

Soleus™ Air

Split Type Room Air Conditioner - Single Zone Wall Mount Heat Pump

INSTALLATION AND OPERATION INSTRUCTIONS



KFR/KFS Series



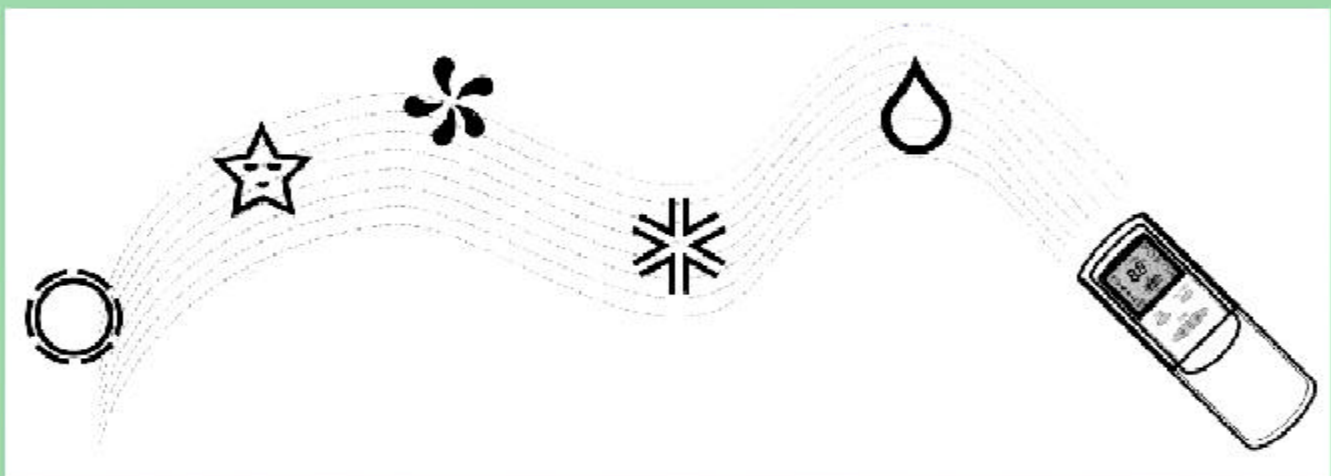





Please read this owner's manual carefully before using your air conditioner.

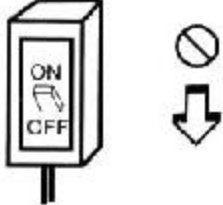

Contents

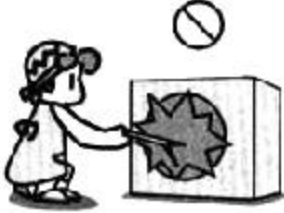
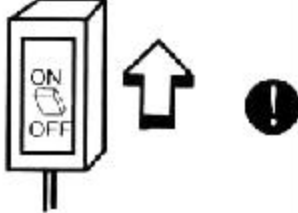
Safety Precautions	1
Identification of parts	2
Indoor Unit / Operation and display	3,4
Remote controller	5,6
Operation instructions / Modes	7
Air flow direction control.....	8
“I FEEL” mode	9
Timer operation mode	10
Sleep operation mode	11
Maintenance	12
Protection	13
Refrigeration cycle	14
Specifications.....	15
Installation instructions	16-24
System start up Procedures Electrical Schematics	25-27
WARNING.....	28
Troubleshooting	29,30
Warranty.....	31

Safety precautions

 <p>Do not turn off the power supply circuit breaker or pull out the unit power cord during unit operation. This may cause electrical hazards and/or a fire.</p>	 <p>Keep the power supply circuit breaker and power plug free from any type of debris. If using a power supply cord, be sure to connect to plug firmly. This will minimize the risk for electrical shock or any other type of electrical hazard.</p>	 <p>Use 230V/60Hz or 115V/60Hz power supply only .</p> <p>Depending on the electrical specifications of your unit, use only 230V/60Hz or 115V/60Hz power supply. Failure to do so may result in electrical problems or hazards.</p>
 <p>Power supply wires must be located in areas where they will not be damaged or cut.</p>	 <p>Never insert any type of object into the outdoor unit fan. Because the fan rotates at a high speed, this may cause injury.</p>	 <p>Be sure that the indoor and outdoor units are not in operation when disconnecting the power supply to the unit.</p>
 <p>Any type of repairs or maintenance done to the units must be done by a professionally licensed contractor. Any unqualified person should not attempt to repair the units themselves.</p>	 <p>Be sure that your hands are not wet when touching any of the operation buttons on the indoor unit.</p>	 <p>Be sure that the outdoor unit is free and clear of any debris around the outside of the unit. Do not place or lean any items on the unit.</p>

Identification of parts

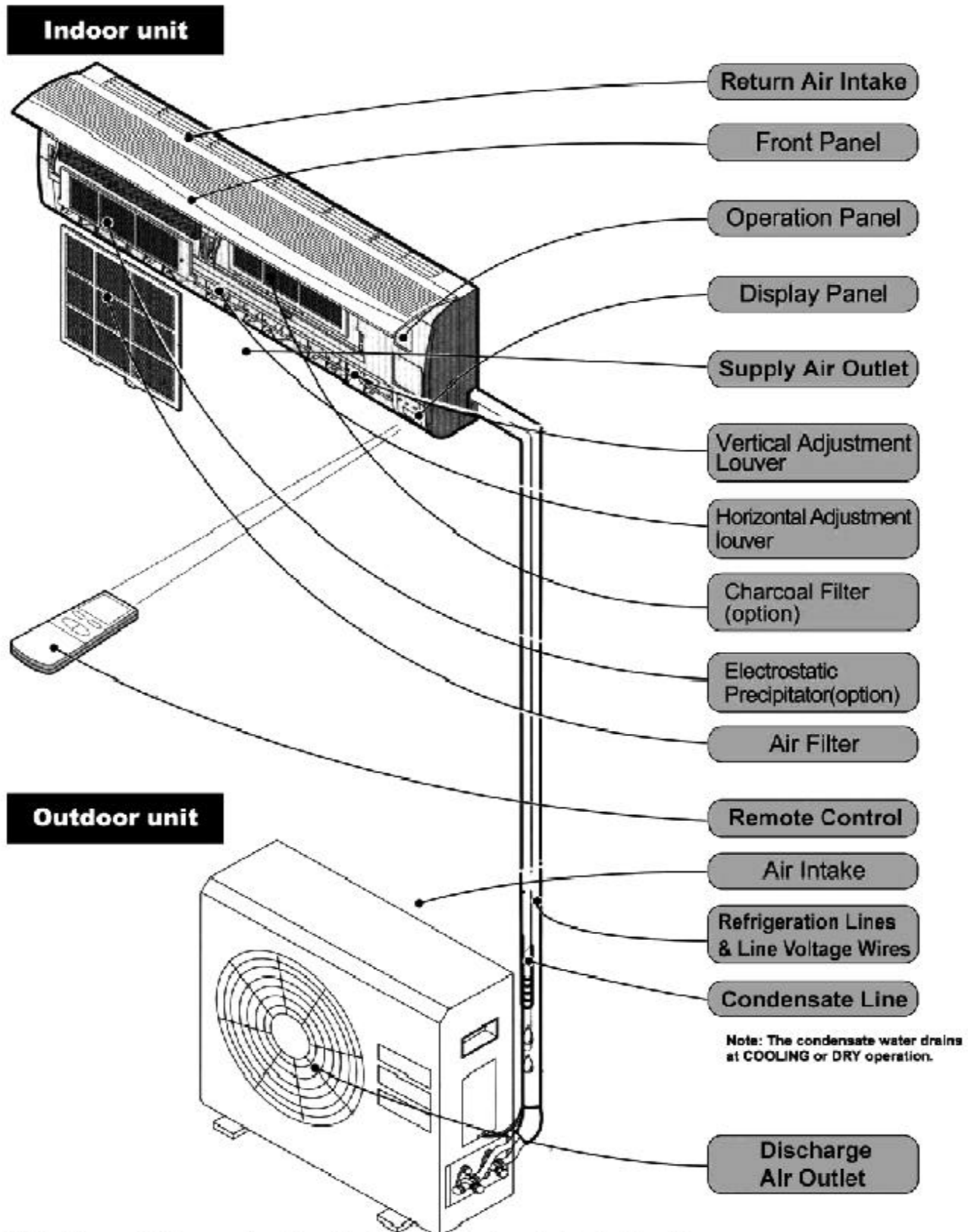

☑ The figures in this manual are based on the external view of a standard model. Consequently, the shape may differ from that of the air conditioner you have selected.

Identification of parts

Operation and Display

KF(R)-09GW KF(R)-12GW
KF(R)-12GW/A KF(S)-12GW

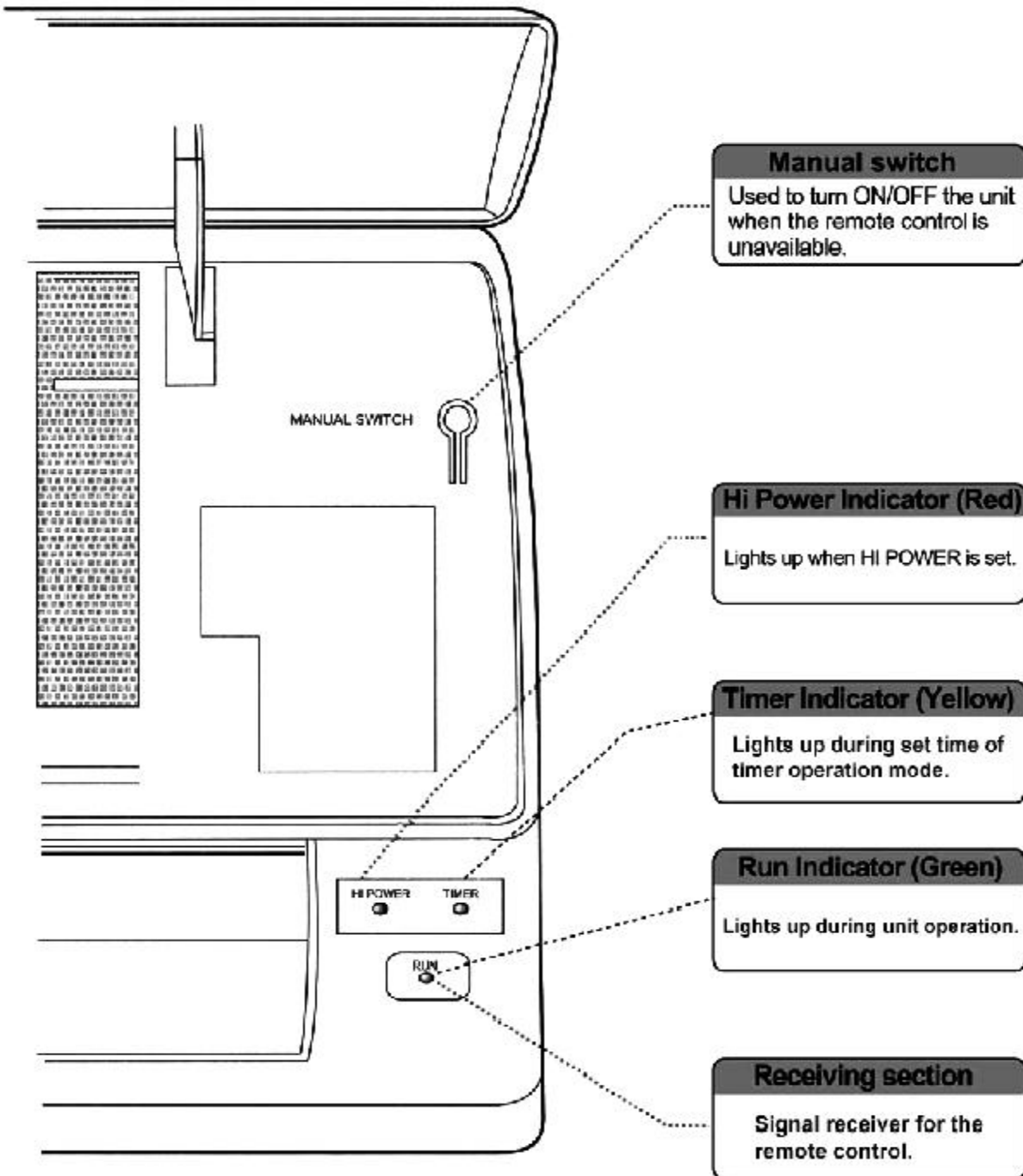

Identification of parts

Operation and Display

KF(R)-18GW

KF(R)-24GW

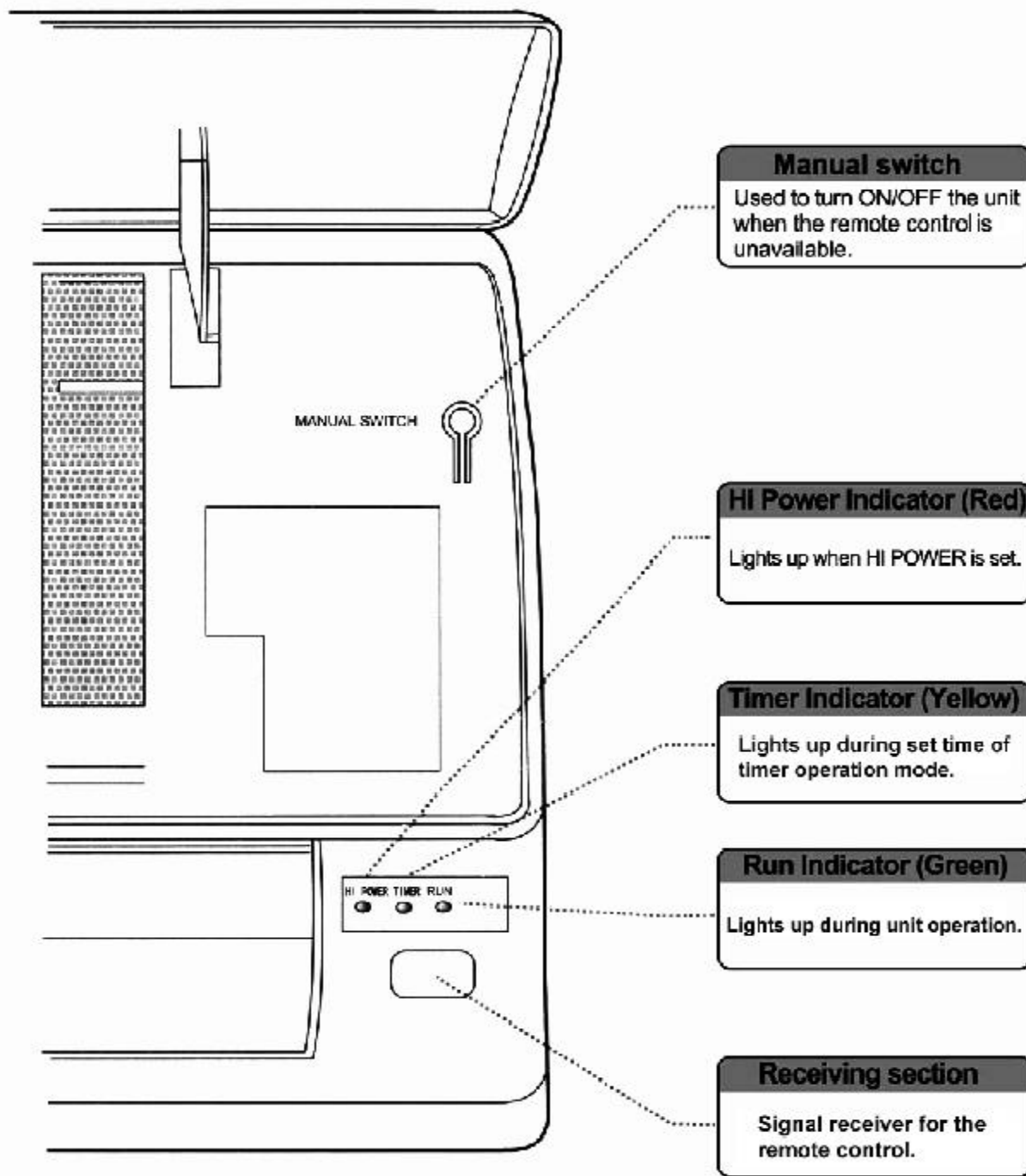

Identification of parts

Remote controller

Remote controller transmitter

Sends signal to the indoor unit.

LCD Panel

I FEEL™ | FEEL™ mode

signal transmit.

auto fan speed

high fan speed

medium fan speed

low fan speed

HI POWER fan speed

FAN button

Press to select the indoor fan speed.

SLEEP button

Press to set sleep mode and press again to cancel.

TIME-Cancel button

Press to cancel timer set during timer operation mode.

SWING button

Press to activate/deactivate vertical airflow oscillation.

HI POWER BUTTON

Press this button during cooling or heating mode to make indoor fan motor run in highest speed.

LCD Panel

- ☆ Sleep Indicator
- ☉ Heating Indicator
- ❄ Cooling indicator
- 💧 Dry indicator
- ✂ Fan only indicator

ON/OFF button

Press to turn appliance ON/OFF.

TEMPERATURE button

Used to adjust set temperature

▼ Press once to lower the set temperature by 1°F

▲ Press once to raise the set temperature by 1°F

MODE button

To change operation modes

TIMER button

Used to set times in timer operation mode.

TIMER-SET button

Used to send information programmed in timer operation mode

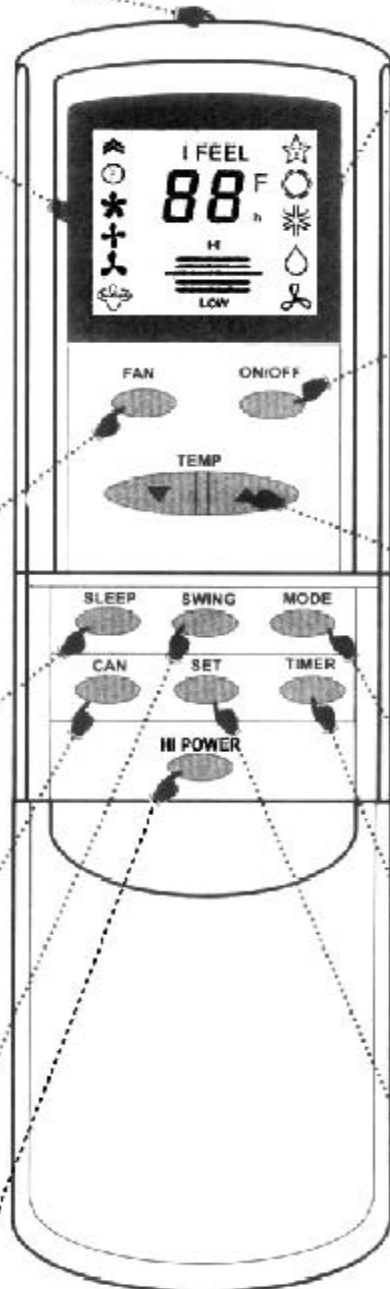

★ HEATING mode(☉) is only available for heat-pump model.

★ The remote control continues to display even when the unit has stopped operation.

★ There is no "HI POWER" mode for some models.

Identification of parts

Remote control

How to insert batteries





- A** Pull to open the cover
- B** Insert batteries properly in the compartment according to polarity
- C** Push up to close the cover.

Note:

- A** The service life of an alkaline battery is about 1 year. When the indoor unit does not respond to a signal, or the display becomes dim, replace the batteries at once.
- B** Replace with fresh batteries only. Do not use used batteries.
- C** To prevent leakage take out the batteries when unit will not be used for an extended period of time.

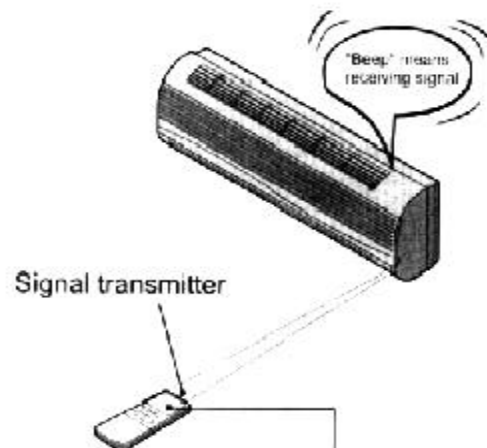
How to use remote control



- A** Signal-sent symbol  will flash for a short time when signal is sent.
- B** The range that the signal can reach is about 23 feet when pointing at the front of the indoor unit.
- C** Be sure that remote control receiver on the indoor unit is not obstructed in any way. This will ensure that a proper signal can be received from the remote control.
- D** The remote control should not be exposed to any direct sunlight. This can lead to altering of set programming and/or permanent damage to the remote control.

- After replacing the batteries, if the remote control does not display, take them out for a period of 20 seconds and replace.
- Be sure to stop unit operation before replacing batteries.

Operation instructions

Operation modes

Selecting mode

Each time the MODE button is pressed, the operation mode is changed in the following sequence:

"HEATING" → "COOLING" → "DRY" → "FAN ONLY" → "I FEEL" **1**

- * "I FEEL" mode is described on page 10.
- * When operating at fan only mode, the compressor will not operate.

"FAN" mode

Each time the "FAN" button is pressed, the fan speed is changed in sequence:

AUTO → HI → MED → LO **2**

- * On "FAN ONLY" mode, only "HI", "MED" and "LO" are available.
- * While on "DRY" mode, airflow is set by air conditioner automatically, "FAN" button is ineffective in this case.

Setting temperature

Press once to lower temperature by 1°F **3**

Press once to raise temperature by 1°F



Range of available set temperatures

Heating, Cooling	64 F~90 F
DRY	room temperature ± 4 F

Turning on

Press "ON/OFF" button, When the appliance receives a signal, a "beep" will be heard. The RUN indicator will then light up. **4**

AUX operation

Open the front panel to press the manual switch to run on/off the unit when your remote control is damaged or batteries have died.



Open the front panel of the indoor unit and press the switch.

The appliance operates at "I FEEL" mode. The RUN indicator lights up.



Press it once again.

The RUN indicator light turns off and unit shuts down.



The name and position of the manual switch may vary from different models, but their function are the same.

- * When the compressor shuts off or if changing modes during operation of the unit, the unit may not respond at once. It may be necessary to wait up to 3 minutes due to built-in compressor protector.
- * There is a 2-5 minute delay on the indoor fan in the heating mode operation. Time of delay depends on how long it takes for the indoor coil to come up to a desirable temperature.

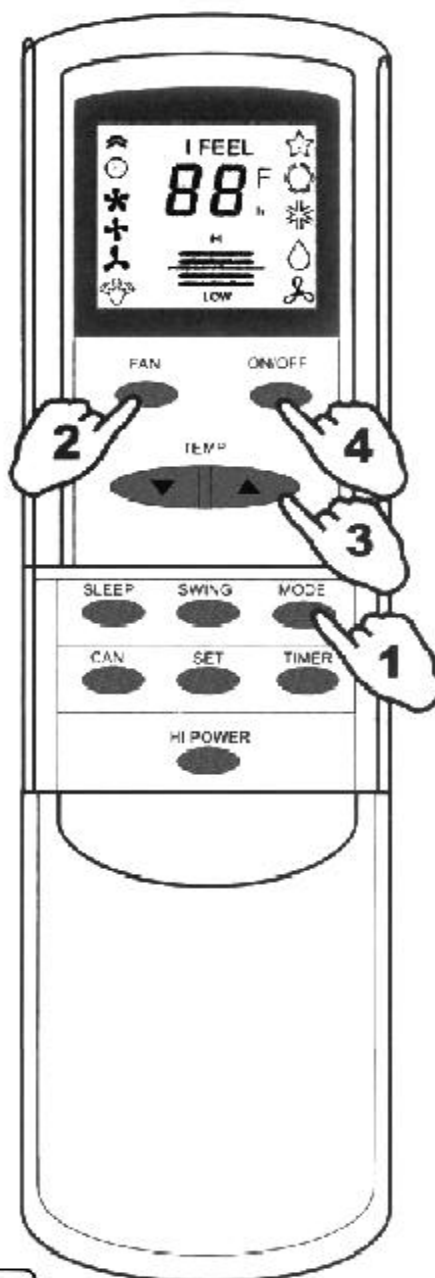

Operation instructions

Airflow direction control

Vertical airflow is automatically adjusted to a certain angle in accordance with the operation mode after turning on the unit.

Operation mode	Direction of airflow
COOLING, DRY	horizontal
*HEATING, FAN ONLY	downward

The direction of airflow can also be manually adjusted by pressing the "SWING" button of the remote control

SWING



5

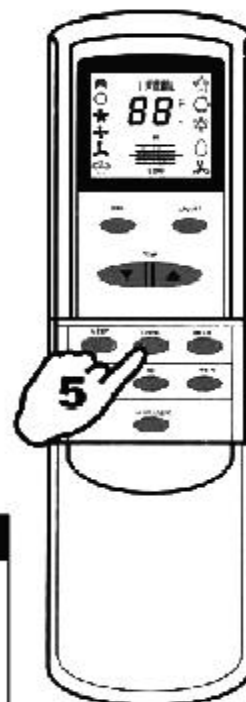

Vertical airflow control (use the remote control)

Use the following steps to set desired directions of airflow.

Swinging airflow option

Press the "SWING" button once, the vertical adjustment louvers will swing/sweep up and down automatically.

Fixed airflow option

Press the "SWING" button once more as soon as the louvers are at the desired airflow directions and the louver will stop.

Horizontal airflow control (set manually)

Manually turn the control rods of the horizontal adjustment louvers to change horizontal flow as shown.

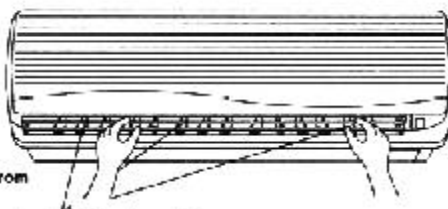

Note: The shape of the unit may look different from that of the air conditioner you have selected.

control rods of horizontal adjustment louvers

- * Do not turn the vertical adjustments louvers manual or a malfunction may occur. If a malfunction does not occur the unit first and turn off the power supply. Then restore power supply again and set unit operation.
- * Vertical adjustment louver should not tilt downward for a long time at cooling or dry mode to prevent condensed water from dripping from the indoor coil.
- * When the vertical adjustment louvers are set using the "SWING" button, the angle of airflow will be remembered by the unit as long as it is in the same operation mode. Once the mode is changed, the louver will return to the preprogrammed auto angle.

Operation instructions

"I FEEL" mode









Press the "ON/OFF" button then choose the "I FEEL" mode by pressing "MODE" button. The automatically controlled at the optimum temperature and airflow volume which unit will be determined by the indoor temperature.

Operation mode / Temperature setting Chart

Indoor temperature	Operation mode	Set temperature
below 70°F	*HEATING	73°F
70°F-77°F	DRY	Room temperature at initial operation
77°F-82°F	COOLING	77°F
over 82°F		79°F

*Not available for cooling only models.

Temperature airflow volume and direction are controlled automatically.
Remote controller is still functional if you wish to change setting.

Your feeling	button	adjustment procedure		
Slightly warmer A decrease by 4°F can be set		 Press twice to lower the set temp by 2°F <table border="1" style="float: right; margin-left: 20px;"> <tr><td style="text-align: center;">HI</td></tr> <tr><td style="text-align: center;">LOW</td></tr> </table>	HI	LOW
		HI		
LOW				
 Press four times to lower the set temp by 4°F <table border="1" style="float: right; margin-left: 20px;"> <tr><td style="text-align: center;">HI</td></tr> <tr><td style="text-align: center;">LOW</td></tr> </table>	HI	LOW		
HI				
LOW				
Slightly cooler A rise by 4°F can be set		 Press twice to raise the set temp by 2°F <table border="1" style="float: right; margin-left: 20px;"> <tr><td style="text-align: center;">HI</td></tr> <tr><td style="text-align: center;">LOW</td></tr> </table>	HI	LOW
		HI		
LOW				
 Press four times to raise the set temp by 4°F <table border="1" style="float: right; margin-left: 20px;"> <tr><td style="text-align: center;">HI</td></tr> <tr><td style="text-align: center;">LOW</td></tr> </table>	HI	LOW		
HI				
LOW				
Uncomfortable because of unsuitable air flow volume.	FAN 	Indoor fan speed alternates between Hi, Med and Low each time this button is pressed.		
Uncomfortable because of unsuitable flow direction.	SWING 	Press it once, the vertical adjustment louver swings to change vertical airflow direction. Press it again, swings stops. For horizontal airflow direction, please refer to the previous page for details.		

Operation instructions

Timer operation mode

This is a function in which you can set the timer on with the "TIMER" button when you go out in the morning to achieve a comfortable room temperature for when you get home. You can also set the timer off at night to enjoy a more comfortable sleep.

Timer-setting

Set the switch-on timer when the appliance is off.



Set the switch-off timer during operation.

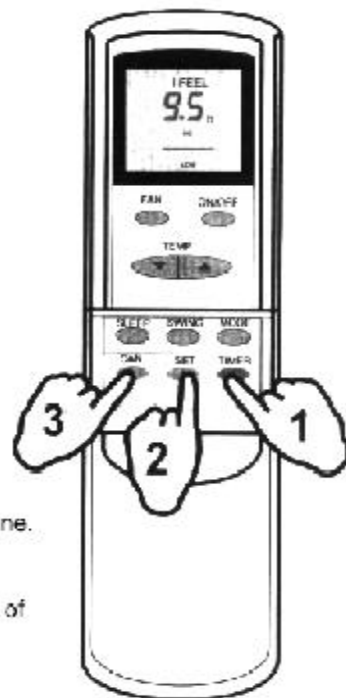

- A** As time passes, LCD displays the remained time.
- B** The previous set time is stored and the next set time begins with the previously set one.
- C** On-timer and off-timer cannot be set at the same time.
- D** The room may not reach your desired temperature within the preset time because of different sizes of rooms and/or climatic conditions.

Example: set an operation after 9.5 hours

Set the operating mode, temperature and indoor fan speed first, then press the "TIMER" button until "9.5h" appears.

- Press the TIMER button; "h" flashes on the LCD, then you can set the time. Each time the button is pressed, the set time increases by half an hour within 10 hours and increases by one hour beyond 10 hours. The range that can be set is 0.5 hour to 24 hours.



1

Point the remote controller at the signal receiver of the indoor unit, press the "SET" button when the letter "h" flashes.

A "beep" will be heard:

- A** Timer indicator on the indoor unit lights up.
- B** Letter "h" stops flashing.



2

To cancel the set timer: press the "CAN" button, a "beep" will be heard and the timer indicator light on the indoor unit will turn off.

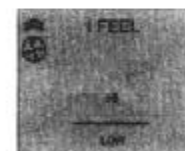

3

Operation instructions

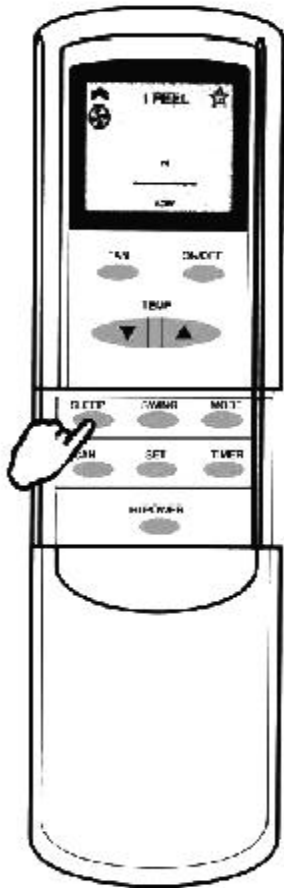

SLEEP operation mode

- SLEEP mode can be set in I FEEL, DRY, COOLING or HEATING operation modes.
- This function allows a more comfortable environment for times of sleeping.
- The fan speed is automatically set at ultra-low speed, which is lower than low speed.
- The fan does NOT shut off during sleep mode.
- Before going to sleep, press the 'SLEEP' button. The sleep mode will then be activated.
- When operating under the Cooling or Dry modes, set the temperature increases by 2°F degree over a 2 hour period. It will then remain at that temperature until the unit is manually turned off or operation mode is changed. See chart below for more detail.
- When operating under the Heating mode, the set temperature decreases a total of 5.5°F degrees over a 3 hour period. It will then remain at that temperature until the unit is manually turned off or operation mode is changed. See chart below for more detail.
- It is recommended to use SLEEP mode together with OFF TIMER to achieve a more economical and energy-saving operation.

COOLING or DRY

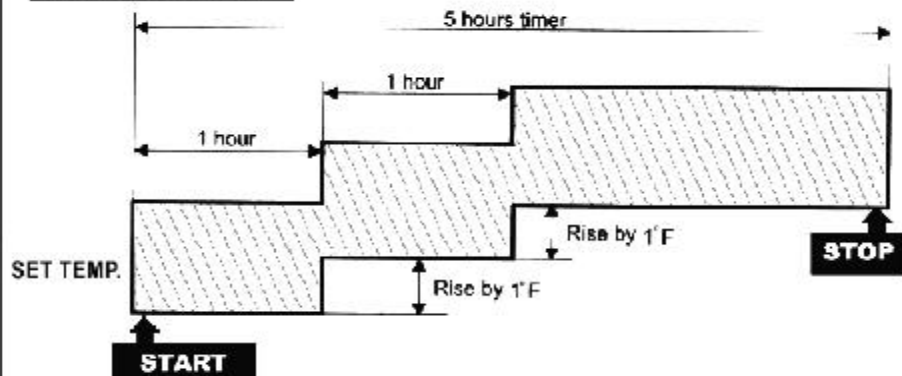

*HEATING (*HEATING mode is not available for cooling only models)

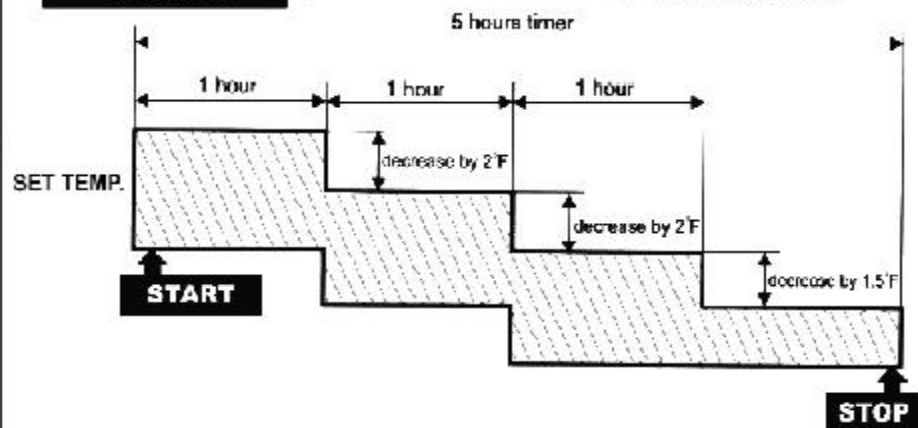

Maintenance

Front panel maintenance

1 Cut off the power supply

Turn off the appliance before cutting off the power supply.



2

Grasp position "a" and pull outward to remove the front panel.

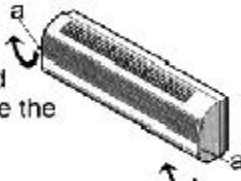

3 Wipe Panel with a soft, dry cloth.

Use lukewarm water to clean if the unit is very dirty.



Use a dry and soft cloth to clean it.

4 Never use substances such as gasoline or polishing liquids to clean the unit.



5 Never use water directly onto the indoor unit.



Dangerous!
Electric shock!

6 Reinstall and shut the front panel.

Reinstall and shut the front panel by pressing position "b" downward.



Air filter maintenance

The filter must be cleaned as follows when the air conditioner has run for approximately 100 hours.

1 Stop the appliance and remove the air filter.

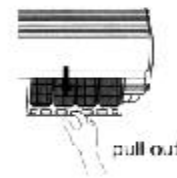

1. Open the front panel.
2. Press the handle of the filter gently from the front.
3. Slide out the filter.

2 Clean and reinstall the air filter.

If the filter is extremely dirty wash the filter with a solution of detergent in lukewarm water. After cleaning allow filter to dry thoroughly out of direct sunlight.



3 For an air conditioner equipped with an electrostatic and a charcoal precipitator (optional parts):

- Do not clean the electrostatic filter with water. It should be cleaned using a soft, dry cloth.
- The charcoal filter can be washed using lukewarm water and a neutral detergent.
- It is recommended that the electrostatic and charcoal filter be replaced after 8 months of operation.

Protection

Operating condition

The following cases may cause the internal safety device to trip:

HEATING	Outdoor air temperature is over 75°F
	Outdoor air temperature is below 32°F
COOLING	Room temperature is over 81°F
	Outdoor air temperature is over 109°F
DRY	Room temperature is below 70°F
	Room temperature is below 64°F

If the air conditioner runs in "COOLING" or "DRY" mode with door or window opened for a long time when relative humidity is above 80%, dew may drip down from the air outlet.

Noise pollution

- Install the indoor unit on a wall that will be able to hold its own weight, this will ensure that it operates more quietly. (See page 18 for further instructions about indoor unit installation.)
- Install the outdoor unit in a location where air discharge and operation noise will not be bothersome to surrounding residents. (See page 18 for further instructions about indoor unit installation.)
- Do not place any obstacles in front of the air discharge of the outdoor unit. This will cause damage to the compressor and motor and will cause these components to be noisier. (See page 18 for further instructions on unit clearances.)

Features of protector

- 1 A fault protector device will operate during the following cases:
 - Stopping the unit and restarting it at once or changing modes during operation you will need to wait 3 minutes for time delay.
 - Putting the plug into the wall outlet and turning on the appliance at once you will need to wait about 20 seconds.
- 2
 - If all operations have stopped due to the fault protector, press "on/off" button to reset the unit.
 - Set timer again if it has been cancelled.

Inspection

After using the unit for an extended period of time, the unit should be inspected for the following items:

- Overheating of the power supply cord or plug.
 - Abnormal operating sound or unit vibrations.
 - Water leaking from the unit excessively.
 - Indoor unit cabinet becoming electrified.
- If any of these symptoms occurs, call a qualified service technician immediately.
- It is recommended that a detailed inspection be made by a qualified technician after 3 years of operation, if even if the above symptoms do not occur.

Features of HEATING mode

Preheat

At the beginning of HEATING operation there is a 2-5 minute delay on the indoor fan. This is to allow the indoor coil to raise in temperature for proper operation.

Defrost mode

In HEATING operation the appliance will defrost the outdoor coil automatically to raise efficiency. This procedure lasts 2-10 minutes. During defrosting mode the indoor fan stops operation. After defrosting complete, it returns to the heating mode automatically.

- It may be difficult to raise the indoor temperature when outdoor temperature is very low (35°F) this is due to nature of heat pumps and their loss in efficiency as outdoor temperatures decrease.

Refrigeration cycle

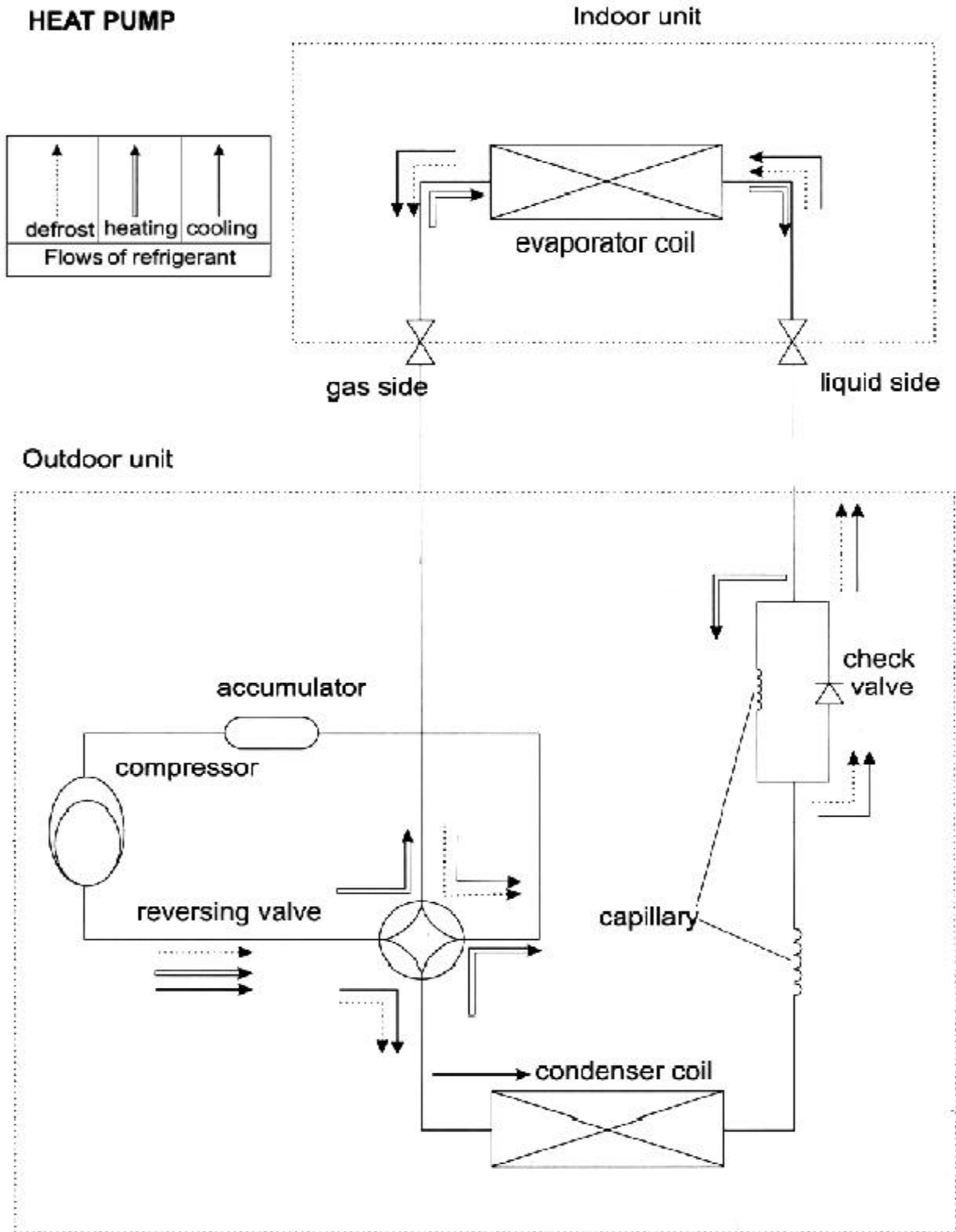

Specifications

PERFORMANCE RATINGS				
MODEL	KFS-12G	KFR-12G	KFR-18G	KFR-24G
Capacity Cooling [BTU/h]	12000	12400	18500	23100
Capacity Heating [BTU/h]	12000	12800	18800	23266
SEER	10.5	10.5	10.2	10.4
Moisture Removal [Pts/h]	2.9	2.9	3.1	5.2
Air Flow	340/450/520	340/450/520	690/810/900	890/1100/1200
Sound Rating Indoor dB	<42	<42	<44	<45
Sound Rating Outdoor dB	<52	<52	<58	<59
Operating Range - Cooling [F]	60 to 109	60 to 109	60 to 109	60 to 109
Operating Range - Heating [F]	28 to 75	28 to 75	28 to 75	28 to 75
ELECTRICAL DATA				
Power Source	115-60-1	230/208-60-1	230/208-60-1	230/208-60-1
Min. Ampacity [A]	15	10	15	15
Cooling Watts Amps	1440 / 11.7	1230 / 5.3	1870 / 8.1	2323 / 10.1
Heating Watts Amps	1420 / 10.8	1300 / 5.7	1890 / 8.2	2379 / 10.3
Max TD Fuse/Breaker [A]	28	15	22	27
REFRIGERANT LINES				
Connections	Flare	Flare	Flare	Flare
Liquid Line OD [in]	1/4	1/4	1/4	3/8
Suction Line OD [in]	1/2	1/2	1/2	5/8
Mac line Length [ft]	49	49	49	49
Max Height Difference [ft]	16	16	16	16
DIMENSIONS & WEIGHTS				
INDOOR SECTION	KFS-12GW	KFS-12GW	KFS-12GW	KFS-12GW
WxHxD [in]	24x8x5	24x8x5	42x14x11	46x15x11
Shipping Weight [lbs]	22	22	29	31
OUTDOOR SECTION	KFS-12GWH	KFS-12GWH	KFS-12GWH	KFS-12GWH
WxHxD [in]	31x22x10	31x22x10	38x28x15	38x39x15
Shipping Weight [lbs]	73	73	115	143
Refrigerant Charge [lbs]	2	2.1	2.9	4.8

Specifications are subject to change without prior notice. Visit our website - www.soleusair.com
 Copyright 2003 Soleus International Inc.

Installation instructions

Installation diagram of air conditioner

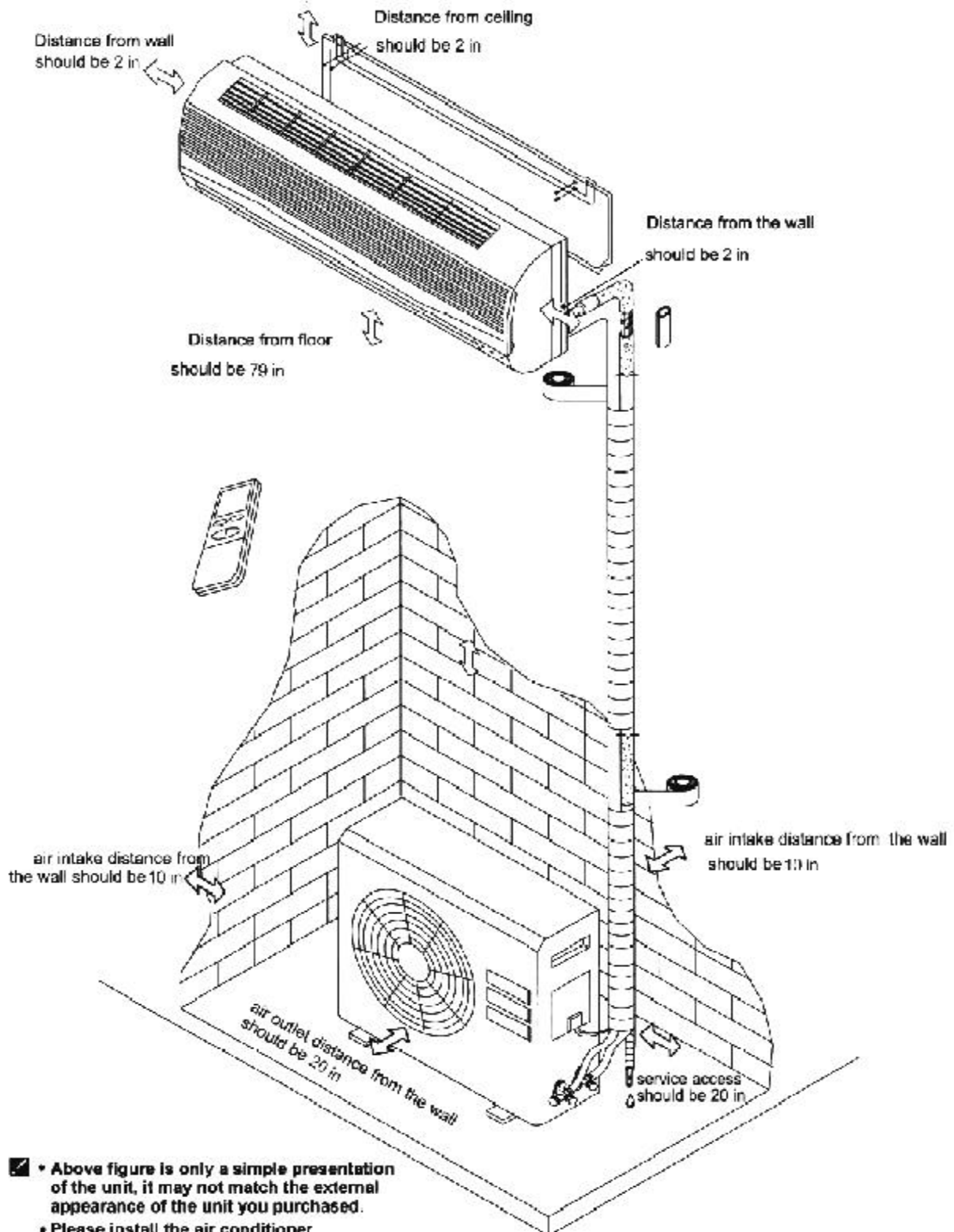

- Above figure is only a simple presentation of the unit, it may not match the external appearance of the unit you purchased.
- Please install the air conditioner according to laws and local codes.

Installation instructions

Select the installation locations

Indoor unit installation location:

- Locate indoor unit so that there is not obstruction near the supply air or return air outlets.
- The wall that the indoor unit hangs on must be free from internal obstructions to facilitate a clear hole for the refrigeration lines and condensate line to go through.
- Proper clearances must be maintained to ceilings and walls per instructions on page 16.
- Easy access must be maintained for removal of the air filter.
- Indoor unit and remote control must be at least 3 feet from televisions, radios, etc.
- Indoor unit and remote control must be kept out of direct sunlight and/or fluorescent lighting.
- The wall that the indoor unit hangs on must strong enough to bear the weight of the unit to ensure quieter operation.

Outdoor unit installation location:

- Outdoor unit location must be well ventilated. Avoid installing where any type of flammable gas could leak.
- Proper clearances must be maintained per instructions on page 16.
- The maximum length for refrigeration lines is 49 ft. For refrigeration lines exceeding 23ft. an additional .75 pounds must be added per 3.5 feet.
- The Maximum height between indoor and outdoor units is 25ft. If the outdoor unit is located above the indoor unit more than 4 ft., a suction line oil trap must be installed.
- The outdoor unit must not be located in environments that have high contents of acidic substances, vulcanized gasses, or high salt contents in the air.
- The outdoor unit must not be located near locations where dirt, mud, or debris can be caked onto the outdoor coil or unit.
- The foundation that the outdoor unit sits on must be solid and sound so as to decrease noise vibration.
- No obstructions should be placed around the outdoor unit.

Installation Diagram

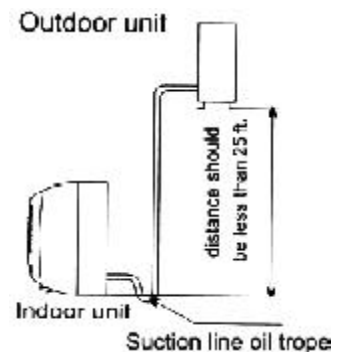
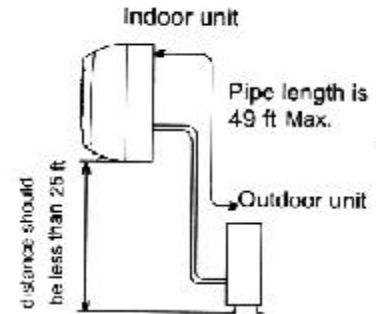

Indoor unit installation

1. Installing the mounting plate

- Hold mounting plate on the wall where unit will be located. Using a level or plumb line, ensure that the plate is level. Once the plate is level, mark holes that will be used to hold plate on the wall.
- Remove plate and drill marked hole at a depth of 1.75 inches.
- Insert the screw plugs into the holes and affix the mounting plate using the tapping screws.
- Once mounting plate is securely fastened to the wall, then locate an area on the wall for the access hole for the refrigeration line/condensate line/wiring bundle.

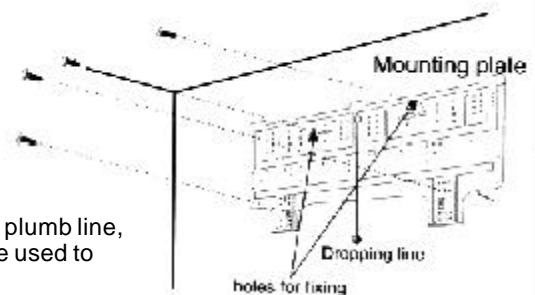

Note: The shape of your mounting plate may be different from the one above, but installation method is similar.

2. Access hole for refrigeration lines/condensate drain line/wiring bundle.

- These directions must be followed at least for the condensate drain line. There must be rear access for the condensate drain line to drain properly from the unit.
- Decide on a location for the access hole according to the location of the unit.
- Drill an approximately 2.5 inch hole, making sure that there is a tilt downward of a 1/4 inch. This will ensure that proper drainage is maintained for the condensate drain line. (If you are not using rear access for the refrigeration lines and wiring, hole will not need to be as large.)
- It is recommended that a wall sleeve of some sort (i.e. PVC pipe) be used to keep the hole neat and tidy.

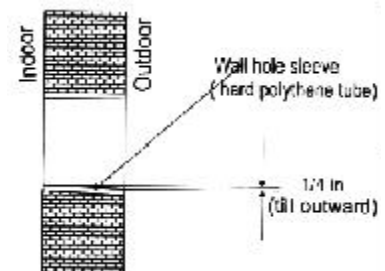

Installation instructions

3. Indoor unit refrigeration line installation

- The refrigeration lines and wiring can be routed to the outdoor unit in a number of ways (left or right from the back of the unit), by using the cut-out access pieces on the casing of the unit.
- Bend the refrigeration lines carefully to the required position in order to be aligned with the drilled hole.

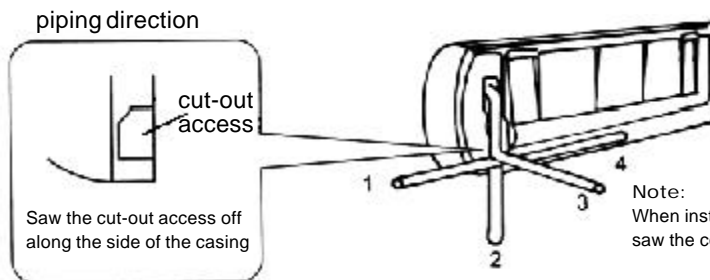

Note:
When installing the refrigeration lines at the directions 1, 2 or 4, saw the corresponding cut-out piece off the indoor unit casing.

- After connecting refrigeration lines (see directions below), install the condensate drain line (see page 21+24 for detailed instructions on connecting condensate drain line). Then connect all wiring (see pages 25-27 for detailed instructions on wiring). After all connections are made, bundle the refrigeration lines, wiring, and condensate drain line together using a thermal insulation and vinyl/duct tape.

Refrigeration lines insulation:

- It is important that both the liquid and suction refrigeration lines are individually insulated to ensure that they do not sweat and also to maintain proper unit capacities. This is necessary since the refrigeration is metered from the outdoor unit and will produce condensation on both refrigeration lines if not properly insulated.

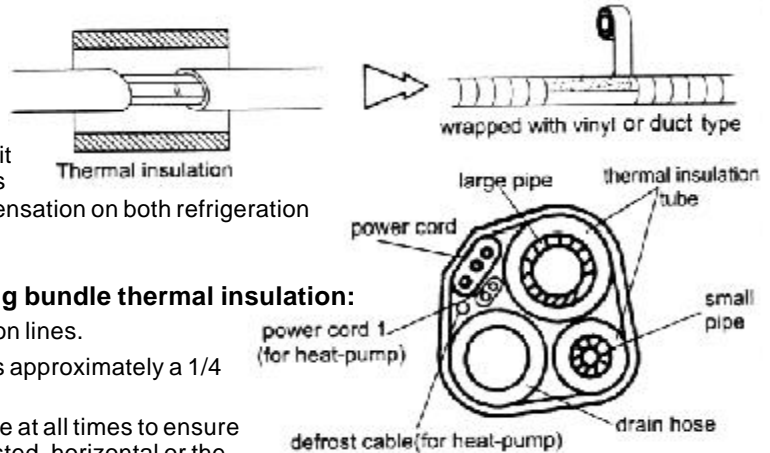

Refrigeration lines/Condensate drain line/wiring bundle thermal insulation:

- Place the condensate drain line under the refrigeration lines.
- Insulation material should be a polythene foam that is approximately a 1/4 inch wall thickness.
- Condensate drain line should have a downward slope at all times to ensure proper drainage. Do not allow the drain line to be twisted, horizontal or the end of the line be immersed in water. If an extension is added to the drain line, make sure that it is also properly insulated.

Connection of refrigeration lines:

- Do not use contaminated or damaged copper tubing for refrigeration lines. If any of the tubing, evaporator or condenser coils have been exposed to the air for more than 15 seconds, it is important that they are vacuumed and purged with field-supplied refrigerant. Do not remove plastic or rubber plugs and brass nuts from the valves, fittings, tubing, or coils until they are ready to be connected.
- Use proper tubing cutters to cut the refrigeration lines, advancing the blade of the tubing cutters slowly. Extra force or improper cutting will cause tubing distortion and also extra burring.
- Once refrigeration tubes are cut, remove burrs from cut edges with a remover. This will avoid unevenness on the flare faces, which could cause a gas leak. Hold the ends of the pipes downward to prevent metal from going into the tubes.
- Insert the flare nuts, mounted on the connection ends of both the indoor and outdoor units onto the ends of the copper tubing.
- The length of the pipe protruding from the face of the flare die is determined by the particular flaring tool that will be used.
- Fix the pipe firmly on the flare die. Match the centers of both the flare die and the flaring punch, and then tighten the flaring punch fully.
- Once flaring is complete, connection of the tubing is ready. Align the center of the tubing and tighten the flare nuts using a torque wrench.

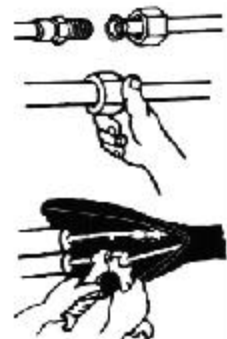

Installation instructions

Properly connect the electrical wiring between the indoor and outdoor unit as shown below.

WARNING

THIS APPLIANCE MUST BE GROUNDED.

IMPORTANT:

The figures shown below are for information purposes only. Make sure that local and/or national codes and regulations are complied with when making connections.

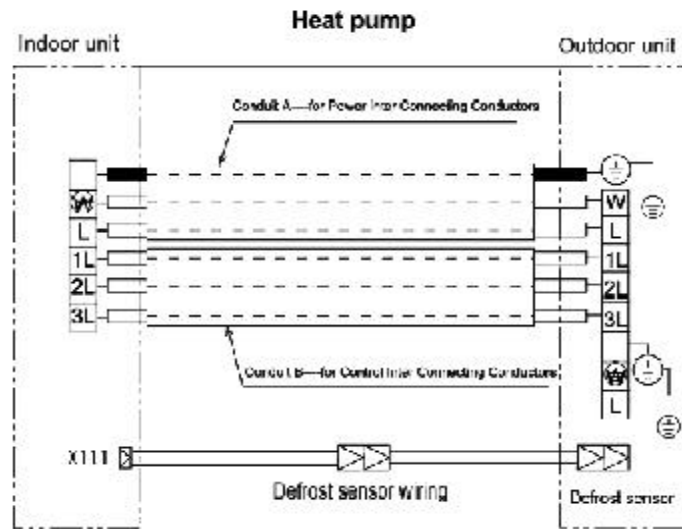

4. Interconnecting wires

- (1) Remove the indoor terminal cover:
Open the front panel and remove the indoor terminal board cover.

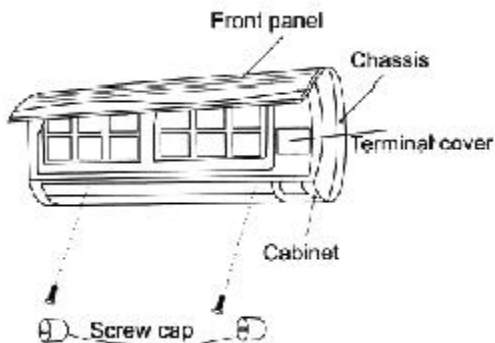

- (2) Supply wiring, control wiring and defrost cable connection.

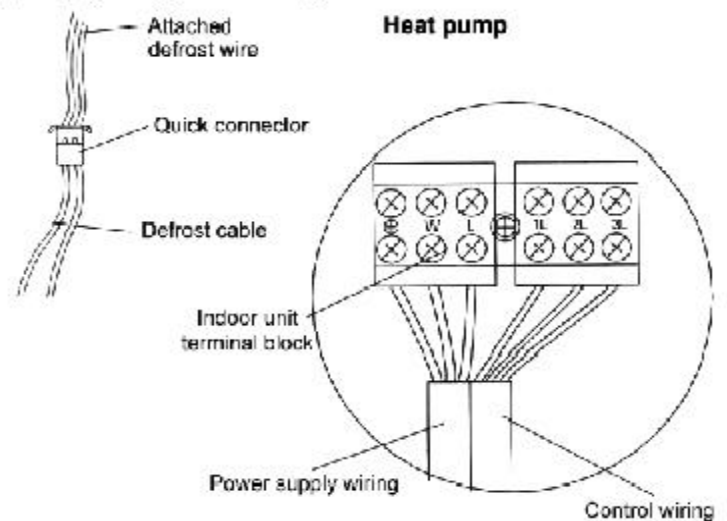

5. Conduit fittings

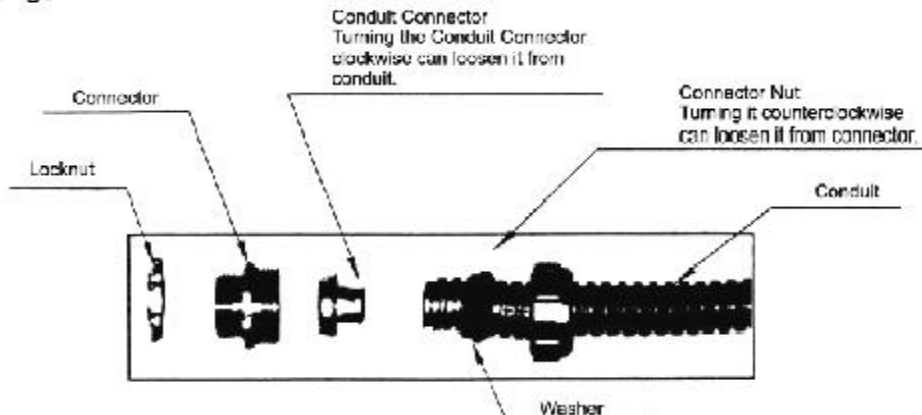

Installation instructions

6. Installation of conduit bracket

(The shape of conduit bracket is shown as below.)



- Put the conductors through the Conduit and Connector. Tighten the Conduit Connector to the conduit.
- Put the conductors through the Connector and the Conduit Bracket. Tighten the Connector Nut to the Connector.
- Turn the locknut counterclockwise to tighten the locknut.

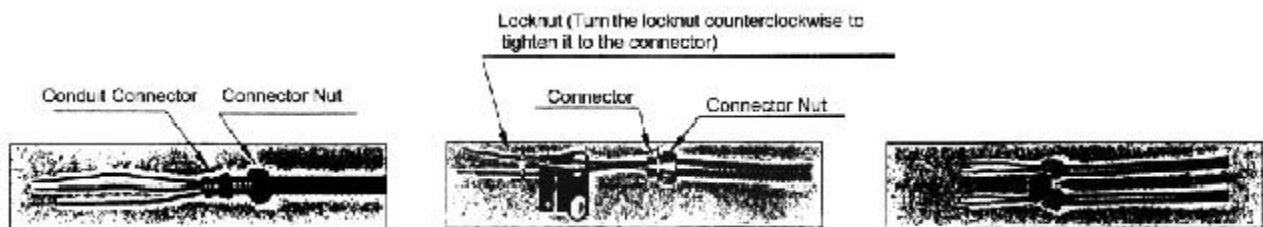

Mounting the Indoor unit to the Mounting Plate:

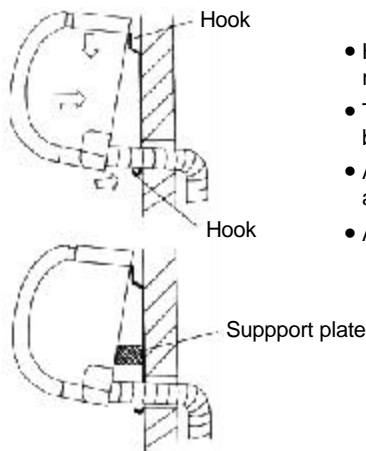

- Hook the indoor unit onto the upper portion of the mounting plate by connecting the hooks at the rear top of the indoor unit with the upper edge of the mounting plate.
- To ensure that the hooks are properly seated on the mounting plate, check if the unit can slide by moving it to the left and right. If the unit moves, it is not properly seated.
- A unit support plate in the mounting plate can be used if the unit is on a slanted wall and can also be used to ease the connection of the refrigeration lines.
- Affix the screw underneath the unit to the mounting plate after completed with installation.

Connection of condensate drain extension line:

- Place glue on the end of the drain line extension end.
- Fully insert the end of the drain line to the extension line. Make sure it is properly inserted to no less than 3/8 of an inch so that water does not leak from the hose.

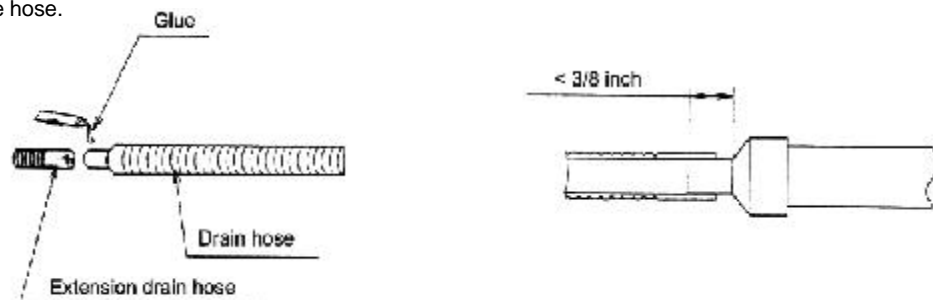

Installation instructions

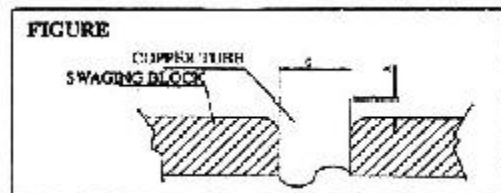
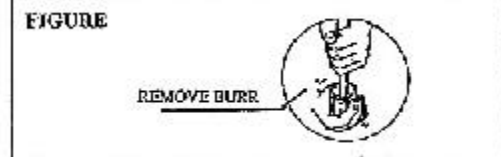
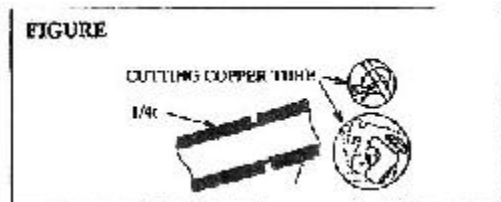

Ø TUBE		A (mm)	
Inch	mm	Imperial	Rigid
1/4"	6.35	1.3	0.7
3/8"	9.52	1.5	1.0
1/2"	12.70	1.9	1.3
5/8"	15.88	2.2	1.7
3/4"	19.05	2.5	2.0

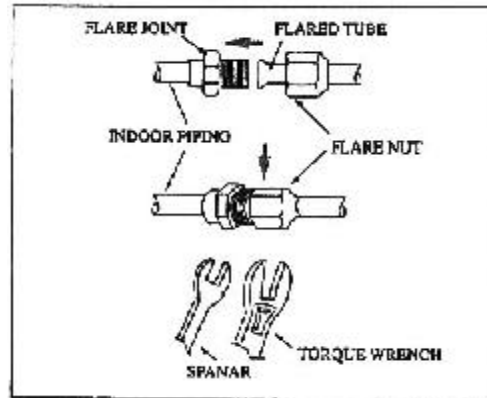

PIPE SIZE (mm/in)	TORQUE (Nm)
6.35 (1/4)	18
9.53 (3/8)	42
12.7 (1/2)	55
15.88 (5/8)	65
19.05 (3/4)	78

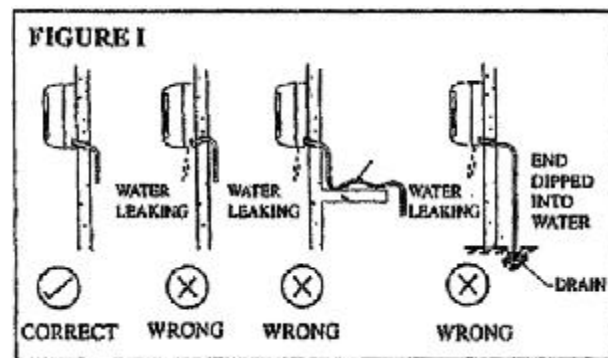

Outdoor unit installation

1. Install the outdoor unit

- Outdoor unit must be mounted on a solid, level foundation. If possible, affix unit using bolts to the foundation.
- If installing on a wall or structure, be sure that construction of the wall or structure can support the weight of the unit and that consideration is given to the integrity of the construction. Since the unit can vibrate during operation, movement of sound of the unit should be considered when installing the unit.
- Since the unit discharges air during operation, plants or other obstruction should be free and clear of the unit to ensure proper operation.
- Owners should be advised to avoid lawn mowers or other machinery discharge toward the unit, as debris can damage the finned coil surfaces and reduce efficiency of the unit.

2. Outdoor unit refrigeration line connection

- Remove the valve caps at the outdoor unit where refrigeration tubing will be connected.
- Connect the refrigeration tubing using flaring techniques described earlier in the indoor unit installation. Be sure to use required torque.

Attention

- A baffle is needed when installation is in locations near the sea or areas with strong winds.
- Be sure that unit airflow is not obstructed in any way or that recirculation of discharge air does not occur.

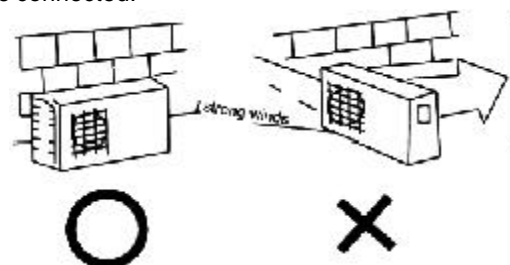

Installation instructions

3. Wiring connection

- Remove the electrical cover of outdoor unit (1 screw).
- Connect wires as shown below in the illustrations.

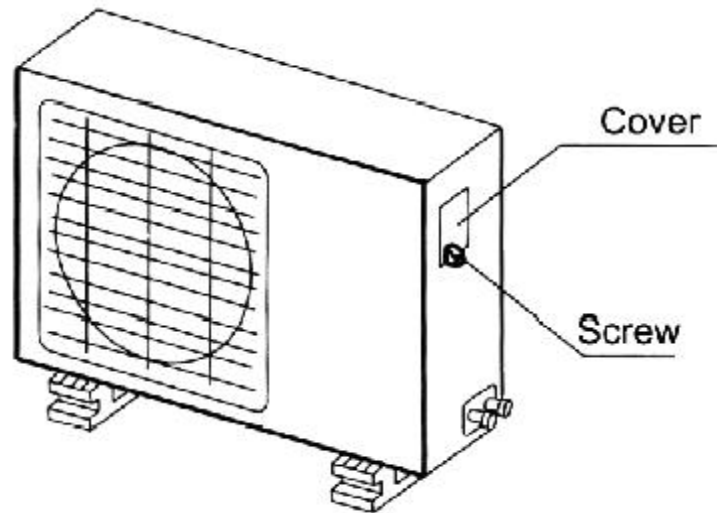

Heat Pump

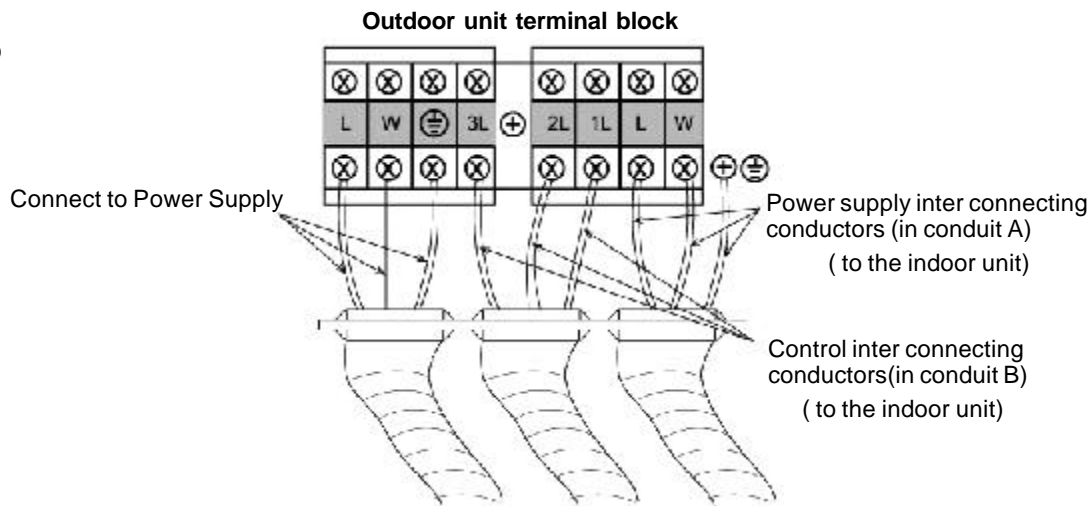

The conduit should not be loosened after being fixed, otherwise, it may cause abnormal noise when the unit is running.

- Number 14 wire should be used for KFR-18GW.
- Number 12 wire should be used for KFR-24GW.
- Number 14 wire should be used for KFR-09GW, KFR-12GW/A.
- Number 16 wire should be used for KFR-12GW.

Installation instructions

System Start Up and Charge Adjustment Procedures

Leakage check

Properly check refrigeration tubes and connections for any leaks prior to system start up procedures.

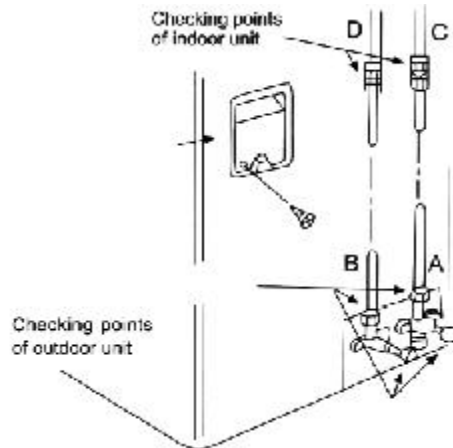

NOTE:

A is the low-pressure valve
B is the high-pressure valve
C and D are the joints of connecting pipes of indoor unit.

Air exhaust

The outdoor unit is supplied with a R-22 charge sufficient for 15 feet of refrigeration tubing. The outdoor unit's liquid and suction valves are closed to contain the charge within the unit. The recommended procedures for charge adjustments are as follows:

Additional Charge Needed for Refrigeration lines over 15 feet

Liquid Line O.D. (Inches)	Additional R-22 (oz / ft)
1/4	.22
3/8	.58

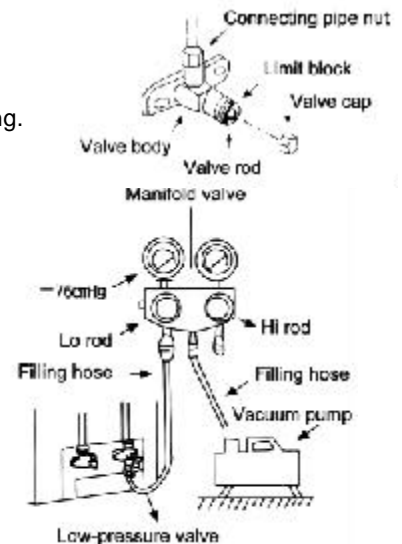

1. After connecting the refrigeration tubing to the indoor and outdoor units, connect a vacuum pump to the refrigeration valve service ports.
2. Evacuate through the liquid and suction valve service ports to 500 microns or less for a minimum of 30 minutes. Close the valves to the pump and monitor the vacuum for 15 minutes. The vacuum should not rise above 800 microns.
3. If a vacuum of 500 microns cannot be obtained, or if it rises above 800 microns over the 15 minute period, discontinue evacuation, pressurize the system with nitrogen and look for leaks. Repair any leaks that are found and repeat step 2.
4. Close the valves to the vacuum pump, turn the pump off, and disconnect it from the refrigerant valve service ports. Open the liquid and suction service valves fully, releasing the R-22 into the system. Connect the service gauges to the refrigerant valve service ports.
5. Set the indoor remote control to cool mode and ensure proper operation. Allow unit to run for a period of 10 minutes to allow system pressures to stabilize.
 - * Make sure that proper pressures are observed.
 - * Check proper temperatures in space, to ensure temperatures match those on remote control.
 - * Check condensate drain hose for proper drainage.
 - * Check for any abnormal vibration noises and correct as needed.
 - * Check for any signs of refrigerant leakage.
6. Set the indoor remote control to heat mode and ensure proper operation. Allow unit to run for a period of 10 minutes to allow system pressures to stabilize. Follow same checkouts as cool mode.

HOW TO INSTALL DRAIN ACCESSORIES

There will be some water dripping from the condenser when the heat pump is working during the heating mode. Two drain caps, a drain elbow with rubber collar and a plastic hose (5/8" x 6") are supplied for user's choice.

INSTALLATION STEPS:

- (1) Observe the drainage flow of the three drain holes on the base while pouring water into the condensing unit evenly around the condenser. (Figure 1)
- (2) Connect the drain elbow and the plastic hose. (Figure 2)
- (3) Insert the drain elbow connected with the drain hose into the hole which has the largest drainage flow and rotate it to the wall side of the building in order to make the drainage flow against the wall. The other two holes of the base should be stopped by using the two drain caps. (Figure @)

NOTE:

If the drain hole inserted with the drain elbow is not at the desired location, adjust the level of the condensing unit slightly, and then reinstall the accessories according to the above steps.

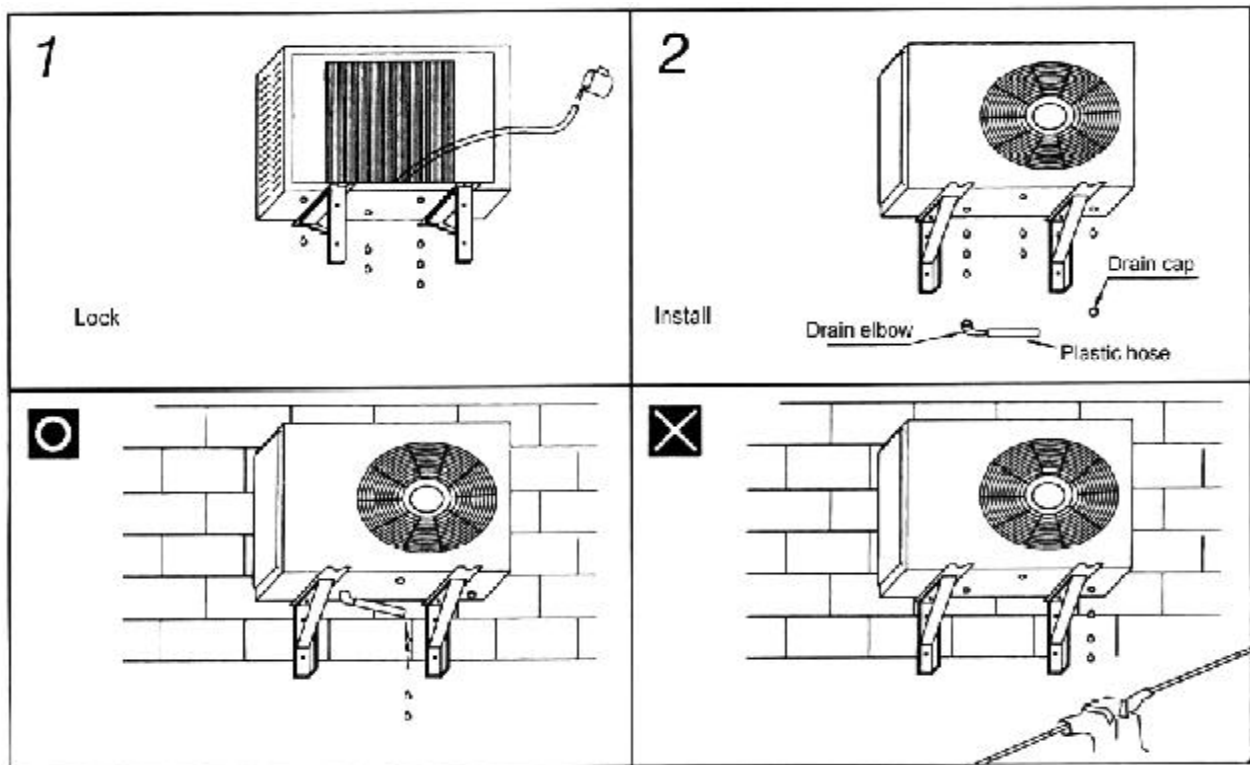

Electrical schematic diagram

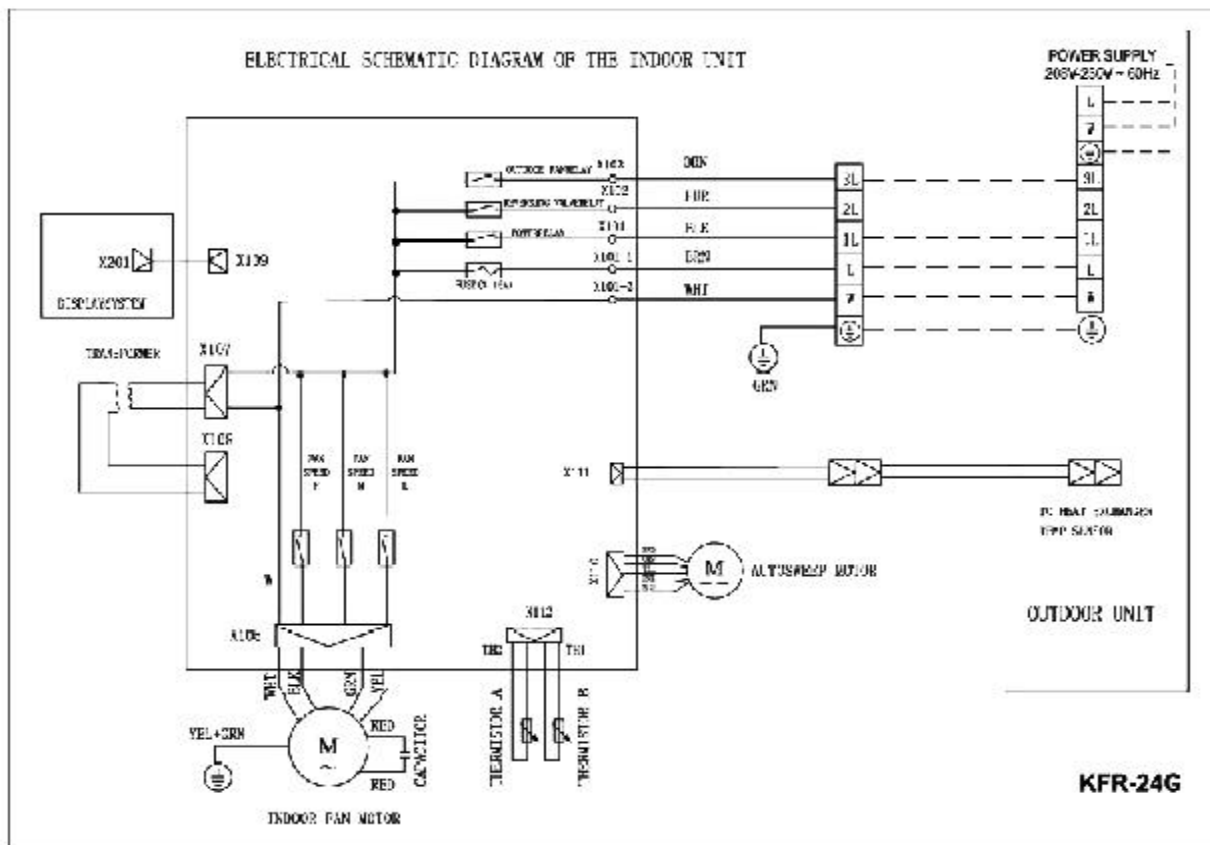
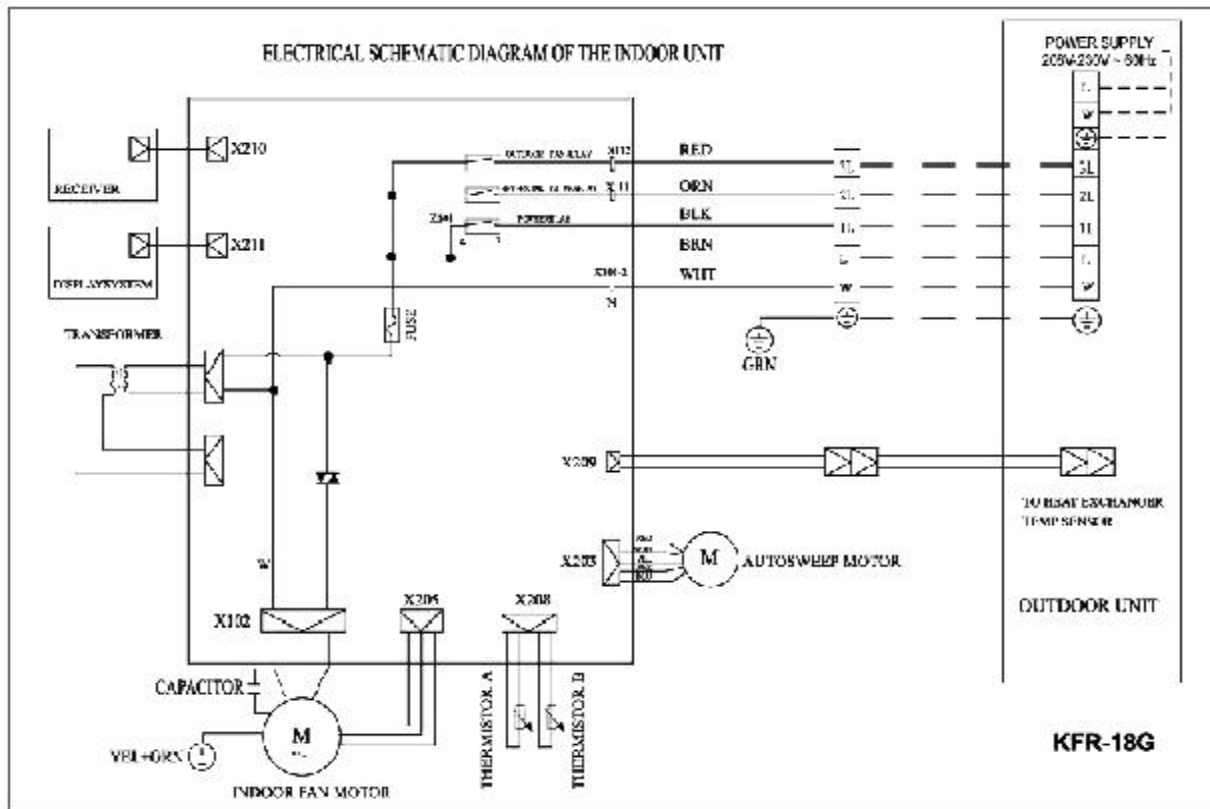

Electrical schematic diagram

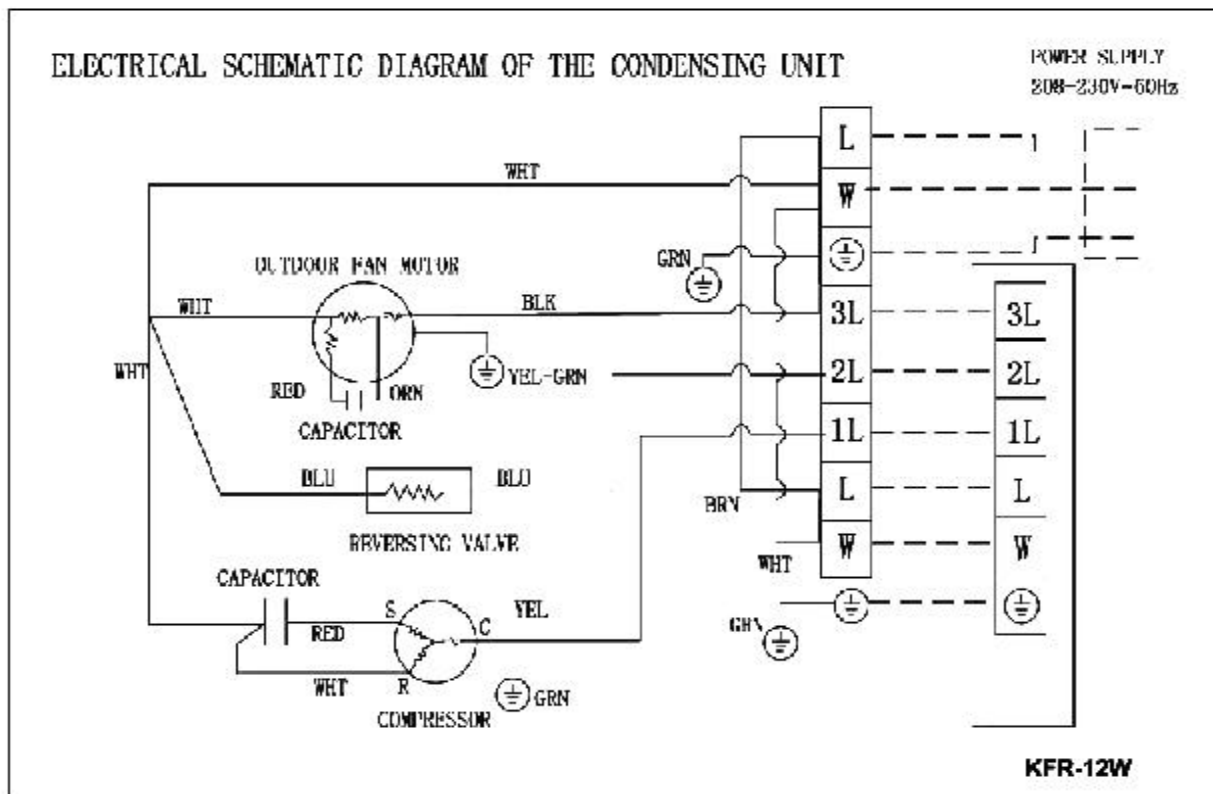
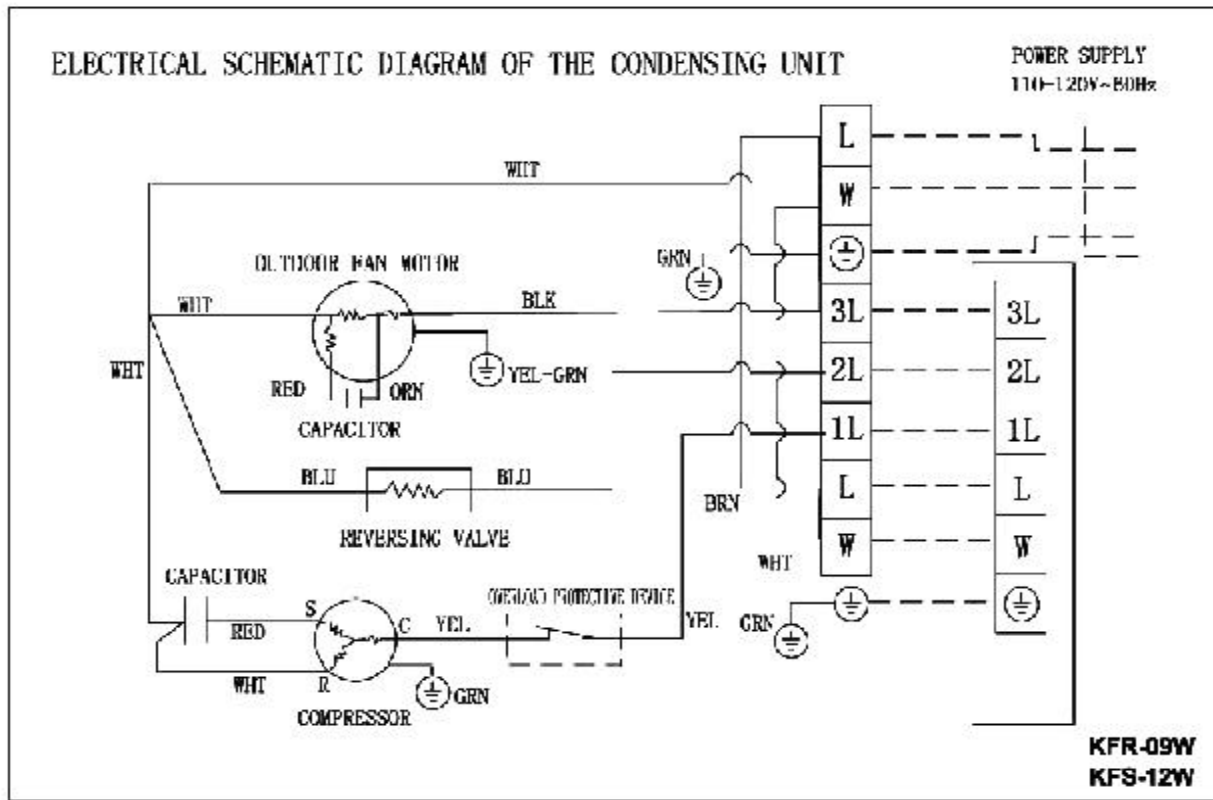







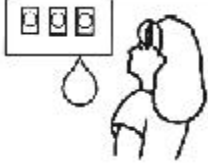

WARNING

- ❗ **USE COPPER WIRES ONLY FOR POWER SUPPLY.**
- ❗ **WARNING: RISK OF ELECTRIC SHOCK CAN CAUSE INJURY OR DEATH. DISCONNECT ALL ELECTRIC POWER SUPPLIES BEFORE SERVICING.**
- ❗ **DURING CONNECTION OF THE REFRIGERATION TUBES, IF EXCESSIVE TORQUE IS IMPOSED ON FLARE NUTS, SERVICE VALVE ON DISCHARGE LINE MAY BE DAMAGED. WHEN TIGHTENING FLARE NUTS OR NARROW PIPE, TORQUE SHOULD BE ADJUSTED BETWEEN 13.7~18.6N.M (140~190GF.CM).**
- ❗ **DO NOT PUT INDOOR UNIT IN LOCATIONS WHERE IT MAY GET WET.**
- ❗ **ELECTRICAL INSTALLATION MUST BE IN ACCORDANCE WITH LOCAL AND NATIONAL ELECTRICAL CODES.**
- ❗ **THE INSTALLATION OF THESE UNITS REQUIRES QUALIFIED PERSONNEL.**
- ❗ **CERTIFIED (APPROVED) POWER SUPPLY CONDUCTORS MUST BE USED.**
- ❗ **AN INDEPENDENT BRANCH CIRCUIT BREAKER MUST BE USED.**
- ❗ **MAXIMUM INTER CONNECTING WIRE LENGTH SHOULD NOT EXCEED 11.3M (37FT.)**
- ❗ **REFRIGERATING PIPE LENGTH MUST BE LIMITED BETWEEN 4~10M (13FT~33FT.) IF THE LENGTH EXCEEDS 7.62M (25FT.), THE COOLING (OR HEATING) CAPACITY MAY BECOME IMPAIRED.**
- ❗ **DIFFERENCE IN HEIGHT BETWEEN INDOOR AND OUTDOOR UNIT SHOULD NOT EXCEED 7M (26 FT.).**

Troubleshooting

If after checking the following conditions the unit still does not operate, call a qualified service technician.

Fault	Possible Condition
<p>Does not run</p> 	<ul style="list-style-type: none"> • Fault trip or fuse is blown. • Fault device trips to protect the appliance. • Batteries in the remote controller are dead. • Plug is not properly plugged into outlet.
<p>No cooling or heating</p> 	<ul style="list-style-type: none"> • Is the air filter dirty? • Are the intakes and outlets of the indoor or outdoor units blocked? • Is the temperature set properly?
<p>Ineffective control</p> 	<ul style="list-style-type: none"> • If strong interference (from excessive static electricity discharge, power supply voltage abnormality) is present, operation may be abnormal. If this occurs, disconnect from the power supply and connect back 2-3 seconds later.
<p>Does not operate immediately</p> 	<ul style="list-style-type: none"> • Changing modes during operation, must wait for 3 minute delay.
<p>Odors</p> 	<ul style="list-style-type: none"> • Odors may come from another source such as furniture, cigarettes, etc. These odors may remain on the indoor coil, or filter which may require cleaning.
<p>Sound of flowing water</p> 	<ul style="list-style-type: none"> • Caused by the flow of refrigerant in the air conditioner. • Sound from defrost mode in heating mode. (Note: For some model with a compressor indicator (red), it lights up during defrosting.)
<p>Slight crackling heard</p> 	<ul style="list-style-type: none"> • The sound may be generated by the expansion or contraction of the front plastic panel due to change of temperature.
<p>Moisture from the outlet</p> 	<ul style="list-style-type: none"> • Mist appears when the room air becomes very cold because of cool air discharged from indoor unit during "COOLING" or "DRY" operation mode.

Troubleshooting

RUN light blinks	Defect	What to check
1 time	Abnormality of room temperature sensor.	● Open circuit or short circuit of room temperature sensor.
		● Incorrect connection of the sensor.
2 times	Abnormality of defrost sensor.	<ul style="list-style-type: none"> ● Open circuit or short circuit of defrost sensor. ● Incorrect connection of the sensor.
3 times	Abnormality of indoor fan motor.	<ul style="list-style-type: none"> ● Indoor fan motor is defective. ● Bad connection to motor.
4 times	Abnormality of outdoor unit.	<ul style="list-style-type: none"> ● Compressor is defective. ● Refrigerant is low. ● Capacitor is defective.
Continuous blink	No defect-unit in defrost mode.	

Free Manuals Download Website

<http://myh66.com>

<http://usermanuals.us>

<http://www.somanuals.com>

<http://www.4manuals.cc>

<http://www.manual-lib.com>

<http://www.404manual.com>

<http://www.luxmanual.com>

<http://aubethermostatmanual.com>

Golf course search by state

<http://golfingnear.com>

Email search by domain

<http://emailbydomain.com>

Auto manuals search

<http://auto.somanuals.com>

TV manuals search

<http://tv.somanuals.com>