



PN.33-2159 6.01

IMPORTANT SAFETY INSTRUCTIONS

When using your Sonamp® 1230, basic safety precautions should always be followed to reduce the risk of fire, electric shock, and injury to persons, including the following:

1. Read instructions – All the safety and operating instructions should be read before the appliance is operated.
2. Retain instructions – The safety and operating instructions should be retained for future reference.
3. Heed warnings – adhere to all warnings and precautions listed on the appliance and in the operating instructions.
4. Follow instructions – Follow all operating instructions.
5. Water and moisture – The appliance should never be used next to water; for example, near a bathtub, kitchen sink, laundry tub, in a wet basement, or near a swimming pool, etc.
6. Carts and stands – The appliance should be used only with a cart or stand that is recommended by the manufacturer.
7. An appliance and cart combination should be moved with care. Quick stops, excessive force, and uneven surfaces may cause the appliance and cart combination to overturn.
8. Caution: To prevent electric shock, do not use the Sonamp (polarized) plug with an extension cord, receptacle, or other outlets unless the blades can be fully inserted to prevent blade exposure.
9. Ventilation – The appliance should be situated so that its location does not interfere with its proper ventilation. For example, the appliance should not be situated on a bed, sofa, register, or similar surface that may impede the flow of air through the ventilation openings.
10. Heat – The appliance should be situated away from heat sources such as radiators, heat registers, stoves, or other appliances (including amplifiers) that produce heat.
11. Power sources – The appliance should be connected to a power supply only of the type described in the operating instructions or as marked on the appliance.
12. Grounding or polarization – Grounding or polarization are the precautions that should be taken so that these attributes of an appliance are not defeated.
13. Power-Cord Protection - Power supply cords should be routed so that they are not likely to be walked on or pinched by items placed upon or against them, paying particular attention to cords at plugs, convenience receptacles, and the point where they exit from the appliance.
14. Cleaning - The appliance should be cleaned only as recommended by the manufacturer.
15. Non-Use Periods- The power cord of the appliance should be unplugged from the outlet when left unused for a long period of time.
16. Object and Liquid Entry - Care should be taken so that objects do not fall and liquids are not spilled through the opening of the enclosure.

INSTALLATION INSTRUCTIONS

SONAMP 1230 OWNER'S MANUAL PROFESSIONAL MATRIX POWER AMPLIFIER

17. Damage Requiring Service - The appliance should be serviced by a qualified service personnel when:
 - A. The power-supply cord or the plug has been damaged
 - B. Objects have fallen, or liquid has been spilled into the appliance
 - C. The appliance has been exposed to rain
 - D. The appliance does not appear to operate normally or exhibits a marked change in performance
 - E. The appliance has been dropped, or the enclosure damaged
18. Servicing - The user should not attempt to service the appliance beyond that described in the operating instructions. All other servicing should be referred to qualified service personnel.
19. Lifting – Do not attempt to lift the Sonamp® 1230 without assistance. Improper lifting of this 35 lb. unit can cause personal injury.
20. Power requirement – Do not connect the Sonamp® 1230 to the accessory outlet of another component. A minimum 15 amp grounded wall outlet is required.
21. Storms – To prevent damage to components, unplug all electronic equipment during thunderstorms.

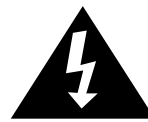
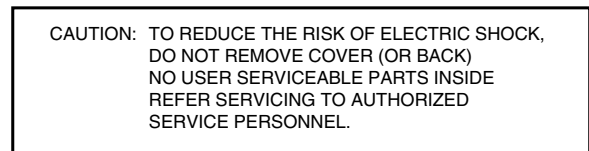

The lightning flash with arrowhead symbol, within an equilateral triangle, is intended to alert the user to the presence of uninsulated dangerous voltage within the product's enclosure that may be of sufficient magnitude to constitute a risk of electric shock to persons.



The exclamation point within an equilateral triangle is intended to alert the user to the presence of important operating and maintenance (servicing) instructions in the literature accompanying the appliance.

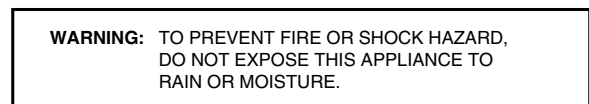

**WARNING
MOVE WITH CARE**

INTRODUCTION

Thank You for purchasing the Sonamp® 1230. Sonance has taken the versatile Sonamp® 1250 and improved it by adding more features, which makes the Sonamp® 1230 the most versatile and reliable multi-channel amplifier available. Most importantly, we listened to installers and end users and added features that they wanted.

ADDITIONAL AMPLIFIERS

If additional Sonamp® 1230's are used, we recommend separate 15 amp circuits for each amplifier due to the enormous power capability and requirements of this product. Non-buffered LINE OUT connections for left, right, and auxiliary channels are provided. Within the limits of available mains power, any number of additional Sonamp 1230 amplifiers may be daisy chained for larger installations.

ASSOCIATED COMPONENTS

A music reproduction system is only as good as its weakest link. To avoid disappointment, your Sonamp® 1230 should be used with other components of the highest caliber. The Sonamp® 1230 is compatible with most high quality preamplifiers, tuners, CD/DVD players, and Mini Disc decks; as well as better in-wall and cabinet mounted speakers from Sonance and other reputable manufacturers.

CARE AND MAINTENANCE

Retain the safety and operating instructions for future reference.

1. Follow all warnings and instructions in this manual and marked on the product.
2. Any service or repair required must be performed by qualified, factory authorized personnel.
3. To clean your Sonamp 1230, use a soft brush, "canned air," or wipe exterior surfaces with a damp cloth. Never use any cleaners or solvents.
4. Do not use this product in a high humidity environment or near water, for example a wet basement, wet bar, or swimming pool.
5. If the electrical service is subject to frequent sags, spikes, and brownouts, a power conditioner designed for use with high fidelity equipment may be employed to protect the Sonamp 1230.

SYSTEM CONFIGURATION

Read Getting The Most From Your Sonamp 1230 and plan your installation configuration. Due to the flexibility of the Sonamp 1230, the installation should be carefully planned to avoid errors.

Start by drawing a diagram of the system, like the examples in this manual. Plan the settings and connections to achieve your objective.

Verify that you have all of the parts and tools required for the installation:

- High fidelity interconnect cables such as Sonance Silver MediaLinQ OFC Interconnects.

- Speaker wires. These may be unterminated (tinned bare wire at connections) or spade, banana, or pin connectors. Gold plated connectors are preferred to resist oxidation.

- LS1 and LR1 balanced line-level sender and receiver (optional). If the amplifier is placed more than 20 feet from the source or preamplifier, the balanced sender and receiver provide a way to send low level audio signals long distances and near sources of noise interference without introducing noise or suffering high frequency roll-off (See Fig. 6 for example).

INSTALLATION

Unpacking

Save the carton and polystyrene inserts for future safe transport in case the amplifier is moved or the unit requires shipping for repair.

Before proceeding with installation, locate the serial number on the real panel of the unit and note it here for future reference :

S/N: _____

Placement

CAUTION: Do not attempt to lift the Sonamp 1230 without assistance. Improper lifting of this 35 lb. unit can cause personal injury.

Place the Sonamp® 1230 on a level surface, in an upright position, out of direct sunlight and away from windows through which rain may enter. **NOTE:** The amplifier must always rest on its four feet to allow ventilation or it will sustain damage.

Situate the amplifier away from heat sources such as hot air ducts or radiators. Be sure that the amplifier is adequately ventilated by convection or suitable cabinet fans. **CAUTION:** The Sonamp® 1230 requires four inches of clearance on the top and all sides. Never place any object on or against the amplifier. Never operate the amplifier on a carpeted surface as this will compromise ventilation. When the amplifier is installed in any cabinet, the front or back must be open during operation. Alternately, install fans in the cabinet to assure continuous ventilation.

Power Connection

The Sonamp® 1230 uses a 14 gauge EIA standard 120 volt grounded power cable (provided). Due to the power requirement of this amplifier, it is not advised that this cable be replaced with another of unknown quality. Connect the power cable to a 15 amp or 20 amp grounded wall outlet. Never attempt to operate the amplifier from the accessory outlet of another component.

Sensitive source components should be isolated from the Sonamp® 1230 with appropriate power conditioning to minimize hum from the amplifier's power supply.

Speaker Connection

Always turn off power and unplug the amplifier before making source signal or speaker connections.

Use quality speaker wire such as Sonance Silver or Gold

A

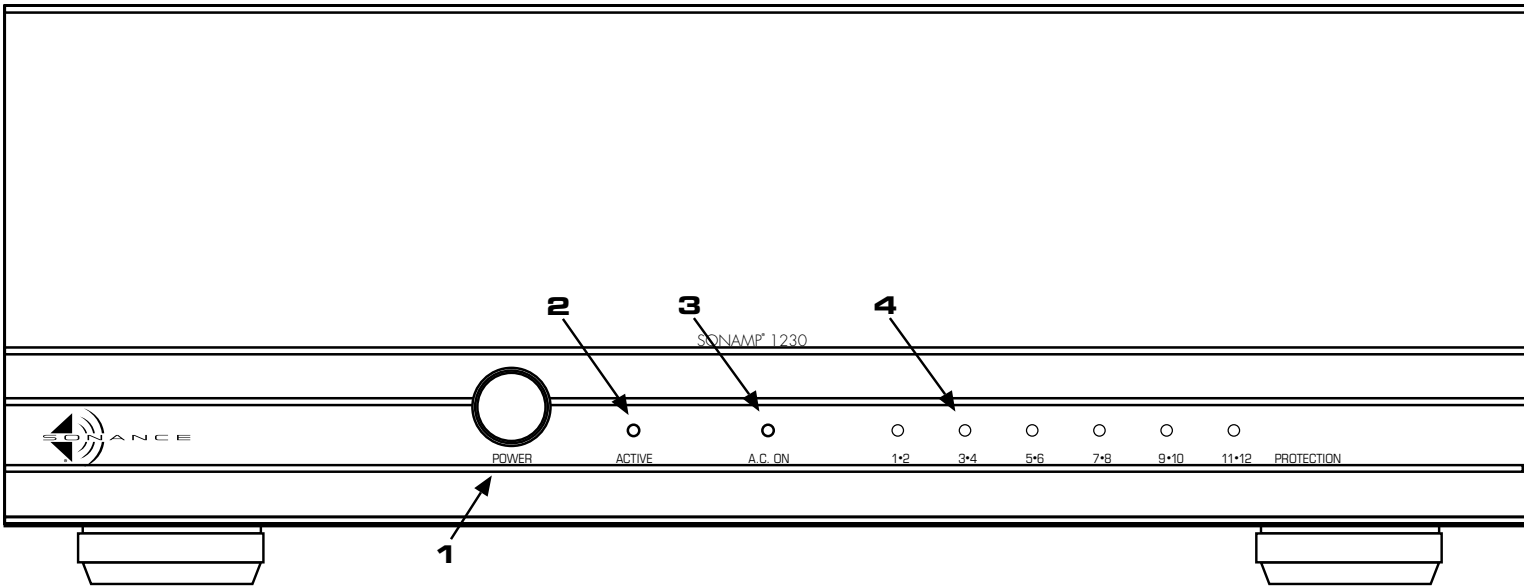

A. FRONT PANEL

1. POWER SWITCH
2. ACTIVE L.E.D.
3. POWER L.E.D.
4. FAULT INDICATORS

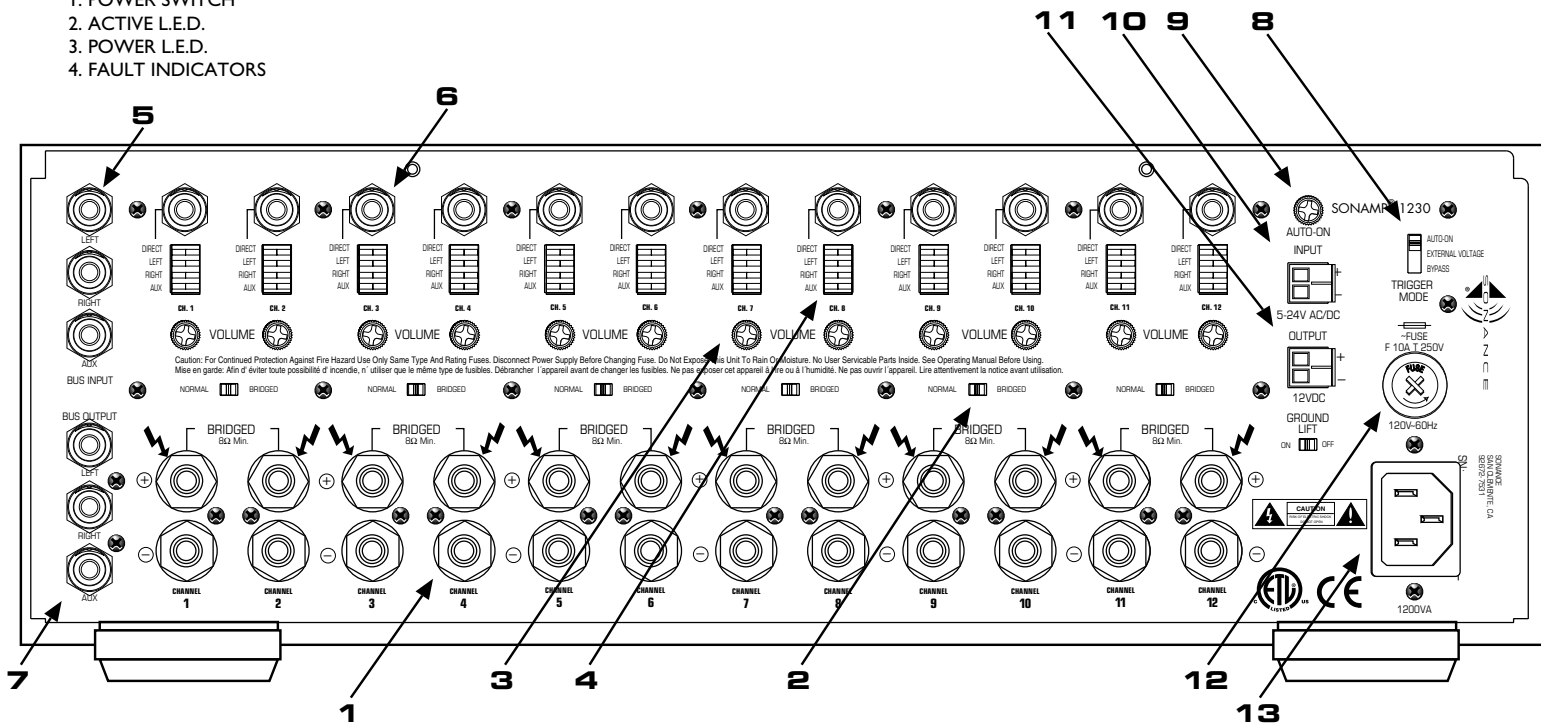

B

B. REAR PANEL

1. SPEAKER TERMINALS (12)
2. BRIDGING SWITCH (6)
3. INPUT LEVEL CONTROL (12)
4. SOURCE SELECTION SWITCH (12)
5. BUS LINE-IN JACKS (3)
6. DIRECT INPUT SOURCE JACK (12)
7. LINE-OUT JACKS (3)
8. TRIGGER SELECT SWITCH
9. AUTO-ON SENSITIVITY CONTROL
10. CONTROL VOLTAGE INPUT
11. CONTROL VOLTAGE OUTPUT
12. ~ POWER FUSE RECEPTACLE
13. ~ POWER CORD RECEPTACLE

MediaLinQ™ cable to assure optimum sound reproduction. Small gauge or inferior quality wire will degrade imaging, diminish bass reproduction, and add a generally congested quality to music. Always check local building codes before installing wire in walls or ceilings.

Wires may be terminated with banana plugs for convenience if connections will be changed frequently. Any connector should be gold plated to prevent oxidation, which degrades sound quality. The binding posts on the Sonamp® 1230 also accept twisted bare wire ends through the 45° opening in their center shafts. Do not overtighten shafts. Tinning the bare copper wire is recommended. As an option, use contact enhancer on mating surfaces of connections to retard oxidation and enhance signal flow. Do not strip more than 1/2" of the jacket from speaker wires.

Always provide sufficient slack in wires to avoid tension or accidental disconnection. Always contain any excess wire to prevent tripping hazards.

Source Connection

Always use quality high fidelity interconnect cables such as Sonance Silver MediaLinQ OFC Interconnects. If source components are more than 20 feet from the amplifier, use the LS1 and LR1 balanced line-level sender and receiver to avoid signal degradation (As shown in Figure 6).

Plug source components (receiver, preamp, page signal) to the LINE IN bus inputs at the top center of the amplifier.

Plug dedicated sources (zone output, page signal, video game, or electronic doorbell) into the DIR (direct) channel inputs if desired.

Plug downstream amplifiers to the non-buffered LINE OUT bus outputs at the bottom center of the amplifier.

Source Settings

The fourplex DIP switches of the Sonamp® 1230 provides the most flexible configuration options of any multichannel amplifier. Settings are changed by moving the switches from (ON) to (OFF):

- L Assign to master left channel source
- R Assign to master right channel source
- L + R Mono reproduction of source
- AUX Assign to AUX channel source
- DIR Select dedicated channel input.

Note: It is possible to assign one or all switches as needed (L+R+AUX, where AUX is the page input for a hallway or waiting room with paging.

Volume Control

The individual channel volume controls are useful to balance the desired sound levels for various zones, to balance output from right and left channels to compensate for room characteristics such as size and ceiling height. Also, by reducing the Sonamp volume control settings, you compel the source preamp or receiver volume control to operate in the middle of its range. do not set the level controls higher than the maximum level desired. Place tape over the VC hole to prevent tampering.

Power Trigger Controls

The Sonamp® 1230 may be automatically activated by an input signal, low voltage trigger, or manual pushbutton. It also provides a 12 volt DC output to trigger other components.

Auto-On Control

To use the Auto-On feature, turn the main power switch ON and slide the TRIGGER switch on the rear panel to the UP position. Use the SENSITIVITY control to set the minimum signal level that will activate the amplifier. In this mode, the amplifier will automatically turn off after 8 minutes of no input signal at any of the 12 channel inputs. The Auto-On mode disables the other two triggering modes.

Voltage Control

When the TRIGGER switch is set to EXTERNAL VOLTAGE (the center position) and the main power switch (on the front panel) is set to ON, the amplifier will be activated by the presence of AC or DC voltage, from 5 to 24 volts, at the INPUT connector. The EXTERNAL VOLTAGE mode disables the other two triggering modes. (DO NOT CONNECT TO 120VAC LINE VOLTAGE)

Bypass

If the TRIGGER switch is set to BYPASS (the bottom position) and the main power switch (on the front panel) is set to ON, the amplifier will always be active. The BYPASS mode disables the other two triggering modes.

Ground lift

The GROUND LIFT switch breaks ground loops that can occur between source equipment and amplifiers. Set the GROUND LIFT switch to OFF for most applications. When the Sonamp 1230 is to be used in an equipment rack, set the GROUND LIFT switch in the ON position. This will isolate the audio circuitry from the chassis. Thus, the chassis need not be isolated from the equipment rack with insulator washers.

Status LEDs

AC ON LED – This red LED indicates that the AC power line cord is plugged into a live AC outlet. If the main AC line fuse opens, this LED goes out. The main power switch setting does not impact this LED.

ACTIVE LED – This green LED indicates that the amplifier has been activated via one of the three methods described previously.

PROTECTION LEDs – These amber LED's light during a fault condition, one LED for each pair of channels. If one of the Sonamp 1230's protection circuits is triggered, the LED will turn on. If a channel pair encounters a short-circuit event or an extremely low impedance, the respective LEDs will light (1&2, 3&4, 5&6, 7&8, 9&10, 11&12). All other channel pairs are unaffected. If the heat sink temperature is exceeded because of poor air circulation or high ambient temperature, a cutoff switch attached to left and right channels will activate. Each bank (1&2, 3&4, 5&6 or 7&8, 9&10, 11&12)of a Protect LEDs will then light to signify a fault. If amplifiers are in Bridged mode, the Protection Circuitry will sense a short circuit across both positive speaker terminals and also positive to negative speaker terminal.

Each time the amplifier is initially plugged in and the main power switch is turned on, the protection LEDs will light for approximately 3 seconds while amplifier circuitry is stabilizing. This prevents spikes and thumps from getting to speakers. Any time the protection circuits are triggered, turn the main power switch off before troubleshooting for shorted output connections or faults with source components.

Bridging Channels

Bridging a pair of 30W channels to yield one 60W channel is a simple operation of moving the toggle switch from the NORMAL position to the BRIDGED position. This operation subsequently disables the routing/switching function of the channel directly below the bridged channel. This would apply to even numbered channels (2,4,6,8,10,12). The dip switch controls for the BRIDGED channel is directly related to the odd numbered channels(1,3,5,7,9,11). The bridged channel would then use both positive speaker binding post connections (red + terminals) to connect to speakers. (8Ω speakers only) Do not use double banana plugs for bridged connections.

INSTALLATION SAFETY

When installing the Sonamp 1230, basic safety precautions should always be followed to reduce the risk of fire, electric shock, and injury to persons, see the following:

1. Read and understand all instructions.
2. Follow all warnings and instructions in this manual and marked on the product.
3. Any service or repair required must be performed by qualified factory authorized personnel.
4. Do not install this product in a high humidity environment or near water, for example a wet basement, wet bar, or swimming pool.
5. Do not defeat the ground pin on the AC cord.
6. Disconnect the AC power to Sonamp® 1230 when wiring or reconfiguring connections.

INSTALLATION EXAMPLES

Diagrams of these examples follow later in this manual. The following six system examples are only the beginning, with some imagination, many other variations are possible.

Basic Background Music System (Figure 1)

Features

- 6 Room
- Common Music Source
- Passive Volume Control at each Zone

Perhaps the simplest configuration of the Sonamp 1230 uses a single source preamplifier into six sets of stereo speakers, one pair of speakers per room. The factory default rear panel DIP switches and toggles are set for this application. This is a single zone system. Note that each room may have a volume control as

well as a preset maximum volume level (using the 1230 volume controls). This capability allows tailoring sound reproduction to the size and use of each room.

If one room requires more power, a pair of high output channels may be configured by bridging two pairs of channels.

Commercial Background Music System with Paging Capabilities (Figure 2)

Features

- 6 Room
- Common Music Source
- Two Zones with AUX Input for Paging Function

Adding a microphone preamplifier connected to the AUX input provides the capability of mixing the stereo source with paging. For maximum flexibility, each channel is individually configurable to use or ignore the AUX input. Use an AL1/S to mute the audio inputs during paging.

A great application for restaurants, nightclubs, offices, etc.

Note: If possible, adjust the microphone preamp volume level slightly higher than the other input source.

Multiple Zone Music System (Figure 3)

Features

- 5 Zones are fed from Main System
- 1 Zone is a Dedicated system with IR Control of Volume and Input Selections

Using the Sonance Navigator Harbor, a matrix preamplifier capable of directing signals to multiple amplifier inputs, or employing several discrete preamplifiers, the Sonamp 1230 may be configured to provide different program material to all, or some zones. The main input can drive any channels not individually connected to sources.

Home Theater and Music System (Figure 4)

Features

- 10 Channels Bridged to 5 channels for 60 watt per channel Theatre Output
- 2 Channels for Second Room Output on Receiver or Separate Input Source

A five channel surround sound system may be configured from five channels. The five bridged channel configuration leaves two channels available for stereo reproduction in other zones.

In larger home theaters where high listening levels must be supported, every channel pair may be bridged, creating six 60 watt channels to support speakers in the LCR (left, center, right), surround, and subwoofer roles.

A surround sound receiver may be configured to provide source signal to the Sonamp 1230 for one room, while independently driving another set of surround speakers with its internal amplifier.

Multiple Source/Multiple Zone with Paging (Figure 5)

Features

- 1 Zone is HIGH POWER with Bridged Outputs and IR Control
- 2 Zones are STEREO with Volume Controls
- 4 Zones are MONO with Impedance Matching Volume Controls and Paging
- 1 Zone is STEREO with Volume Control and Paging
- AUX Input for KSU Paging in Selected Zones

This configuration shows several rooms in stereo mode while utilizing mono in selected areas. Note that certain areas receive the paging signal. Due to its large size, the master bedroom receives a bridged 4 channels providing 60 watts per channel .

Major Corporate System (Figure 6)

Features

- Automatic 2 source Main Music
- 8 Speakers on 2 Channels with Impedance Matching Volume Controls and MONO Function
- 4 Zone Keypad System
- Executive Office controls with option to select from Main Source to Local
- AC Power Control of Main Music Sources
- Key Switch On/Off of Entire System, Auto-On Feature Defeated, 12v control for AC Switching
- AUX Input for KSU Paging in Selected Areas

A specialized installation that includes remote key switch turn on and usage of multi-zone controllers for individual spaces with keypad controls. Executive suite is specialized with main/local source selection and control of entire system. Restrooms, small vestibules, elevators, and large rooms arranged in multiple seating areas are some examples of spaces more appropriate to monaural music. Each of the Sonamp 1230's 12 channels may be individually configured for monaural reproduction if required to achieve smooth coverage of the entire musical content of the source.

A Basic Six Zone System (Figure 7)

Features

- 6 Rooms
- 3 Music Sources
- 3 Video Sources
- Sonance Navigator Master keypads at each zone

This diagram depicts a basic six zone install featuring a Sonance Navigator Harbor with three audio and three video inputs feeding a Sonamp 1230 amplifier with voltage turn on, as well as feeding video to three TVs located in zones two, five and six. Each of the six zones is controlled by a Sonance Navigator Master keypad. The source components are controlled by the Harbor's Common IR outputs. When only a couple source components are present, the 200VA switched power outlet can be used to power up these devices. A voltage controlled power strip to power up more source components is recommended to prevent overloading of the switched AC outlet. The Control Output of the Harbor should be used to control the power strip. (Do not exceed the 100mA rating of the Control Output.)

MAINTAINING YOUR SONAMP 1230

The Sonamp® 1230 does not require periodic maintenance and has no user serviceable parts inside. Do not remove the top cover as this will increase your risk of electric shock. To keep the amplifier clean, use only a soft cloth and never use any solvents or abrasives. Fingerprints may be removed with a soft cloth moistened only with a few drops of water.

SPECIFICATIONS

All Channels Driven	
Output Power, Stereo mode, RMS:	30 Watts per channel, 12 channels @8Ω 45 Watts per channel, 12 channels @4Ω 60 Watts per channel, 6 channels @8Ω bridged
IHF: Dynamic Power:	49 Watts per channel, 12 channels @8Ω 78 Watts per channel, 12 channels @4Ω 158 Watts per channel, 6 channels @8Ω bridged
Dynamic Headroom:	+2.13dB, 12 channels @8Ω +2.38dB, 12 channels @4Ω +4.15dB, 6 channels @8Ω bridged
Total Harmonic Distortion:	0.1% 20Hz-20kHz @8Ω (30 WRMS) 0.25% 20Hz-20kHz @4Ω (45 WRMS) THD @ 1kHz less than 0.01% with 8Ω (30 WRMS) THD @ 1kHz less than 0.01% with 4Ω (45 WRMS)
I.M. Distortion (SMPTE 4:1) @8Ω:	0.01% @ 30 Watts
Signal to Noise Ratio:	-100dB below rated output (A-weighted)
Input Sensitivity:	700 millivolt for 30 watts RMS @8Ω
Input Impedance:	20kΩ
Power Consumption:	1400 Watts maximum @ 4 ohms, full power 6.5 Watts, standby
AC Fuse	10A AG
Optional Items	3-space Rack Mount Faceplate
Dimensions:	16-3/4" x 5-3/4" x 15-3/8" (425mm x 146mm x 391mm)
RMF Dimensions:	19" x 5-1/4" x 15-3/8" (483mm x 133mm x 391mm)
Shipping Weight:	38 lbs (17kg)

TECHNICAL ASSISTANCE

If you have any questions about the operation or installation of your Sonance Sonamp 1230, please call our Technical Assistance Department on any business day at:

• (800) 582-0772 or (949) 492-7777 from 9 a.m. to 5 p.m., PST

OBTAINING SERVICE

Should your product require repair or service, contact your authorized Sonance retailer for help, or use the following procedure:

1. Prior to calling, note the product model number, serial number, purchase date, and original retailer's name and address.
2. Contact our Technical Assistance Department at the number(s) above and describe the problem. If required, a Return Merchandise Authorization (RMA) number will be issued. **IMPORTANT:** Do not return the unit to Sonance without first obtaining an RMA number.
3. If you are directed to return the unit to Sonance for repair, pack the unit in its original shipping cartons(inner & outer). Replacement packaging can be obtained from Sonance for a small charge.
4. Contact United Parcel Service, Federal Express, or RPS to arrange prepaid (not collect) shipping. Do not use the United States Postal Service. **IMPORTANT:** Freight collect shipments will be refused.
5. Write the Return Merchandise Authorization number on the outside of the shipping carton.
6. For warranty work, please include a copy of the original bill of sale inside the package.

Ship the packaged unit to:

Technical Assistance Department

Sonance

212 Avenida Fabricante

San Clemente, CA 92672-7531

WARRANTY COVERAGE (USA ONLY)

If, within one (1) year from the date shown on the bill of sale, the unit fails due to a defect in workmanship or materials, Sonance will, at its option and at no charge to purchaser, repair or replace the components of such unit which proves to be defective.

For this warranty to be effective, the bill of sale must show that the unit was purchased from an authorized Sonance retailer. This warranty shall apply exclusively to the original purchaser and shall not apply to units purchased for industrial or commercial use.

Furthermore, this warranty shall not apply if:

1. Damage to the unit was caused by accident, abuse, or misuse;
2. The unit was opened, modified, or repaired by unauthorized personnel; or
3. The unit was not used as outlined in the operating instructions.

Exclusions and Limitations

The warranty set forth above is in lieu of all other warranties, express or implied, of merchantability, fitness for a particular purpose, or otherwise. The warranty is limited to Sonance products registered herein and specifically excludes any damage to any associated equipment, which may result for any reason from use with this product.

Sonance shall, in no event, be liable for incidental or consequential damages arising from any breach of this warranty or otherwise. This warranty gives you specific legal rights, and you may have other rights, which vary from state to state.

Figure 1 Single Zone
Factory Default Settings for DIP Switches and toggle switches
of Channel Assignments

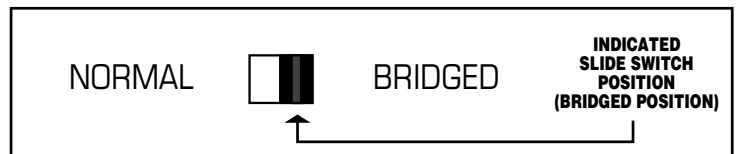
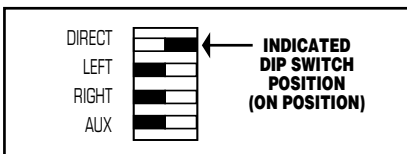
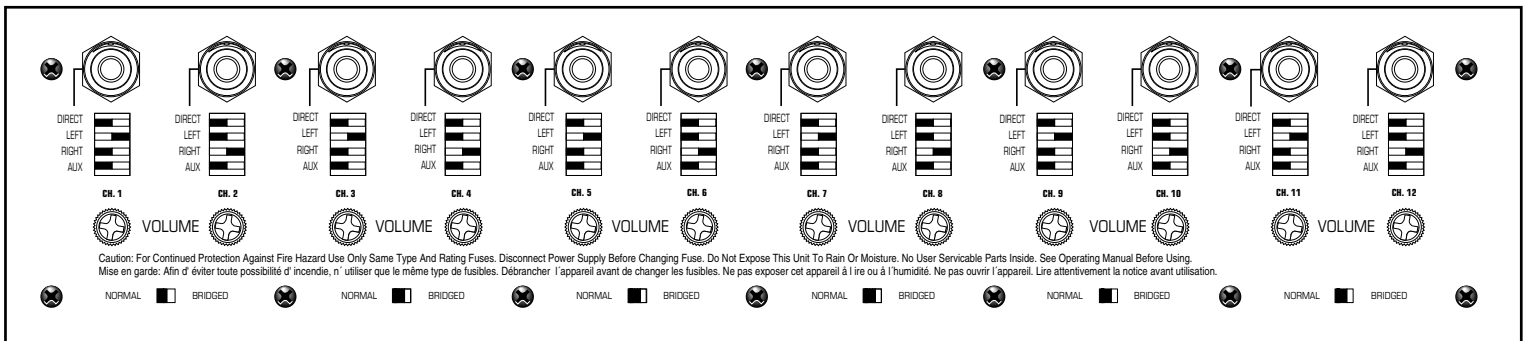
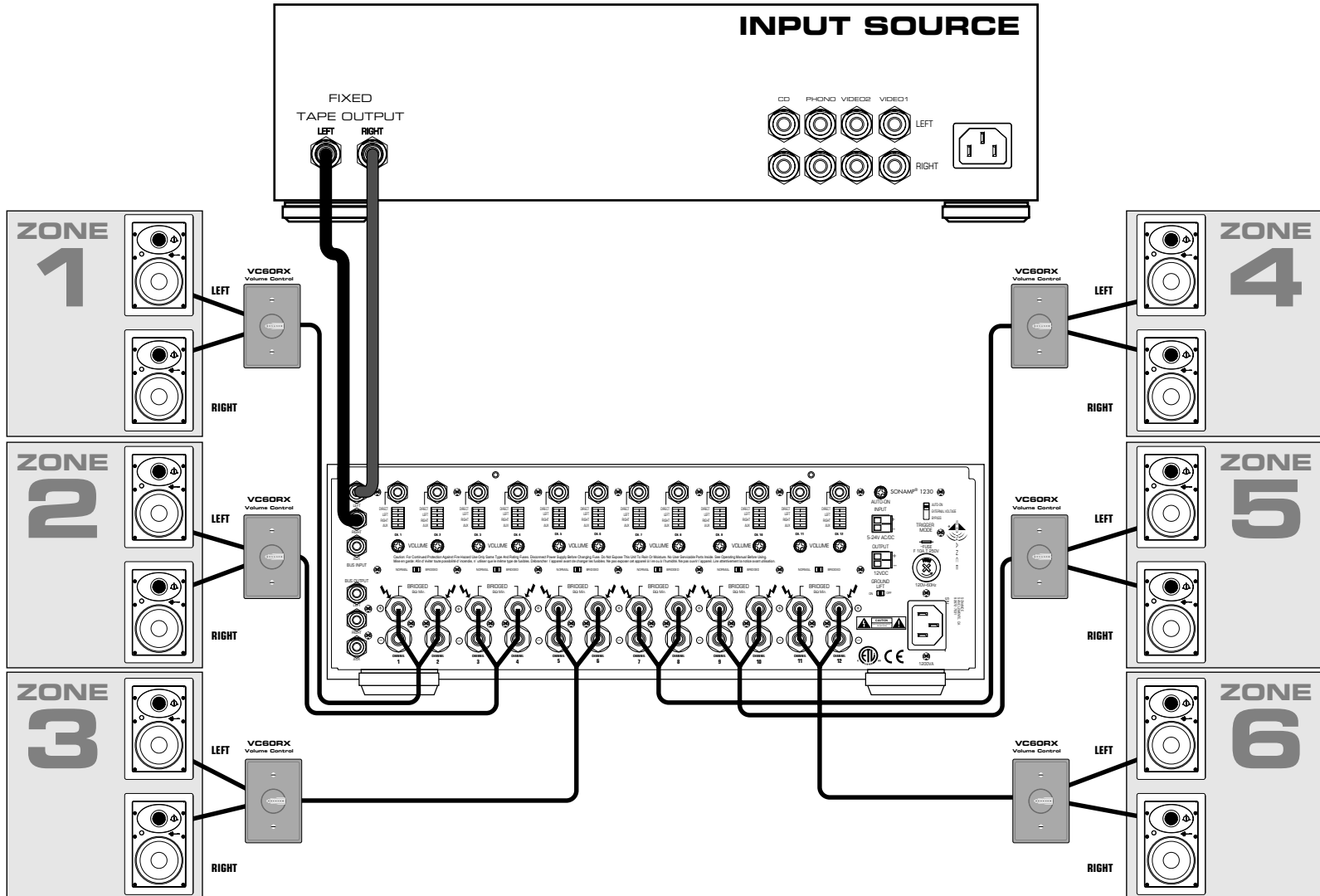

Figure 2 Single Zone plus Paging

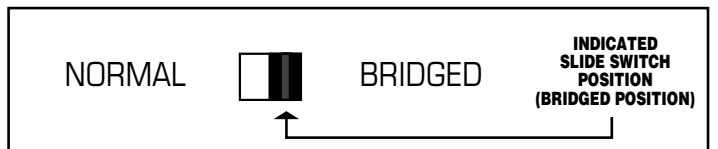
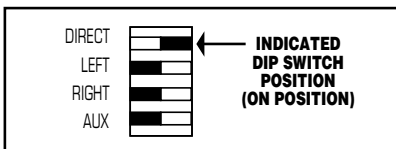
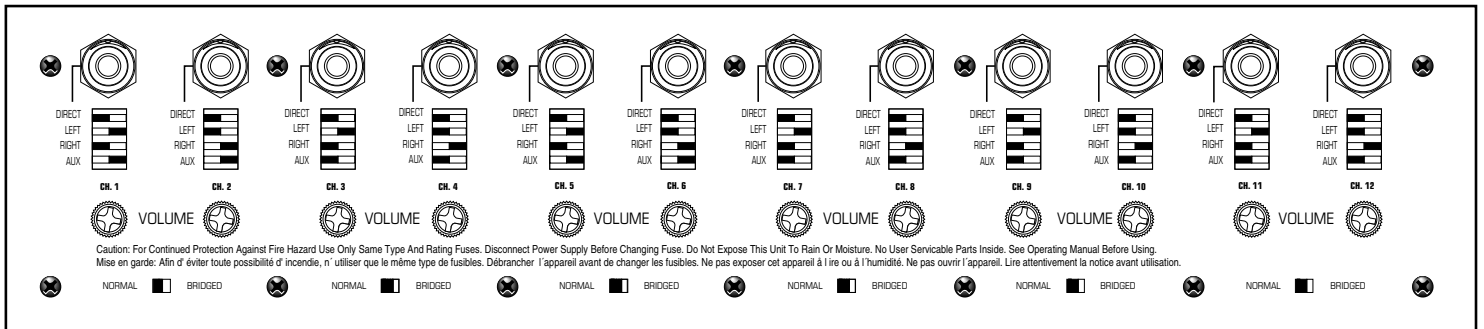
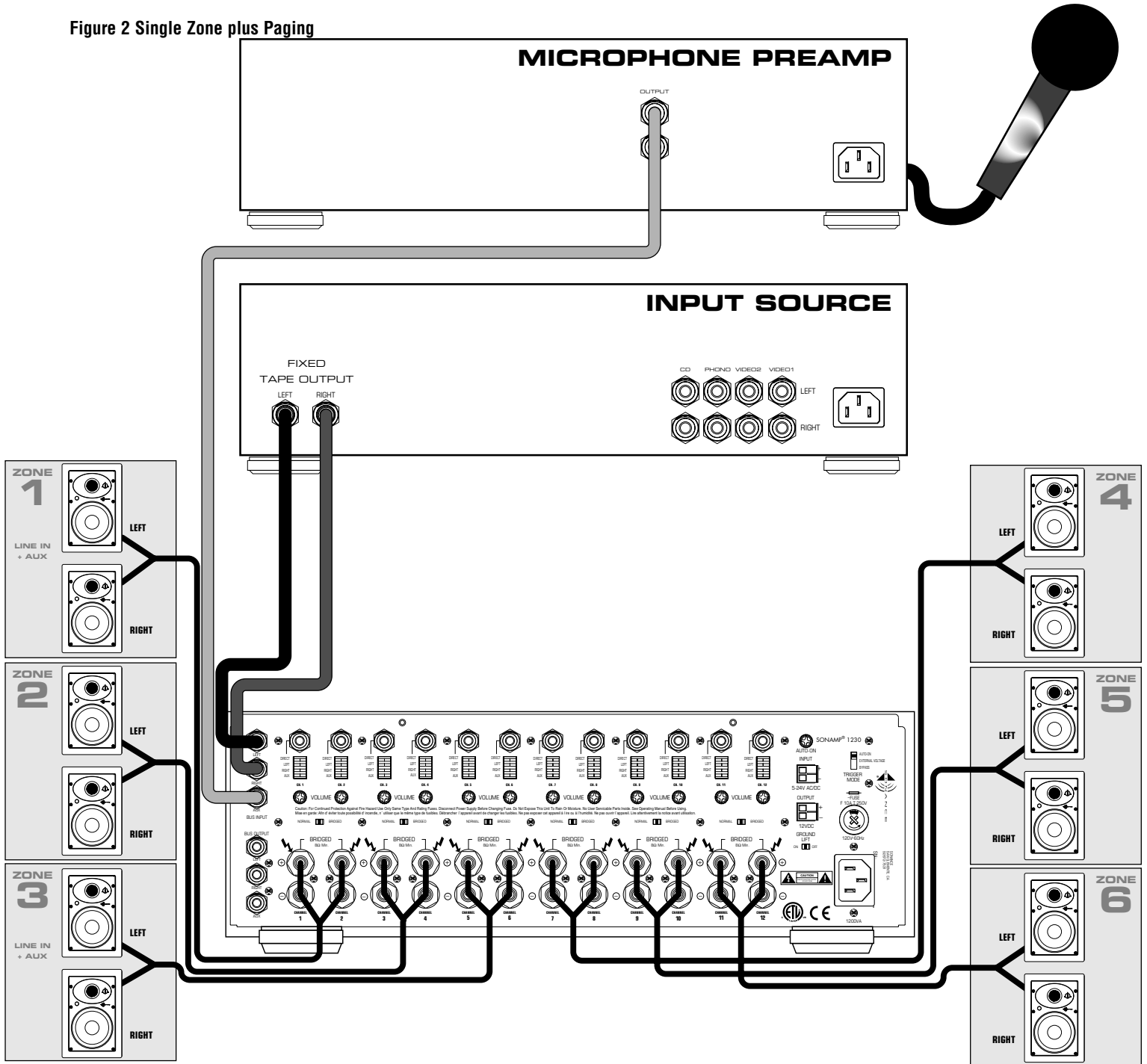
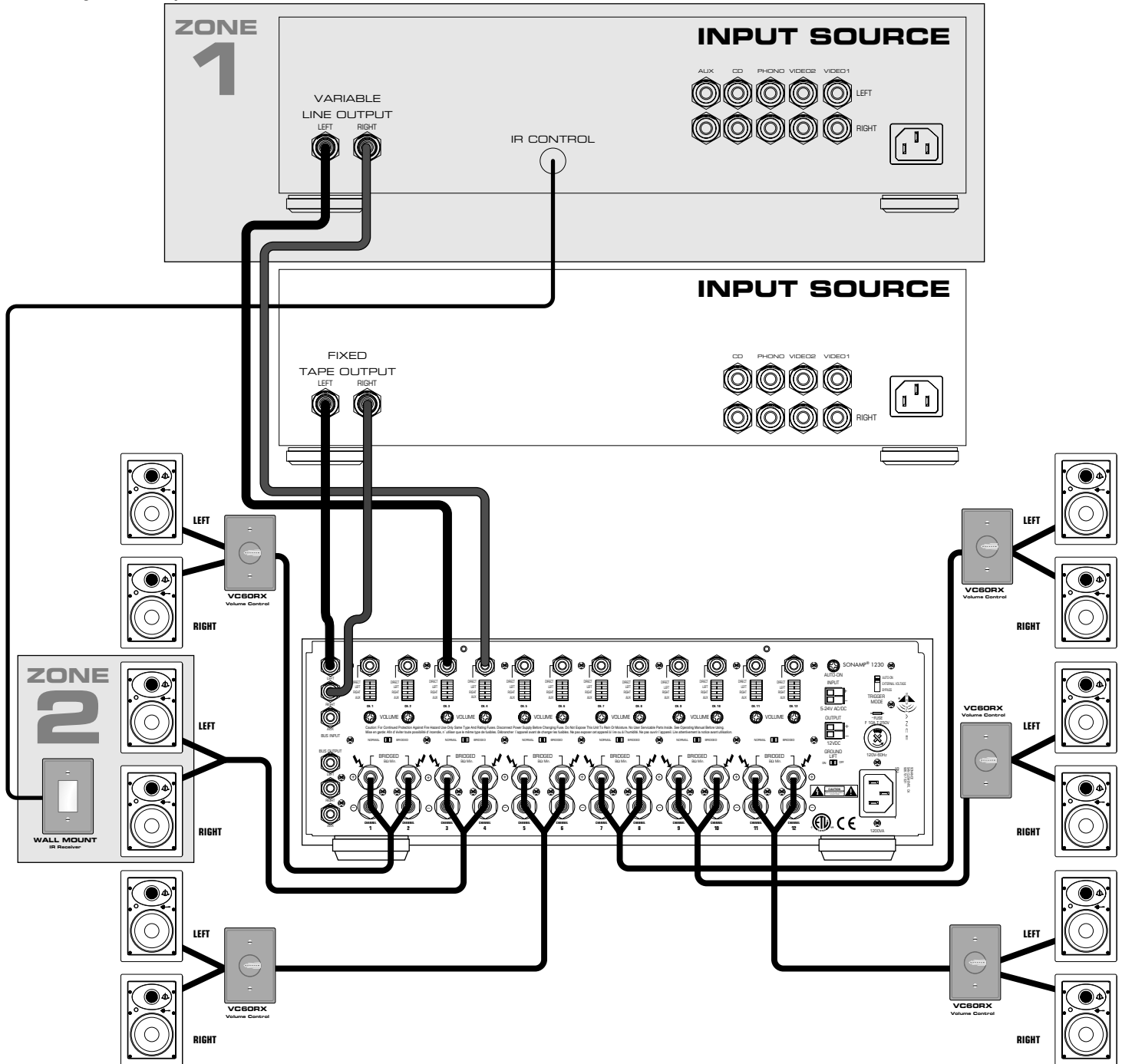

Figure 3 Multiple Zone



CH. 1	CH. 2	CH. 3	CH. 4	CH. 5	CH. 6	CH. 7	CH. 8	CH. 9	CH. 10	CH. 11	CH. 12

Caution: For Continued Protection Against Fire Hazard Use Only Same Type And Rating Fuses. Disconnect Power Supply Before Changing Fuse. Do Not Expose This Unit To Rain Or Moisture. No User Servicable Parts Inside. See Operating Manual Before Using.
 Mise en garde: Afin d'éviter toute possibilité d'incendie, n'utiliser que le même type de fusibles. Débrancher l'appareil avant de changer les fusibles. Ne pas exposer cet appareil à l'eau ou à l'humidité. Ne pas ouvrir l'appareil. Lire attentivement la notice avant utilisation.

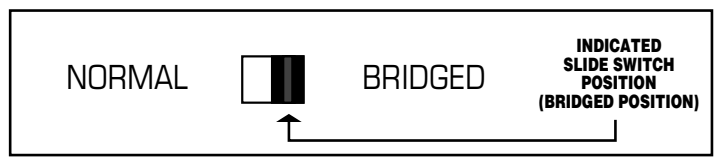
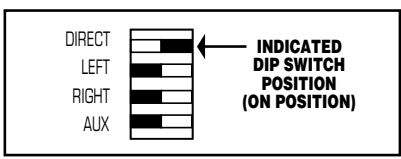

Figure 4 HomeTheater Surround / Stereo Zone

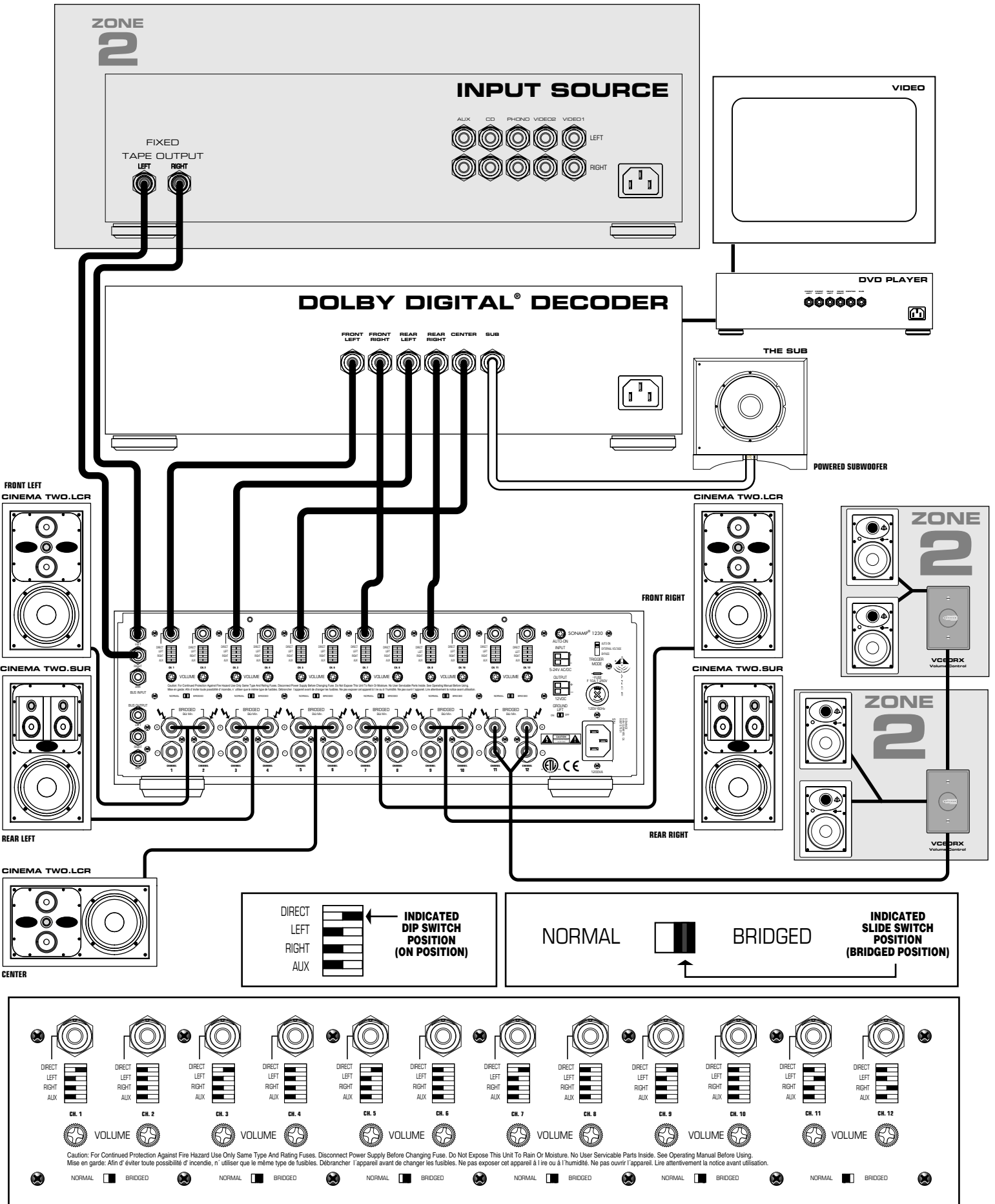
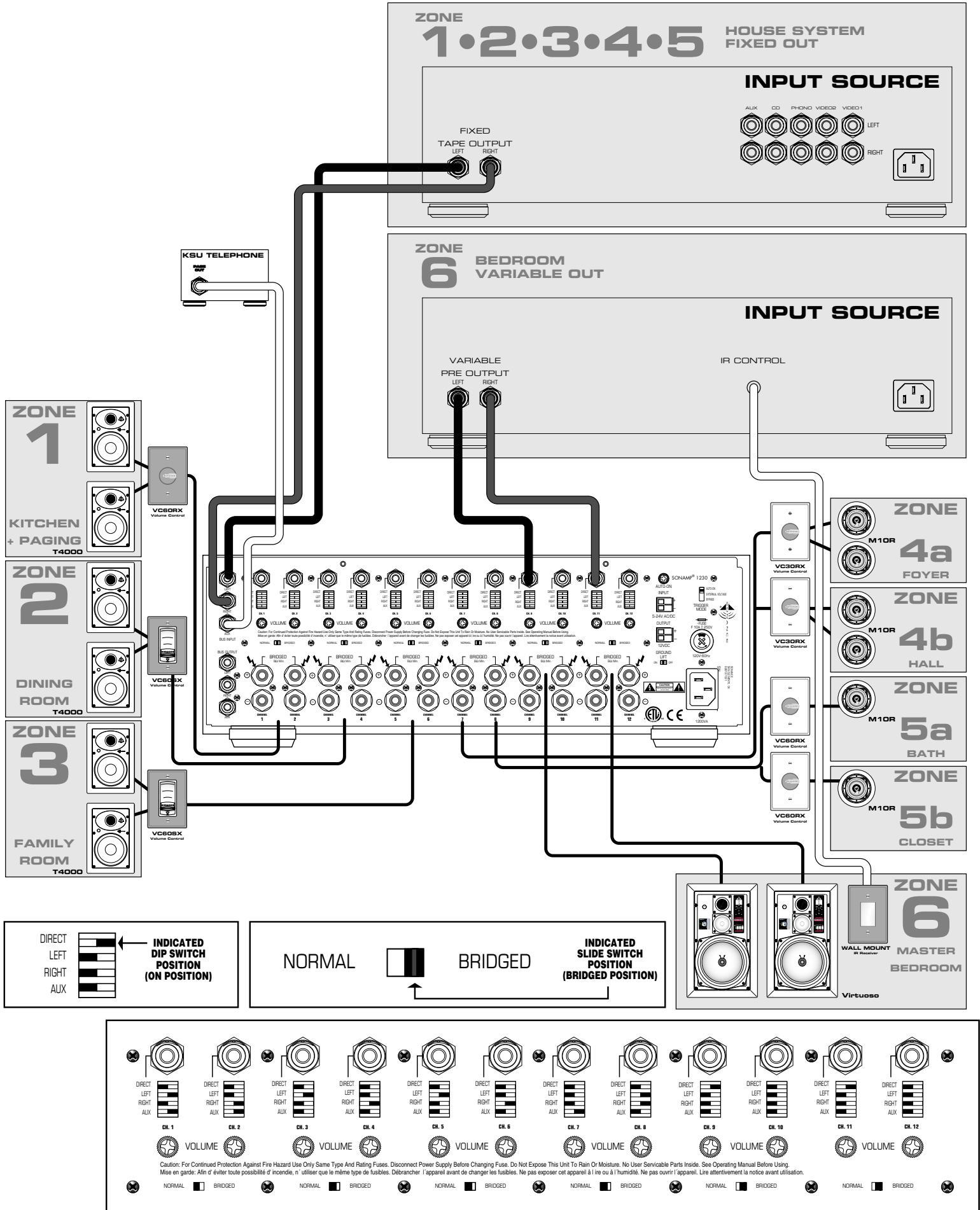

Figure 5 Multiple Amplifier / Home Theater/Multiple Zone+Paging



Free Manuals Download Website

<http://myh66.com>

<http://usermanuals.us>

<http://www.somanuals.com>

<http://www.4manuals.cc>

<http://www.manual-lib.com>

<http://www.404manual.com>

<http://www.luxmanual.com>

<http://aubethermostatmanual.com>

Golf course search by state

<http://golfingnear.com>

Email search by domain

<http://emailbydomain.com>

Auto manuals search

<http://auto.somanuals.com>

TV manuals search

<http://tv.somanuals.com>