



Interchangeable Lens Digital Camera

ILCE-5100

α



Use this manual if you encounter any problems, or have any questions about your product.

How to Use

[Before Use](#)



[Preparing the camera](#)



[Confirming the operation method](#)



[Shooting](#)



[Using shooting functions](#)



[Viewing](#)



[Changing settings](#)



[Using Wi-Fi functions](#)



[Adding applications to the product](#)



[Viewing on computers](#)



[Precautions/This product](#)



Troubleshooting

[If you have problems](#)



[Troubleshooting](#)



[Messages](#)



[Situations this product has difficulty handling](#)



List of Topics

[How to Use](#)



[Troubleshooting](#)



4-543-698-11(1)

Copyright 2014 Sony Corporation

Table Of Contents

ILCE-5100 Help Guide.....	i
Before Use.....	1
Names of parts.....	28
Checking the camera and the supplied items.....	100
Identifying parts.....	102
Identifying parts Lens E PZ 16–50 mm F3.5–5.6 OSS (supplied with ILCE-5100L/ILCE-5100Y).....	105
Identifying parts Lens E 55-210 mm F4.5-6.3 OSS (supplied with ILCE- 5100Y).....	106
Icons and indicators.....	29
List of icons on the screen.....	107
List of focus range finder frames.....	112
Using the strap.....	30
Using the shoulder strap.....	114
In-Camera guide.....	31
About the [In-Camera Guide].....	115
About the shooting advice.....	116
Preparing the camera.....	2
Charging the battery pack.....	32
Charging the battery pack while it is inserted in the camera.....	117
Charging by connecting to a computer.....	119
Inserting the battery pack into the camera.....	120
Battery life and the number of images that can be recorded/played back using a battery pack.....	122
Supplying power using a wall outlet (wall socket).....	123
Removing the battery pack.....	124
Inserting a memory card (sold separately).....	33
Inserting a memory card.....	125
Removing the memory card.....	127
Attaching a lens.....	34
Attaching a lens.....	129
Removing the lens.....	131
Attaching the lens hood.....	132
Notes on changing the lens.....	133
Setting the date and time.....	134
Confirming the operation method.....	3
Confirming the operation method.....	36
Using the control wheel.....	135

Using the touch panel.....	136
Using MENU items.....	137
Shooting.....	4
Shooting still images/movies.....	37
Shooting still images.....	139
Shooting movies.....	141
Selecting a shooting mode.....	38
List of shooting modes.....	142
Intelligent Auto.....	144
Superior Auto.....	145
About Scene Recognition.....	146
The advantages of automatic shooting.....	147
Program Auto.....	148
Sweep Panorama.....	149
Scene Selection.....	151
Shutter Priority.....	154
Aperture Priority.....	155
Manual Exposure.....	156
BULB.....	157
Movie.....	158
Using shooting functions.....	5
Using the zoom.....	40
Using the flash.....	41
Selecting a screen display mode.....	42
Selecting still image size/image quality.....	43
Adjusting the focus.....	44
Adjusting the exposure.....	46
Selecting a drive mode (Continuous shooting/Self-timer).....	47
Taking pictures of yourself by monitoring the screen.....	48
Selecting the ISO sensitivity.....	49
Correcting the brightness or contrast.....	50
Adjusting color tones.....	51
Selecting an effect mode.....	52
Recording movies.....	53
Customizing the shooting functions for convenient use.....	54
Setting the other functions of this product.....	55
Shooting using the touch panel.....	57
Viewing.....	7
Viewing still images.....	58
Playing back images.....	273

Playback zoom.....	274
Image Index.....	275
Switching the screen display (during playback).....	276
Deleting images.....	59
Deleting a displayed image.....	277
Deleting multiple selected images.....	278
Playing back movies.....	60
Playing back movies.....	279
Viewing panoramic images.....	61
Playing back panoramic images.....	280
Printing.....	62
Specify Printing.....	281
Using viewing functions.....	63
View Mode.....	282
Display Rotation.....	283
Slide Show.....	284
Rotate.....	285
Protect.....	286
4K Still Image PB.....	287
Viewing images on a TV.....	64
Viewing images on an HD TV.....	288
Viewing images on a “BRAVIA” Sync-compatible TV	290
Changing settings.....	8
Setup menu.....	65
Using Wi-Fi functions.....	9
Connecting this product and a Smartphone.....	68
PlayMemories Mobile.....	320
Connecting an Android smartphone to this product.....	321
Connecting the product to an iPhone or iPad.....	322
Calling up an application using [One-touch(NFC)].....	324
Controlling this product using a Smartphone.....	69
Smart Remote Embedded.....	325
One-touch connection with an NFC-enabled Android smartphone (NFC One-touch remote).....	327
Transferring images to a Smartphone.....	70
Send to Smartphone.....	329
Sending images to an Android smartphone (NFC One-touch Sharing).....	331
Transferring images to a computer.....	71
Send to Computer.....	333
Transferring images to a TV.....	72

View on TV.....	334
Changing the settings of Wi-Fi functions.....	73
Airplane Mode.....	336
WPS Push.....	337
Access Point Set.....	338
Edit Device Name.....	340
Disp MAC Address.....	341
SSID/PW Reset.....	342
Reset Network Set.....	343
Adding applications to the product.....	10
PlayMemories Camera Apps.....	74
PlayMemories Camera Apps.....	344
Recommended computer environment.....	345
Installing the applications.....	75
Opening a service account.....	346
Downloading applications.....	347
Downloading applications directly to the product using the Wi-Fi function.....	348
Starting the applications.....	76
Launching the downloaded application.....	349
Managing the applications.....	77
Uninstalling applications.....	350
Changing the order of applications.....	351
Confirming the account information of PlayMemories Camera Apps.....	352
Viewing on computers.....	11
Recommended computer environment.....	78
Recommended computer environment.....	353
Using the software.....	79
PlayMemories Home.....	354
Installing PlayMemories Home.....	355
Software for Mac computers.....	356
“Image Data Converter”	357
Installing “Image Data Converter”	358
Accessing “Image Data Converter Guide”	359
“Remote Camera Control”	360
Installing “Remote Camera Control”	361
Accessing the Help of Remote Camera Control.....	362
Connecting this product and a computer.....	80
Connecting the product to a computer.....	363
Importing images to the computer.....	364
Disconnecting the product from the computer.....	365

Creating a movie disc.....	81
Disc type.....	366
Selecting the disc creation method.....	367
Creating a disc with a device other than a computer.....	368
Creating Blu-ray Discs.....	369
Precautions/This product.....	12
Precautions.....	82
Precautions.....	370
On the internal rechargeable battery.....	373
Notes on the battery pack.....	374
Charging the battery pack.....	376
Memory card.....	377
Cleaning this product.....	83
On cleaning.....	379
Cleaning the image sensor.....	380
Number of recordable still images and recordable time of movies.....	84
Number of still images.....	381
Recordable time of movies.....	383
Using this product abroad.....	85
Plug adaptor.....	386
On TV color systems.....	387
Other information.....	86
Mount Adaptor.....	388
LA-EA1 Mount Adaptor.....	389
LA-EA2 Mount Adaptor.....	390
LA-EA3 Mount Adaptor.....	391
LA-EA4 Mount Adaptor.....	392
AVCHD format.....	393
License.....	394
Trademarks.....	87
Trademarks.....	395
If you have problems.....	13
If you have problems.....	88
Troubleshooting.....	397
Troubleshooting.....	14
Battery pack and power.....	89
Shooting still images/movies.....	90
Viewing images.....	92
Wi-Fi.....	93
Computers.....	94

Memory cards.....	95
Printing.....	96
Others.....	97
Messages.....	15
Messages.....	98
Warning messages.....	454
Situations this product has difficulty handling.....	456
How to Use.....	17
Troubleshooting.....	25

Interchangeable Lens Digital Camera
ILCE-5100

Before Use

[Names of parts](#)



[Icons and indicators](#)



[Using the strap](#)



[In-Camera guide](#)



4-543-698-11(1)

Copyright 2014 Sony Corporation

Interchangeable Lens Digital Camera
ILCE-5100

Preparing the camera

[Charging the battery pack](#)



[Inserting a memory card \(sold separately\)](#)



[Attaching a lens](#)



[Setting the date and time](#)



4-543-698-11(1)

Copyright 2014 Sony Corporation

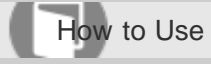

Interchangeable Lens Digital Camera
ILCE-5100

Confirming the operation method

[Confirming the operation method](#)



4-543-698-11(1)

Copyright 2014 Sony Corporation

Interchangeable Lens Digital Camera
ILCE-5100

Shooting

[Shooting still images/movies](#)



[Selecting a shooting mode](#)



4-543-698-11(1)

Copyright 2014 Sony Corporation

Interchangeable Lens Digital Camera
ILCE-5100

Using shooting functions

[Using the zoom](#)



[Using the flash](#)



[Selecting a screen display mode](#)



[Selecting still image size/image quality](#)



[Adjusting the focus](#)



[Adjusting the exposure](#)



[Selecting a drive mode \(Continuous shooting/Self-timer\)](#)



[Taking pictures of yourself by monitoring the screen](#)



[Selecting the ISO sensitivity](#)



[Correcting the brightness or contrast](#)



[Adjusting color tones](#)



[Selecting an effect mode](#)



[Recording movies](#)



[Customizing the shooting functions for convenient use](#)



Setting the other functions of this product



Shooting using the touch panel



4-543-698-11(1)

Copyright 2014 Sony Corporation

Interchangeable Lens Digital Camera
ILCE-5100

Viewing

[Viewing still images](#) >

[Deleting images](#) >

[Playing back movies](#) >

[Viewing panoramic images](#) >

[Printing](#) >

[Using viewing functions](#) >

[Viewing images on a TV](#) >

4-543-698-11(1)

Copyright 2014 Sony Corporation

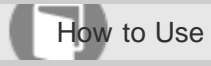

Interchangeable Lens Digital Camera
ILCE-5100

Changing settings

[Setup menu](#)



4-543-698-11(1)
Copyright 2014 Sony Corporation



Interchangeable Lens Digital Camera
ILCE-5100

Using Wi-Fi functions

[Connecting this product and a Smartphone](#)



[Controlling this product using a Smartphone](#)



[Transferring images to a Smartphone](#)



[Transferring images to a computer](#)



[Transferring images to a TV](#)



[Changing the settings of Wi-Fi functions](#)



4-543-698-11(1)

Copyright 2014 Sony Corporation

Interchangeable Lens Digital Camera
ILCE-5100

Adding applications to the product

[PlayMemories Camera Apps](#)



[Installing the applications](#)



[Starting the applications](#)



[Managing the applications](#)



4-543-698-11(1)

Copyright 2014 Sony Corporation

Interchangeable Lens Digital Camera
ILCE-5100

Viewing on computers

[Recommended computer environment](#)



[Using the software](#)



[Connecting this product and a computer](#)



[Creating a movie disc](#)



4-543-698-11(1)

Copyright 2014 Sony Corporation

Interchangeable Lens Digital Camera
ILCE-5100

Precautions/This product

[Precautions](#) 

[Cleaning this product](#) 

[Number of recordable still images and recordable time of movies](#) 

[Using this product abroad](#) 

[Other information](#) 

[Trademarks](#) 

4-543-698-11(1)

Copyright 2014 Sony Corporation



Interchangeable Lens Digital Camera
ILCE-5100

If you have problems

[If you have problems](#)



4-543-698-11(1)

Copyright 2014 Sony Corporation

Interchangeable Lens Digital Camera
ILCE-5100

Troubleshooting

[Battery pack and power](#)



[Shooting still images/movies](#)



[Viewing images](#)



[Wi-Fi](#)



[Computers](#)



[Memory cards](#)



[Printing](#)



[Others](#)



4-543-698-11(1)

Copyright 2014 Sony Corporation



Interchangeable Lens Digital Camera
ILCE-5100

Messages

[Messages](#)



4-543-698-11(1)

Copyright 2014 Sony Corporation

Interchangeable Lens Digital Camera
ILCE-5100

Situations this product has difficulty handling

[Situations this product has difficulty handling](#)



4-543-698-11(1)

Copyright 2014 Sony Corporation

Interchangeable Lens Digital Camera
ILCE-5100

How to Use

Before Use

Names of parts

- [Checking the camera and the supplied items](#)
- [Identifying parts](#)
- [Identifying parts Lens E PZ 16–50 mm F3.5–5.6 OSS \(supplied with ILCE-5100L/ILCE-5100Y\)](#)
- [Identifying parts Lens E 55-210 mm F4.5-6.3 OSS \(supplied with ILCE-5100Y\)](#)

Icons and indicators

- [List of icons on the screen](#)
- [List of focus range finder frames](#)

Using the strap

- [Using the shoulder strap](#)

In-Camera guide

- [About the \[In-Camera Guide\]](#)
- [About the shooting advice](#)

Preparing the camera

Charging the battery pack

- [Charging the battery pack while it is inserted in the camera](#)
- [Charging by connecting to a computer](#)
- [Inserting the battery pack into the camera](#)
- [Battery life and the number of images that can be recorded/played back using a battery pack](#)
- [Supplying power using a wall outlet \(wall socket\)](#)
- [Removing the battery pack](#)

Inserting a memory card (sold separately)

- [Inserting a memory card](#)
- [Removing the memory card](#)

Attaching a lens

- [Attaching a lens](#)
- [Removing the lens](#)
- [Attaching the lens hood](#)
- [Notes on changing the lens](#)

Setting the date and time

- [Setting the date and time](#)

Confirming the operation method

Confirming the operation method

- [Using the control wheel](#)
- [Using the touch panel](#)
- [Using MENU items](#)

Shooting

Shooting still images/movies

- [Shooting still images](#)
- [Shooting movies](#)

Selecting a shooting mode

- [List of shooting modes](#)
- [Intelligent Auto](#)
- [Superior Auto](#)
- [About Scene Recognition](#)
- [The advantages of automatic shooting](#)
- [Program Auto](#)
- [Sweep Panorama](#)
- [Scene Selection](#)
- [Shutter Priority](#)
- [Aperture Priority](#)
- [Manual Exposure](#)
- [BULB](#)
- [Movie](#)

Using shooting functions

Using the zoom

- [Zoom](#)
- [The zoom features available with this product](#)
- [Zoom Setting](#)
- [About zoom scale](#)

Using the flash

- [Using flash](#)
- [Flash Mode](#)
- [Flash Comp.](#)

Selecting a screen display mode

- [Switching the screen display \(Shooting\)](#)

Selecting still image size/image quality

- [Image Size \(still image\)](#)
- [Aspect Ratio \(still image\)](#)
- [Quality \(still image\)](#)
- [Panorama: Size](#)
- [Panorama: Direction](#)

Adjusting the focus

- [Focus Mode](#)
- [Focus Area](#)
- [Focal plane phase detection AF](#)
- [Center Lock-on AF](#)
- [Focus-lock](#)
- [Manual Focus](#)
- [Direct manual focus \(DMF\)](#)
- [MF Assist \(still image\)](#)
- [Focus Magnifier](#)
- [Focus Magnif. Time](#)
- [Peaking Level](#)
- [Peaking Color](#)
- [Pre-AF \(still image\)](#)
- [AF/MF control](#)
- [AF Illuminator \(still image\)](#)
- [AF Micro Adj.](#)
- [Disp. cont. AF area](#)
- [AF On](#)
- [Eye AF](#)
- [AF drive speed \(movie\)](#)
- [AF Track Duration \(movie\)](#)
- [Measuring the exact distance to the subject](#)

Adjusting the exposure

- [Exposure Comp.](#)
- [Metering Mode](#)
- [AE lock](#)
- [AEL w/ shutter \(still image\)](#)
- [Exp.comp.set](#)
- [Zebra](#)
- [Exposure Set. Guide](#)

Selecting a drive mode (Continuous shooting/Self-timer)

- [Drive Mode](#)
- [Cont. Shooting](#)
- [Self-timer](#)
- [Self-timer\(Cont\)](#)
- [Cont. Bracket](#)

- [Single Bracket](#)
- [WB bracket](#)
- [DRO Bracket](#)

Taking pictures of yourself by monitoring the screen

- [Self-portrait/ -timer](#)

Selecting the ISO sensitivity

- [ISO](#)

Correcting the brightness or contrast

- [D-Range Opt. \(DRO\)](#)
- [Auto HDR](#)

Adjusting color tones

- [White Balance](#)
- [Capturing a basic white color in \[Custom Setup\] mode](#)

Selecting an effect mode

- [Picture Effect](#)
- [Creative Style](#)

Recording movies

- [Movie recording formats](#)
- [File Format \(movie\)](#)
- [Record Setting \(movie\)](#)
- [Dual Video REC](#)
- [Marker Display](#)
- [Marker Settings](#)
- [Audio Recording](#)
- [Wind Noise Reduct.](#)
- [Auto Slow Shut. \(movie\)](#)
- [MOVIE Button](#)

Customizing the shooting functions for convenient use

- [Custom Key Settings](#)
- [Function of the center button](#)
- [Function of the left button](#)
- [Function of the right button](#)
- [Function of the down button](#)
- [Function of the ? button](#)

Setting the other functions of this product

- [Photo Creativity](#)
- [Smile/Face Detect.](#)
- [Soft Skin Effect \(still image\)](#)
- [Face Registration \(New Registration\)](#)
- [Face Registration \(Order Exchanging\)](#)
- [Face Registration \(Delete\)](#)

- [Red Eye Reduction](#)
- [Auto Obj. Framing \(still image\)](#)
- [SteadyShot](#)
- [High ISO NR \(still image\)](#)
- [Color Space \(still image\)](#)
- [Grid Line](#)
- [Auto Review](#)
- [Live View Display](#)
- [Release w/o Lens](#)
- [S. Auto Img. Extract.](#)
- [Shading Comp.](#)
- [Chro. Aber. Comp.](#)
- [Distortion Comp.](#)
- [Aperture Preview](#)
- [Shot. Result Preview](#)

Shooting using the touch panel

- [Shooting still images using touch operation \(Touch Shutter\)](#)
- [Taking pictures of yourself using touch operation \(Self-portrait/ -timer\)](#)
- [Adjusting the focus using touch operation \(Touch Focus\) \(still image\)](#)
- [Adjusting the focus using touch operation \(Touch Focus\) \(movie\)](#)

Viewing

Viewing still images

- [Playing back images](#)
- [Playback zoom](#)
- [Image Index](#)
- [Switching the screen display \(during playback\)](#)

Deleting images

- [Deleting a displayed image](#)
- [Deleting multiple selected images](#)

Playing back movies

- [Playing back movies](#)

Viewing panoramic images

- [Playing back panoramic images](#)

Printing

- [Specify Printing](#)

Using viewing functions

- [View Mode](#)
- [Display Rotation](#)
- [Slide Show](#)
- [Rotate](#)

- [Protect](#)
- [4K Still Image PB](#)

Viewing images on a TV

- [Viewing images on an HD TV](#)
- [Viewing images on a “BRAVIA” Sync-compatible TV](#)

Changing settings

Setup menu

- [Monitor Brightness](#)
- [Volume Settings](#)
- [Audio signals](#)
- [Upload Settings\(Eye-Fi\)](#)
- [Tile Menu](#)
- [Delete confirm.](#)
- [Pwr Save Start Time](#)
- [PAL/NTSC Selector](#)
- [Demo Mode](#)
- [HDMI Resolution](#)
- [CTRL FOR HDMI](#)
- [HDMI Info. Display](#)
- [USB Connection](#)
- [USB LUN Setting](#)
- [Language](#)
- [Date/Time Setup](#)
- [Area Setting](#)
- [Format](#)
- [File Number](#)
- [Select REC Folder](#)
- [New Folder](#)
- [Folder Name](#)
- [Recover Image DB](#)
- [Display Media Info.](#)
- [Version](#)
- [Certification Logo \(Overseas model only\)](#)
- [Setting Reset](#)

Using Wi-Fi functions

Connecting this product and a Smartphone

- [PlayMemories Mobile](#)
- [Connecting an Android smartphone to this product](#)
- [Connecting the product to an iPhone or iPad](#)
- [Calling up an application using \[One-touch\(NFC\)\]](#)

Controlling this product using a Smartphone

- [Smart Remote Embedded](#)
- [One-touch connection with an NFC-enabled Android smartphone \(NFC One-touch remote\)](#)

Transferring images to a Smartphone

- [Send to Smartphone](#)
- [Sending images to an Android smartphone \(NFC One-touch Sharing\)](#)

Transferring images to a computer

- [Send to Computer](#)

Transferring images to a TV

- [View on TV](#)

Changing the settings of Wi-Fi functions

- [Airplane Mode](#)
- [WPS Push](#)
- [Access Point Set.](#)
- [Edit Device Name](#)
- [Disp MAC Address](#)
- [SSID/PW Reset](#)
- [Reset Network Set.](#)

Adding applications to the product

PlayMemories Camera Apps

- [PlayMemories Camera Apps](#)
- [Recommended computer environment](#)

Installing the applications

- [Opening a service account](#)
- [Downloading applications](#)
- [Downloading applications directly to the product using the Wi-Fi function](#)

Starting the applications

- [Launching the downloaded application](#)

Managing the applications

- [Uninstalling applications](#)
- [Changing the order of applications](#)
- [Confirming the account information of PlayMemories Camera Apps](#)

Viewing on computers

Recommended computer environment

- [Recommended computer environment](#)

Using the software

- [PlayMemories Home](#)
- [Installing PlayMemories Home](#)
- [Software for Mac computers](#)

- [“Image Data Converter”](#)
- [Installing “Image Data Converter”](#)
- [Accessing “Image Data Converter Guide”](#)
- [“Remote Camera Control”](#)
- [Installing “Remote Camera Control”](#)
- [Accessing the Help of Remote Camera Control](#)

Connecting this product and a computer

- [Connecting the product to a computer](#)
- [Importing images to the computer](#)
- [Disconnecting the product from the computer](#)

Creating a movie disc

- [Disc type](#)
- [Selecting the disc creation method](#)
- [Creating a disc with a device other than a computer](#)
- [Creating Blu-ray Discs](#)

Precautions/This product

Precautions

- [Precautions](#)
- [On the internal rechargeable battery](#)
- [Notes on the battery pack](#)
- [Charging the battery pack](#)
- [Memory card](#)

Cleaning this product

- [On cleaning](#)
- [Cleaning the image sensor](#)

Number of recordable still images and recordable time of movies

- [Number of still images](#)
- [Recordable time of movies](#)

Using this product abroad

- [Plug adaptor](#)
- [On TV color systems](#)

Other information

- [Mount Adaptor](#)
- [LA-EA1 Mount Adaptor](#)
- [LA-EA2 Mount Adaptor](#)
- [LA-EA3 Mount Adaptor](#)
- [LA-EA4 Mount Adaptor](#)
- [AVCHD format](#)
- [License](#)

Trademarks

Interchangeable Lens Digital Camera
ILCE-5100

Troubleshooting

If you have problems

If you have problems

- [Troubleshooting](#)

Troubleshooting

Battery pack and power

- [You cannot insert the battery pack into the product.](#)
- [You cannot turn on the product.](#)
- [The power turns off suddenly.](#)
- [The product gets hot.](#)
- [The remaining battery level indicator shows an incorrect level.](#)
- [The charge lamp on the product flashes when charging the battery pack.](#)
- [The battery pack inserted in the camera is not charging.](#)
- [The battery pack is not charged.](#)

Shooting still images/movies

- [You cannot record images.](#)
- [Recording takes a long time.](#)
- [The image is out of focus.](#)
- [Zoom does not work.](#)
- [The flash does not work.](#)
- [Fuzzy white circular spots appear on images shot using the flash.](#)
- [The recording date and time are not displayed on the screen.](#)
- [The date and time are recorded incorrectly.](#)
- [The aperture value and/or shutter speed flashes.](#)
- [The image colors are not correct.](#)
- [Noise appears in the image when you view the screen in a dark place.](#)
- [The eyes of the subject come out red.](#)
- [Dots appear and remain on the screen.](#)
- [You cannot shoot images continuously.](#)
- [The image is whitish \(Flare\)/Blurring of light appears on the image \(Ghosting\).](#)
- [The corners of the picture are too dark.](#)
- [The image is blurred.](#)

- The LCD screen darkens after a short period of time passed.
- The flash takes too long to recharge.

Viewing images

- Images cannot be played back.
- The date and time are not displayed.
- The image cannot be deleted.
- The image was deleted by mistake.
- A DPOF mark cannot be put.

Wi-Fi

- You cannot find the wireless access point to be connected.
- [WPS Push] does not work.
- [Send to Computer] is canceled halfway.
- You cannot send movies to a smartphone.
- [Smart Remote Embedded] or [Send to Smartphone] is canceled halfway.
- The shooting screen for [Smart Remote Embedded] is not displayed smoothly./The connection between this product and the smartphone is disconnected.
- You cannot use One-Touch connection (NFC).

Computers

- The computer does not recognize this product.
- You cannot import images.
- The image and sound are interrupted by noise when viewing a movie on a computer.
- Images exported from a computer cannot be viewed on this product.

Memory cards

- Formatted the memory card by mistake.

Printing

- You cannot print images.
- The color of the image is strange.
- Images are printed with both edges cut off.
- You cannot print images with the date.

Others

- The lens gets fogged.
- The product becomes warm when you use it for a long time.
- The Clock Set screen appears when you turn on the product.
- The number of recordable images does not decrease, or decreases two images at a time.
- The product does not work properly.
- "--E-" appears on the screen.
- The buttons on the touch panel do not work correctly or do not work at all.
- You cannot perform touch operations.

Messages

Messages

- [Warning messages](#)

Situations this product has difficulty handling

Situations this product has difficulty handling

- [Situations this product has difficulty handling](#)

4-543-698-11(1)

Copyright 2014 Sony Corporation

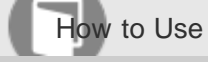

How to Use

Interchangeable Lens Digital Camera
ILCE-5100

Names of parts

[Checking the camera and the supplied items](#)



[Identifying parts](#)



[Identifying parts Lens E PZ 16–50 mm F3.5–5.6 OSS \(supplied with ILCE-5100L/ILCE-5100Y\)](#)



[Identifying parts Lens E 55-210 mm F4.5-6.3 OSS \(supplied with ILCE-5100Y\)](#)



4-543-698-11(1)

Copyright 2014 Sony Corporation

Interchangeable Lens Digital Camera
ILCE-5100

Icons and indicators

[List of icons on the screen](#)



[List of focus range finder frames](#)



4-543-698-11(1)

Copyright 2014 Sony Corporation

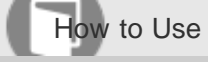

Interchangeable Lens Digital Camera
ILCE-5100

Using the strap

[Using the shoulder strap](#)

Attach the shoulder strap to prevent damage caused by dropping the product.



4-543-698-11(1)

Copyright 2014 Sony Corporation

Interchangeable Lens Digital Camera
ILCE-5100

In-Camera guide

[About the \[In-Camera Guide\]](#)

The [In-Camera Guide] displays descriptions of MENU items and settings, and if a function cannot be set, the reason why. 

[About the shooting advice](#)

Displays the shooting advice according to the selected shooting mode. 

4-543-698-11(1)

Copyright 2014 Sony Corporation



Interchangeable Lens Digital Camera
ILCE-5100

Charging the battery pack

[Charging the battery pack while it is inserted in the camera](#)

When using the camera for the first time, be sure to charge the battery pack.

[Charging by connecting to a computer](#)

The battery pack can be charged by connecting the camera to a computer using a micro USB cable.

[Inserting the battery pack into the camera](#)

How to insert the battery pack into the camera

[Battery life and the number of images that can be recorded/played back using a battery pack](#)

[Supplying power using a wall outlet \(wall socket\)](#)

Power can be supplied to the camera during shooting/playback using an AC adaptor AC-PW20 (sold separately).

[Removing the battery pack](#)

How to remove the battery pack

4-543-698-11(1)

Copyright 2014 Sony Corporation

Interchangeable Lens Digital Camera
ILCE-5100

Inserting a memory card (sold separately)

[Inserting a memory card](#)

How to insert a memory card



[Removing the memory card](#)

How to remove the memory card



4-543-698-11(1)

Copyright 2014 Sony Corporation

Interchangeable Lens Digital Camera
ILCE-5100

Attaching a lens

[Attaching a lens](#)

Set the power switch of the camera to OFF before attaching the lens.

[Removing the lens](#)

Set the power switch of the camera to OFF before you remove the lens.

[Attaching the lens hood](#)

We recommend that you use the lens hood to prevent light outside the shooting frame from affecting the image.

[Notes on changing the lens](#)

4-543-698-11(1)

Copyright 2014 Sony Corporation

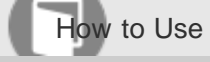

Interchangeable Lens Digital Camera
ILCE-5100

Setting the date and time

Setting the date and time

When you turn on the camera for the first time or after you have initialized the functions, the setting screen for the date and time appears. 

4-543-698-11(1)

Copyright 2014 Sony Corporation



Interchangeable Lens Digital Camera
ILCE-5100

Confirming the operation method

[Using the control wheel](#)



[Using the touch panel](#)

This product is equipped with a touch panel. By touching the monitor, you can shoot still images (Touch Shutter) or bring the subject into focus (Touch Focus). You can also use the [Touch Shutter] function with [Self-portrait/ -timer] shooting.



[Using MENU items](#)

In this section, you learn how to change settings related to all camera operations and execute camera functions including shooting, playback, and operation methods.



4-543-698-11(1)

Copyright 2014 Sony Corporation



Interchangeable Lens Digital Camera
ILCE-5100

Shooting still images/movies

Shooting still images

Shoots still images.



Shooting movies

You can record movies by pressing the MOVIE button.



4-543-698-11(1)

Copyright 2014 Sony Corporation



Interchangeable Lens Digital Camera
ILCE-5100

Selecting a shooting mode

[List of shooting modes](#)

You can select a desired shooting mode.

[Intelligent Auto](#)

The product analyzes the subject, and allows you to shoot with appropriate settings.

[Superior Auto](#)

The product automatically recognizes and evaluates the shooting conditions, and the appropriate settings are set automatically.

[About Scene Recognition](#)

Scene Recognition operates in [Intelligent Auto] mode and [Superior Auto] mode.

[The advantages of automatic shooting](#)

[Program Auto](#)

Allows you to shoot with the exposure adjusted automatically (both the shutter speed and the aperture value).

[Sweep Panorama](#)

Allows you to create a single panoramic image from multiple images shot while panning the camera.

[Scene Selection](#)

Allows you to shoot with preset settings according to the scene.

[Shutter Priority](#)

You can express the movement of a moving subject in various ways by adjusting the shutter speed, for example, at the instant of the movement with high speed shutter, or as a trailing image with low speed shutter.

[Aperture Priority](#)

You can shoot by adjusting the aperture and changing the range in focus, or by defocusing the background.

Manual Exposure

You can shoot with the desired exposure setting by adjusting both the shutter speed and aperture.



BULB

You can shoot a trailing image of the movement of a subject with long exposure.



Movie

You can adjust the shutter speed or aperture value to your desired settings for recording movies.



4-543-698-11(1)

Copyright 2014 Sony Corporation



Interchangeable Lens Digital Camera
ILCE-5100

Using the zoom

[Zoom](#)

Enlarge images using the W/T (zoom) lever when shooting.

[The zoom features available with this product](#)

The zoom feature of the product provides a higher magnification zoom by combining various zoom features.

[Zoom Setting](#)

You can select the zoom setting of the product.

[About zoom scale](#)

The zoom scale that is used in combination with the zoom of the lens changes according to the selected image size.

4-543-698-11(1)

Copyright 2014 Sony Corporation

Interchangeable Lens Digital Camera
ILCE-5100

Using the flash

Using flash

In dark environments, use the flash to light up the subject while shooting and to prevent camera-shake. When shooting against the sun, use the flash to lighten the image of the backlit subject. 

Flash Mode

You can set the flash mode. 

Flash Comp.

Adjusts the amount of flash light in a range of -2.0 EV to $+2.0$ EV. 

4-543-698-11(1)

Copyright 2014 Sony Corporation

Interchangeable Lens Digital Camera
ILCE-5100

Selecting a screen display mode

[Switching the screen display \(Shooting\)](#)

You can change the display contents on the screen.



4-543-698-11(1)

Copyright 2014 Sony Corporation



Interchangeable Lens Digital Camera
ILCE-5100

Selecting still image size/image quality

[Image Size \(still image\)](#)

The larger the image size, the more detail will be reproduced when the image is printed on large-format paper. The smaller the image size, the more images can be recorded. 

[Aspect Ratio \(still image\)](#)

Sets the aspect ratio of still images. 

[Quality \(still image\)](#)

Selects the compression format of still images. 

[Panorama: Size](#)

Sets the image size when shooting panoramic images. 

[Panorama: Direction](#)

Sets the direction to pan the camera when shooting panoramic images. 

Interchangeable Lens Digital Camera
ILCE-5100

Adjusting the focus

Focus Mode

Selects the focus method to suit the movement of the subject.

Focus Area

Selects the focusing area. Use this function when it is difficult to get the proper focus in auto focus mode.

Focal plane phase detection AF

When there are focal plane phase detection AF points within the auto focus area, the product uses the combined autofocus of the focal plane phase detection AF and contrast AF.

Center Lock-on AF

When you press the center button, the camera detects the subject positioned in the center of the screen and continues to track the subject.

Focus-lock

Shoots images with the focus locked on the desired subject in auto focus mode.

Manual Focus

When it is difficult to get the proper focus in autofocus mode, you can adjust the focus manually.

Direct manual focus (DMF)

You can make fine adjustments manually after the focus is locked.

MF Assist (still image)

Enlarges the image on the screen automatically to make manual focusing easier. This works in Manual Focus or Direct Manual Focus shooting.

Focus Magnifier

You can check the focus by enlarging the image before shooting.

Focus Magnif. Time

Set the duration for which an image is to be magnified using the [MF Assist] or [Focus Magnifier] function.

Peaking Level

Enhances the outline of in-focus ranges using a specific color in Manual Focus or Direct Manual Focus shooting.

Peaking Color

Sets the color used for the peaking function in Manual Focus or Direct Manual Focus shooting.

Pre-AF (still image)

The product automatically adjusts focus before you press the shutter button halfway down.

AF/MF control

You can easily switch the focusing mode from auto to manual and vice versa while shooting without changing your holding position.

AF Illuminator (still image)

The AF illuminator supplies fill light to focus more easily on a subject in dark surroundings. The red AF illuminator allows the product to focus easily when the shutter button is pressed halfway, until the focus is locked.

AF Micro Adj.

Allows you to adjust and register an autofocused position for each lens, when using an A-mount lens with the Mount Adaptor LA-EA2 or LA-EA4 (sold separately).

Disp. cont. AF area

You can set whether or not to display the focus area that is in focus when [Focus Area] is set to [Wide] or [Zone] and [Focus Mode] is set to [Continuous AF].

AF On

You can focus using any button instead of pressing the shutter button halfway down.

Eye AF

The camera focuses on the subject's eyes while you keep the button pressed.

AF drive speed (movie)

You can switch focusing speed when using autofocus in movie mode.

AF Track Duration (movie)

You can set the duration for AF tracking in movie mode.

Measuring the exact distance to the subject



Interchangeable Lens Digital Camera
ILCE-5100

Adjusting the exposure

[Exposure Comp.](#)

Based on the exposure value set by auto exposure, you can make the entire image brighter or darker if you adjust [Exposure Comp.] to the plus side or minus side, respectively (exposure compensation). 

[Metering Mode](#)

Selects the metering mode that sets which part of the screen to measure for determining the exposure. 

[AE lock](#)

When the contrast between the subject and background is high, such as when shooting a backlit subject or a subject near a window, meter the light at a spot where the subject appears to have the appropriate brightness and lock the exposure before shooting. 

[AEL w/ shutter \(still image\)](#)

Sets whether to fix the exposure when you press the shutter button halfway down. 

[Exp.comp.set](#)

Sets whether to apply the exposure compensation value to control both flash light and ambient light, or just ambient light. 

[Zebra](#)

The zebra pattern will appear over the part of an image if the brightness level exceeds the IRE that you set. 

[Exposure Set. Guide](#)

You can set whether to display a guide when you change the exposure. 

Interchangeable Lens Digital Camera
ILCE-5100

Selecting a drive mode (Continuous shooting/Self-timer)

Drive Mode

You can set the drive mode, such as continuous or self-timer shooting.

Cont. Shooting

Shoots images continuously while you press and hold down the shutter button.

Self-timer

The product shoots an image using the self-timer with a 10-second or 2-second delay.

Self-timer(Cont)

Continuously shoots the number of images you have set after 10 seconds.

Cont. Bracket

Shoots multiple images while automatically shifting the exposure from base to darker and then to lighter. Press and hold down the shutter button until the bracket recording is completed.

Single Bracket

Shoots multiple images while automatically shifting the exposure from base to darker and then to lighter. Press the shutter button for each image.

WB bracket

Shoots three images, each with different color tones according to the selected settings of white balance, color temperature and color filter.

DRO Bracket

You can record a total of three images, each at a different degree of D-Range Optimizer value.

Interchangeable Lens Digital Camera
ILCE-5100

Taking pictures of yourself by monitoring the screen

[Self-portrait/ -timer](#)

You can change the angle of the LCD screen and shoot images while monitoring the image on the screen.



4-543-698-11(1)

Copyright 2014 Sony Corporation

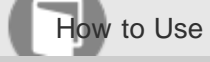

Interchangeable Lens Digital Camera
ILCE-5100

Selecting the ISO sensitivity

ISO

Sensitivity to light is expressed by the ISO number (recommended exposure index).



4-543-698-11(1)

Copyright 2014 Sony Corporation

Interchangeable Lens Digital Camera
ILCE-5100

Correcting the brightness or contrast

D-Range Opt. (DRO)

By dividing the image into small areas, the product analyzes the contrast of light and shadow between the subject and the background, and creates an image with the optimal brightness and gradation. 

Auto HDR

Widens the range (gradation) so that you can record from bright parts to dark parts with correct brightness (HDR: High Dynamic Range). 

4-543-698-11(1)

Copyright 2014 Sony Corporation



Interchangeable Lens Digital Camera
ILCE-5100

Adjusting color tones

White Balance

Adjusts the color tones according to the ambient light conditions.

Capturing a basic white color in [Custom Setup] mode

In a scene where the ambient light consists of multiple types of light sources, it is recommended to use the custom white balance in order to accurately reproduce the whiteness.

4-543-698-11(1)

Copyright 2014 Sony Corporation

Interchangeable Lens Digital Camera
ILCE-5100

Selecting an effect mode

Picture Effect

Select the desired effect filter to achieve more impressive and artistic images.

Creative Style

Allows you to select the desired image processing. You can adjust exposure (shutter speed and aperture) as you like with [Creative Style], unlike with [Scene Selection] where the product adjusts the exposure.

4-543-698-11(1)

Copyright 2014 Sony Corporation



Interchangeable Lens Digital Camera
ILCE-5100

Recording movies

[Movie recording formats](#)

You can use the movie recording format "XAVC S" with this camera.

[File Format \(movie\)](#)

Selects the movie file format.

[Record Setting \(movie\)](#)

Selects the image size, frame rate, and image quality for movie recording.

[Dual Video REC](#)

Allows you to simultaneously record an XAVC S movie and an MP4 movie, or an AVCHD movie and an MP4 movie.

[Marker Display](#)

Sets whether or not to display markers to enable alignment to a structure while shooting movies.

[Marker Settings](#)

Sets the markers to be displayed while shooting movies.

[Audio Recording](#)

Sets whether to record sounds when shooting movies.

[Wind Noise Reduct.](#)

Sets whether or not to reduce wind noise during movie recording.

[Auto Slow Shut. \(movie\)](#)

Sets whether or not to adjust the shutter speed automatically when recording movies if the subject is dark.

[MOVIE Button](#)

Sets whether or not to activate the MOVIE button.



Interchangeable Lens Digital Camera
ILCE-5100

Customizing the shooting functions for convenient use

Custom Key Settings

Assigning functions to the various keys allows you to speed up operations by pressing the appropriate key when the shooting information screen is displayed.

Function of the center button

Once you assign a function to the center button, you can perform that function by simply pressing the center button when the shooting information screen is displayed.

Function of the left button

Once you assign a function to the left button, you can perform that function by simply pressing the left button when the shooting information screen is displayed.

Function of the right button

Once you assign a function to the right button, you can perform that function by simply pressing the right button when the shooting information screen is displayed.

Function of the down button

Once you assign a function to the down button, you can perform that function by simply pressing the down button when the shooting information screen is displayed.

Function of the ? button

Once you assign a function to the ? (question mark) button, you can perform that function by simply pressing the ? (question mark) button when the shooting information screen is displayed.

Interchangeable Lens Digital Camera
ILCE-5100

Setting the other functions of this product

[Photo Creativity](#)

[Photo Creativity] is a mode that allows you to operate the camera intuitively with a different screen display.

[Smile/Face Detect.](#)

Detects the faces of your subjects and adjusts the focus, exposure, flash settings and performs image processing automatically.

[Soft Skin Effect \(still image\)](#)

Sets the effect used for shooting the skin smoothly in the Face Detection function.

[Face Registration \(New Registration\)](#)

If you register faces in advance, the product can detect the registered face as a priority when [Smile/Face Detect.] is set to [On (Regist. Faces)].

[Face Registration \(Order Exchanging\)](#)

When multiple faces are registered to be given priority, the face registered first will be given priority. You can change the priority order.

[Face Registration \(Delete\)](#)

Deletes a registered face.

[Red Eye Reduction](#)

When using the flash, it is fired two or more times before shooting to reduce the red-eye phenomenon.

[Auto Obj. Framing \(still image\)](#)

When this product detects and shoots faces, macro shooting subjects or subjects that are tracked by [Lock-on AF], the product automatically trims the image into an appropriate composition, and then saves it.

[SteadyShot](#)

Sets whether or not to use the SteadyShot function.

High ISO NR (still image)

When shooting with high ISO sensitivity, the product reduces noise that becomes more noticeable when the product sensitivity is high.

Color Space (still image)

The way colors are represented using combinations of numbers or the range of color reproduction is called "color space." You can change the color space depending on the purpose of the image.

Grid Line

Sets whether the grid line is displayed or not. The grid line will help you to adjust the composition of images.

Auto Review

You can check the recorded image on the screen right after the shooting.

Live View Display

Sets whether or not to show images altered with effects of the exposure compensation, white balance, [Creative Style], or [Picture Effect] on the screen.

Release w/o Lens

Sets whether or not the shutter can be released when no lens is attached.

S. Auto Img. Extract.

Sets whether or not to save all the images that were shot continuously in [Superior Auto].

Shading Comp.

Compensates for the shaded corners of the screen, caused by certain lens characteristics.

Chro. Aber. Comp.

Reduces the color deviation at the corners of the screen, caused by certain lens characteristics.

Distortion Comp.

Compensates for the distortion of the screen, caused by certain lens characteristics.

Aperture Preview

With the monitor, you may see an image with an aperture that differs from the shooting result.

Shot. Result Preview

With the monitor, you may see an image with an aperture that differs from the shooting result.

Interchangeable Lens Digital Camera
ILCE-5100

Shooting using the touch panel

[Shooting still images using touch operation \(Touch Shutter\)](#)

The product automatically focuses on the point you touch and takes a still picture.

[Taking pictures of yourself using touch operation \(Self-portrait/ -timer\)](#)

You can change the angle of the monitor and shoot a self-portrait while watching the monitor.

[Adjusting the focus using touch operation \(Touch Focus\) \(still image\)](#)

The product automatically focuses on the subject you touch on the monitor when shooting still images.

[Adjusting the focus using touch operation \(Touch Focus\) \(movie\)](#)

The product automatically focuses on the subject you touch on the monitor when shooting movies.

Interchangeable Lens Digital Camera
ILCE-5100

Viewing still images

[Playing back images](#)

Plays back the recorded images.



[Playback zoom](#)

Enlarges the image being played back.



[Image Index](#)

You can display multiple images at the same time in playback mode.



[Switching the screen display \(during playback\)](#)

Switches the screen display.



4-543-698-11(1)

Copyright 2014 Sony Corporation

Interchangeable Lens Digital Camera
ILCE-5100

Deleting images

[Deleting a displayed image](#)

You can delete an image displayed.



[Deleting multiple selected images](#)

You can delete multiple selected images.



4-543-698-11(1)

Copyright 2014 Sony Corporation

Interchangeable Lens Digital Camera
ILCE-5100

Playing back movies

[Playing back movies](#)

Plays back the recorded movies.



4-543-698-11(1)

Copyright 2014 Sony Corporation

Interchangeable Lens Digital Camera
ILCE-5100

Viewing panoramic images

[Playing back panoramic images](#)

The product automatically scrolls a panoramic image from end to end.



4-543-698-11(1)

Copyright 2014 Sony Corporation

Interchangeable Lens Digital Camera
ILCE-5100

Printing

[Specify Printing](#)

You can specify in advance on the memory card which still images you want to print out later.



4-543-698-11(1)

Copyright 2014 Sony Corporation



Interchangeable Lens Digital Camera
ILCE-5100

Using viewing functions

[View Mode](#)

Sets the View Mode (image display method).

[Display Rotation](#)

Selects the orientation when playing back recorded still images.

[Slide Show](#)

Automatically plays back images continuously.

[Rotate](#)

Rotates a recorded still image counter-clockwise.

[Protect](#)

Protects recorded images against accidental erasure.

[4K Still Image PB](#)

Outputs still images in 4K resolution to an HDMI-connected TV that supports 4K.

4-543-698-11(1)

Copyright 2014 Sony Corporation



Interchangeable Lens Digital Camera
ILCE-5100

Viewing images on a TV

[Viewing images on an HD TV](#)

To view images stored on this product using a TV, an HDMI cable (sold separately) and an HD TV equipped with an HDMI jack are required. 

[Viewing images on a "BRAVIA" Sync-compatible TV](#)

By connecting this product to a TV that supports "BRAVIA" Sync using an HDMI cable (sold separately), you can operate this product with the TV Remote Control. 

4-543-698-11(1)

Copyright 2014 Sony Corporation

Interchangeable Lens Digital Camera
ILCE-5100

Setup menu

Monitor Brightness

You can adjust the brightness of the screen.

Volume Settings

Adjusts the sound volume.

Audio signals

Selects whether the product produces a sound or not.

Upload Settings(Eye-Fi)

Sets whether to use the upload function when using an Eye-Fi card (commercially available).

Tile Menu

Selects whether to always display the first screen of the menu when you press the MENU button.

Delete confirm.

You can set whether [Delete] or [Cancel] is selected as the default setting on the delete confirmation screen.

Pwr Save Start Time

You can set time intervals to automatically switch to power save mode.

PAL/NTSC Selector

Plays back movies recorded with the product on a PAL/NTSC system TV.

Demo Mode

The [Demo Mode] function displays the movies recorded on the memory card automatically (demonstration), when the camera has not been operated for a certain time.

HDMI Resolution

When you connect the product to a High Definition (HD) TV with HDMI terminals using an HDMI cable (sold separately), you can select HDMI Resolution to output images to the TV.

CTRL FOR HDMI

When connecting this product to a “BRAVIA” Sync-compatible TV using an HDMI cable (sold separately), you can operate this product by aiming the TV remote control at the TV. >

HDMI Info. Display

Selects whether to display the shooting information when this product and the TV are connected using an HDMI cable (sold separately). >

USB Connection

Selects the appropriate USB connection method for each computer or USB device connected to this product. >

USB LUN Setting

Enhances compatibility by limiting of USB connection functions. >

Language

Selects the language to be used in the menu items, warnings and messages. >

Date/Time Setup

Sets the date and time again. >

Area Setting

Sets the area where you are using the product. >

Format

Formats (initializes) the memory card. >

File Number

Selects how to assign file numbers to recorded still images and MP4 movies. >

Select REC Folder

You can change the folder on the memory card where still images and MP4 movies are to be recorded. >

New Folder

Creates a new folder on the memory card for recording still images and MP4 movies. >

Folder Name

Still images you shoot are recorded in a folder that is automatically created under the DCIM folder on the memory card. You can change the way folder names are assigned. >

Recover Image DB

If image files were processed on a computer, problems may occur in the image database file. In such cases, the images on the memory card will not be played back on this product. If these problems happen, repair the file using [Recover Image DB].

Display Media Info.

Displays the recordable time of movies and the number of recordable still images for the inserted memory card.

Version

Displays the software version of this product, lens and Mount Adaptor.

Certification Logo (Overseas model only)

Displays some of the certification logos for this product.

Setting Reset

Resets the product to the default settings.

4-543-698-11(1)

Copyright 2014 Sony Corporation



Interchangeable Lens Digital Camera
ILCE-5100

Connecting this product and a Smartphone

[PlayMemories Mobile](#)

To use [Smart Remote Embedded] or [Send to Smartphone], etc., the application PlayMemories Mobile should be installed on your smartphone. 

[Connecting an Android smartphone to this product](#)



[Connecting the product to an iPhone or iPad](#)



[Calling up an application using \[One-touch\(NFC\)\]](#)

You can call up a desired application from the application menu of this product by touching an NFC-enabled Android smartphone to the product. 

4-543-698-11(1)

Copyright 2014 Sony Corporation

Interchangeable Lens Digital Camera
ILCE-5100

Controlling this product using a Smartphone

[Smart Remote Embedded](#)

You can use a smartphone as the remote controller for this product, and shoot still images/movies.

[One-touch connection with an NFC-enabled Android smartphone \(NFC One-touch remote\)](#)

You can connect this product and an NFC-enabled Android smartphone with one touch, without performing a complex setup operation.

4-543-698-11(1)

Copyright 2014 Sony Corporation

Interchangeable Lens Digital Camera
ILCE-5100

Transferring images to a Smartphone

[Send to Smartphone](#)

You can transfer still images to a smartphone and view them.

[Sending images to an Android smartphone \(NFC One-touch Sharing\)](#)

With just one touch, you can connect this product and an NFC-enabled Android smartphone, and send an image displayed on the product screen directly to the smartphone.

4-543-698-11(1)

Copyright 2014 Sony Corporation

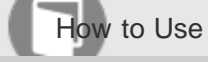

Interchangeable Lens Digital Camera
ILCE-5100

Transferring images to a computer

[Send to Computer](#)

You can transfer images stored in the product to a computer connected to a wireless access point or wireless broadband router and easily make backup copies using this operation. 

4-543-698-11(1)

Copyright 2014 Sony Corporation



Interchangeable Lens Digital Camera
ILCE-5100

Transferring images to a TV

[View on TV](#)

You can view images on a network-enabled TV by transferring them from the product without connecting the product and TV with a cable. 

4-543-698-11(1)

Copyright 2014 Sony Corporation



Interchangeable Lens Digital Camera
ILCE-5100

Changing the settings of Wi-Fi functions

[Airplane Mode](#)

When you board an airplane, etc., you can turn off all Wi-Fi functions temporarily. 

[WPS Push](#)

If your access point has the WPS button, you can register the access point to this product easily by pushing the WPS button. 

[Access Point Set.](#)

You can register your access point manually. 

[Edit Device Name](#)

You can change the device name under Wi-Fi Direct. 

[Disp MAC Address](#)

Displays the MAC address of this product. 

[SSID/PW Reset](#)

This product shares the connection information for [Send to Smartphone] and [Smart Remote Embedded] with a device that has permission to connect. If you want to change the device that is permitted to connect, reset the connection information. 

[Reset Network Set.](#)

Resets all the network settings to default settings. 

Interchangeable Lens Digital Camera
ILCE-5100

PlayMemories Camera Apps

[PlayMemories Camera Apps](#)



[Recommended computer environment](#)



4-543-698-11(1)

Copyright 2014 Sony Corporation



Interchangeable Lens Digital Camera
ILCE-5100

Installing the applications

[Opening a service account](#)

You can open a service account, which is required to download applications.

[Downloading applications](#)

You can download applications using your computer.

[Downloading applications directly to the product using the Wi-Fi function](#)

You can download applications using the Wi-Fi function without connecting to a computer.

4-543-698-11(1)

Copyright 2014 Sony Corporation



Interchangeable Lens Digital Camera
ILCE-5100

Starting the applications

[Launching the downloaded application](#)

Launch an application that has been downloaded from the application download website PlayMemories Camera Apps.



4-543-698-11(1)

Copyright 2014 Sony Corporation



Interchangeable Lens Digital Camera
ILCE-5100

Managing the applications

[Uninstalling applications](#)

You can uninstall applications from this product.

[Changing the order of applications](#)

You can change the order in which added applications are displayed on this product.

[Confirming the account information of PlayMemories Camera Apps](#)

The account information for the “Sony Entertainment Network” that is registered on the product is displayed.

4-543-698-11(1)

Copyright 2014 Sony Corporation

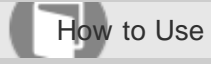

Interchangeable Lens Digital Camera
ILCE-5100

Recommended computer environment

[Recommended computer environment](#)



4-543-698-11(1)

Copyright 2014 Sony Corporation



Interchangeable Lens Digital Camera
ILCE-5100

Using the software

[PlayMemories Home](#)



[Installing PlayMemories Home](#)



[Software for Mac computers](#)



[“Image Data Converter”](#)



[Installing “Image Data Converter”](#)



[Accessing “Image Data Converter Guide”](#)



[“Remote Camera Control”](#)



[Installing “Remote Camera Control”](#)



[Accessing the Help of Remote Camera Control](#)



4-543-698-11(1)

Copyright 2014 Sony Corporation



Interchangeable Lens Digital Camera
ILCE-5100

Connecting this product and a computer

[Connecting the product to a computer](#)



[Importing images to the computer](#)

PlayMemories Home allows you to easily import images.



[Disconnecting the product from the computer](#)

Disconnects the USB connection between this product and the computer.



4-543-698-11(1)

Copyright 2014 Sony Corporation



Interchangeable Lens Digital Camera
ILCE-5100

Creating a movie disc

Disc type

Selecting the disc creation method

You can create a disc from an AVCHD format movie recorded using this product.

Creating a disc with a device other than a computer

You can also create discs using a Blu-ray recorder, etc.

Creating Blu-ray Discs

You can create Blu-ray Discs from AVCHD movies imported to a computer.

4-543-698-11(1)

Copyright 2014 Sony Corporation

Interchangeable Lens Digital Camera
ILCE-5100

Precautions

[Precautions](#)



[On the internal rechargeable battery](#)



This camera has an internal rechargeable battery for maintaining the date and time and other settings regardless of whether the power is on or off, or whether the battery pack is charged or discharged.

[Notes on the battery pack](#)



[Charging the battery pack](#)



[Memory card](#)



4-543-698-11(1)

Copyright 2014 Sony Corporation

Interchangeable Lens Digital Camera
ILCE-5100

Cleaning this product

[On cleaning](#)



[Cleaning the image sensor](#)

Follow the steps below to clean the image sensor.



4-543-698-11(1)

Copyright 2014 Sony Corporation

Interchangeable Lens Digital Camera
ILCE-5100

Number of recordable still images and recordable time of movies

[Number of still images](#)



[Recordable time of movies](#)



4-543-698-11(1)

Copyright 2014 Sony Corporation



Interchangeable Lens Digital Camera
ILCE-5100

Using this product abroad

Plug adaptor

You can use the AC Adaptor (supplied) in any country or region where the power supply is within 100 V to 240 V AC and 50 Hz/60 Hz. 

On TV color systems

To view movies shot using this product on a television, the product and television must use the same color television system. 

4-543-698-11(1)

Copyright 2014 Sony Corporation

Interchangeable Lens Digital Camera
ILCE-5100

Other information

[Mount Adaptor](#)



[LA-EA1 Mount Adaptor](#)



[LA-EA2 Mount Adaptor](#)



[LA-EA3 Mount Adaptor](#)



[LA-EA4 Mount Adaptor](#)



[AVCHD format](#)



[License](#)



4-543-698-11(1)

Copyright 2014 Sony Corporation

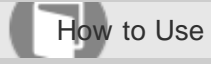

Interchangeable Lens Digital Camera
ILCE-5100

Trademarks

[Trademarks](#)



4-543-698-11(1)

Copyright 2014 Sony Corporation



Interchangeable Lens Digital Camera
ILCE-5100

If you have problems

[Troubleshooting](#)



4-543-698-11(1)

Copyright 2014 Sony Corporation

Interchangeable Lens Digital Camera
ILCE-5100

Battery pack and power

You cannot insert the battery pack into the product. 

You cannot turn on the product. 

The power turns off suddenly. 

The product gets hot. 

The remaining battery level indicator shows an incorrect level. 

The charge lamp on the product flashes when charging the battery pack. 

The battery pack inserted in the camera is not charging. 

The battery pack is not charged. 

4-543-698-11(1)

Copyright 2014 Sony Corporation

Interchangeable Lens Digital Camera
ILCE-5100

Shooting still images/movies

You cannot record images.



Recording takes a long time.



The image is out of focus.



Zoom does not work.



The flash does not work.



Fuzzy white circular spots appear on images shot using the flash.



The recording date and time are not displayed on the screen.



The date and time are recorded incorrectly.



The aperture value and/or shutter speed flashes.



The image colors are not correct.



Noise appears in the image when you view the screen in a dark place.



The eyes of the subject come out red.



Dots appear and remain on the screen.



You cannot shoot images continuously.



The image is whitish (Flare)./Blurring of light appears on the image (Ghosting).



The corners of the picture are too dark.



The image is blurred.



The LCD screen darkens after a short period of time passed.



The flash takes too long to recharge.



4-543-698-11(1)

Copyright 2014 Sony Corporation

Interchangeable Lens Digital Camera
ILCE-5100

Viewing images

Images cannot be played back.



The date and time are not displayed.



The image cannot be deleted.



The image was deleted by mistake.



A DPOF mark cannot be put.



4-543-698-11(1)

Copyright 2014 Sony Corporation

Interchangeable Lens Digital Camera
ILCE-5100

Wi-Fi

You cannot find the wireless access point to be connected. 

[WPS Push] does not work. 

[Send to Computer] is canceled halfway. 

You cannot send movies to a smartphone. 

[Smart Remote Embedded] or [Send to Smartphone] is canceled halfway. 

The shooting screen for [Smart Remote Embedded] is not displayed smoothly./The connection between this product and the smartphone is disconnected. 

You cannot use One-Touch connection (NFC). 

4-543-698-11(1)

Copyright 2014 Sony Corporation

Interchangeable Lens Digital Camera
ILCE-5100

Computers

[The computer does not recognize this product.](#)



[You cannot import images.](#)



[The image and sound are interrupted by noise when viewing a movie on a computer.](#)



[Images exported from a computer cannot be viewed on this product.](#)



4-543-698-11(1)

Copyright 2014 Sony Corporation

Interchangeable Lens Digital Camera
ILCE-5100

Memory cards

[Formatted the memory card by mistake.](#)



4-543-698-11(1)

Copyright 2014 Sony Corporation

Interchangeable Lens Digital Camera
ILCE-5100

Printing

You cannot print images.



The color of the image is strange.



Images are printed with both edges cut off.



You cannot print images with the date.



4-543-698-11(1)

Copyright 2014 Sony Corporation

Interchangeable Lens Digital Camera
ILCE-5100

Others

[The lens gets fogged.](#)



[The product becomes warm when you use it for a long time.](#)



[The Clock Set screen appears when you turn on the product.](#)



[The number of recordable images does not decrease, or decreases two images at a time.](#)



[The product does not work properly.](#)



[“--E-” appears on the screen.](#)



[The buttons on the touch panel do not work correctly or do not work at all.](#)



[You cannot perform touch operations.](#)



4-543-698-11(1)

Copyright 2014 Sony Corporation



Interchangeable Lens Digital Camera
ILCE-5100

Messages

[Warning messages](#)



4-543-698-11(1)
Copyright 2014 Sony Corporation



Interchangeable Lens Digital Camera
ILCE-5100

Situations this product has difficulty handling

[Situations this product has difficulty handling](#)



4-543-698-11(1)

Copyright 2014 Sony Corporation

Interchangeable Lens Digital Camera
ILCE-5100

Checking the camera and the supplied items

First check the model name of your camera. The accessories supplied differ depending on the model. The number in parentheses indicates the number of pieces.

Supplied with all models:

- Camera (1)
- NP-FW50 Rechargeable battery pack (1)

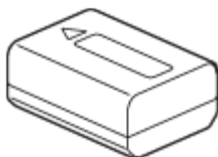

- Micro USB Cable (1)

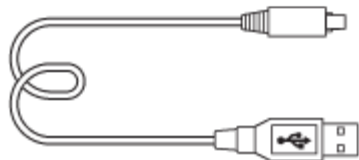

- AC-UB10C/UB10D AC Adaptor (1)

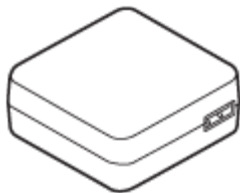

- Shoulder strap (1)

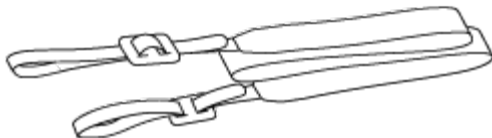

- Instruction Manual (1)
- Wi-Fi Connection/One-touch (NFC) Guide (1)

ILCE-5100

- Body cap (1) (Attached on the camera)

ILCE-5100L

- E16-50 mm zoom lens (1) (Attached on the camera)/Front lens cap (1) (Attached on the lens)

ILCE-5100Y

- E16-50 mm zoom lens (1) (Attached on the camera)/Front lens cap (1) (Attached on the lens)
- E55-210 mm zoom lens (1)/Front lens cap (1)/Rear lens cap (1)/Lens hood (1)

4-543-698-11(1)

Copyright 2014 Sony Corporation



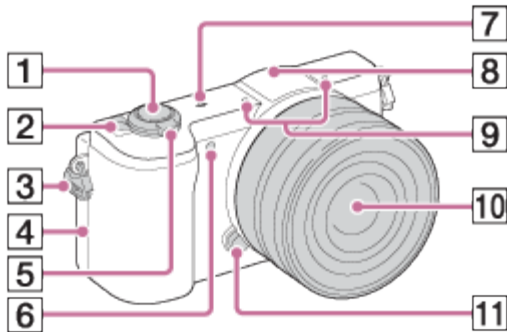

Interchangeable Lens Digital Camera
ILCE-5100

Identifying parts

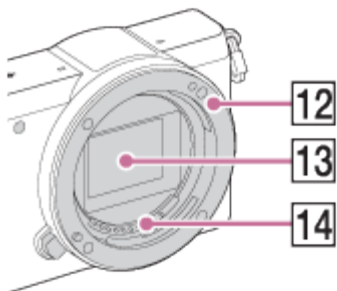

When the lens is removed



1. Shutter button
2. ON/OFF (Power) switch
3. Hook for shoulder strap
4.  (N mark)
 - Touch the mark when you connect the camera to a smartphone equipped with the NFC function.
 - NFC (Near Field Communication) is an international standard of the short-range wireless communication technology.
5. For shooting: W/T (zoom) lever
For viewing:  (Index) lever/  (Playback zoom) lever
6. AF illuminator/Self-timer lamp
7.  Image sensor position mark
8. Flash
 - Press the  (Flash pop-up) button to use the flash.
9. Microphone*
10. Lens

11. Lens release button
12. Mount
13. Image sensor**
14. Lens contacts**

*Do not cover this part during movie recording.

**Do not touch this part directly.

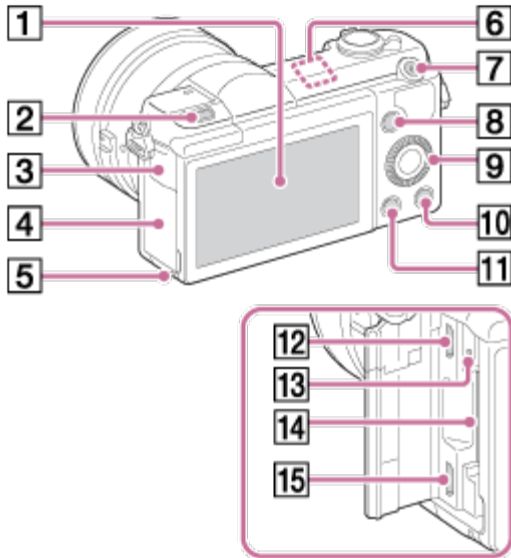

1. Monitor/Touch panel

- You can adjust the monitor to an easily viewable angle and shoot from any position.

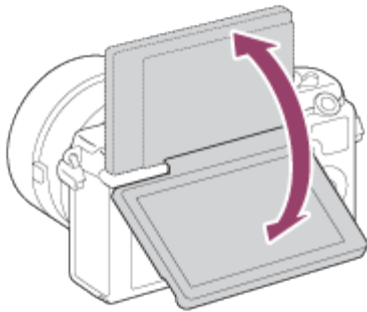

2. ⚡ (Flash pop-up) button
3. Multi/Micro USB Terminal cover
4. Memory card/terminal cover
5. Access lamp
6. Wi-Fi sensor (built-in)
7. MOVIE (Movie) button
8. MENU button
9. Control wheel
10. ? (In-Camera Guide) button/ 🗑️ (Delete) button
11. ▶️ (Playback) button
12. Multi/Micro USB Terminal
 - Supports Micro USB compatible device.

13. Charge lamp
14. Memory card slot
15. HDMI micro jack

*For details on compatible accessories for the Multi/Micro USB Terminal, visit the Sony website, or consult your Sony dealer or local authorized Sony service facility.

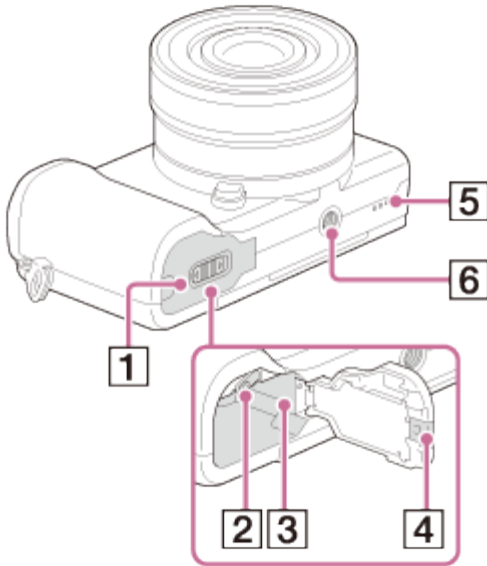

1. Battery cover
2. Battery lock lever
3. Battery insertion slot
4. Connection plate cover

- Use this when using an AC-PW20 (sold separately). Insert the connection plate into the battery compartment, and then pass the cord through the connection plate cover as shown below.

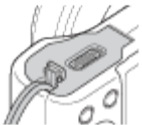

- Make sure that the cord is not pinched when you close the cover.

5. Speaker
6. Tripod socket hole

- Use a tripod with a screw less than 5.5 mm (7/32 inches) long. Otherwise, you cannot firmly secure the camera, and damage to the camera may occur.

4-543-698-11(1)

Copyright 2014 Sony Corporation

Interchangeable Lens Digital Camera
ILCE-5100

Identifying parts Lens E PZ 16–50 mm F3.5–5.6 OSS (supplied with ILCE-5100L/ILCE-5100Y)

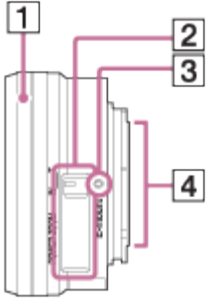

1. Zooming/Focusing ring
2. Zooming lever
3. Mounting index
4. Lens contacts*

*Do not touch this part directly.

4-543-698-11(1)

Copyright 2014 Sony Corporation

Interchangeable Lens Digital Camera
ILCE-5100

Identifying parts Lens E 55-210 mm F4.5-6.3 OSS (supplied with ILCE-5100Y)

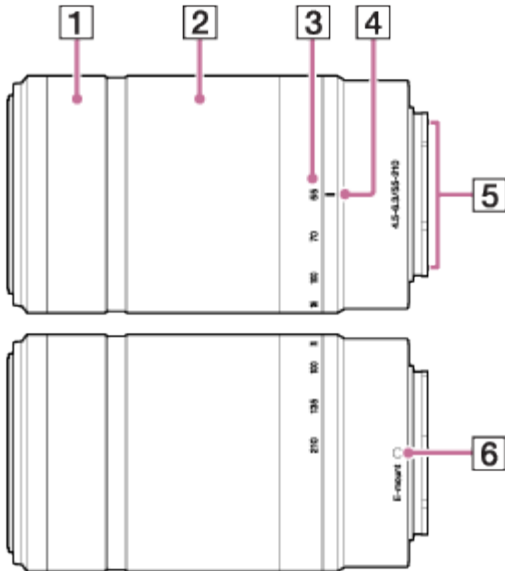

1. Focusing ring
2. Zooming ring
3. Focal-length scale
4. Focal-length index
5. Lens contacts*
6. Mounting index

*Do not touch this part directly.

4-543-698-11(1)

Copyright 2014 Sony Corporation

Interchangeable Lens Digital Camera
ILCE-5100

List of icons on the screen

The displayed contents and their positions shown below are just a guideline, and may differ from the actual display.

List of shooting mode icons

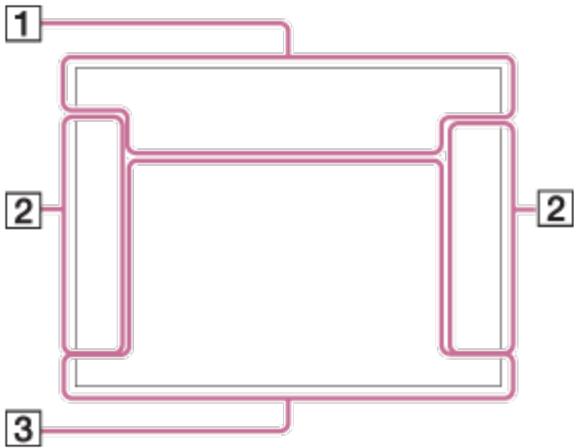

List of viewing mode icons



1. 📷 📷+ P P* A S M 📐 📐 P 📐 A 📐 S 📐 M 📐

Shooting mode

📄 NO CARD 📶 📶 OFF 📶 📶 📶 📶 📶 📶

Memory card/Uploading status

🌙 🌙 🌙 🌙 🌙 🌙 🌙 🌙 🌙 🌙 🌙

Scene Recognition icons



Scene Selection

100

Remaining number of recordable images



Aspect ratio of still images

24M / 20M / 12M / 10M / 6.0M / 5.1M  WIDE  STD

Image size of still images

RAW RAW+J FINE STD

Image quality of still images



Frame rate of movies



Image size of movies



NFC is activated

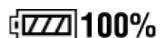

Remaining battery



Remaining battery warning



Flash charge in progress



AF Illuminator



Auto Obj. Framing



SteadyShot



Camera shake warning



Airplane Mode



No audio recording of movies



Wind Noise Reduct.



Overheating warning



Database file full/Database file error



Setting Effect OFF



Smart Zoom/Clear Image Zoom/Digital Zoom



Spot metering area



View Mode

100-0003

Folder-File number

XAVC S AVCHD MP4

Recording mode of movies



Protect

DPOF

DPOF set



Dual Video REC



PC Remote



Touch shutter icon



Touch operation is enabled



Touch focus OFF

- 2.

Drive mode



Self-portrait/ -timer



Metering mode



Flash mode/Red-eye reduction

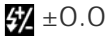

Flash compensation



Focus mode



Focus area

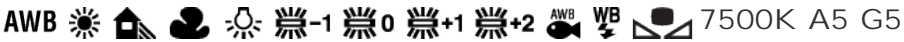

White balance



DRO/Auto HDR



Smile/Face Detect.



Creative Style



Soft Skin Effect

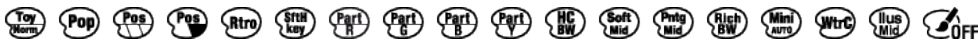

Picture Effect



Smile detection sensitivity indicator

3. ● Switch Shoot Mode

Guide display for switching the shooting mode



Guide display for center button Lock-on AF

REC 0:12

Recording time of the movie (m:s)



Control wheel function (P*: Program shift, Av: Aperture, Tv: Shutter speed)



Focus

1/250

Shutter speed

F3.5

Aperture Value

 ±0.0

Metered Manual

 ±0.0

Exposure compensation

ISO400

ISO sensitivity



AE lock



Shutter speed indicator



Aperture indicator



Histogram



Picture Effect error



Auto HDR image warning

2014-1-1

10:37AM

Date of recording

3/7

File number/Number of images in the view mode

4-543-698-11(1)

Copyright 2014 Sony Corporation

Interchangeable Lens Digital Camera
ILCE-5100

List of focus range finder frames

The focus range finder frame differs as follows depending on the shooting mode.

When using contrast AF or focal plane phase detection AF mode

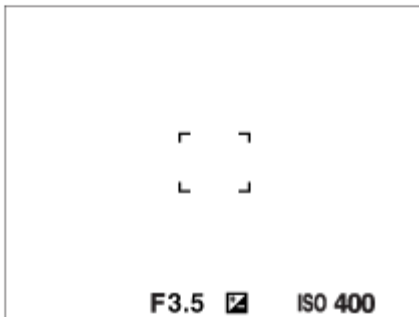

When using focal plane phase detection AF mode

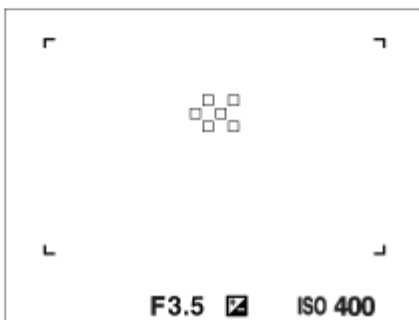

- When [Focus Area] is set to [Wide] or [Zone], and if you aim at a moving subject, the focus range finder frame may be displayed as above.

When focus is achieved automatically based on the whole range of the monitor

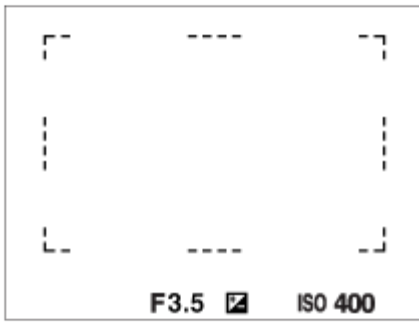

- When [AF Illuminator] is set to [Auto], and [Focus Area] is set to [Wide] or [Zone], an AF range finder frame may be shown by the dotted line.
- When you use a zoom function other than the optical zoom, the [Focus Area] setting is disabled and the focus area frame is shown by the dotted line. The AF operates with priority on and around the center area.

4-543-698-11(1)

Copyright 2014 Sony Corporation

Interchangeable Lens Digital Camera
ILCE-5100

Using the shoulder strap

Attach the shoulder strap to prevent damage caused by dropping the product.

1. Attach both ends of the strap.

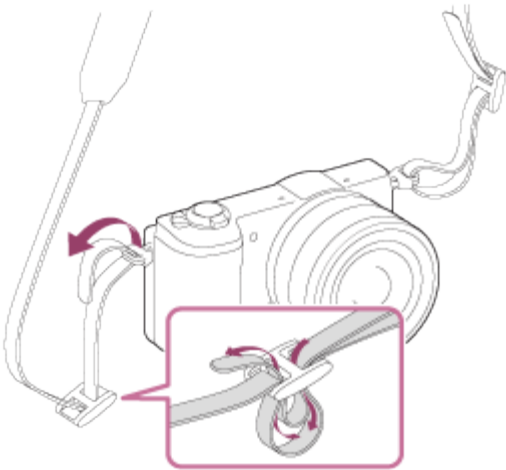

4-543-698-11(1)

Copyright 2014 Sony Corporation



Interchangeable Lens Digital Camera
ILCE-5100

About the [In-Camera Guide]

The [In-Camera Guide] displays descriptions of MENU items and settings, and if a function cannot be set, the reason why.

1. Press the MENU button.
2. Select the desired MENU item using up/down/left/right side on the control wheel.
3. Press the ? (In-Camera Guide) button.

The operation guide for the MENU item you have selected in step 2 is displayed.

- If you press the  on the center of the control wheel after selecting an item shown in gray, the reason the item cannot be set is displayed.

Related Topic

 [Custom Key Settings](#)

4-543-698-11(1)

Copyright 2014 Sony Corporation

Interchangeable Lens Digital Camera
ILCE-5100

About the shooting advice

Displays the shooting advice according to the selected shooting mode.

1. Press the ? (In-Camera Guide) button while the shooting screen is displayed.
2. Press the top/bottom side of the control wheel to select the desired shooting advice, then press  on the center.
The shooting advice is displayed.
 - You can scroll the screen by pressing the up/down side of the control wheel.

Hint

- To view all the shooting advice, select MENU →  (Camera Settings) → [Shooting Tip List].

4-543-698-11(1)

Copyright 2014 Sony Corporation

Interchangeable Lens Digital Camera
ILCE-5100

Charging the battery pack while it is inserted in the camera

When using the camera for the first time, be sure to charge the battery pack. The charged battery pack will discharge little by little, even if you do not use it. To avoid missing a shooting opportunity, charge the battery pack before shooting.

1. Turn the power OFF.
2. Connect the camera with the battery pack inserted to the AC Adaptor (supplied) using the micro USB cable (supplied), and connect the AC Adaptor to the wall outlet (wall socket).

For customers in the U.S.A. and Canada

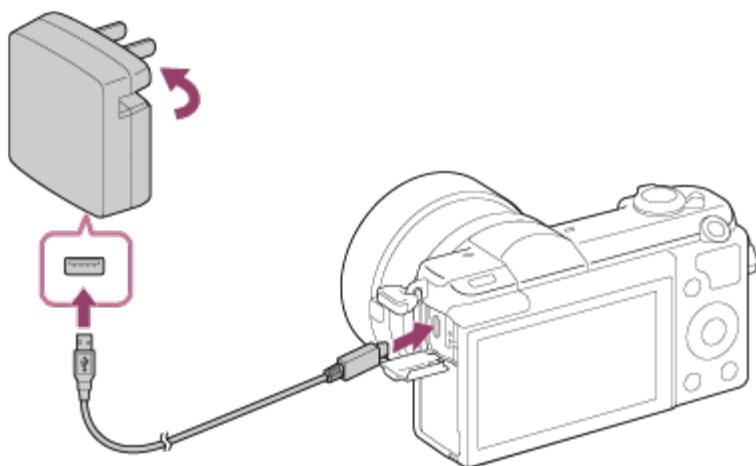

For customers in countries/regions other than the U.S.A. and Canada

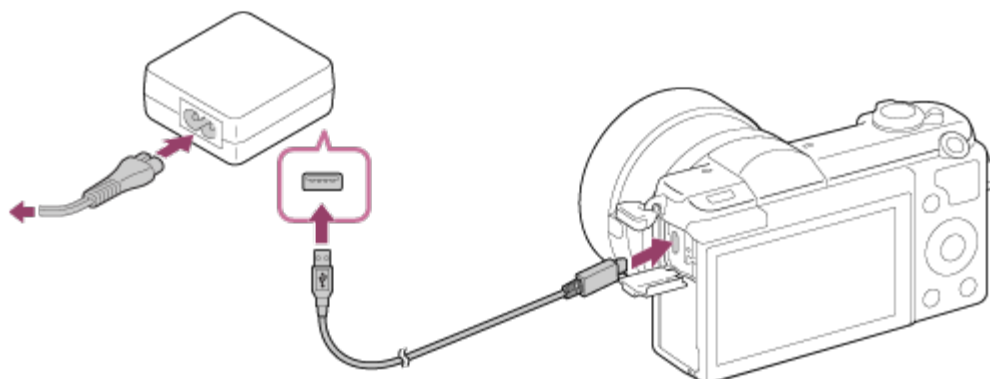

Charge lamp

Lit: Charging

Off: Charging finished

Flashing: Charging error or charging paused temporarily because the camera is not within the proper temperature

range

Charging time (Full charge)

The charging time is approximately 310 min. using the AC Adaptor (supplied).

- The charging time may differ depending on the remaining capacity of the battery pack or the charging conditions.
- The battery pack can be charged even when it is not fully depleted.
- The above charging time applies when charging a fully depleted battery pack (supplied) at a temperature of 25°C (77°F). Charging may take longer depending on the conditions of use and the environment.
- To check the remaining battery charge, detach the micro USB cable and check the  (remaining charge indicator) on the screen.

Note

- If the charge lamp flashes when the battery pack is not fully charged, remove the battery pack from the camera and then re-insert it to recharge.
- If the charge lamp on the camera flashes when the AC Adaptor is connected to the wall outlet (wall socket), this indicates that charging is temporarily stopped because the temperature is outside the recommended range. When the temperature gets back within the appropriate range, the charging resumes. We recommend charging the battery pack at an ambient temperature of between 10°C to 30°C (50°F to 86°F).
- Connect the AC Adaptor to the nearest wall outlet (wall socket). If malfunctions occur while using the AC Adaptor, immediately disconnect the plug from the wall outlet (wall socket) to disconnect from the power source.
- When you use a completely new battery pack or a battery pack that has not been used for a long time, the charge lamp may flash quickly when the battery is charged for the first time. If that happens, remove the battery pack from the camera and then re-insert it to recharge.
- Do not continuously or repeatedly charge the battery pack without using it if it is already fully charged or close to fully charged. Doing so may cause a deterioration in battery performance.
- When charging is finished, disconnect the AC Adaptor from the wall outlet (wall socket).
- Be sure to use only genuine Sony brand battery packs, micro USB cables (supplied) and AC Adaptors (supplied).

Related Topic

- [Notes on the battery pack](#)
- [Charging the battery pack](#)

4-543-698-11(1)

Copyright 2014 Sony Corporation

Interchangeable Lens Digital Camera
ILCE-5100

Charging by connecting to a computer

The battery pack can be charged by connecting the camera to a computer using a micro USB cable.

1. Turn off the product, and connect to the USB terminal of the computer.

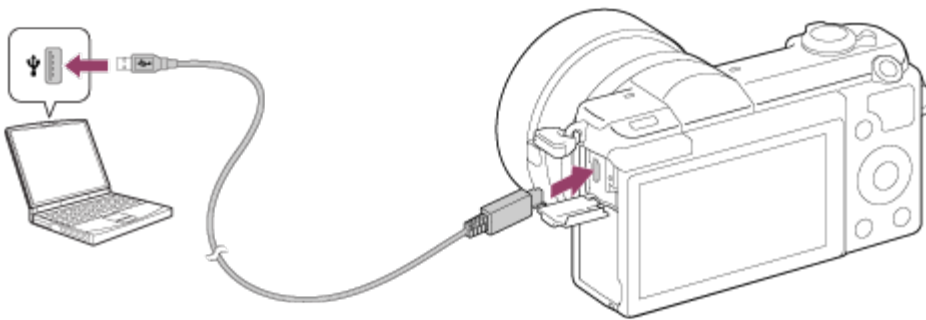
**Note**

- Note the following points when charging via a computer:
 - If the product is connected to a laptop computer that is not connected to a power source, the laptop battery level decreases. Do not charge for an extended period of time.
 - Do not turn on/off or restart the computer, or wake the computer from sleep mode when a USB connection has been established between the computer and the camera. Doing so may cause a malfunction. Before turning on/off or restarting the computer, or waking the computer from sleep mode, disconnect the camera from the computer.
 - Proper operation cannot be guaranteed on all types of computers.
 - No guarantees are made for charging using a custom-built computer or a modified computer.
 - The camera may not operate correctly when other USB devices are used at the same time.

Related Topic

- [Notes on the battery pack](#)
- [Charging the battery pack](#)

Interchangeable Lens Digital Camera
ILCE-5100

Inserting the battery pack into the camera

How to insert the battery pack into the camera

1. Slide the open lever to open the battery cover.

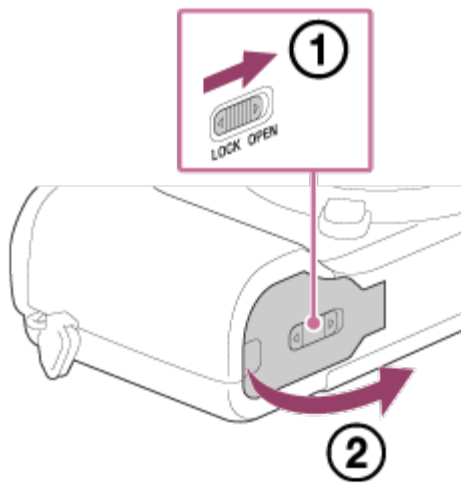

2. Insert the battery pack while pressing the lock lever (A) with the tip of the battery until the battery locks into place.

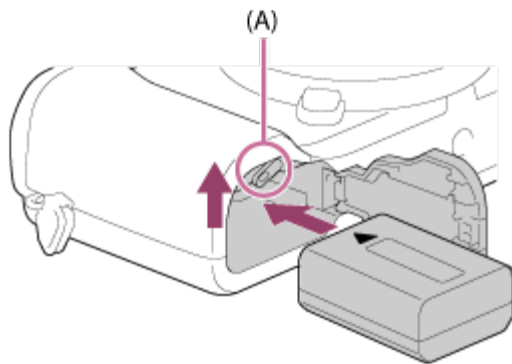

3. Close the cover.

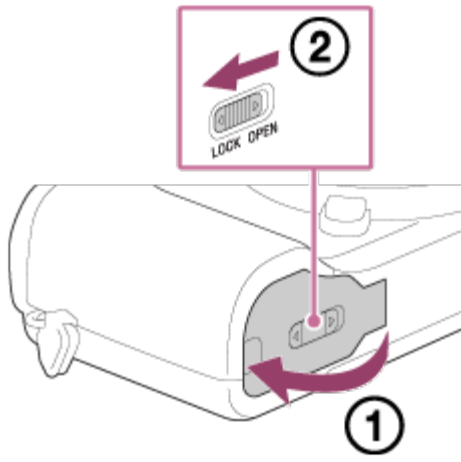

4-543-698-11(1)

Copyright 2014 Sony Corporation

Interchangeable Lens Digital Camera
ILCE-5100

Battery life and the number of images that can be recorded/played back using a battery pack

Shooting (still images):

Battery life: approx. 200 min., Number of images: approx. 400

Actual shooting (movies):

Battery life: approx. 75 min.

Continuous shooting (movies):

Battery life: approx. 110 min.

Viewing (still images):

Battery life: approx. 340 min., Number of images: approx. 6800

Note

- The above battery life and number of images applies when the battery pack has been fully charged. The battery life and number of images may decrease depending on the conditions of use.
- The battery life and number of images that can be recorded is for shooting under the following conditions:
 - The battery pack is used at an ambient temperature of 25°C (77°F).
 - Using the lens E PZ 16-50mm F3.5-5.6 OSS
 - Using Sony Memory Stick PRO Duo (Mark2) media (sold separately)
 - [Monitor Brightness]: [Manual][±0]
- The number for "Shooting (still images)" is based on the CIPA standard, and is for shooting under the following conditions (CIPA: Camera & Imaging Products Association):
 - DISP: [Display All Info.]
 - Focus Mode: [Automatic AF]
 - One picture is taken every 30 seconds.
 - The zoom is switched alternately between the W and T ends.
 - The flash strobes once for every two pictures.
 - The power is turned on and off once every ten times.
- The number for "Actual shooting (movies)" is based on the CIPA standard, and is for shooting under the following conditions:
 - The image quality is set to 60i 17M (FH) .
 - Actual shooting (movies): Battery life based on repeated shooting, zooming, shooting stand-by, turning on/off, etc.
 - Continuous movie shooting: Battery life based on non-stop shooting until the limit (29 minutes) has been reached, and then continued by pressing the MOVIE button again. Other functions, such as zooming, are not used.
- If the remaining battery is not displayed, press the DISP (Display Setting).

Interchangeable Lens Digital Camera
ILCE-5100

Supplying power using a wall outlet (wall socket)

Power can be supplied to the camera during shooting/playback using an AC adaptor AC-PW20 (sold separately).

1. To supply power to the camera during shooting/playback, connect the camera and the AC adaptor AC-PW20 (sold separately) and plug the AC adaptor to a wall outlet (wall socket).

Note

- Power is not supplied during shooting/playback if the camera is connected to a wall outlet (wall socket) with the supplied AC adaptor. To supply power to the camera during shooting/playback, use the AC-PW20 AC adaptor (sold separately).

4-543-698-11(1)

Copyright 2014 Sony Corporation

Interchangeable Lens Digital Camera
ILCE-5100

Removing the battery pack

How to remove the battery pack

1. Make sure that the access lamp is not lit, and turn off the camera.
2. Slide lock lever (A) and remove the battery pack.

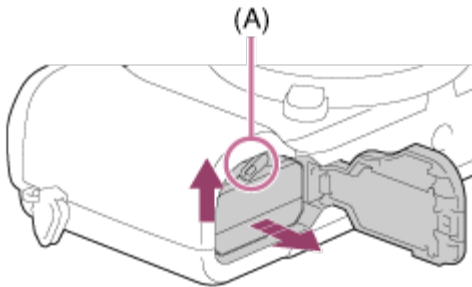

- Be careful not to drop the battery pack.

4-543-698-11(1)

Copyright 2014 Sony Corporation

Interchangeable Lens Digital Camera
ILCE-5100

Inserting a memory card

How to insert a memory card

1. Slide the memory card cover to open it.

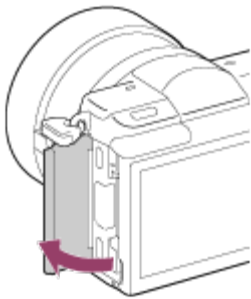

2. Insert the memory card.

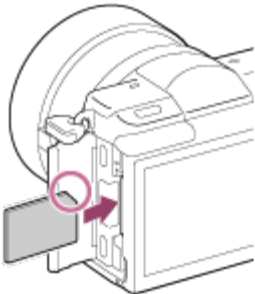

- Ensure that the notched corner is facing in the correct direction.
- With the notched corner facing in the direction illustrated, insert the memory card until it clicks into place.

3. Close the memory card cover.

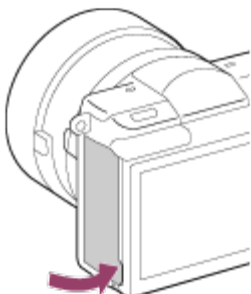

Related Topic

● [Memory card](#)

4-543-698-11(1)

Copyright 2014 Sony Corporation

Interchangeable Lens Digital Camera
ILCE-5100

Removing the memory card

How to remove the memory card

1. Open the memory card cover.
2. Make sure that the access lamp (A) is not lit.



3. Push in on the memory card once to remove it.

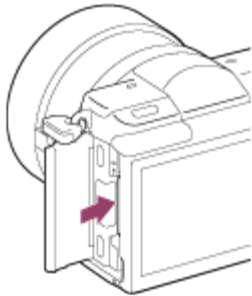

4. Close the memory card cover.

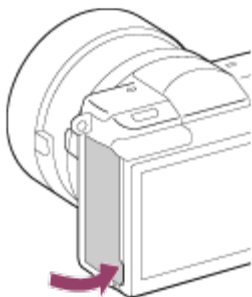

Related Topic

● [Memory card](#)

4-543-698-11(1)

Copyright 2014 Sony Corporation

Interchangeable Lens Digital Camera
ILCE-5100

Attaching a lens

Set the power switch of the camera to OFF before attaching the lens.

1. Remove the body cap (A) from the camera and the rear lens cap (B) from the rear of the lens.

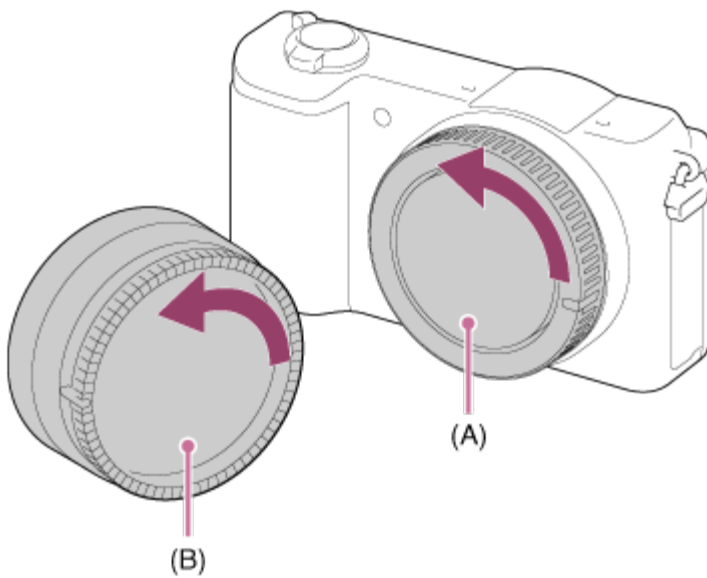

- When changing the lens, work quickly in a dust-free location to keep dust or debris from getting inside the camera.
- When shooting, remove the front lens cap from the front of the lens.

2. Mount the lens by aligning the two white index marks (mounting indexes) on the lens and camera.

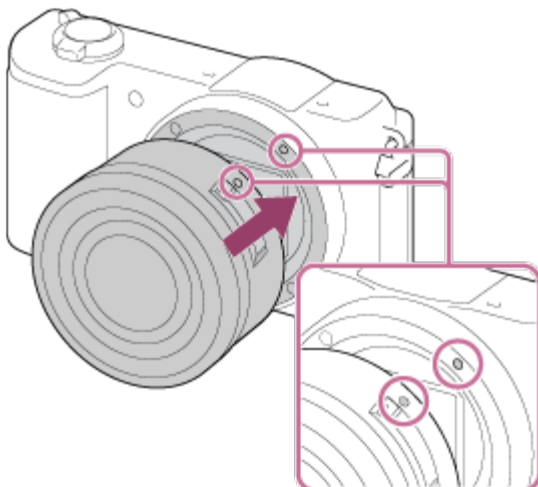

- Hold the camera with the lens facing down to prevent dust and debris from entering the camera.
3. While pushing the lens lightly toward the camera, turn the lens slowly in the direction of the arrow until it clicks into the locked position.

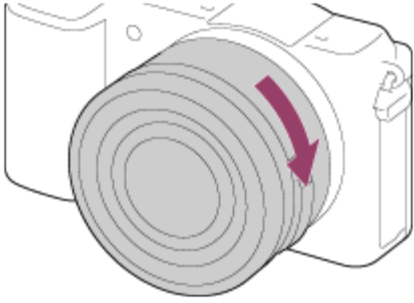

- Be sure to hold the lens straight when attaching it.

Note

- Do not press the lens release button when attaching a lens.
- Do not use force when attaching a lens.
- A Mount Adaptor (sold separately) is required to use an A-mount lens (sold separately). When using the Mount Adaptor, refer to the operating manual supplied with the Mount Adaptor.
- When you use a lens with a tripod socket, attach a tripod to the tripod socket of the lens to help balance the weight of the lens.
- When carrying the camera with a lens attached, hold both the camera and the lens firmly.
- Do not hold the part of the lens that is extended for zoom or focus adjustment.

Related Topic

- [Attaching the lens hood](#)

4-543-698-11(1)

Copyright 2014 Sony Corporation

Interchangeable Lens Digital Camera
ILCE-5100

Removing the lens

Set the power switch of the camera to OFF before you remove the lens.

1. Keep pressing the lens release button (A) and turn the lens in the direction of the arrow until it stops.

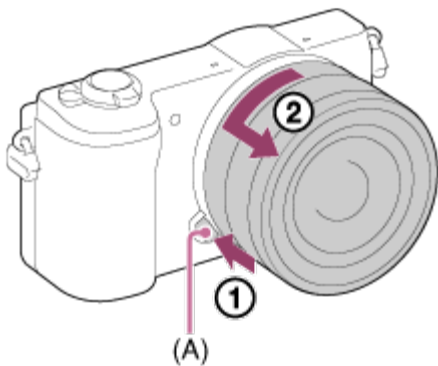

2. Attach the lens caps to the front and rear of the lens and the body cap to the camera.

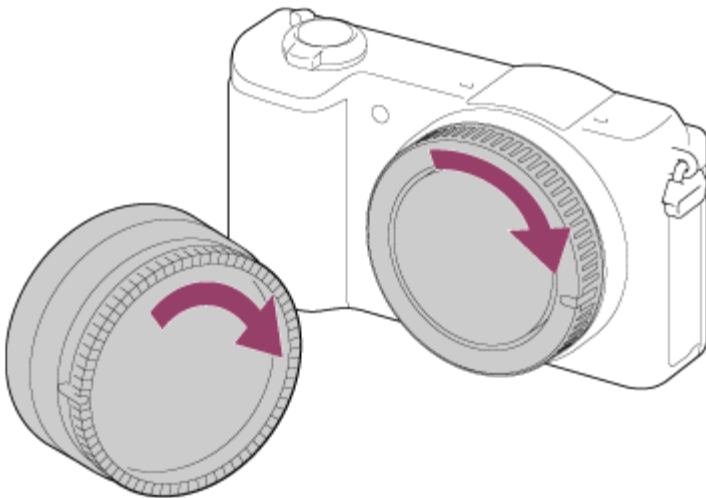

- Remove any dust from the caps before attaching them.

Interchangeable Lens Digital Camera
ILCE-5100

Attaching the lens hood

We recommend that you use the lens hood to prevent light outside the shooting frame from affecting the image.

1. Match the shape of the lens hood mounting part and lens head, and turn the lens hood clockwise until it clicks.

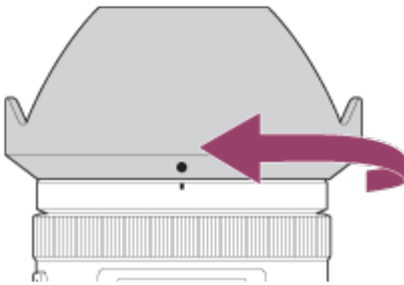
**Note**

- Attach the lens hood properly. Otherwise, the lens hood may not have any effect or may be partially reflected in the image.
- When the lens hood is attached properly, the lens hood index (red line) matches the red index mark on the hood. (There may be no lens hood index on some lenses.)
- Remove the lens hood when using the flash. Otherwise, the lens hood blocks the flash light and may appear as a shadow on the image.
- To store the lens hood after shooting, attach the lens hood to the lens backward.

Related Topic

- [Attaching a lens](#)



Interchangeable Lens Digital Camera
ILCE-5100

Notes on changing the lens

When changing the lens, if dust or debris gets inside the camera and adheres to the surface of the image sensor (the part that converts the light to an electric signal), it may appear as dark spots on the image, depending on the shooting environment.

The camera's image sensor is coated with an anti-dust coating to prevent dust from adhering to it. However, always make sure to attach/remove the lens quickly, away from dusty locations.





4-543-698-11(1)

Copyright 2014 Sony Corporation

Interchangeable Lens Digital Camera
ILCE-5100

Setting the date and time

When you turn on the camera for the first time or after you have initialized the functions, the setting screen for the date and time appears.

1. Set the power switch to ON to turn on the camera.
The setting screen for the date and time appears.
2. Check that [Enter] is selected on the screen, then press  on the control wheel.
3. Select your desired geographic location, and then press .
4. Select a setting item using the up/down side of the control wheel or by turning the control wheel, then press  in the center.
5. Set [Daylight Savings], [Date/Time], and [Date Format] using the up/down/left/right sides, then press  in the center.
 - Midnight is indicated as 12:00 AM, and noon as 12:00 PM.
6. Repeat steps 4 and 5 to set other items, then select [Enter] and press  in the center.
 - To cancel the date and time setting procedure, press the MENU button.

Note

- This camera does not have a function for inserting the date on images. You can insert the date on images and then save and print them using PlayMemories Home.
- If the date and time setting is cancelled halfway, the setting screen for the date and time appears every time you turn on the camera.

Related Topic

- [Date/Time Setup](#)
- [Area Setting](#)



Interchangeable Lens Digital Camera
ILCE-5100

Using the control wheel

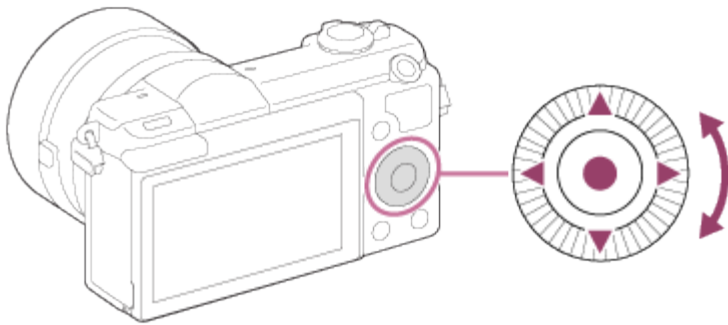

You can select setting items by turning or pressing the top/bottom/right/left side of the control wheel. Your selection is determined when you press  on the center of the control wheel.

The DISP (Display Setting), , ,  /  (Drive Mode), ISO functions are assigned to the top/bottom/left/right side of the control wheel. In addition, [Shoot Mode] is assigned to the  in the center. You can assign selected functions to the left/right/bottom side of the control wheel or to  in the center.

During playback, you can display the next/previous image by pressing the right/left side of the control wheel or by turning the control wheel.

Related Topic

- [Function of the center button](#)
- [Function of the left button](#)
- [Function of the right button](#)
- [Function of the down button](#)

Interchangeable Lens Digital Camera
ILCE-5100

Using the touch panel

This product is equipped with a touch panel. By touching the monitor, you can shoot still images (Touch Shutter) or bring the subject into focus (Touch Focus). You can also use the [Touch Shutter] function with [Self-portrait/ -timer] shooting.

Activating/deactivating the touch panel

You can set whether to operate the product using the touch panel.

1. MENU →  (Setup) → [Touch Operation] → desired setting.

Menu item details

On (default setting):

The touch panel is activated.

Off:

The touch panel is deactivated.

Related Topic

- [Shooting still images using touch operation \(Touch Shutter\)](#)
- [Taking pictures of yourself using touch operation \(Self-portrait/ -timer\)](#)
- [Adjusting the focus using touch operation \(Touch Focus\) \(still image\)](#)
- [Adjusting the focus using touch operation \(Touch Focus\) \(movie\)](#)

Interchangeable Lens Digital Camera
ILCE-5100

Using MENU items

In this section, you learn how to change settings related to all camera operations and execute camera functions including shooting, playback, and operation methods.

1. Press MENU button to display the Menu screen.

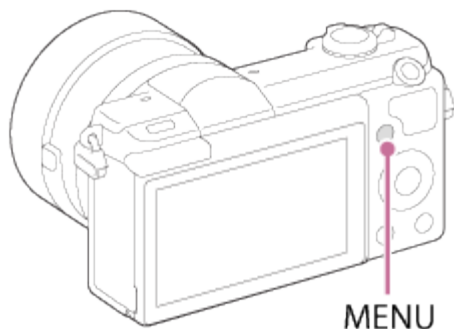

2. Select the desired MENU item using the up/down/left/right side of the control wheel or by turning the control wheel, and then press  in the center of the control wheel.
 - The display may move directly from step 1 to step 3 depending on the [Tile Menu] setting.

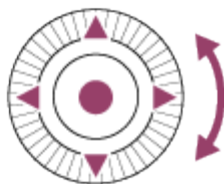
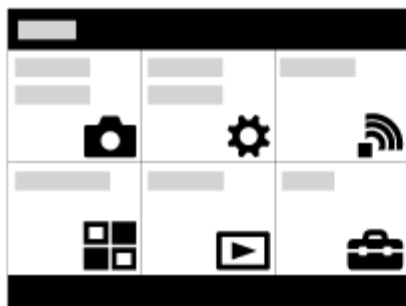

3. Select the desired setting item by pressing the up/down/left/right side on the control wheel or by turning the control wheel, and then press  on the center of the control wheel.
 - Select an icon at the top of the screen and press the left/right side of the control wheel to move to another MENU item.

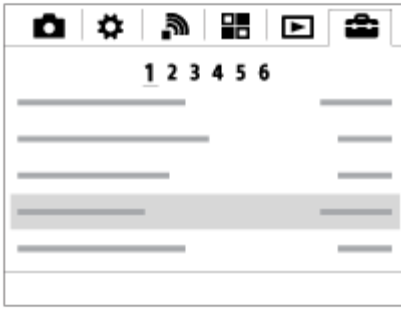

4. Select the desired setting value, and press ● to confirm.

Related Topic

● [Tile Menu](#)

4-543-698-11(1)

Copyright 2014 Sony Corporation





Interchangeable Lens Digital Camera
ILCE-5100

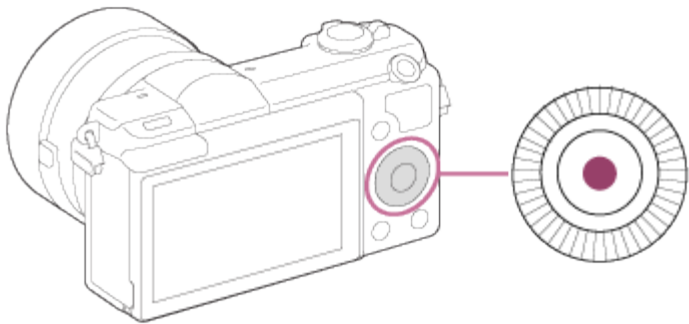

Shooting still images

Shoots still images.

1. Set the shooting mode to  (Intelligent Auto).



- If another function is assigned to the center button, select MENU →  (Camera Settings) → [Shoot Mode] → [Intelligent Auto].

2. Adjust the monitor angle, and hold the camera.
3. Press the shutter button halfway down to focus.
When the image is in focus, the indicator ( or ) lights up.

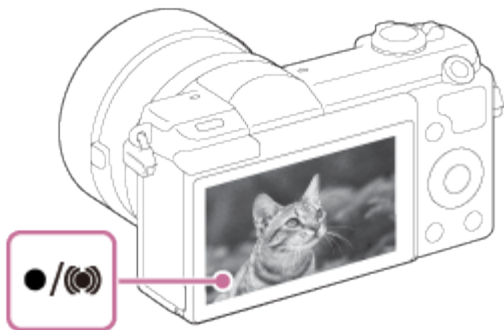

4. Press the shutter button fully down.

Focus indicator

 lights:

Image is in the focus.

 flashes:

The focusing has failed.

 lights:

Image is in the focus. The focused position will change to suit the motion of the subject.

 lights:

The focusing is in progress.

Hint

- When the product cannot focus automatically, the focus indicator flashes and the beep does not sound. Either recompose the shot or change the focus setting. When [Continuous AF] is set, the beep does not sound when focus is achieved.
- Focusing may be difficult in the following situations:
 - It is dark and the subject is distant.
 - The contrast between the subject and the background is poor.
 - The subject is seen through glass.
 - The subject is moving quickly.
 - There is reflective light or shiny surfaces.
 - There is a flashing light.
 - The subject is backlit.
 - Continuously repetitive pattern, such as the appearance of a building.

Related Topic

- [Zoom](#)
- [Playing back images](#)
- [Intelligent Auto](#)

4-543-698-11(1)

Copyright 2014 Sony Corporation

Interchangeable Lens Digital Camera
ILCE-5100

Shooting movies

You can record movies by pressing the MOVIE button.

1. Press the MOVIE button to start recording.

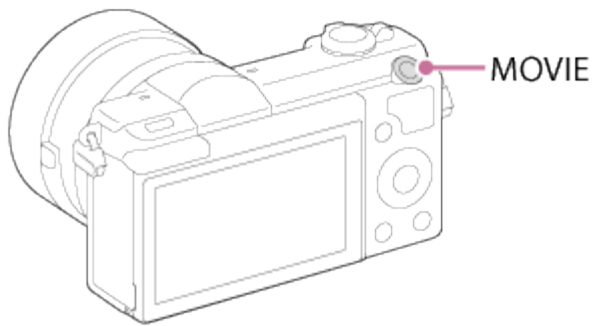

2. Press the MOVIE button again to stop recording.

Note

- To adjust the shutter speed and aperture value to the desired settings, set the shooting mode to  (Movie).
- If you use a function such as zoom while shooting a movie, the noise of the product operating will be recorded. The sound of the MOVIE button operating may also be recorded when you press the MOVIE button to stop recording.
- For the continuous shooting time of a movie recording, refer to "Recordable time of movies." When movie recording is finished, you can restart recording by pressing the MOVIE button again. Recording may stop to protect the product, depending on the temperature of the product or the battery.
- When shooting, the sound of the shoulder strap hooks (triangular hook) could be recorded, depending on the situation used.

Related Topic

- [Zoom](#)
- [Movie](#)
- [File Format \(movie\)](#)
- [Recordable time of movies](#)

Interchangeable Lens Digital Camera
ILCE-5100

List of shooting modes

You can select a desired shooting mode.

1. MENU →  (Camera Settings) → [Shoot Mode] → desired setting.

Available functions

 (Intelligent Auto):

Allows you to shoot still images with the settings adjusted automatically.

 (Superior Auto):

Allows you to shoot still images in higher quality than with Intelligent Auto mode.

P (Program Auto):

Allows you to shoot with the exposure adjusted automatically (both the shutter speed and the aperture value (F value)).

Also you can select various settings from the menu.

A (Aperture Priority):

Allows you to adjust the aperture and shoot, for example when you want to blur the background, etc.

S (Shutter Priority):

Allows you to shoot fast-moving subjects etc., by manually adjusting the shutter speed.

M (Manual Exposure):

Allows you to shoot still images with the desired exposure by adjusting the shutter speed and the aperture value.

 (Movie):

Allows you to change the settings for movie recording.

 (Sweep Panorama):

Allows you to shoot a panoramic image by compositing the images.

SCN (Scene Selection):

Allows you to shoot with preset settings according to the subject and scene.

Related Topic

- [Intelligent Auto](#)
- [Superior Auto](#)
- [Program Auto](#)
- [Sweep Panorama](#)
- [Scene Selection](#)

- Shutter Priority
- Aperture Priority
- Manual Exposure
- Movie

4-543-698-11(1)

Copyright 2014 Sony Corporation

Interchangeable Lens Digital Camera
ILCE-5100

Intelligent Auto

The product analyzes the subject, and allows you to shoot with appropriate settings.

1. MENU →  (Camera Settings) → [Shoot Mode] → [Intelligent Auto].

2. Point the camera to the subject.

When the camera recognized the scene, the icon for the recognized scene appears on the screen.



3. Adjust the focus and shoot the image.

Note

- The product will not recognize the scene when you shoot images with zoom functions other than optical zoom.
- The product may not properly recognize these scenes under some shooting conditions.

Related Topic

 [About Scene Recognition](#)

4-543-698-11(1)

Copyright 2014 Sony Corporation

Interchangeable Lens Digital Camera
ILCE-5100

Superior Auto

The product automatically recognizes and evaluates the shooting conditions, and the appropriate settings are set automatically.

The product may shoot multiple images and create a composite image, etc., using more shooting settings than in Intelligent Auto mode to record higher quality images.

1. Adjust the focus and shoot the image.

When the camera shoots multiple images, it automatically chooses and saves the appropriate image. You can also save all the images by setting the [S. Auto Img. Extract.].

2. MENU →  (Camera Settings) → [Shoot Mode] → [Superior Auto].

3. Point the camera to the subject.

When the camera recognizes a scene, scene recognition icon appears on the screen. If necessary, appropriate shooting function for the recognized scene and the number of times the shutter is released also appear.



Note

- When the product is used to create composite images, the recording process takes longer than usual.
- The product will not recognize the scene when you use zoom functions other than optical zoom.
- The product may not properly recognize a scene under some shooting conditions.
- When [ Quality] is set to [RAW] or [RAW & JPEG], the product cannot create a composite image.

Related Topic

- [S. Auto Img. Extract.](#)



Interchangeable Lens Digital Camera
ILCE-5100

About Scene Recognition

Scene Recognition operates in [Intelligent Auto] mode and [Superior Auto] mode.

This function allows the product to automatically recognize the shooting conditions and shoot the image.

Scene Recognition:













Icons and guides such as  (Portrait),  (Infant),  (Night Portrait),  (Night Scene),  (Backlight Portrait),  (Backlight),  (Landscape),  (Macro),  (Spotlight),  (Low Light),  (Night Scene using a tripod) or  (Hand-held Twilight) are displayed.

Image processing:

Cont. Shooting, Slow Sync., Auto HDR, Daylight Sync., Slow Shutter, Hand-held Twilight

Note

- When [Smile/Face Detect.] is set to [Off], the [Portrait], [Backlight Portrait], [Night Portrait] and [Infant] scenes are not recognized.

Related Topic

- [Intelligent Auto](#)
- [Superior Auto](#)



Interchangeable Lens Digital Camera
ILCE-5100

The advantages of automatic shooting

In [Superior Auto] mode, the product shoots with higher quality than [Intelligent Auto] mode and performs composite shooting as necessary.

In [Program Auto] mode, you can shoot after adjusting various functions, such as white balance, ISO, etc.

 (Intelligent Auto):

Select this mode when you want the camera automatically recognize the scene.

 (Superior Auto):

Select this mode to shoot scenes under difficult circumstances, such as when it is dark or the subjects are back-lit.

Select this mode to shoot a higher quality image than that provided by  (Intelligent Auto).

P (Program Auto):

Select this mode to shoot with various functions other than the exposure (shutter speed and aperture) adjusted.

Note

- In [Intelligent Auto] mode, you may not be able to shoot dark scenes or back-lit subjects clearly.
- In [Superior Auto] mode, the recording process takes longer, since the product creates a composite image.

Related Topic

- [Intelligent Auto](#)
- [Superior Auto](#)
- [Program Auto](#)

Interchangeable Lens Digital Camera
ILCE-5100

Program Auto

Allows you to shoot with the exposure adjusted automatically (both the shutter speed and the aperture value). You can set shooting functions such as [ISO].

1. MENU →  (Camera Settings) → [Shoot Mode] → [Program Auto].
2. Set the shooting functions to your desired settings.
3. Adjust the focus and shoot the subject.

Program Shift

You can change the shutter speed and aperture (F-value) combination by rotating the control wheel, without changing the appropriate exposure that is set by this product. This function is available when you do not use the flash.

- “P” on the screen changes to “P*” when you turn the control wheel.
- To cancel program shift, set the shooting mode to other than [Program Auto], or turn off the camera.

Note

- According to the brightness of the environment, the program shift may not be used.
- Set the shooting mode to another one than “P” or turn off the power to cancel the setting you made.
- When the brightness changes, the aperture (F value) and shutter speed also change while maintaining the shift amount.

Interchangeable Lens Digital Camera
ILCE-5100

Sweep Panorama

Allows you to create a single panoramic image from multiple images shot while panning the camera.



1. MENU →  (Camera Settings) → [Shoot Mode] → [Sweep Panorama].
2. Point the camera at the subject.
3. While pressing the shutter button halfway down, aim the camera at one end of the desired panoramic composition.



(A)

(A) This part will not be shot.

4. Press the shutter button fully down.
5. Pan the camera to the end of the guide in the direction of the arrow on the monitor.

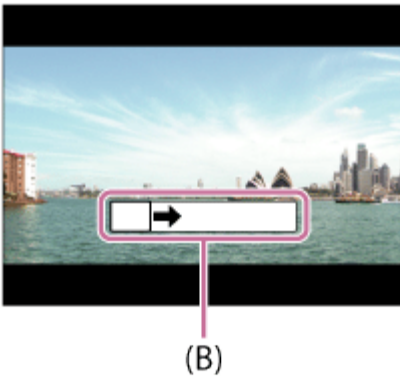

(B) Guidance bar

Note

- If the entire angle of the panoramic shot is not achieved within the set time, a gray area occurs in the composite image. If this happens, move the product faster to record the full panoramic image.
- When [Wide] is selected for [Panorama: Size], the entire angle of the panoramic shot may not be achieved within the given time. If this happens, try shooting after changing [Panorama: Size] to [Standard].
- Since several images are stitched together, the stitched part may not be recorded smoothly in some cases.
- The images may be blurred in dark scenes.
- When a light source such as a fluorescent light flickers, the brightness and color of a stitched image may not be consistent.
- When the whole angle of panoramic shooting and the AE/AF locked angle are very different in brightness and focus, the shooting may not be successful. If this happens, change AE/AF locked angle and shoot again.
- The following situations are not suited for shooting Sweep Panorama:
 - Moving subjects.
 - Subjects that are too close to the product.
 - Subjects with continuously similar patterns, such as the sky, beach, or a lawn.
 - Subjects with constant change such as waves or water falls.
 - Subjects with brightness widely different from its surroundings such as the sun or a light bulb.
- The Sweep Panorama shooting may be interrupted in the following situations.
 - When the camera is panned too fast or too slow.
 - The subject is too blurry.

Hint

- You can turn the control wheel on the shooting screen to select the shooting direction.

Related Topic

- [Panorama: Size](#)
- [Panorama: Direction](#)

Interchangeable Lens Digital Camera
ILCE-5100

Scene Selection

Allows you to shoot with preset settings according to the scene.

1. MENU →  (Camera Settings) → [Shoot Mode]→[Scene Selection] → desired mode.

Menu item details

 Portrait:

Blurs background and sharpens the subject. Accentuates the skin tones softly.



 Sports Action:

Shoots a moving subject at a fast shutter speed so that the subject looks as if it is standing still. The product shoots images continuously while the shutter button is pressed.



 Macro:

Shoots close-ups of the subjects, such as flowers, insects, food, or small items.



 Landscape:

Shoots the entire range of a scenery in sharp focus with vivid colors.



Sunset:

Shoots the red of the sunset beautifully.



Night Scene:

Shoots night scenes without losing the dark atmosphere.



Hand-held Twilight:

Shoots night scenes with less noise and blur without using a tripod. A burst of shots are taken, and image processing is applied to reduce subject blur, camera-shake, and noise.



Night Portrait:

Shoots night scene portraits using the flash.



Anti Motion Blur:

Allows you to shoot indoor shots without using the flash and reduces subject blur. The product shoots burst images and combines them to create the image, reducing subject blur and noise.



Note

- In the [Night Scene] and [Night Portrait] modes, the shutter speed is slower, so use of a tripod is recommended to prevent the image from blurring.
- In the [Hand-held Twilight] or [Anti Motion Blur] mode, the shutter clicks 4 times and an image is recorded.
- If you select [Hand-held Twilight] or [Anti Motion Blur] with [RAW] or [RAW & JPEG], the image quality becomes [Fine] temporarily.
- Reducing blur is less effective even in [Hand-held Twilight] or [Anti Motion Blur] when shooting the following subjects:
 - Subjects with erratic movement.
 - Subjects that are too close to the product.
 - Subjects with continuously similar patterns, such as the sky, a beach, or a lawn.
 - Subjects with constant change such as waves or water falls.
- In the case of [Hand-held Twilight] or [Anti Motion Blur], block noise may occur when using a light source that flickers, such as fluorescent lighting.
- The minimum distance that you can come close to a subject does not change even if you select [Macro]. For the minimum in-focus range, refer to the minimum distance of the lens attached to the product.

Hint

- To change the scene, rotate the control wheel on the shooting screen and select a new scene.

Related Topic

● [Using flash](#)

4-543-698-11(1)

Copyright 2014 Sony Corporation

Interchangeable Lens Digital Camera
ILCE-5100

Shutter Priority

You can express the movement of a moving subject in various ways by adjusting the shutter speed, for example, at the instant of the movement with high speed shutter, or as a trailing image with low speed shutter. The shutter speed can be changed while recording movies.

1. MENU →  (Camera Settings) → [Shoot Mode] → [Shutter Priority].
2. Select the desired value by turning the control wheel.
3. Adjust the focus and shoot the subject.
The aperture is automatically adjusted to obtain proper exposure.

Note

- If proper exposure cannot be obtained after setup, the aperture value on the shooting screen blinks. Although you can shoot as it is, resetting is recommended.
- Use a tripod to prevent blurring when you use a slow shutter speed.
- The  (SteadyShot warning) indicator does not appear in shutter speed priority mode.
- When the shutter speed is 1 second(s) or longer, noise reduction will be done after shooting for the same amount of time that the shutter was open. However, you cannot shoot any more while noise reduction is in progress.
- The brightness of the image on the monitor may differ from the actual image being shot.

Hint

- When a faster shutter speed is used, moving subjects, such as a running person, cars, or sea spray come out as if they are frozen in their movements. When a slower shutter speed is used, a trailing image of the movement of the subject is captured to create a more natural and dynamic image.

4-543-698-11(1)

Copyright 2014 Sony Corporation



Aperture Priority

You can shoot by adjusting the aperture and changing the range in focus, or by defocusing the background. The aperture value can be changed while recording movies.

1. MENU →  (Camera Settings) → [Shoot Mode] → [Aperture Priority].
2. Select the desired value by turning the control wheel.
 - Smaller F-value: The subject is in focus, but objects in front of and beyond the subject are blurred.
 - Larger F-value: The subject and its foreground and background are all in focus.
3. Adjust the focus and shoot the subject.
The shutter speed is automatically adjusted to obtain proper exposure.

Note

- If proper exposure cannot be obtained after setup, the shutter speed on the shooting screen blinks. Although you can shoot as it is, resetting is recommended.
- The brightness of the image on the screen may differ from the actual image being shot.

Hint

- Smaller F-value (opening the aperture) narrows the range that is in focus. This allows you to put the subject in sharp focus and blur objects in front of and beyond the subject (depth of field becomes shallower). Larger F-value (narrowing down the aperture) widens the range that is in focus. This allows you to shoot the depth of the scenery (depth of field becomes deeper).

Interchangeable Lens Digital Camera
ILCE-5100

Manual Exposure

You can shoot with the desired exposure setting by adjusting both the shutter speed and aperture. The shutter speed and the aperture value can be changed while recording movies.

1. MENU →  (Camera Settings) → [Shoot Mode] → [Manual Exposure].
2. Press the bottom side of the control wheel to select the shutter speed or aperture value, then turn the control wheel to select a value.
When [ISO] is set to other than [ISO AUTO], use MM (Metered Manual) to check the exposure value.
Toward +: Images become brighter.
Toward -: Images become darker.
O: Appropriate exposure analyzed by the product
3. Adjust the focus and shoot the subject.

Note

- When [ISO] is set to [ISO AUTO], the ISO value automatically changes to achieve the appropriate exposure using the aperture value and shutter speed you have set. If the aperture value and shutter speed you have set are not suitable for appropriate exposure, the ISO value indicator will blink.
- The Metered Manual indicator does not appear when [ISO] is set to [ISO AUTO].
- When the amount of ambient light exceeds the metering range of the Metered Manual, the Metered Manual indicator flashes.
- The  (SteadyShot warning) indicator does not appear in manual exposure mode.
- The brightness of the image on the monitor may differ from the actual image being shot.



BULB

You can shoot a trailing image of the movement of a subject with long exposure.

BULB is suitable for shooting trails of light, such as fireworks.

1. MENU →  (Camera Settings) → [Shoot Mode] → [Manual Exposure].
2. Press the bottom side of the control wheel to select the shutter speed, then turn the control wheel counterclockwise until [BULB] is indicated.
3. Press the shutter button halfway down to adjust the focus.
4. Press and hold the shutter button for the duration of the shooting.
As long as the shutter button is pressed, the shutter remains open.

Note

- Since the shutter speed becomes slow and the camera-shake tends to occur more easily, it is recommended that you use a tripod.
- The longer the exposure time, the more noise will be visible on the image.
- After shooting, noise reduction will be done for the same amount of time that the shutter was open. However, you cannot shoot any more while noise reduction is in progress.
- You cannot set the shutter speed to [BULB] in the following situations:
 - When the [Smile Shutter] function is activated.
 - When the [Auto HDR] function is activated.
 - When [Picture Effect] is set to [HDR Painting] or [Rich-tone Mono.].
 - When the [Drive Mode] function is set to [Cont. Shooting], [Cont. Bracket], [Self-timer(Cont)].

If you use the above functions when the shutter speed is set to [BULB], the shutter speed is temporarily set to 30 seconds.

Hint

- Images shot in [BULB] mode tend to be blurry. We recommend that you use a tripod or a remote commander (sold separately) that has a shutter button lock function.

Related Topic

 [Manual Exposure](#)



Interchangeable Lens Digital Camera
ILCE-5100

Movie

You can adjust the shutter speed or aperture value to your desired settings for recording movies. You can also check the image angle before shooting.

1. MENU →  (Camera Settings) → [Shoot Mode] → [Movie].
2. Press the MOVIE button to start recording.
 - Press the MOVIE button again to stop recording.

Menu item details

Program Auto:

Allows you to shoot with the exposure (both the shutter speed and the aperture value) adjusted automatically. Other settings can be adjusted manually and the settings are retained.

Aperture Priority:

Allows you to shoot after adjusting the aperture value manually.

Shutter Priority:

Allows you to shoot after adjusting the shutter speed manually.

Manual Exposure:

Allows you to shoot after adjusting the exposure (both the shutter speed and the aperture value) manually.

Related Topic

 [Shooting movies](#)

Interchangeable Lens Digital Camera
ILCE-5100

Zoom

Enlarge images using the W/T (zoom) lever when shooting.

1. Enlarge images with the W/T (zoom) lever when shooting.
 - Move the W/T (zoom) lever to the T side to zoom in and to the W side to zoom out.
 - When a zoom lens is mounted, you can also zoom by operating that lens. When a motor zoom lens is mounted, move the zoom lever of the zoom lens to enlarge subjects.

Hint

- When you select other than [Optical zoom only] for [Zoom Setting], you can exceed the zoom range of the optical zoom to zoom images.

Related Topic

- [Zoom Setting](#)
- [The zoom features available with this product](#)

4-543-698-11(1)

Copyright 2014 Sony Corporation

Interchangeable Lens Digital Camera
ILCE-5100

The zoom features available with this product

The zoom feature of the product provides a higher magnification zoom by combining various zoom features. The icon displayed on the screen changes, according to the selected zoom feature.

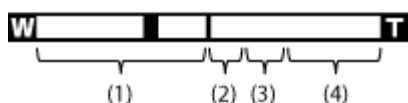

(1) Optical zoom range

Zoom images in the zoom range of a lens.

When a Power zoom lens is mounted, the zoom bar of the optical zoom range is displayed.

When a lens other than a Power zoom lens is mounted, the zoom bar of optical zoom range is not displayed.

(2) Smart Zoom range (s⁺)

Zoom images without causing the original quality to deteriorate by partially cropping an image (only when the image size is [M] or [S]).

(3) Clear Image Zoom range (c⁺)

Zoom images using an image process with less deterioration. Set [Zoom Setting] to [On:ClearImage Zoom] or [On:Digital Zoom] first.

(4) Digital Zoom range (d⁺)

You can magnify images using an image process. When you select [On:Digital Zoom] for [Zoom Setting], you can use this zoom function.

Note

- The default setting for [Image Size] is [L]. To use the smart zoom change [Image Size] to [M] or [S].
- Zoom functions other than the optical zoom are not available when shooting in the following situations:
 - [Sweep Panorama]
 - [Smile/Face Detect.] is set to [Smile Shutter]
 - [Quality] is set to [RAW] or [RAW & JPEG]
- You cannot use the Smart Zoom function with movies.
- When you use a zoom function other than the optical zoom, [Metering Mode] is fixed to [Multi].
- When you use another zoom function than the optical zoom, the following functions are not available:
 - [Face Detection]
 - [Lock-on AF]
 - [Auto Obj. Framing]

- [Zoom](#)
- [Zoom Setting](#)
- [About zoom scale](#)

4-543-698-11(1)

Copyright 2014 Sony Corporation

Interchangeable Lens Digital Camera
ILCE-5100

Zoom Setting

You can select the zoom setting of the product.

1. MENU →  (Custom Settings) → [Zoom Setting] → desired setting.

Menu item details

Optical zoom only:

Optical zoom is activated. You can use the Smart Zoom function if you set [ Image Size] to [M] or [S].

On:ClearImage Zoom (default setting):

Even if the zoom range of the optical zoom is exceeded, the product magnifies images within the range in which image quality does not deteriorate significantly.

On:Digital Zoom:

When the zoom range of the [ Clear Image Zoom] is exceeded, the product magnifies images to the largest scale. However, the image quality will deteriorate.

Note

- Set [Optical zoom only] if you want to magnify images within the range in which image quality does not deteriorate.

Related Topic

- [The zoom features available with this product](#)
- [About zoom scale](#)

Interchangeable Lens Digital Camera
ILCE-5100

About zoom scale

The zoom scale that is used in combination with the zoom of the lens changes according to the selected image size.

When [ Aspect Ratio] is [3:2]

[Zoom Setting] : [Optical zoom only (including smart zoom)]

[ Image Size] : L -, M 1.4x, S 2x

[Zoom Setting] : [On:ClearImage Zoom]

[ Image Size] : L 2x, M 2.8x, S 4x

[Zoom Setting] : [On:Digital Zoom]

[ Image Size] : L 4x, M 5.7x, S 8x

Related Topic

- [Zoom](#)
- [The zoom features available with this product](#)
- [Image Size \(still image\)](#)

4-543-698-11(1)

Copyright 2014 Sony Corporation

Interchangeable Lens Digital Camera
ILCE-5100

Using flash

In dark environments, use the flash to light up the subject while shooting and to prevent camera-shake. When shooting against the sun, use the flash to lighten the image of the backlit subject.

1. Press the  (Flash pop-up) button to pop up the flash.

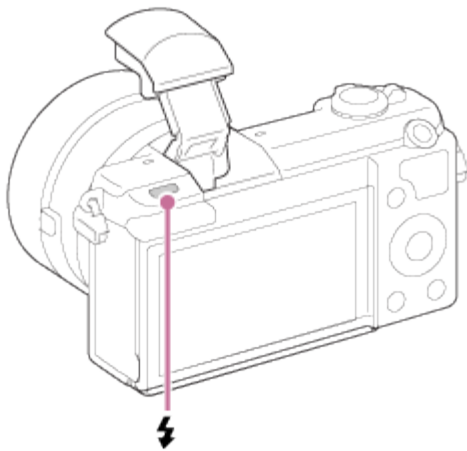



2. Press the shutter button fully down.

When you do not use the flash

When not using the flash, press it back into the camera body.

Note

- If you fire the flash before the flash unit pops up entirely, it may cause malfunction.
- You cannot use the flash when recording movies.
- While charging the flash,  flashes. After charging is completed, the flashing icon will light up.
- The light of the flash may be blocked by the lens attached.
- The corners of a recorded image may be shaded, depending on the lens.
- When the monitor is tilted upward more than 90 degrees, it is difficult to operate the  (Flash pop-up) button. Raise the flash unit before adjusting the monitor angle.
- When using flash to shoot pictures of yourself, be careful not to look directly at the light, because the flash will go off at a close distance. To prevent the flash from hitting the monitor when you press it back down into the camera body after use, first return the monitor to its original position.

4-543-698-11(1)

Copyright 2014 Sony Corporation



Interchangeable Lens Digital Camera
ILCE-5100

Flash Mode

You can set the flash mode.

1. MENU →  (Camera Settings) → [Flash Mode] → desired setting.

Menu item details

 Flash Off:

The flash does not operate.

 Autoflash:

The flash works in dark environments or when shooting towards bright light.

 Fill-flash:

The flash works every time you trigger the shutter.

 Slow Sync.:

The flash works every time you trigger the shutter. Slow sync shooting allows you to shoot a clear image of both the subject and the background by slowing the shutter speed.

 Rear Sync.:

The flash works right before the exposure is completed every time you trigger the shutter. Rear sync shooting allows you to shoot a natural image of the trail of a moving subject such as a moving car or a walking person.

Note

- The default setting depends on the shooting mode.
- Available flash mode depends on the shooting mode.

Related Topic

 [Using flash](#)



Interchangeable Lens Digital Camera
ILCE-5100

Flash Comp.

Adjusts the amount of flash light in a range of -2.0 EV to $+2.0$ EV.

Flash compensation changes the amount of flash light only. Exposure compensation changes the amount of flash light along with the change of the shutter speed and aperture.

1. MENU →  (Camera Settings) → [Flash Comp.] → desired setting.

Selecting higher values (+ side) makes the flash level higher, and lower values (– side) makes the flash level lower.

Note

- The higher flash effect may not be visible due to the limited amount of flash light available, if the subject is outside the maximum range of the flash. If the subject is very close, the lower flash effect may not be visible.

Related Topic

[Using flash](#)

4-543-698-11(1)

Copyright 2014 Sony Corporation

Interchangeable Lens Digital Camera
ILCE-5100

Switching the screen display (Shooting)

You can change the display contents on the screen.

1. Press the DISP (Display Setting) button.

Each time you press the DISP button, the recording information display changes as follows:

Graphic Display → Display All Info. → No Disp. Info. → Histogram → Graphic Display

Graphic Display

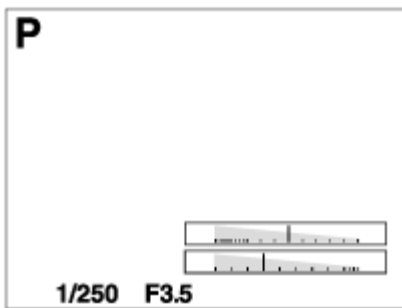

Display All Info.

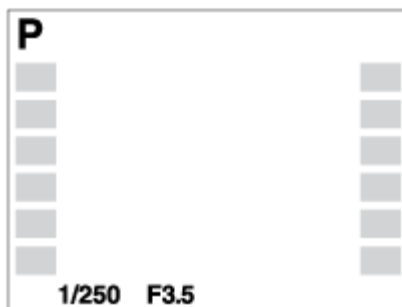

No Disp. Info.

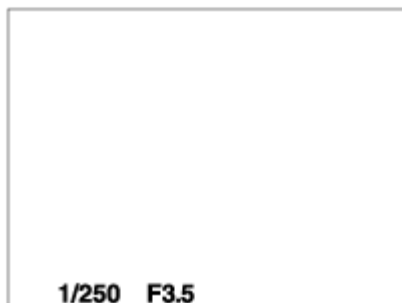

Histogram

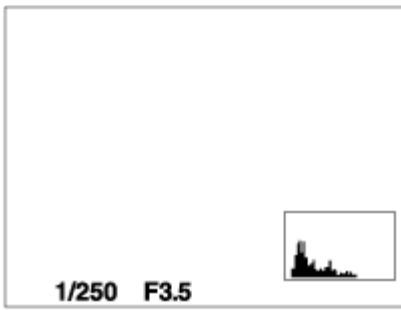



Some display modes are not available in the default settings.

To change the display modes, press MENU →  (Custom Settings) → [DISP Button] and change the setting.

Note

- Histogram is not displayed during panorama shooting.

Hint

- To hide the grid lines displayed during still image shooting, select MENU →  (Custom Settings) → [Grid Line] → [Off].
- To hide the marker displayed during movie recording, select MENU →  (Custom Settings) → [ Marker Display] → [Off].



4-543-698-11(1)

Copyright 2014 Sony Corporation

Interchangeable Lens Digital Camera
ILCE-5100

Image Size (still image)

The larger the image size, the more detail will be reproduced when the image is printed on large-format paper. The smaller the image size, the more images can be recorded.

1. MENU →  (Camera Settings) → [ Image Size] → desired setting.

Menu item details

Image size when [ Aspect Ratio] is 3:2

L: 24M 6000×4000 pixels

M: 12M 4240×2832 pixels

S: 6.0M 3008×2000 pixels

Image size when [ Aspect Ratio] is 16:9

L: 20M 6000×3376 pixels

M: 10M 4240×2400 pixels

S: 5.1M 3008×1688 pixels

Note

- When [ Quality] is set to [RAW] or [RAW & JPEG], the image size for RAW images corresponds to [L].

Related Topic

- [Aspect Ratio \(still image\)](#)

Interchangeable Lens Digital Camera
ILCE-5100

Aspect Ratio (still image)

Sets the aspect ratio of still images.

1. MENU →  (Camera Settings) → [ Aspect Ratio] → desired setting.

Menu item details

3:2 (default setting):

Suitable for standard prints.

16:9:

For viewing on a high-definition TV.

4-543-698-11(1)

Copyright 2014 Sony Corporation

Interchangeable Lens Digital Camera
ILCE-5100

Quality (still image)

Selects the compression format of still images.

1. MENU →  (Camera Settings) → [ Quality] → desired setting.

Menu item details

RAW:

File format: RAW (Records using the RAW compression format.)

Digital processing is not performed on this file format. Select this format to process images on a computer for professional purposes.

- The image size is fixed to the maximum size. The image size is not displayed on the screen.

RAW & JPEG:

File format: RAW (Records using the RAW compression format.) + JPEG

A RAW image and a JPEG image are created at the same time. This is suitable when you need 2 image files, a JPEG for viewing, and a RAW for editing.

The JPEG image quality is set to [Fine].

Fine (default setting):

File format: JPEG

The image is compressed in the JPEG format when recorded.

Standard:

File format: JPEG

The image is compressed in the JPEG format when recorded. Since the compression rate of [Standard] is higher than that of [Fine], the file size of [Standard] is smaller than that of [Fine]. This will allow more files to be recorded on 1 memory card, but the image quality will be lower.

Note

- If images are not to be modified using your computer, we recommend that you record images in JPEG format.
- You cannot add DPOF (print order) registration to RAW format images.

Interchangeable Lens Digital Camera
ILCE-5100

Panorama: Size

Sets the image size when shooting panoramic images. The image size varies depending on the [Panorama: Direction] setting.

1. MENU →  (Camera Settings) → [Panorama: Size] → desired setting.

Menu item details

When [Panorama: Direction] is [Up] or [Down]

Standard: 3872x2160

Wide: 5536x2160

When [Panorama: Direction] is [Left] or [Right]

Standard: 8192x1856

Wide: 12416x1856

Related Topic

- [Sweep Panorama](#)
- [Panorama: Direction](#)

4-543-698-11(1)

Copyright 2014 Sony Corporation

Interchangeable Lens Digital Camera
ILCE-5100

Panorama: Direction

Sets the direction to pan the camera when shooting panoramic images.

1. MENU →  (Camera Settings) → [Panorama: Direction] → desired setting.

Menu item details

Right (default setting):

Pan the camera from the left to the right.

Left:

Pan the camera from the right to the left.

Up:

Pan the camera from the bottom to the top.

Down:

Pan the camera from the top to the bottom.

Related Topic

 [Sweep Panorama](#)

Interchangeable Lens Digital Camera
ILCE-5100

Focus Mode

Selects the focus method to suit the movement of the subject.

1. MENU →  (Camera Settings) → [Focus Mode] → desired setting.

Menu item details

AF-S (Single-shot AF):

The product locks the focus when the focus adjustment is achieved. Use [Single-shot AF] when the subject is motionless.

AF-A (Automatic AF) (default setting):

[Single-shot AF] and [Continuous AF] are switched according to the movement of the subject. When the shutter button is pressed halfway down, the product locks the focus when it determines that the subject is motionless, or continues to focus when the subject is in motion.

During continuous shooting, the product automatically shoots with Continuous AF from the second shot.

AF-C (Continuous AF):

The product continues to focus while the shutter button is pressed and held halfway down. Use this when the subject is in motion.

DMF (DMF):

Allows you to use manual focus and auto focus in combination.

MF (Manual Focus):

Adjusts the focus manually.

Note

- If the subject is too close, the image may show any dust or fingerprints on the lens. Wipe the lens with a soft cloth, etc.
- When [Focus Mode] is set to [Continuous AF], the beep does not sound when focus is achieved.
- [Automatic AF] is available only when you are using a lens that supports focal plane phase detection AF.
- When [Focus Area] is [Wide] or [Zone], the focus range finder frame may change after you achieve focus using [Automatic AF] mode.

Related Topic

- [Direct manual focus \(DMF\)](#)
- [Manual Focus](#)
- [MF Assist \(still image\)](#)

Interchangeable Lens Digital Camera
ILCE-5100

Focus Area

Selects the focusing area. Use this function when it is difficult to get the proper focus in auto focus mode.

1. MENU →  (Camera Settings) → [Focus Area] → desired setting.

Menu item details

 Wide:

Focuses automatically on a subject in all ranges of the image.

When you press the shutter button halfway down in still image shooting mode, a green frame is displayed around the area that is in focus.

 Zone:

Select a zone on the monitor on which to focus. A zone consists of nine focus areas, and the product automatically selects a focus area on which to focus.

 Center:

Focuses automatically on a subject in the center of the image. When used together with the AF lock function, you can compose the image you want.

 Flexible Spot:

Allows you to move the AF range frame to the desired point on the screen and focus on an extremely small subject in a narrow area.

On the Flexible Spot shooting screen, you can change the size of the AF range finder frame by rotating the control wheel.

    Lock-on AF:

When the shutter button is pressed and held halfway down, the product tracks the subject within the selected autofocus area. Point the cursor to [Lock-on AF] on the [Focus Area] setting screen, then select the desired tracking start area using the left/right sides of the control wheel. You can move the tracking start area to the desired point by designating the area to be the flexible spot.

On the Flexible Spot shooting screen, you can change the size of the AF range finder frame by rotating the control wheel.

Note

- When [Focus Mode] is [Continuous AF] and [Focus Area] is [Wide] or [Zone], the focus range finder frame may change after the focus is achieved.

- When [ AF Illuminator] is [Auto] and [Focus Area] is [Wide] or [Zone], an AF range finder frame may be shown by the dotted line.

4-543-698-11(1)

Copyright 2014 Sony Corporation





Interchangeable Lens Digital Camera
ILCE-5100

Focal plane phase detection AF

When there are focal plane phase detection AF points within the auto focus area, the product uses the combined autofocus of the focal plane phase detection AF and contrast AF.

Note

- When the aperture value is set to F13 or above, you cannot use the focal plane phase detection AF. Only contrast AF is available.
- Focal plane phase detection AF is available only when an applicable lens is attached. If you use a lens that does not support focal plane phase detection AF, you cannot use [Automatic AF], [ AF Track Duration] or [ AF drive speed].
Also, even if you use a previously purchased applicable lens, the focal plane phase detection AF might not function unless you update the lens.
- When you attach an A-mount lens (sold separately) with the Mount Adaptor (sold separately), you cannot use the focal plane phase detection AF of this product.



4-543-698-11(1)

Copyright 2014 Sony Corporation

Interchangeable Lens Digital Camera
ILCE-5100

Center Lock-on AF

When you press the center button, the camera detects the subject positioned in the center of the screen and continues to track the subject.

1. MENU →  (Camera Settings) → [Center Lock-on AF] → [On]
2. Align the target frame (A) over the subject and press  in the center of the control wheel. To stop tracking, select MENU →  (Camera Settings) → [Center Lock-on AF] → [Off].

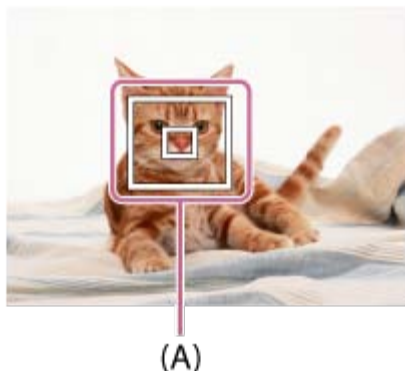

3. Press the shutter button fully down to shoot the image.

Note

- [Center Lock-on AF] may not function very well in the following situations:
 - The subject is moving too quickly.
 - The subject is too small, or too large.
 - The contrast between the subject and the background is poor.
 - It is dark.
 - The ambient light changes.
- Lock-on AF does not work in the following situations:
 - In [Sweep Panorama] mode
 - When [Scene Selection] is set to [Hand-held Twilight] or [Anti Motion Blur]
 - When shooting in Manual Focus mode
 - When using the digital zoom
- When the subject to be tracked disappears from the screen, Lock-on AF is released.
- When [Center Lock-on AF] is set to [On], the camera may not be able to resume tracking for a while after it loses the track of the subject.

Interchangeable Lens Digital Camera
ILCE-5100

Focus-lock

Shoots images with the focus locked on the desired subject in auto focus mode.

1. MENU →  (Camera Settings) → [Focus Mode] → [Single-shot AF].
2. Place the subject within the AF area and press the shutter button halfway down.
The focus is locked.
3. Keep pressing the shutter button halfway down, and place the subject back in the original position to re-compose the shot.
4. Press the shutter button down fully to take the picture.

4-543-698-11(1)

Copyright 2014 Sony Corporation

Interchangeable Lens Digital Camera
ILCE-5100

Manual Focus

When it is difficult to get the proper focus in autofocus mode, you can adjust the focus manually.

1. MENU →  (Camera Settings) → [Focus Mode] → [Manual Focus].
2. Rotate the focus ring to achieve sharp focus.

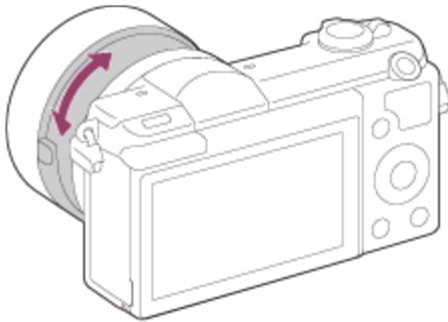

- When you rotate the focus ring, the focus distance is displayed on the screen.
3. Press the shutter button fully down to take the picture.

Related Topic

- [MF Assist \(still image\)](#)
- [Focus Magnifier](#)

4-543-698-11(1)

Copyright 2014 Sony Corporation

Interchangeable Lens Digital Camera
ILCE-5100

Direct manual focus (DMF)

You can make fine adjustments manually after the focus is locked.

You can quickly focus on a subject rather than using the manual focus from the beginning. This is convenient in cases such as macro shooting.

1. MENU →  (Camera Settings) → [Focus Mode] → [DMF].
2. Press the shutter button halfway down to focus automatically.
3. Keep the shutter button halfway down, rotate the focusing ring to achieve a sharper focus.

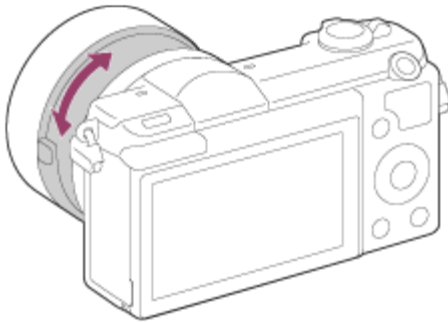

- When you rotate the focus ring, the focus distance is displayed on the screen.
4. Press the shutter button fully down to shoot an image.

4-543-698-11(1)

Copyright 2014 Sony Corporation

Interchangeable Lens Digital Camera
ILCE-5100

MF Assist (still image)



Enlarges the image on the screen automatically to make manual focusing easier. This works in Manual Focus or Direct Manual Focus shooting.

1. MENU →  (Custom Settings) → [ MF Assist] → [On].

2. Turn the focus ring to adjust the focus.

- The image is enlarged. You can magnify images further by pressing  on the center of the control wheel.

Note

- You cannot use [ MF Assist] when shooting movies.
- [ MF Assist] is available only when E-mount lens is attached.

Hint

- You can set how long the image is to be shown magnified by selecting MENU →  (Custom Settings) → [Focus Magnif. Time].



Related Topic

- [Manual Focus](#)
- [Direct manual focus \(DMF\)](#)
- [Focus Magnif. Time](#)



Interchangeable Lens Digital Camera
ILCE-5100

Focus Magnifier

You can check the focus by enlarging the image before shooting.

1. MENU →  (Camera Settings) → [Focus Magnifier].
2. Press  on the center of the control wheel to enlarge the image and select the position you want to enlarge using up/down/left/right side of the control wheel.
3. Confirm the focus.
4. Press the shutter button fully down to shoot the image.

Hint

- Each time you press  in the center, the magnifier scaling changes.
- When focusing manually, you can adjust the focus while an image is magnified.
- The [Focus Magnifier] function will be released when the shutter button is pressed halfway.
- You can record images while an image is enlarged, but the product records a full-display image.
- The [Focus Magnifier] function will be released after shooting.
- You can set how long the image is to be shown magnified by selecting MENU →  (Custom Settings) → [Focus Magnif. Time].

Related Topic

- [MF Assist \(still image\)](#)
- [Focus Magnif. Time](#)

4-543-698-11(1)

Copyright 2014 Sony Corporation

Interchangeable Lens Digital Camera
ILCE-5100

Focus Magnif. Time

Set the duration for which an image is to be magnified using the [ MF Assist] or [Focus Magnifier] function.

1. MENU →  (Custom Settings) → [Focus Magnif. Time] → desired setting.

Menu item details

2 Sec (default setting):

Magnifies the images for 2 seconds.

5 Sec:

Magnifies the images for 5 seconds.

No Limit:

Magnifies the images until you press the shutter button.

Related Topic

- [MF Assist \(still image\)](#)
- [Focus Magnifier](#)

4-543-698-11(1)

Copyright 2014 Sony Corporation

Interchangeable Lens Digital Camera
ILCE-5100

Peaking Level

Enhances the outline of in-focus ranges using a specific color in Manual Focus or Direct Manual Focus shooting. This function allows you to confirm the focus easily.

1. MENU →  (Custom Settings) → [Peaking Level] → desired setting.

Menu item details

High:

Sets the peaking level to high.

Mid:

Sets the peaking level to middle.

Low:

Sets the peaking level to low.

Off (default setting):

Does not use the peaking function.

Note

- Since the product determines that sharp areas are in focus, the effect of peaking differs, depending on the subject and shooting conditions.
- The outline of in-focus ranges is not enhanced when the product is connected using an HDMI cable.

Related Topic

- [Manual Focus](#)
- [Direct manual focus \(DMF\)](#)
- [Peaking Color](#)

Interchangeable Lens Digital Camera
ILCE-5100

Peaking Color

Sets the color used for the peaking function in Manual Focus or Direct Manual Focus shooting.

1. MENU →  (Custom Settings) → [Peaking Color] → desired setting.

Menu item details

Red:

Enhances outlines in red.

Yellow:

Enhances outlines in yellow.

White (default setting):

Enhances outlines in white.

Related Topic

- [Manual Focus](#)
- [Direct manual focus \(DMF\)](#)
- [Peaking Level](#)



4-543-698-11(1)

Copyright 2014 Sony Corporation

Interchangeable Lens Digital Camera
ILCE-5100

Pre-AF (still image)

The product automatically adjusts focus before you press the shutter button halfway down.

1. MENU →  (Custom Settings) → [ Pre-AF] → desired setting.

Menu item details

On (default setting):

Adjusts focus before you press the shutter button halfway down.

Off:

Does not adjust focus before you press the shutter button halfway down.

Note

- [ Pre-AF] is available only when an E-mount lens is mounted.

4-543-698-11(1)

Copyright 2014 Sony Corporation



Interchangeable Lens Digital Camera
ILCE-5100

AF/MF control

You can easily switch the focusing mode from auto to manual and vice versa while shooting without changing your holding position.

1. MENU →  (Custom Settings) → [Custom Key Settings] → button to be assigned → [AF/MF Control Hold] or [AF/MF Ctrl Toggle].

Menu item details

AF/MF Control Hold:

Switches the focusing mode while the button is held down.

AF/MF Ctrl Toggle:

Switches the focusing mode until the button is pressed again.

Note

- You cannot set the [AF/MF Control Hold] function to [Left Button], [Right Button] or [Down Button].

4-543-698-11(1)



Copyright 2014 Sony Corporation



Interchangeable Lens Digital Camera
ILCE-5100

AF Illuminator (still image)

The AF illuminator supplies fill light to focus more easily on a subject in dark surroundings. The red AF illuminator allows the product to focus easily when the shutter button is pressed halfway, until the focus is locked.

1. MENU →  (Camera Settings) → [ AF Illuminator] → desired setting.

Menu item details

Auto (default setting):

Uses the AF illuminator.

Off:

Does not use the AF illuminator.

Note

- You cannot use [ AF Illuminator] in the following situations:
 - In movie mode
 - In [Sweep Panorama] mode
 - When [Focus Mode] is set to [Continuous AF].
 - When [Scene Selection] is set to [Landscape], [Sports Action] or [Night Scene].
 - When a Mount Adaptor is attached.
- When [Focus Area] is set to [Wide] or [Zone], the AF range finder frame is indicated by a dotted line.
- The AF illuminator emits a very bright light. Although there is no health hazard, do not look directly into the AF illuminator at close range.



AF Micro Adj.

Allows you to adjust and register an autofocused position for each lens, when using an A-mount lens with the Mount Adaptor LA-EA2 or LA-EA4 (sold separately).

1. Select MENU →  (Custom Settings) → [AF Micro Adj.].
2. Select [AF Adjustment Set.] → [On].
3. [amount] → desired value.
 - You can select a value between -20 and +20. Selecting a positive value shifts the autofocused position away from the product. Selecting a negative value shifts the autofocused position closer to the product.

Note

- It is recommended that you adjust the position under actual shooting conditions.
- When you attach a lens for which you have already registered a value, the registered value appears on the screen. [±0] appears for lenses for which a value has not yet been registered.
- If [-] is displayed as the value, then a total of 30 lenses have been registered and no new lens can be registered. To register a new lens, attach a lens for which the registration can be erased, and set its value to [±0], or reset the values of all the lenses using [Clear].
- If you perform [AF Micro Adj.] with lenses other than Sony, Minolta, or Konica-Minolta lenses, the registered settings for Sony, Minolta, or Konica-Minolta lenses may be affected. Do not perform [AF Micro Adj.] with an unsupported lens.
- You cannot set [AF Micro Adj.] individually for a Sony, Minolta, and Konica-Minolta lens of the same specification.



Interchangeable Lens Digital Camera
ILCE-5100

Disp. cont. AF area

You can set whether or not to display the focus area that is in focus when [Focus Area] is set to [Wide] or [Zone] and [Focus Mode] is set to [Continuous AF].

1. MENU →  (Custom Settings) → [Disp. cont. AF area] → desired setting.

Menu item details

On (default setting):

Displays the focus area that is in focus.

Off:

Does not display the focus area that is in focus.

Note

- When [Focus Area] is [Center] or [Flexible Spot], the frames in the focus area that is in focus turn green, regardless of the [Disp. cont. AF area] settings.

Related Topic

 [Focus Mode](#)

 [Focus Area](#)

Interchangeable Lens Digital Camera
ILCE-5100

AF On

You can focus using any button instead of pressing the shutter button halfway down. The settings for [Focus Mode] will be applied.

1. Select the desired key and assign the [AF On] function to it using MENU →  (Custom Settings) → [Custom Key Settings].
2. Press the key to which you have assigned the [AF On] function while auto-focus shooting.

Note

- You cannot set the [AF On] function to [Left Button], [Right Button] or [Down Button].

Related Topic

 [Custom Key Settings](#)

4-543-698-11(1)

Copyright 2014 Sony Corporation

Interchangeable Lens Digital Camera
ILCE-5100

Eye AF

The camera focuses on the subject's eyes while you keep the button pressed.

1. MENU →  (Custom Settings) → [Custom Key Settings] → assign the [Eye AF] function to the desired button.
2. Point the camera at a person's face, and press the button to which you have assigned the [Eye AF] function.
3. Press the shutter button while pressing the button.

Note

- Depending on the circumstances, the camera may not be able to focus on the eyes. In such cases, the camera detects a face and focuses on the face.
- If the camera cannot detect a person's face, you cannot use [Eye AF].
- Depending on the circumstances, you cannot use [Eye AF], such as when [Focus Mode] is set to [Continuous AF] or [Manual Focus], etc.
- [Eye AF] may not function in the following situations:
 - When the person is wearing sunglasses.
 - When the front hair covers the person's eyes.
 - In low-light or back-lit conditions.
 - When the eyes are closed.
 - When the person is in the shade.
 - When the person is out of focus.

Hint

- When the camera focuses on the eyes and [Smile/Face Detect.] is set to [On], a detection frame is displayed on the face after it is displayed on the eyes. When [Smile/Face Detect.] is set to [Off], a detection frame is displayed on the eyes for a certain time.

Note

- You cannot set the [Eye AF] function to [Left Button], [Right Button] or [Down Button].



Related Topic

- [Custom Key Settings](#)
- [Smile/Face Detect.](#)

Interchangeable Lens Digital Camera
ILCE-5100

AF drive speed (movie)

You can switch focusing speed when using autofocus in movie mode.

1. MENU →  (Camera Settings) → [ AF drive speed] → desired setting.

Menu item details

Fast:

Sets the AF drive speed to fast. This mode is suitable for shooting active scenes, such as sports.

Normal (default setting):

Sets the AF drive speed to normal.



Slow:

Sets the AF drive speed to slow. With this mode, the focus switches smoothly when the subject to be focused is changed. This mode is useful for shooting impressive images.

Interchangeable Lens Digital Camera
ILCE-5100

AF Track Duration (movie)

You can set the duration for AF tracking in movie mode.

1. MENU →  (Camera Settings) → [ AF Track Duration] → desired setting.

Menu item details

High:

Sets the AF Track Duration to high. This mode is useful when recording movies when the subject is moving quickly.

Normal (default setting):

Sets the AF Track Duration to normal. This mode is useful when you want to keep the focus on a certain subject when there are some obstacles in front of the subject or in crowded places.

4-543-698-11(1)

Copyright 2014 Sony Corporation

Interchangeable Lens Digital Camera
ILCE-5100

Measuring the exact distance to the subject

The  mark shows the location of the image sensor*. When you measure the exact distance between the product and the subject, refer to the position of the horizontal line.

The distance from the lens contact surface to the image sensor is about 18 mm (23/32 in.).

*The image sensor is the part that converts the light source to a digital signal.

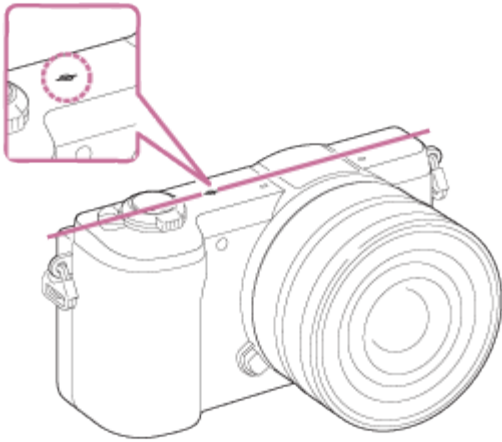

Note

- If the subject is closer than the minimum shooting distance of the lens, the focus cannot be confirmed. Make sure you put enough distance between the subject and the product.

4-543-698-11(1)

Copyright 2014 Sony Corporation

Interchangeable Lens Digital Camera
ILCE-5100

Exposure Comp.

Based on the exposure value set by auto exposure, you can make the entire image brighter or darker if you adjust [Exposure Comp.] to the plus side or minus side, respectively (exposure compensation). Normally, exposure is set automatically (auto exposure).

1. MENU →  (Camera Settings) → [Exposure Comp.] → desired setting.
You can adjust the exposure in a range of -3.0 EV to $+3.0$ EV.

Note

- You can adjust the exposure in a range of -2.0 EV to $+2.0$ EV for movies.
- If you shoot a subject in extremely bright or dark conditions, or when you use the flash, you may not be able to get a satisfactory effect.
- When you use [Manual Exposure], you can compensate for the exposure only when [ISO] is set to [ISO AUTO].

Related Topic

 [Exp.comp.set](#)

Interchangeable Lens Digital Camera
ILCE-5100

Metering Mode

Selects the metering mode that sets which part of the screen to measure for determining the exposure.

1. MENU →  (Camera Settings) → [Metering Mode] → desired setting.

Menu item details

 Multi (default setting):

Measures light on each area after dividing the total area into multiple areas and determines the proper exposure of the entire screen (Multi-pattern metering).

 Center:

Measures the average brightness of the entire screen, while emphasizing the central area of the screen (Center-weighted metering).

 Spot:

Measures only the central area (Spot metering). This function is useful when the subject is backlit or when there is strong contrast between the subject and the background.



Note

- [Multi] is selected when using the following functions:
 - [Intelligent Auto]
 - [Superior Auto]
 - [Scene Selection]
 - Zoom functions other than optical zoom



AE lock

When the contrast between the subject and background is high, such as when shooting a backlit subject or a subject near a window, meter the light at a spot where the subject appears to have the appropriate brightness and lock the exposure before shooting. To reduce the brightness of the subject, meter the light at a spot brighter than the subject and lock the exposure of the entire screen. To make the subject brighter, meter the light at a spot darker than the subject and lock the exposure of the entire screen.

1. MENU →  (Custom Settings) → [Custom Key Settings], then assign the [AEL toggle] to the desired key.
2. Adjust the focus on the spot at which the exposure is adjusted.
3. Press the button to which the [AEL toggle] function is assigned.
 - The exposure is locked, and  (AE lock) lights up.
4. Focus on the subject again and press the shutter button.
 - To cancel the exposure lock, press the button to which the [AEL toggle] function is assigned.



Hint

- If you select the [AEL hold] function in [Custom Key Settings], you can lock the exposure as long as you are holding down the AEL button. The [AEL hold] function cannot be assigned to the [Left Button], [Right Button], and [Down Button].

Interchangeable Lens Digital Camera
ILCE-5100

AEL w/ shutter (still image)

Sets whether to fix the exposure when you press the shutter button halfway down.

1. MENU →  (Custom Settings) → [ AEL w/ shutter] → desired setting.

Menu item details

Auto (default setting):

Fixes the exposure after adjusting the focus automatically when you press the shutter button halfway down when [Focus Mode] is set to [Single-shot AF].

When [Focus Mode] is set to [Automatic AF], and the product determines that the subject is moving, or you shoot burst images, the fixed exposure is cancelled.



On:

Fixes the exposure when you press the shutter button halfway down.

Off:

Does not fix the exposure when you press the shutter button halfway down. Use this mode when you want to adjust focus and exposure separately.

Note

- When [Focus Mode] is set to [Continuous AF] and [ AEL w/ shutter] is [Off] or [Auto], the aperture is fixed at the moment you press the shutter button halfway. If the brightness changes drastically during continuous shooting, release your finger from the shutter button once, then press the shutter button halfway down again.
- When [AEL toggle] is assigned to any key using [Custom Key Settings], operation using the key will be given priority over the [ AEL w/ shutter] settings.

Interchangeable Lens Digital Camera
ILCE-5100

Exp.comp.set

Sets whether to apply the exposure compensation value to control both flash light and ambient light, or just ambient light.

1. MENU →  (Custom Settings) → [Exp.comp.set] → desired setting.

Menu item details

Ambient&flash (default setting):

Applies the exposure compensation value to control both flash light and ambient light.

Ambient only:

Applies the exposure compensation value to control ambient light only.

Related Topic

 [Flash Comp.](#)

4-543-698-11(1)

Copyright 2014 Sony Corporation

Interchangeable Lens Digital Camera
ILCE-5100

Zebra

The zebra pattern will appear over the part of an image if the brightness level exceeds the IRE that you set. Use this zebra pattern as a guide to adjust the brightness.

1. MENU →  (Custom Settings) → [Zebra] → desired setting.

Menu item details

Off (default setting):

Does not display the zebra pattern.

70/75/80/85/90/95/100/100+:

Adjusts the brightness level.

Note

- The zebra pattern is not displayed during HDMI connection.

4-543-698-11(1)

Copyright 2014 Sony Corporation

Interchangeable Lens Digital Camera
ILCE-5100

Exposure Set. Guide

You can set whether to display a guide when you change the exposure.

1. MENU →  (Custom Settings) → [Exposure Set. Guide] → desired setting.

Menu item details

Off:

Does not display the guide.

On (default setting):

Displays the guide.

4-543-698-11(1)

Copyright 2014 Sony Corporation

Interchangeable Lens Digital Camera
ILCE-5100

Drive Mode

You can set the drive mode, such as continuous or self-timer shooting.

1. MENU →  (Camera Settings) → [Drive Mode] → desired setting.

Menu item details

 Single Shooting (default setting):

Shoots one still image. Normal shooting mode.

 Cont. Shooting:

Shoots images continuously while you press and hold down the shutter button.

 Self-timer:

Shoots an image after 10 or 2 seconds.

 Self-timer(Cont):

Shoots a specified number of images continuously after 10 seconds.

 **BRK C** Cont. Bracket:

Shoots images while holding the shutter button down, each with different degrees of brightness.

 **BRK S** Single Bracket:

Shoots a specified number of images, one by one, each with a different degree of brightness.

 **BRK WB** WB bracket:

Shoots a total of three images, each with a different color tones according to the selected settings for white balance, color temperature and color filter.

 **BRK DRO** DRO Bracket:

Shoots a total of three images, each at a different degree of D-Range Optimizer.

Related Topic

- [Cont. Shooting](#)
- [Self-timer](#)
- [Self-timer\(Cont\)](#)
- [Cont. Bracket](#)
- [Single Bracket](#)
- [WB bracket](#)
- [DRO Bracket](#)

Interchangeable Lens Digital Camera
ILCE-5100

Cont. Shooting

Shoots images continuously while you press and hold down the shutter button.

1. MENU →  (Camera Settings) → [Drive Mode] → [Cont. Shooting].
2. Select the desired mode using the right/left side of the control wheel.

Menu Item Details

 Continuous Shooting: Hi (default setting):

Continuous shooting speed is set at a maximum of about 6 images per second.

 Continuous Shooting: Lo:

Continuous shooting speed is set at a maximum of about 3 images per second.

Hint

- To hold the focus and exposure during burst, change the following settings.
The exposure of the first shot is determined when you press the shutter button halfway down. The exposure setting for the first shot is used for the subsequent shots.
 - Set [Focus Mode] to [Continuous AF] or [Automatic AF].
 - Set [ AEL w/ shutter] to [Off] or [Auto].

Related Topic

- [Focus Mode](#)
- [AEL w/ shutter \(still image\)](#)



Interchangeable Lens Digital Camera
ILCE-5100

Self-timer

The product shoots an image using the self-timer with a 10-second or 2-second delay.

1. MENU →  (Camera Settings) → [Drive Mode] → [Self-timer].
2. Select the desired mode using the right/left side of the control wheel.

Menu item details

 Self-timer: 10 Sec (default setting):





Sets the 10-second delay self-timer.

When you press the shutter button, the self-timer lamp flashes, a beep sounds, and the shutter operates after 10 seconds. To cancel the self-timer, press the shutter button again.

 Self-timer: 2 Sec:

Sets the 2-second delay self-timer. This reduces the camera-shake caused by pressing the shutter button.

Hint

- Press the / button of the control wheel to end the self-timer.
- Press the / button and select  (Single Shooting) of the control wheel to release the self-timer.

Interchangeable Lens Digital Camera
ILCE-5100

Self-timer(Cont)

Continuously shoots the number of images you have set after 10 seconds. You can choose the best shot from several shots taken.

1. MENU →  (Camera Settings) → [Drive Mode] → [Self-timer(Cont)].
2. Select the desired mode using the right/left side of the control wheel.

Menu item details

 Self-timer(Cont.): 10 Sec. 3 Img. (default setting):

Shoots three frames in succession 10 seconds after you press the shutter button.

When you press the shutter button, the self-timer lamp flashes, a beep sounds, and the shutter operates after 10 seconds.

 Self-timer(Cont.): 10 Sec. 5 Img.:

Shoots five frames in succession 10 seconds after you press the shutter button.

When you press the shutter button, the self-timer lamp flashes, a beep sounds, and the shutter operates after 10 seconds.

Interchangeable Lens Digital Camera
ILCE-5100

Cont. Bracket

Shoots multiple images while automatically shifting the exposure from base to darker and then to lighter. Press and hold down the shutter button until the bracket recording is completed.

You can select an image that suits your intention, after recording.

1. MENU →  (Camera Settings) → [Drive Mode] → [Cont. Bracket].
2. Select the desired mode using the right/left side of the control wheel.

Menu item details

 Cont. Bracket: 0.3EV 3 Image (default setting):

This setting shoots three images continuously with an exposure value shifted by plus or minus 0.3 EV.

 Cont. Bracket: 0.3EV 5 Image:

This setting shoots five images continuously with an exposure value shifted by plus or minus 0.3 EV.

 Cont. Bracket: 0.5EV 3 Image:

This setting shoots three images continuously with an exposure value shifted by plus or minus 0.5 EV.

 Cont. Bracket: 0.5EV 5 Image:

This setting shoots five images continuously with an exposure value shifted by plus or minus 0.5 EV.

 Cont. Bracket: 0.7EV 3 Image:

This setting shoots three images continuously with an exposure value shifted by plus or minus 0.7 EV.

 Cont. Bracket: 0.7EV 5 Image:

This setting shoots five images continuously with an exposure value shifted by plus or minus 0.7 EV.

 Cont. Bracket: 1.0EV 3 Image:

This setting shoots three images continuously with an exposure value shifted by plus or minus 1.0 EV.

 Cont. Bracket: 2.0EV 3 Image:

This setting shoots three images continuously with an exposure value shifted by plus or minus 2.0 EV.

 Cont. Bracket: 3.0EV 3 Image:

This setting shoots three images continuously with an exposure value shifted by plus or minus 3.0 EV.

Note

- The last shot is shown on the Auto Review.

When [ISO AUTO] is selected in [Manual Exposure] mode, the exposure is changed by adjusting the ISO value. If a setting other than [ISO AUTO] is selected, the exposure is changed by adjusting the shutter speed.

- When you adjust the exposure, the exposure is shifted based on the compensated value.
- When the flash is used, the product performs flash bracket shooting, which shifts the amount of flash light even if [Cont. Bracket] is selected. Press the shutter button for each image.

4-543-698-11(1)

Copyright 2014 Sony Corporation



Interchangeable Lens Digital Camera
ILCE-5100

Single Bracket

Shoots multiple images while automatically shifting the exposure from base to darker and then to lighter. Press the shutter button for each image. You can select an image that suits your purpose after recording.

1. MENU →  (Camera Settings) → [Drive Mode] → [Single Bracket].
2. Select the desired mode using the right/left side of the control wheel.

Menu item details

 Single Bracket: 0.3EV 3 Image (default setting):

This setting shoots a total of three images in a row with an exposure value shifted by plus or minus 0.3 EV.

 Single Bracket: 0.3EV 5 Image:

This setting shoots a total of five images in a row with an exposure value shifted by plus or minus 0.3 EV.

 Single Bracket: 0.5EV 3 Image:

This setting shoots a total of three images in a row with an exposure value shifted by plus or minus 0.5 EV.

 Single Bracket: 0.5EV 5 Image:

This setting shoots a total of five images in a row with an exposure value shifted by plus or minus 0.5 EV.

 Single Bracket: 0.7EV 3 Image:

This setting shoots a total of three images in a row with an exposure value shifted by plus or minus 0.7 EV.

 Single Bracket: 0.7EV 5 Image:

This setting shoots a total of five images in a row with an exposure value shifted by plus or minus 0.7 EV.

 Single Bracket: 1.0EV 3 Image:

This setting shoots a total of three images in a row with an exposure value shifted by plus or minus 1.0 EV.

 Single Bracket: 2.0EV 3 Image:

This setting shoots a total of three images in a row with an exposure value shifted by plus or minus 2.0 EV.

 Single Bracket: 3.0EV 3 Image:

This setting shoots a total of three images in a row with an exposure value shifted by plus or minus 3.0 EV.

Note

- When [ISO AUTO] is selected in [Manual Exposure] mode, the exposure is changed by adjusting the ISO value. If a setting other than [ISO AUTO] is selected, the exposure is changed by adjusting the shutter speed.

When you adjust the exposure, the exposure is shifted based on the compensated value.

4-543-698-11(1)

Copyright 2014 Sony Corporation



Interchangeable Lens Digital Camera
ILCE-5100

WB bracket

Shoots three images, each with different color tones according to the selected settings of white balance, color temperature and color filter.

1. MENU →  (Camera Settings) → [Drive Mode] → [WB bracket].
2. Select the desired mode using the right/left side of the control wheel.

Menu item details

 White Balance Bracket: Lo (default setting):

Records a series of three images with small changes in the white balance.

 White Balance Bracket: Hi:

Records a series of three images with large changes in the white balance.

Note

- The last shot is shown on the Auto Review.

4-543-698-11(1)

Copyright 2014 Sony Corporation

Interchangeable Lens Digital Camera
ILCE-5100

DRO Bracket

You can record a total of three images, each at a different degree of D-Range Optimizer value.

1. MENU →  (Camera Settings) → [Drive Mode] → [DRO Bracket].
2. Select the desired mode using the right/left side of the control wheel.

Menu item details

 DRO Bracket: Lo (default setting):

Records a series of three images with small changes in the D-Range Optimizer value.

 DRO Bracket: Hi:

Records a series of three images with large changes in the D-Range Optimizer value.

Note

- The last shot is shown on the Auto Review.

Interchangeable Lens Digital Camera
ILCE-5100

Self-portrait/ -timer

You can change the angle of the LCD screen and shoot images while monitoring the image on the screen.

1. MENU →  (Custom Settings) → [Self-portrait/ -timer] → [On].
2. Tilt the LCD screen 180° upward, and then point the lens at yourself.

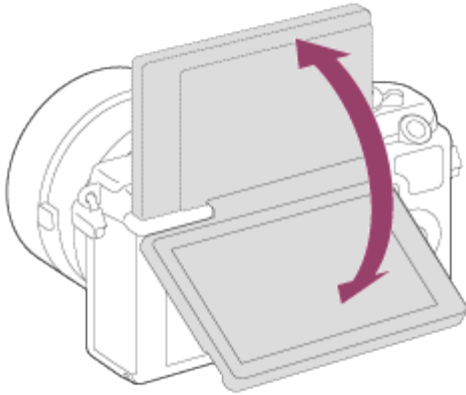

3. Press the shutter button.
The product starts the self-timer shooting after three seconds.

Hint

- If you want to use another Drive Mode than the 3-second self-timer mode, first set [Self-portrait/ -timer] to [Off], then tilt the monitor upward approx. 180 degrees.

4-543-698-11(1)

Copyright 2014 Sony Corporation

Interchangeable Lens Digital Camera
ILCE-5100

ISO

Sensitivity to light is expressed by the ISO number (recommended exposure index). The larger the number, the higher the sensitivity.

1. MENU →  (Camera Settings) → [ISO] → desired setting.

Menu item details

ISO AUTO (default setting):

Sets the ISO sensitivity automatically.

100 / 125 / 160 / 200 / 250 / 320 / 400 / 500 / 640 / 800 / 1000 / 1250 / 1600 / 2000 / 2500 / 3200 / 4000 / 5000 / 6400 / 8000 / 10000 / 12800 / 16000 / 20000 / 25600:

You can reduce image blurring in dark locations or with moving subjects by increasing the ISO sensitivity (select a larger number).

Note

- [ISO AUTO] is selected when using the following functions:
 - [Intelligent Auto]
 - [Superior Auto]
 - [Scene Selection]
 - [Sweep Panorama]
- The higher the ISO value, the more noise will appear on the images.
- When shooting movies, ISO values between ISO 100 and ISO 12800 are available. If the ISO value is set to larger value than ISO 12800, the setting is automatically switched to ISO 12800. When you finished the movie recording, the ISO value returns to the original setting.



Interchangeable Lens Digital Camera
ILCE-5100

D-Range Opt. (DRO)

By dividing the image into small areas, the product analyzes the contrast of light and shadow between the subject and the background, and creates an image with the optimal brightness and gradation.

1. MENU →  (Camera Settings) → [DRO/Auto HDR] → [D-Range Opt.].
2. Select the desired setting using the left/right side of the control wheel.

Menu item details

 D-Range Optimizer: Auto (default setting):

Corrects the brightness automatically.

 D-Range Optimizer: Lv1 — D-Range Optimizer: Lv5:

Optimizes the gradation of a recorded image for each divided area. Select the optimization level from Lv1 (weak) to Lv5 (strong).

Note

- [DRO/Auto HDR] is fixed to [Off] when the shooting mode is set to [Sweep Panorama], or when [Picture Effect] is used.
- [DRO/Auto HDR] is fixed to [Off] when [Sunset], [Night Scene], [Night Portrait], [Hand-held Twilight] or [Anti Motion Blur] is selected in [Scene Selection]. The setting is fixed to [D-Range Optimizer: Auto] when other modes are selected in [Scene Selection].
- When shooting with [D-Range Opt.], the image may be noisy. Select the proper level by checking the recorded image, especially when you enhance the effect.



Interchangeable Lens Digital Camera
ILCE-5100

Auto HDR

Widens the range (gradation) so that you can record from bright parts to dark parts with correct brightness (HDR: High Dynamic Range). One image with proper exposure and one overlaid image are recorded.

1. MENU →  (Camera Settings) → [DRO/Auto HDR] → [Auto HDR].
2. Select the desired setting using the left/right side of the control wheel.

Menu item details

 Auto HDR: Exposure Diff. Auto (default setting):

Corrects the exposure difference automatically.

 Auto HDR: Exposure Diff. 1.0EV — Auto HDR: Exposure Diff. 6.0EV:

Sets the exposure difference, based on the contrast of the subject. Select the optimal level between 1.0 EV (weak) and 6.0 EV (strong).

For example, if you set the exposure value to 2.0 EV, three images will be composed with the following exposure levels; -1.0 EV, optimal exposure and +1.0 EV.

Note

- [Auto HDR] is not available for RAW images.
- When the shooting mode is set to [Intelligent Auto], [Superior Auto], [Sweep Panorama] or [Scene Selection], you cannot select [Auto HDR].
- When using [Picture Effect], you cannot select [Auto HDR].
- You cannot start the next shot until the capture process is completed after you shoot.
- You may not obtain the desired effect depending on the luminance difference of a subject and the shooting conditions.
- When the flash is used, this function has little effect.
- When the contrast of the scene is low or when product shake or subject blur occurs, you may not obtain good HDR images. If the product has detected a problem,  is displayed on the recorded image to inform you of this situation. Shoot again as necessary, paying attention to the contrast or blur.

Interchangeable Lens Digital Camera
ILCE-5100

White Balance

Adjusts the color tones according to the ambient light conditions. Use this feature when the color tones of the image did not come out as you expected, or when you want to change the color tones on purpose for photographic expression.

1. MENU →  (Camera Settings) → [White Balance] → desired setting.

Menu item details

AWB Auto (default setting):

The product automatically detects the light source and adjusts the color tones.

 Daylight:

The color tones are adjusted for the daylight.

 Shade:

The color tones are adjusted for shadiness.

 Cloudy:

The color temperature is adjusted for a cloudy sky.

 Incandescent:

The color temperature is adjusted for places under an incandescent lamp, or under bright lighting, such as in a photo studio.

-1 Fluor.: Warm White:

The color temperature is adjusted for warm white fluorescent lighting.

0 Fluor.: Cool White:

The color temperature is adjusted for white fluorescent lighting.

+1 Fluor.: Day White:

The color temperature is adjusted for neutral white fluorescent lighting.

+2 Fluor.: Daylight:

The color temperature is adjusted for daylight fluorescent lighting.

 Flash:

The color temperature is adjusted for flash light.

 Underwater Auto:

The color temperature is adjusted for underwater shooting.

C.Temp./Filter:

Adjusts the color tones depending on the light source. Achieves the effect of CC (Color Compensation) filters for photography.

Custom:

Uses the white balance setting saved in [Custom Setup].

SET Custom Setup:

Memorizes the basic white color under the light conditions for the shooting environment.

Hint

- You can use the right side of the control wheel to display the fine adjustment screen and perform fine adjustments of the color temperature as required.
- In [C.Temp./Filter], you can use the right button to display the color temperature setting screen and perform a setting. When you press the right button again, the fine adjustment screen appears to allow you perform fine adjustments as required.

Note

- [White Balance] is fixed to [Auto] in the following situations:
 - [Intelligent Auto]
 - [Superior Auto]
 - [Scene Selection]

Related Topic

- [Capturing a basic white color in \[Custom Setup\] mode](#)



4-543-698-11(1)

Copyright 2014 Sony Corporation

Interchangeable Lens Digital Camera
ILCE-5100

Capturing a basic white color in [Custom Setup] mode

In a scene where the ambient light consists of multiple types of light sources, it is recommended to use the custom white balance in order to accurately reproduce the whiteness.

1. MENU →  (Camera Settings) → [White Balance] → [Custom Setup].
2. Hold the product so that the white area fully covers the AF area located in the center, and then press  on the center of the control wheel.
The calibrated values (Color Temperature and Color Filter) are displayed and registered.

Note

- The message [Custom WB Error] indicates that the value is higher than the expected range, when the flash is used on a subject with too bright colors in the frame. If you register this value, the  indicator turns orange on the recording information display. You can shoot at this point, but it is recommended that you set the white balance again to get a more accurate white balance value.

4-543-698-11(1)

Copyright 2014 Sony Corporation

Interchangeable Lens Digital Camera
ILCE-5100

Picture Effect

Select the desired effect filter to achieve more impressive and artistic images.

1. MENU →  (Camera Settings) → [Picture Effect] → desired setting.

Menu item details

 Off (default setting):

Disables the [Picture Effect] function.

 Toy Camera:

Creates a soft image with shaded corners and reduced sharpness.

 Pop Color:

Creates a vivid look by emphasizing color tones.

 Posterization:

Creates a high contrast, abstract look by heavily emphasizing primary colors, or in black and white.

 Retro Photo:

Creates the look of an aged photo with sepia color tones and faded contrast.

 Soft High-key:

Creates an image with the indicated atmosphere: bright, transparent, ethereal, tender, soft.

 Partial Color:

Creates an image which retains a specific color, but converts others to black and white.

 High Contrast Mono.:

Creates a high-contrast image in black and white.

 Soft Focus:

Creates an image filled with a soft lighting effect.

 HDR Painting:

Creates the look of a painting, enhancing the colors and details.

 Rich-tone Mono.:

Creates an image in black and white with rich gradation and reproduction of details.

 Miniature:

Creates an image which enhances the subject vividly, with the background defocused considerably. This effect may

often be found in pictures of miniature models.

 Watercolor:

Creates an image with ink bleed and blurring effects as if painted using watercolors.

 Illustration:



Creates an illustration-like image by emphasizing the outlines.

Hint

- You can perform detailed settings for the following [Picture Effect] modes using the left/right side of the control wheel.
 - [Toy Camera]
 - [Posterization]
 - [Partial Color]
 - [Soft Focus]
 - [HDR Painting]
 - [Miniature]
 - [Illustration]

Note

- When [Partial Color] is selected, images may not retain the selected color, depending on the subject or shooting conditions.
- You cannot check the following effects on the shooting screen, because the product processes the image after the shot. Also, you cannot shoot another image until image processing is finished. You cannot use these effects with movies.
 - [Soft Focus]
 - [HDR Painting]
 - [Rich-tone Mono.]
 - [Miniature]
 - [Watercolor]
 - [Illustration]
- In the case of [HDR Painting] and [Rich-tone Mono.], the shutter is released three times for one shot. Be careful about the following:
 - Use this function when the subject is motionless or does not flash light.
 - Do not change the composition before shooting.

When the contrast of the scene is low or when significant camera-shake or subject blur has occurred, you may not be able to obtain good HDR images. If the product detects such a situation,  /  appear on the recorded image to inform you of this situation. If necessary, change the composition or otherwise adjust the settings, be careful of blurring, and shoot again.

- [Picture Effect] cannot be set when [ Quality] is set to [RAW] or [RAW & JPEG].

Interchangeable Lens Digital Camera
ILCE-5100

Creative Style

Allows you to select the desired image processing. You can adjust exposure (shutter speed and aperture) as you like with [Creative Style], unlike with [Scene Selection] where the product adjusts the exposure.

1. MENU →  (Camera Settings) → [Creative Style] → desired setting.

Menu item details

Std.† Standard (default setting):

For shooting various scenes with rich gradation and beautiful colors.

Vivid† Vivid:

The saturation and contrast are heightened for shooting striking images of colorful scenes and subjects such as flowers, spring greenery, blue sky, or ocean views.

Port.† Portrait:

For shooting the skin color in a soft tone, ideally suited for shooting portraits.

Land.† Landscape:

The saturation, contrast, and sharpness are heightened for shooting vivid and crisp scenery. Distant landscapes also stand out more.

Sunset† Sunset:

For shooting the beautiful red of the setting sun.

B/W† Black & White:

For shooting images in black and white monotone.

Sepia† Sepia:

For shooting images in sepia monotone.

To set [Contrast], [Saturation] and [Sharpness]

[Contrast], [Saturation] and [Sharpness] can be adjusted for each [Creative Style] item.

Select an item to be set by pressing the right/left side of the control wheel, then set the value using the top/bottom side of the control wheel.

 Contrast:

The higher the value selected, the more the difference of light and shadow is accentuated, and the bigger the effect on the image.

 Saturation:

The higher the value selected, the more vivid the color. When a lower value is selected, the color of the image is restrained and subdued.

Sharpness:

Adjusts the sharpness. The higher the value selected, the more the contours are accentuated, and the lower the value selected, the more the contours are softened.

Note

- [Standard] is selected when using the following functions:
 - [Intelligent Auto]
 - [Superior Auto]
 - [Scene Selection]
 - [Picture Effect]
- When [Creative Style] is set to [Black & White] or [Sepia], [Saturation] cannot be adjusted.

4-543-698-11(1)

Copyright 2014 Sony Corporation

Interchangeable Lens Digital Camera
ILCE-5100

Movie recording formats

You can use the movie recording format "XAVC S" with this camera. For details on the "XAVC S" format, see the following description.

What is XAVC S?

Records high-definition movies by converting them to MP4 movies using the MPEG-4 AVC/H.264 codec. MPEG-4 AVC/H.264 is capable of compressing images at higher efficiency. You can record high-quality images while reducing the amount of data.

XAVC S/AVCHD recording format

XAVC S:

Bit-rate: Approx. 50 Mbps^{*1}

Records a more vivid movie compared to AVCHD with increased amounts of information.

AVCHD:

Bit-rate: Approx. 28Mbps^{*2}

The AVCHD format has a high degree of compatibility with storage devices other than computers.

- Bit rate is the amount of the data processed within a given length of time.

^{*1}Average

^{*2}Maximum



Related Topic

- [File Format \(movie\)](#)
- [Record Setting \(movie\)](#)

Interchangeable Lens Digital Camera
ILCE-5100

File Format (movie)

Selects the movie file format.



1. MENU →  (Camera Settings) → [ File Format] → desired setting.

Menu item details

XAVC S:

Records HD movies in XAVC S format. This file format is suitable for high bit rates.

Audio: LPCM

- You cannot create discs using the software PlayMemories Home with movies that are recorded with [ File Format] set to [XAVC S].
- In order to record movies with [ File Format] set to [XAVC S], you need an SDXC memory card with a capacity of at least 64 GB (Class 10 or faster), a UHS-I compatible SDXC memory card with at least 64 GB, or a Memory Stick XC-HG Duo media.

AVCHD (default setting):

Records HD movies in AVCHD format. This file format is suitable for high-definition TV.

You can create a Blu-ray Disc, an AVCHD recording disc, or a DVD-Video disc using the software PlayMemories Home.

Audio: Dolby Digital

MP4:

Records mp4 (AVC) movies. This format is suitable for WEB uploads, e-mail attachments, etc.



Audio: AAC

- You cannot create a disc using the software PlayMemories Home with a movie that was recorded when [ File Format] was set to [MP4].

Interchangeable Lens Digital Camera
 ILCE-5100

Record Setting (movie)

Selects the image size, frame rate, and image quality for movie recording. The higher the bit-rate, the higher the image quality.

1. MENU →  (Camera Settings) → [ Record Setting] → desired setting.

When [ File Format] is set to [XAVC S]

Records high-definition movies by converting them to MP4 file format using the MPEG-4 AVC/H.264 codec.

When [ File Format] is set to [AVCHD]

60i/50i: Movies are recorded at approximately 60 fields/sec (for 1080 60i-compatible devices) or 50 fields/sec (for 1080 50i-compatible devices), in interlaced mode, with Dolby Digital audio, in AVCHD format.

24p/25p: Movies are recorded at approximately 24 frames/sec (for 1080 60i-compatible devices) or 25 frames/sec (for 1080 50i-compatible devices), in progressive mode, with Dolby Digital audio, in AVCHD format.

60p/50p: Movies are recorded at approximately 60 frames/sec (for 1080 60i-compatible devices) or 50 frames/sec (for 1080 50i-compatible devices), in progressive mode, with Dolby Digital audio, in AVCHD format.

When [ File Format] is set to [MP4]

Movies shot are recorded in MPEG-4 format, at approximately 30 frames/sec (for 1080 60i-compatible devices) or approximately 25 frames/sec (for 1080 50i-compatible devices), in progressive mode, with AAC audio, mp4 format.

Menu items details

When [ File Format] is set to [XAVC S]

60p 50M^{*}/50p 50M^{**} (default setting):

Records high image quality movies at 1920 × 1080 (60p/50p).

Bit-rate: Approx. 50 Mbps (Avg.)

30p 50M/25p 50M^{**}:

Records high image quality movies at 1920 × 1080 (30p/25p).

Bit-rate: Approx. 50 Mbps (Avg.)

24p 50M (Only for 1080 60i compatible models):

Records high image quality movies at 1920 × 1080 (24p). This produces a cinema-like atmosphere.

Bit-rate: Approx. 50 Mbps (Avg.)

When [ File Format] is set to [AVCHD]

60i 24M(FX)*:

50i 24M(FX)**:

Records high image quality movies of 1920 × 1080 (60i/50i).

Bit-rate: Approx. 24 Mbps (Max.)

60i 17M(FH) (default setting)*:

50i 17M(FH) (default setting)**:

Records standard image quality movies of 1920 × 1080 (60i/50i).

Bit-rate: Approx. 17 Mbps (Avg.)

60p 28M(PS)*:

50p 28M(PS)**:

Records the highest image quality movies of 1920 × 1080 (60p/50p).

Bit-rate: Approx. 28 Mbps (Max.)

24p 24M(FX)*:

25p 24M(FX)**:

Records high image quality movies of 1920 × 1080 (24p/25p). This produces a cinema-like atmosphere.

Bit-rate: Approx. 24 Mbps (Max.)

24p 17M(FH)*:

25p 17M(FH)**:

Records standard image quality movies of 1920 × 1080 (24p/25p). This produces a cinema-like atmosphere.

Bit-rate: Approx. 17 Mbps (Avg.)

When [ File Format] is set to [MP4]

1440×1080 12M (default setting):

Records movies of 1440 × 1080.

Bit-rate: Approx. 12 Mbps (Avg.)

VGA 3M:

Records movies of VGA size.

Bit-rate: Approx. 3 Mbps (Avg.)

* 1080 60i (NTSC) compatible device

** 1080 50i (PAL) compatible device

Note

- 60p/50p movies can be played back only on compatible devices.
- Movies recorded with the [60p 28M(PS)]/[50p 28M(PS)]/[60i 24M(FX)]/[50i 24M(FX)]/[24p 24M(FX)]/[25p 24M(FX)] setting in [ Record Setting] are converted by PlayMemories Home in order to create an AVCHD recording disc. This conversion can take a long time. Also, you cannot create a disc in the original image quality. If you want to keep the original image quality, store your movies on a Blu-ray Disc.
- To play back 24p/25p movies on a TV, the TV must be compatible with the 24p/25p formats. If the TV is not compatible with the 24p/25p format, 24p/25p movies will be output as 60i/50i movies.
- You cannot create discs with movies recorded with [XAVC S] or [MP4] recording settings using PlayMemories Home.

Interchangeable Lens Digital Camera
ILCE-5100

Dual Video REC

Allows you to simultaneously record an XAVC S movie and an MP4 movie, or an AVCHD movie and an MP4 movie.

1. MENU →  (Camera Settings) → [Dual Video REC] → desired setting.

Menu item details



On:

An XAVC S movie and an MP4 movie, or an AVCHD movie and an MP4 movie, are recorded simultaneously.

Off (default setting):

The [Dual Video REC] function is not used.

Note

- When [ Record Setting] for an XAVC S movie is set to [60p]/[50p], [ Record Setting] for an AVCHD movie is set to [60p]/[50p], or [ File Format] is set to [MP4], the [Dual Video REC] function is set to [Off].
- If you select [Date View] in [View Mode] when playing back movies, XAVC S movies and MP4 movies, or AVCHD movies and MP4 movies are displayed side-by-side.



Related Topic

- [Record Setting \(movie\)](#)
- [View Mode](#)

Interchangeable Lens Digital Camera
ILCE-5100

Marker Display

Sets whether or not to display markers to enable alignment to a structure while shooting movies.

1. MENU →  (Custom Settings) → [ Marker Display] → desired setting.

Menu item details

On:

Markers are displayed. The markers are not recorded on the medium.

Off (default setting):

No marker is displayed.

Note

- You cannot display markers when using [Focus Magnifier].
- The markers are displayed on the screen. (You cannot output the markers.)



4-543-698-11(1)

Copyright 2014 Sony Corporation

Interchangeable Lens Digital Camera
ILCE-5100

Marker Settings

Sets the markers to be displayed while shooting movies.

1. MENU →  (Custom Settings) → [ Marker Settings] → desired setting.

Menu item details

Center:

Sets whether or not to display the center marker in the center of the shooting screen.

Off (default setting) / On

Aspect:

Sets the aspect marker display.

Off (default setting) / 4:3 / 13:9 / 14:9 / 15:9 / 1.66:1 / 1.85:1 / 2.35:1

Safety Zone:

Sets the safety zone display. This becomes the standard range that can be received by a general household TV.

Off (default setting) / 80% / 90%

Guideframe:

Sets whether or not to display the guide frame. You can verify whether the subject is level or perpendicular to the ground.

Off (default setting) / On

Hint

- You can display all the markers at the same time.
- Place the subject on the cross point of the [Guideframe] to make a balanced composition.

Interchangeable Lens Digital Camera
ILCE-5100

Audio Recording

Sets whether to record sounds when shooting movies.

1. MENU →  (Camera Settings) → [Audio Recording] → desired setting.

Menu item details

On (default setting):

Records sound (stereo).

Off:

Does not record sound.

Note

- The noise of the lens and the product in operation will also be recorded, when [On] is selected.

4-543-698-11(1)

Copyright 2014 Sony Corporation

Interchangeable Lens Digital Camera
ILCE-5100

Wind Noise Reduct.

Sets whether or not to reduce wind noise during movie recording.

1. MENU →  (Camera Settings) → [Wind Noise Reduct.] → desired setting.

Menu item details

On:

Reduces wind noise.

Off (default setting):

Does not reduce wind noise.

Note

- Setting this item to [On] where wind is not blowing sufficiently hard may cause normal sound to be recorded with too low volume.



4-543-698-11(1)

Copyright 2014 Sony Corporation

Interchangeable Lens Digital Camera
ILCE-5100

Auto Slow Shut. (movie)

Sets whether or not to adjust the shutter speed automatically when recording movies if the subject is dark.

1. MENU →  (Camera Settings) → [ Auto Slow Shut.] → desired setting.

Menu item details

On (default setting):

Uses [ Auto Slow Shut.]. The shutter speed automatically slows when recording in dark locations. You can reduce noise in the movie by using a slow shutter speed when recording in dark locations.

Off:

Does not use [ Auto Slow Shut.]. The recorded movie will be darker than when [On] is selected, but you can record movies with smoother motion and less object blur.

Note

- [ Auto Slow Shut.] does not function in the following situations:
 - When [Movie] in shooting mode is set to [Shutter Priority] or [Manual Exposure].

4-543-698-11(1)

Copyright 2014 Sony Corporation

Interchangeable Lens Digital Camera
ILCE-5100

MOVIE Button

Sets whether or not to activate the MOVIE button.

1. MENU →  (Custom Settings) → [MOVIE Button] → desired setting.

Menu item details

Always (default setting):

Starts movie recording when you press the MOVIE button in any mode.

Movie Mode Only:

Starts movie recording when you press the MOVIE button only if the shooting mode is set to [Movie] mode.

4-543-698-11(1)

Copyright 2014 Sony Corporation



Interchangeable Lens Digital Camera
ILCE-5100

Custom Key Settings

Assigning functions to the various keys allows you to speed up operations by pressing the appropriate key when the shooting information screen is displayed.

1. MENU →  (Custom Settings) → [Custom Key Settings] → set a function to the desired key.

Note

- Some functions cannot be assigned to certain keys.

Related Topic

- [Function of the center button](#)
- [Function of the left button](#)
- [Function of the right button](#)
- [Function of the down button](#)
- [Function of the ? button](#)

4-543-698-11(1)

Copyright 2014 Sony Corporation

Interchangeable Lens Digital Camera
ILCE-5100

Function of the center button

Once you assign a function to the center button, you can perform that function by simply pressing the center button when the shooting information screen is displayed.

1. MENU →  (Custom Settings) → [Custom Key Settings] → [Center Button] → desired setting.

The functions that can be assigned are displayed on the setup item selection screen.

4-543-698-11(1)

Copyright 2014 Sony Corporation

Interchangeable Lens Digital Camera
ILCE-5100

Function of the left button

Once you assign a function to the left button, you can perform that function by simply pressing the left button when the shooting information screen is displayed.

1. MENU →  (Custom Settings) → [Custom Key Settings] → [Left Button] → desired setting.

The functions that can be assigned are displayed on the setup item selection screen.

4-543-698-11(1)

Copyright 2014 Sony Corporation

Interchangeable Lens Digital Camera
ILCE-5100

Function of the right button

Once you assign a function to the right button, you can perform that function by simply pressing the right button when the shooting information screen is displayed.

1. MENU →  (Custom Settings) → [Custom Key Settings] → [Right Button] → desired setting.

The functions that can be assigned are displayed on the setup item selection screen.

4-543-698-11(1)

Copyright 2014 Sony Corporation

Interchangeable Lens Digital Camera
ILCE-5100

Function of the down button

Once you assign a function to the down button, you can perform that function by simply pressing the down button when the shooting information screen is displayed.

1. MENU →  (Custom Settings) → [Custom Key Settings] → [Down Button] → desired setting.

The functions that can be assigned are displayed on the setup item selection screen.

4-543-698-11(1)

Copyright 2014 Sony Corporation

Interchangeable Lens Digital Camera
ILCE-5100

Function of the ? button

Once you assign a function to the ? (question mark) button, you can perform that function by simply pressing the ? (question mark) button when the shooting information screen is displayed.

1. MENU →  (Custom Settings) → [Custom Key Settings] → [ button] → desired setting.



The functions that can be assigned are displayed on the setup item selection screen of the product.

4-543-698-11(1)

Copyright 2014 Sony Corporation

Interchangeable Lens Digital Camera
ILCE-5100

Photo Creativity

[Photo Creativity] is a mode that allows you to operate the camera intuitively with a different screen display. When the shooting mode is set to  (Intelligent Auto) or , you can change the settings easily and shoot images.

1. Set the shooting mode to  (Intelligent Auto) or .

2. Press  (Photo Creativity) on the control wheel.

3. Select the item to be changed using the control wheel.

 (Bkground Defocus):

Adjusts the blurring of the background.

 (Brightness):

Adjusts brightness.

 (Color):

Adjusts color.







 (Vividness):

Adjusts vividness.

 (Picture Effect):

You can select a desired effect and shoot images with the specific texture.

4. Select the desired settings.

- You can use some settings together by repeating steps 3 and 4.
- To reset the changed settings to the default settings, press the  (Delete) button.  (Bkground Defocus),  (Brightness),  (Color) and  (Vividness) are set to [AUTO], and  (Picture Effect) is set to .

5. For shooting still images: Press the shutter button.

When recording movies: Press the MOVIE button to start recording.

Note

- When [Quality] is set to [RAW] or [RAW & JPEG], you cannot use [Photo Creativity].
- When you record movies using the [Photo Creativity] function, you can change the  (Bkground Defocus) settings only.

- If you switch the shooting mode to [Intelligent Auto] mode or [Superior Auto] mode, or turn off the product, the settings you have changed revert to the default settings.
- When the shooting mode is set to [Superior Auto], and you use [Photo Creativity], the product does not perform the overlay processing of images.

Related Topic

● [Picture Effect](#)

4-543-698-11(1)

Copyright 2014 Sony Corporation

Interchangeable Lens Digital Camera
ILCE-5100

Smile/Face Detect.

Detects the faces of your subjects and adjusts the focus, exposure, flash settings and performs image processing automatically.

1. MENU →  (Camera Settings) → [Smile/Face Detect.] → desired setting.

Menu item details

 Off:

Does not use the Face Detection function.

 On (Regist. Faces) (default setting):

Detects the registered face with higher priority using [Face Registration].

 On:

Detects a face without giving higher priority to the registered face.

 Smile Shutter:

Automatically detects and shoots a smile.

Face Detection frame

- When the product detects a face, the gray face detection frame appears. When the product determines that autofocus is enabled, the face detection frame turns white. When you press the shutter button halfway down, the frame turns green.
- In case you have registered the priority order for each face using [Face Registration], the product automatically selects the first prioritized face and the face detection frame over that face turns white. The face detection frames of other registered faces turn reddish-purple.



Tips for capturing smiles more effectively

- Do not cover the eyes with front hair and keep the eyes narrowed.
- Do not obscure the face by a hat, masks, sunglasses, etc.

Try to orient the face in front of the product and be as level as possible.

- Give a clear smile with an open mouth. The smile is easier to be detected when the teeth are shown.
- If you press the shutter button during Smile Shutter, the product shoots the image. After shooting, the product returns to Smile Shutter mode.

Hint

- When the [Smile/Face Detect.] is set to [Smile Shutter], you can select the Smile Detection Sensitivity from [On: Slight Smile], [On: Normal Smile] and [On: Big Smile].

Note

- You cannot use the Face Detection function with the following functions:
 - When using zoom functions other than the optical zoom
 - [Sweep Panorama]
 - [Picture Effect] is set to [Posterization].
 - When using the [Focus Magnifier] function.
 - [Scene Selection] is set to [Landscape], [Night Scene] or [Sunset].
- Up to eight faces of your subjects can be detected.
- The product may not detect faces at all or may accidentally detect other objects as faces in some conditions.
- If the product cannot detect a face, set the Smile Detection Sensitivity.



4-543-698-11(1)

Copyright 2014 Sony Corporation

Interchangeable Lens Digital Camera
ILCE-5100

Soft Skin Effect (still image)

Sets the effect used for shooting the skin smoothly in the Face Detection function.

1. MENU →  (Camera Settings) → [ Soft Skin Effect] → desired setting.

Menu item details

 Off (default setting):

Does not use the [ Soft Skin Effect] function.

 On:

Uses the [ Soft Skin Effect].

Hint

- When [ Soft Skin Effect] is set to [On], you can select the effect level.

Note

- [ Soft Skin Effect] is not available for RAW images.

4-543-698-11(1)

Copyright 2014 Sony Corporation



Interchangeable Lens Digital Camera
ILCE-5100

Face Registration (New Registration)

If you register faces in advance, the product can detect the registered face as a priority when [Smile/Face Detect.] is set to [On (Regist. Faces)].

1. MENU →  (Custom Settings) → [Face Registration] → [New Registration].
2. Align the guide frame with the face to be registered, and press the shutter button.
3. When a confirmation message appears, select [Enter].

Note

- Up to eight faces can be registered.
- Shoot the face from the front in a brightly lit place. The face may not be registered correctly if it is obscured by a hat, a mask, sunglasses, etc.

4-543-698-11(1)

Copyright 2014 Sony Corporation



Interchangeable Lens Digital Camera
ILCE-5100

Face Registration (Order Exchanging)

When multiple faces are registered to be given priority, the face registered first will be given priority. You can change the priority order.

1. MENU → (Custom Settings) → [Face Registration] → [Order Exchanging].
2. Select a face to change the order of priority.
3. Select the destination.

4-543-698-11(1)

Copyright 2014 Sony Corporation

Interchangeable Lens Digital Camera
ILCE-5100

Face Registration (Delete)

Deletes a registered face.

1. MENU →  (Custom Settings) → [Face Registration] → [Delete].
If you select [Delete All], you can delete all registered faces.

Note

- Even if you execute [Delete], the data for registered face will remain in the product. To delete the data for registered faces from the product, select [Delete All].

4-543-698-11(1)

Copyright 2014 Sony Corporation

Interchangeable Lens Digital Camera
ILCE-5100

Red Eye Reduction

When using the flash, it is fired two or more times before shooting to reduce the red-eye phenomenon.

1. MENU →  (Camera Settings) → [Red Eye Reduction] → desired setting.

Menu item details

On:

The flash is always fired to reduce the red-eye phenomenon.

Off (default setting):

Does not use Red Eye Reduction.

Note

- Red Eye Reduction may not produce the desired effects. It depends on individual differences and conditions, such as distance to the subject, or whether the subject looks at the pre-strobe or not.

4-543-698-11(1)

Copyright 2014 Sony Corporation

Interchangeable Lens Digital Camera
ILCE-5100

Auto Obj. Framing (still image)

When this product detects and shoots faces, macro shooting subjects or subjects that are tracked by [Lock-on AF], the product automatically trims the image into an appropriate composition, and then saves it. Both the original and the trimmed images are saved. The trimmed image is recorded in the same size as the original image size.

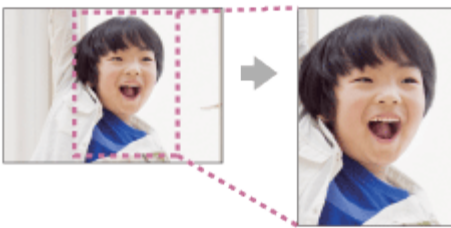

1. MENU →  (Camera Settings) → [ Auto Obj. Framing] → desired setting.

Menu item details



Off:

Does not trim images.

Auto (default setting):

Automatically trims images into an appropriate composition.

Note

- The trimmed image may not be the best possible composition, depending on the shooting conditions.
- [ Auto Obj. Framing] cannot be set when [ Quality] is set to [RAW] or [RAW & JPEG].

4-543-698-11(1)

Copyright 2014 Sony Corporation

Interchangeable Lens Digital Camera
ILCE-5100

SteadyShot

Sets whether or not to use the SteadyShot function.

1. MENU →  (Camera Settings) → [SteadyShot] → desired setting.

Menu item details

On (default setting):

Uses [SteadyShot].

Off:

Does not use [SteadyShot].

We recommend that you set [SteadyShot] to [Off] when using a tripod.

Note

- You cannot set [SteadyShot] when you are using an A-mount lens (sold separately), or when the name of the attached lens does not contain the letters “OSS,” such as “E16mm F2.8.”

4-543-698-11(1)



Copyright 2014 Sony Corporation



Interchangeable Lens Digital Camera
ILCE-5100

High ISO NR (still image)

When shooting with high ISO sensitivity, the product reduces noise that becomes more noticeable when the product sensitivity is high. A message may be displayed during noise reduction processing; you cannot shoot another image until the message disappears.

1. MENU →  (Camera Settings) → [ High ISO NR] → desired setting.

Menu item details



Normal (default setting):

Activates high ISO noise reduction normally.

Low:

Activates high ISO noise reduction moderately. Select this to prioritize the timing of shooting.



Note

- [ High ISO NR] is not available in the following situations:
 - When the shooting mode is set to [Intelligent Auto], [Superior Auto] or [Sweep Panorama].
 - [Scene Selection]
- [ High ISO NR] is not available for RAW images.

Interchangeable Lens Digital Camera
ILCE-5100

Color Space (still image)

The way colors are represented using combinations of numbers or the range of color reproduction is called “color space.” You can change the color space depending on the purpose of the image.

1. MENU →  (Camera Settings) → [ Color Space] → desired setting.

Menu item details

sRGB (default setting):

This is the standard color space of the digital camera. Use [sRGB] in normal shooting, such as when you intend to print out the images without any modification.

AdobeRGB:

This color space has a wide range of color reproduction. When a large part of the subject is vivid green or red, Adobe RGB is effective. The file name of the image starts with “_DSC.”

Note

- [AdobeRGB] is for applications or printers that support color management and DCF2.0 option color space. Images may not be printed or viewed in the correct colors if you use applications or printers that do not support Adobe RGB.
- When displaying images that were recorded with [AdobeRGB] on this product or non-Adobe RGB-compliant devices, the images are displayed with low saturation.

Interchangeable Lens Digital Camera
ILCE-5100

Grid Line

Sets whether the grid line is displayed or not. The grid line will help you to adjust the composition of images.

1. MENU →  (Custom Settings) → [Grid Line] → desired setting.

Menu item details

Rule of 3rds Grid:

Place main subjects close to one of the grid lines that divide the image into thirds for a well-balanced composition.

Square Grid:

Square grids make it easier to confirm the horizontal level of your composition. This is suitable to determine the quality of the composition when shooting landscape, close-up, or duplicated images.

Diag. + Square Grid:

Place a subject on the diagonal line to express an uplifting and powerful feeling.

Off (default setting):

Does not display the grid line.



Interchangeable Lens Digital Camera
ILCE-5100

Auto Review

You can check the recorded image on the screen right after the shooting. You can also set the display time for Auto Review.

1. MENU →  (Custom Settings) → [Auto Review] → desired setting.

Menu item details

10 Sec/5 Sec/2 Sec (default setting):

Displays the recorded image on the screen right after shooting for the selected duration of time. If you perform a magnifying operation during Auto Review, you can check that image using the magnified scale.

Off:

Does not display the Auto Review.

Note

- When the product is enlarging an image using image processing, it may temporarily display the original image prior to enlarging and then display the enlarged image.
- The DISP (Display Setting) settings are applied for the Auto Review display.

Related Topic

- [Switching the screen display \(during playback\)](#)
- [Playback zoom](#)



Interchangeable Lens Digital Camera
ILCE-5100

Live View Display

Sets whether or not to show images altered with effects of the exposure compensation, white balance, [Creative Style], or [Picture Effect] on the screen.

1. MENU →  (Custom Settings) → [Live View Display] → desired setting.

Menu item details

Setting Effect ON (default setting):

Displays Live View in conditions close to what your picture will look like as a result of applying all your settings. This setting is useful when you want to shoot pictures while checking the results of the shot on the Live View screen.

Setting Effect OFF:

Shows Live View without the effects of exposure compensation, white balance, [Creative Style], or [Picture Effect]. When this setting is used, you can easily check the image composition.

Live View is always displayed with the appropriate brightness even in [Manual Exposure] mode.

When [Setting Effect OFF] is selected, the **VIEW** icon is displayed on the Live View screen.

Note

- When the shooting mode is set to [Intelligent Auto], [Superior Auto], [Sweep Panorama], [Movie] or [Scene Selection], [Live View Display] cannot be set to [Setting Effect OFF].
- When [Live View Display] is set to [Setting Effect ON], you may have difficulty checking the composition, as the Live View Display may seem too dark or too bright. If such a phenomenon occurs, set [Live View Display] to [Setting Effect OFF]. When [Live View Display] is set to [Setting Effect OFF], the brightness of the shot image will not be the same as that of the displayed Live View.

Hint

- When you use a third-party flash, such as a studio flash, Live View Display may be dark for some shutter speed settings. When [Live View Display] is set to [Setting Effect OFF], Live View Display will be displayed brightly, so that you can easily check the composition.

Interchangeable Lens Digital Camera
ILCE-5100

Release w/o Lens

Sets whether or not the shutter can be released when no lens is attached.

1. MENU →  (Custom Settings) → [Release w/o Lens] → desired setting.

Menu item details

Enable:

Releases the shutter when no lens is attached. Select [Enable] when attaching the product to an astronomical telescope, etc.

Disable (default setting):

Does not release the shutter when a lens is not attached.

Note

- Correct metering cannot be achieved when you use lenses that do not provide a lens contact, such as the lens of an astronomical telescope. In such cases, adjust the exposure manually by checking it on the recorded image.



Interchangeable Lens Digital Camera
ILCE-5100

S. Auto Img. Extract.

Sets whether or not to save all the images that were shot continuously in [Superior Auto].

1. MENU →  (Custom Settings) → [S. Auto Img. Extract.] → desired setting.

Menu item details

Auto (default setting):

Saves one appropriate image selected by the product.

Off:

Saves all of the images.

Note

- Even if you set [S. Auto Img. Extract.] to [Off] with [Hand-held Twilight] selected as the scene recognition mode, one combined image is saved.
- When the [ Auto Obj. Framing] function is activated, two images are saved even if you set [S. Auto Img. Extract.] to [Auto].

4-543-698-11(1)

Copyright 2014 Sony Corporation

Interchangeable Lens Digital Camera
ILCE-5100

Shading Comp.

Compensates for the shaded corners of the screen, caused by certain lens characteristics.

1. MENU →  (Custom Settings) → [Lens Comp.] → [Shading Comp.] → desired setting.

Menu item details

Auto (default setting):

Compensates for darker corners of the screen automatically.

Off:

Does not compensate for darker corners of the screen.

Note

- The [Shading Comp.] function is only available when an E-mount lens is mounted.
- The amount of light around the edges may not be corrected, depending on the lens type.

4-543-698-11(1)

Copyright 2014 Sony Corporation

Interchangeable Lens Digital Camera
ILCE-5100

Chro. Aber. Comp.

Reduces the color deviation at the corners of the screen, caused by certain lens characteristics.

1. MENU →  (Custom Settings) → [Lens Comp.] → [Chro. Aber. Comp.] → desired setting.

Menu item details

Auto (default setting):

Reduces the color deviation automatically.

Off:

Does not compensate for the color deviation.

Note

- The [Chro. Aber. Comp.] function is only available when an E-mount lens is mounted.

Interchangeable Lens Digital Camera
ILCE-5100

Distortion Comp.

Compensates for the distortion of the screen, caused by certain lens characteristics.

1. MENU →  (Custom Settings) → [Lens Comp.] → [Distortion Comp.] → desired setting.

Menu item details

Auto:

Compensates for distortion of the screen automatically.

Off (default setting):

Does not compensate for distortion of the screen.

Note

- The [Distortion Comp.] function is only available when an E-mount lens is mounted.
- Depending on the attached lens, [Distortion Comp.] is fixed to [Auto], and you cannot select [Off].

4-543-698-11(1)

Copyright 2014 Sony Corporation



Interchangeable Lens Digital Camera
ILCE-5100

Aperture Preview

With the monitor, you may see an image with an aperture that differs from the shooting result. Since the blurring of a subject changes if the aperture is changed, the blurriness of the actual picture will differ from the image you were viewing prior to shooting.

While you press and hold the key to which you assigned the [Aperture Preview] function, the aperture is stepped down to the set aperture value and you can check the blurriness prior to shooting.

1. MENU →  (Custom Settings) → [Custom Key Settings] → set the [Aperture Preview] function to the desired key.
2. Confirm the image by pressing the key to which [Aperture Preview] was assigned.

Hint

- Although you can change the aperture value during the preview, the subject may be defocused if you select a brighter aperture. We recommend that you adjust the focus again.

Note

- You cannot set the [Aperture Preview] function to [Left Button], [Right Button] or [Down Button].

Related Topic

- [Custom Key Settings](#)
- [Shot. Result Preview](#)



Interchangeable Lens Digital Camera
ILCE-5100

Shot. Result Preview

With the monitor, you may see an image with an aperture that differs from the shooting result. Since the blurring of a subject changes if the aperture is changed, the blurriness of the actual picture will differ from the image you were viewing prior to shooting. While pressing down the key to which [Shot. Result Preview] is assigned, you can check the image preview with the DRO, shutter speed, aperture and ISO sensitivity settings applied. Check the shooting result preview before shooting.

1. MENU →  (Custom Settings) → [Custom Key Settings] → set the [Shot. Result Preview] function to the desired key.
2. Confirm the image by pressing the key to which [Shot. Result Preview] was assigned.

Hint

- The DRO settings, shutter speed, aperture and ISO sensitivity settings you have set are reflected on the image for [Shot. Result Preview], but some effects cannot be previewed depending on the shooting settings. Even in that case, the settings you have selected will be applied to the images you shoot.

Note

- You cannot set the [Shot. Result Preview] function to [Left Button], [Right Button] or [Down Button].

Related Topic





- [Custom Key Settings](#)
- [Aperture Preview](#)



Interchangeable Lens Digital Camera
ILCE-5100

Shooting still images using touch operation (Touch Shutter)

The product automatically focuses on the point you touch and takes a still picture.

1. MENU →  (Custom Settings) → [ Touch Shoot. Set.] → [Touch Shutter]
2. Touch the  icon on the monitor while the shooting screen is displayed.
The mark to the left of the icon turns orange. To cancel [Touch Shutter], touch the  icon again.
3. Touch the subject to focus on.
When the subject you touched is in focus, a still image is recorded.

Hint

You can operate the shooting functions below by touching the monitor:

- Shooting burst images using the touch shutter
When [Drive Mode] is set to [Cont. Shooting], you can record burst images while touching the monitor.
- Shooting burst images of sports scenes using the touch shutter
When [Scene Selection] is set to [Sports Action], you can record burst images while touching the monitor.
- Shooting continuous bracket images using the touch shutter
The product shoots three images while automatically shifting the exposure from base, to darker, and then to lighter.
When [Drive Mode] is set to [Cont. Bracket], keep touching the monitor until the shooting ends.
After the recording you can select the image you prefer.

Note

- The [Touch Shutter] function is unavailable in the following situations:
 - When [Shoot Mode] is set to [Movie]
 - When [Shoot Mode] is set to [Sweep Panorama]
 - When [Scene Selection] is set to [Night Scene]
 - When [Smile/Face Detect.] is set to [Smile Shutter]
 - When [Focus Mode] is set to [Manual Focus]
 - When [Focus Area] is set to [Flexible Spot]
 - While using Digital Zoom
- You cannot shoot images using [Touch Shutter] with applications downloaded from the website.

Related Topic

- [Shooting still images](#)

- Cont. Shooting
- Scene Selection
- Cont. Bracket

4-543-698-11(1)

Copyright 2014 Sony Corporation

Interchangeable Lens Digital Camera
ILCE-5100

Taking pictures of yourself using touch operation (Self-portrait/ -timer)

You can change the angle of the monitor and shoot a self-portrait while watching the monitor.

1. MENU →  (Custom Settings) → [Self-portrait/ -timer] → [On]
2. Tilt the monitor approx. 180° upward.

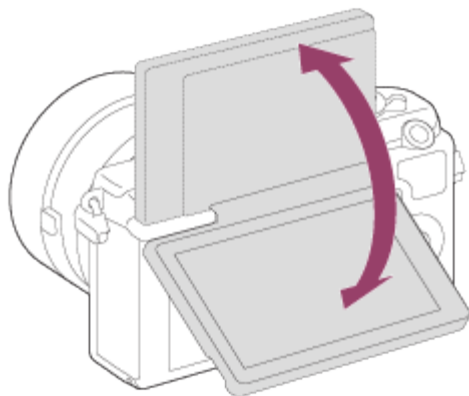

- Set [Focus Mode] to another mode than [Manual Focus]. The touch shutter function cannot be used when [Focus Mode] is set to [Manual Focus] mode.
 - Even if [ Touch Shoot. Set.] is set to [Touch Focus], if you tilt the monitor approx. 180° upward, you can use the touch shutter function.
3. Point the lens toward yourself, compose the shot, then touch the subject on the monitor.
The product records a still image after three seconds.

Note

- The [Touch Shutter] function is unavailable in the following situations:
 - When [Scene Selection] is set to [Night Scene]
 - When [Smile/Face Detect.] is set to [Smile Shutter]
 - When [Focus Mode] is set to [Manual Focus]
 - When [Focus Area] is set to [Flexible Spot]
 - While using Digital Zoom
- You cannot shoot images using [Touch Shutter] with applications downloaded from the website.







Interchangeable Lens Digital Camera
ILCE-5100

Adjusting the focus using touch operation (Touch Focus) (still image)

The product automatically focuses on the subject you touch on the monitor when shooting still images.





Specifying the desired focus point (Touch Focus)

A frame appears around the point you touched, and when you press the shutter button halfway down the product adjusts the focus within that frame.

1. MENU →  (Custom Settings) → [ Touch Shoot. Set.] → [Touch Focus]
2. MENU →  (Camera Settings) → [Center Lock-on AF] → [Off]
3. Touch the subject to focus on.
4. Press the shutter button fully down to shoot the image.
5. To cancel focusing, touch the  icon.

Tracking and focusing on the touched subject (Lock-on AF)

The product continuously tracks a designated moving subject.

1. MENU →  (Custom Settings) → [ Touch Shoot. Set.] → [Touch Focus]
2. MENU →  (Camera Settings) → [Center Lock-on AF] → [On] (default setting)
3. Touch the desired area to start [Lock-on AF].
4. Press the shutter button fully down to shoot the image.
5. To cancel [Lock-on AF], touch the  icon.

Displaying a magnified view of the touched subject (Focus Magnifier)

You can view an enlarged display in order to focus manually.

1. MENU →  (Camera Settings) → [Focus Mode] → [Manual Focus]
2. Touch the point to focus on.
3. Turn the focus ring to adjust the focus.
4. Press the shutter button fully down to shoot the image.

Hint

- To cancel the magnified view, press the shutter button lightly.

Note

- The [Touch Focus] function is unavailable in the following situations:
 - When [Shoot Mode] is set to [Sweep Panorama]
 - When [Scene Selection] is set to [Night Scene]

- When [Smile/Face Detect.] is set to [Smile Shutter]
- While using Digital Zoom
- You cannot shoot images using [Touch Focus] with applications downloaded from the website.

Related Topic

- [Focus Mode](#)
- [Center Lock-on AF](#)
- [Focus Magnifier](#)

4-543-698-11(1)

Copyright 2014 Sony Corporation





Interchangeable Lens Digital Camera
ILCE-5100

Adjusting the focus using touch operation (Touch Focus) (movie)

The product automatically focuses on the subject you touch on the monitor when shooting movies.



Tracking and focusing on the touched subject (Lock-on AF)

The product continuously tracks a designated moving subject.

1. MENU →  (Camera Settings) → [Center Lock-on AF] → [On] (default setting)
2. Touch the desired area to start [Lock-on AF] before/while recording a movie.
3. To cancel [Lock-on AF], touch the  icon.

Focusing on the touched subject (Spot Focus)

The product automatically focuses on the subject you touch on the monitor. The [Focus Mode] automatically switches to [Manual Focus].

1. MENU →  (Camera Settings) → [Center Lock-on AF] → [Off]
2. Touch the subject you want to focus on before/while recording the movie.
3. To cancel Spot Focus, touch the  icon.

Displaying a magnified view of the touched subject (Focus Magnifier)

You can view an enlarged display in order to focus manually.

1. MENU →  (Camera Settings) → [Focus Mode] → [Manual Focus]
2. Touch the point to focus on.
3. Turn the focus ring to adjust the focus.

Hint

- To cancel the magnified view, press the shutter button lightly.

Note

- The [Touch Focus] function is unavailable in the following situations:
 - While using Digital Zoom
- You cannot shoot images using [Touch Focus] with applications downloaded from the website.

Related Topic

 [Focus Mode](#)

- Center Lock-on AF

- Focus Magnifier

4-543-698-11(1)

Copyright 2014 Sony Corporation

Interchangeable Lens Digital Camera
ILCE-5100

Playing back images

Plays back the recorded images.

1. Press the  (Playback) button to switch to the playback mode.
2. Select the image with the control wheel.

Hint

- The product creates an image database file on a memory card to record and play back images. An image that is not registered in the image database file may not be played back correctly. To play back images shot using other devices, register those images to the image database file using MENU → [Setup] → [Recover Image DB].

Related Topic

 [Recover Image DB](#)

4-543-698-11(1)

Copyright 2014 Sony Corporation

Interchangeable Lens Digital Camera
ILCE-5100

Playback zoom

Enlarges the image being played back.

1. Display the image you want to enlarge, and slide the W/T (zoom) lever to the T side.
 - If the image is too large, slide the W/T (zoom) lever to the W side to adjust the zoom scale.
2. Select the portion you want to enlarge by pressing the top/bottom/right/left side of the control wheel.
3. Press the MENU button, or  in the center of the control wheel to exit the playback zoom.

Hint

- You can also enlarge an image being played back using MENU.

Note

- You cannot enlarge movies.

4-543-698-11(1)

Copyright 2014 Sony Corporation

Interchangeable Lens Digital Camera
ILCE-5100

Image Index

You can display multiple images at the same time in playback mode.

1. Slide the W/T (zoom) lever to the W side while the image is being played back.
To change the number of images to be displayed
MENU →  (Playback) → [Image Index] → desired setting.

Menu item details

12 Images (default setting)/30 Images

To return to single-image playback

Select the desired image and press  on the center of the control wheel.

To display a desired image quickly

Select the bar on the left of the image index screen using the control wheel, then press the top/bottom side of the control wheel. While the bar is being selected, you can display the calendar screen or folder selection screen by pressing  in the center. In addition, you can switch View Mode by selecting an icon.

Related Topic

 [View Mode](#)

Interchangeable Lens Digital Camera
ILCE-5100

Switching the screen display (during playback)

Switches the screen display.

1. Press the DISP (Display Setting) button.
 - The screen display switches in the order “Display Info. → Histogram → No Disp. Info. → Display Info.” each time you press the DISP button.
 - The DISP (Display Setting) settings are applied for the Auto Review display.

Note

- The histogram is not displayed in the following situations:
 - During movie playback
 - During scrolling playback of panoramic images
 - During slideshows
 - During Folder View (MP4)
 - During AVCHD View
 - During XAVC S View

4-543-698-11(1)



Copyright 2014 Sony Corporation



Interchangeable Lens Digital Camera
ILCE-5100

Deleting a displayed image

You can delete an image displayed.

1. Display the image you want to delete.
2. Press the  (Delete) button.
3. Select [Delete] using the control wheel, then press  on the center of the control wheel.

Related Topic

 [Deleting multiple selected images](#)

4-543-698-11(1)

Copyright 2014 Sony Corporation



Interchangeable Lens Digital Camera
ILCE-5100

Deleting multiple selected images





You can delete multiple selected images.

1. MENU →  (Playback) → [Delete] → desired setting.

Menu item details

Multiple Img.:

Deletes the selected images.

(1) Select the images to be deleted, then press  on the center of the control wheel. The  mark is displayed in the check box. To cancel the selection, press  again to remove the  mark.

(2) To delete other images, repeat step (1).

(3) MENU → [OK] → Press  on the center.

All in this Folder:

Deletes all images in the selected folder.

All with this date:

Deletes all images in the selected date range.

Hint

- Perform [Format] to delete all images, including protected images.

Note

- The menu items that can be selected differ depending on the [View Mode] setting.

Related Topic

 [Deleting a displayed image](#)



 [Format](#)



Interchangeable Lens Digital Camera
ILCE-5100













Playing back movies

Plays back the recorded movies.

1. Press the  (playback) button to switch to playback mode.
2. Select the movie to be played back using the control wheel.
3. To play back movies, press  on the center.

Available operations during movie playback

You can perform slow playback and sound volume adjustment, etc. by pressing the bottom side of the control wheel.

-  : Playback
-  : Pause
-  : Fast-forward
-  : Fast-rewind
-  : Forward slow playback
-  : Reverse slow playback
-  : Next movie file
-  : Previous movie file
-  : Displays the next frame
-  : Displays the previous frame
-  : Sound volume adjustment
-  : Closes the operation panel

Hint

- “Forward slow playback,” “Reverse slow playback,” “Displays the next frame” and “Displays the previous frame” are available during pause.



Related Topic

 [View Mode](#)

Interchangeable Lens Digital Camera
ILCE-5100

Playing back panoramic images

The product automatically scrolls a panoramic image from end to end.

1. Press the  (playback) button to switch to playback mode.
2. Select the panoramic image to be played back using the control wheel.
3. Press  on the center to play back the image.

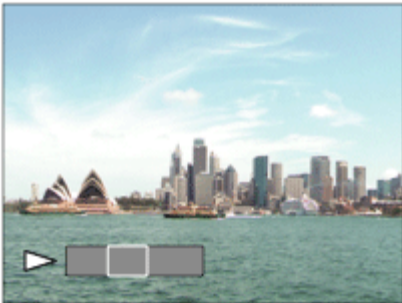

- To pause playback, press  on the center again.
- To return to the display of the entire image, press the MENU button.

Note

- Panoramic images shot using other products may be displayed in a different size from the actual size, or may not scroll correctly.

4-543-698-11(1)

Copyright 2014 Sony Corporation

Interchangeable Lens Digital Camera
ILCE-5100

Specify Printing

You can specify in advance on the memory card which still images you want to print out later.





The **DPOF** (print order) icon will appear on the specified images. DPOF refers to “Digital Print Order Format.”

1. MENU →  (Playback) → [Specify Printing] → desired setting.

Menu item details

Multiple Img.:

Selects images to order printing.

(1) Select an image and press  on the center of the control wheel. A  mark is displayed in the check box. To cancel the selection, press  and delete the  mark.

(2) Repeat step (1) to print other images.

(3) MENU → [OK] →  on the center.

Cancel All:

Clears all DPOF marks.

Print Setting:

You can set whether to print the date on images registered with DPOF marks.

Select [On] or [Off] → [Enter] in [Date Imprint].

Note

- You cannot add the DPOF mark to the following files:
 - Movies
 - RAW images

Interchangeable Lens Digital Camera
ILCE-5100

View Mode

Sets the View Mode (image display method).

1. MENU →  (Playback) → [View Mode] → desired setting.

Menu item details

 Date View:

Displays the images by date.

 Folder View(Still):

Displays only still images.

 Folder View(MP4):

Displays only MP4-format movies.

 AVCHD View:

Displays only AVCHD-format movies.

 XAVC S View:

Displays only XAVC S-format movies.

4-543-698-11(1)

Copyright 2014 Sony Corporation

Interchangeable Lens Digital Camera
ILCE-5100

Display Rotation

Selects the orientation when playing back recorded still images.

1. MENU →  (Playback) → [Display Rotation] → desired setting.

Menu items details

Manual (default setting):

The image is displayed according to the orientation information of the image. You can rotate the image using the rotation function.

Off:

Always displays in landscape orientation.

Related Topic

 [Rotate](#)

4-543-698-11(1)

Copyright 2014 Sony Corporation

Interchangeable Lens Digital Camera
ILCE-5100

Slide Show

Automatically plays back images continuously.

1. MENU →  (Playback) → [Slide Show] → desired setting.
2. Select [Enter].

Menu item details

Repeat:

Select [On], in which images are played back in a continuous loop, or [Off] (default setting), in which the product exits the slideshow when all the images are played back once.

Interval:

Select the display interval for images from among [1 Sec], [3 Sec] (default setting), [5 Sec], [10 Sec] or [30 Sec].

To quit the slideshow in the middle of playback

Press the MENU button to quit the slideshow. You cannot pause the slideshow.

Hint

- You can activate a slideshow only when [View Mode] is set to [Date View] or [Folder View(Still)].



Interchangeable Lens Digital Camera
ILCE-5100

Rotate

Rotates a recorded still image counter-clockwise.

1. MENU →  (Playback) → [Rotate].

2. Press  on the center of the control wheel.

The image is rotated counter-clockwise. The image rotates as you press  on the center. If you rotate the image once, the image remains rotated even after the product is turned off.

Note

- You cannot rotate the movies.
- You may not be able to rotate images shot using other products.
- When viewing rotated images on a computer, the images may be displayed in their original orientation depending on the software.

4-543-698-11(1)

Copyright 2014 Sony Corporation

Interchangeable Lens Digital Camera
ILCE-5100

Protect





Protects recorded images against accidental erasure. The  mark is displayed on protected images.

1. MENU →  (Playback) → [Protect] → desired setting.

Menu item details

Multiple Img.:

Applies or cancels the protection of the selected multiple images.

(1) Select the image to be protected, then press  on the center of the control wheel. The  mark is displayed in the check box. To cancel the selection, press  again to remove the  mark.

(2) To protect other images, repeat step (1).

(3) MENU → [OK] → Press  on the center.

All in this Folder:

Protects all images in the selected folder.

All with this date:

Protects all images in the selected date range.

Cancel All in this Folder:

Cancels the protection of all images in the selected folder.

Cancel All with this date:

Cancels the protection of all images in the selected date range.

Note

- The menu items that can be selected differ depending on the [View Mode] setting.

Interchangeable Lens Digital Camera
ILCE-5100

4K Still Image PB

Outputs still images in 4K resolution to an HDMI-connected TV that supports 4K.

1. Turn off this product and the TV.
2. Connect the HDMI micro terminal of this product to the HDMI jack of the TV using an HDMI cable (sold separately).

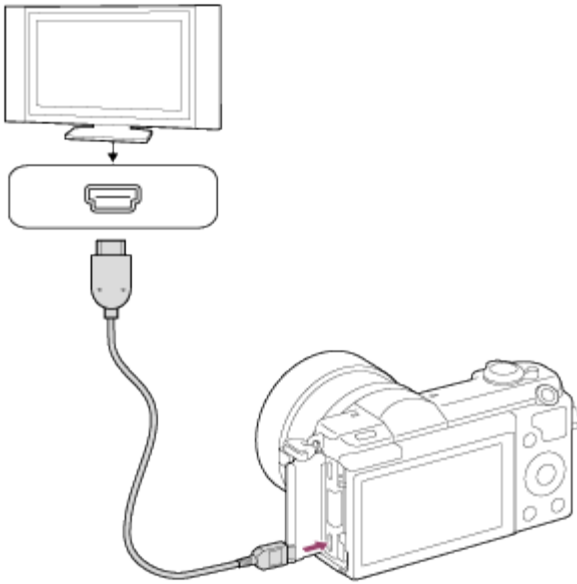

3. Turn on the TV and switch the input.
4. Turn on this product.
5. Play back a still image, then press the bottom of the control wheel.
The still image is output in 4K resolution.
 - You can output still images in 4K resolution by selecting MENU →  (Playback) → [4K Still Image PB] → [OK].

Note

- This menu is only available with 4K-compatible TVs. For details, refer to the operating instructions of the TV.

Related Topic

- [Viewing images on an HD TV](#)

Interchangeable Lens Digital Camera
ILCE-5100

Viewing images on an HD TV

To view images stored on this product using a TV, an HDMI cable (sold separately) and an HD TV equipped with an HDMI jack are required.

1. Turn off both this product and the TV.
2. Connect the HDMI micro terminal of this product to the HDMI jack of the TV using an HDMI cable (sold separately).

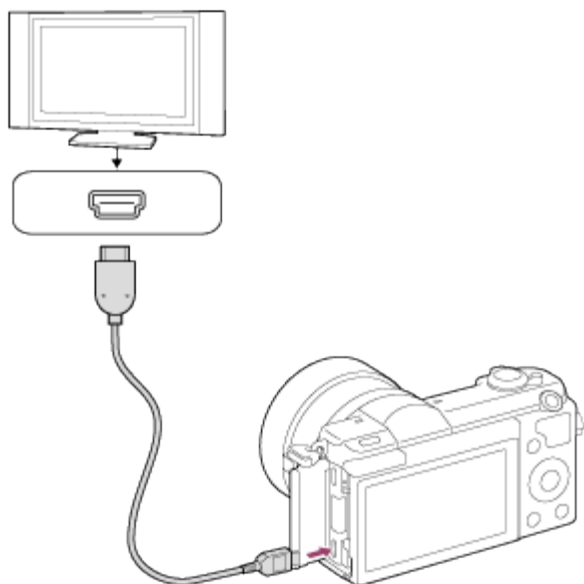

3. Turn on the TV and switch the input.
4. Turn on this product.
Images shot with the product appear on the TV screen.

Hint

- This product is compatible with the PhotoTV HD standard. If you connect Sony PhotoTV HD-compatible devices using an HDMI cable (sold separately), the TV is set to the image quality suitable for viewing still images, and a whole new world of photos can be enjoyed in breathtaking high quality.
- The PhotoTV HD allows for a highly-detailed, photo-like expression of subtle textures and colors.
- For details, refer to the operating instructions supplied with the compatible TV.

Note

- Do not connect this product and another device using the output terminals of both. Doing so may cause a malfunction.

- Some devices may not work properly when connected to this product. For example, they may not output video or audio.
- Use an HDMI cable with the HDMI logo or a genuine Sony cable.
- Use an HDMI cable that is compatible with the HDMI micro terminal of the product and the HDMI jack of the TV.

4-543-698-11(1)

Copyright 2014 Sony Corporation

Interchangeable Lens Digital Camera
ILCE-5100

Viewing images on a “BRAVIA” Sync-compatible TV

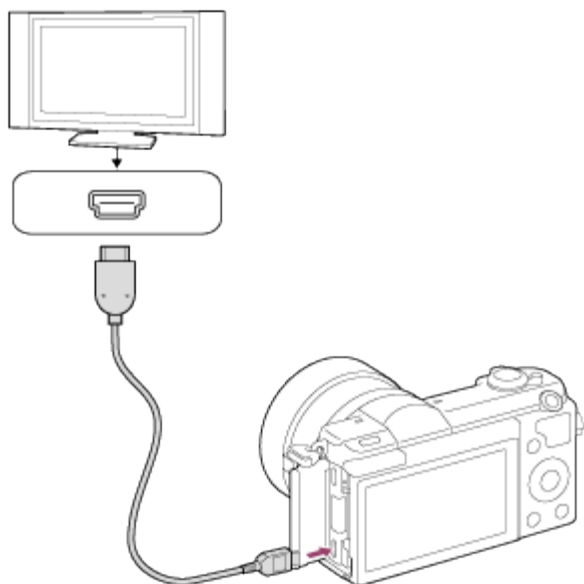

By connecting this product to a TV that supports “BRAVIA” Sync using an HDMI cable (sold separately), you can operate this product with the TV Remote Control.

1. Turn off both this product and the TV.
2. Connect the HDMI micro terminal of the product to the HDMI jack of the TV using an HDMI cable (sold separately).



3. Turn on the TV and switch the input.
4. Turn on this product.
5. MENU →  (Setup) → [HDMI Settings] → [CTRL FOR HDMI] → [On].
6. Press the SYNC MENU button on the TV Remote Control, and select the desired mode.

Note

- If the product is not in playback mode, press the  (Playback) button.
- Only TVs that support “BRAVIA” Sync can provide SYNC MENU operations. For details, refer to the operating instructions supplied with the TV.
- If the product performs unwanted operations in response to the TV Remote Control when the product is connected to another manufacturer’s TV using an HDMI connection, select MENU →  (Setup) → [HDMI Settings] → [CTRL

FOR HDMI] → [Off].

4-543-698-11(1)

Copyright 2014 Sony Corporation

Interchangeable Lens Digital Camera
ILCE-5100

Monitor Brightness

You can adjust the brightness of the screen.

1. MENU →  (Setup) → [Monitor Brightness] → desired setting.

Menu item details

Manual (default setting):

Adjusts the brightness within the range of -2 to +2.

Sunny Weather:

Sets the brightness appropriately for shooting outdoors.

Note

- The [Sunny Weather] setting is too bright for shooting indoors. Set [Monitor Brightness] to [Manual] for indoor shooting.

4-543-698-11(1)

Copyright 2014 Sony Corporation

Interchangeable Lens Digital Camera
ILCE-5100

Volume Settings

Adjusts the sound volume.

1. MENU →  (Setup) → [Volume Settings] → desired setting.

Adjusting the volume during playback

Press the bottom of the control wheel while playing back movies to display the operation panel, then adjust the volume. You can adjust the volume while listening to the actual sound.

4-543-698-11(1)

Copyright 2014 Sony Corporation

Interchangeable Lens Digital Camera
ILCE-5100

Audio signals

Selects whether the product produces a sound or not.

1. MENU →  (Setup) → [Audio signals] → desired setting.

Menu item details

On (default setting):

Sounds are produced for example when the focus is achieved by pressing the shutter button halfway down.

Off:

Sounds are not produced.

4-543-698-11(1)

Copyright 2014 Sony Corporation

Interchangeable Lens Digital Camera
 ILCE-5100

Upload Settings(Eye-Fi)

Sets whether to use the upload function when using an Eye-Fi card (commercially available). This item appears when an Eye-Fi card is inserted into the product's memory card slot.

1. MENU →  (Setup) → [Upload Settings] → desired setting.
2. Set your Wi-Fi network or destination on the Eye-Fi card.
For details, refer to the manual supplied with the Eye-Fi card.
3. Insert the Eye-Fi card you have set up into the product, and shoot still images.
Images are transferred to your computer, etc., automatically via the Wi-Fi network.

Menu item details

On (default setting):

Enables the upload function.

Off:

Disables the upload function

Communication status screen display

: Standby. No images are to be sent.



: Upload standby.

: Connecting.

: Uploading.

: Error

Note

- Eye-Fi cards are only sold in certain countries/regions.
- For more information on Eye-Fi cards, please contact the manufacturer or vendor directly.
- Eye-Fi cards can be used only in the countries/regions where they were purchased. Use Eye-Fi cards in accordance with the law of the countries/regions where you purchased the card.
- Eye-Fi cards are equipped with a wireless LAN function. Do not insert an Eye-Fi card into the product in locations in which their use is prohibited, such as on an airplane. When an Eye-Fi card is inserted into the product, set [Upload Settings] to [Off]. When the upload function is set to [Off], the  indicator will be displayed on the product.
- Power save mode will not function during uploading.
- If  (error) is displayed, remove the memory card and reinsert it, or turn the product off and then on again. If the indicator appears again, the Eye-Fi card may be damaged.
- Wireless LAN communication may be influenced by other communication devices. If the communication status is poor, move closer to the access point to be connected.

- This product does not support Eye-Fi “Endless Memory Mode.” Before using an Eye-Fi card, be sure that “Endless Memory Mode” is turned off.

4-543-698-11(1)

Copyright 2014 Sony Corporation

Interchangeable Lens Digital Camera
ILCE-5100

Tile Menu

Selects whether to always display the first screen of the menu when you press the MENU button.

1. MENU →  (Setup) → [Tile Menu] → desired setting.

Menu item details

On:

Always displays the first screen of the menu (Tile Menu).

Off:

Deactivates the Tile Menu display.

4-543-698-11(1)

Copyright 2014 Sony Corporation



Interchangeable Lens Digital Camera
ILCE-5100

Delete confirm.

You can set whether [Delete] or [Cancel] is selected as the default setting on the delete confirmation screen.

1. MENU →  (Setup) → [Delete confirm.] → desired setting.

Menu item details

"Delete" first:

[Delete] is selected as the default setting.

"Cancel" first (default setting):

[Cancel] is selected as the default setting.

4-543-698-11(1)

Copyright 2014 Sony Corporation

Interchangeable Lens Digital Camera
ILCE-5100

Pwr Save Start Time

You can set time intervals to automatically switch to power save mode. To return to shooting mode, perform an operation such as pressing the shutter button halfway down.

1. MENU →  (Setup) → [Pwr Save Start Time] → desired setting.

Menu item details

30 Min/5 Min/2 Min/1 Min (default setting)/10 Sec

Note

- Turn off the product when you do not use it for a long time.
- The power save function is not activated during playing back slideshow or recording movies, or when connected to a computer.

4-543-698-11(1)

Copyright 2014 Sony Corporation



Interchangeable Lens Digital Camera
ILCE-5100

PAL/NTSC Selector

Plays back movies recorded with the product on a PAL/NTSC system TV.

1. MENU →  (Setup) → [PAL/NTSC Selector] → [Enter]

Note

- This function is provided with 1080 50i-compatible devices only. It is not provided with 1080 60i-compatible devices. The 1080 50i-compatible devices have a “50i” mark on the bottom of the product.
- If you insert a memory card that has previously been formatted with the PAL system, a message telling you that you must re-format the card appears. When you record using the NTSC system, re-format the memory card or use another memory card.
- When the NTSC mode is selected, the “Running on NTSC.” message always appears on the start-up screen each time you turn the product on.

4-543-698-11(1)

Copyright 2014 Sony Corporation



Interchangeable Lens Digital Camera
ILCE-5100

Demo Mode

The [Demo Mode] function displays the movies recorded on the memory card automatically (demonstration), when the camera has not been operated for a certain time.

Normally select [Off].

1. MENU →  (Setup) → [Demo Mode] → desired setting.

Menu item details

On:

The movie playback demonstration starts automatically if the product is not operated for about one minute. Only protected AVCHD movies are played back.

Set the view mode to [AVCHD View], and protect the movie file with the oldest recorded date and time.

Off (default setting):

Does not show the demonstration.

Note

- You can set this item only when the product is powered by the AC-PW20 AC Adaptor (sold separately).
- Even if [On] is selected, the product does not start a demonstration if there is no movie file on the memory card.
- When [On] is selected, the product does not switch to power save mode.

Interchangeable Lens Digital Camera
ILCE-5100

HDMI Resolution

When you connect the product to a High Definition (HD) TV with HDMI terminals using an HDMI cable (sold separately), you can select HDMI Resolution to output images to the TV.

1. MENU →  (Setup) → [HDMI Settings] → [HDMI Resolution] → desired setting.

Menu item details

Auto (default setting):

The product automatically recognizes an HD TV and sets the output resolution.

1080p:

Outputs signals in HD picture quality (1080p).

1080i:

Outputs signals in HD picture quality (1080i).

Note

- If the images are not displayed properly using the [Auto] setting, select either [1080i] or [1080p], based on which TV is to be connected.



Interchangeable Lens Digital Camera
ILCE-5100

CTRL FOR HDMI

When connecting this product to a “BRAVIA” Sync-compatible TV using an HDMI cable (sold separately), you can operate this product by aiming the TV remote control at the TV.

1. MENU →  (Setup) → [HDMI Settings] → [CTRL FOR HDMI] → desired setting.

Menu item details

On (default setting):

You can operate this product with a TV's remote control.

Off:

You cannot operate this product with a TV's remote control.

Note

- [CTRL FOR HDMI] is available only with a “BRAVIA” Sync-compatible TV.

4-543-698-11(1)

Copyright 2014 Sony Corporation

Interchangeable Lens Digital Camera
ILCE-5100

HDMI Info. Display

Selects whether to display the shooting information when this product and the TV are connected using an HDMI cable (sold separately).

1. MENU →  (Setup) → [HDMI Settings] → [HDMI Info. Display] → desired setting.

Menu item details

On (default setting):

Displays the shooting information of the played back image.

Off:

Does not display the shooting information of the played back image.

4-543-698-11(1)

Copyright 2014 Sony Corporation



Interchangeable Lens Digital Camera
ILCE-5100

USB Connection

Selects the appropriate USB connection method for each computer or USB device connected to this product.

1. MENU →  (Setup) → [USB Connection] → desired setting.

Menu item details

Auto (default setting):

Establishes a Mass Storage or MTP connection automatically, depending on the computer or other USB devices to be connected. Windows 7 or Windows 8 computers are connected in MTP, and their unique functions are enabled for use.

Mass Storage:

Establishes a Mass Storage connection between this product, a computer, and other USB devices.

MTP:

Establishes an MTP connection between this product, a computer, and other USB devices. Windows 7 or Windows 8 computers are connected in MTP, and their unique functions are enabled for use.

PC Remote:

Uses "Remote Camera Control" to control this product from the computer, including such functions as shooting and storing images on the computer.

Note

- If Device Stage* is not displayed with Windows 7 or Windows 8, set [USB Connection] to [Auto].
- * Device Stage is a menu screen used to manage connected devices, such as a camera (Function of Windows 7 or Windows 8).



Interchangeable Lens Digital Camera
ILCE-5100

USB LUN Setting

Enhances compatibility by limiting of USB connection functions.

1. MENU →  (Setup) → [USB LUN Setting] → desired setting.

Menu item details

Multi (default setting):

Normally, use [Multi].

Single:

Set [USB LUN Setting] to [Single] only if you cannot make a connection.

4-543-698-11(1)

Copyright 2014 Sony Corporation



Interchangeable Lens Digital Camera
ILCE-5100

Language

Selects the language to be used in the menu items, warnings and messages.

1. MENU → (Setup) → [Language] → desired language.

4-543-698-11(1)

Copyright 2014 Sony Corporation



Interchangeable Lens Digital Camera
ILCE-5100

Date/Time Setup

Sets the date and time again.

1. MENU →  (Setup) → [Date/Time Setup] → desired setting.

Menu item details

Daylight Savings:

Selects Daylight Savings [On]/[Off].

Date/Time:

Sets the date and time.

Date Format:

Selects the date and time display format.

4-543-698-11(1)

Copyright 2014 Sony Corporation

Interchangeable Lens Digital Camera
ILCE-5100

Area Setting

Sets the area where you are using the product.

1. MENU →  (Setup) → [Area Setting] → desired area.

4-543-698-11(1)

Copyright 2014 Sony Corporation

Interchangeable Lens Digital Camera
ILCE-5100

Format

Formats (initializes) the memory card. When you use a memory card with this product for the first time, it is recommended that you format the card using the product for stable performance of the memory card. Note that formatting permanently erases all data on the memory card, and is unrecoverable. Save valuable data on a computer, etc.

1. MENU →  (Setup) → [Format].

Note

- Formatting permanently erases all data including even protected images.

4-543-698-11(1)

Copyright 2014 Sony Corporation

Interchangeable Lens Digital Camera
ILCE-5100

File Number

Selects how to assign file numbers to recorded still images and MP4 movies.

1. MENU →  (Setup) → [File Number] → desired setting.

Menu item details

Series (default setting):

Even if you change the recording destination folder or change the memory card, the product continues to assign numbers to files in sequence.

(If there is a larger file number on the new memory card than the latest image file, a number one higher than the largest number is assigned.)

Reset:

The product resets numbers when a file is recorded in a new folder and assigns numbers to files starting with "0001."
(When the recording folder contains a file, a number one higher than the largest number is assigned.)

Interchangeable Lens Digital Camera
ILCE-5100

Select REC Folder

You can change the folder on the memory card where still images and MP4 movies are to be recorded.

1. MENU →  (Setup) → [Select REC Folder] → desired folder.

Note

- You cannot select the folder when you select the [Date Form] setting.

4-543-698-11(1)

Copyright 2014 Sony Corporation



Interchangeable Lens Digital Camera
ILCE-5100

New Folder

Creates a new folder on the memory card for recording still images and MP4 movies. A new folder is created with a folder number one greater than the largest folder number currently used. Images are recorded in the newly created folder. A folder for still images and a folder for MP4 movies that have the same number are created at the same time.

1. MENU →  (Setup) → [New Folder].

Note

- When you insert a memory card that was used with other equipment into this product and shoot images, a new folder may be automatically created.
- Up to 4,000 images in total can be stored in one folder. When the folder capacity is exceeded, a new folder may be automatically created.

4-543-698-11(1)

Copyright 2014 Sony Corporation



Interchangeable Lens Digital Camera
ILCE-5100

Folder Name

Still images you shoot are recorded in a folder that is automatically created under the DCIM folder on the memory card. You can change the way folder names are assigned.

1. MENU →  (Setup) → [Folder Name] → desired setting.

Menu item details

Standard Form (default setting):

The folder name form is as follows: folder number + MSDCF.

Example: 100MSDCF

Date Form:

The folder name form is as follows: folder number + Y (the last digit)/MM/DD.

Example: 10040405 (Folder number: 100, date: 04/05/2014)

Note

- The MP4 movie folder form is fixed as “folder number + ANV01”.

Interchangeable Lens Digital Camera
ILCE-5100

Recover Image DB

If image files were processed on a computer, problems may occur in the image database file. In such cases, the images on the memory card will not be played back on this product. If these problems happen, repair the file using [Recover Image DB].

1. MENU →  (Setup) → [Recover Image DB] → [Enter].

Note

- Use a sufficiently charged battery pack. Low battery power during repairing can cause damage to data.

4-543-698-11(1)

Copyright 2014 Sony Corporation



Interchangeable Lens Digital Camera
ILCE-5100

Display Media Info.

Displays the recordable time of movies and the number of recordable still images for the inserted memory card.

1. MENU → (Setup) → [Display Media Info.].

4-543-698-11(1)

Copyright 2014 Sony Corporation

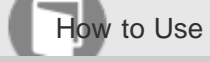

Interchangeable Lens Digital Camera
ILCE-5100

Version

Displays the software version of this product, lens and Mount Adaptor.

1. MENU →  (Setup) → [Version].

4-543-698-11(1)

Copyright 2014 Sony Corporation



Interchangeable Lens Digital Camera
ILCE-5100

Certification Logo (Overseas model only)

Displays some of the certification logos for this product.

1. MENU → (Setup) → [Certification Logo].

4-543-698-11(1)

Copyright 2014 Sony Corporation



Interchangeable Lens Digital Camera
ILCE-5100

Setting Reset

Resets the product to the default settings. Even if you perform [Setting Reset], the recorded images are retained.

1. MENU →  (Setup) → [Setting Reset] → desired setting.

Menu item details

Camera Settings Reset:

Initializes the main shooting settings to the default settings.

Initialize:

Initializes all the settings to the default settings.

Note

- Be sure not to eject the battery pack while resetting.
- When you perform [Initialize], downloaded applications on the product may be uninstalled. To use these applications again, re-install them.
- The value set with [AF Micro Adj.] will not be reset even when [Camera Settings Reset] or [Initialize] is performed.

4-543-698-11(1)

Copyright 2014 Sony Corporation



Interchangeable Lens Digital Camera
ILCE-5100

PlayMemories Mobile

To use [Smart Remote Embedded] or [Send to Smartphone], etc., the application PlayMemories Mobile should be installed on your smartphone.

Download and install the application PlayMemories Mobile from your smartphone's application store. If PlayMemories Mobile is already installed on your smartphone, be sure to update it to the latest version.

For details on PlayMemories Mobile, refer to the support page (<http://www.sony.net/pmm/>).

4-543-698-11(1)

Copyright 2014 Sony Corporation

Interchangeable Lens Digital Camera
ILCE-5100

Connecting an Android smartphone to this product

1. Launch PlayMemories Mobile on your smartphone.
2. Select the model name of this product (DIRECT-xxxx: xxxx).



3. Input the password that is displayed on this product.



The smartphone is connected to the product.

Related Topic

● [Smart Remote Embedded](#)

Interchangeable Lens Digital Camera
ILCE-5100

Connecting the product to an iPhone or iPad

1. Select the model name of this product (DIRECT-xxxx:xxxx) on the Wi-Fi setting screen of your iPhone or iPad.



2. Input the password displayed on this product.



The iPhone or iPad is connected to the product.

3. Confirm that your iPhone or iPad was connected to the “SSID” shown on this product.



4. Return to the “Home” screen and launch PlayMemories Mobile.

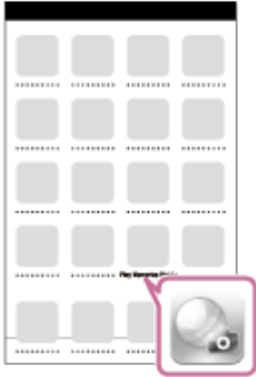

Related Topic

● [Smart Remote Embedded](#)

4-543-698-11(1)



Copyright 2014 Sony Corporation



Interchangeable Lens Digital Camera
ILCE-5100

Calling up an application using [One-touch(NFC)]

You can call up a desired application from the application menu of this product by touching an NFC-enabled Android smartphone to the product. If the application you call up has a feature that works with the smartphone, the product and the smartphone will be connected via Wi-Fi. To use this function, register the desired application in advance.

1. MENU →  (Wireless) → [One-touch(NFC)] → desired application.
2. Switch this product to shooting mode, then touch an NFC-enabled smartphone to the  (N mark) on the product for 1-2 seconds.
 - PlayMemories Mobile launches on the smartphone, and the application you have registered launches on this product.

Note

- When the product is in playback mode, the registered application will not launch even if you touch the smartphone to the product.
- When you call up an application with one touch, even if that application does not work with a smartphone, PlayMemories Mobile on smartphone will launch. Exit PlayMemories Mobile without performing an operation. If you do not exit PlayMemories Mobile, the smartphone stays in standby connection status.

4-543-698-11(1)

Copyright 2014 Sony Corporation

Interchangeable Lens Digital Camera ILCE-5100

Smart Remote Embedded

You can use a smartphone as the remote controller for this product, and shoot still images/movies. Still images/movies shot via remote control are sent to the smartphone from the product. The application PlayMemories Mobile must be installed on your smartphone.

1. MENU →  (Application) → [Application List] → [Smart Remote Embedded].
2. When the product is ready for the connection, an information screen appears on the product. Connect the smartphone and the product using that information.
 - Connection setting methods differ among smartphones.

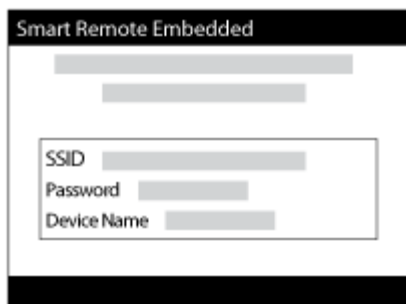

3. Check the composition of the image on the smartphone screen, and then press the shutter button (A) on the smartphone to shoot an image.
 - Use button (B) to change settings such as [EV], [Self-Timer] and [Review Check].

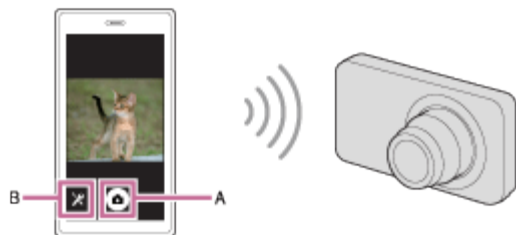

Note

- When you record movies using a smartphone as a remote controller, the monitor of the product becomes darker.
- This product shares the connection information for [Smart Remote Embedded] with a device that has permission to connect. If you want to change the device that is permitted to connect to the product, reset the connection information by following these steps. MENU →  (Wireless) → [SSID/PW Reset]. After resetting the connection information, you

must register the smartphone again.

- Depending on future version upgrades, the operational procedures or screen displays are subject to change without notice.

Related Topic

- [Connecting an Android smartphone to this product](#)
- [Connecting the product to an iPhone or iPad](#)
- [PlayMemories Mobile](#)

4-543-698-11(1)

Copyright 2014 Sony Corporation

Interchangeable Lens Digital Camera
ILCE-5100

One-touch connection with an NFC-enabled Android smartphone (NFC One-touch remote)

You can connect this product and an NFC-enabled Android smartphone with one touch, without performing a complex setup operation.

1. Activate the NFC function of the smartphone.
2. Switch this product to shooting mode.
 - The NFC function is available only when the  (N mark) is displayed on the screen.
3. Touch the product to the smartphone.

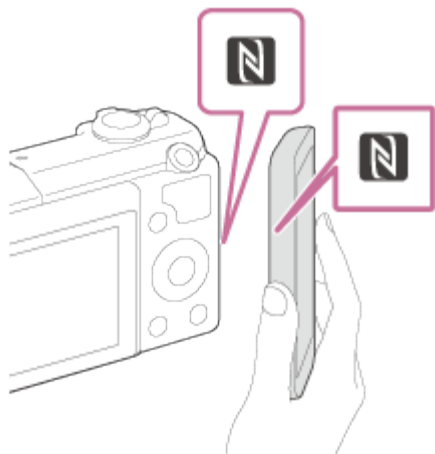

The smartphone and the product are connected, and PlayMemories Mobile launches on the smartphone.

- Touch the smartphone to the product for 1-2 seconds until PlayMemories Mobile launches.

About "NFC"

NFC is a technology that enables short-range wireless communication between various devices, such as mobile phones or IC tags, etc. NFC makes data communication simpler with just a touch on the designated touch-point.

- NFC (Near Field Communication) is an international standard of short-range wireless communication technology.

Note

- If you cannot make a connection, do as the following:
 - Launch PlayMemories Mobile on your smartphone, and then move the smartphone slowly toward the  (N mark) of this product.
 - If the smartphone is in a case, remove it.
 - If the product is in a case, remove it.

–Check whether the NFC function is activated on your smartphone.

- When [Airplane Mode] is set to [On], you cannot connect this product and the smartphone. Set [Airplane Mode] to [Off].
- If this product and the smartphone are connected when the product is in playback mode, the displayed image is sent to the smartphone.

Related Topic

- [Airplane Mode](#)
- [Smart Remote Embedded](#)

4-543-698-11(1)

Copyright 2014 Sony Corporation

Interchangeable Lens Digital Camera
 ILCE-5100

Send to Smartphone

You can transfer still images to a smartphone and view them. The application PlayMemories Mobile must be installed on your smartphone.

1. MENU →  (Wireless) → [Send to Smartphone] → desired setting.
2. If the product is ready for the transfer, the information screen appears on the product. Connect the smartphone and the product using that information.
 - The setting method for connecting the smartphone and the product varies depending on the smartphone.

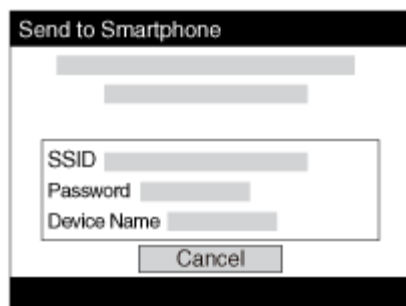

Menu item details

Select on This Device:

Selects an image on the product to be transferred to the smartphone.

(1) Select from among [This Image], [All Images on This Date] or [Multiple Images].

- The options displayed may differ depending on the View Mode selected on the camera.

(2) If you select [Multiple Images], select the desired images using  on the control wheel, then press MENU → [Enter].

Select on Smartphone:

Displays all images recorded on the product's memory card on the smartphone.

Note

- You can select an image size to be sent to the smartphone from [Original], [2M] or [VGA].

To change the image size, refer to the following steps.

–For Android smartphone

Start PlayMemories Mobile, and change the image size by [Settings] → [Copy Image Size].

–For iPhone/iPad

Select PlayMemories Mobile in the setting menu, and change the image size by [Copy Image Size].

- Some images may not be displayed on the smartphone depending on the recording format.
- RAW images are converted to JPEG format when they are sent.
- You cannot send XAVC S or AVCHD format movies.
- This product shares the connection information for [Send to Smartphone] with a device that has permission to connect. If you want to change the device that is permitted to connect to the product, reset the connection information by following these steps. MENU → [Wireless] → [SSID/PW Reset]. After resetting the connection information, you must register the smartphone again.
- When [Airplane Mode] is set to [On], you cannot connect this product and the smartphone. Set [Airplane Mode] to [Off].

Related Topic

- [Connecting an Android smartphone to this product](#)
- [Connecting the product to an iPhone or iPad](#)
- [PlayMemories Mobile](#)

4-543-698-11(1)

Copyright 2014 Sony Corporation

Interchangeable Lens Digital Camera
ILCE-5100



Sending images to an Android smartphone (NFC One-touch Sharing)

With just one touch, you can connect this product and an NFC-enabled Android smartphone, and send an image displayed on the product screen directly to the smartphone. For movies, you can only transfer MP4 movies recorded with [ File Format] set to [MP4].

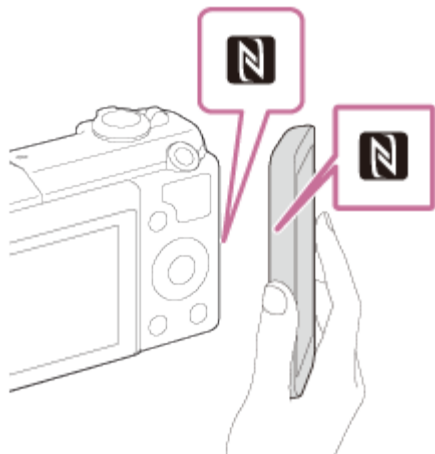
1. Activate the NFC function of the smartphone.
2. Display a single image on the product.
3. Touch the smartphone to the product.



The product and the smartphone are connected, and PlayMemories Mobile automatically launches on the smartphone, and then the displayed image is sent to the smartphone.

- Before you touch the smartphone, cancel the sleep and lock-screen functions of the smartphone.
- The NFC function is available only when the  (N mark) is displayed on the product.
- Touch the smartphone to the product for 1-2 seconds until PlayMemories Mobile launches.
- To transfer two or more images, select MENU →  (Wireless) → [Send to Smartphone] to select images. After the connection enabled screen appears, use NFC to connect the product and the smartphone.

About “NFC”

NFC is a technology that enables short-range wireless communication between various devices, such as mobile phones or IC tags, etc. NFC makes data communication simpler with just a touch on the designated touch-point.

- NFC (Near Field Communication) is an international standard of short-range wireless communication technology.

- You can select an image size to be sent to the smartphone from [Original], [2M], or [VGA]. To change the image size, refer to the following steps.
 - For Android smartphone
 - Start PlayMemories Mobile, and change the image size by [Settings] → [Copy Image Size].
- RAW images are converted to JPEG format when they are sent.
- If the Image Index is displayed on the product, you cannot transfer images using the NFC function.
- If you cannot make a connection, perform the following:
 - Launch PlayMemories Mobile on your smartphone, and then move the smartphone slowly toward the  (N mark) of this product.
 - If the smartphone is in a case, remove it.
 - If the product is in a case, remove it.
 - Confirm that the NFC function is activated on the smartphone.
- When [Airplane Mode] is set to [On], you cannot connect the product and the smartphone. Set [Airplane Mode] to [Off].
- You cannot send AVCHD format movies.
- You cannot send XAVC S format movies.

Related Topic

- [Connecting an Android smartphone to this product](#)
- [Connecting the product to an iPhone or iPad](#)
- [Airplane Mode](#)
- [Send to Smartphone](#)
- [PlayMemories Mobile](#)

4-543-698-11(1)

Copyright 2014 Sony Corporation

Interchangeable Lens Digital Camera
ILCE-5100

Send to Computer

You can transfer images stored in the product to a computer connected to a wireless access point or wireless broadband router and easily make backup copies using this operation. Before starting this operation, install PlayMemories Home on your computer and register the access point on the product.

1. Start your computer.
2. MENU →  (Wireless) → [Send to Computer].

Note

- Depending on the application settings of your computer, the product will turn off after saving the images to your computer.
- You can transfer images from the product to only one computer at a time.
- If you want to transfer images to another computer, connect the product and the computer via a USB connection and follow the instructions in PlayMemories Home.

Related Topic



- [Installing PlayMemories Home](#)
- [WPS Push](#)
- [Access Point Set.](#)



Interchangeable Lens Digital Camera ILCE-5100

View on TV

You can view images on a network-enabled TV by transferring them from the product without connecting the product and TV with a cable. For some TVs, you may need to perform operations on the TV. For details, refer to the operating instructions supplied with the TV.

1. MENU →  (Wireless) → [View on TV] → desired device to be connected.
2. When you want to play back images using slideshow, press  on the center of the control wheel.

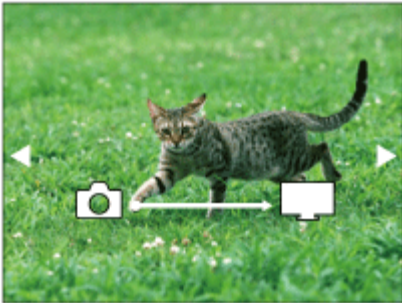

- To display the next/previous image manually, press the right/left side of the control wheel.
- To change the device to be connected, press the bottom side of the control wheel, then select [Device list].

Slideshow settings

You can change the slideshow settings by pressing the bottom side of the control wheel.

Playback Selection:

Selects the group of images to be shown.

Folder View(Still):

Selects from [All] and [All in Folder].

Date View:

Selects from [All] and [All in Date Rng.].

Interval:

Selects from [Short] and [Long].

Effects*:

Select from [On] and [Off].

Playback Image Size:

Select from [HD] and [4K].

*The settings are effective only for BRAVIA TV which is compatible with the functions.

Note

- You can use this function on a TV that supports DLNA renderer.
- You can view images on a Wi-Fi Direct-enabled TV or network-enabled TV (including cable TV).
- If you connect TV and this product and do not use Wi-Fi Direct, you need to register your access point first.
- Displaying the images on the TV may take time.
- Movies cannot be shown on a TV via Wi-Fi. Use an HDMI cable (sold separately).

Related Topic

- [WPS Push](#)
- [Access Point Set.](#)

4-543-698-11(1)

Copyright 2014 Sony Corporation

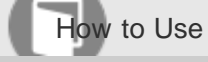

Interchangeable Lens Digital Camera
ILCE-5100

Airplane Mode

When you board an airplane, etc., you can turn off all Wi-Fi functions temporarily.

1. MENU →  (Wireless) → [Airplane Mode] → desired setting.

If you set [Airplane Mode] to [On], an airplane mark will be displayed on the screen.

4-543-698-11(1)

Copyright 2014 Sony Corporation



Interchangeable Lens Digital Camera
ILCE-5100

WPS Push

If your access point has the WPS button, you can register the access point to this product easily by pushing the WPS button.

1. MENU →  (Wireless) → [WPS Push].
2. Press the WPS button on the access point you want to register.

Note

- [WPS Push] works only if the security setting of your access point is set to WPA or WPA2 and your access point supports the WPS button method. If the security setting is set to WEP or your access point does not support the WPS button method, perform [Access Point Set.].
- For details about the available functions and settings of your access point, see the access point operating instructions or contact the administrator of the access point.
- A connection may not be enabled depending on the surrounding conditions, such as the type of wall material or if there is an obstruction or poor wireless signal between the product and access point. If that happens, change the location of the product or move the product closer to the access point.

Related Topic

 [Access Point Set.](#)

Interchangeable Lens Digital Camera
ILCE-5100

Access Point Set.

You can register your access point manually. Before starting the procedure, check the SSID name of the access point, security system, and password. The password may be preset in some devices. For details, see the access point operating instructions, or consult the access point administrator.

1. MENU →  (Wireless) → [Access Point Set.].
2. Select the access point you want to register.

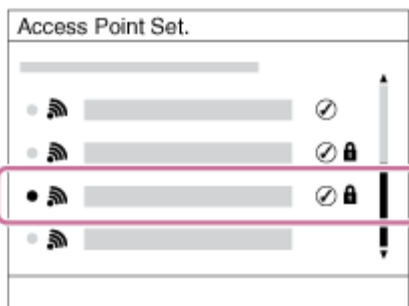

When the desired access point is displayed on the screen: Select the desired access point.

When the desired access point is not displayed on the screen: Select [Manual Setting] and set the access point.

*For the input method, refer to “How to use the keyboard.”

- If you select [Manual Setting], input the SSID name of the access point, then select the security system.

3. Input the password, and select [OK].

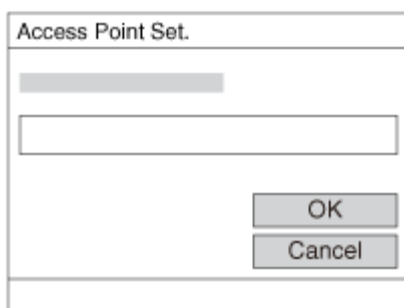

- Access points without the  mark do not require a password.

4. Select [OK].

How to use the keyboard

When manual character entry is required, a keyboard is displayed on the screen.



1. Input box The characters you entered are displayed.
2. Switch character types Each time you press ● on the center of the control wheel, the character type switches among alphabet letters, numerals and symbols.
3. Keyboard Each time you press ● on the center, the character that you enter will be displayed.

For example: If you want to enter "abd"

Select the key for "abc" and press ● once to display "a" → select "➡" ((5) Move cursor) and press ● → select the key for "abc" and press ● twice to display "b" → select the key for "def" and press ● once to display "d".

4. Finalize Finalizes the entered characters.
5. Move cursor Moves the cursor in the input box to the right or left.
6. Delete Deletes the character preceding the cursor.
7. ↑ Switches the next character to a capital or small letter.
8. ␣ Enters a space.

- To cancel the input, select [Cancel].

Other setting items

Depending on the status or the setting method of your access point, you may want to set more items.

WPS PIN:

Displays the PIN code you enter into the connected device.

Priority Connection:

Select [On] or [Off].

IP Address Setting:

Select [Auto] or [Manual].

IP Address:

If you are entering the IP address manually, enter the set address.

Subnet Mask/Default Gateway:

When you set [IP Address Setting] to [Manual], enter the IP address to match your network environment.

Note

- To give the registered access point priority, set [Priority Connection] to [On].

Related Topic

- [WPS Push](#)



Interchangeable Lens Digital Camera
ILCE-5100

Edit Device Name

You can change the device name under Wi-Fi Direct.

1. MENU →  (Wireless) → [Edit Device Name].
2. Select the input box, then input the device name → [OK].
 - For input method, refer to [“How to use the keyboard.”](#)

Related Topic

- [WPS Push](#)
- [Access Point Set.](#)

4-543-698-11(1)

Copyright 2014 Sony Corporation

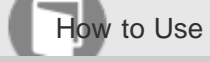

Interchangeable Lens Digital Camera
ILCE-5100

Disp MAC Address

Displays the MAC address of this product.

1. MENU →  (Wireless) → [Disp MAC Address].

4-543-698-11(1)

Copyright 2014 Sony Corporation

Interchangeable Lens Digital Camera
ILCE-5100

SSID/PW Reset

This product shares the connection information for [Send to Smartphone] and [Smart Remote Embedded] with a device that has permission to connect. If you want to change the device that is permitted to connect, reset the connection information.

1. MENU →  (Wireless) → [SSID/PW Reset] → [OK].

Note

- If you connect this product to the smartphone after resetting the connection information, you must register the smartphone again.

Related Topic

- [Send to Smartphone](#)
- [Smart Remote Embedded](#)

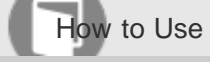

Interchangeable Lens Digital Camera
ILCE-5100

Reset Network Set.

Resets all the network settings to default settings.

1. MENU →  (Wireless) → [Reset Network Set.] → [OK].

4-543-698-11(1)

Copyright 2014 Sony Corporation

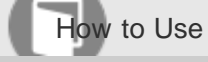

Interchangeable Lens Digital Camera
ILCE-5100

PlayMemories Camera Apps

You can add the desired functions to this product by connecting to the application download website  (PlayMemories Camera Apps) via the Internet. For example, the following operations are available:

- You can use various effects for shooting images.
- You can upload images to network services directly from the product.
- Press MENU →  (Application) → [Introduction] for information about the service and available countries and regions.

4-543-698-11(1)

Copyright 2014 Sony Corporation



Interchangeable Lens Digital Camera
ILCE-5100

Recommended computer environment

For details on the recommended computer environments for downloading an application and adding functions to the product, use to the following URL:

“PlayMemories Camera Apps” website (www.sony.net/pmca/)

4-543-698-11(1)

Copyright 2014 Sony Corporation

Interchangeable Lens Digital Camera
ILCE-5100

Opening a service account

You can open a service account, which is required to download applications.

1. Access the application download website.
<http://www.sony.net/pmca/>
2. Follow the instructions on the screen and acquire a service account.
 - Follow the instructions on the screen to download the desired application to the product.

4-543-698-11(1)

Copyright 2014 Sony Corporation

Interchangeable Lens Digital Camera
ILCE-5100

Downloading applications

You can download applications using your computer.

1. Access the application downloading website.
<http://www.sony.net/pmca/>
2. Select the desired application and download the application to the product following the instructions on the screen.
 - Connect the computer and the product using the micro USB cable (supplied), following the instructions on the screen.

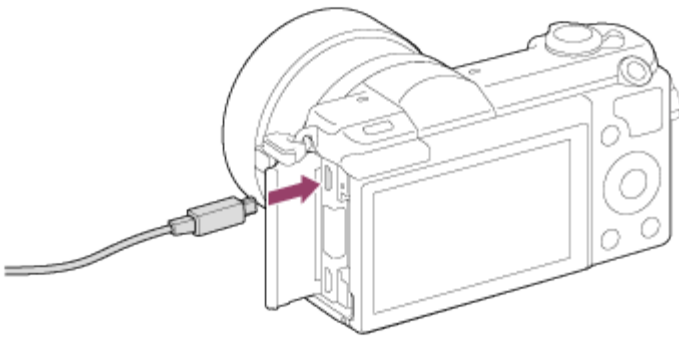

Related Topic

- [Opening a service account](#)

4-543-698-11(1)



Copyright 2014 Sony Corporation



Interchangeable Lens Digital Camera
ILCE-5100

Downloading applications directly to the product using the Wi-Fi function

You can download applications using the Wi-Fi function without connecting to a computer.

1. MENU →  (Application) → Application List →  (PlayMemories Camera Apps), then follow the instructions on the screen to download applications.
Acquire a service account in advance.

Note

- When the IP address setting of this product is [Manual], you cannot download an application. Set [IP Address Setting] to [Auto].

Related Topic

- [Access Point Set.](#)
- [Opening a service account](#)

4-543-698-11(1)

Copyright 2014 Sony Corporation

Interchangeable Lens Digital Camera
ILCE-5100

Launching the downloaded application

Launch an application that has been downloaded from the application download website PlayMemories Camera Apps.

1. MENU →  (Application) → [Application List] → desired application to launch.

Hint

How to launch the applications faster

Assign [Download Appli.] and [Application List] to the custom key. You can launch the applications or display application list only by pressing the custom key during the shooting information screen is displayed.

Related Topic

[Custom Key Settings](#)



4-543-698-11(1)

Copyright 2014 Sony Corporation

Interchangeable Lens Digital Camera
ILCE-5100

Uninstalling applications

You can uninstall applications from this product.

1. MENU →  (Application) → Application List → [Application Management] → [Manage and Remove].
 2. Select the application to be uninstalled.
 3. Select  to uninstall the application.
- The uninstalled application can be re-installed. For details, see the application download website.

4-543-698-11(1)

Copyright 2014 Sony Corporation



Interchangeable Lens Digital Camera
ILCE-5100

Changing the order of applications

You can change the order in which added applications are displayed on this product.

1. MENU → (Application) → Application List → [Application Management] → [Sort].
2. Select the application of which you want to change the order.
3. Select the destination.

4-543-698-11(1)

Copyright 2014 Sony Corporation



Interchangeable Lens Digital Camera
ILCE-5100

Confirming the account information of PlayMemories Camera Apps

The account information for the “Sony Entertainment Network” that is registered on the product is displayed.

1. MENU → (Application) → Application List → [Application Management] → [Display Account Information].

4-543-698-11(1)

Copyright 2014 Sony Corporation



Interchangeable Lens Digital Camera
ILCE-5100

Recommended computer environment

You can confirm the operating computer environment of the software from the following URL:

www.sony.net/pcenv/

4-543-698-11(1)

Copyright 2014 Sony Corporation



Interchangeable Lens Digital Camera
ILCE-5100

PlayMemories Home

With PlayMemories Home, you can do the following:

- You can import images shot with this product to your computer.
- You can play back the images imported to your computer.
- You can share your images using PlayMemories Online.

Also for Windows, you can do the following:

- You can organize images on the computer on a calendar by shooting date to view them.
- You can edit and correct images, such as by trimming and resizing.
- You can create a Blu-ray Disc, AVCHD disc or DVD-Video disc from AVCHD movies imported to a computer. You cannot create discs from XAVC S format movies, although they can be imported to computers.
- You can upload images to a network service. (An internet connection is required.)
- For other details, please refer to the Help of PlayMemories Home.
- An Internet connection is required to use PlayMemories Online or other network services. PlayMemories Online or other network services may not be available in some countries or regions.

4-543-698-11(1)

Copyright 2014 Sony Corporation

Interchangeable Lens Digital Camera
ILCE-5100

Installing PlayMemories Home

1. Using the Internet browser on your computer, go to the following URL and install PlayMemories Home.
www.sony.net/pm/
 - Proceed the installation by following the instructions on the screen.
 - When installation is completed, PlayMemories Home starts up.
 - If PMB (Picture Motion Browser) supplied with a product that was purchased before 2011 has already been installed on the computer, PMB will be overwritten by PlayMemories Home. Please use PlayMemories Home.
2. Connect the product and your computer using the supplied micro USB cable.
 - New functions may be added to PlayMemories Home. Even if PlayMemories Home has already been installed on your computer, connect this product and your computer again.

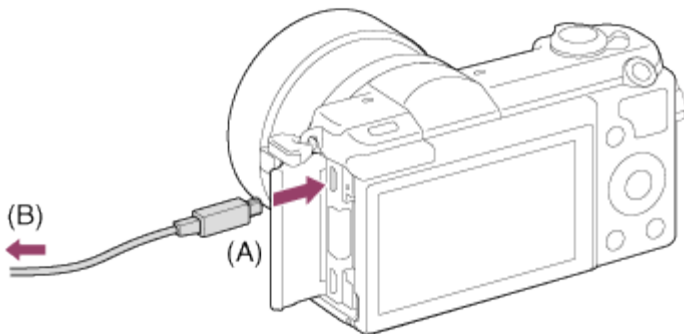

A: To the Multi/Micro USB Terminal

B: To the USB jack of the computer

Note

- Log on as Administrator.
- It may be necessary to restart your computer. When the restart confirmation message appears, restart the computer following the instructions on the screen.
- DirectX may be installed depending on your computer's system environment.

Hint

- For details on PlayMemories Home, refer to the Help of PlayMemories Home or the PlayMemories Home support page (<http://www.sony.co.jp/pmh-se/>) (English only).



Interchangeable Lens Digital Camera
ILCE-5100

Software for Mac computers

For details on software for Mac computers, access the following URL:

<http://www.sony.co.jp/imsoft/Mac/>

Wireless Auto Import

“Wireless Auto Import” is required if you are using a Mac computer and want to import images to the computer using Wi-Fi function. Download “Wireless Auto Import” from the URL above, and install it on your Mac computer. For details, see Help for “Wireless Auto Import.”

Note

- The software that can be used varies depending on the region.

Related Topic

[Send to Computer](#)

4-543-698-11(1)

Copyright 2014 Sony Corporation

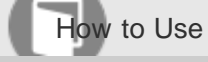

Interchangeable Lens Digital Camera
ILCE-5100

“Image Data Converter”

With “Image Data Converter,” you can do the following:

- You can edit images recorded in RAW format with various corrections, such as tone curve and sharpness.
- You can adjust images with white balance, exposure, and [Creative Style], etc.
- You can save the still images displayed and edited on a computer.
You can either save the still image as RAW format or save it in the general file format.
- You can display and compare the RAW images and JPEG images recorded by this product.
- You can rank images in five grades.
- You can apply color labels.

4-543-698-11(1)

Copyright 2014 Sony Corporation

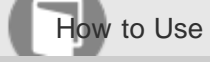

Interchangeable Lens Digital Camera
ILCE-5100

Installing “Image Data Converter”

1. Download and install the software by accessing the following URL (English only).

<http://www.sony.co.jp/ids-se/>

Note

- Log on as Administrator.

4-543-698-11(1)

Copyright 2014 Sony Corporation



Interchangeable Lens Digital Camera
ILCE-5100

Accessing “Image Data Converter Guide”

Windows:

[Start] → [All Programs] → [Image Data Converter] → [Help] → [Image Data Converter Ver.4].

- For Windows 8, start [Image Data Converter Ver.4], and select [Help] from the menu bar → [Image Data Converter Guide].

Mac:

Finder → [Applications] → [Image Data Converter] → [Image Data Converter Ver.4], and select [Help] from the menu bar → [Image Data Converter Guide].

- For details on operation, you can also refer to the “Image Data Converter” support page (English only).
<http://www.sony.co.jp/ids-se/>

4-543-698-11(1)

Copyright 2014 Sony Corporation

Interchangeable Lens Digital Camera
ILCE-5100

“Remote Camera Control”

When using “Remote Camera Control,” the following operations are available on your computer.

- Changing this product’s settings and shooting.
- Recording images directly to the computer.
- Performing interval timer shooting.

Use these functions after selecting MENU →  (Setup) → [USB Connection] → [PC Remote]. For details on how to use “Remote Camera Control,” refer to the Help.

4-543-698-11(1)

Copyright 2014 Sony Corporation

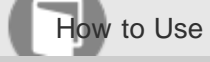

Interchangeable Lens Digital Camera
ILCE-5100

Installing “Remote Camera Control”

Download and install the software by accessing the following URL:

Windows:

<http://www.sony.co.jp/imsoft/Win/>

Mac:

<http://www.sony.co.jp/imsoft/Mac/>

4-543-698-11(1)

Copyright 2014 Sony Corporation



Interchangeable Lens Digital Camera
ILCE-5100

Accessing the Help of Remote Camera Control

Windows:

[Start] → [All Programs] → [Remote Camera Control] → [Remote Camera Control Help].

- For Windows 8, start [Remote Camera Control], and right-click the title bar to select [Remote Camera Control Help].

Mac:

Finder → [Applications] → [Remote Camera Control], and select [Help] from the menu bar → [Remote Camera Control Help].

4-543-698-11(1)

Copyright 2014 Sony Corporation

Interchangeable Lens Digital Camera
ILCE-5100

Connecting the product to a computer

1. Insert a sufficiently charged battery pack into the product, or connect it to a wall outlet (wall socket) using an AC Adaptor AC-PW20 (sold separately).
2. Turn on the product and the computer.
3. Connect the product and your computer using the micro USB cable (supplied) (A) .

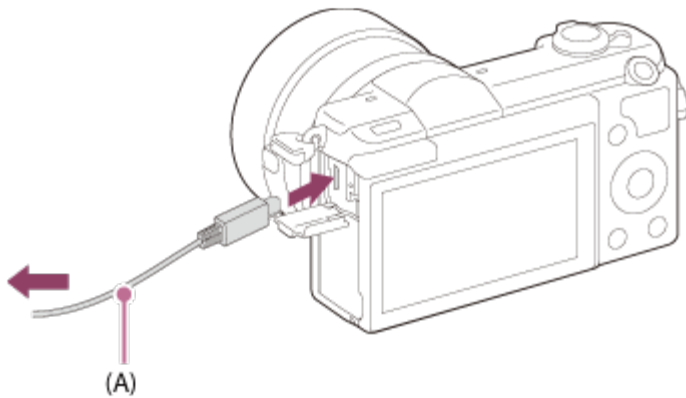

Related Topic

- [USB Connection](#)
- [USB LUN Setting](#)



Interchangeable Lens Digital Camera
ILCE-5100

Importing images to the computer

PlayMemories Home allows you to easily import images. For details on PlayMemories Home functions, see the Help of PlayMemories Home.

Importing images to the computer without using PlayMemories Home (For Windows)

When the AutoPlay Wizard appears after making a USB connection between this product and a computer, click [Open folder to view files] → [OK] → [DCIM] or [MP_ROOT]. Then copy the desired images to the computer.

- If Device Stage appears on a Windows 7 or Windows 8 computer, double-click [Browse Files] → media icon → folder in which the images you want to import are stored.

Importing images to the computer without using PlayMemories Home (For Mac)

Connect the product to your Mac computer. Double-click the newly recognized icon on the desktop → the folder in which the image you want to import is stored. Then drag and drop the image file on to the hard disk icon.

Note

- For operations such as importing AVCHD movies to the computer, use PlayMemories Home.
- Do not edit or otherwise process AVCHD movie files/folders from the connected computer. Movie files may be damaged or become unplayable. Do not delete or copy AVCHD movies on the memory card from the computer. Sony is not held liable for consequences resulting from such operations via the computer.



Interchangeable Lens Digital Camera
ILCE-5100

Disconnecting the product from the computer

Disconnects the USB connection between this product and the computer.

Perform the procedures from step 1 to 2 below before performing the following operations:

- Disconnecting the cable.
- Removing a memory card.
- Turning off the product.

1. Click  (Safely remove USB Mass Storage Device) on the taskbar.
2. Click the displayed message.

Note

- For Mac computers, drag and drop the icon of the memory card or the drive icon in the “Trash” icon. The product is disconnected from the computer.
- For Windows 7/Windows 8 computers, the disconnect icon may not appear. In that case, you can skip steps 1 and 2 above.

4-543-698-11(1)

Copyright 2014 Sony Corporation

Interchangeable Lens Digital Camera
ILCE-5100

Disc type



High-definition image quality (HD)

A Blu-ray Disc enables you to record longer duration of high definition image quality (HD) movies than DVD discs.



High-definition image quality (HD) (AVCHD recording disc)

High definition image quality (HD) movie can be recorded on DVD media, such as DVD-R discs, and a high definition image quality (HD) disc is created.

- You can play a high definition image quality (HD) disc on AVCHD format playback devices, such as a Sony Blu-ray Disc player and a PlayStation®3. You cannot play the disc on ordinary DVD players.



Standard definition image quality (STD)

Standard definition image quality (STD) movie converted from high definition image quality (HD) movie can be recorded on DVD media, such as DVD-R discs, and a standard image quality (STD) disc is created.

Hint

You can use the following types of 12 cm discs with PlayMemories Home. For Blu-ray discs, see “Creating Blu-ray Discs”.

DVD-R/DVD+R/DVD+R DL: Non-rewritable

DVD-RW/DVD+RW: Rewritable

- Always maintain your “PlayStation 3” to use the latest version of the “PlayStation 3” system software.
- “PlayStation 3” may not be available in some countries/regions.

Related Topic

- [Creating Blu-ray Discs](#)

Interchangeable Lens Digital Camera
ILCE-5100

Selecting the disc creation method

You can create a disc from an AVCHD format movie recorded using this product. Depending on the disc type, playable devices may vary. Select a method suitable for your disc player.

For details on creating a disc using PlayMemories Home, see the Help of PlayMemories Home. (Only for Windows)



Creates a disc with high-definition image quality (HD)

Writable movie format: PS, FX, FH

Player: Blu-ray Disc playback devices (Sony Blu-ray Disc player, PlayStation®3, etc.)



Creates a disc with high-definition image quality (HD) (AVCHD recording disc)

Writable movie format: PS*, FX*, FH

Player: AVCHD format playback devices (Sony Blu-ray Disc player, PlayStation®3, etc.)



Creates a disc with standard definition image quality (STD)

Writable movie format: PS*, FX*, FH*

Player: Ordinary DVD playback devices (DVD player, computer that can play back DVD discs, etc.)

*You can create a disc with movies recorded in these formats using PlayMemories Home by down-converting the image quality.

Interchangeable Lens Digital Camera
ILCE-5100

Creating a disc with a device other than a computer

You can also create discs using a Blu-ray recorder, etc. Depending on which device you use, the types of disc that can be created vary.

Blu-ray recorder:



High-definition image quality (HD)





Standard definition image quality (STD)

HDD recorder, etc.:



Standard definition image quality (STD)

Note

- When creating AVCHD discs using PlayMemories Home from movies recorded with the [ Record Setting] of [60p 28M(PS)]/[50p 28M(PS)], [60i 24M(FX)]/[50i 24M(FX)] or [24p 24M(FX)]/[25p 24M(FX)], the image quality is converted and it is not possible to create discs that have the original image quality. Converting the image quality takes time. To record movies with the original image quality, use Blu-ray Discs.
- To create a Blu-ray Disc from movies recorded in [60p 28M(PS)]/[50p 28M(PS)], you need to use a device that is compliant with AVCHD format Ver. 2.0. The created Blu-ray Disc can be played back only on a device that is compliant with AVCHD format Ver. 2.0.
- For details on how to create a disc, refer to the operating instructions of the device you use.
- Movies recorded with [ File Format] set to [XAVC S] cannot be copied to discs.



Interchangeable Lens Digital Camera
ILCE-5100

Creating Blu-ray Discs

You can create Blu-ray Discs from AVCHD movies imported to a computer. The computer must be capable of creating Blu-ray Discs. BD-R (not re-writable) or BD-RE (rewritable) discs can be used. Multi-session recordings cannot be made. To create Blu-ray Discs using PlayMemories Home, be sure to install the dedicated add-on software. For details, see the following URL:

<http://support.d-imaging.sony.co.jp/BDUW/>

To install, your computer must be connected to the Internet. For detailed operations, see the Help of PlayMemories Home.

Note

- To play back a Blu-ray Disc that was created using movies recorded in [60p 28M(PS)]/[50p 28M(PS)], you must use a device that is compliant with AVCHD format Ver. 2.0.

4-543-698-11(1)

Copyright 2014 Sony Corporation



Precautions

Backing up memory cards

Data may be corrupted in the following cases. Be sure to back up the data for protection.

- When the memory card is removed or the product is turned off during a read or write operation.
- When the memory card is used in locations subject to static electricity or electrical noise.

Creating an image database file

If you insert a memory card that does not contain an image database file into the product and turn on the power, the product automatically creates an image database file using some of the memory card's capacity. The process may take a long time and you cannot operate the product until the process is completed.

If a database file error occurs, export all images to your computer using PlayMemories Home, and then format the memory card using this product.

Do not use/store the product in the following places

- In an extremely hot, cold or humid place
In places such as in a car parked in the sun, the camera body may become deformed and this may cause a malfunction.
- Storing under direct sunlight or near a heater
The camera body may become discolored or deformed, and this may cause a malfunction.
- In a location subject to rocking vibration
- Near strong magnetic place
- In sandy or dusty places
Be careful not to let sand or dust get into the product. This may cause the product to malfunction, and in some cases this malfunction cannot be repaired.

On operating temperatures

Your product is designed for use under the temperatures between 0°C and 40 °C (32 °F and 104 °F). Shooting in extremely cold or hot places that exceed this range is not recommended.

On moisture condensation

- If the product is brought directly from a cold to a warm location, moisture may condense inside or outside the product. This moisture condensation may cause a malfunction of the product.
- To prevent moisture condensation when you bring the product directly from a cold to a warm location, first put it in a plastic bag and seal it to prevent air from entering. Wait for about an hour until the temperature of the product has

reached the ambient temperature.

- If moisture condensation occurs, turn off the product and wait about an hour for the moisture to evaporate. Note that if you attempt to shoot with moisture remaining inside the lens, you will be unable to record clear images.

On the functions available with the product

This manual describes the functions of 1080 60i-compatible devices and 1080 50i-compatible devices. To check whether this product is a 1080 60i-compatible device or 1080 50i-compatible device, look for the following marks on the bottom of the product.

- 1080 60i-compatible device: 60i
- 1080 50i-compatible device: 50i

Notes for when on board an airplane

- In an airplane, set [Airplane Mode] to [On].

On image data compatibility

This product conforms with DCF (Design rule for Camera File system) universal standard established by JEITA (Japan Electronics and Information Technology Industries Association).

- Playback of images recorded with your product on other equipment and playback of images recorded or edited with other equipment on your product are not guaranteed.

Notes on playing movies on other devices

- This product uses MPEG-4 AVC/H.264 High Profile for AVCHD format recording. For this reason, movies recorded in AVCHD format with this product cannot be played by the following devices.
 - _Other devices compatible with AVCHD format that does not support High Profile
 - _Devices incompatible with the AVCHD format

This product also uses MPEG-4 AVC/H.264 Main Profile for MP4 format recording. For this reason, play back movies recorded in MP4 format with this product on MPEG-4 AVC/H.264 supported devices.

- Discs recorded with HD (high definition) image quality can be played back only on AVCHD format-compatible devices.

DVD-based players or recorders cannot play back HD image quality discs, as they are incompatible with the AVCHD format. Also, DVD-based players or recorders may fail to eject HD image quality discs that are recorded using the AVCHD format.

On the monitor and lens

- The monitor is manufactured using extremely high-precision technology so over 99.99 % of the pixels are operational for effective use. However, there may be some tiny black points and/or bright points (white, red, blue or green in color) that constantly appear on the monitor. These points are normal in the manufacturing process and do not affect the images in any way.
- Exposing the monitor or lens to direct sunlight for long periods may cause a malfunction. Exercise caution when placing the product near a window or outdoors.
- Do not press against the monitor. The monitor may be discolored and that may cause a malfunction.
- Images may trail across on the monitor in a cold location. This is not a malfunction.
- If the monitor has drops of water or other liquids on it, wipe it with a soft cloth. If the monitor stays wet, the surface of the monitor may change or deteriorate. This may cause a malfunction.

- In addition, the monitor may be darker than usual at first.
- Make sure not to bump the lens or subject it to force.
- Do not operate the touch panel using a pointed object. This may cause a malfunction.

Notes on the flash

- Do not cover the flash with your fingers.
- Do not carry the product by the flash unit, or use excessive strength on it.
- If water, dust or sand get into the open flash unit, it may cause a malfunction.

Notes on discarding or transferring this product to others

When discarding or transferring this product to others, make sure to perform the following operation to protect private information.

- Perform [Setting Reset] to reset all the settings.

4-543-698-11(1)

Copyright 2014 Sony Corporation

Interchangeable Lens Digital Camera
ILCE-5100

On the internal rechargeable battery

This camera has an internal rechargeable battery for maintaining the date and time and other settings regardless of whether the power is on or off, or whether the battery pack is charged or discharged. This rechargeable battery is continually charged as long as you are using the product. However, if you use the product for only short periods, it gradually discharges. If you do not use the product at all for about 2 month(s) it becomes completely discharged. In this case, be sure to charge this rechargeable battery before using the product. However, even if this rechargeable battery is not charged, you can still use the product as long as you do not record the date and time.

Charging method of the internal rechargeable battery

Insert a charged battery pack into the product, or connect the product to a wall outlet (wall socket) using the AC Adaptor (supplied), and leave the product for 24 hours or more with the power off.

4-543-698-11(1)

Copyright 2014 Sony Corporation



Notes on the battery pack

Charging the battery pack

- Charge the battery pack (supplied) before using the product for the first time.
- The charged battery pack will discharge little by little even if you do not use it. Charge the battery pack each time before you use the product so that you do not miss any opportunities to shoot images.
- You can charge the battery pack even if it is not completely discharged. You can use a partially charged battery pack.
- If the Charge lamp flashes and charging is canceled halfway, remove the battery pack once then reinsert it.
- We recommend charging the battery pack in an ambient temperature of between 10 °C and 30 °C (50 °F and 86 °F). The battery pack may not be effectively charged in temperatures outside this range.
- When you connect this product and a laptop computer that is not connected to a power source, the laptop's battery charge may decrease. Do not charge this product using the laptop computer for too long.
- Do not turn on/restart a computer, wake a computer from sleep mode, or turn off a computer while this product is connected to the computer via USB cable. Doing so may cause a malfunction of this product. Disconnect the product and the computer before performing the above operations.
- We do not guarantee charging if you are using a self-built or modified computer.

Charging time (Full charge)

The charging time is approximately 310 minutes using the AC adaptor (supplied). The above charging time applies when charging a fully depleted battery pack at a temperature of 25°C (77°F). Charging may take longer depending on conditions of use and circumstances.

Effective use of the battery pack

- Battery performance decreases in low temperature environments. So in cold places, the operational time of the battery pack is shorter. To ensure longer battery pack use, we recommend putting the battery pack in your pocket close to your body to warm it up, and insert it in the product immediately before you start shooting. If there are any metal objects such as keys in your pocket, be careful of causing a short-circuit.
- The battery pack will run down quickly if you use the flash or zoom frequently.
- We recommend preparing spare battery packs and taking trial shots before taking the actual shots.
- Do not expose the battery pack to water. The battery pack is not water-resistant.
- Do not leave the battery pack in extremely hot places, such as in a car or under direct sunlight.
- If the battery terminal is dirty, you may not be able to turn on the product or the battery pack may not be properly charged. In that case, clean the battery by lightly wiping off any dust using a soft cloth or a cotton swab.

Remaining battery indicator

The remaining battery indicator appears on the screen.



A: Battery level high

B: Battery exhausted

- It takes about one minute for the correct remaining battery indicator to appear.
- The correct remaining battery indicator may not be displayed under some operating or environmental conditions.
- If the remaining battery time does not appear on the screen, press the DISP (Display Setting) button to display it.

How to store the battery pack

- To maintain the battery pack's function, charge the battery pack and then fully discharge it in the product at least once a year before storing it. Store the battery pack in a cool, dry place.
- To use the battery pack up, leave the product in slide show playback mode until the power goes off.
- To prevent staining the terminal, short-circuiting, etc., be sure to use a plastic bag to keep away from metal materials when carrying or storing the battery pack.

On battery life

- The battery life is limited. If you use the same battery repeatedly, or use the same battery for a long period, the battery capacity decreases gradually. If the available time of the battery is shortened significantly, it is probably time to replace the battery pack with a new one.
- The battery life varies according to how the battery pack is stored and the operating conditions and environment in which each battery pack is used.

4-543-698-11(1)

Copyright 2014 Sony Corporation



Charging the battery pack

- The supplied AC Adaptor is dedicated to this product. Do not connect with other electronic devices. Doing so may cause a malfunction.
- Make sure to use a genuine Sony AC Adaptor.
- If the product's Charge lamp flashes while charging, remove the battery pack being charged, and then insert the same battery pack firmly back into the product. If the Charge lamp flashes again, this may indicate a faulty battery or that a battery pack other than the specified type has been inserted. Check that the battery pack is the specified type. If the battery pack is the specified type, remove the battery pack, replace it with a new or different one and check that the newly inserted battery is charging correctly. If the newly inserted battery is charging correctly, the previously inserted battery may be faulty.
- If the Charge lamp flashes even if the AC Adaptor is connected to the product and the wall outlet (wall socket), this indicates that charging has stopped temporarily and is on standby. Charging stops and enters standby status automatically when the temperature is outside of the recommended operating temperature. When the temperature returns to the appropriate range, charging resumes and the Charge lamp lights up again. We recommend charging the battery pack in an ambient temperature of between 10°C to 30°C (50°F to 86°F).



Interchangeable Lens Digital Camera
ILCE-5100

Memory card

Memory card

Card Type Indications in Help Guide

Memory Stick PRO Duo media

(Memory Stick XC-HG Duo media/Memory Stick PRO Duo media/Memory Stick PRO-HG Duo media)

SD card

(SD memory card/SDHC memory card/SDXC memory card)

- Memory Stick PRO Duo media and SD cards up to 64 GB have been tested and proven to operate with this product.
- When recording movies, the following memory cards are recommended:
 - **MEMORY STICK PRO DUO** (Mark2) (Memory Stick PRO Duo media (Mark2))
 - **MEMORY STICK XC-HG DUO** (Memory Stick XC-HG Duo media (Mark2))
 - **MEMORY STICK PRO-HG DUO** (Memory Stick PRO-HG Duo media)
 - Class 4 SD card or faster
- When recording XAVC S format movies, use the following memory cards:
 - SDXC memory card with a capacity of at least 64 GB (Class 10 or faster)
 - UHS-I compatible SDXC memory card with a capacity of at least 64 GB
 - Memory Stick XC-HG Duo media
- This product supports UHS-I-compatible SD cards.

Note

- When you use a memory card with this product for the first time, it is recommended that you format the card using the product for stable performance of the memory card before shooting.
Note that formatting permanently erases all data on the memory card, and is unrecoverable. Save precious data on a computer, etc.
- If you repeatedly shoot and delete images for a long time, fragmentation of data in a file in the memory card may occur, and movie recording may be interrupted in the middle of shooting. If this happens, save your images to a computer or other storage location, then execute [Format].
- Memory card formatted with a computer is not guaranteed to operate with the product.
- Data read/write speeds differ depending on the combination of the memory card and the equipment used.
- We recommend backing up important data, such as to a hard disk of a computer.
- Do not attach a label on the memory card itself nor on a memory card adaptor.
- Do not touch the terminal section of the memory card with your hand or a metal object.
- Do not strike, bend or drop the memory card.
- Do not disassemble or modify the memory card.
- Do not expose the memory card to water.

- Do not leave the memory card within the reach of small children. They might accidentally swallow it.
- The memory card may be hot just after it has been used for a long time. Be careful when you handle it.
- Do not insert a memory card that does not fit the memory card slot. Doing so will cause a malfunction.
- Do not use or store the memory card under the following conditions:
 - High temperature locations such as in a car parked under the sun
 - Locations exposed to direct sunlight
 - Humid locations or locations with corrosive substances present
- Images recorded on a Memory Stick XC-HG Duo media and SDXC memory card cannot be imported to or played on computers or AV devices that are not compatible with exFAT when connected using a micro USB cable. Make sure that the device is compatible with exFAT before connecting it to the product. If you connect your product to an incompatible device, you may be prompted to format the card. Never format the card in response to this prompt, as doing so will erase all data on the card. (exFAT is the file system used on Memory Stick XC-HG Duo media and SDXC memory cards.)

Memory Stick media

The types of Memory Stick media that can be used with the product are as follows. However, proper operation cannot be guaranteed for all Memory Stick media functions.

- Memory Stick PRO Duo media: *1*2*3
- Memory Stick PRO-HG Duo media: *1*2
- Memory Stick XC-HG Duo media: *1*2

*1This Memory Stick is equipped with MagicGate function. MagicGate is copyright protection technology that uses encryption technology. Data recording/playback that requires MagicGate functions cannot be performed with this product.

*2High-speed data transfer using a parallel interface is supported.

*3When recording movies, only media marked with Mark2 can be used.

Notes on using Memory Stick Micro media (sold separately)

- This product is compatible with Memory Stick Micro media (M2). M2 is an abbreviation for Memory Stick Micro media.
- To use a Memory Stick Micro media with this product, be sure to insert the Memory Stick Micro media into an M2 Adaptor as large as Duo size. If you insert a Memory Stick Micro media into the product without an M2 Adaptor as large as Duo size, you might not be able to remove it from the product.
- Do not leave the Memory Stick Micro media within the reach of small children. They might accidentally swallow it.

4-543-698-11(1)

Copyright 2014 Sony Corporation



On cleaning

Cleaning the lens and flash

Wipe the lens and flash with a soft cloth to remove fingerprints, dust, etc.

Cleaning the lens

- Do not use a cleaning solution containing organic solvents, such as thinner, or benzine.
- When cleaning the lens surface, remove dust with a commercially available blower. In case of dust that sticks to the surface, wipe it off with a soft cloth or tissue paper slightly moistened with lens cleaning solution. Wipe in a spiral pattern from the center to the outside. Do not spray lens cleaning solution directly onto the lens surface.

Cleaning the flash

Clean the flash surface before use. The heat of the flash emission may cause dirt on the flash surface to start smoking or burning. Wipe the flash surface with a soft cloth to remove dirt or dust, etc.

Cleaning the camera body

Do not touch the parts of the product inside the lens mount, such as a lens signal contact. To clean inside the lens mount, use a commercially available blower* to blow any dust off.

*Do not use a spray-type blower as doing so may cause a malfunction.

Cleaning the product surface

Clean the product surface with a soft cloth slightly moistened with water, then wipe the surface with a dry cloth. To prevent damage to the finish or casing:

- Do not expose the product to chemical products such as thinner, benzine, alcohol, disposable cloths, insect repellent, sunscreen or insecticide.
- Do not touch the product with any of the above on your hand.
- Do not leave the product in contact with rubber or vinyl for a long time.

Cleaning the monitor

- If oil from your hand or hand cream, etc., remain on the monitor, the original coating may become easily removable. Wipe oil or hand cream off as soon as possible.
- If you wipe the monitor firmly using tissue paper, etc., the coating may be scratched.
- If the monitor becomes dirty with fingerprints or dust, gently remove the dust from the surface, and then clean the monitor using soft cloth, etc.



Interchangeable Lens Digital Camera
ILCE-5100

Cleaning the image sensor

Follow the steps below to clean the image sensor.

1. Turn off the product.
2. Remove the lens.
3. Blow off dust on and around the image sensor surface using a blower for camera cleaning.
4. Attach the lens.

Note

- A blower is not supplied with this product. Use a commercially available blower for camera cleaning.
- Do not use a spray-type blower as doing so may scatter water droplets inside the product body.
- Do not insert the tip of the blower into the cavity beyond the lens mount area, in order to make sure that the tip of the blower does not touch the image sensor.
- Hold the camera facing slightly downward so that the dust falls out.
- Do not expose the product to any shock during cleaning.
- When cleaning the image sensor with a blower, do not blow too hard. If you blow on the sensor too hard, the inside of the product may be damaged.
- If the dust remains even after you have performed cleaning as described, consult your service facility.

4-543-698-11(1)

Copyright 2014 Sony Corporation

Interchangeable Lens Digital Camera
ILCE-5100

Number of still images

The number of still images may vary depending on the shooting conditions and the memory card.

[ Image Size]: [L: 24M]

When [ Aspect Ratio] is set to [3:2]*

Standard

2GB: 330 images

4GB: 660 images

8GB: 1340 images

16GB: 2700 images

32GB: 5400 images

64GB: 10500 images

Fine

2GB: 200 images

4GB: 410 images

8GB: 820 images

16GB: 1650 images

32GB: 3300 images

64GB: 6600 images

RAW & JPEG

2GB: 54 images

4GB: 105 images

8GB: 220 images

16GB: 440 images

32GB: 880 images

64GB: 1750 images

RAW

2GB: 74 images



4GB: 145 images

8GB: 300 images

16GB: 600 images

32GB: 1200 images

64GB: 2400 images

*When the [ Aspect Ratio] is set to other than [3:2], you can record more pictures than shown above. (Except when [ Quality] is set to [RAW].)

Note

- Even if the number of remaining shootable images is greater than 9,999, the “9999” indicator appears.
- When an image shot with other products is played back on this product, the image may not appear in the actual image size.

4-543-698-11(1)

Copyright 2014 Sony Corporation

Interchangeable Lens Digital Camera
 ILCE-5100

Recordable time of movies

The table below shows the approximate maximum recording times which can be recorded on the memory card that is formatted with this product. These numbers are the total times of all movie files on the memory card. The recordable time may vary depending on the shooting conditions and the memory card.

The values when [ File Format] is set to [XAVC S] and [AVCHD] are based on shooting with [Dual Video REC] set to [Off].

(h (hour), m (minute))

 [ File Format]:[XAVC S]

60p 50M

50p 50M

2GB: -

4GB: -

8GB: -

16GB: -

32GB: -

64GB: 2 h 35 m

30p 50M

25p 50M

2GB: -

4GB: -

8GB: -

16GB: -

32GB: -

64GB: 2 h 35 m

24p 50M (Only for 1080 60i compatible models.)

2GB: -

4GB: -

8GB: -

16GB: -

32GB: -

64GB: 2 h 35 m

 [ File Format]:[AVCHD]

60i 24M(FX)

50i 24M(FX)

2GB: 10 m

4GB: 20 m
8GB: 40 m
16GB: 1 h 30 m
32GB: 3 h
64GB: 6 h
60i 17M(FH)
50i 17M(FH)
2GB: 10 m
4GB: 30 m
8GB: 1 h
16GB: 2 h
32GB: 4 h 5 m
64GB: 8 h 15 m
60p 28M(PS)
50p 28M(PS)
2GB: 9 m
4GB: 15 m
8GB: 35 m
16GB: 1 h 15 m
32GB: 2 h 30 m
64GB: 5 h 5 m
24p 24M(FX)
25p 24M(FX)
2GB: 10 m
4GB: 20 m
8GB: 40 m
16GB: 1 h 30 m
32GB: 3 h
64GB: 6 h
24p 17M(FH)
25p 17M(FH)
2GB: 10 m
4GB: 30 m
8GB: 1 h
16GB: 2 h
32GB: 4 h
64GB: 8 h
[ File Format]:[MP4]
1440×1080 12M
2GB: 20 m
4GB: 40 m
8GB: 1 h 20 m
16GB: 2 h 45 m
32GB: 5 h 30 m
64GB: 11 h
VGA 3M

2GB: 1 h 10 m
4GB: 2 h 25 m
8GB: 4 h 55 m
16GB: 10 h
32GB: 20 h
64GB: 40 h

Continuous shooting is possible for approximately 29 minutes for each shooting (limited by product specifications). For [MP4 12M] size movies, continuous shooting is possible for approximately 20 minutes (limited by 2 GB file size).

Note

- The recordable time of movies varies because the product is equipped with VBR (Variable Bit Rate), which automatically adjusts image quality depending on the shooting scene.
When you record a fast-moving subject, the image is clearer but the recordable time is shorter because more memory is required for recording.
The recordable time also varies depending on the shooting conditions, the subject or the image quality/size settings.

Notes on continuous movie recording

- It requires a lot of power to perform high quality movie recording or continuous shooting using the image sensor. Therefore, if you continue to shoot, the temperature inside the camera will rise, especially that of the image sensor. In such cases, the camera turns off automatically since higher temperatures affect the quality of the images or affect the internal mechanism of the camera.
- The duration of time available for movie recording is as follows when the camera starts recording with the camera's default settings after the power of the camera has been turned off for a while. (The following values indicate the continuous time from when the camera starts recording until the camera stops recording.)
Ambient temperature: 20°C (68°F) Continuous recording time for movies: About 29 minutes
Ambient temperature: 30°C (86°F) Continuous recording time for movies: About 29 minutes
Ambient temperature: 40°C (104°F) Continuous recording time for movies: About 20 minutes
- The duration of time available for movie recording varies with the temperature, the recording format/setting, or condition of the camera before you start recording. If you frequently recompose or shoot images after the power is turned on, the temperature inside the camera will rise and the recording time available will be shorter.
- When  is indicated, stop recording the movie.
- If the camera stops recording due to the temperature, leave it for several minutes with the power turned off. Start recording after the temperature inside the camera drops fully.

4-543-698-11(1)

Copyright 2014 Sony Corporation

Interchangeable Lens Digital Camera
ILCE-5100

Plug adaptor

You can use the AC Adaptor (supplied) in any country or region where the power supply is within 100 V to 240 V AC and 50 Hz/60 Hz.

Note

- Do not use an electronic voltage transformer as doing so may cause a malfunction.

4-543-698-11(1)

Copyright 2014 Sony Corporation



Interchangeable Lens Digital Camera
ILCE-5100

On TV color systems

To view movies shot using this product on a television, the product and television must use the same color television system. Check the TV color system for the country or region where you are using the product.

- NTSC system:
Bahama Islands, Bolivia, Canada, Central America, Chile, Colombia, Ecuador, Jamaica, Japan, Korea, Mexico, Peru, Surinam, Taiwan, the Philippines, the U.S.A., Venezuela, etc.
- PAL system:
Australia, Austria, Belgium, China, Croatia, Czech Republic, Denmark, Finland, Germany, Holland, Hong Kong, Hungary, Indonesia, Italy, Kuwait, Malaysia, New Zealand, Norway, Poland, Portugal, Rumania, Singapore, Slovak Republic, Spain, Sweden, Switzerland, Thailand, Turkey, United Kingdom, Viet Nam, etc.
- PAL-M system:
Brazil
- PAL-N system:
Argentina, Paraguay, Uruguay
- SECAM system:
Bulgaria, France, Greece, Guiana, Iran, Iraq, Monaco, Russia, Ukraine, etc.

4-543-698-11(1)

Copyright 2014 Sony Corporation

Interchangeable Lens Digital Camera
ILCE-5100

Mount Adaptor

Using a Mount Adaptor (sold separately), you can attach an A-mount lens (sold separately) to this product. For details, refer to the operating instructions supplied with the Mount Adaptor.

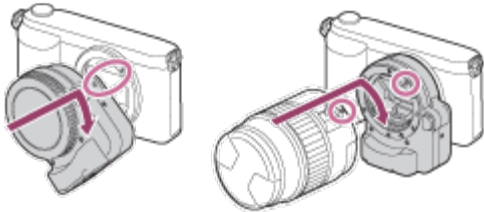

Note

- You may not be able to use the Mount Adaptor with certain lenses. Consult your Sony dealer or local authorized Sony service facility on compatible lenses.
- You cannot use the AF illuminator when using an A-mount lens.
- The sound of the lens and the product in operation may be recorded during movie recording. You can turn the sound off by selecting MENU → [Camera Settings] → [Audio Recording] → [Off].
- It may take a long time or may be difficult for the product to focus, depending on the lens used or the subject.
- The light of the flash may be blocked by the lens attached.

Related Topic

- [LA-EA1 Mount Adaptor](#)
- [LA-EA2 Mount Adaptor](#)
- [LA-EA3 Mount Adaptor](#)
- [LA-EA4 Mount Adaptor](#)



Interchangeable Lens Digital Camera
ILCE-5100

LA-EA1 Mount Adaptor

If you use the LA-EA1 Mount Adaptor (sold separately), the following functions are available.

Autofocus:

Available with SAM/SSM lens only*

AF system:

Contrast AF

AF/MF Select:

Can be changed using the operating switch on the lens.

Focus Mode:

Single-shot AF

*When an A-mount lens is attached, the autofocus speed will be slower than when an E-mount lens is attached. (Approximately two to seven seconds slower (for shooting based on the Sony measurement conditions). This may vary depending on conditions such as subject and brightness during shooting.)

- When using a Mount Adaptor, the Auto Focus does not work in movie mode.
- When using a Mount Adaptor in movie mode, adjust the aperture manually.

Available focus area

When the LA-EA1 Mount Adaptor is mounted, the available focus areas are the same as for the available settings of this camera.

Related Topic

 [Focus Area](#)



Interchangeable Lens Digital Camera
ILCE-5100

LA-EA2 Mount Adaptor

If you use the LA-EA2 Mount Adaptor (sold separately), the following functions are available.

Autofocus:

Available

AF system:

Phase Detection AF, which is controlled by the dedicated AF sensor inside the Mount Adaptor

AF/MF Select:

SAM lens:

Can be changed using the operating switch on the lens.

SSM lens:

Can be changed using the operating switch on the lens. When the switch on the lens is set to AF, you can use MENU to change the focus method.

Other lenses:

Can be changed using MENU.

Focus Mode:

Available modes are as follows (Single-shot AF/Continuous AF)

Available focus area

Wide:

The product automatically selects a focus area from among 15 areas.

Center:

The product uses the focus area located in the center area exclusively.

Flexible Spot:

You can select a focus area from 15 areas using the control wheel.



Interchangeable Lens Digital Camera
ILCE-5100

LA-EA3 Mount Adaptor

If you use the LA-EA3 Mount Adaptor (sold separately), the following functions are available.

Autofocus:

Available with SAM/SSM lens only*

AF system:

Contrast AF

AF/MF Select:

Can be changed using the operating switch on the lens.

Focus Mode:

Single-shot AF

*When an A-mount lens is attached, the autofocus speed will be slower than when an E-mount lens is attached. (Approximately two to seven seconds slower (for shooting based on the Sony measurement conditions). This may vary depending on conditions such as subject and brightness during shooting.)

- When using a Mount Adaptor, the Auto Focus does not work in movie mode.
- When using a Mount Adaptor in movie mode, adjust the aperture manually.

Available focus area

When the LA-EA3 Mount Adaptor is mounted, the available focus areas are the same as for the available settings of this camera.

Related Topic

[Focus Area](#)



Interchangeable Lens Digital Camera
ILCE-5100

LA-EA4 Mount Adaptor

If you use the LA-EA4 Mount Adaptor (sold separately), the following functions are available.

Autofocus:

Available

AF system:

Phase Detection AF, which is controlled by the dedicated AF sensor inside the Mount Adaptor

AF/MF Select:

SAM lens:

Can be changed using the operating switch on the lens.

SSM lens:

Can be changed using the operating switch on the lens. When the switch on the lens is set to AF, you can use MENU to change the focus method.

Other lenses:

Can be changed using MENU.

Focus Mode:

Available modes are as follows

(Single-shot AF/Continuous AF/Automatic AF)

Available focus area

Wide:

The product automatically selects a focus area from among 15 areas.

Center:

The product uses the focus area located in the center area exclusively.

Flexible Spot:

You can select a focus area from 15 areas using the control wheel.

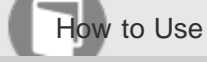

Interchangeable Lens Digital Camera
ILCE-5100

AVCHD format

The AVCHD format was developed for high-definition digital video cameras when recording an HD (High-Definition) signal using high-efficiency compression coding technology. The MPEG-4 AVC/H.264 format is used to compress video data, and the Dolby Digital or Linear PCM system is used to compress audio data.

The MPEG-4 AVC/H.264 format is capable of compressing images at higher efficiency than that of the conventional image compressing format.

- As the AVCHD format uses compression coding technology, the picture may be unstable in scenes where the screen, angle of view, or brightness, etc. change drastically, but this is not a malfunction.

4-543-698-11(1)

Copyright 2014 Sony Corporation

Interchangeable Lens Digital Camera
ILCE-5100

License

Notes on the License

This product comes with software that are used based on licensing agreements with the owners of that software. Based on requests by the owners of copyright of these software applications, we have an obligation to inform you of the following. Please read the following sections. Licenses (in English) are recorded in the internal memory of your product. Establish a Mass Storage connection between the product and a computer to read licenses in the “PMHOME” - “LICENSE” folder.

THIS PRODUCT IS LICENSED UNDER THE AVC PATENT PORTFOLIO LICENSE FOR THE PERSONAL USE OF A CONSUMER OR OTHER USES IN WHICH IT DOES NOT RECEIVE REMUNERATION TO

(i) ENCODE VIDEO IN COMPLIANCE WITH THE AVC STANDARD (“AVC VIDEO”)
AND/OR

(ii) DECODE AVC VIDEO THAT WAS ENCODED BY A CONSUMER ENGAGED IN A PERSONAL ACTIVITY AND/OR WAS OBTAINED FROM A VIDEO PROVIDER LICENSED TO PROVIDE AVC VIDEO.

NO LICENSE IS GRANTED OR SHALL BE IMPLIED FOR ANY OTHER USE. ADDITIONAL INFORMATION MAY BE OBTAINED FROM MPEG LA, L.L.C. SEE [HTTP://WWW.MPEGLA.COM](http://www.mpegla.com)

On GNU GPL/LGPL applied software

The software that is eligible for the following GNU General Public License (hereinafter referred to as “GPL”) or GNU Lesser General Public License (hereinafter referred to as “LGPL”) are included in the product.

This informs you that you have a right to have access to, modify, and redistribute source code for these software programs under the conditions of the supplied GPL/LGPL.

Source code is provided on the web.

Use the following URL to download it.

<http://www.sony.net/Products/Linux/>



We would prefer you do not contact us about the contents of source code.



Licenses (in English) are recorded in the internal memory of your product. Establish a Mass Storage connection between the product and a computer to read licenses in the “PMHOME” - “LICENSE” folder.

Interchangeable Lens Digital Camera
ILCE-5100

Trademarks

- The following marks are registered trademarks or trademarks of Sony Corporation.

, , Memory Stick, **MEMORY STICK PRO**, Memory Stick PRO, **MEMORY STICK DUO**, Memory Stick Duo, **MEMORY STICK PRO DUO**, Memory Stick PRO Duo, **MEMORY STICK PRO-HG DUO**, Memory Stick PRO-HG Duo, **MEMORY STICK XC-HG DUO**, Memory Stick XC-HG Duo, **MEMORY STICK MICRO**, Memory Stick Micro, **MAGIC GATE**, MagicGate, PhotoTV HD, InfoLITHIUM, PlayMemories Online, PlayMemories Online logo, PlayMemories Home, PlayMemories Home logo, PlayMemories Mobile, PlayMemories Mobile logo, PlayMemories Camera Apps, PlayMemories Camera Apps logo

- XAVC S and  are registered trademarks of Sony Corporation.
- Blu-ray Disc™ and Blu-ray™ are trademarks of the Blu-ray Disc Association.
- AVCHD Progressive and AVCHD Progressive logotype are trademarks of Panasonic Corporation and Sony Corporation.
- Dolby and the double-D symbol are trademarks of Dolby Laboratories.
- HDMI, the HDMI logo and High-Definition Multimedia Interface are trademarks or registered trademarks of HDMI Licensing LLC.
- Microsoft, Windows and DirectX are either registered trademarks or trademarks of Microsoft Corporation in the United States and/or other countries.
- Mac and Mac OS are trademarks of Apple Inc.
- iOS is a registered trademark or trademark of Cisco Systems Inc.
- iPhone and iPad are trademarks of Apple Inc., registered in the U.S. and other countries.
- SDXC logo is a trademark of SD-3C, LLC.
- Android and Google Play are trademarks or registered trademarks of Google Inc.
- Wi-Fi, the Wi-Fi logo, Wi-Fi PROTECTED SET-UP are registered trademarks or trademarks of the Wi-Fi Alliance.
- The N Mark is a trademark or registered trademark of NFC Forum, Inc. in the United States and in other countries.
- DLNA and DLNA CERTIFIED are trademarks of Digital Living Network Alliance.
-  and "PlayStation" are registered trademarks of Sony Computer Entertainment Inc.



- Add further enjoyment with your PlayStation 3 by downloading the application for PlayStation 3 from PlayStation Store

(where available.)

- The application for PlayStation 3 requires PlayStation Network account and application download. Accessible in areas where the PlayStation Store is available.
- Eye-Fi is a trademark of Eye-Fi Inc.
- In addition, system and product names used in this manual are, in general, trademarks or registered trademarks of their respective developers or manufacturers. However, the ™ or ® marks may not be specified in all cases in this manual.

4-543-698-11(1)

Copyright 2014 Sony Corporation

Interchangeable Lens Digital Camera
ILCE-5100

Troubleshooting

If you experience trouble with the product, try the following solutions.

1. Check the items under “Troubleshooting”, then check the product.
2. Remove the battery pack, wait for about one minute, re-insert the battery pack, then turn on the power.
3. Initialize the settings.
4. Consult your dealer or local authorized service facility. Additional information on this product and answers to frequently asked questions can be found at our Customer Support Website.

<http://www.sony.net/>

Related Topic

● [Setting Reset](#)

4-543-698-11(1)

Copyright 2014 Sony Corporation



Interchangeable Lens Digital Camera
ILCE-5100

You cannot insert the battery pack into the product.

- Make sure the direction of the battery pack is correct, and insert it until the lock lever is locked.

4-543-698-11(1)

Copyright 2014 Sony Corporation

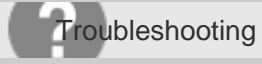

Interchangeable Lens Digital Camera
ILCE-5100

You cannot turn on the product.

- After inserting the battery pack into the product, it may take a few moments for the product to power up.
- Make sure that the battery pack is inserted correctly.
- The battery pack will discharge by itself even if you do not use it. Charge the battery pack before use.
- Make sure that the battery is NP-FW50.

4-543-698-11(1)

Copyright 2014 Sony Corporation



Interchangeable Lens Digital Camera
ILCE-5100

The power turns off suddenly.

- Depending on the product and battery pack temperature, the product may turn off automatically to protect itself. In this case, a message is displayed on the product screen before the product turns off.

4-543-698-11(1)

Copyright 2014 Sony Corporation



Interchangeable Lens Digital Camera
ILCE-5100

The product gets hot.

- When the product is used for a long time, the temperature of the product will rise. If the product gets too hot, movie recording may be interrupted or the power may turn off automatically to protect the product.

4-543-698-11(1)

Copyright 2014 Sony Corporation



The remaining battery level indicator shows an incorrect level.

- This phenomenon occurs when you use the product in an extremely hot or cold location.
- There may be a difference between the remaining battery level indicator and the actual remaining battery charge. Deplete the battery pack once, then charge it so that the remaining battery level indicator is reset. The correct remaining battery level indicator may not be displayed under some operating or environmental conditions.
- Battery capacity decreases over time and through repeated use. If decreased usage time between charges becomes significant, it is probably time to replace it with a new one.

4-543-698-11(1)

Copyright 2014 Sony Corporation

Interchangeable Lens Digital Camera
ILCE-5100

The charge lamp on the product flashes when charging the battery pack.

- Make sure that the battery is NP-FW50.
- Remove the battery pack and then reinsert it into the product.
- Batteries which have not been used for more than a year may have deteriorated.
- This phenomenon occurs when you charge the battery pack in an extremely hot or cold location. The optimum temperature for charging the battery pack is between 10 °C and 30 °C (50 °F and 86 °F).

Related Topic

- [Notes on the battery pack](#)
- [Charging the battery pack](#)

4-543-698-11(1)

Copyright 2014 Sony Corporation



Interchangeable Lens Digital Camera
ILCE-5100

The battery pack inserted in the camera is not charging.

- Charge the battery pack with the camera's power turned off.

4-543-698-11(1)

Copyright 2014 Sony Corporation

Interchangeable Lens Digital Camera
ILCE-5100

The battery pack is not charged.

- When the battery pack is not charged (the charge lamp does not light) even if you follow the proper charging procedure, check if the power of the product is turned off, then remove the battery pack and re-insert the same battery pack securely, or disconnect and reconnect the USB cable.

4-543-698-11(1)

Copyright 2014 Sony Corporation



Interchangeable Lens Digital Camera
ILCE-5100

You cannot record images.

- You are using a memory card with a write-protect switch, and the switch is set to the LOCK position. Set the switch to the record position.
- Check the free capacity of the memory card.
- You cannot record images while charging the flash.
- The lens is not attached properly. Attach the lens properly.
- The [Self-timer] is activated.

4-543-698-11(1)

Copyright 2014 Sony Corporation

Interchangeable Lens Digital Camera
ILCE-5100

Recording takes a long time.

- The noise reduction function is processing an image. This is not a malfunction.
- You are shooting in RAW mode. Since RAW data files are large, RAW mode shooting may take time.
- The [Auto HDR] function is processing an image.
- The product is compiling images.

Related Topic

- [High ISO NR \(still image\)](#)
- [Auto HDR](#)
- [Superior Auto](#)

4-543-698-11(1)

Copyright 2014 Sony Corporation

Interchangeable Lens Digital Camera
ILCE-5100

The image is out of focus.

- The subject is too close. Check the minimum focal distance of the lens.
- Ambient light is insufficient.
- The subject you are shooting is not suitable for auto-focusing. Shoot in [Flexible Spot] mode or manual focus mode.

Related Topic

- [Focus Area](#)
- [Manual Focus](#)

4-543-698-11(1)

Copyright 2014 Sony Corporation

Interchangeable Lens Digital Camera
ILCE-5100

Zoom does not work.

- You cannot use zoom functions during Sweep Panorama shooting.
- You can use only the optical zoom in the following situations:
 - When using Smile Shutter function.
 - [Drive Mode] is set to [Self-portrait].
 - [ Quality] is set to [RAW] or [RAW & JPEG].

4-543-698-11(1)

Copyright 2014 Sony Corporation



Interchangeable Lens Digital Camera
ILCE-5100

The flash does not work.

- Raise the flash.
- You cannot use a flash in the following situations:
 - [Anti Motion Blur], [Night Scene] or [Hand-held Twilight] in Scene Selection is selected.
 - During Sweep Panorama shooting.
 - During movie recording.

4-543-698-11(1)

Copyright 2014 Sony Corporation



Interchangeable Lens Digital Camera
ILCE-5100

Fuzzy white circular spots appear on images shot using the flash.

- Particles (dust, pollen, etc.) in the air reflected the flash light and appeared on the image. This is not a malfunction.

4-543-698-11(1)

Copyright 2014 Sony Corporation



Interchangeable Lens Digital Camera
ILCE-5100

The recording date and time are not displayed on the screen.

- While shooting, the date and time are not displayed. They are displayed only during playback.

4-543-698-11(1)

Copyright 2014 Sony Corporation



Interchangeable Lens Digital Camera
ILCE-5100

The date and time are recorded incorrectly.

- Set the correct date and time.
- The area selected using [Area Setting] differs from the actual area. Select the actual area.

Related Topic

• [Date/Time Setup](#)

• [Area Setting](#)

4-543-698-11(1)

Copyright 2014 Sony Corporation



Interchangeable Lens Digital Camera
ILCE-5100

The aperture value and/or shutter speed flashes.

- The subject is too bright or too dark to shoot using the current aperture value and/or shutter speed settings. Readjust the settings.

4-543-698-11(1)

Copyright 2014 Sony Corporation



Interchangeable Lens Digital Camera
ILCE-5100

The image colors are not correct.

- Adjust [White Balance].
- [Picture Effect] is set. Set [Picture Effect] to [Off].
- To reset settings to default, perform [Setting Reset].

Related Topic

- [White Balance](#)
- [Picture Effect](#)
- [Setting Reset](#)

4-543-698-11(1)

Copyright 2014 Sony Corporation



Interchangeable Lens Digital Camera
ILCE-5100

Noise appears in the image when you view the screen in a dark place.

- The product is attempting to increase the visibility of the screen by temporarily brightening the monitor under conditions of low illumination. There is no effect on the recorded image.

4-543-698-11(1)

Copyright 2014 Sony Corporation

Interchangeable Lens Digital Camera
ILCE-5100

The eyes of the subject come out red.

- Set [Red Eye Reduction] to [On].
- Shoot the subject at a distance closer than the flash range using the flash.
- Light the room and shoot the subject.

Related Topic

 [Red Eye Reduction](#)

4-543-698-11(1)

Copyright 2014 Sony Corporation



Interchangeable Lens Digital Camera
ILCE-5100

Dots appear and remain on the screen.

- This is not a malfunction. These dots are not recorded.

4-543-698-11(1)

Copyright 2014 Sony Corporation



Interchangeable Lens Digital Camera
ILCE-5100

You cannot shoot images continuously.

- The memory card is full. Delete unnecessary images.
- The battery level is low. Insert a charged battery pack.

4-543-698-11(1)

Copyright 2014 Sony Corporation

Interchangeable Lens Digital Camera
ILCE-5100

The image is whitish (Flare)./Blurring of light appears on the image (Ghosting).

- When pointing the lens toward the strong light source, excessive light enters the lens and the image may come out white (flare) or extraneous light (ghost images) may appear on the image, but this is not a malfunction. When using the zoom lens, attach the lens hood. Also, set up the composition so that you shoot images while avoiding backlit condition.

4-543-698-11(1)

Copyright 2014 Sony Corporation

Interchangeable Lens Digital Camera
ILCE-5100

The corners of the picture are too dark.

- If any filter or hood is used, take it off and try shooting again. Depending on the thickness of the filter and improper attachment of the hood, the filter or the hood may partially appear in the image. The optical properties of some lenses may cause the periphery of the image to appear too dark (insufficient light). You may compensate for this phenomenon with [Shading Comp.].

Related Topic

● [Shading Comp.](#)

4-543-698-11(1)

Copyright 2014 Sony Corporation



Interchangeable Lens Digital Camera
ILCE-5100

The image is blurred.

- Make sure that [SteadyShot] is set to [On].
- The picture was taken in a dark location without the flash, resulting in camera-shake. The use of a tripod or the flash is recommended. [Hand-held Twilight] and [Anti Motion Blur] in [Scene Selection] are also effective in reducing blur.

Related Topic

[Using flash](#)

[Scene Selection](#)

4-543-698-11(1)

Copyright 2014 Sony Corporation



Interchangeable Lens Digital Camera
ILCE-5100

The LCD screen darkens after a short period of time passed.

- If you do not operate the product for a certain period of time, the product switches to the power-save mode. The product exits power-save mode when you perform operations such as pressing the shutter button halfway.

Related Topic

[Pwr Save Start Time](#)

4-543-698-11(1)

Copyright 2014 Sony Corporation



Interchangeable Lens Digital Camera
ILCE-5100

The flash takes too long to recharge.

- The flash has been fired in succession in a short period. When the flash has been fired in succession, the recharging process may take longer than usual to avoid overheating of the camera.

4-543-698-11(1)

Copyright 2014 Sony Corporation

Interchangeable Lens Digital Camera
ILCE-5100

Images cannot be played back.

- Make sure that the memory card is fully inserted into the product.
- The folder/file name has been changed on your computer.
- When an image file has been processed by a computer or when the image file was recorded using a model other than this product, playback on this product is not guaranteed.
- The product is in USB mode. Disconnect the product from the computer.
- Use PlayMemories Home to play back on this product images that are stored on your computer.

Related Topic

[Disconnecting the product from the computer](#)

4-543-698-11(1)

Copyright 2014 Sony Corporation



Interchangeable Lens Digital Camera
ILCE-5100

The date and time are not displayed.

- The screen display is set to display images only. Press DISP (Display Setting) on the control wheel to display the information.

4-543-698-11(1)

Copyright 2014 Sony Corporation



Interchangeable Lens Digital Camera
ILCE-5100

The image cannot be deleted.

- Cancel the protection.

Related Topic

 [Protect](#)

4-543-698-11(1)

Copyright 2014 Sony Corporation



Interchangeable Lens Digital Camera
ILCE-5100

The image was deleted by mistake.

- Once you have deleted an image, you cannot restore it. We recommend that you protect images that you do not want to delete.

Related Topic

[Protect](#)

4-543-698-11(1)

Copyright 2014 Sony Corporation



Interchangeable Lens Digital Camera
ILCE-5100

A DPOF mark cannot be put.

- You cannot place DPOF marks on RAW images.

4-543-698-11(1)

Copyright 2014 Sony Corporation



Interchangeable Lens Digital Camera
ILCE-5100

You cannot find the wireless access point to be connected.

- Wireless access points may not be displayed on the product due to signal conditions. Place the product closer to the wireless access point.
- Wireless access points may not be displayed on the product depending on the access point settings. Refer to the instruction manual of the wireless access point.

4-543-698-11(1)

Copyright 2014 Sony Corporation



Interchangeable Lens Digital Camera
ILCE-5100

[WPS Push] does not work.

- [WPS Push] may not work depending on the access point settings. Check the SSID and password of the wireless access point, and perform [Access Point Set.].

4-543-698-11(1)

Copyright 2014 Sony Corporation



Interchangeable Lens Digital Camera
ILCE-5100

[Send to Computer] is canceled halfway.

- When the battery remaining level is low, [Send to Computer] may be canceled halfway. Charge the battery pack and try again.

4-543-698-11(1)

Copyright 2014 Sony Corporation



Interchangeable Lens Digital Camera
ILCE-5100

You cannot send movies to a smartphone.

- You cannot send XAVC S movies to a smartphone.
- You cannot send AVCHD movies to a smartphone. Set [File Format] to [MP4] to record movies.

Related Topic

[File Format \(movie\)](#)

4-543-698-11(1)

Copyright 2014 Sony Corporation



Interchangeable Lens Digital Camera
ILCE-5100

[Smart Remote Embedded] or [Send to Smartphone] is canceled halfway.

- When the remaining battery level is low, [Smart Remote Embedded] or [Send to Smartphone] may be canceled halfway. Charge the battery pack and try again.

4-543-698-11(1)

Copyright 2014 Sony Corporation



Interchangeable Lens Digital Camera
ILCE-5100

The shooting screen for [Smart Remote Embedded] is not displayed smoothly./The connection between this product and the smartphone is disconnected.



- Data communication between this product and the smartphone may fail due to signal conditions. Place this product closer to the smartphone.

4-543-698-11(1)

Copyright 2014 Sony Corporation

Interchangeable Lens Digital Camera
ILCE-5100

You cannot use One-Touch connection (NFC).

- Place the  (N mark) on the smartphone and the  (N mark) on the product as close together as possible. If there is no response, move the smartphone a few millimeters or move the smartphone away from this product, wait more than 10 seconds, and then touch them together again.
- [Airplane Mode] is set to [On]. Set [Airplane Mode] to [Off].
- Check whether the NFC function is activated on your smartphone. For details, refer to the instruction manual of the smartphone.
- Do not place any metal objects other than a smartphone near the  (N mark).
- Do not contact two or more smartphones to this product at the same time.
- If another NFC-based application is running on your smartphone, terminate that application.

Related Topic

 [Airplane Mode](#)

4-543-698-11(1)

Copyright 2014 Sony Corporation



Interchangeable Lens Digital Camera
ILCE-5100

The computer does not recognize this product.

- Set [USB Connection] to [Mass Storage].
- Use the micro USB cable (supplied) to connect the devices.
- Disconnect the USB cable, and connect it again firmly.
- Disconnect all equipment other than this product, the keyboard and the mouse from the USB terminals of your computer.
- Connect this product directly to your computer without passing through a USB hub or other device.

Related Topic

[USB Connection](#)

4-543-698-11(1)

Copyright 2014 Sony Corporation



Interchangeable Lens Digital Camera
ILCE-5100

You cannot import images.

- Connect this product and your computer correctly making a USB connection.
- When you shoot images with a memory card formatted by a computer, you may not be able to import the images to a computer. Shoot using a memory card formatted by this product.

Related Topic

- [Connecting the product to a computer](#)
- [Format](#)

4-543-698-11(1)

Copyright 2014 Sony Corporation



Interchangeable Lens Digital Camera
ILCE-5100

The image and sound are interrupted by noise when viewing a movie on a computer.

- You are playing back the movie directly from the memory card. Import the movie to your computer using PlayMemories Home and play it back.

4-543-698-11(1)

Copyright 2014 Sony Corporation



Interchangeable Lens Digital Camera
ILCE-5100

Images exported from a computer cannot be viewed on this product.

- Use PlayMemories Home to copy images that are stored on a computer onto a memory card inserted into this product and view them on this product.

4-543-698-11(1)

Copyright 2014 Sony Corporation



Interchangeable Lens Digital Camera
ILCE-5100

Formatted the memory card by mistake.

- All the data on the memory card is deleted by formatting. You cannot restore the data.

4-543-698-11(1)

Copyright 2014 Sony Corporation



Interchangeable Lens Digital Camera
ILCE-5100

You cannot print images.

- RAW images cannot be printed. To print RAW images, first convert them to JPEG images using “Image Data Converter.”

4-543-698-11(1)

Copyright 2014 Sony Corporation



Interchangeable Lens Digital Camera
ILCE-5100

The color of the image is strange.

- When you print the images recorded in Adobe RGB mode using sRGB printers that are not compatible with Adobe RGB (DCF2.0/Exif2.21), the images are printed at a lower saturation.

4-543-698-11(1)

Copyright 2014 Sony Corporation

Interchangeable Lens Digital Camera
ILCE-5100

Images are printed with both edges cut off.

- Depending on your printer, the left, right, top, and bottom edges of the image may be cut off. Especially when you print an image shot with [ Aspect Ratio] set to [16:9], the lateral end of the image may be cut off.
- When printing images using your printer, cancel the trimming or borderless settings of the printer. Consult the printer manufacturer as to whether the printer provides these functions or not.
- When you print images at a shop, ask the shop whether they can print the images without cutting off both edges.

Related Topic

- [Aspect Ratio \(still image\)](#)

4-543-698-11(1)

Copyright 2014 Sony Corporation



Interchangeable Lens Digital Camera
ILCE-5100

You cannot print images with the date.

- If you want to print images with the date, use [Print Setting] under [Specify Printing].
- You can print images with the date superimposed if the printer or the software can recognize Exif information. For compatibility with Exif information, consult the manufacturer of the printer or the software.
- Using PlayMemories Home, you can print images with the date without recording the date.
- When you print images at a shop, images can be printed with the date if you ask them to do so.

Related Topic

● [Specify Printing](#)

4-543-698-11(1)

Copyright 2014 Sony Corporation



Interchangeable Lens Digital Camera
ILCE-5100

The lens gets fogged.

- Moisture condensation has occurred. Turn off the product and leave it for about an hour before using it.

4-543-698-11(1)

Copyright 2014 Sony Corporation



Interchangeable Lens Digital Camera
ILCE-5100

The product becomes warm when you use it for a long time.

- This is not a malfunction. Turn off the product and do not use it for a while.

4-543-698-11(1)

Copyright 2014 Sony Corporation



Interchangeable Lens Digital Camera
ILCE-5100

The Clock Set screen appears when you turn on the product.

- Set the date and time again.
- The internal rechargeable backup battery has discharged. Insert a charged battery, and set aside for 24 hours or more with the power left off.

Related Topic

[Date/Time Setup](#)

4-543-698-11(1)

Copyright 2014 Sony Corporation



Interchangeable Lens Digital Camera
ILCE-5100

The number of recordable images does not decrease, or decreases two images at a time.

- This is because the compression rate and the image size after compression change depending on the image when you shoot a JPEG image.

4-543-698-11(1)

Copyright 2014 Sony Corporation



Interchangeable Lens Digital Camera
ILCE-5100

The product does not work properly.

- Turn off the product. Remove the battery pack and insert it again. If the product is hot, remove the battery pack, and allow it to cool down before trying this corrective procedure.
- If an AC-PW20 AC Adaptor (sold separately) is used, disconnect the power cord. Connect the power cord and turn on the product again. If the product repeats the same error often or still does not work after trying these solutions, consult your Sony dealer or local authorized Sony service facility.

4-543-698-11(1)

Copyright 2014 Sony Corporation



Interchangeable Lens Digital Camera
ILCE-5100

“--E-” appears on the screen.

- Remove the memory card, and insert it again. If the problem persists even after performing this procedure, format the memory card.

4-543-698-11(1)

Copyright 2014 Sony Corporation



Interchangeable Lens Digital Camera
ILCE-5100

The buttons on the touch panel do not work correctly or do not work at all.

- If you cover the panel with a commercially available protective film, the panel may not operate.
- If you are touching somewhere other than the point you should touch, the panel may not operate properly.
- Some operations cannot be done on the touch panel. In this case, use the control wheel and buttons.

4-543-698-11(1)

Copyright 2014 Sony Corporation

Interchangeable Lens Digital Camera
ILCE-5100

You cannot perform touch operations.

- Check if [Touch Operation] is set to [On].
- The MENU screen and the playback mode screen cannot be operated using touch operations.
- The [Touch Shutter] function or [Touch Focus] function is disabled while using Digital Zoom. You can use [Touch Shutter] or [Touch Focus] within the range of the optical zoom.
- The touch panel of this product is not pressure-sensitive. You may not be able to operate the touch panel using your fingernail or a pen.
- If there are water drops on the monitor, or you touch the monitor with a wet finger, you may not be able to operate the touch panel. Turn the product off, then wipe off the drops on the monitor using a soft cloth.

4-543-698-11(1)

Copyright 2014 Sony Corporation

Interchangeable Lens Digital Camera
ILCE-5100

Warning messages

Set Area/Date/Time.

- Set the area, date and time. If you have not used the product for a long time, charge the internal rechargeable backup battery.

Unable to use memory card. Format?

- The memory card was formatted on a computer and the file format was modified. Select [Enter], and then format the memory card. You can use the memory card again, however, all previous data in the memory card is erased. It may take some time to complete the format. If the message still appears, change the memory card.

Memory Card Error

- An incompatible memory card is inserted.
- Formatting has failed. Format the memory card again.

Unable to read memory card. Reinsert memory card.

- An incompatible memory card is inserted.
- The memory card is damaged.
- The terminal section of the memory card is dirty.

This memory card may not be capable of recording and playing normally.

- An incompatible memory card is inserted.

Processing...

- When performing noise reduction, the reduction process takes place. You cannot do any further shooting during this reduction process.

Unable to display.

- Images recorded with other products or images modified with a computer may not be displayed.

Cannot recognize lens. Attach it properly.

- The lens is not attached properly, or the lens is not attached. If the message appears when a lens is attached, reattach the lens. If the message appears frequently, check whether the contacts of the lens and product are clean or not.
- When attaching the product to an astronomical telescope or something similar, set [Release w/o Lens] to [Enable].
- The SteadyShot function does not work. You can continue to shoot but the SteadyShot function will not work. Turn

the product off and on again. If this icon does not disappear, consult your Sony dealer or local authorized Sony service facility.

- The retractable lens with power zoom is retracted. Turn off the product and eject the battery pack, then reinsert the battery pack.

Unable to print.

- You tried to mark RAW images with a DPOF mark.

Internal temp. high. Allow it to cool.

- The product has become hot because you have been shooting continuously. Turn the power off. Cool the product and wait until the product is ready to shoot again.



- You have been recording images for a long time, the product temperature has risen. Stop recording images until the product cools.

Recording is unavailable in this movie format.

- Set [ File Format] to [MP4].



- The number of images exceeds that for which date management in a database file by the product is possible.



- Unable to register to the database file. Import all the images to a computer and recover the memory card.

Image DataBase File error

- There is something wrong in the Image Database File. Select [Setup] → [Recover Image DB].

System Error

Camera Error. Turn power off then on.

- Remove the battery pack, and then re-insert it. If the message appears frequently, consult your Sony dealer or local authorized Sony service facility.

Unable to magnify.

Unable to rotate image.

- Images recorded with other products may not be enlarged or rotated.

Related Topic

- [On the internal rechargeable battery](#)
- [Memory card](#)
- [Format](#)
- [Release w/o Lens](#)

Interchangeable Lens Digital Camera
ILCE-5100

Situations this product has difficulty handling

The product cannot take full advantage of some features under certain circumstances.

When shooting under the following conditions, either recompose the shot or change the shooting mode, then shoot the images again.

Low light conditions

- Sweep Panorama
- Lock-on AF

Overly bright conditions

- Lock-on AF

Varying levels of brightness

- Lock-on AF

Flickering lights

- Sweep Panorama

Subjects too close to the product

- Sweep Panorama

Subjects with large movements or subjects that move too quickly

- Superior Auto
- Sweep Panorama
- Auto HDR
- Lock-on AF

Subjects too small or too large

- Sweep Panorama
- Lock-on AF

Scenes with little contrast, such as the sky or a sandy beach

- Sweep Panorama
- Superior Auto

Scenes changing constantly, such as a waterfall

- Sweep Panorama

- [Superior Auto](#)

Related Topic

- [Sweep Panorama](#)
- [Center Lock-on AF](#)
- [Superior Auto](#)
- [Auto HDR](#)
- [AF Track Duration \(movie\)](#)

4-543-698-11(1)

Copyright 2014 Sony Corporation

Free Manuals Download Website

<http://myh66.com>

<http://usermanuals.us>

<http://www.somanuals.com>

<http://www.4manuals.cc>

<http://www.manual-lib.com>

<http://www.404manual.com>

<http://www.luxmanual.com>

<http://aubethermostatmanual.com>

Golf course search by state

<http://golfingnear.com>

Email search by domain

<http://emailbydomain.com>

Auto manuals search

<http://auto.somanuals.com>

TV manuals search

<http://tv.somanuals.com>