

FM/AM Compact Disc Player

Operating Instructions _____

EN

Owner's Record

The model and serial numbers are located on the bottom of the unit.
Record the serial number in the space provided below.
Refer to these numbers whenever you call upon your Sony dealer regarding this product.

Model No. CDX-4160 Serial No. _____
Model No. CDX-3160 Serial No. _____

For installation and connections, see the supplied installation/connections manual.



***CDX-4160
CDX-3160***

© 1997 by Sony Corporation



Actual total number: _____

Sony CDX-4160/3160 (E) 3-859-005-32(1)

Warning

This equipment has been tested and found to comply with the limits for a Class B digital device, pursuant to Part 15 of the FCC Rules. These limits are designed to provide reasonable protection against harmful interference in a residential installation. This equipment generates, uses, and can radiate radio frequency energy and, if not installed and used in accordance with the instructions, may cause harmful interference to radio communications. However, there is no guarantee that interference will not occur in a particular installation. If this equipment does cause harmful interference to radio or television reception, which can be determined by turning the equipment off and on, the user is encouraged to try to correct the interference by one or more of the following measures:

- Reorient or relocate the receiving antenna.
- Increase the separation between the equipment and receiver.
- Connect the equipment into an outlet on a circuit different from that to which the receiver is connected.
- Consult the dealer or an experienced radio/TV technician for help.

You are cautioned that any changes or modifications not expressly approved in this manual could void your authority to operate this equipment.

CAUTION

The use of optical instruments with this product will increase eye hazard.

Welcome !

Thank you for purchasing the Sony Compact Disc Player. This unit lets you enjoy a variety of features. You can use an optional rotary remote (RM-X2S) (CDX-4160 only).

Table of Contents

Getting Started

Resetting the unit	4
Detaching the front panel	4
Setting the clock	5

CD Player

Listening to a CD	5
Playing a CD in various modes	6

Radio

Memorizing stations automatically	
— Automatic Memory	6
Memorizing only the desired stations	6
Receiving the memorized stations	7

Other Functions

Adjusting the sound characteristics	7
Muting the sound	7
Changing the sound and beep tone	7
Turning on the clock display	
— Power Select Function	8

Additional Information

Precautions	8
Maintenance	9
Dismounting the unit	9
Attaching the label to the rotary remote (CDX-4160 only)	10
Location of controls	11
Specifications	12
Troubleshooting guide	13
Index	14

EN

Getting Started

Resetting the unit

Before operating the unit for the first time or after replacing the car battery, you must reset the unit.

Press the reset button with a pointed object, such as a ball-point pen.



Reset button

Notes

- Pressing the reset button will erase all the memorized program and memory functions.
- When you connect the power supply cord to the unit or reset the unit, wait for about 10 seconds before you insert a disc. Do not insert a disc within these 10 seconds, otherwise, the unit will not be reset, and you will have to press the reset button again.

Attaching the front panel

Align part (A) of the front panel to part (B) of the unit as illustrated, and push until it clicks.

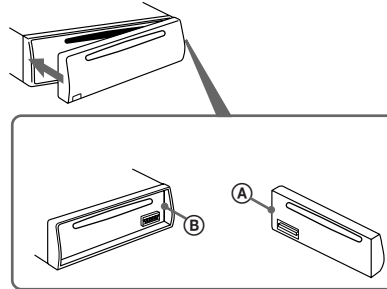

Notes

- Be sure not to attach the front panel upside down.
- Do not press the front panel hard against the unit when attaching it. Press it lightly against the unit.
- Do not press hard or put excessive pressure on the display window of the front panel.
- Do not expose the front panel to direct sunlight, heat sources such as hot air ducts, and do not leave it in a humid place. Never leave it on the dashboard of a car parked in direct sunlight where there may be a considerable rise in temperature.

Caution alarm

If you turn the ignition key switch to the OFF position without removing the front panel, the caution alarm will be activated and a beep tone will be heard for a few seconds (only for cars with an accessory position on the ignition key switch). If you connect an optional power amplifier and do not use the built-in amplifier, the beep tone will be disabled.

Detaching the front panel

You can detach the front panel of this unit to prevent the unit from being stolen.

- 1 Press (OFF).
- 2 Press (RELEASE) to open up the front panel. Then slide the front panel a little to the left, and pull it off towards you.

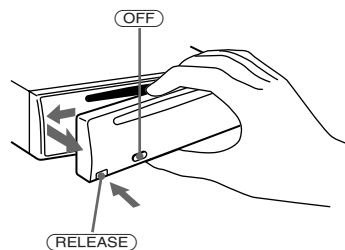

Notes

- Be sure not to drop the panel when detaching it from the unit.
- If you press (RELEASE) to detach the panel while the unit is still on, the unit will turn off automatically to prevent the speakers from being damaged.
- When you carry the front panel with you, put it in the supplied front panel case.

4

Actual total number:

Sony CDX-4160/3160 (E) 3-859-005-32(1)

Setting the clock

The clock has a 12-hour digital indication.

Example: Set the clock to 10:08

1 Press **(OFF)** or **(DSPL)** during operation.

2 Press **(DSPL)** for two seconds.

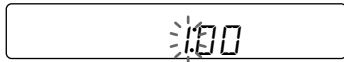

The hour digit flashes.

1 Set the hour digits.



2 Press **(SEL)** momentarily.

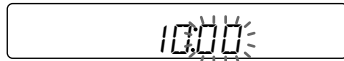

The minute digits flash.

3 Set the minute digits.

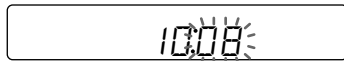

3 Press **(DSPL)** momentarily.

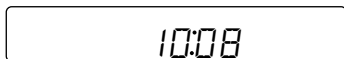

The clock is activated.

Note

If the car has no accessory position on the ignition key switch, the clock cannot be set unless the power is turned on. Set the clock after you have turned on the radio, or started CD playback.

CD Player

Listening to a CD

Simply insert the CD.

Playback starts automatically.

Labelled side up

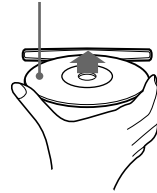

If a CD is already inserted, press **(SOURCE)** repeatedly until "CD" appears.

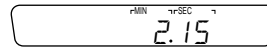

Elapsed playing time

Note

To play back an 8 cm (3 in.) CD, use the optional Sony compact disc single adapter (CSA-8).

To	Press
Stop playback	(▲) or (OFF)
Eject the CD	(▲)

Changing the displayed items

Each time you press **(DSPL)**, the item changes as follows:

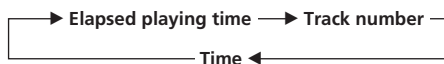

Locating a specific track

— Automatic Music Sensor (AMS)

During playback, press either side of

(SEEK/AMS) momentarily.

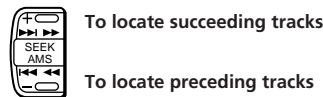

EN

Getting Started/CD Player

Actual total number:

Sony CDX-4160/3160 (E) 3-859-005-32(1)

Locating a specific point in a track — Manual Search

During playback, press and hold either side of **(SEEK/AMS)** for two seconds. Release the button when you have found the desired point.



To search forward

To search backward

Note

If “--” or “--” appears in the display, you have reached the beginning or the end of the disc and you cannot go any further.

Playing a CD in various modes

Searching for the desired track — Intro Scan

Press **(1)** during playback. “INTRO” appears in the display.

The first 10 seconds of all the tracks are played.

When you find the desired track, press again. The unit returns to the normal playback mode.

Playing tracks repeatedly — Repeat Play

Press **(2)** during playback. “REPEAT” appears in the display.

When the currently played track is over, it will be played again from the beginning.

To cancel this mode, press again.

Playing tracks in random order — Shuffle Play

Press **(3)** during playback. “SHUFFLE” appears in the display.

To cancel this mode, press again.

Radio

Memorizing stations automatically

— Automatic Memory

Stations with the clearest reception are automatically searched and memorized on each band (FMI, FMII, FMIII and AM). Up to 6 stations on each band can be stored on the number buttons (**(1)** to **(6)**) in the order of band frequency.

1 Press **(SOURCE)** repeatedly to select the tuner.

Each time you press **(MODE)**, the mode change as follows:

CD ↔ TUNER

2 Press **(MODE)** repeatedly to select the band.

Each time you press **(MODE)**, the mode changes as follows:

→ FM I → FM II → FM III → AM

3 Press **(A.MEM)** for two seconds.

The unit will be starts scanning the selected band and memories the tuned stations on the number button **(1)** through **(6)** automatically.

Notes

- The unit does not store stations with weak signals. If only a few stations are received, some number buttons remain empty.
- When a number is indicated in the display, the unit starts storing stations from the one currently displayed.
- If a CD is not in the unit, only the tuner band appears even if you press **(SOURCE)**.

Memorizing only the desired stations

You can store up to 6 stations on each band (18 for FMI, FMII and FMIII, 6 for AM) in the order of your choice.

1 Press **(SOURCE)** repeatedly to select the tuner.

2 Press **(MODE)** repeatedly to select the band.

- 3 Press either side of **(SEEK/AMS)** to tune in the station that you want to store on the number button.
- 4 Press the desired number button (**(1)** to **(6)**) for two seconds until "MEM" appears.
The number button indication appears in the display.

Note

If you try to store another station on the same number button, the previously stored station will be erased.

Receiving the memorized stations

- 1 Select the desired band (page 6).
- 2 Press the number button (**(1)** to **(6)**) momentarily where the desired station is stored.

If you cannot tune in a preset station

Press either side of **(SEEK/AMS)** momentarily to search for the station (automatic tuning).

Scanning stops when the unit receives a station. Press either side of **(SEEK/AMS)** repeatedly until the desired station is received.

Note

If the automatic tuning stops too frequently, press **(SENS)** momentarily until "LCL" appears in the display (local seek mode). Only the stations with relatively strong signals will be tuned in.

Tip

If you know the frequency of the station you want to listen to, press and hold either side of **(SEEK/AMS)** for two seconds until the desired frequency appears (manual tuning).

If FM stereo reception is poor — Monaural Mode

Press **(SENS)** momentarily until "MONO" appears.

The sound improves, but becomes monaural ("ST" disappears).

To go back to the normal mode, press again until "MONO" disappears.

Changing the displayed items

Each time you press **(DSPL)**, the items alternate between the frequency and time.

Other Functions

Adjusting the sound characteristics

You can adjust bass, treble, balance and fader. Each source can store the bass and treble level independently.

- 1 Select the item you want to adjust by pressing **(SEL)** repeatedly.
VOL (volume) → BAS (bass) → TRE (treble) → BALANCE (balance) → FADER (fader)
- 2 Adjust the selected item by pressing **(+)** or **(-)**.
Adjust within three seconds after selecting the item. (After three seconds, the buttons work as volume control buttons.)

Muting the sound

Press **(MUTE)**.
"MUTE" flashes.

To restore the previous volume level, press **(MUTE)** again.

Changing the sound and beep tone

Enjoying bass and treble even at low volume — Loudness (CDX-3160 only)

Bass and treble will be reinforced.

Press **(2)** while pressing **(SEL)**.
"LOUD" appears in the display.

To cancel, press these buttons again.

Boosting the bass sound — D-bass (CDX-4160 only)

You can enjoy clear and powerful bass sound. The D-bass function boosts the low frequency signal with a sharper curve than conventional bass boost.

You can hear the bass line more clearly even if the vocal sound is the same volume. You can emphasize and adjust the bass sound easily with the D-bass control. This effect is similar to the one you get when you use an optional subwoofer system.

Moreover, the Digital D-bass* function creates even shaper and more powerful bass sound than Analog D-bass.

* Digital D-bass is available during CD playback.

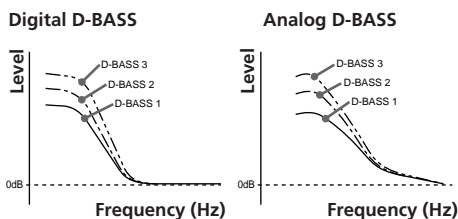

Adjusting the bass curve

Turn the D-BASS dial to adjust the bass level (1, 2 or 3).

"D-BASS" appears in the display.
During CD playback, "DIGITAL D-BASS" appears in the display.

To cancel, turn the dial to the OFF position.

Muting the beep tone

Press **(6)** while pressing **(SEL)**.

To obtain the beep tone again, press these buttons again.

Note

If you connect an optional power amplifier and do not built-in amplifier, the beep tone will be disabled.

Turning on the clock display — Power Select Function

Only for cars with an accessory position on the ignition key switch

To turn the Power Select Function ON

Press **(OFF)** while pressing **(SEL)**.

The Power Select Function ties the clock display power to the accessory position on the ignition key switch.

To avoid battery wear, the clock is not displayed while the unit is initializing.

Note

You cannot operate this function with the optional rotary remote (RM-X2S) (CDX-4160 only).

Additional Information

Precautions

- If your car was parked in direct sunlight resulting in a considerable rise in temperature inside the car, allow the unit to cool off before operating it.
- If no power is being supplied to the unit, check the connections first. If everything is in order, check the fuse.
- If no sound comes from the speakers of a two-speaker system, set the fader control to the center position.
- If your car is equipped with a power antenna, note that it will extend automatically while the unit is operating.

If you have any questions or problems concerning your unit that are not covered in this manual, please consult your nearest Sony dealer.

Notes on handling CDs

A dirty or defective disc may cause sound dropouts while playing. To enjoy optimum sound, handle the disc as follows. Handle the disc by its edge. To keep the disc clean, do not touch the surface.



Do not stick paper or tape on the labeled surface.

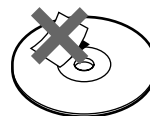

Do not expose the discs to direct sunlight or heat sources such as hot air-ducts, or leave them in a car parked in direct sunlight where there can be a considerable rise in the temperature inside the car.

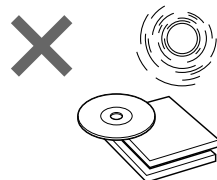

Before playing, clean the discs with an optional cleaning cloth. Wipe each disc from the center out. Do not use solvents such as benzine, thinner, commercially available cleaners or antistatic spray intended for analog discs.



Notes on moisture condensation

On a rainy day or in a very damp area, moisture may condense on the lenses inside the CD player. Should this occur, the unit will not operate properly. In this case, remove the disc and wait for about an hour until the moisture evaporates.

When you play 8 cm (3 in.) CDs

Use the optional Sony compact disc single adapter (CSA-8) to protect the CD player from being damaged.

Maintenance

Fuse replacement

When replacing the fuse, be sure to use one that matches the amperage described on the fuse. If the fuse blows, check the power connection and replace the fuse. If the fuse blows again after replacement, there may be an internal malfunction. In such a case, consult your nearest Sony dealer.

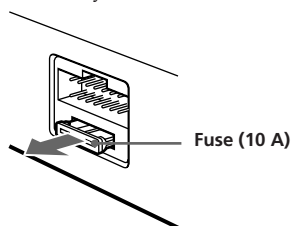

Warning

Never use a fuse with an amperage rating exceeding the one supplied with the unit as this could damage the unit.

Cleaning the connectors

The unit may not function properly if the connectors between the unit and the front panel are not clean. To prevent this, open the front panel by pressing (RELEASE), then detach it and clean the connectors with a cotton swab dipped in alcohol. Do not apply too much force. Otherwise, the connectors may be damaged.

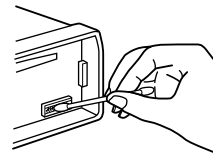

Main unit

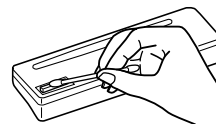

Back of the front panel

Dismounting the unit

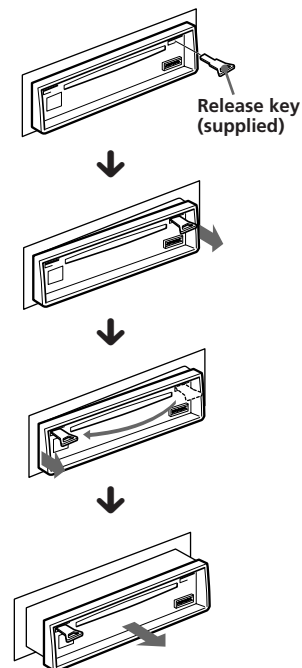

EN

Other Functions/Additional Information

Attaching the label to the rotary remote (CDX-4160)

You can control this unit with the optional rotary remote (RM-X2S) (CDX-4160 only). Several labels are supplied with the rotary remote. Attach the label that matches the functions of this unit and the mounting position of the rotary remote. After you mount the rotary remote, attach the label in the illustration below.

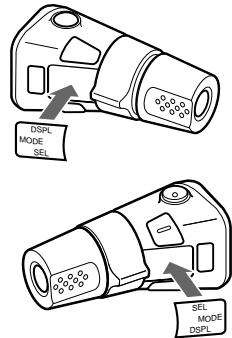

EN

Location of controls

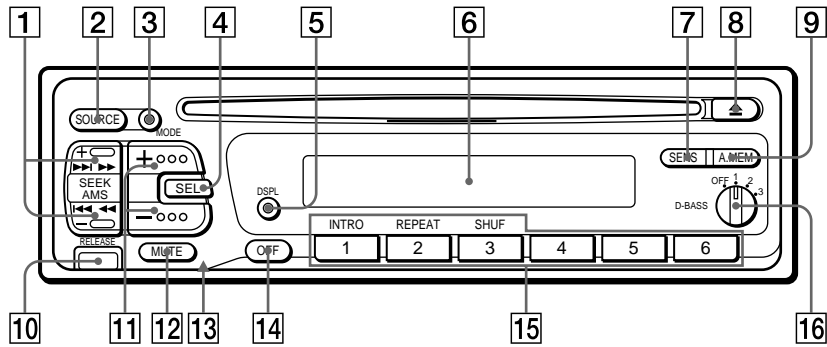

Refer to the pages for details.

- 1 SEEK/AMS (seek/Automatic Music Sensor/manual search) button 5, 6, 7
- 2 SOURCE (source select) button 5, 6
- 3 MODE (band select) button 6
- 4 SEL (control mode select) button 5, 7, 8
- 5 DSPL (display mode change/time set) button 5, 7
- 6 Display window
- 7 SENS (sensitivity adjust) button 7
- 8 ▲ (eject) button 5
- 9 A.MEM (Automatic Memory) button 6
- 10 RELEASE (front panel release) button 4, 10
- 11 + - (volume/bass/treble/balance/fader control) buttons 5, 7
- 12 MUTE button 8
- 13 Reset button (located on the front side of the unit hidden by the front panel) 4
- 14 OFF button 4, 5, 8
- 15 During radio reception:
Number buttons 6, 7
During CD playback:
① INTRO button 6
② REPEAT button 6
③ SHUF button 6
- 16 D-BASS dial (CDX-4160 only) 8

The illustration of the front panel in the manual is of the CDX-4160.

EN

Additional Information

Specifications

AUDIO POWER SPECIFICATIONS

POWER OUTPUT AND TOTAL HARMONIC DISTORTION

12 watts per channel minimum continuous average power into 4 ohms, 4 channels driven from 20 Hz to 20 kHz with no more than 1% total harmonic distortion.

CD player section

System	Compact disc digital audio system
Signal-to-noise ratio	90 dB
Frequency response	10 – 20,000 Hz
Wow and flutter	Below measurable limit
Laser Diode Properties	
Material	GaAlAs
Wavelength	780 nm
Emission Duration	Continuous
Laser output power	Less than 44.6 μ W*

* This output is the value measured at a distance of 200 mm from the objective lens surface on the Optical Pick-up Block.

Tuner section

FM

Tuning range	87.5 – 107.9 MHz
Antenna terminal	External antenna connector
Intermediate frequency	10.7 MHz

	CDX-4160	CDX-3160
Usable sensitivity	8 dBf	13 dBf
Selectivity (at 400 kHz)	75 dB	70 dB
Separation (at 1 kHz)	35 dB	33 dB
Signal-to-noise ratio	65 dB (stereo), 68 dB (mono)	
Harmonic distortion at 1 kHz	0.5 % (stereo), 0.3 % (mono)	
Frequency response	30 – 15,000 Hz	
Capture ratio	2 dB	

AM

	CDX-4160	CDX-3160
Intermediate frequency	10.71 MHz /450 kHz	450 kHz
Sensitivity	30 μ V	32 μ V
Tuning range	530 – 1,710 kHz	
Antenna terminal	External antenna connector	

Power amplifier section

Outputs	Speaker outputs (sure seal connectors)
Speaker impedance	4 – 8 ohms
Maximum power output	35 W \times 4 (at 4 ohms)

General

Outputs	Line output (2) Power antenna relay control/Power amplifier control lead
Tone controls	Bass \pm 10 dB at 100 Hz Treble \pm 10 dB at 10 kHz
Power requirements	12 V DC car battery (negative ground)
Dimensions	Approx. 188 \times 58 \times 180 mm (7 ¹ / ₂ \times 2 ³ / ₈ \times 7 ¹ / ₈ in.) (w/h/d)
Mounting dimensions	Approx. 183 \times 53 \times 163 mm (7 ¹ / ₄ \times 2 ¹ / ₈ \times 6 ¹ / ₂ in.) (w/h/d)
Mass	Approx. 1.3 kg (2 lb 14 oz)
Supplied accessories	Parts for installation and connections (1 set) Front panel case (1)
Optional accessories	Rotary remote RM-X2S (for CDX-4160) RCA pin cord RC-63 (1 m), RC-64 (2 m), RC-65 (5 m) Cleaning cloth XP-CD1 Compact disc single adapter CSA-8

Design and specifications are subject to change without notice.

EN

Troubleshooting guide

The following checklist will help you remedy the problems that you may encounter with your unit. Before going through the checklist below, check the connection and operating procedures.

General

Problem	Cause/Solution
No sound.	<ul style="list-style-type: none"> Adjust the volume with (+). Set the fader control to the center position for two-speaker systems.
The contents of the memory have been erased.	<ul style="list-style-type: none"> The power cord or battery has been disconnected. The reset button has been pressed. → Store the settings again into the memory.
Indications do not appear in the display.	Remove the front panel and clean the connectors. See "Cleaning the connectors" (page 9) for details.
No beep tone.	<ul style="list-style-type: none"> An optional power amplifier is connected and you are not using the built-in amplifier. The beep tone is muted (page 8).

CD playback

Problem	Cause/Solution
CD cannot be loaded.	<ul style="list-style-type: none"> Another CD is already loaded. The CD was forcibly inserted upside down.
Play does not begin.	Dusty disc.
CD is automatically ejected.	The ambient temperature is more than 50°C (122°F).
CD will not eject.	Press the ▲ button for two seconds.
The operation buttons do not function.	Press the reset button.
The sound skips due to vibration.	<ul style="list-style-type: none"> The unit is installed at an angle of more than 20°. The unit is not installed in a sturdy part of the car.

Radio reception

Problem	Cause/Solution
Preset tuning is not possible.	<ul style="list-style-type: none"> Store the correct frequency. The broadcast signal is too weak.
Automatic tuning is not possible.	The broadcast signal is too weak. → Use manual tuning.
The "ST" indication flashes.	<ul style="list-style-type: none"> Tune in the frequency correctly. The broadcast signal is too weak. → Set to the MONO mode (page 7).

Error displays

The following indications will flash for about five seconds.

Display	Cause	Solution
<i>E - 04</i>	A CD is dirty or inserted upside down.	Clean or insert the CD correctly.
<i>E - 99</i>	The CD player cannot be operated because of some problem.	Press the reset button or ▲.

If the above-mentioned solutions do not help improve the situation, consult your nearest Sony dealer.

EN

Additional Information

13

Actual total number:

Sony CDX-4160/3160 (E) 3-859-005-32(1)

Index

A

Automatic Memory 6
Automatic Music Sensor (AMS) 5
Automatic tuning 7

B

Balance 7
Bass 7
Beep tone 8

C

Caution alarm 4
CD playback 5
Clock 5

D, E

D-BASS 7
Display 5,7

F, G, H

Fader 7
Front panel 4
Fuse 9

I, J, K

Intro Scan 6

L

Local seek 7
Locating
 a specific point 6
 a specific track 5
Loudness 7

M, N, O

Manual search 6
Manual tuning 7
Memorizing a station 6
Monaural mode 7
Mute 7

P, Q

Power select 8

R

Radio 6
Repeat Play 6
Reset 4
Rotary remote (CDX-4160 only) 10

S

Shuffle Play 6

T, U

Treble 7

V, W, X, Y, Z

Volume 7

EN

Sony Corporation Printed in Korea



Actual total number:

Sony CDX-4160/3160 (E) 3-859-005-32(1)

Free Manuals Download Website

<http://myh66.com>

<http://usermanuals.us>

<http://www.somanuals.com>

<http://www.4manuals.cc>

<http://www.manual-lib.com>

<http://www.404manual.com>

<http://www.luxmanual.com>

<http://aubethermostatmanual.com>

Golf course search by state

<http://golfingnear.com>

Email search by domain

<http://emailbydomain.com>

Auto manuals search

<http://auto.somanuals.com>

TV manuals search

<http://tv.somanuals.com>