

CDP-338ESD / 608ESD

SERVICE MANUAL

US Model
 Canadian Model
 CDP-608ESD
 AEP Model
 UK Model
 E Model
 CDP-338ESD



This photo is CDP-338ESD

SPECIFICATIONS

Compact disc player

Frequency response	2 Hz – 20 kHz \pm 0.5 dB (CDP-338ESD) 2 Hz – 20 kHz \pm 0.3 dB (CDP-608ESD)
Signal to noise ratio	More than 113 dB
Dynamic range	More than 100 dB
Harmonic distortion	Less than 0.0022%
Channel separation	More than 110 dB

Outputs

LINE OUT (FIXED) (phono jacks)	Output level 2 V (at 50 kilohms) Load impedance over 10 kilohms
LINE OUT (VARIABLE) (phono jacks)	Output level max. 2 V (at 50 kilohms) Load impedance over 50 kilohms
DIGITAL OUT (COAXIAL) (cable)	Output level max. 0.5 Vp-p Load impedance 75 ohms
DIGITAL OUT (OPTICAL) (optical output connector)	Wave length 660 nm Output level – 18 dBm
HEADPHONES (stereo phone jack)	Output level max. 28 mW Load impedance 32 ohms

SAFETY-RELATED COMPONENT WARNING!!

COMPONENTS IDENTIFIED BY MARK Δ OR DOTTED LINE WITH MARK Δ ON THE SCHEMATIC DIAGRAMS AND IN THE PARTS LIST ARE CRITICAL TO SAFE OPERATION. REPLACE THESE COMPONENTS WITH SONY PARTS WHOSE PART NUMBERS APPEAR AS SHOWN IN THIS MANUAL OR IN SUPPLEMENTS PUBLISHED BY SONY.

ATTENTION AU COMPOSANT AYANT RAPPORT À LA SÉCURITÉ!

LES COMPOSANTS IDENTIFIÉS PAR UNE MARQUE Δ SUR LES DIAGRAMMES SCHÉMATIQUES ET LA LISTE DES PIÈCES SONT CRITIQUES POUR LA SÉCURITÉ DE FONCTIONNEMENT. NE REMPLACER CES COMPOSANTS QUE PAR DES PIÈCES SONY DONT LES NUMÉROS SONT DONNÉS DANS CE MANUEL OU DANS LES SUPPLÉMENTS PUBLIÉS PAR SONY.

Model Name Using Similar Mechanism	New
CD Transport Mechanism Type	KSS-151A
Optical Pick-Up Block Type	BU-6B

General

Power requirements	AEP Model: (CDP-338ESD) 220 V AC (or 240 V AC adjustable by Sony personnel), 50/60 Hz UK Model: (CDP-338ESD) 240 V AC (or 220 V AC adjustable by Sony personnel), 50/60 Hz US, Canadian Model: (CDP-608ESD) 120 V AC, 60Hz E Model: (CDP-338ESD) 110, 120, 220 or 240 V AC adjustable, 50/60 Hz
Power consumption	27 W
Dimensions (approx., including projections)	470 × 125 × 375 mm (w/h/d) (18 ⁵ / ₈ × 5 × 14 ⁷ / ₈ inches)
Weight (approx.)	12.5 kg (27 lbs 11 oz)

— continued on next page —

COMPACT DISC PLAYER
SONY®

Remote commander

Remote control system	Infrared control
Power requirements	3 V DC with two batteries size AA (IEC designation R6)
Dimensions	67×20×175 mm (w/h/d) (2 ⁹ / ₁₆ ×1 ¹³ / ₁₆ ×7 inches)
Weight	135 g (4.7 oz) Including batteries

Supplied accessories

Connecting cord	1 (2 phono plugs ↔ 2 phono plugs)
Remote commander	1
Size AA batteries	2
Screws	4

Design and specifications subject to change without notice.

SAFETY CHECK-OUT

After correcting the original service problem, perform the following safety check before releasing the set to the customer:

Check the antenna terminals, metal trim, "metallized" knobs, screws, and all other exposed metal parts for AC leakage. Check leakage as described below.

LEAKAGE TEST

The AC leakage from any exposed metal part to earth ground and from all exposed metal parts to any exposed metal part having a return to chassis, must not exceed 0.5 mA (500 microampers). Leakage current can be measured by any one of three methods.

1. A commercial leakage tester, such as the Simpson 229 or RCA WT-540A. Follow the manufacturers' instructions to use these instruments.
2. A battery-operated AC milliammeter. The Data Precision 245 digital multimeter is suitable for this job.

<u>Section</u>	<u>Title</u>	<u>Page</u>
1. GENERAL		
1-1.	Location of Controls.....	3
2. ELECTRICAL ADJUSTMENTS		4
3. DIAGRAMS		
3-1.	Circuit Boards Location.....	7
3-2.	Printed Wiring Boards.....	9
3-3.	Schematic Diagram.....	13
3-4.	Semiconductor Lead Layouts.....	18
4. EXPLODED VIEWS		
4-1.	Cover Section.....	21
4-2.	Front Panel Section.....	22
4-3.	Chassis Section.....	23
4-4.	Mechanism Section.....	24
4-5.	Optical Pick-Up Block Section.....	25
5. ELECTRICAL PARTS LIST		26

3. Measuring the voltage drop across a resistor by means of a VOM or battery-operated AC voltmeter. The "limit" indication is 0.75 V, so analog meters must have an accurate low-voltage scale. The Simpson 250 and Sanwa SH-63Trd are examples of a passive VOM that is suitable. Nearly all battery operated digital multimeters that have a 2 V AC range are suitable. (See Fig. A)

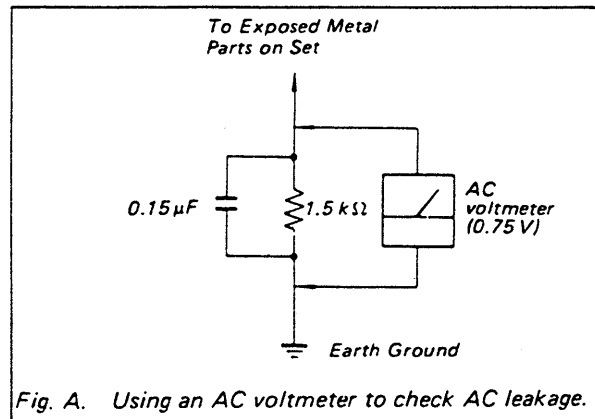

SERVICING NOTE

NOTES ON HANDLING THE OPTICAL PICK-UP BLOCK OR BASE UNIT

The laser diode in the optical pick-up block may suffer electrostatic breakdown because of the potential difference generated by the charged electrostatic load, etc. on clothing and the human body. During repair, pay attention to electrostatic breakdown and also use the procedure in the printed matter which is included in the repair parts. The flexible board is easily damaged and should be handled with care.

CAUTION

Use of controls or adjustments or performance of procedures other than those specified herein may result in hazardous radiation exposure.

NOTES ON LASER DIODE EMISSION CHECK

The laser beam on this model is concentrated so as to be focused on the disc reflective surface by the objective lens in the optical pick-up block. Therefore, when checking the laser diode emission, observe from more than 30 cm away from the objective lens.

MODEL IDENTIFICATION

— Label Model Number —

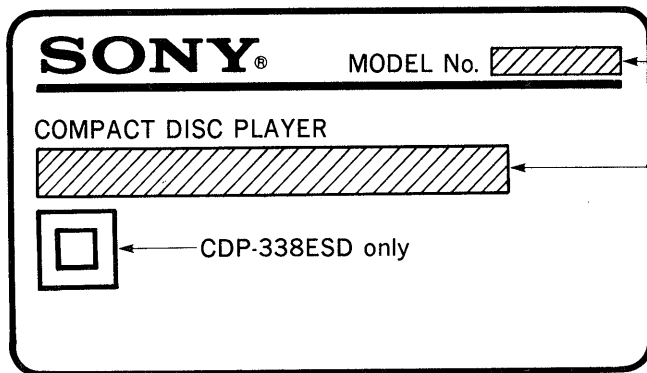

CDP-338ESD
CDP-608ESD

US model ; AC:120V 60Hz 27W
Canadian model ; AC:120V 60Hz 27W
AEP model ; AC:220V~50/60Hz 27W
UK model ; AC:240V~50/60Hz 27W
E model ; AC:110, 120, 220, 240V~50/60Hz 27W

SECTION 1 GENERAL

1-1. LOCATION OF CONTROLS

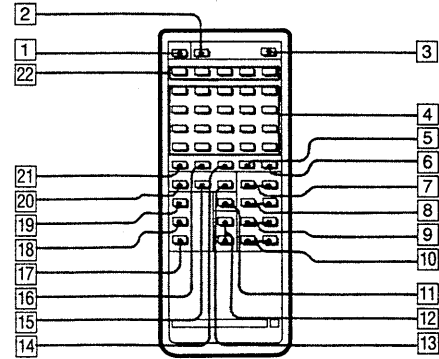
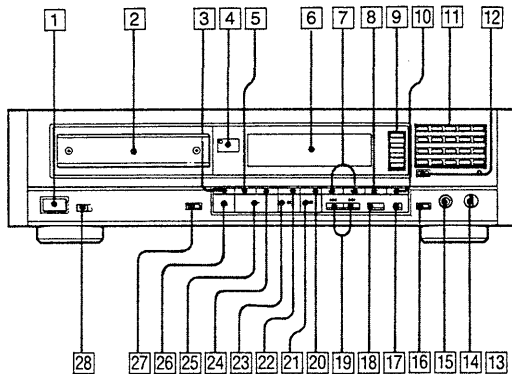

- 1 POWER switch
- 2 Disc tray
- 3 TIME/MEMO button
- 4 Remote sensor
- 5 AUTO SPACE (auto space) button
- 6 Display window
- 7 ◀▶ (manual search) buttons
- 8 CHECK (program check) button
- 9 PLAY MODE buttons
PROGRAM button
SHUFFLE button
CONTINUE/SINGLE button
CUSTOM INDEX button
- 10 CLEAR (program clear) button
- 11 Numeric buttons
- 12 >20 (over 20) button
- 13 DISPLAY ON/OFF button
- 14 LINE OUT/PHONE LEVEL control
- 15 HEADPHONES jack
- 16 EDIT/TIME FADE button
- 17 ERASE (memory erase) button
- 18 FILE (custom file) button
- 19 ◀▶▶ (AMS*) buttons
- 20 FILE RECALL button
- 21 ■ (stop) button
- 22 FADER (fade in/fade out) button
- 23 || (pause) button
- 24 REPEAT button
- 25 ▶ (play) button
- 26 ▲ (open/close) button
- 27 DIGITAL OUTPUT ON/OFF button
- 28 Timer switch

- 1 ▲ (open/close) button
- 2 FILE RECALL button
- 3 DISPLAY ON/OFF button
- 4 Numeric buttons
- 5 ERASE button
- 6 FILE (custom file) button
- 7 ◀▶▶ AMS buttons
- 8 ◀▶ INDEX buttons
- 9 ◀▶▶ (manual search) buttons
- 10 ◀▶ SLOW (low speed manual search) buttons
- 11 FADER (fade in/fade out) button
- 12 LINE OUT VOLUME (line out/headphone volume) buttons
- 13 TIME button
- 14 CLEAR (program clear) button
- 15 A↔B repeat button
- 16 CHECK button
- 17 ■ (stop) button
- 18 || (pause) button
- 19 ▶ (play) button
- 20 CLEAR/REPEAT (A↔B repeat clear/repeat) button
- 21 >20 (over 20) button
- 22 PLAY MODE buttons
PGM (program button)
SHUFFLE button
CONTINUE button
SINGLE button
C. INDEX button

*AMS is the abbreviation of Automatic Music Sensor.

SECTION 2 ELECTRICAL ADJUSTMENTS

1. Perform adjustments in the order given.
2. Use YEDS-18 (Part No : 3-702-101-01) disc unless otherwise indicated.
3. Use the oscilloscope with more than 10 MΩ impedance.

RF PLL Frequency Adjustment

Procedure :

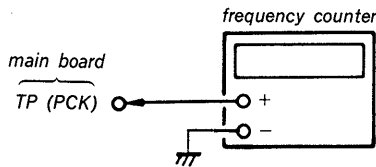

1. Connect the frequency counter to test point TP (PCK).
2. Turn POWER switch on.
3. Adjust RV201 so that the reading on the frequency counter is 4.3218MHz \pm 30kHz
4. Put disc (YEDS-18) in and press ▷ button.
5. Confirm that the reading on frequency counter is 4.3218MHz.

E-F Balance Adjustment

This adjustment should be made when replacing TOP (T-type Optical Pick-up).

Procedure :

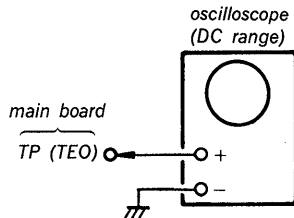

1. Connect oscilloscope to test point TP (TEO).
2. Connect test point TP (ADJ) and test point TP (TES) to ground with lead wire.
3. Turn POWER switch on.
4. Put disc (YEDS-18) in and press ▷ button.
5. Adjust RV101 so that the traverse waveform is symmetrical above and below.
6. After adjustment, remove the lead wire connected in step 5.

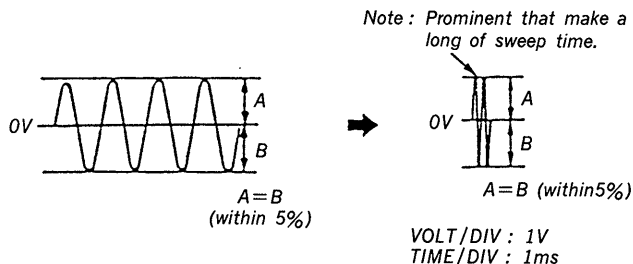

Focus Bias Adjustment

This adjustment should be made when replacing TOP (T-type Optical Pick-up).

Procedure :

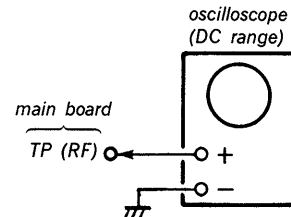

1. Connect oscilloscope to test point TP (RF).
2. Turn POWER switch on.
3. Put disc (YEDS-18) in and press ▷ button.
4. Adjust RV104 for an optimum waveform eye pattern or so that the peak is maximum. Optimum eye pattern means that shape "◇" can be clearly distinguished at the center of the waveform.

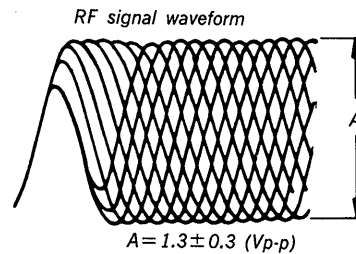

Adjustment Location :main board

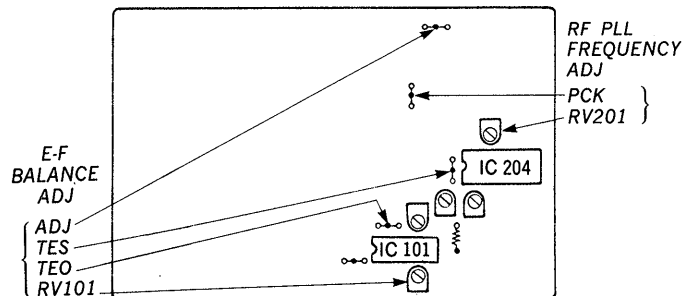

**SECTION 3
DIAGRAMS**

REFERENCE

Focus/Tracking Gain Adjustments

A frequency response analyzer is necessary in order to perform this adjustment exactly.

However, this gain has a margin, so even if it is slightly off, there is no problem. Therefore, do not perform this adjustment.

Focus/tracking gain determines the pick-up follow up (vertical and horizontal) relative to mechanical noise and shock when the 2-axis device operate.

However, as these reciprocate, the adjustment is at the point where both are satisfied.

- When gain is raised, the noise when the 2-axis device operates increases.
- When gain is lowered, mechanical shock and skipping occurs more easily.
- When gain adjustment is off, the symptoms below appear.

Symptoms	Gain	Focus	Tracking
• The time until music starts becomes longer for ■ → ▷ or automatic selection. (◀◀ , ▶▶ buttons pressed.) (Normally tapes about 1 seconds.)		low	low or high
• Music does not start and disc continues to rotate for ■ → ▷ or automatic selection. (◀◀ , ▶▶ buttons pressed.)		—	low
• Disc table opens shortly after ■ → ▷ .		low or high	—
• Sound is interrupted during PLAY or time counter display stops progressing.		—	low
• More noise during 2-axis device operation.		high	high

The following is a simple adjustment method.

—Primary Adjustment—

Note: Since exact adjustment cannot be performed, remember the positions of the controls before performing the adjustment. If the position after the primary adjustment are only a little different, return the controls to the original position.

Procedure:

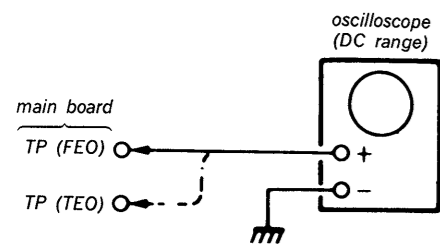

1. Keep the set horizontal.
(If the set is not horizontal, this adjustment cannot be performed due to the gravity against the 2-axis device.)
2. Insert disc (YEDS-18: Fifth Selection) and press **▷** button.
3. Connect oscilloscope to main board TP (FEO).
4. Adjust RV103 so that the waveform is as shown in the figure below. (focus gain adjustment)
5. Connect oscilloscope to main board TP (TEO).
6. Adjust RV102 so that the waveform is as shown in the figure below. (tracking gain adjustment)

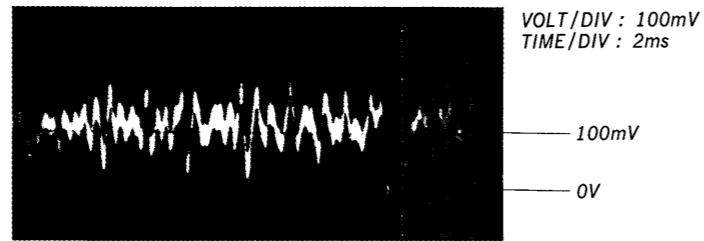

• Incorrect Examples (DC level changes more than on adjusted waveform)

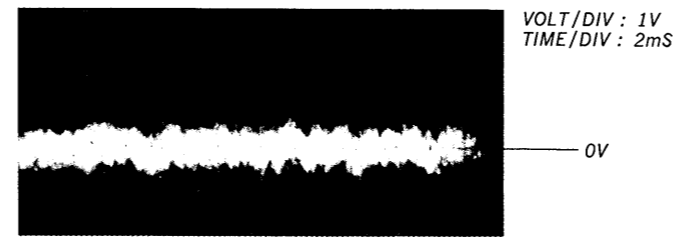
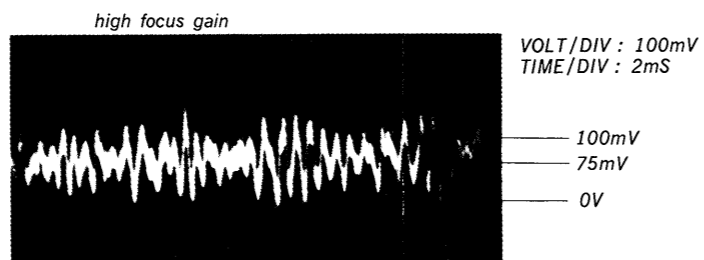
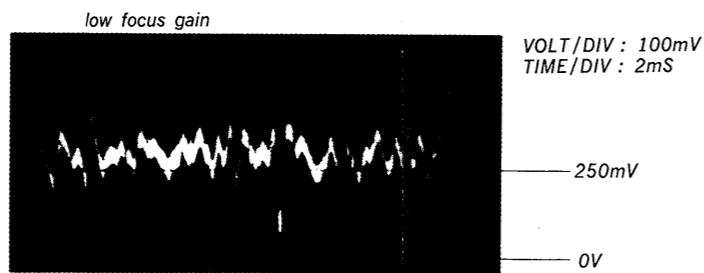

• Incorrect Examples (fundamental wave appears)

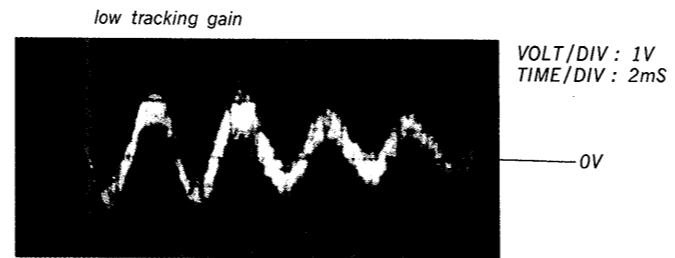

• Incorrect Examples (higher fundamental wave than for low gain)

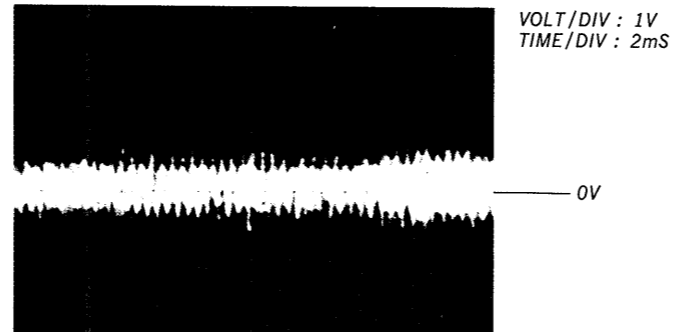

Adjustment Location: main board

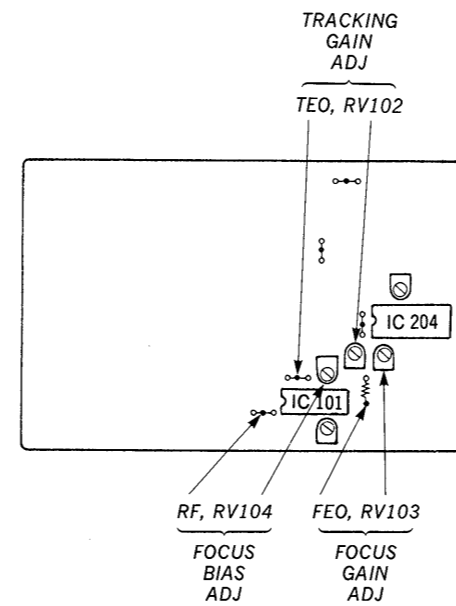

3-1. CIRCUIT BOARDS LOCATION

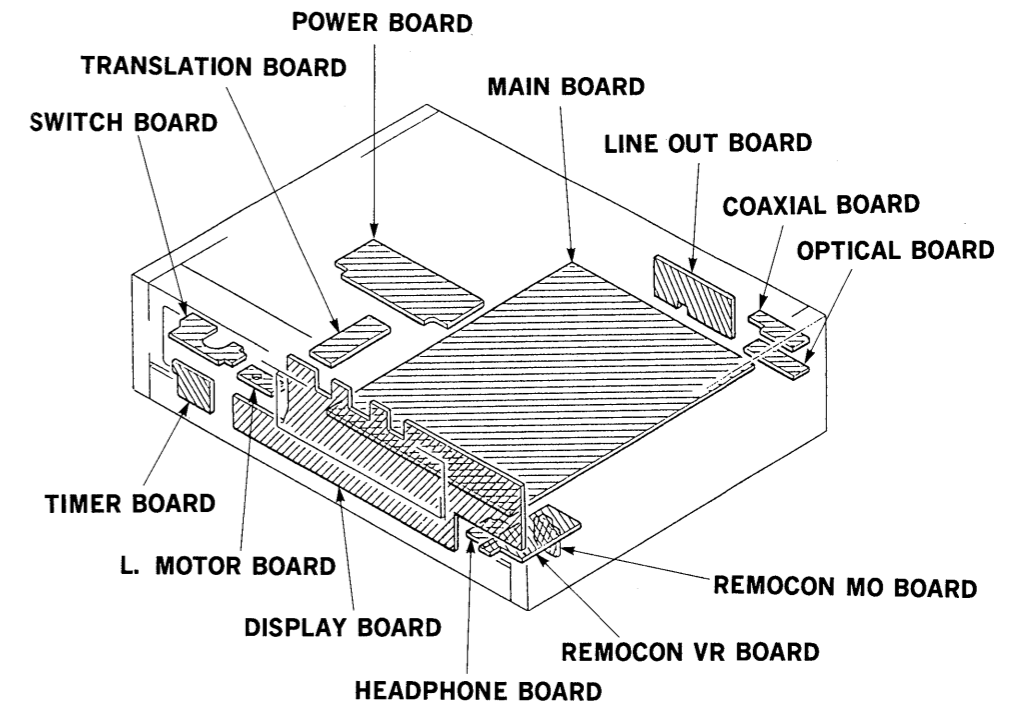

• Semiconductor Location

Ref.No.	Location	Ref. No.	Location
D101	J-5	Q383	G-9
D381	D-10	Q801	H-20
D391	F-26	Q802	I-21
D802	G-16	Q901	E-10
D901	I-11	Q902	E-10
D902	I-11	Q950	G-9
D903	I-10	Q951	H-9
D904	I-10	Q952	I-8
D950	I-10	Q961	H-8
D951	I-9		
D952	I-9		
D953	I-9		
D955	I-8		
D956	I-8		
D957	G-8		
D958	I-9		
D961	I-9		
D962	I-9		
IC101	H-5		
IC201	H-2		
IC202	H-3		
IC204	F-3		
IC302	E-5		
IC303	F-6		
IC351	C-3		
IC352	B-3		
IC353	D-7		
IC354	C-6		
IC356	C-11		
IC357	C-11		
IC358	F-9		
IC391	E-24		
IC401	C-8		
IC402	C-9		
IC501	E-8		
IC502	E-9		
IC801	I-21		
IC802	I-17		
IC901	G-11		
IC902	G-10		
IC903	C-7		
IC905	G-9		
Q101	I-5		
Q205	E-2		
Q206	E-2		
Q381	G-10		
Q382	F-7		

Note on Printed Wiring Board:

- : parts extracted from the component side.
- : indicates side identified with part number.
- : Jumper wire connected to the ground pattern on the component side.
- : parts mounted on the conductor side.

3-2. PRINTED WIRING BOARDS • Refer to page 18 for Semiconductor Lead Layouts.

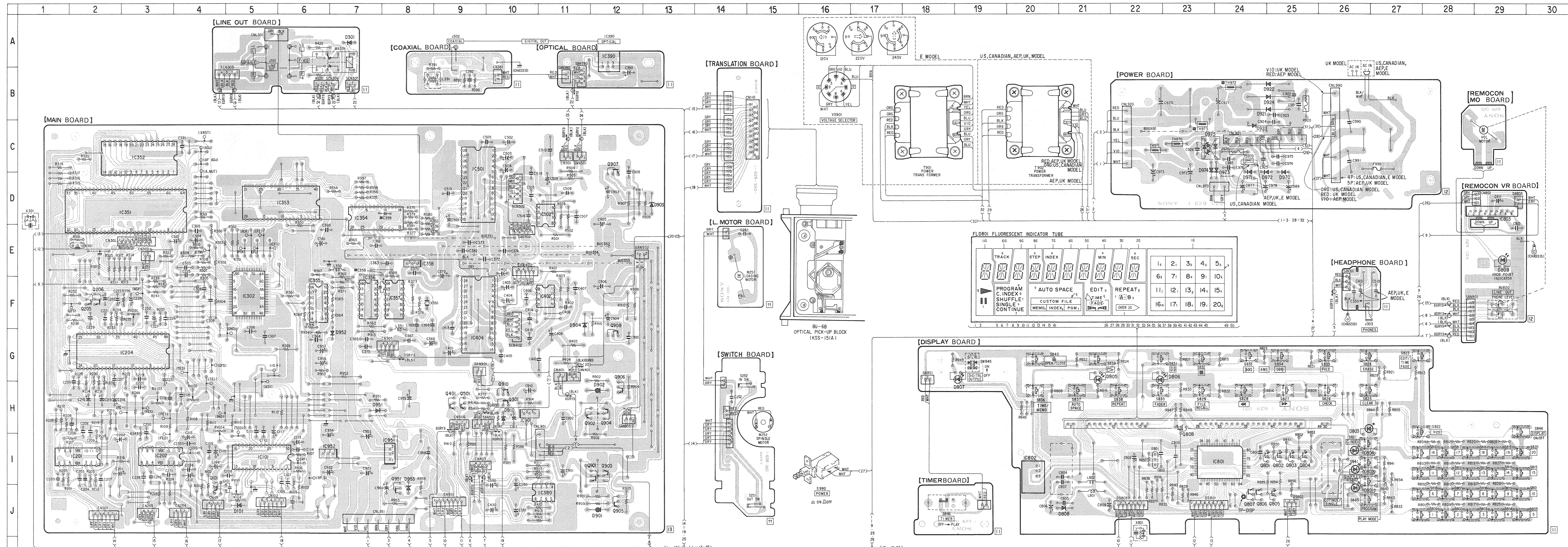

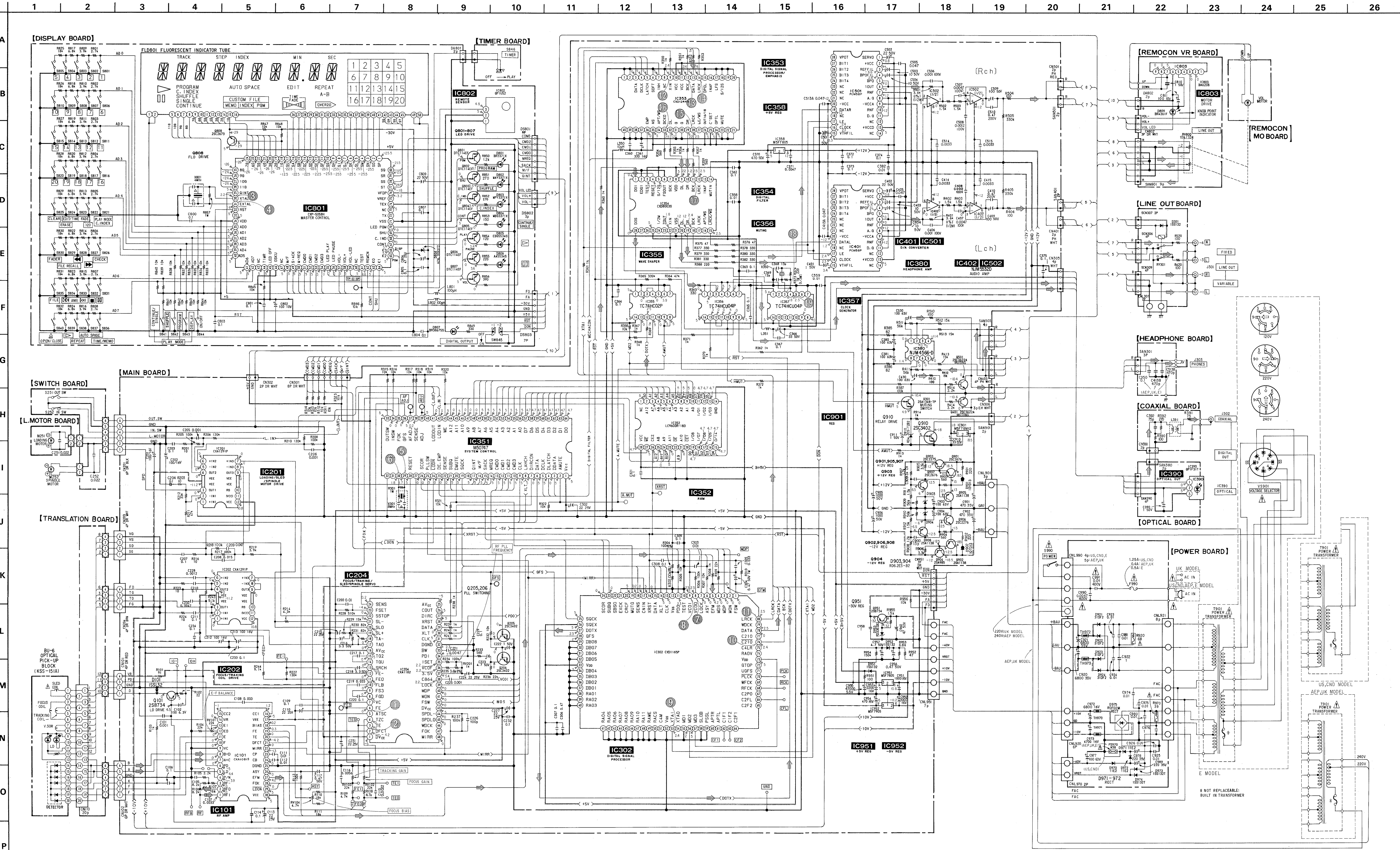

Note on Schematic Diagram:

- All capacitors are in μF unless otherwise noted. $\text{pF} = \mu\text{F}$ and tantalums.
- All resistors are in Ω and $\frac{1}{4}\text{W}$ or less unless otherwise specified.
- % : indicates tolerance.
- \triangle : internal component.
- \square : fusible resistor.

Note:
 The components identified by mark Δ or dotted line with mark Δ are critical for safety. Replace only with part number specified.

Note:
 Les composants identifiés par une marque Δ ou une ligne pointillée sont critiques pour la sécurité. Ne les remplacer que par une pièce portant le numéro spécifié.

○ = B+ Line
 □ = B- Line
 ◊ = adjustment for repair.
 e Voltage and waveforms are dc with respect to ground under no-signal conditions.
 (:) : STOP
 (:) : PLAY
 e Voltages are taken with a VOM (input impedance 10M Ω). Voltage variations may be noted due to normal production tolerances.
 e Waveforms are taken with an oscilloscope. Voltage variations may be noted due to normal production tolerances.
 e Circled numbers refer to waveforms.
 e Signal path.
 e : CD

• Wave forms

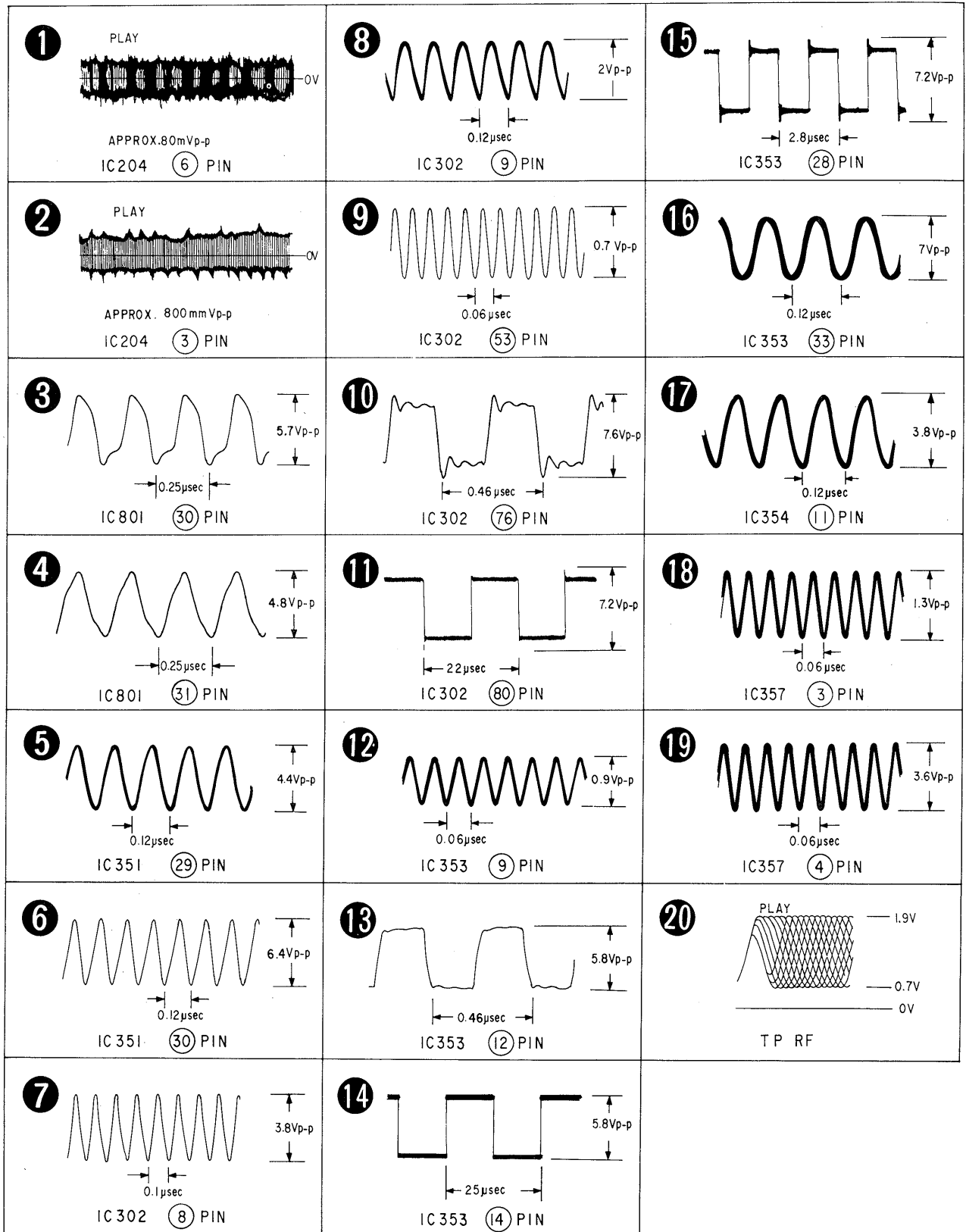

3-4. SEMICONDUCTOR LEAD LAYOUTS

BA6208



M5F78M12
M5F7805

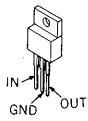

2SA985P
2SC2275A

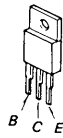

1SS202-1
10YD1.3-A

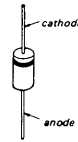

BR3867S



CXA1081S

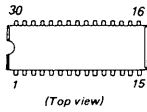

M5F7905

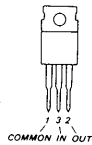

2SA1138-F
2SB734
2SC2676



31DF2

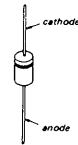

CXA1182S

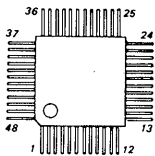

M50747-161SP

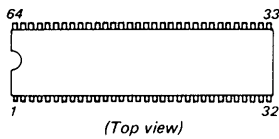

2SC3622A-K



5P-4M

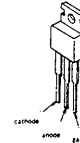

CXA1291P

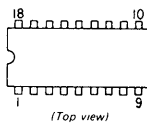

RC4556D
RC5532D-D

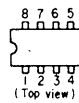

HZ8.2E-B3

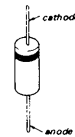

AA5534S

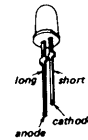

CXD1165Q
CXP5058H-162Q

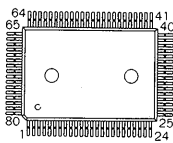

TC74HCU04P
TC74HCO2P

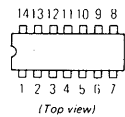

RDF02M

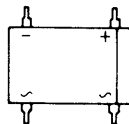

BG5535S

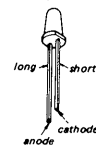

CXD1244S

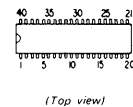

DTA114ES
DTC114ES



RD33ES-B2
RD4.7ES-B2
RD6.2JS-B2
11ES2

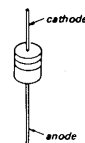

BR3371X
MAY3371X
MBG3371X
MPY3371X-117



CXD8003S
LC9600R-183
PCM58P-J

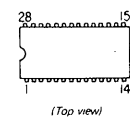

DTC114EF
2SC2673

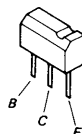

• IC Block Diagrams

IC101 CXA1081S

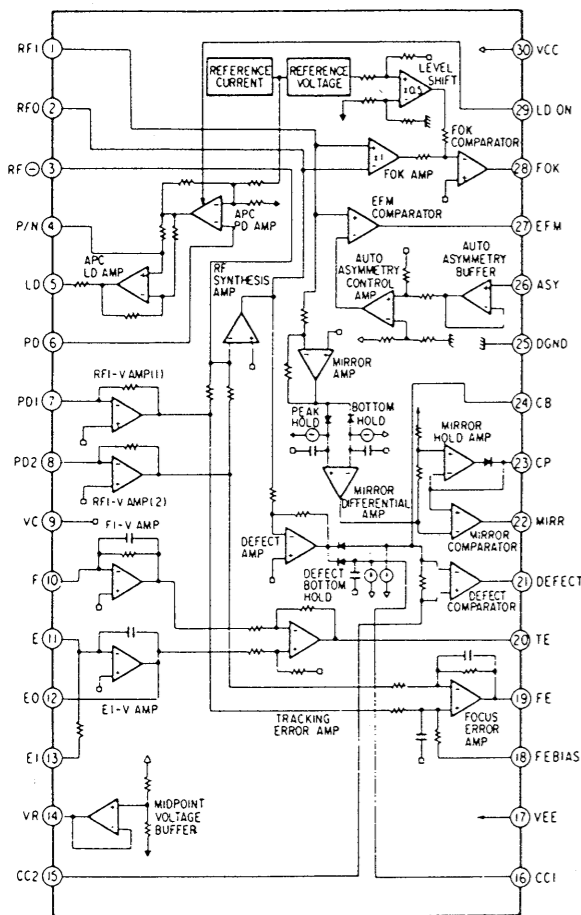

IC201, 202 CXA1291P

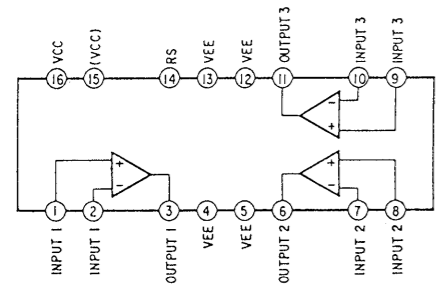

IC204 CXA1182S

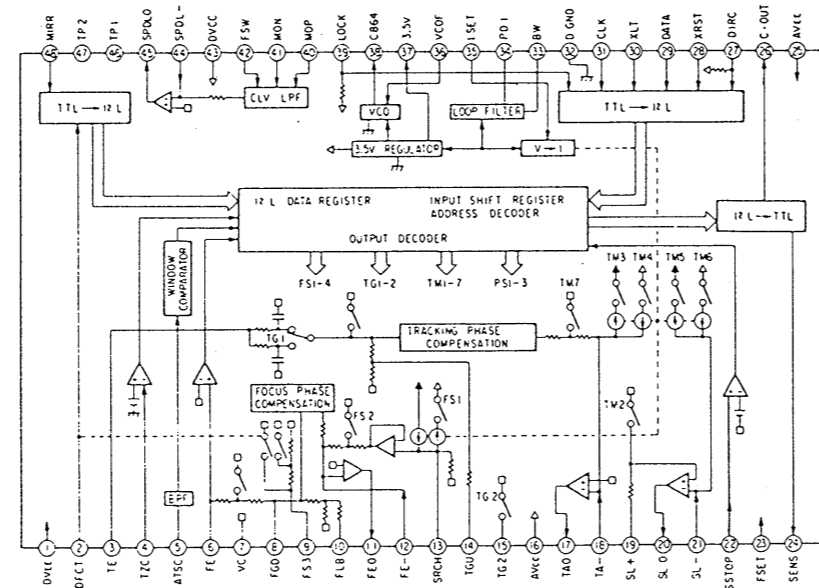

IC302 CXD1165Q

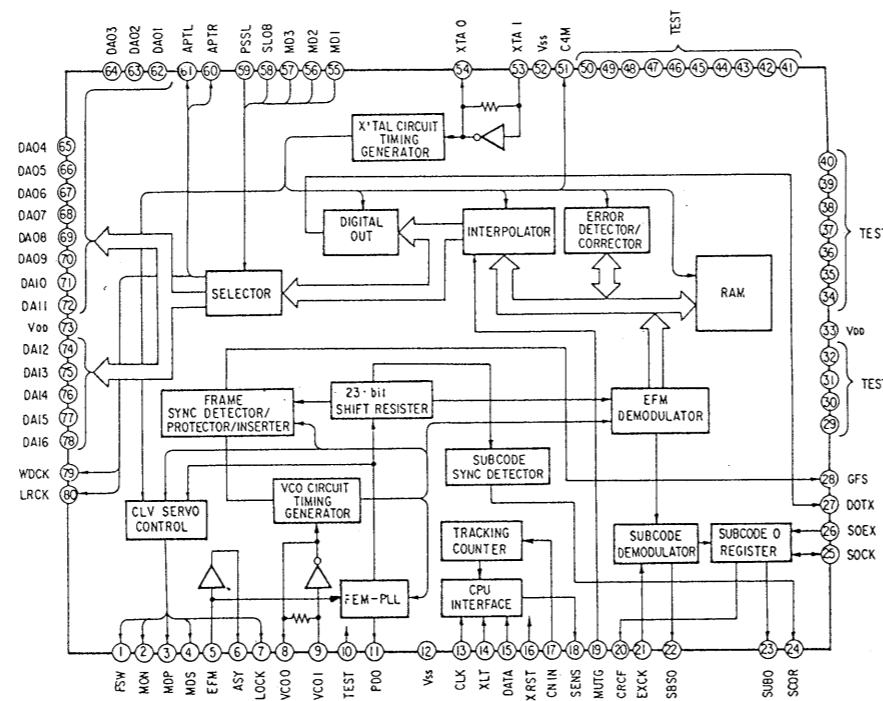

IC355 TC74HC02P

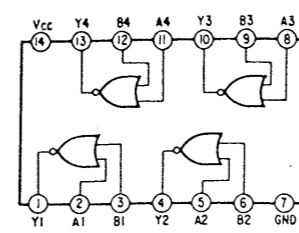

IC401, 501 PCM58P-J

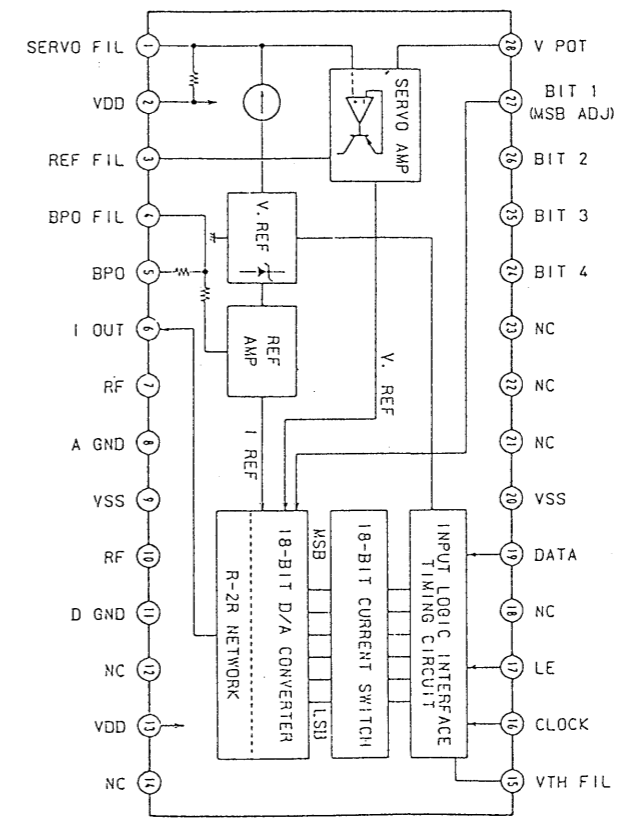

SECTION 4 EXPLODED VIEWS

NOTE:

- The mechanical parts with no reference number in the exploded views are not supplied.
- The construction parts of an assembled part are indicated with a collation number in the remark column.
- Items marked "★" are not stocked since they are seldom required for routine service. Some delay should be anticipated when ordering these items.
- Due to standardization, parts with part number suffix -XX and -X may be different from the parts specified in the components used on the set.
- Color Indication of Appearance Parts
Example:
(RED) ... KNOB, BALANCE (WHITE)
 ↑ ↑
 Cabinet's Color Parts' Color
- CND: Canadian model

The components identified by mark or dotted line with mark are critical for safety. Replace only with part number specified.

Les composants identifiés par une marque sont critiques pour la sécurité. Ne les remplacer que par une pièce portant le numéro spécifié.

4-1. COVER SECTION

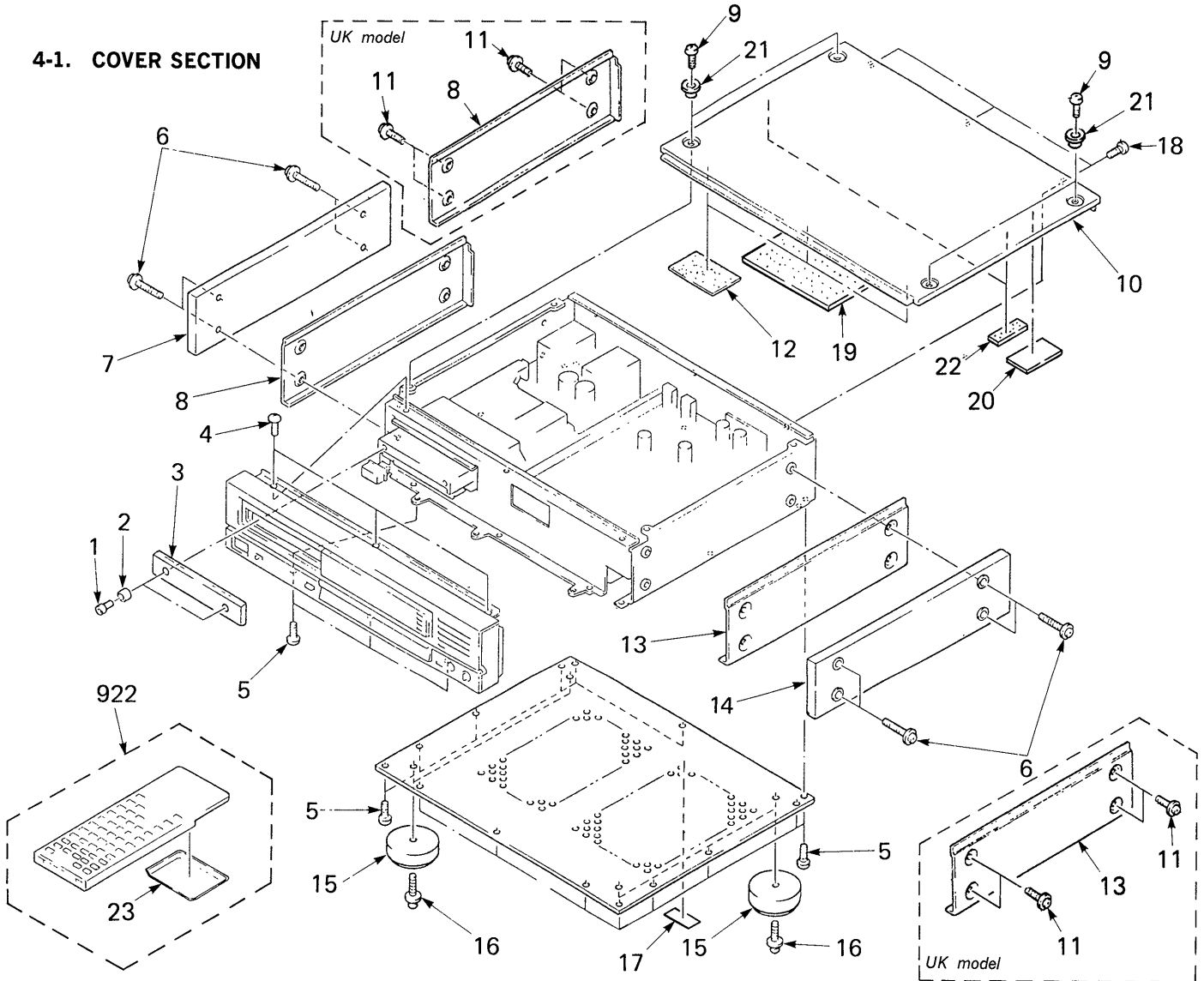

Ref.No	Part No.	Description	Remarks	Ref.No	Part No.	Description	Remarks
1	7-621-996-05	BOLT, HEXAGON SOCKET 2.6X5		13	*4-925-369-01	CASE (RIGHT)	
2	4-884-635-00	BASE, ORNAMENTAL		14	X-4922-575-2	(AEP)....BOARD (RIGHT) ASSY, SIDE	
3	X-4922-551-1	(CND, AEP, UK)....PANEL ASSY, LOADING		14	X-4928-002-1	(US, CND, E)....PLATE (RIGHT) ASSY, SIDE	
3	X-4922-554-1	(US, E)....PANEL ASSY, LOADING		15	X-4922-549-1	FOOT ASSY	
4	4-929-073-01	SCREW (3X8)		16	7-682-664-09	SCREW +PSW 4X14	
5	3-703-685-21	SCREW (+BV 3X8)		17	*3-703-079-21	(UK)....LABEL, CAUTION (BACK)	
6	4-885-979-11	(US, CND, AEP, E)....SCREW (4X25)		18	4-886-821-21	SCREW, M3 CASE STOPPER	
7	X-4922-574-2	(AEP)....BOARD (LEFT) ASSY, SIDE		19	*4-913-189-11	FELT (B), ACOUSTIC ABSORBENT	
7	X-4928-001-1	(US, CND, E)....PLATE (LEFT) ASSY, SIDE		20	*4-923-557-01	DUMPER	
8	*4-925-368-01	CASE (LEFT)		21	4-928-025-11	ESCUTCHEON (TOP PLATE)	
9	4-924-242-11	SCREW (M3X6), FLAT HEAD		22	*4-929-017-01	CUSHION	
10	4-925-367-01	CASE (TOP PLATE)		23	4-928-079-01	COVER, BATTERY	
11	4-847-802-00	(UK)....SCREW		922	1-465-047-11	REMOTE COMMANDER (RM-D670)	23
12	*4-923-563-01	CUSHION					

4-2. FRONT PANEL SECTION

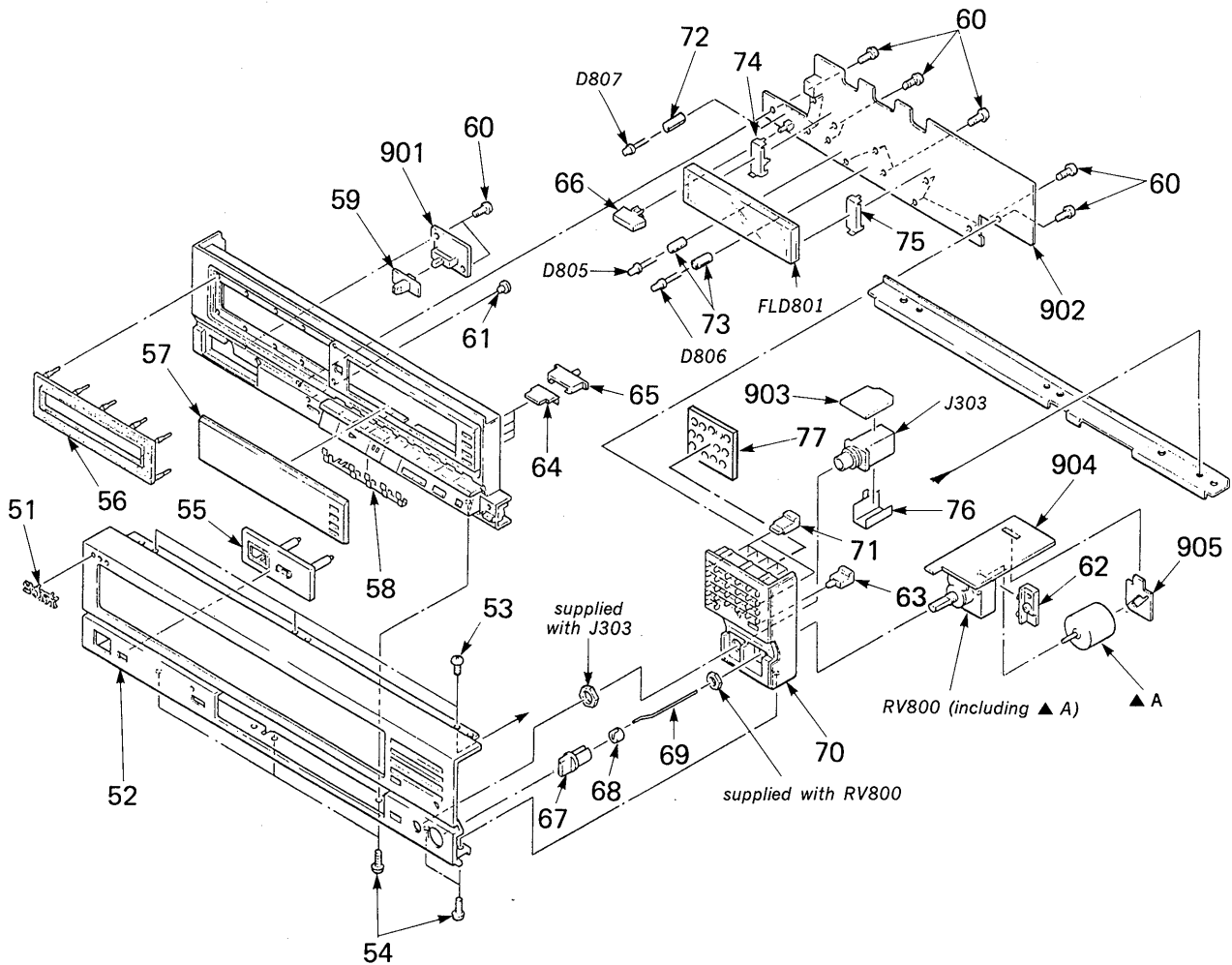



Ref.No	Part No.	Description	Remarks
51	4-908-848-01	EMBLEM, SONY	
52	4-925-353-01	PANEL, FRONT	
53	7-685-870-01	SCREW +BVTT 3X5 (S)	
54	7-685-646-79	SCREW +BTP 3X8 TYPE2 N-S	
55	*4-925-374-01	ESCUTCHEON (POWER SWITCH)	
56	4-925-375-01	PACKING (LOADING)	
57	4-925-373-01	PLATE, INDICATION	
58	4-925-384-01	PLATE (BUTTON), GROUND	
59	4-922-518-11	KNOB (TIMER)	
60	7-685-134-19	SCREW +BTP 2.6X8 TYPE2 N-S	
61	4-925-327-01	INDICATOR	
62	*4-922-980-01	HOLDER (LED)	
63	4-925-383-01	BUTTON (DIAPLAY)	
64	4-925-381-01	BUTTON (MODE)	
65	4-925-382-01	BUTTON (MODE HOLDER)	
66	4-925-326-01	BUTTON (D/A)	
67	4-922-977-01	KNOB (HP)	
68	4-922-978-01	HOLDER (FIBER)	
69	4-922-979-01	INDICATOR	
70	*4-925-355-01	BASE (RIGHT), PANEL	



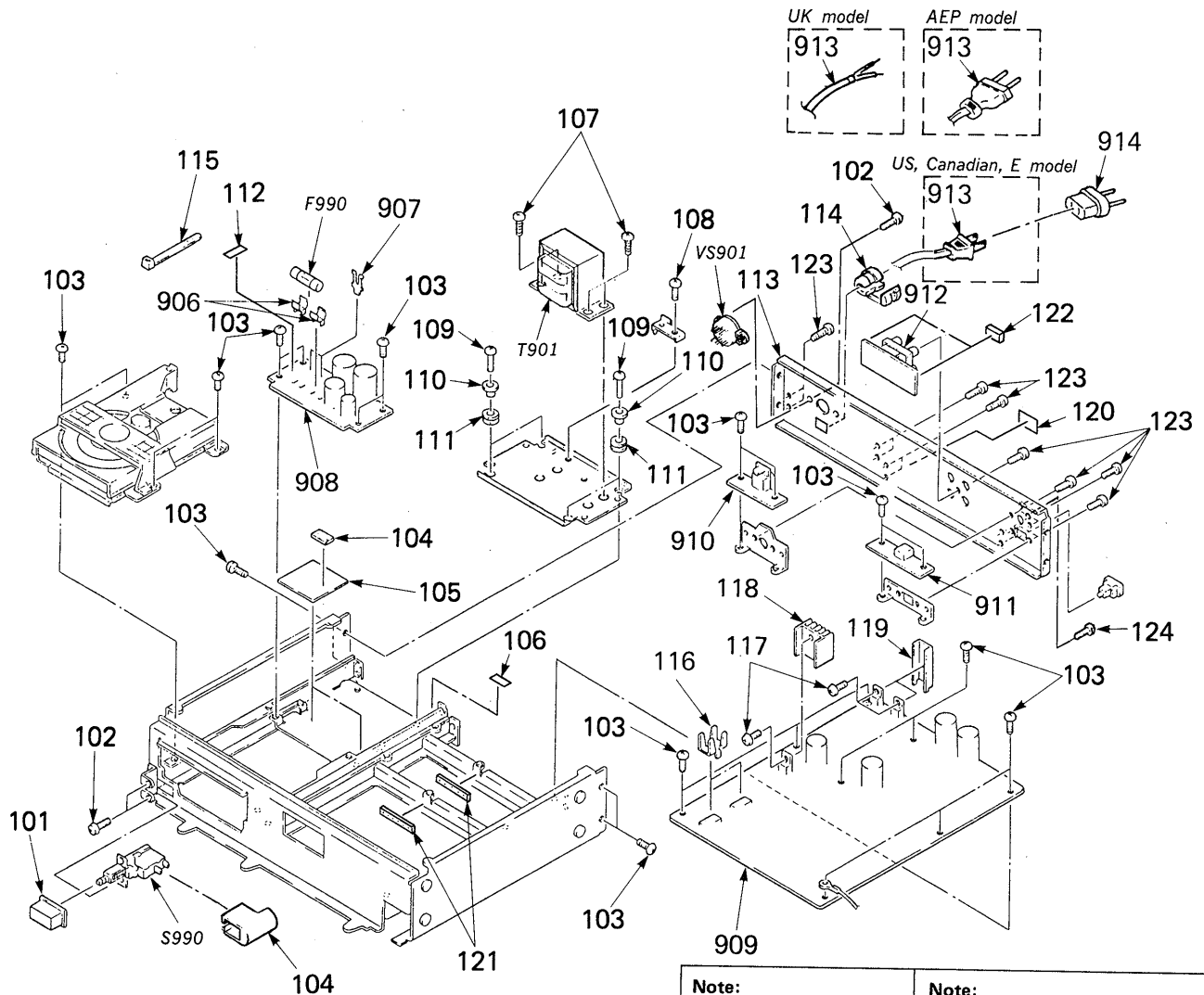









Ref.No	Part No.	Description	Remarks
71	4-927-604-01	BUTTON (MC)	
72	*4-923-532-31	SPACER, LED	
73	*4-923-532-21	SPACER, LED	
74	*4-922-524-01	HOLDER (LEFT)	
75	*4-922-523-01	HOLDER (RIGHT)	
76	4-925-366-01	PLATE (HP), GROUND	
77	*4-929-021-01	CUSHION (20 KEY)	
901	*1-629-023-11	PC BOARD, TIMER	
902	*A-4655-076-A	MOUNTED PCB, DISPLAY	
903	*1-629-022-11	PC BOARD, HEADPHONE	
904	*1-629-024-11	PC BOARD, REMOCON VR	
905	*1-629-025-11	PC BOARD, REMOCON MO	
D805	8-719-907-81	DIODE 5P-4M	
D806	8-719-907-75	DIODE AA5534S	
D807	8-719-971-70	DIODE BR3867S	
FLD801	1-519-476-11	INDICATOR TUBE, FLUORESCENT	
J303	1-507-796-61	JACK, LARGE TYPE (PHONES)	
RV800	1-238-315-21	RES, VAR, CARBON 10K/10K (LINE OUT) (Including VOL MOTOR)	

4-3. CHASSIS SECTION



Note:
The components identified by mark  or dotted line with mark  are critical for safety. Replace only with part number specified.

Note:
Les composants identifiés par une marque  sont critiques pour la sécurité. Ne les remplacer que par une pièce portant le numéro spécifié.

Ref.No	Part No.	Description	Remarks	Ref.No	Part No.	Description	Remarks
101	4-923-520-01	KNOB, POWER		121	*4-929-013-01	ABSORBENT, VIBRATION	
102	7-682-547-09	SCREW +B 3X6		122	*4-929-018-01	ABSORBENT, VIBRATION	
103	4-929-073-01	SCREW (3X8)		123	4-929-074-01	SCREW (3X8)	
104	3-575-524-00	COVER, POWER SWITCH		124	7-685-647-79	SCREW +BVTP 3X10 TYPE2 N-S	
105	*4-925-394-01	SHEET, INSULATING		906	1-533-183-11	HOLDER, FUSE	
106	3-831-441-XX	CUSHION (B), CABINET		907	*1-535-688-11	TERMINAL	
107	7-682-560-04	SCREW +BVTT 4X6 (S)		908	*1-629-020-11	PC BOARD, POWER	
108	7-682-547-04	SCREW +BVTT 3X6 (S)		909	*A-4651-225-A	MOUNTED PCB, MAIN	
109	7-685-873-09	SCREW +BVTT 3X10 (S)		910	*1-629-017-11	PC BOARD, COAXIAL	
110	4-928-032-01	COLLAR (A)		911	*1-629-016-11	PC BOARD, OPTICAL	
111	*4-888-798-00	BUSHING, RUBBER		912	*1-629-019-11	PC BOARD, LINE OUT	
112	3-701-948-10	(AEP, UK)... LABEL (T400MA), FUSE		913	 1-555-386-00	(E)... CORD, POWER	
112	*3-701-947-08	(E)... LABEL (T500MA), FUSE		913	 1-555-795-00	(AEP)... COAD, POWER	
113	*4-925-361-12	(US)... PANEL, BACK		913	 1-556-035-00	(UK)... COAD, POWER	
113	*4-925-361-22	(CND)... PANEL, BACK		913	 1-557-577-11	(US, CND)... COAD, POWER	
113	*4-925-361-32	(AEP)... PANEL, BACK		914	1-526-565-00	(E)... AC PLUG ADAPTOR	
113	*4-925-361-42	(UK)... PANEL, BACK		F990	 1-532-066-11	(AEP, UK)... FUSE, TIME-LAG T0.4A	
113	*4-925-361-52	(E)... PANEL, BACK		F990	 1-532-279-00	(E)... FUSE, TIME-LAG T0.5A	
114	2-231-019-00	CLAMPER, CORD		F990	 1-532-741-11	(US, CND)... FUSE, GLASS TUBE 1.25A 125V	
115	3-655-653-21	BAND (TAITON), BINDING		S990	 1-570-156-11	SWITCH, PUSH (AC POWER)(1 KEY)(POWER)	
116	*4-922-525-01	HEAT SINK		T901	 1-449-631-11	(E)... TRANSFORMER, POWER	
117	7-682-147-15	SCREW, TR		T901	 1-449-632-11	(US, CND)... TRANSFORMER, POWER	
118	*4-363-146-00	HEAT SINK, V.OUT		T901	 1-449-633-11	(AEP, UK)... TRANSFORMER, POWER	
119	*3-309-144-01	HEAT SINK		VS901	 1-526-576-51	(E)... SELECTOR, POWER VOLTAGE	
120	*4-885-838-00	(AEP, UK, E)... LABEL, CLASS 1					

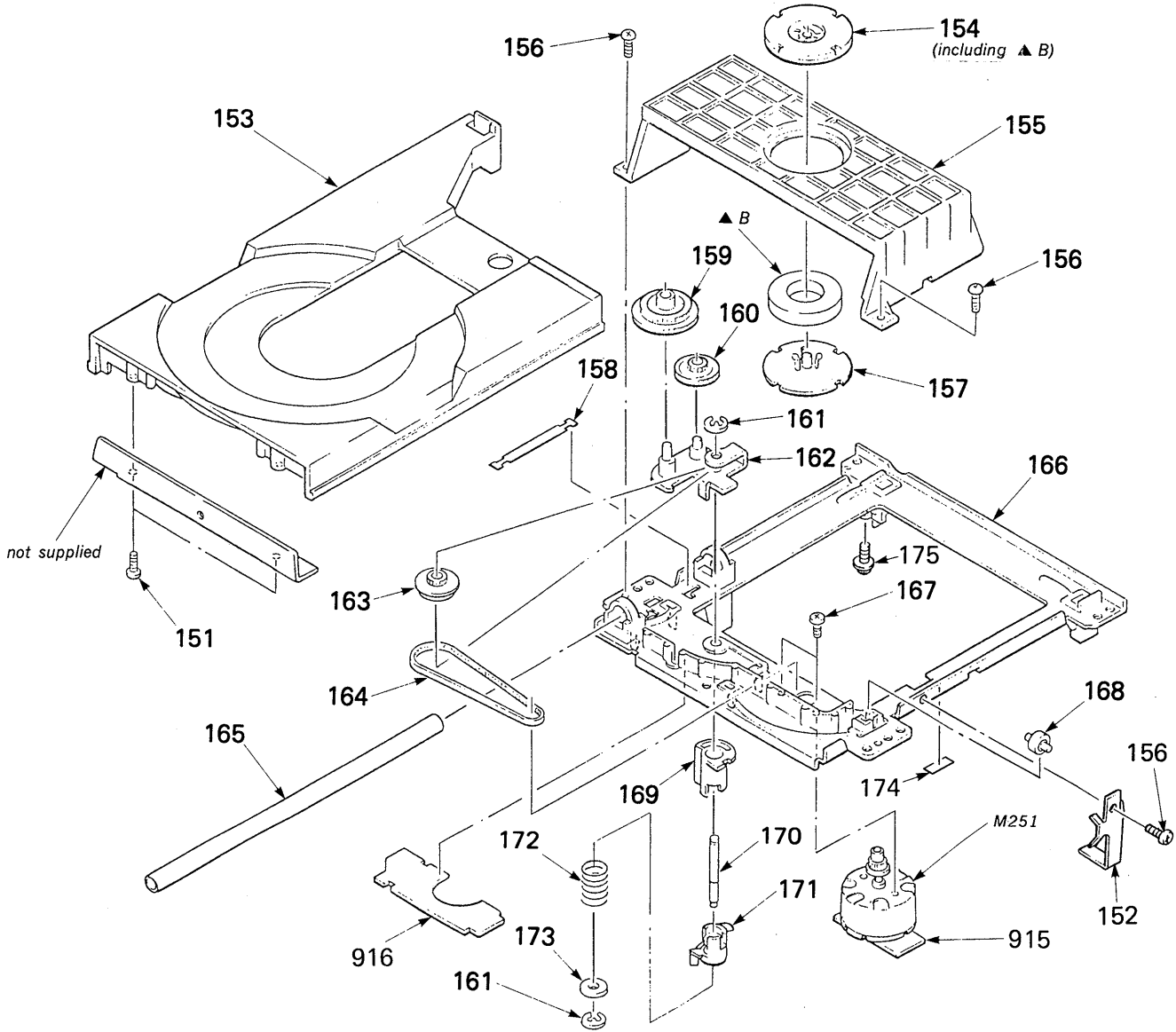

4-4. MECHANISM SECTION
(CDM11A-6B)



Ref.No	Part No.	Description	Remarks	Ref.No	Part No.	Description	Remarks
151	7-685-647-79	SCREW +P 3X10 TYPE2 SLIT		165	4-927-617-01	BAR, GUIDE	
152	*4-927-655-01	LIMITER		166	*4-927-641-04	CHASSIS (OUTSERT), MECHANICAL	
153	*4-927-642-01	TABLE (EXL), DISK		167	7-621-775-08	SCREW +P 2.6X3	
154	A-4665-024-A	MAGNET ASSY		168	4-927-627-01	ROLLER (S, G)	
155	*4-927-638-03	HOLDER (A,P)		169	4-927-624-01	CAM (L,A)	
156	7-621-770-67	SCREW +BVTT 2.6X6 (S)		170	4-927-665-01	SHAFT (S)	
157	*4-918-679-04	PULLEY, PRESS		171	4-927-635-01	CAM (L,B)	
158	*4-927-648-01	SLIDER (GROUND)		172	3-659-338-00	SPRING, COMPRESSION	
159	4-927-620-01	GEAR (P)		173	4-927-654-01	WASHER (LIMITER)	
160	4-927-628-01	GEAR (C)		174	3-831-441-XX	CUSHION	
161	7-624-105-04	STOP RING 2.3, TYPE -E		175	*4-917-583-21	BRACKET, YOKE	
162	X-4927-608-1	ARM ASSY, SWING		915	*1-629-359-11	PC BOARD, L.MOTOR	
163	4-929-724-01	PULLEY (B)		916	*1-629-360-11	PC BOARD, SWITCH	
164	4-927-649-01	BELT		M251	A-4608-362-A	MOTOR (L) ASSY (LOADING)	



REVISED

4-5. OPTICAL PICK-UP BLOCK SECTION (BU-6B)

Note:
The components identified by mark  or dotted line with mark  are critical for safety. Replace only with part number specified.

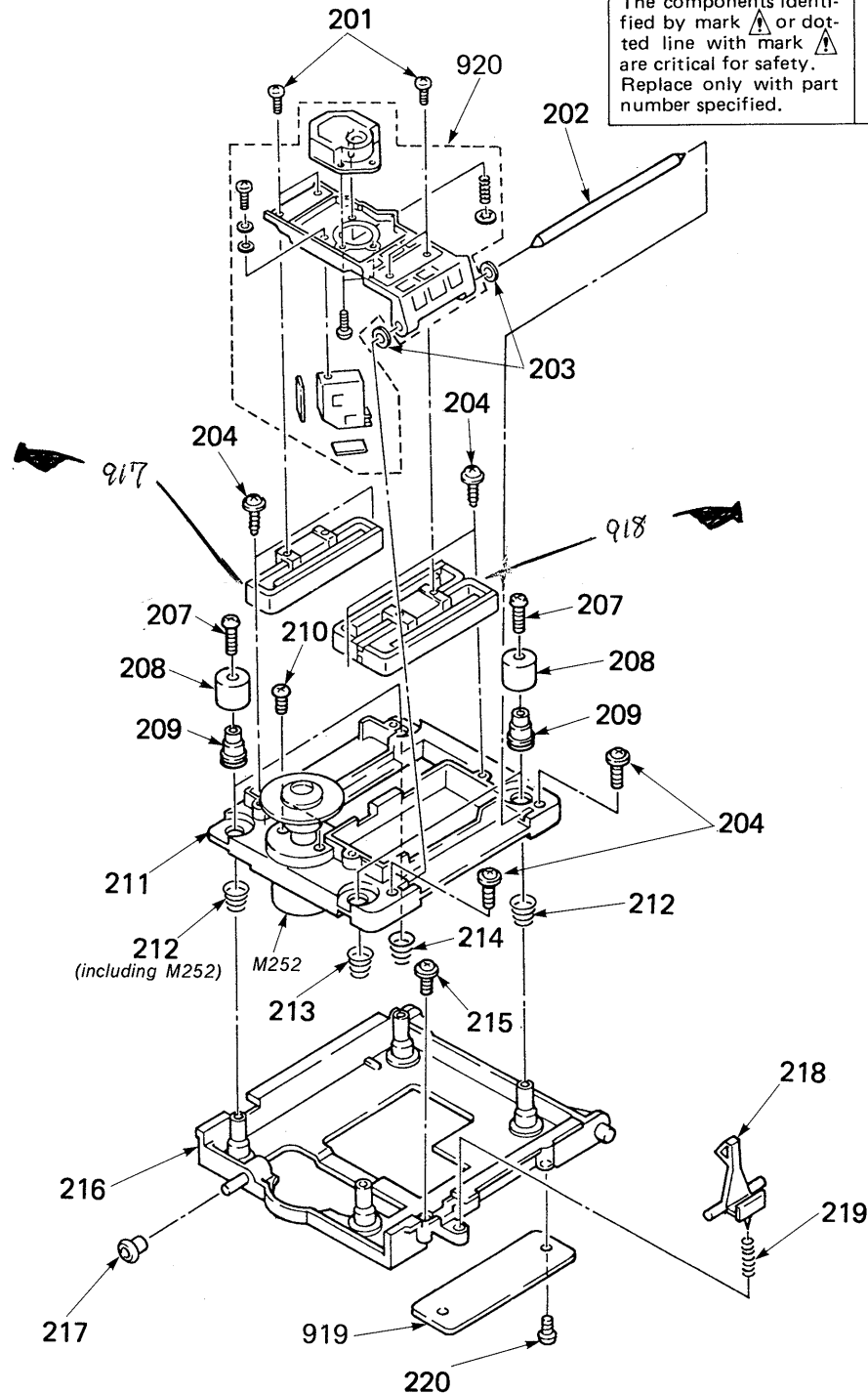
Note:
Les composants identifiés par une marque  sont critiques pour la sécurité. Ne les remplacer que par une pièce portant le numéro spécifié.



Ref.No	Part No.	Description	Remarks	Ref.No	Part No.	Description	Remarks
201	3-318-203-61	SCREW (B1.7X4), TAPPING		214	4-917-573-01	SPRING (E)	
202	*4-910-431-01	SHAFT, SLIDE		215	7-685-132-19	+ PTPWH (2.6X5)	
203	*4-917-582-01	CUSHION, SLIDE		216	*4-927-637-01	HOLDER (BU-6)	
204	7-685-646-79	SCREW, TAPPING		217	4-927-631-01	ROLLER (L)	
205		deletion		218	4-927-626-01	LEVER (L)	
206		deletion		219	3-305-423-00	SPRING, COMPRESSION	
207	7-685-134-19	SCREW +BTP 2.6X8 TYPE2 N-S		220	7-621-773-86	SCREW +BVTT 2.6X4 (S)	
208	4-927-634-01	HOLDER (SP)		917	A-4638-084-A	SENSOR ASSY, SPEED	
209	4-917-562-01	INSULATOR		918	A-4608-335-A	MOTOR ASSY, LINEAR	
210	7-621-255-25	SCREW +P2X4		919	*1-628-390-11	PC BOARD, TRANSLATION	
211	X-4927-605-3	M. BASE ASSY(Including M252)		920	 8-848-047-01	PICK UP, OPTICS (KSS-151A)	
212	4-917-572-01	SPRING (B)		921		deletion	
213	4-917-571-01	SPRING (A)					

REVISED

SECTION 5
ELECTRICAL PARTS LIST

NOTE:

- Due to standardization, replacements in the parts list may be different from the parts specified in the diagrams or the components used on the set.
- Items marked "★" are not stocked since they are seldom required for routine service. Some delay should be anticipated when ordering these items.
- If there are two or more same circuits in a set such as a stereophonic machine, only typical circuit parts may be indicated and capacitors and resistors in other same circuits may be omitted.

CAPACITORS:
MF: μ F, PF: μ MF.

RESISTORS

- All resistors are in ohms.
- F: nonflammable

COILS

- MMH: mH, UH: μ H

SEMICONDUCTORS

In each case, U: μ , for example:
UA...: μ A..., UPA...: μ PA...,
UPC...: μ PC, UPD...: μ PD...

- CND: Canadian model

The components identified by mark Δ or dotted line with mark Δ are critical for safety. Replace only with part number specified.

Les composants identifiés par une marque Δ sont critiques pour la sécurité. Ne les remplacer que par une pièce portant le numéro spécifié.

Ref.No	Part No.	Description
901	*1-629-023-11	PC BOARD, TIMER
902	*A-4655-076-A	MOUNTED PCB, DISPLAY
903	*1-629-022-11	PC BOARD, HEADPHONE
904	*1-629-024-11	PC BOARD, REMOCON VR
905	*1-629-025-11	PC BOARD, REMOCON MO
906	1-533-183-11	HOLDER, FUSE
907	*1-535-688-11	TERMINAL
908	*1-629-020-11	PC BOARD, POWER
909	*A-4651-225-A	MOUNTED PCB, MAIN
910	*1-629-017-11	PC BOARD, COAXIAL
911	*1-629-016-11	PC BOARD, OPTICAL
912	*1-629-019-11	PC BOARD, LINE OUT
913	Δ 1-555-386-00	(E)...CORD, POWER
913	Δ 1-555-795-00	(AEP)...COAD, POWER
913	Δ 1-556-035-00	(UK)...COAD, POWER
913	Δ 1-557-577-11	(US, CND)...COAD, POWER
914	1-526-565-00	(E)...AC PLUG ADAPTOR
915	*1-629-359-11	PC BOARD, L.MOTOR
916	*1-629-360-11	PC BOARD, SWITCH
917	A-4638-084-A	SENSOR ASSY, SPEED
918	A-4608-335-A	MOTOR ASSY, LINEAR
919	*1-628-390-11	PC BOARD, TRANSLATION
920	Δ 8-848-047-01	PICK UP, OPTICS (KSS-151A)
921		deletion
922	1-465-047-11	REMOTE COMMANDER (RM-D670)
BUS351	*1-560-242-21	BUS BAR 4P
BUS352	*1-560-242-31	BUS BAR 5P
BUS353	*1-560-242-31	BUS BAR 5P
BUS354	*1-566-959-11	BAR, BUS
BUS900	*1-560-242-21	BUS BAR 4P
CAPACITOR		
C101	1-164-088-11	CERAMIC 0.001MF 50V
C102	1-124-443-00	ELECT 100MF 20% 6.3V
C105	1-162-198-31	CERAMIC 8.2PF 10% 50V
C106	1-164-159-11	CERAMIC 0.1MF 50V
C107	1-130-477-00	MYLAR 0.0033MF 5% 50V
C108	1-136-159-00	FILM 0.033MF 5% 50V
C109	1-164-159-11	CERAMIC 0.1MF 50V
C110	1-126-233-11	ELECT 22MF 20% 25V
C111	1-136-153-00	FILM 0.01MF 5% 50V
C112	1-136-153-00	FILM 0.01MF 5% 50V
C113	1-126-233-11	ELECT 22MF 20% 25V
C114	1-164-159-11	CERAMIC 0.1MF 50V
C115	1-161-375-00	CERAMIC 0.0022MF 30% 16V
C116	1-130-480-00	MYLAR 0.0056MF 5% 50V
C117	1-124-902-00	ELECT 0.47MF 20% 50V
C200	1-161-379-00	CERAMIC 0.01MF 20% 16V
C201	1-123-333-00	ELECT 100MF 20% 16V
C202	1-123-333-00	ELECT 100MF 20% 16V
C203	1-164-159-11	CERAMIC 0.1MF 50V
C204	1-164-159-11	CERAMIC 0.1MF 50V
C205	1-162-294-31	CERAMIC 0.001MF 10% 50V
C206	1-162-294-31	CERAMIC 0.001MF 10% 50V
C207	1-164-159-11	CERAMIC 0.1MF 50V

Ref.No	Part No.	Description
C208	1-136-155-00	FILM 0.015MF 5% 50V
C209	1-136-161-00	FILM 0.047MF 5% 50V
C210	1-164-159-11	CERAMIC 0.1MF 50V
C211	1-164-159-11	CERAMIC 0.1MF 50V
C212	1-123-333-00	ELECT 100MF 20% 16V
C213	1-123-333-00	ELECT 100MF 20% 16V
C215	1-126-233-11	ELECT 22MF 20% 25V
C216	1-123-382-00	ELECT 3.3MF 20% 50V
C217	1-136-165-00	FILM 0.1MF 5% 50V
C218	1-123-382-00	ELECT 3.3MF 20% 50V
C219	1-136-159-00	FILM 0.033MF 5% 50V
C220	1-136-165-00	FILM 0.1MF 5% 50V
C221	1-106-359-00	MYLAR 0.0047MF 5% 50V
C222	1-124-499-11	ELECT 1MF 20% 50V
C223	1-124-927-11	ELECT 4.7MF 20% 50V
C224	1-126-233-11	ELECT 22MF 20% 25V
C225	1-162-294-31	CERAMIC 0.001MF 10% 50V
C226	1-162-282-31	CERAMIC 100PF 10% 50V
C227	1-126-233-11	ELECT 22MF 20% 25V
C228	1-130-472-00	MYLAR 0.0012MF 5% 50V
C229	1-164-159-11	CERAMIC 0.1MF 50V
C230	1-106-359-00	MYLAR 0.0047MF 5% 50V
C231	1-126-233-11	ELECT 22MF 20% 25V
C232	1-164-159-11	CERAMIC 0.1MF 50V
C233	1-164-159-11	CERAMIC 0.1MF 50V
C234	1-164-159-11	CERAMIC 0.1MF 50V
C251	1-136-157-00	FILM 0.022MF 5% 50V
C252	1-136-157-00	FILM 0.022MF 5% 50V
C302	1-126-233-11	ELECT 22MF 20% 25V
C303	1-161-379-00	CERAMIC 0.01MF 20% 16V
C304	1-124-902-00	ELECT 0.47MF 20% 50V
C305	1-136-159-00	FILM 0.033MF 5% 50V
C306	1-136-173-00	FILM 0.47MF 5% 50V
C307	1-164-159-11	CERAMIC 0.1MF 50V
C308	1-164-159-11	CERAMIC 0.1MF 50V
C309	1-164-159-11	CERAMIC 0.1MF 50V
C321	1-164-159-11	CERAMIC 0.1MF 50V
C350	1-164-159-11	(AEP, UK, E)... CERAMIC 0.1MF 50V
C358	1-130-483-00	MYLAR 0.01MF 5% 50V
C359	1-130-483-00	MYLAR 0.01MF 5% 50V
C360	1-136-165-00	FILM 0.1MF 5% 50V
C361	1-124-119-00	ELECT 330MF 20% 16V
C362	1-136-920-00	FILM 0.1MF 5% 50V
C363	1-136-920-00	FILM 0.1MF 5% 50V
C364	1-136-165-00	FILM 0.1MF 5% 50V
C365	1-164-159-11	CERAMIC 0.1MF 50V
C366	1-123-382-00	ELECT 33MF 20% 50V
C367	1-136-165-00	FILM 0.1MF 5% 50V
C368	1-102-950-00	CERAMIC 13PF 5% 50V
C369	1-102-950-00	CERAMIC 13PF 5% 50V
C370	1-124-517-11	ELECT 470MF 20% 50V
C371	1-106-359-00	MYLAR 0.0047MF 5% 50V
C372	1-136-920-00	FILM 0.1MF 5% 50V
C373	1-136-920-00	FILM 0.1MF 5% 50V

Note:

The components identified by mark Δ or dotted line with mark Δ are critical for safety. Replace only with part number specified.

Note:

Les composants identifiés par une marque Δ sont critiques pour la sécurité. Ne les remplacer que par une pièce portant le numéro spécifié.

Ref.No	Part No.	Description				Ref.No	Part No.	Description			
C374	1-136-920-00	FILM	0.1MF	5%	50V	C926	1-130-483-00	MYLAR	0.01MF	5%	50V
C375	1-136-920-00	FILM	0.1MF	5%	50V	C951	1-124-360-00	ELECT	1000MF	20%	16V
C380	1-124-130-00	ELECT	100MF	20%	63V	C952	1-124-360-00	ELECT	1000MF	20%	16V
C381	1-124-130-00	ELECT	100MF	20%	63V	C953	1-124-556-11	ELECT	2200MF	20%	16V
C382	1-130-483-00	MYLAR	0.01MF	5%	50V	C954	1-126-103-11	ELECT	470MF	20%	16V
C390	1-123-380-00	ELECT	1MF	20%	50V	C955	1-126-244-51	ELECT	47000MF		5.5V
C392	1-162-279-31	CERAMIC	75PF	10%	50V	C956	1-124-902-00	ELECT	0.47MF	20%	50V
C401	1-123-380-00	ELECT	1MF	20%	50V	C957	1-124-927-11	ELECT	4.7MF	20%	50V
C402	1-123-357-00	ELECT	22MF	20%	50V	C958	1-136-177-00	FILM	1MF	5%	50V
C403	1-126-059-11	ELECT	10MF	20%	50V	C960	1-124-910-11	ELECT	47MF	20%	50V
C404	1-126-059-11	ELECT	10MF	20%	50V	C972	1-126-017-11	ELECT	6800MF	20%	16V
C405	1-130-491-00	MYLAR	0.047MF	5%	50V	C973	1-124-898-11	ELECT	4700MF	20%	16V
C406	1-136-854-00	FILM	0.001MF	2%	100V	C974	1-130-483-00	MYLAR	0.01MF	5%	50V
C407	1-136-870-00	FILM	0.0047MF	2%	100V	C975	1-130-483-00	MYLAR	0.01MF	5%	50V
C408	1-136-856-00	FILM	0.0012MF	2%	100V	C976	1-136-177-00	FILM	1MF	5%	50V
C409	1-124-572-11	ELECT	100MF	20%	50V	C977	1-124-130-00	ELECT	100MF	20%	63V
C410	1-136-580-11	FILM	0.47MF	10%	200V	C978	1-124-484-11	ELECT	220MF	20%	35V
C413A	1-130-491-00	MYLAR	0.047MF	5%	50V	C980	1-130-483-00	MYLAR	0.01MF	5%	50V
C413B	1-162-290-31	(AEP, UK, E).... CERAMIC	470PF	10%	50V	C981	1-130-483-00	MYLAR	0.01MF	5%	50V
C414	1-130-477-00	MYLAR	0.0033MF	5%	50V	C989	1-124-484-11	ELECT	220MF	20%	35V
C415	1-130-477-00	MYLAR	0.0033MF	5%	50V	C990	Δ 1-162-599-12	CERAMIC	0.0047MF	20%	400V
C430	1-124-130-00	ELECT	100MF	20%	63V	C991	Δ 1-161-744-00	CERAMIC	0.01MF		400V
C501	1-123-380-00	ELECT	1MF	20%	50V	CN101	* 1-564-338-71	PIN, CONNECTOR 4P			
C502	1-123-357-00	ELECT	22MF	20%	50V	CN110	* 1-562-883-11	SOCKET, CONNECTOR 20P			
C503	1-126-059-11	ELECT	10MF	20%	50V	CN102	* 1-564-340-00	PIN, CONNECTOR 6P			
C504	1-126-059-11	ELECT	10MF	20%	50V	CN110	* 1-562-883-11	SOCKET, CONNECTOR 20P			
C505	1-130-491-00	MYLAR	0.047MF	5%	50V	CN201	* 1-564-340-61	PIN, CONNECTOR 6P			
C506	1-136-854-00	FILM	0.001MF	2%	100V	CN203	* 1-564-338-00	PIN, CONNECTOR 4P			
C507	1-136-870-00	FILM	0.0047MF	2%	100V	CN204	* 1-564-338-81	PIN, CONNECTOR 4P			
C508	1-136-856-00	FILM	0.0012MF	2%	100V	CN301	* 1-564-342-11	PIN, CONNECTOR 8P			
C509	1-124-572-11	ELECT	100MF	20%	50V	CN302	* 1-564-336-00	PIN, CONNECTOR 2P			
C510	1-136-580-11	FILM	0.47MF	10%	200V	CN305	* 1-564-706-11	PIN, CONNECTOR (SMALL TYPE) 4P			
C513A	1-130-491-00	MYLAR	0.047MF	5%	50V	CN306	* 1-564-506-11	PLUG, CONNECTOR 3P			
C513B	1-162-290-31	(AEP, UK, E).... CERAMIC	470PF	10%	50V	CN381	* 1-564-704-11	PIN, CONNECTOR (SMALL TYPE) 2P			
C514	1-130-477-00	MYLAR	0.0033MF	5%	50V	CN401	* 1-564-704-11	PIN, CONNECTOR (SMALL TYPE) 2P			
C515	1-130-477-00	MYLAR	0.0033MF	5%	50V	CN403	* 1-564-706-11	PIN, CONNECTOR (SMALL TYPE) 4P			
C530	1-124-130-00	ELECT	100MF	20%	63V	CN501	* 1-564-704-11	PIN, CONNECTOR (SMALL TYPE) 2P			
C800	1-164-159-11	CERAMIC	0.1MF		50V	CN802	* 1-564-337-00	PIN, CONNECTOR 3P			
C801	1-164-159-11	CERAMIC	0.1MF		50V	CN951	* 1-564-341-11	PIN, CONNECTOR 7P			
C802	1-124-584-00	ELECT	100MF	20%	10V	CNL301	* 1-508-829-12	H TYPE BASE POST 2P			
C803	1-164-159-11	CERAMIC	0.1MF		50V	CNL901	* 1-535-116-00	TERMINAL 3P			
C804	1-164-159-11	CERAMIC	0.1MF		50V	CNL920	* 1-535-119-00	TERMINAL 6P			
C805	1-164-159-11	CERAMIC	0.1MF		50V	CNL921	* 1-535-121-00	TERMINAL 6P			
C806	1-124-477-11	ELECT	47MF	20%	25V	CNL951	* 1-535-120-00	TERMINAL 7P			
C807	1-164-159-11	CERAMIC	0.1MF		50V	CNL970	* 1-535-115-00	TERMINAL 2P			
C809	1-126-233-11	ELECT	22MF	20%	50V	CNL990	* 1-535-141-00	(US, CND, E).... BASE POST 22MM (10MM PITCH) 4P			
C810	1-124-611-00	ELECT	1MF	20%	50V	CNL990	* 1-535-142-00	(AEP, UK).... BASE POST 22MM (10MM PITCH) 5P			
C811	1-124-443-00	ELECT	100MF	20%	10V	D101	8-719-107-94	DIODE 1SS202-1			
C900	1-102-950-00	CERAMIC	13PF	5%	50V	D301	8-719-107-94	DIODE 1SS202-1			
C901	1-124-713-11	ELECT	470MF	20%	35V	D801	8-719-971-49	DIODE BR3371X			
C902	1-124-713-11	ELECT	470MF	20%	35V	D802	8-719-971-52	DIODE MAY3371X			
C903	1-124-130-00	ELECT	100MF	20%	63V	D803	8-719-970-98	DIODE MPY3371X-117			
C904	1-124-130-00	ELECT	100MF	20%	63V	D804	8-719-971-50	DIODE MBG3371X			
C905	1-126-170-11	ELECT	1000MF	20%	50V	D805	8-719-907-81	DIODE 5P-4M			
C906	1-126-170-11	ELECT	1000MF	20%	50V	D806	8-719-907-75	DIODE AA5534S			
C909	1-102-950-00	CERAMIC	13PF	5%	50V	D807	8-719-971-70	DIODE BR3867S			
C910	1-123-382-00	ELECT	33MF	20%	50V	D808	8-719-915-91	DIODE HZ8.2E-B3			
C911	1-123-380-00	ELECT	1MF	20%	50V	D809	8-719-970-49	DIODE BR4361F			
C920	1-126-129-11	ELECT	6800MF	20%	35V	D901	8-719-224-12	DIODE 10YD1.3-A			
C921	1-126-129-11	ELECT	6800MF	20%	35V	D902	8-719-224-12	DIODE 10YD1.3-A			
C922	1-136-177-00	FILM	1MF	5%	50V	D903	8-719-114-41	DIODE RD6.2JS-B2			
C923	1-130-483-00	MYLAR	0.01MF	5%	50V	D904	8-719-114-41	DIODE RD6.2JS-B2			
C924	1-130-483-00	MYLAR	0.01MF	5%	50V	D910	8-719-109-81	DIODE RD4.7ES-B2			
C925	1-130-483-00	MYLAR	0.01MF	5%	50V	D921	8-719-230-02	DIODE 31DF2			

Ref.No	Part No.	Description
D922	8-719-230-02	DIODE 31DF2
D923	8-719-230-02	DIODE 31DF2
D924	8-719-230-02	DIODE 31DF2
D951	8-719-107-94	DIODE 1SS202-1
D952	8-719-107-94	DIODE 1SS202-1
D953	8-719-110-78	DIODE RD33ES-B2
D970	8-719-200-82	DIODE 11ES2
D971	8-719-200-82	DIODE 11ES2
D972	8-719-200-82	DIODE 11ES2
D973	8-719-107-94	DIODE 1SS202-1
D974	8-719-107-94	DIODE 1SS202-1
D975	8-719-937-49	DIODE RDF02M
F990	△.1-532-066-11	(AEP, UK) ... FUSE, TIME-LAG T0.4A
F990	△.1-532-279-00	(E) ... FUSE, TIME-LAG T0.5A
F990	△.1-532-741-11	(US, CND) ... FUSE, GLASS TUBE 1.25A 125V
FLD801	1-519-476-11	INDICATOR TUBE, FLUORESCENT
IC101	8-752-034-00	IC CXA1081S
IC201	8-752-035-28	IC CXA1291P
IC202	8-752-035-28	IC CXA1291P
IC204	8-752-032-33	IC CXA1182S
IC302	8-752-325-59	IC CXD1165Q
IC351	8-759-631-47	IC M50747-161SP
IC352	8-759-820-64	IC LC9600R-183
IC353	8-752-328-61	IC CXD1244S
IC354	8-759-978-53	IC CXD8003S
IC355	8-759-202-12	IC TC74HC02P
IC356	8-759-202-13	IC TC74HCU04P
IC357	8-759-202-13	IC TC74HCU04P
IC358	8-759-604-29	IC M5F7805
IC380	8-759-981-85	IC RC4556D
IC390	8-759-977-71	IC GP1F31T
IC401	8-759-979-08	IC PCM58P-J
IC402	8-759-982-03	IC RC5532DD
IC501	8-759-979-08	IC PCM58P-J
IC502	8-759-982-03	IC RC5532DD
IC801	8-752-806-27	IC CXP5058H-162Q
IC802	8-749-920-03	IC GP1U52
IC803	8-759-962-08	IC BA6208
IC901	8-759-604-39	IC M5F78M12
IC951	8-759-604-29	IC M5F7805
IC952	8-759-604-47	IC M5F7905
J301	1-568-101-11	JACK, PIN 4P (LINE OUT)
J302	1-566-922-21	JACK, PIN 1P (DIGITAL OUT COAXIAL)
J303	1-507-796-61	JACK, LARGE TYPE (PHONES)
L350	1-410-509-11	INDUCTOR 10UH
L351	*1-410-858-11	INDUCTOR 0UH
L391	1-421-946-11	TRANSFORMER, PULSE
L801	1-408-080-00	INDUCTOR 100UH
L802	1-408-080-00	INDUCTOR 100UH
M251	A-4608-362-A	MOTOR (L) ASSY (LOADING)
PS970	1-532-675-00	(AEP, UK, E) ... LINK, IC
Q101	8-729-140-97	TRANSISTOR 2SB734
Q205	8-729-900-80	TRANSISTOR DTC114ES
Q206	8-729-900-80	TRANSISTOR DTC114ES
Q301	8-729-900-61	TRANSISTOR DTA114ES
Q401	8-729-107-99	TRANSISTOR 2SC3622A-K
Q501	8-729-107-99	TRANSISTOR 2SC3622A-K
Q801	8-729-900-45	TRANSISTOR DTC114EF
Q802	8-729-900-45	TRANSISTOR DTC114EF
Q803	8-729-900-45	TRANSISTOR DTC114EF
Q804	8-729-900-45	TRANSISTOR DTC114EF
Q805	8-729-900-45	TRANSISTOR DTC114EF

Ref.No	Part No.	Description
Q806	8-729-900-45	TRANSISTOR DTC114EF
Q807	8-729-900-45	TRANSISTOR DTC114EF
Q808	8-729-967-32	TRANSISTOR 2SC2673
Q901	8-729-167-62	TRANSISTOR 2SC2676
Q902	8-729-113-82	TRANSISTOR 2SA1138-F
Q903	8-729-107-53	TRANSISTOR 2SC2275-A
Q904	8-729-190-53	TRANSISTOR 2SA985-P
Q905	8-729-113-82	TRANSISTOR 2SA1138-F
Q906	8-729-167-62	TRANSISTOR 2SC2676
Q907	8-729-167-62	TRANSISTOR 2SC2676
Q908	8-729-113-82	TRANSISTOR 2SA1138-F
Q910	8-729-900-80	TRANSISTOR DTC114ES
Q951	8-729-140-97	TRANSISTOR 2SB734
RESISTOR		
R101	1-247-806-11	CARBON 91 5% 1/4W
R102	1-249-512-11	CARBON 22 5% 1/4W
R103	1-249-417-11	CARBON 1K 5% 1/4W
R104	1-249-433-11	CARBON 22K 5% 1/4W
R105	1-249-421-11	CARBON 2.2K 5% 1/4W
R106	1-249-428-11	CARBON 8.2K 5% 1/4W
R107	1-247-860-11	CARBON 16K 5% 1/4W
R108	1-249-425-11	CARBON 4.7K 5% 1/4W
R109	1-249-425-11	CARBON 4.7K 5% 1/4W
R110	1-249-432-11	CARBON 18K 5% 1/4W
R111	1-249-432-11	CARBON 18K 5% 1/4W
R112	1-249-441-11	CARBON 100K 5% 1/4W
R201	1-249-393-11	CARBON 10 5% 1/4W
R203	1-249-393-11	CARBON 10 5% 1/4W
R205	1-249-441-11	CARBON 100K 5% 1/4W
R206	1-247-881-00	CARBON 120K 5% 1/4W
R208	1-249-441-11	CARBON 100K 5% 1/4W
R210	1-247-881-00	CARBON 120K 5% 1/4W
R211	1-249-437-11	CARBON 47K 5% 1/4W
R212	1-249-435-11	CARBON 33K 5% 1/4W
R214	1-247-846-11	CARBON 4.3K 5% 1/4W
R216	1-249-393-11	CARBON 10 5% 1/4W
R217	1-247-899-11	CARBON 680K 5% 1/4W
R218	1-249-441-11	CARBON 100K 5% 1/4W
R219	1-249-424-11	CARBON 3.9K 5% 1/4W
R222	1-247-882-11	CARBON 130K 5% 1/4W
R223	1-249-393-11	CARBON 10 5% 1/4W
R224	1-249-393-11	CARBON 10 5% 1/4W
R228	1-247-896-11	CARBON 510K 5% 1/4W
R229	1-249-431-11	CARBON 15K 5% 1/4W
R230	1-249-440-11	CARBON 82K 5% 1/4W
R231	1-249-440-11	CARBON 82K 5% 1/4W
R232	1-249-429-11	CARBON 10K 5% 1/4W
R233	1-249-414-11	CARBON 560 5% 1/4W
R234	1-249-441-11	CARBON 100K 5% 1/4W
R235	1-215-434-00	METAL 3.6K 1% 1/6W
R236	1-249-433-11	CARBON 22K 5% 1/4W
R237	1-249-441-11	CARBON 100K 5% 1/4W
R238	1-249-417-11	CARBON 1K 5% 1/4W
R239	1-249-417-11	CARBON 1K 5% 1/4W
R240	1-249-417-11	CARBON 1K 5% 1/4W
R241	1-249-417-11	CARBON 1K 5% 1/4W
R243	1-247-854-11	CARBON 9.1K 5% 1/4W
R244	1-247-854-11	CARBON 9.1K 5% 1/4W
R301	1-247-903-00	CARBON 1M 5% 1/4W
R303	1-215-469-00	METAL 100K 1% 1/6W
R304	1-215-469-00	METAL 100K 1% 1/6W
R305	1-249-429-11	CARBON 10K 5% 1/4W
R306	1-249-441-11	CARBON 100K 5% 1/4W
R307	1-249-429-11	CARBON 10K 5% 1/4W

Note:
The components identified by mark △ or dotted line with mark △ are critical for safety. Replace only with part numbers specified.

Note:
Les composants identifiés par une marque △ sont critiques pour la sécurité. Ne les remplacer que par une pièce portant le numéro spécifique.

Ref.No	Part No.	Description			
R308	1-249-417-11	CARBON	1K	5%	1/4W
R309	1-249-433-11	CARBON	22K	5%	1/4W
R310	1-247-903-00	CARBON	1M	5%	1/4W
R311	1-249-429-11	CARBON	10K	5%	1/4W
R312	1-249-429-11	CARBON	10K	5%	1/4W
R313	1-249-429-11	CARBON	10K	5%	1/4W
R314	1-249-429-11	CARBON	10K	5%	1/4W
R315	1-249-429-11	CARBON	10K	5%	1/4W
R316	1-249-429-11	CARBON	10K	5%	1/4W
R317	1-249-429-11	CARBON	10K	5%	1/4W
R318	1-249-429-11	CARBON	10K	5%	1/4W
R319	1-249-429-11	CARBON	10K	5%	1/4W
R320	1-249-429-11	CARBON	10K	5%	1/4W
R321	1-249-429-11	CARBON	10K	5%	1/4W
R322	1-249-429-11	CARBON	10K	5%	1/4W
R323	1-249-429-11	CARBON	10K	5%	1/4W
R350	1-249-417-11	CARBON	1K	5%	1/4W
R351	1-249-417-11	CARBON	1K	5%	1/4W
R352	1-249-417-11	CARBON	1K	5%	1/4W
R353	1-249-417-11	CARBON	1K	5%	1/4W
R354	1-249-414-11	CARBON	560	5%	1/4W
R355	1-249-417-11	CARBON	1K	5%	1/4W
R356	1-249-417-11	CARBON	1K	5%	1/4W
R357	1-249-417-11	CARBON	1K	5%	1/4W
R359	1-249-414-11	CARBON	560	5%	1/4W
R360	1-249-417-11	CARBON	1K	5%	1/4W
R361	1-249-417-11	CARBON	1K	5%	1/4W
R362	1-249-417-11	CARBON	1K	5%	1/4W
R363	1-249-411-11	CARBON	330	5%	1/4W
R364	1-249-437-11	CARBON	47K	5%	1/4W
R365	1-247-891-00	CARBON	330K	5%	1/4W
R366	1-249-429-11	CARBON	10K	5%	1/4W
R367	1-249-417-11	CARBON	1K	5%	1/4W
R368	1-249-417-11	CARBON	1K	5%	1/4W
R369	1-249-417-11	CARBON	1K	5%	1/4W
R370	1-249-417-11	CARBON	1K	5%	1/4W
R371	1-249-417-11	CARBON	1K	5%	1/4W
R372	1-249-417-11	CARBON	1K	5%	1/4W
R373	1-214-937-00	CARBON	1M	5%	1/2W
R374	1-249-409-11	CARBON	220	5%	1/4W
R375	1-249-401-11	CARBON	47	5%	1/4W
R376	1-249-401-11	CARBON	47	5%	1/4W
R377	1-249-411-11	CARBON	330	5%	1/4W
R378	1-249-411-11	CARBON	330	5%	1/4W
R379	1-249-411-11	CARBON	330	5%	1/4W
R380	1-249-411-11	CARBON	330	5%	1/4W
R381	1-249-411-11	CARBON	330	5%	1/4W
R382	1-249-411-11	CARBON	330	5%	1/4W
R385	1-249-526-11	CARBON	82	5%	1/4W
R386	1-249-526-11	CARBON	82	5%	1/4W
R387	1-249-441-11	CARBON	100K	5%	1/4W
R388	1-249-409-11	CARBON	220	5%	1/4W
R390	1-249-405-11	CARBON	100	5%	1/4W
R391	1-247-804-11	CARBON	75	5%	1/4W
R392	1-249-410-11	CARBON	270	5%	1/4W
R401	1-249-815-11	CARBON	3.6K	1%	1/2W
R402	1-249-556-11	CARBON	1.5K	5%	1/4W
R403	1-249-556-11	CARBON	1.5K	5%	1/4W
R404	1-247-700-11	CARBON	100	5%	1/4W
R405	1-247-891-00	CARBON	330K	5%	1/4W
R410	1-247-700-11	CARBON	100	5%	1/4W
R411	1-249-466-11	CARBON	56K	5%	1/4W
R412	1-249-460-11	CARBON	15K	5%	1/4W
R413	1-249-460-11	CARBON	15K	5%	1/4W
R414	1-249-421-11	CARBON	2.2K	5%	1/4W

Ref.No	Part No.	Description			
R420	1-247-700-11	CARBON	100	5%	1/4W
R501	1-249-815-11	CARBON	3.6K	1%	1/2W
R502	1-249-556-11	CARBON	1.5K	5%	1/4W
R503	1-249-556-11	CARBON	1.5K	5%	1/4W
R504	1-247-700-11	CARBON	100	5%	1/4W
R505	1-247-891-00	CARBON	330K	5%	1/4W
R510	1-247-700-11	CARBON	100	5%	1/4W
R511	1-249-466-11	CARBON	56K	5%	1/4W
R512	1-249-460-11	CARBON	15K	5%	1/4W
R513	1-249-460-11	CARBON	15K	5%	1/4W
R514	1-249-421-11	CARBON	2.2K	5%	1/4W
R520	1-247-700-11	CARBON	100	5%	1/4W
R801	1-249-422-11	CARBON	2.7K	5%	1/4W
R802	1-249-422-11	CARBON	2.7K	5%	1/4W
R803	1-249-422-11	CARBON	2.7K	5%	1/4W
R804	1-249-422-11	CARBON	2.7K	5%	1/4W
R805	1-249-422-11	CARBON	2.7K	5%	1/4W
R806	1-249-422-11	CARBON	2.7K	5%	1/4W
R807	1-249-422-11	CARBON	2.7K	5%	1/4W
R808	1-249-422-11	CARBON	2.7K	5%	1/4W
R809	1-249-424-11	CARBON	3.9K	5%	1/4W
R810	1-249-424-11	CARBON	3.9K	5%	1/4W
R811	1-249-424-11	CARBON	3.9K	5%	1/4W
R812	1-249-424-11	CARBON	3.9K	5%	1/4W
R813	1-249-424-11	CARBON	3.9K	5%	1/4W
R814	1-249-424-11	CARBON	3.9K	5%	1/4W
R815	1-249-424-11	CARBON	3.9K	5%	1/4W
R816	1-249-424-11	CARBON	3.9K	5%	1/4W
R817	1-249-427-11	CARBON	6.8K	5%	1/4W
R818	1-249-427-11	CARBON	6.8K	5%	1/4W
R819	1-249-427-11	CARBON	6.8K	5%	1/4W
R820	1-249-427-11	CARBON	6.8K	5%	1/4W
R821	1-249-427-11	CARBON	6.8K	5%	1/4W
R822	1-249-427-11	CARBON	6.8K	5%	1/4W
R823	1-249-427-11	CARBON	6.8K	5%	1/4W
R824	1-249-427-11	CARBON	6.8K	5%	1/4W
R825	1-249-432-11	CARBON	18K	5%	1/4W
R826	1-249-432-11	CARBON	18K	5%	1/4W
R827	1-249-432-11	CARBON	18K	5%	1/4W
R828	1-249-432-11	CARBON	18K	5%	1/4W
R829	1-249-432-11	CARBON	18K	5%	1/4W
R830	1-249-432-11	CARBON	18K	5%	1/4W
R831	1-249-432-11	CARBON	18K	5%	1/4W
R832	1-249-432-11	CARBON	18K	5%	1/4W
R833	1-249-429-11	CARBON	10K	5%	1/4W
R834	1-249-429-11	CARBON	10K	5%	1/4W
R835	1-249-429-11	CARBON	10K	5%	1/4W
R836	1-249-429-11	CARBON	10K	5%	1/4W
R837	1-249-429-11	CARBON	10K	5%	1/4W
R838	1-249-429-11	CARBON	10K	5%	1/4W
R839	1-249-429-11	CARBON	10K	5%	1/4W
R840	1-249-429-11	CARBON	10K	5%	1/4W
R841	1-249-429-11	CARBON	10K	5%	1/4W
R842	1-249-429-11	CARBON	10K	5%	1/4W
R843	1-249-429-11	CARBON	10K	5%	1/4W
R844	1-249-429-11	CARBON	10K	5%	1/4W
R845	1-249-429-11	CARBON	10K	5%	1/4W
R846	1-249-429-11	CARBON	10K	5%	1/4W
R847	1-249-429-11	CARBON	10K	5%	1/4W
R848	1-249-429-11	CARBON	10K	5%	1/4W
R849	1-249-411-11	CARBON	330	5%	1/4W
R850	1-249-418-11	CARBON	1.2K	5%	1/4W
R851	1-249-410-11	CARBON	270	5%	1/4W
R852	1-249-410-11	CARBON	270	5%	1/4W
R853	1-249-407-11	CARBON	150	5%	1/4W

Ref.No	Part No.	Description			
R854	1-249-406-11	CARBON	120	5%	1/4W
R855	1-249-409-11	CARBON	220	5%	1/4W
R856	1-249-412-11	CARBON	390	5%	1/4W
R857	1-247-903-00	CARBON	1M	5%	1/4W
R901	1-247-704-11	CARBON	220	5%	1/4W
R902	1-247-704-11	CARBON	220	5%	1/4W
R903	1-247-710-11	CARBON	560	5%	1/4W
R904	1-247-710-11	CARBON	560	5%	1/4W
R905	1-247-719-11	CARBON	3.3K	5%	1/4W
R906	1-247-719-11	CARBON	3.3K	5%	1/4W
R907	1-247-714-11	CARBON	1.2K	5%	1/4W
R908	1-247-714-11	CARBON	1.2K	5%	1/4W
R909	1-249-466-11	CARBON	56K	5%	1/4W
R910	1-249-466-11	CARBON	56K	5%	1/4W
R911	1-249-556-11	CARBON	1.5K	5%	1/4W
R912	1-249-556-11	CARBON	1.5K	5%	1/4W
R913	1-249-417-11	CARBON	1K	5%	1/4W
R914	1-247-713-11	CARBON	1K	5%	1/4W
R920	△1-212-877-11	FUSIBLE	68	5%	1/4W
R951	1-249-405-11	CARBON	100	5%	1/4W
R952	1-249-520-11	CARBON	47	5%	1/4W
R953	1-249-427-11	CARBON	6.8K	5%	1/4W
R954	1-247-883-00	CARBON	150K	5%	1/4W
R955	1-249-556-11	CARBON	1.5K	5%	1/4W
R956	1-249-429-11	CARBON	10K	5%	1/4W
R970	△1-212-871-11	FUSIBLE	39	5%	1/4W
RV101	1-228-995-00	RES, ADJ, CARBON 22K			
RV102	1-228-995-00	RES, ADJ, CARBON 22K			
RV103	1-228-995-00	RES, ADJ, CARBON 22K			
RV104	1-228-993-00	RES, ADJ, CARBON 4.7K			
RV201	1-228-990-00	RES, ADJ, METAL GLAZE 1K			
RV800	1-238-315-21	RES, VAR, CARBON 10K/10K (LINE OUT) (Including VOL MOTOR)			
RY301	1-515-683-11	RELAY			
S251	1-571-736-11	SWITCH, LEAF (OUT SW)			
S252	1-571-736-11	SWITCH, LEAF (IN SW)			
S801	1-554-596-21	SWITCH, KEY BOARD (1)			
S802	1-554-596-21	SWITCH, KEY BOARD (2)			
S803	1-554-596-21	SWITCH, KEY BOARD (3)			
S804	1-554-596-21	SWITCH, KEY BOARD (4)			
S805	1-554-596-21	SWITCH, KEY BOARD (5)			
S806	1-554-596-21	SWITCH, KEY BOARD (6)			
S807	1-554-596-21	SWITCH, KEY BOARD (7)			
S808	1-554-596-21	SWITCH, KEY BOARD (8)			
S809	1-554-596-21	SWITCH, KEY BOARD (9)			
S810	1-554-596-21	SWITCH, KEY BOARD (10)			
S811	1-554-596-21	SWITCH, KEY BOARD (11)			
S812	1-554-596-21	SWITCH, KEY BOARD (12)			
S813	1-554-596-21	SWITCH, KEY BOARD (13)			
S814	1-554-596-21	SWITCH, KEY BOARD (14)			
S815	1-554-596-21	SWITCH, KEY BOARD (15)			
S816	1-554-596-21	SWITCH, KEY BOARD (16)			
S817	1-554-596-21	SWITCH, KEY BOARD (17)			
S818	1-554-596-21	SWITCH, KEY BOARD (18)			
S819	1-554-596-21	SWITCH, KEY BOARD (19)			
S820	1-554-596-21	SWITCH, KEY BOARD (20)			
S821	1-554-596-21	SWITCH, KEY BOARD (PLAY MODE C INDEX)			
S822	1-554-596-21	SWITCH, KEY BOARD (> 20)			
S823	1-554-596-21	SWITCH, KEY BOARD (EDIT TIME FADE)			
S824	1-554-596-21	SWITCH, KEY BOARD (ERASE)			
S825	1-554-596-21	SWITCH, KEY BOARD (CLEAR)			
S826	1-554-596-21	SWITCH, KEY BOARD (CHECK)			
S827	1-554-596-21	SWITCH, KEY BOARD (▶▶)			
S828	1-554-596-21	SWITCH, KEY BOARD (◀◀)			

Ref.No	Part No.	Description
S829	1-554-596-21	SWITCH, KEY BOARD (FILE RECALL)
S830	1-554-596-21	SWITCH, KEY BOARD (FADER)
S831	1-554-596-21	SWITCH, KEY BOARD (II)
S832	1-554-596-21	SWITCH, KEY BOARD (■)
S833	1-554-596-21	SWITCH, KEY BOARD (K<)
S834	1-554-596-21	SWITCH, KEY BOARD (▶▶)
S835	1-554-596-21	SWITCH, KEY BOARD (FILE)
S836	1-554-596-21	SWITCH, KEY BOARD (TIME/MODE)
S837	1-554-596-21	SWITCH, KEY BOARD (AUTO SPACE)
S838	1-554-596-21	SWITCH, KEY BOARD (REPEAT)
S839	1-554-596-21	SWITCH, KEY BOARD (△)
S840	1-554-596-21	SWITCH, KEY BOARD (△OPEN/CLOSE)
S841	1-554-596-21	SWITCH, KEY BOARD (CONTINUE/SINGLE)
S842	1-554-596-21	SWITCH, KEY BOARD (SHUFFLE)
S843	1-554-596-21	SWITCH, KEY BOARD (PROGRAM)
S844	1-554-596-21	SWITCH, KEY BOARD (DISPLAY)
S846	1-554-481-00	SWITCH, SLIDE (TIMER)
S990	△1-570-156-11	SWITCH, PUSH (AC POWER)(1 KEY)
SW845	1-554-419-00	SWITCH, PUSH (1 KEY) (DIGITAL OUTPUT)
T901	△1-449-631-11	(E)... TRANSFORMER, POWER
T901	△1-449-632-11	(US,CND)... TRANSFORMER, POWER
T901	△1-449-633-11	(AEP, UK)... TRANSFORMER, POWER
TH970	1-808-065-11	THERMISTOR, POSITIVE
TH971	1-808-065-11	THERMISTOR, POSITIVE
TH972	1-808-065-11	THERMISTOR, POSITIVE
TH973	1-808-065-11	THERMISTOR, POSITIVE
VS901	△1-526-576-51	(E)... SELECTOR, POWER VOLTAGE
X301	1-577-157-11	VIBRATOR, CERAMIC 8MHz
X350	1-567-926-11	VIBRATOR, CRYSTAL
X801	1-577-082-11	VIBRATOR, CERAMIC 4MHz

Part No. Description

ACCESSORY & PACKING MATERIALS

1-558-271-11	CORD, CONNECTION
3-786-738-11	(CND, AEP, UK, E)... MANUAL, INSTRUCTION (ENGLISH, FRENCH, SPANISH, PORTUGUESE)
3-786-738-21	(US)... MANUAL, INSTRUCTION (ENGLISH)
3-786-738-41	(AEP)... MANUAL, INSTRUCTION (GERMAN, DUTCH, SWEDISH, ITALIAN)
3-795-629-11	(AEP)... INSTRUCTION
4-847-802-00	(US, CND, AEP, E)... SCREW
4-923-548-01	CUSHION (UPPER)
4-923-549-01	CUSHION (LOWER)
*4-929-016-01	STOPPER, DISK TABLE
*4-929-069-01	INDIVIDUAL CARTON
4-925-305-01	(UK)... CUSHION, SIDE

Note:
The components identified by mark △ or dotted line with mark △ are critical for safety. Replace only with part number specified.

Note:
Les composants identifiés par une marque △ sont critiques pour la sécurité. Ne les remplacer que par une pièce portant le numéro spécifié.

Free Manuals Download Website

<http://myh66.com>

<http://usermanuals.us>

<http://www.somanuals.com>

<http://www.4manuals.cc>

<http://www.manual-lib.com>

<http://www.404manual.com>

<http://www.luxmanual.com>

<http://aubethermostatmanual.com>

Golf course search by state

<http://golfingnear.com>

Email search by domain

<http://emailbydomain.com>

Auto manuals search

<http://auto.somanuals.com>

TV manuals search

<http://tv.somanuals.com>