

# *FM/AM Compact Disc Player*

---

Operating Instructions \_\_\_\_\_

US

## Owner's Record

The model and serial numbers are located on the bottom of the unit.

Record these numbers in the space provided below.

Refer to these numbers whenever you call upon your Sony dealer regarding this product.

Model No. \_\_\_\_\_ Serial No. \_\_\_\_\_

For installation and connections, see the supplied installation/connections manual.



*CDX-4000X  
CDX-4005*

---

## Warning

This equipment has been tested and found to comply with the limits for a Class B digital device, pursuant to Part 15 of the FCC Rules. These limits are designed to provide reasonable protection against harmful interference in a residential installation. This equipment generates, uses, and can radiate radio frequency energy and, if not installed and used in accordance with the instructions, may cause harmful interference to radio communications. However, there is no guarantee that interference will not occur in a particular installation. If this equipment does cause harmful interference to radio or television reception, which can be determined by turning the equipment off and on, the user is encouraged to try to correct the interference by one or more of the following measures:

- Reorient or relocate the receiving antenna.
- Increase the separation between the equipment and receiver.
- Connect the equipment into an outlet on a circuit different from that to which the receiver is connected.
- Consult the dealer or an experienced radio/TV technician for help.

You are cautioned that any changes or modifications not expressly approved in this manual could void your authority to operate this equipment.

### CAUTION

The use of optical instruments with this product will increase eye hazard.

---

## Welcome !

Thank you for purchasing the Sony Compact Disc Player. This unit lets you enjoy a variety of features using the following controller accessory:

### Optional accessory

Rotary commander RM-X4S

---

## Precautions



CLASS 1  
LASER PRODUCT

This label is located on the bottom of the chassis (CDX-4005 only).

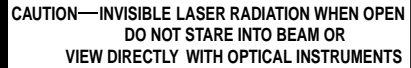

CAUTION—INVISIBLE LASER RADIATION WHEN OPEN  
DO NOT STARE INTO BEAM OR  
VIEW DIRECTLY WITH OPTICAL INSTRUMENTS

This label is located on the drive unit's internal chassis (CDX-4005 only).

- If your car was parked in direct sunlight resulting in a considerable rise in temperature inside the car, allow the unit to cool off before operating it.
- If no power is being supplied to the unit, check the connections first. If everything is in order, check the fuse.
- If your car is equipped with a power antenna, it will extend automatically while the unit is operating.

If you have any questions or problems concerning your unit that are not covered in this manual, please consult your nearest Sony dealer.

### Moisture Condensation

On a rainy day or in a very damp area, moisture may condense on the lenses inside the unit. Should this occur, the unit will not operate properly. In such a case, remove the disc and wait for about an hour until the moisture has evaporated.

### To maintain high quality sound

If you have drink holders near your audio equipment, be careful not to splash juice or other soft drinks onto the unit and CD. Sugary residues on the unit or CD may contaminate the lenses inside the unit, reduce the sound quality, or prevent sound reproduction altogether.

## Notes on CDs

A dirty or defective disc may cause sound dropouts while playing. To enjoy optimum sound, handle the disc as follows. Handle the disc by its edge. To keep the disc clean, do not touch the surface.



Do not stick paper or tape on the disc.

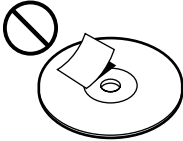

Do not expose the discs to direct sunlight or heat sources such as hot air-ducts, or leave them in a car parked in direct sunlight where there can be a considerable rise in temperature inside the car.

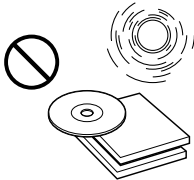

Before playing, clean the discs with an optional cleaning cloth. Wipe each disc from the center out.



Do not use solvents such as benzine, thinner, commercially available cleaners, or antistatic spray intended for analog discs.

## Notes on discs

If you use the discs explained below, the sticky residue can cause the CD to stop spinning and may cause malfunction or ruin your discs.

Do not use second-hand or rental CDs that have a sticky residue on the surface (for example, from peeled-off stickers or from ink, or glue leaking from under the stickers).

There are paste residue.  
Ink is sticky.



Do not use rental CDs with old labels that are beginning to peel off.

Stickers that are beginning to peel away, leaving a sticky residue.



Do not use your CDs with labels or stickers attached.

Labels are attached.

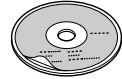

## Notes on CD-R discs

- You can play CD-Rs (recordable CDs) on this unit. However depending on the conditions of the recording equipment or the CD-R disc itself, some CD-Rs cannot be played on this unit.
- You cannot play a CD-R that is not finalized (Finalization is necessary for a recorded CD-R disc to be played on the audio CD player).
- You cannot play CD-RWs (rewritable CDs) on this player.

## When you play 8 cm (3 in.) CDs

Use the optional Sony compact disc single adaptor (CSA-8) to protect the CD player from damage.

---

# Table of Contents

Location of controls .....	5
<b>Getting Started</b>	
Resetting the unit .....	6
Detaching the front panel .....	6
Turning the unit on/off .....	7
How to use the menu .....	7
Setting the clock .....	7
<b>CD Player</b>	
Listening to a CD .....	8
Playing a CD in various modes .....	10
<b>Radio</b>	
Memorizing stations automatically	
— Best Tuning Memory (BTM) .....	10
Memorizing only the desired stations .....	11
Receiving the memorized stations .....	11
Storing the station names	
— Station Memo .....	12
<b>Other Functions</b>	
Labeling the rotary commander .....	13
Using the rotary commander .....	14
Adjusting the sound characteristics .....	15
Attenuating the sound .....	15
Changing the sound and display settings .....	16
Boosting the bass sound	
— D-bass .....	16
<b>Additional Information</b>	
Maintenance .....	17
Dismounting the unit .....	18
Specifications .....	19
Troubleshooting guide .....	20

# Location of controls

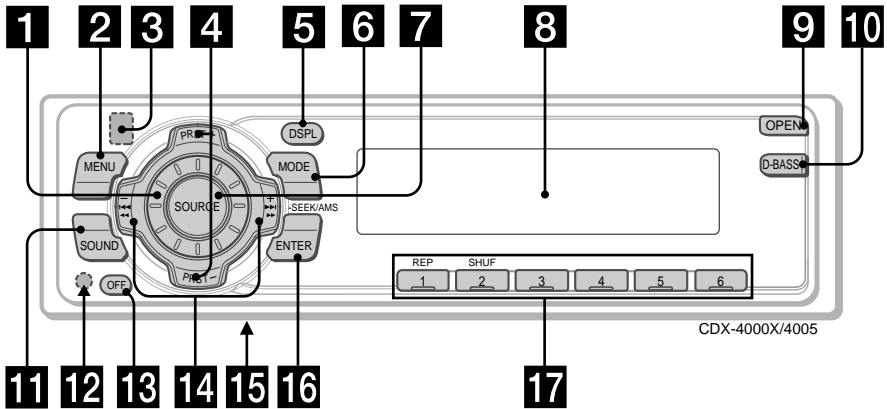

Refer to the pages listed for details.

- 1** Volume control dial
- 2** MENU button 7, 9, 10, 11, 12, 13, 16
- 3** ▲ (eject) button (located on the front side of the unit behind the front panel) 8
- 4** DISC/PRST +/- (cursor up/down) buttons 7, 9, 10, 11, 12, 13, 16
  - During radio reception: Preset stations select 11
- 5** DSPL (display mode change) button 8, 9, 13
- 6** MODE button
  - During radio reception: BAND select 10
- 7** SOURCE (TUNER/CD) button 7, 8, 9, 10, 11
- 8** Display window
- 9** OPEN button 6, 8, 17
- 10** D-BASS button 16
- 11** SOUND button 15
- 12** Reset button (located on the front side of the unit behind the front panel) 6
- 13** OFF button\*1 6, 7, 8
- 14** SEEK/AMS +/- (cursor left/right) buttons 7, 9, 11, 12, 15, 16
  - Automatic Music Sensor 9
  - Manual Search 9
  - Seek 11
- 15** Frequency select switch (located on the bottom of the unit)\*2
  - The AM (FM) tuning interval is factory-set to the 10 k (200 k) position. Make sure that the 9 k (50 k) position is selected.
- 16** ENTER button 7, 9, 10, 11, 12, 13, 16
- 17** Number buttons
  - During radio reception: Preset number select 11
  - During CD playback:
    - ① REP 10
    - ② SHUF 10

\*1 **Warning when installing in a car without ACC (accessory) position on the ignition key switch**  
Be sure to press **OFF** on the unit for two seconds to turn off the clock display after turning off the engine.  
When you press **OFF** momentarily, the clock display does not turn off and this causes battery wear.

\*2 CDX-4005 only

# Getting Started

## Resetting the unit

Before operating the unit for the first time or after replacing the car battery, you must reset the unit.

Remove the front panel and press the reset button with a pointed object, such as a ball-point pen.

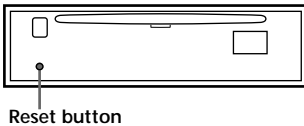

### Note

Pressing the reset button will erase the clock setting and some memorized functions such as the station memo.

## Detaching the front panel

You can detach the front panel of this unit to protect the unit from being stolen.

- 1 Press **OFF**.
- 2 Press **OPEN**, then slide the front panel to the right side, and pull out the left side of the front panel.

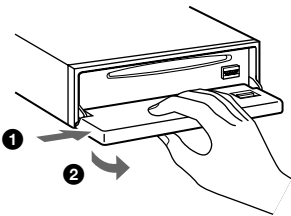

### Notes

- Do not put anything on the inner surface of the front panel.
- Be sure not to drop the panel when detaching it from the unit.
- If you detach the panel while the unit is still turned on, the power will turn off automatically to prevent the speakers from being damaged.
- When carrying the front panel with you, use the supplied front panel case.

## Attaching the front panel

Place the hole **A** in the front panel onto the spindle **B** on the unit as illustrated, then push the left side in.

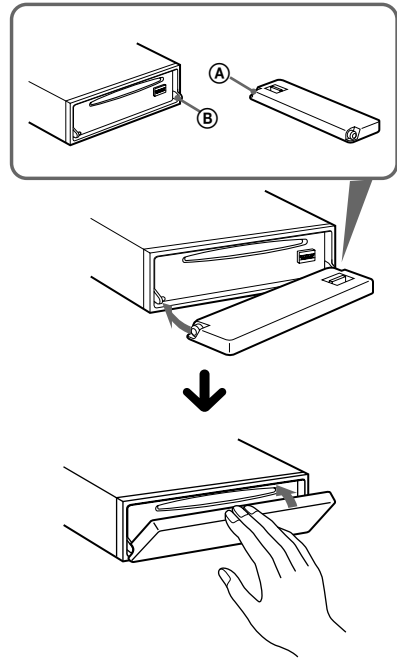

### Notes

- Be careful not to attach the front panel upside down.
- Do not press the front panel too hard against the unit when attaching it.
- Do not press too hard or put excessive pressure on the display window of the front panel.
- Do not expose the front panel to direct sunlight or heat sources such as hot air ducts, and do not leave it in a humid place. Never leave it on the dashboard of a car parked in direct sunlight or where there may be a considerable rise in temperature.

## Caution alarm

If you turn the ignition key switch to the OFF position without removing the front panel, the caution alarm will beep for a few seconds. If you connect an optional power amplifier and do not use the built-in amplifier, the beep sound will be deactivated.

## Turning the unit on/off

### Turning on the unit

Press **(SOURCE)** or insert a CD in the unit. For details on operation, refer to page 8 (CD player) and page 10 (radio).

### Turning off the unit

Press **(OFF)** to stop CD/MD playback or FM/AM reception (the key illumination and display remain on).

Press **(OFF)** for two seconds to completely turn the unit off.

#### Note

If your car has no ACC position on the ignition key switch, be sure to turn the unit off by pressing **(OFF)** for two seconds to avoid car battery wear.

## How to use the menu

This unit is operated by selecting items from a menu.

To select, first enter the menu mode and choose up/down ((+)/(-) of **(PRST)**), or choose left/right ((-)/(+) of **(SEEK/AMS)**).

**(PRST)**

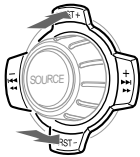

(+): to select upwards

(-): to select downwards

**(SEEK/AMS)**



(-): to select leftwards

(+): to select rightwards

## Setting the clock

The clock uses a 12-hour digital indication.

Example: To set the clock to 10:08

- 1 Press **(MENU)**, then press either side of **(PRST)** repeatedly until "CLOCK" appears.

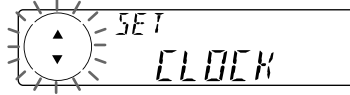

- 1 Press **(ENTER)**.



The hour indication flashes.

- 2 Press either side of **(PRST)** to set the hour.



- 3 Press (+) side of **(SEEK/AMS)**.

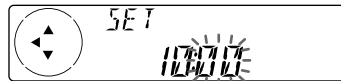

The minute indication flashes.

- 4 Press either side of **(PRST)** to set the minute.



- 2 Press **(ENTER)**.

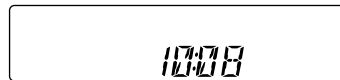

The clock starts.

After the clock setting is completed, the display returns to normal play mode.

#### Note

In the initial setting, the clock indication appears while the unit is turned off.

When the D.INFO mode is set to ON, the time is always displayed (page 16).

# CD Player

## Listening to a CD

1 Press **OPEN** and insert the CD.

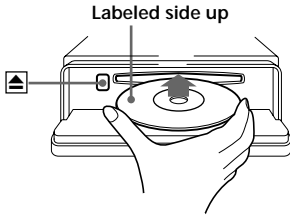

2 Close the front panel.  
Playback starts automatically.

If a CD is already inserted, press **SOURCE** repeatedly until "CD" appears to start playback.

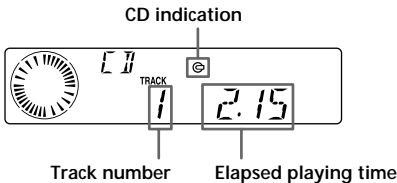

### When the last track on the CD is over

The track number indication returns to "1," and playback restarts from the first track of the CD.

To	Press
Stop playback	<b>OFF</b>
Eject the CD	<b>OPEN</b> then ▲

### Changing the display item

Each time you press **DSPL** during CD TEXT disc playback, the item changes as follows:

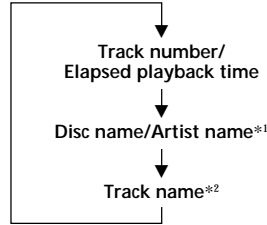

\*1 If you play a CD TEXT disc, the artist name appears in the display after the disc name. (Only for CD TEXT discs with the artist name.)

\*2 If the track name of a CD TEXT disc is not prerecorded, "TRACK" and "NO NAME" appear in the display.

After you select the desired item, the display will automatically change to the Motion Display mode after a few seconds. In the Motion Display mode, all the items are scrolled in the display one by one in order.

#### Tip

The Motion Display mode can be turned off. (See "Changing the sound and display settings" on page 16.)



## Automatically scrolling a disc name

### — Auto Scroll

If the disc name, artist name, or track name on a CD TEXT disc exceeds eight characters and the Auto Scroll function is on, information automatically scrolls across the display as follows:

- The disc name appears when the disc has changed (if the disc name is selected as the display item).
- The track name appears when the track has changed (if the track name is selected as the display item).
- The disc or track name appears depending on the setting when you press (SOURCE) to select CD TEXT disc.

If you press (DSPL) to change the display item, the disc or track name of the CD TEXT disc is scrolled automatically whether you set the function on or off.

- 1 During playback, press (MENU).
- 2 Press either side of (PRST) repeatedly until "A.SCRL-OFF" appears.
- 3 Press the (+) side of (SEEK/AMS) to select "A.SCRL-ON."
- 4 Press (ENTER).

To cancel Auto Scroll, select "A.SCRL-OFF" in step 3.

#### Note

For some CD TEXT discs with very many characters, the following cases may happen:

- Some of the characters are not displayed.
- Auto Scroll does not work.

## Locating a specific track

### — Automatic Music Sensor (AMS)

During playback, press either side of (SEEK/AMS) momentarily for each track you want to skip.

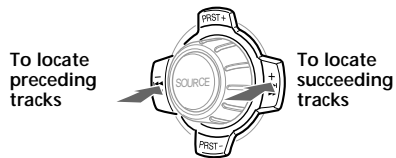

## Locating a specific point in a track

### — Manual Search

During playback, press and hold either side of (SEEK/AMS). Release when you have found the desired point.

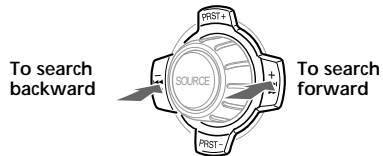

#### Note

If "....." or "....." appears in the display, you have reached the beginning or the end of the disc and you cannot go any further.

# Playing a CD in various modes

You can play CDs in various modes:

- REP (Repeat Play) repeats the current track.
- SHUF (Shuffle Play) plays all the tracks in random order.

## Playing tracks repeatedly

### — Repeat Play

During playback, press **1** (REP).

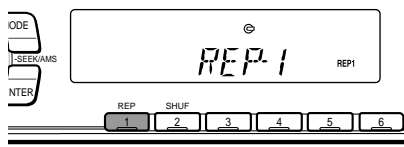

Repeat Play starts.

To return to normal play mode, select "REP-OFF."

## Playing tracks in random order

### — Shuffle Play

During playback, press **2** (SHUF).

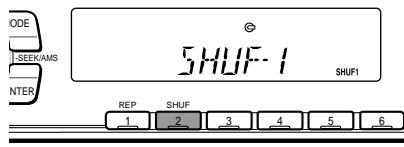

Shuffle Play starts.

To return to normal play mode, select "SHUF-OFF."

# Radio

## Memorizing stations automatically

### — Best Tuning Memory (BTM)

The unit selects the stations with the strongest signals and memorizes them in the order of their frequencies. You can store up to 6 stations on each band (FM1, FM2, FM3, AM1, and AM2).

### Caution

When tuning in stations while driving, use Best Tuning Memory to prevent accidents.

### 1 Press **SOURCE** repeatedly to select the tuner.

Each time you press **SOURCE**, the source changes as follows:

Tuner ↔ CD

### 2 Press **MODE** repeatedly to select the band.

Each time you press **MODE**, the band changes as follows:



### 3 Press **MENU**, then press either side of **PRST** repeatedly until "BTM" appears.

### 4 Press **ENTER**.

The unit stores stations in the order of their frequencies on the number buttons. A beep sounds when the setting is stored.

### Notes

- The unit does not store stations with weak signals. If only a few stations can be received, some number buttons will retain their former setting.
- When a number is indicated in the display, the unit starts storing stations from the one currently displayed.
- If a CD is not in the unit, only the tuner band appears even if you press **SOURCE**.

## Memorizing only the desired stations

You can preset up to 18 FM stations (6 each for FM1, FM2, and FM3), up to 12 AM stations (6 each for AM1 and AM2) in the order of your choice.

- 1 Press **(SOURCE)** repeatedly to select the tuner.
- 2 Press **(MODE)** repeatedly to select the band.
- 3 Press either side of **(SEEK/AMS)** to tune in the station that you want to store on the number button.
- 4 Press the desired number button (**(1)** to **(6)**) for two seconds until "MEM" appears.  
The number button indication appears in the display.

### Note

If you try to store another station on the same number button, the previously stored station will be erased.

## Receiving the memorized stations

- 1 Press **(SOURCE)** repeatedly to select the tuner.
- 2 Press **(MODE)** repeatedly to select the band.
- 3 Press the number button (**(1)** to **(6)**) on which the desired station is stored.

### Tip

Press either side of **(PRST)** to receive the stations in the order they are stored in the memory (Preset Search Function).

## If you cannot tune in a preset station

Press either side of **(SEEK/AMS)** to search for the station (automatic tuning). Scanning stops when the unit receives a station. Press either side of **(SEEK/AMS)** repeatedly until the desired station is received.

### Note

If the automatic tuning stops too frequently, press **(MENU)**, then press either side of **(PRST)** repeatedly until "LOCAL" (local seek mode) is displayed. Then press the (+) side of **(SEEK/AMS)** to select "LOCAL-ON." Press **(ENTER)**. Only the stations with relatively strong signals will be tuned in.

### Tips

- When you select the "LOCAL-ON" setting, "L.SEEK" appears while the unit is searching for a station.
- If you know the frequency of the station you want to listen to, press and hold either side of **(SEEK/AMS)** until the desired frequency appears (manual tuning).

## If FM stereo reception is poor

— Monaural Mode

- 1 During radio reception, press **(MENU)**, then press either side of **(PRST)** repeatedly until “MONO-OFF” appears.
- 2 Press the (+) side of **(SEEK/AMS)** until “MONO-ON” appears.  
The sound improves, but becomes monaural (“ST” disappears).
- 3 Press **(ENTER)**.

To return to normal mode, select “MONO-OFF” in step 2.

## Automatic reception frequency adjustment

— IF AUTO function

If interference occurs, the “IF AUTO” function of this unit will automatically avoid noise and narrow the reception frequency. In such cases, some FM stereo broadcasts may become monaural. If you would like to hear such broadcasts in stereo, manually switch to the “WIDE” setting.

- 1 During radio reception, press **(MENU)**, then press either side of **(PRST)** repeatedly until “IF AUTO” appears.
- 2 Press the (+) side of **(SEEK/AMS)** until “WIDE” appears.
- 3 Press **(ENTER)**.

### Note

When you widen the frequency signal reception setting (“WIDE” mode), some interference may occur.

## Storing the station names

— Station Memo

You can assign a name to each radio station and store it in memory. The name of the station currently tuned in appears in the display. You can assign a name of up to eight characters for a station.

### Storing the station names

- 1 Tune in a station whose name you want to store.
- 2 Press **(MENU)**, then press either side of **(PRST)** repeatedly until “NAME EDIT” appears.
- 3 Press **(ENTER)**.

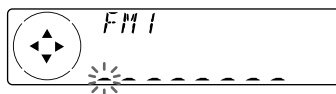

- 4 Enter the characters.

- 1 Press the (+) side of **(PRST)** repeatedly to select the desired characters.  
(A → B → C → ... Z → 0 → 1 → 2 → ... 9 → + → - → \* → / → \ → > → < → . → \_)



If you press the (-) side of **(PRST)** repeatedly, the characters appear in the reverse order.

If you want to put a blank space between characters, select “\_” (underbar).

- 2 Press the (+) side of **(SEEK/AMS)** after locating the desired character.  
The next character flashes.



If you press the (-) side of **(SEEK/AMS)**, the previous character flashes.

- 3 Repeat steps 1 and 2 to enter the entire name.

- 5 To return to the normal radio reception, press **(ENTER)**.

**Tip**

To erase or correct a name, enter “\_” (under-bar) for each character.

### Displaying the station name

Press **(DSPL)** during radio reception.

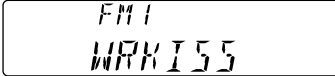

Each time you press **(DSPL)**, the item changes as follows:

Station name\* ↔ Frequency

\* If the station name of a station is not stored, “NO NAME” appears in the display for one second.

### Erasing the station name

- 1 Tune in a station whose name you want to erase.
- 2 Press **(MENU)**, then press either side of **(PRST)** repeatedly until “NAME DEL” appears.
- 3 Press **(ENTER)**.
- 4 Press **(ENTER)** for two seconds. The name is erased. Repeat steps 1 through 4 if you want to erase other names.
- 5 Press **(MENU)** twice. The unit returns to the normal radio reception mode.

**Note**

When you erase all of the station names, “NO NAME” appears in step 4.

## Other Functions

You can also control the unit with a rotary commander.

### Labeling the rotary commander

Depending on how you mount the rotary commander, attach the appropriate label as shown in the illustration below.

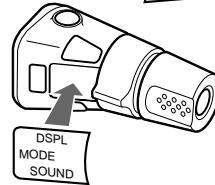
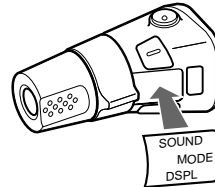

## Using the rotary commander

The rotary commander works by pressing buttons and/or rotating controls.

### By pressing buttons (the SOURCE and MODE buttons)

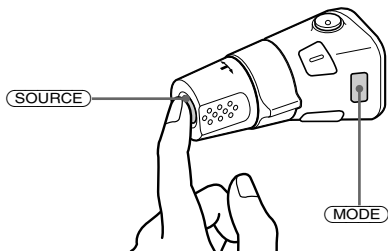

Each time you press **(SOURCE)**, the source changes as follows:

Tuner → CD

Pressing **(MODE)** changes the operation in the following ways:

Tuner: FM1 → FM2 → FM3 → AM1 → AM2

### By rotating the control (the SEEK/AMS control)

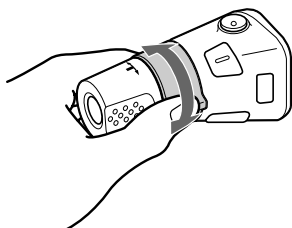

Rotate the control momentarily and release it to:

- Locate a specific track on a disc. Rotate and hold the control until you locate the specific point in a track, then release it to start playback.
- Tune in stations automatically. Rotate and hold the control to find a specific station.

### By pushing in and rotating the control (the PRESET/DISC control)

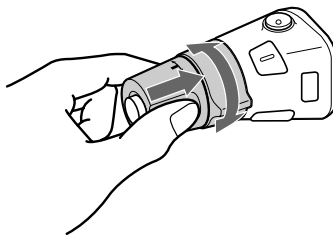

Push in and rotate the control to:

- Receive the stations memorized on the number buttons.

### Other operations

Rotate the VOL control to adjust the volume.

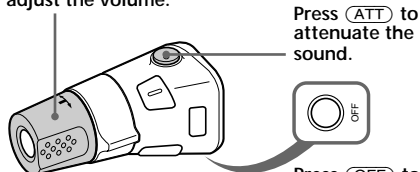

Press **(ATT)** to attenuate the sound.

Press **(OFF)** to turn off the unit.

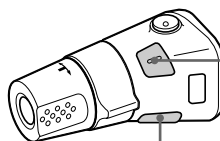

Press **(SOUND)** to adjust the volume and sound menu.

Press **(DSPL)** to display the memorized names.

#### Tip

If your car has no ACC (accessory) position on the ignition key switch, be sure to press **(OFF)** for two seconds to turn off the clock indication after turning off the engine.

## Changing the operative direction

The operative direction of controls is factory-set as shown below.

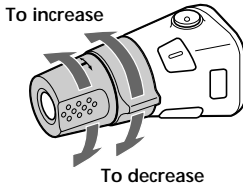

If you need to mount the rotary commander on the right hand side of the steering column, you can reverse the operative direction.

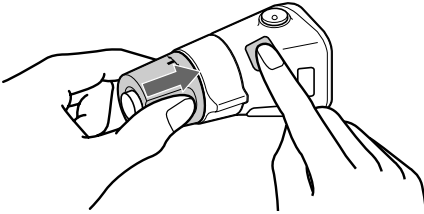

Press **(SOUND)** for two seconds while pushing the VOL control.

### Tip

You can also change the operative direction of these controls with the unit (see "Changing the sound and display settings" on page 16).

---

## Adjusting the sound characteristics

You can adjust the bass, treble, balance, and fader.

You can store the bass and treble levels independently for each source.

- 1 Select the item you want to adjust by pressing **(SOUND)** repeatedly. Each time you press **(SOUND)**, the item changes as follows:  
BAS (bass) → TRE (treble) → BAL (left-right) → FAD (front-rear)
- 2 Adjust the selected item by pressing either side of **(SEEK/AMS)**. When adjusting with the rotary commander, press **(SOUND)** and rotate the VOL control.

### Note

Adjust within three seconds after selecting the item.

---

## Attenuating the sound

Press **(ATT)** on the rotary commander. "ATT-ON" flashes momentarily.

To restore the previous volume level, press **(ATT)** again.

### Tip

When the interface cable of a car telephone is connected to the ATT lead, the unit decreases the volume automatically when a telephone call comes in (Telephone ATT function).

## Changing the sound and display settings

The following items can be set:

### SET (setting)

- CLOCK (page 8)
- BEEP — to turn the beeps on or off.
- RM (Rotary Commander) — to change the operative direction of the controls of the rotary commander.
  - Select “NORM” to use the rotary commander as the factory-set position.
  - Select “REV” when you mount the rotary commander on the right side of the steering column.

### DIS (display)

- D.INFO (Dual Information) — to display the clock and the play mode at the same time (ON).
- M.DSPL (Motion Display) — to turn the motion display on or off.
- A.SCRL (Auto Scroll) (page 10)

#### Note

If you connect an optional power amplifier and do not use the built-in amplifier, the beep sound will be disabled.

1 Press **(MENU)**.

2 Press either side of **(PRST)** repeatedly until the desired item appears.

Each time you press the (–) side of **(PRST)**, the item changes as follows:

CLOCK → BEEP → RM → D.INFO → M.DSPL  
→ A.SCRL

#### Note

The displayed item will differ depending on the source.

#### Tip

You can easily switch among categories (“SET”, “DIS”, “P/M” (play mode), and “EDT” (edit mode)) by pressing either side of **(PRST)** for two seconds.

3 Press the (+) side of **(SEEK/AMS)** to select the desired setting (Example: ON or OFF).

4 Press **(ENTER)**.

After the mode setting is complete, the display returns to normal play mode.

## Boosting the bass sound

— D-bass

You can enjoy a clear and powerful bass sound.

The D-bass function boosts the low and high frequency signal with a sharper curve than conventional bass boost.

You can hear the bass line more clearly even while the vocal volume remains the same. You can emphasize and adjust the bass sound easily with the D-BASS control.

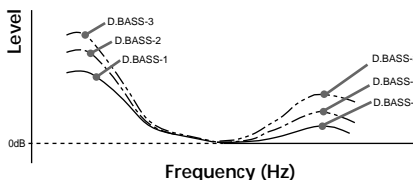

### Adjusting the bass curve

Press **(D-BASS)** repeatedly until the desired bass level (1, 2, or 3) appears in the display.

To cancel, select “D.BASS-OFF.”

#### Note

If the bass sound becomes distorted, select a less effective setting of “D.BASS” or adjust the volume.



# Additional Information

## Maintenance

### Fuse replacement

When replacing the fuse, be sure to use one matching the amperage rating stated on the original fuse. If the fuse blows, check the power connection and replace the fuse. If the fuse blows again after replacement, there may be an internal malfunction. In such a case, consult your nearest Sony dealer.

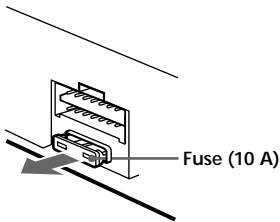

### Warning

Never use a fuse with an amperage rating exceeding the one supplied with the unit as this could damage the unit.

### Cleaning the connectors

The unit may not function properly if the connectors between the unit and the front panel are not clean. In order to prevent this, open the front panel by pressing (OPEN), then detach it and clean the connectors with a cotton swab dipped in alcohol. Do not apply too much force. Otherwise, the connectors may be damaged.

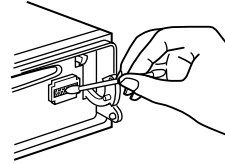

Main unit

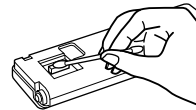

Back of the front panel

### Notes

- For safety, turn off the engine before cleaning the connectors, and remove the key from the ignition switch.
- Never touch the connectors directly with your fingers or any metal device.

# Dismounting the unit

- 1 Press the clip inside the front cover with a thin screwdriver, and gently pry the front cover free.

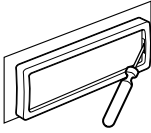

- 2 Repeat step 1 on the left side.  
The front cover is removed.

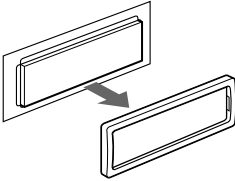

- 3 Use a thin screwdriver to push in the clip on the left side of the unit, then pull out the left side of the unit until the catch clears the mounting.

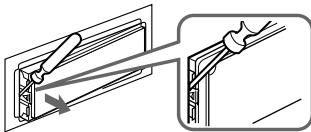

- 4 Repeat step 3 on the right side.

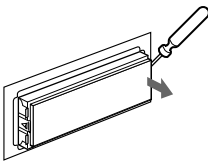

- 5 Slide the unit out of the mounting.

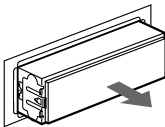

# Specifications

## AUDIO POWER SPECIFICATIONS

### POWER OUTPUT AND TOTAL HARMONIC DISTORTION

19 watts per channel minimum continuous average power into 4 ohms, 4 channels driven from 20 Hz to 20 kHz with no more than 1% total harmonic distortion.

### Other specifications

CD player section		Power amplifier section	
System	Compact disc digital audio system	Outputs	Speaker outputs (sure seal connectors)
Signal-to-noise ratio	90 dB	Speaker impedance	4 – 8 ohms
Frequency response	10 – 20,000 Hz	Maximum power output	50 W × 4 (at 4 ohms)
Wow and flutter	Below measurable limit		
Laser Diode Properties			
Material	GaAlAs		
Wavelength	780 nm		
Emission Duration	Continuous		
Laser output power	Less than 44.6 μW*		
* This output is the value measured at a distance of 200 mm from the objective lens surface on the Optical Pick-up Block.			
Tuner section		General	
FM		Outputs	Audio outputs Power antenna relay control lead Power amplifier control lead Telephone ATT control lead
Tuning range	CDX-4000X 87.5 – 107.9 MHz CDX-4005 FM tuning interval: 50 kHz/200 kHz switchable 87.5 – 108 MHz (at 50 kHz step) 87.5 – 107.9 MHz (at 200 kHz step)	Tone controls	Bass ±9 dB at 100 Hz Treble ±9 dB at 10 kHz
Antenna terminal	External antenna connector	Power requirements	12 V DC car battery (negative ground)
Intermediate frequency	10.7 MHz/450 kHz	Dimensions	Approx. 178 × 50 × 183 mm (7 <sup>1</sup> / <sub>8</sub> × 2 × 7 <sup>1</sup> / <sub>4</sub> in.) (w/h/d)
Usable sensitivity	8 dBf	Mounting dimensions	Approx. 182 × 53 × 162 mm (7 <sup>1</sup> / <sub>4</sub> × 2 <sup>1</sup> / <sub>8</sub> × 6 <sup>1</sup> / <sub>2</sub> in.) (w/h/d)
Selectivity	75 dB at 400 kHz	Mass	Approx. 1.2 kg (2 lb. 10 oz.)
Signal-to-noise ratio	66 dB (stereo), 72 dB (mono)	Supplied accessories	Parts for installation and connections (1 set) Front panel case (1) Rotary commander RM-X4S
Harmonic distortion at 1 kHz	0.6 % (stereo), 0.3 % (mono)	Optional accessories	
Separation	35 dB at 1 kHz		
Frequency response	30 – 15,000 Hz		
AM			
Tuning range	CDX-4000X 530 – 1,710 kHz CDX-4005 AM tuning interval: 9 kHz/10 kHz switchable 531 – 1,602 kHz (at 9 kHz step) 530 – 1,710 kHz (at 10 kHz step)		
Antenna terminal	External antenna connector		
Intermediate frequency	10.7 MHz/450 kHz		
Sensitivity	30 μV		

*Design and specifications are subject to change without notice.*

# Troubleshooting guide

The following checklist will help you remedy the problems you may encounter with your unit. Before going through the checklist below, check the connection and operating procedures.

## General

Problem	Cause/Solution
No sound.	<ul style="list-style-type: none"><li>• Cancel the ATT function.</li><li>• Set the fader control to the center position for two-speaker system.</li><li>• Rotate the dial clockwise to adjust the volume.</li></ul>
The contents of the memory have been erased.	<ul style="list-style-type: none"><li>• The power cord or battery has been disconnected.</li><li>• The reset button has been pressed. → Store again into the memory.</li></ul>
Indications do not appear in the display.	Remove the front panel and clean the connectors. See "Cleaning the connectors" (page 17) for details.
No beep sound.	<ul style="list-style-type: none"><li>• The beep sound is cancelled (page 16).</li><li>• If you connect an optional amplifier and do not use the built-in amplifier, the beep sound will be deactivated.</li></ul>

## CD playback

Problem	Cause/Solution
A disc cannot be loaded.	<ul style="list-style-type: none"><li>• Another CD is already loaded.</li><li>• The CD is forcibly inserted upside down or in the wrong way.</li></ul>
Playback does not begin.	Defective dirty CD.
A disc is automatically ejected.	The ambient temperature exceeds 50°C (122°F).
CD will not be ejected.	You have closed the front panel or pushed the disc forcibly into the unit while the unit was ejecting the disc after you pressed ▲. → Press the reset button.
The operation buttons do not function.	Press the reset button.
The sound skips due to vibration.	<ul style="list-style-type: none"><li>• The unit is installed at an angle of more than 60°.</li><li>• The unit is not installed in a sturdy part of the car.</li></ul>
The sound skips.	A dirty or defective disc.

## Radio reception

Problem	Cause/Solution
Preset tuning is not possible.	<ul style="list-style-type: none"><li>• Memorise the correct frequency.</li><li>• The broadcast signal is too weak.</li><li>• When your car has built-in FM/AM antenna in the rear/side glass, it is necessary to connect the power antenna control lead (blue) or the accessory power input lead (red) to the power terminal of the existing antenna booster. For details, consult your dealer.</li></ul>
Automatic tuning is not possible.	The broadcast signal is too weak. → Use manual tuning.
The "ST" indication flashes.	<ul style="list-style-type: none"><li>• Tune in the frequency accurately.</li><li>• The broadcast signal is too weak. → Set to the MONO mode (page 12).</li></ul>

If the above-mentioned solutions do not help improve the situation, consult your nearest Sony dealer.





---

Sony  line <http://www.world.sony.com/>

---

Sony Corporation Printed in Korea

Download from [Www.Somanuals.com](http://www.Somanuals.com). All Manuals Search And Download.



## Free Manuals Download Website

<http://myh66.com>

<http://usermanuals.us>

<http://www.somanuals.com>

<http://www.4manuals.cc>

<http://www.manual-lib.com>

<http://www.404manual.com>

<http://www.luxmanual.com>

<http://aubethermostatmanual.com>

Golf course search by state

<http://golfingnear.com>

Email search by domain

<http://emailbydomain.com>

Auto manuals search

<http://auto.somanuals.com>

TV manuals search

<http://tv.somanuals.com>