

Television

Operating Instructions

Introducing Your New
BRAVIA®

Getting Started

Operating the TV

Using Features

Using the Menus

Other Information

Sony Customer Support

U.S.A.: <http://www.sony.com/tvsupport>

Canada: <http://www.sony.ca/support>

United States

Canada

1.800.222.SONY

1.877.899.SONY

Please Do Not Return
the Product to the Store

BRAVIA

Owner's Record

The model and serial numbers are located at the side and rear of the TV. Record these numbers in the spaces provided below. Refer to them whenever you call upon your Sony dealer regarding this TV.

Model Name

Serial No.

CAUTION

To prevent electric shock and blade exposure, do not use this polarized AC plug with an extension cord, receptacle or other outlet unless the blades can be fully inserted.

- Operate the TV only on 110-240 V AC (USA/Canada 120 V AC).
- Avoid operating the TV at temperatures below 41°F (5°C).

Licensing Information

MHL, Mobile High-Definition Link and the MHL Logo are trademarks or registered trademarks of MHL Licensing, LLC.

The terms HDMI and HDMI High-Definition Multimedia Interface, and the HDMI Logo are trademarks or registered trademarks of HDMI Licensing LLC in the United States and other countries.

Ferguson Patent Properties, LLC:

U.S. Patent No. 5,717,422

U.S. Patent No. 6,816,141

Manufactured under license from Dolby Laboratories. Dolby and the double-D symbol are trademarks of Dolby Laboratories.

Blu-ray Disc is a trademark.

"BRAVIA" and BRAVIA, BRAVIA Sync, and  are trademarks or registered marks of Sony Corporation.

"PlayStation" is a registered trademark and "PS3" is a trademark of Sony Computer Entertainment Inc.

Opera® Devices SDK from Opera Software ASA.

Copyright 1995-2014 Opera Software ASA.

All rights reserved.

DLNA®, the DLNA Logo and DLNA CERTIFIED® are trademarks, service marks, or certification marks of the Digital Living Network Alliance.

Wi-Fi is a registered trademark of Wi-Fi Alliance.

Cleaning

When cleaning, be sure to unplug the power cord to avoid any chance of electric shock.

- Wipe the LCD screen gently with a soft cloth.
- Stubborn stains may be removed with a cloth slightly moistened with a solution of mild soap and warm water.

- If using a chemically pretreated cloth, please follow the instruction provided on the package.
- Never use strong solvents such as a thinner, alcohol or benzene for cleaning.
- See the supplied Safety Booklet for additional information.

Your BRAVIA TV is ENERGY STAR® qualified in the default mode. It meets strict energy efficiency guidelines set by the U.S. Environmental Protection Agency and Department of Energy.



ENERGY STAR is a joint program of these government agencies, designed to promote energy efficient products and practices. Changes to certain features, settings, and functionalities (when available) of this TV (i.e. Picture/Sound, Power Savings, Picture Scene/Mode, Auto Display, Shop Front Display Settings) can increase or change the power consumption.

The "Auto" and "General" picture scenes are default settings optimized for the input signal selected. Your BRAVIA TV is tested in these settings for ENERGY STAR qualification. Depending upon such changed settings, the power consumption may exceed the limits required for the ENERGY STAR qualification in the default mode.

Wi-Fi Protected Setup™ (WPS) is a mark of the Wi-Fi Alliance.

Wi-Fi Protected Access™ (WPA) is a mark of the Wi-Fi Alliance.



Location of the identification label

Labels for the TV Model No. and Power Supply rating are located on the rear of the TV.

Contents

Introducing Your New BRAVIA®

Welcome to the World of BRAVIA®	4
Experiencing Stunning HD with Your BRAVIA	4
The Four Steps to a Stunning HD Experience	4

Getting Started

Setting Up Your TV	5
Attaching the Table-Top Stand	6
Locating Inputs and Outputs	8
Connecting the TV	10
Connecting Other Equipment	12
When Installing the TV Against a Wall or Enclosed Area	13
Securing the TV	14
Running Initial Setup	17

Operating the TV

Using the Remote Control	18
Remote Control Button Description	19
TV Controls and Indicators	22

Using Features

Using PIP Feature	23
Using PAP Feature	23
Favorites	24
Wide Mode	24
Playing back Photo/Music/Video via USB	25
Home Network	27
Photo Frame	28
Using Home Network Features	29
Setting up the Internet Connection	29

If You Cannot Connect to the Internet	32
Adjusting the Server Display Settings	32
Browsing Websites	33
Enjoying Sony Entertainment Network	33
Enjoying Applications	34

Using the Menus

Navigating through TV Menus	35
---------------------------------------	----

Other Information

PC Input Signal Reference Chart for HDMI/MHL IN	50
Using a Wall-Mount Bracket	51
Troubleshooting	52
Important Notices	59
Specifications	60
Index	62



Customer Support
United States
<http://www.sony.com/tvsupport>
Canada
<http://www.sony.ca/support>

On-line Registration
United States
<http://productregistration.sony.com>
Canada
<http://www.sony.ca/registration>

Welcome to the World of BRAVIA®

Thank you for choosing this Sony BRAVIA® high-definition television. Use the documentation listed below to get the most out of your TV.



Safety Booklet

Contains precautionary measures to keep you and your TV safe. Read this information prior to setting up your TV.



Quick Setup Guide

Provides TV setup information with sample connection diagrams.



Operating Instructions

Provides the most detailed information to operate your TV.

Experiencing Stunning HD with Your BRAVIA

To experience the stunning detail of your new **BRAVIA** TV, you need access to HD programming. Your **BRAVIA** TV can receive and display HD programming from:

- Over-the-air broadcasting via HD-quality antenna
- HD cable subscription
- HD satellite subscription
- Blu-ray Disc™ player or other HD compatible external equipment

Contact your cable, satellite or HD service provider for information on upgrading to HD programming.

The Four Steps to a Stunning HD Experience

Along with your **BRAVIA TV set**, a complete HD system requires a **source** of HD programming, an HD **sound** system, and a proper connection **setup**. Refer to the Quick Setup Guide, enclosed separately, for connecting optional equipment.

Setting Up Your TV

Some TV models are packaged with a detached Table-Top Stand so you can mount your TV to a wall right away. If you are not mounting the TV to a wall, you will need to attach the Table-Top Stand. You will need a Phillips screwdriver (not supplied) and the supplied screws to complete the task. Look for the supplied Table-Top Stand instruction leaflet.

Be sure to consider the following while setting up your TV:

- Disconnect all cables when carrying the TV.
- Carry the TV with the adequate number of people; larger size TVs require two or more people.
- Correct hand placement while carrying the TV is very important for safety and to avoid damage.
- Do not put stress on the LCD panel or the frame around the screen.

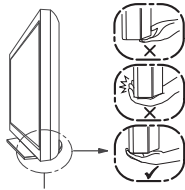

Be sure to hold the bottom of the panel, not the front part.

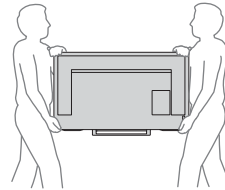

- Ensure your TV has adequate ventilation, see page 13.
- For best picture quality, do not expose the screen to direct illumination or sunlight.
- Avoid installing the TV in a room with reflective wall and floor materials.
- Avoid moving the TV from a cold area to a warm area. Sudden room temperature changes may cause moisture condensation. This may cause the TV to show poor picture and/or poor color. Should this occur, allow moisture to evaporate completely before powering the TV on.

Attaching the Table-Top Stand

Refer to the supplied Table-Top Stand instruction leaflet for proper attachment.



- Be careful to not pinch your hands or the AC power cord when you install the TV set to the Table-Top Stand.

1 Place the TV set on the Table-Top Stand.

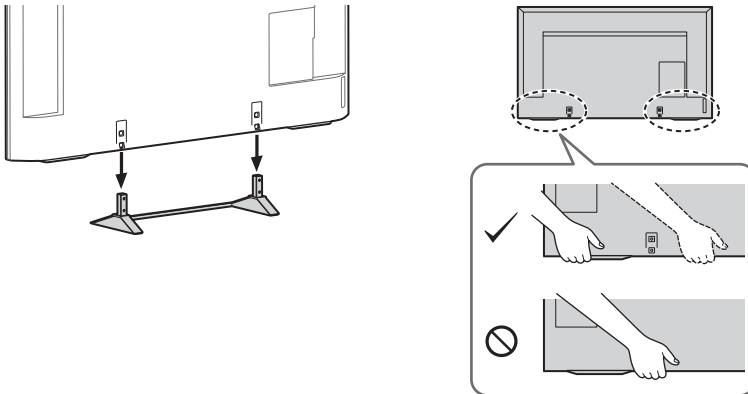

2 Fix the TV to the Table-Top Stand using the supplied screws. The arrow marks  indicate the location of the screw holes used for securing the Table-Top Stand.

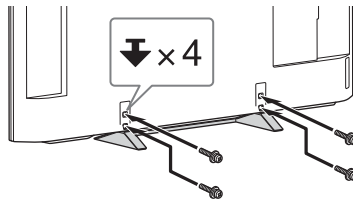

- Hold the TV with one hand to avoid it dropping when attaching.

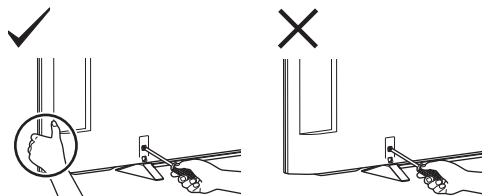

- Align the TV from the top, slide it in until the guide pins cannot be seen.
- If using an electric screwdriver, set the torque at approximately 1.5 N·m {15 kgf·cm}.
- When detaching the Table-Top Stand, reverse the attaching procedure. Do not remove any screws other than those used when attaching the Table-Top Stand.

6

- Be sure the TV is on the vertical position before switching on.
- TV set must not powered on with LCD panel face down to avoid uneven picture uniformity.

Locating Inputs and Outputs

Rear Panel

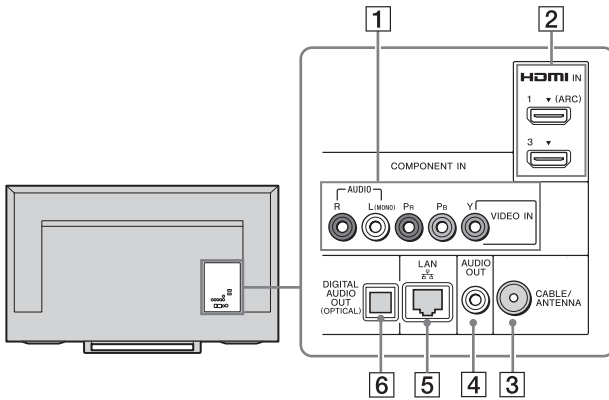

Side Panel

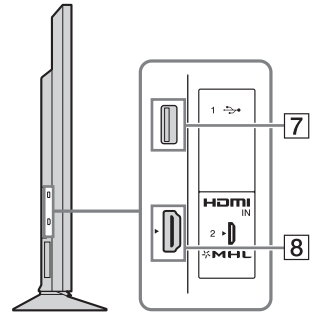

Item	Description
1	<p>VIDEO IN/COMPONENT IN/R-AUDIO-L (MONO)</p> <p>This input port can be used as a composite video input (VIDEO) or as a component video input (COMPONENT). For composite use, connect the yellow jack to Y for video and use audio L (mono) and R for audio signal. For component connection, use Y, P_B, P_R for video signals and also connect the audio L (mono) and R for audio signal. This TV can auto detect and switch between the VIDEO and COMPONENT when VIDEO or COMPONENT is connected. To set to auto detection, press HOME, select Settings, and then select the Setup settings. Select the Video/Component Selection option in AV Setup then set to Auto.</p>
2, 8	<p>HDMI IN 1 (ARC) HDMI IN 2/MHL) HDMI IN 3</p> <p>HDMI (High-Definition Multimedia Interface) provides an uncompressed, all-digital audio/video interface between this TV and any HDMI-equipped audio/video equipment, such as a set-top box, DVD player, and A/V receiver. HDMI supports enhanced, or high-definition video, plus digital audio. You can also connect your MHL (Mobile High-Definition Link) device to HDMI IN 2/MHL using an MHL cable. In addition, when you connect BRAVIA Sync-compatible equipment, communication with the connected device is supported. If connecting a digital audio system that is compatible with Audio Return Channel (ARC) technology, use HDMI IN 1 (ARC). If not, an additional connection with DIGITAL AUDIO OUT (OPTICAL) is necessary.</p>

Item	Description
3 CABLE/ ANTENNA	RF input that connects to your Cable or VHF/UHF antenna.
4 AUDIO OUT	Connects to the audio input jack of your analog audio equipment. You can use this output to listen to your TV's audio through your stereo system.
5 LAN	You can enjoy contents stored in DLNA Certified™ devices via a network (page 29), and also IPTV, applications and Internet Browser are available.
6 DIGITAL AUDIO OUT (OPTICAL)	Connects to the optical audio input of digital audio equipment that is PCM/Dolby Digital compatible.
7 USB	Connects to USB equipment to access photo, music, and video files. A standard USB mouse and USB keyboard can also be connected to the USB ports. An USB mouse or USB keyboard can only operate while navigating on the internet browser (page 33).



- An HDMI or Component video (YPbPr) connection is required to view 480i, 480p, 720p, 1080i and 1080p video formats. 1080/24p is available only with HDMI/MHL connection.
- Be sure to use only an authorized HDMI cable bearing the HDMI logo. We recommend that you use a Sony HDMI cable (high speed type).

Connecting the TV

Cable System or VHF/UHF Antenna System

You can enjoy high-definition and standard-definition digital programming (if available in your area) along with standard-definition analog programming.

This TV is capable of receiving unscrambled digital programming for both cable (QAM and 8VSB) and external VHF/UHF antenna (ATSC).

■ Cable or VHF/UHF (or VHF only)



- It is strongly recommended that you connect the CABLE/ANTENNA input using a 75-ohm coaxial cable to receive optimum picture quality. A 300-ohm twin lead cable can easily be affected by radio frequency interference, resulting in signal degradation.

Cable System and VHF/UHF Antenna System

Use an optional A-B RF switch (not supplied) to switch between the cable and over-the-air antenna programming, as indicated below.

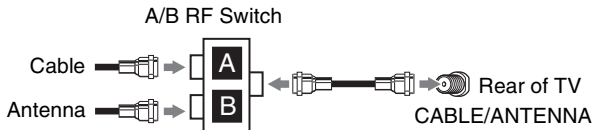

- Be sure to set the **Signal Type** setting to **Cable** or **Antenna** found under the **Channel** settings for your input signal (page 41).

HD Cable Box/HD Satellite Box

You can enjoy high-definition programming by subscribing to a high-definition cable service or a high-definition satellite service. For the best possible picture, make sure you connect this equipment to your TV via the HDMI or component video (with audio) input located on the back of your TV.

■ Shown with HDMI Connection

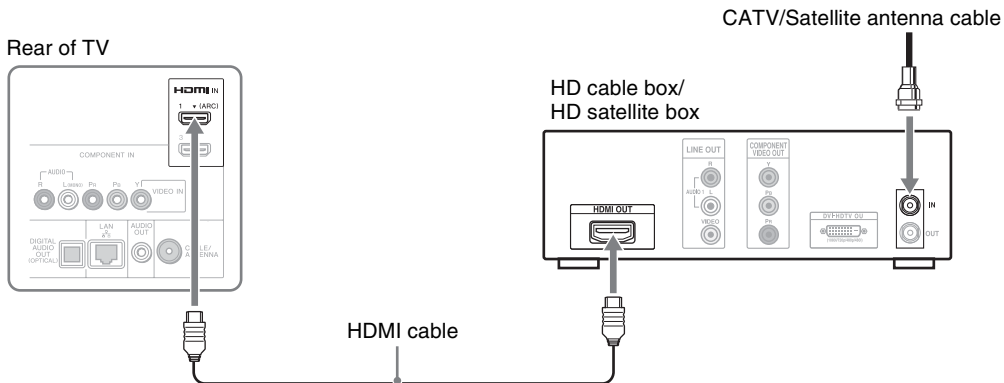

■ Shown with Component Connection

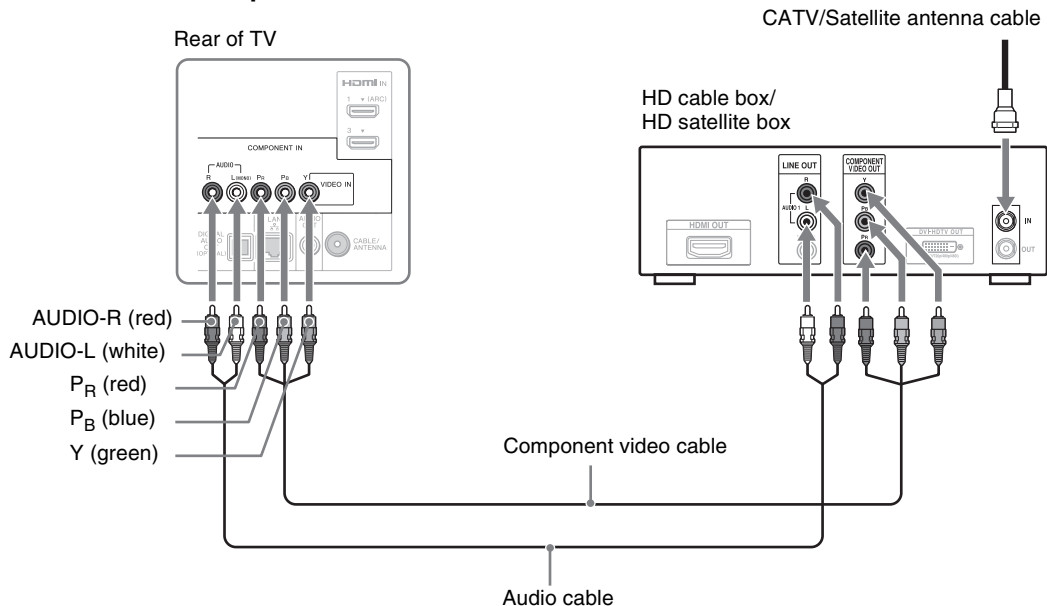

Connecting Other Equipment

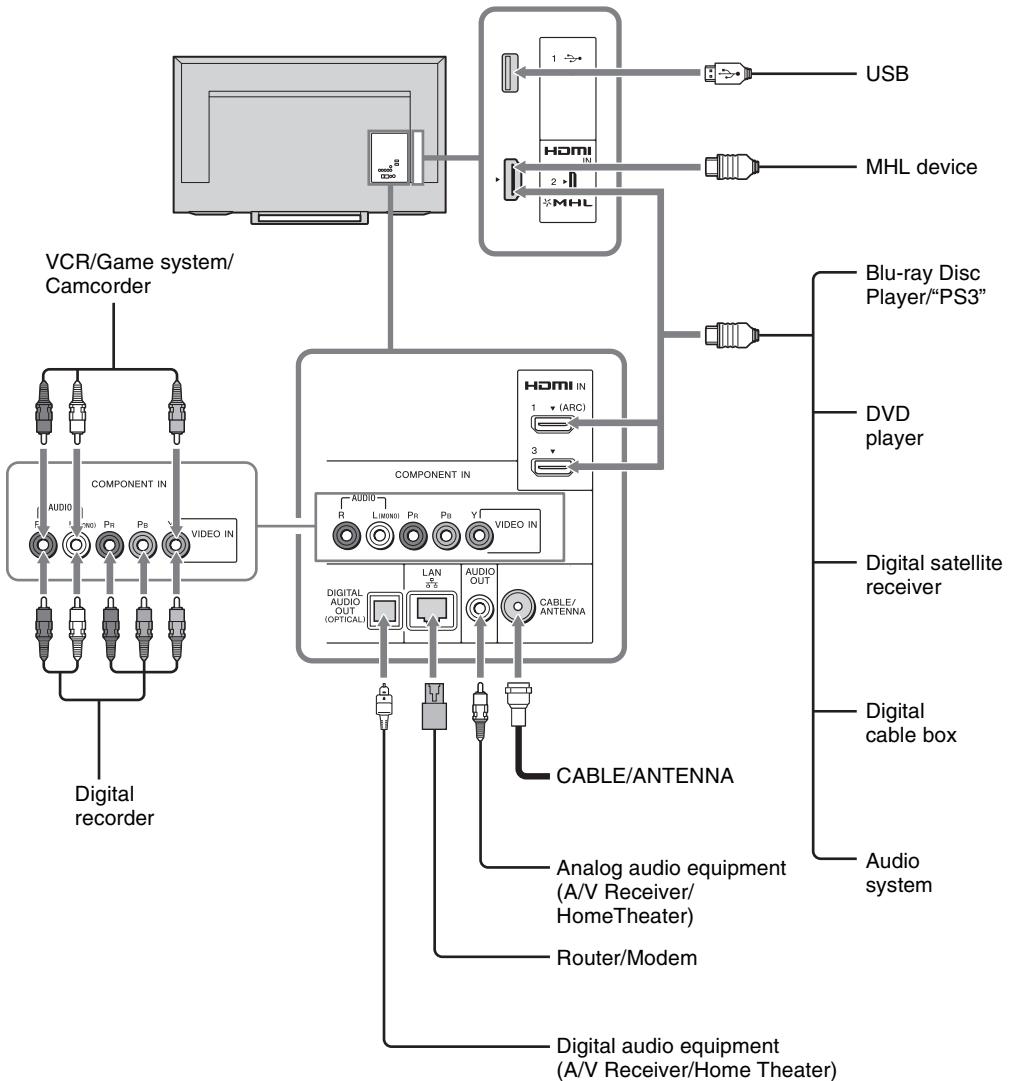

- Refer to the Quick Setup Guide (supplied) when connecting other equipment to your TV.

When Installing the TV Against a Wall or Enclosed Area

Make sure that your TV has adequate ventilation. Allow enough space around the TV as shown below. Avoid operating the TV at temperatures below 41 °F (5 °C).

Installed with stand

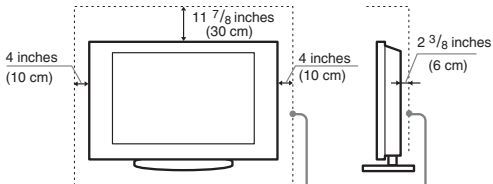

Leave at least this much space around the set.

Installed on the wall

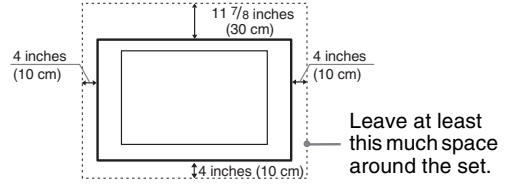

Leave at least this much space around the set.

Never install the TV set as follows:

Air circulation is blocked.

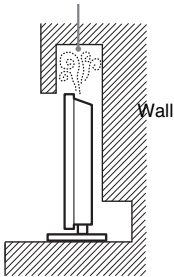

Air circulation is blocked.

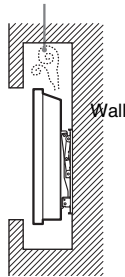

- Inadequate ventilation can lead to overheating of the TV and may cause TV damage or cause a fire.

Securing the TV



Sony strongly recommends taking measures to prevent the TV from toppling over. Unsecured TVs may topple and result in property damage, serious bodily injury or even death.

Preventing the TV from Toppling

- Secure the TV to a wall and/or stand.
- Do not allow children to play or climb on furniture and TV sets.
- Avoid placing or hanging items on the TV.
- Never install the TV on:
 - Slippery, unstable and/or uneven surfaces.
 - Furniture that can easily be used as steps, such as a chest of drawers.
- Install the TV where it cannot be pulled, pushed, or knocked over.
- Route all AC power cords and connecting cables so that they are not accessible to curious children.

Recommended Measures to Secure the TV

Consider the following measures when securing your TV to a TV stand (not supplied).

1 Secure the stand for the TV.

Make sure the TV stand can adequately support the weight of the TV. Use two angle braces (not supplied) to secure the stand.

For each angle brace use the appropriate hardware to:

- Attach one side of the angle brace to the wall stud.
- Attach the other side to the TV stand.

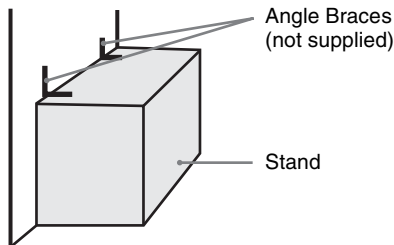

2 Secure the TV to the stand.

Use the optional hardware listed below (not supplied):

- M4 machine screw (screwed into the screw hole of the TV).
- A screw or similar (attach it to the TV stand).
- Rope or chain (strong enough to support the weight of the TV). Make sure that there is no excess slack in the rope or chain.

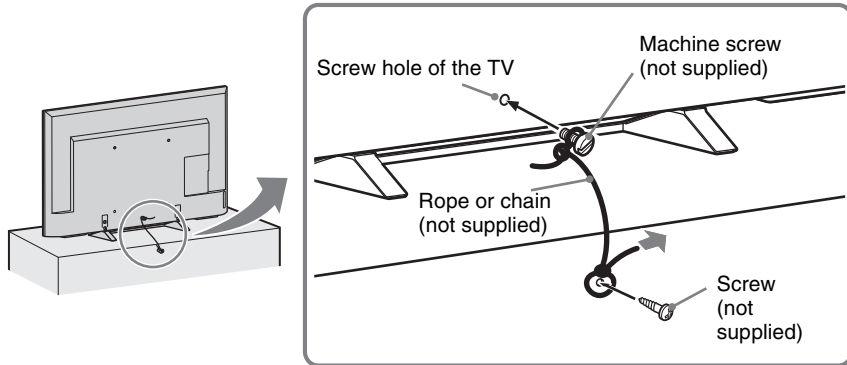

The length of the M4 machine screw differs depending on the rope or chain diameter. Please refer to below illustration.

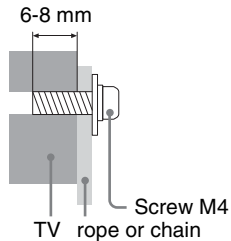

3 Anchor the TV to the wall.

Anchor the TV to the wall by using bolts, wall anchor and chain (or rope).

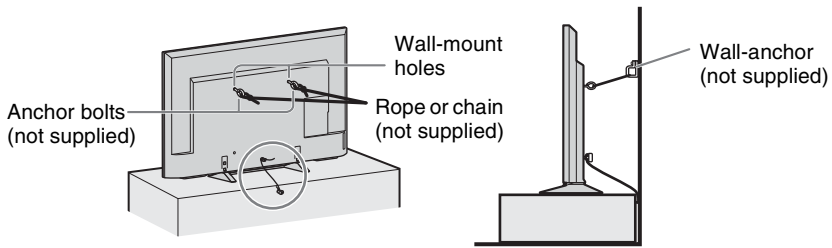

- Securing the TV to the stand without securing the TV and the stand to the wall provides minimum protection against the TV toppling over. For further protection, be sure to follow the three measures recommended.
- Your TV is shipped with screws attached to the rear of the TV depending on the TV model. (They are fastened in the screw holes for wall mounting.) Be sure to remove the upper two screws prior to anchoring the TV to a wall.

Running Initial Setup

Complete your cable connections before beginning the **Initial Setup**. Refer to the Quick Setup Guide (supplied) for sample connection diagrams.



- 1 Turn on the TV.
The **Initial Setup** screen will appear.

- 2 Use the remote control buttons described below to navigate through the **Initial Setup**.

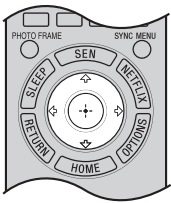

↑/↓/←/→ buttons:

Allow you to navigate and highlight options where applicable.

+ button:

Allows you to select the highlighted option and advance to the next screen.

- 3 **Auto Program** will scan for available channels from the signal source directly connected to the TV's CABLE/ANTENNA input. Follow the help text provided on the screen to run the **Auto Program**.



- If you cancel the **Auto Program**, any channels you have selected are not registered. To rescan for available channels, run **Auto Program**.
- Connect either your cable or antenna to the TV (you can connect both using an A-B RF switch (not supplied)); for more details see page 10.

- 4 Set the current date and time.

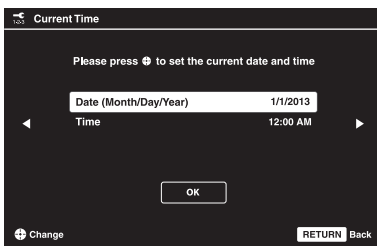

Using the Remote Control

To Insert Batteries into the Remote Control

Insert two size AAA batteries (supplied) by matching \oplus and \ominus on the batteries to the diagram inside the battery compartment of the remote control.

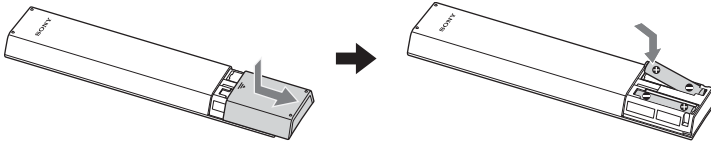

Guidelines to Follow

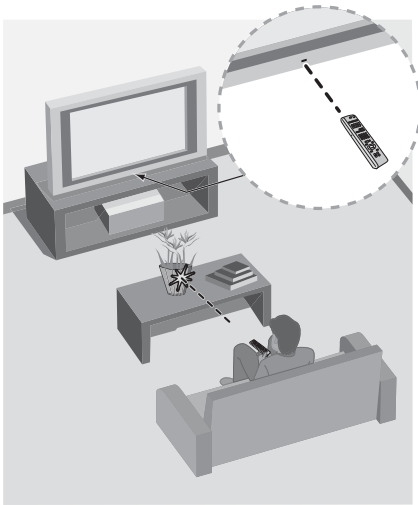

- Point your remote control directly at the IR sensor located on your TV.
- Make sure that no objects are blocking the path between the remote control and the IR sensor on your TV.
- Fluorescent lamps can interfere with your remote control; try turning off the fluorescent lamps.
- If you are having problems with the remote control, reinsert or replace your batteries and make sure that they are correctly inserted.
- Ensure that there are no objects in front of the TV.

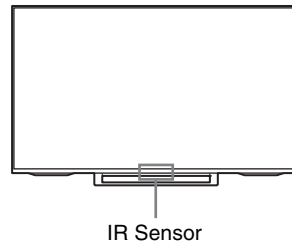



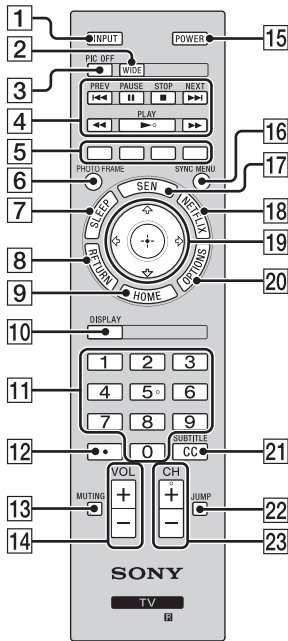

Remote Control Button Description



Button	Description
1 INPUT	Press to display the connected equipment list and select the input source. Press repeatedly to toggle through the inputs.
2 WIDE	Press repeatedly to cycle through the available Wide Mode settings. See page 24.
3 PIC OFF	Press to turn picture off, and sound remains on.
4 Equipment Control	These buttons are used to control the equipment connected to the TV by using the BRAVIA Sync Control function (not available on all BRAVIA Sync Control equipment). Some other buttons on the remote control may also operate BRAVIA® Sync™ equipment. <ul style="list-style-type: none"> ◀◀ (PREV): Press to replay the current program from the previous chapter mark. ⏸ (PAUSE): Press to pause playback. ■ (STOP): Press to stop playback. ▶▶ (NEXT): Press to advance forward to the next chapter mark. ◀◀ (fast reverse): Press to play a program in fast rewind mode. ▶ (PLAY): Press to play a program at a normal speed. ▶▶ (fast forward): Press to play a program in fast forward mode.
5 Colored buttons	When the colored buttons are available, an operation guide appears on the screen.







- The **5**, **▶** and **CH +** buttons have a tactile dot. Use them as a reference when operating the TV.

Button	Description
6 PHOTO FRAME	Press to display the Photo Frame. See page 28.
7 SLEEP	Press repeatedly until the TV displays the time in minutes (Off/15/30/45/60/90/120) that you want the TV to remain on before shutting off. To cancel the sleep timer, press SLEEP repeatedly until Off appears.
8 RETURN	Press to go back to the previous screen or exit from the screen when displaying menu items and settings.
9 HOME	Press to display the menu with TV functions and settings. See "Using the Menus" on page 35.
10 DISPLAY	Press once to display the banner with channel/program information you are watching. The banner will time out in a few seconds or press again to exit.
11 0-9	Press 0-9 to select a channel.
12 	Use with 0-9 to select digital channels. For example, to enter 2.1, press  ,  ,  and  .
13 MUTING	Press to mute the sound. Press again or press VOL + to restore the sound.
14 VOL +/-	Press to adjust the volume.
15 POWER	Press to turn on and off the TV.



- The scene select function is not compliant with USB/DLNA-Photo, -Music, -Video, IPTV, applications and Internet Browser.

Button	Description
16 SYNC MENU	Press to display the BRAVIA Sync Menu and then select connected HDMI/MHL equipment from Device Selection .
17 SEN	Enables selection of content from the online service "SEN" (Sony Entertainment Network). If "SEN" is unavailable, the "SEN" category is not displayed.
18 NETFLIX	Press to display the NETFLIX menu.
19  	Press  to move focus/highlight. Press  to select/confirm an item.
20 OPTIONS	Press to display a list of convenient functions and menu shortcuts. The options menu items vary based on current input and content.
21 CC/ SUBTITLE	Press to cycle through the available settings for Closed Captions (CC) : On , Off , and On when Muting .
22 JUMP	Press to jump back and forth between two channels and external inputs. The TV alternates between the current/last channel or external input selected.
	
23 CH +/-	Press to scan through channels. To scan quickly through channels, press and hold down either CH +/- .

TV Controls and Indicators

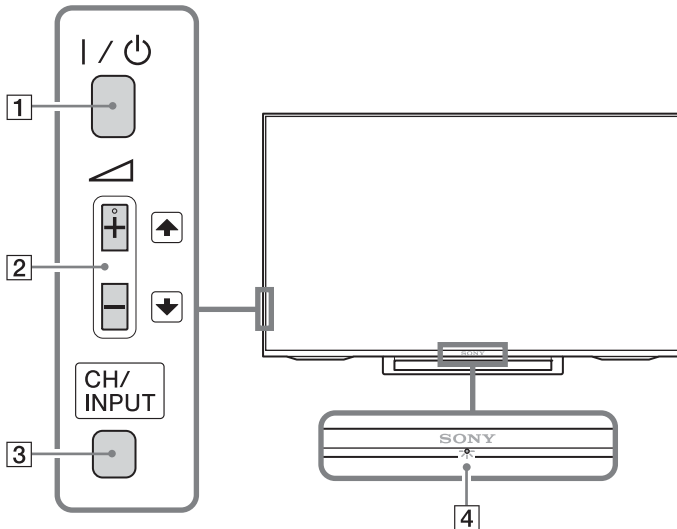

Item	Description
1 I/⏻ (Power)	Press to turn on and off the TV.
2 - + ↓ ↑	Press to adjust the volume, or select a channel/external input. When the volume Up/Down screen is displayed by pressing +/-, volume can be adjusted. When the channel Up/Down screen is displayed by pressing CH/INPUT , channels can be selected. When the input select screen is displayed by pressing CH/INPUT , external input can be selected.
3 CH/INPUT	Switches between the channel Up/Down screen, input select screen and volume Up/Down screen.
4 LED indicator	Receives IR signal from the remote control. <ul style="list-style-type: none"> Lights up in green when the TV is turned on. Lights up in orange when the timer is set or the TV is in Photo Frame Mode. Lights up in green when the Power Saving is set to Picture Off.



- The + button has a tactile dot. Use it as a reference when operating the TV.
- Make sure that the TV is completely switched off before unplugging the power cord.

Using PIP Feature

PIP (picture in picture) displays a picture from a connected PC in full screen, and a TV program or other external input (see below "To Enter PIP" table) in an inset window. (**Closed Captions (CC)** is not available with **PIP** mode.)

To Enter PIP

PIP Supported Inputs	
In main window	In sub window
HDMI IN (PC timing)	TV channel (CABLE/ANTENNA), VIDEO IN, COMPONENT IN

- 1 Press **OPTIONS** while a PC is connected to the TV.
- 2 Select **PIP** from the **OPTIONS** menu.
- 3 The sub window will appear.

Using PAP Feature

PAP (picture and picture) displays two pictures (left and right) on the screen simultaneously (e.g. external input and TV program). For details on external equipment, see page 12.

To Enter PAP

PAP Supported Inputs	
In main window	In sub window
Component	TV channel (CABLE/ANTENNA), VIDEO IN
HDMI IN (except PC timing)	TV channel (CABLE/ANTENNA), VIDEO IN, COMPONENT IN

- 1 Press **OPTIONS** and then select **P&P**.
- 2 Press **←/→** to select active picture.

Favorites

Your favorite channels and external inputs can be accessed by pressing the **HOME** button once they are added to the list.

- 1 Press **HOME**.
- 2 Press **▲/▼** to select **Favorites**, then press **⊕**.

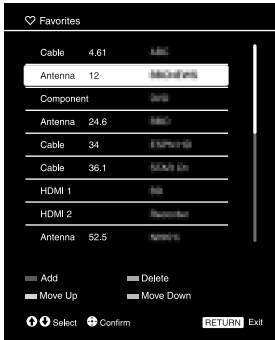

The favorites list appears.

- 3 Press **▲/▼** to select a channel or input, then press **⊕**.

Wide Mode

■ To change the Wide Screen mode

- 1 Press **WIDE** repeatedly to select the wide mode.

Wide Zoom*

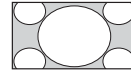

Normal

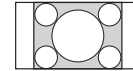

Full

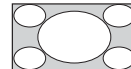

Zoom*



* Parts of the top and bottom of the picture may be cut off.

For HDMI PC Input (PC timing)

Normal

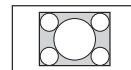

Full 1

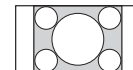

Full 2

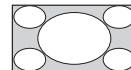

Playing back Photo/Music/Video via USB

You can enjoy photo/music/video files stored in a Sony digital still camera or camcorder through a USB cable or USB storage device on your TV.

- 1 Connect a supported USB device to the TV.
- 2 Press **HOME**.
- 3 Press **▲/▼** to select **Media**, then press **▲/▼/◀/▶** to select **Photo, Music, Video**, then press **(+)**.
- 4 **Device Selection** appears. Press **▲/▼** to select a device.
- 5 Press **▲/▼/◀/▶** to select a file or folder, then press **(+)**.
When you select a folder, select a file, then press **(+)**.
Playback starts.

If more than one device is connected, and you select a file from another device, repeat step 2 and 3.

■ Photo Playback Auto Start

The TV automatically displays the thumbnail view screen when the TV is turned on and a digital still camera or other device storing photo files is connected to the USB port then turned on (page 45).

■ Notes when playing back files

- While the TV is accessing the data on the USB device, observe the following:
 - Do not turn off the TV or connect USB device.
 - Do not disconnect the USB cable.
 - Do not remove the USB device.The data on the USB device may be damaged.

- Sony will not be held liable for any damage to, or loss of, data on the recording media due to a malfunction of any connected devices or the TV.
- Playback does not start automatically if the TV is turned on after connecting the digital still camera or other device to the USB port.
- The USB device supports FAT16, FAT32 and NTFS. Maximum USB Mass Storage (USB HDD) is 2TB.
- Photo Playback Auto Start works only for photo files in the newest digital still camera folder (DCF-compliant, highest-numbered "DCIM" folder).
- Playback may not start automatically when some digital still cameras (such as cameras with internal memory) are connected.
- The file name and folder name support only English.
- When you connect a Sony digital still camera, it is recommended to set the camera's USB connection mode to "Auto" or "Mass Storage." For more information about USB connection mode, refer to the instructions supplied with your digital camera.
- Use a USB storage device that is compliant with USB Mass Storage Class standards.
- If a selected file has incorrect container information, or is incomplete, it cannot be played back.

USB Video format

Extension	Container	Video Codec	Audio Codec
.avi	AVI	Xvid	PCM / MPEG1 Layer1, 2 / MP3 / MPEG2 AAC (2ch) / MPEG4 AAC (2ch) / MPEG4 HE-AAC (2ch) / Dolby Digital (2ch) / Dolby Digital Plus (2ch) / WMA v8
		MPEG1	
		MPEG2 MP	
		H.264 BP/MP/HP	
		MPEG-4 SP/ASP	
.wmv .asf	ASF	WMV v9	MP3 / WMA v8
		Xvid	
		MPEG-4 SP/ASP	
.mp4 .mov .3gp	MP4	VC-1	MPEG1 Layer1, 2 / MP3 / MPEG2 AAC / MPEG4 AAC / MPEG4 HE-AAC
		H.264 BP/MP/HP	
		MPEG-4 SP/ASP	
		H.263	
.mkv	MKV	H.264 BP/MP/HP	PCM / MPEG1 Layer1, 2 / MP3 / MPEG2 AAC (2ch) / MPEG4 AAC (2ch) / MPEG4 HE-AAC (2ch) / Dolby Digital (2ch) / Dolby Digital Plus (2ch) / WMA v8 / VORBIS
		MPEG-4 SP/ASP	
		WMV v9	
		VC-1	
		VP8	
.mpg .mpeg .vob .vro	PS	MPEG1	MPEG1 Layer1, 2 / MP3 / Dolby Digital (2ch) / Dolby Digital Plus (2ch)
		MPEG2 MP	
		MPEG2 MP	
		VC-1	
.ts .m2ts	TS	MPEG2 MP	MPEG1 Layer1, 2 / MP3 / MPEG2 AAC (2ch) / MPEG4 AAC (2ch) / MPEG4 HE-AAC (2ch) / Dolby Digital Plus (2ch) / Dolby Digital (2ch)
		VC-1	
		H.264 BP/MP/HP	

USB Music format

Extension	Audio Codec
.mp3	MP3
.wma	WMA v8

USB Photo format

Extension	Image Codec
.jpg, .jpeg	JPEG

DCF2.0 or EXIF2.21 supported.

• Playback of the above file formats is not guaranteed.

Home Network

Connecting to a Home Network

You can enjoy various content (e.g. photo/music/video files) stored on DLNA Certified™ media servers. The home network feature allows you to enjoy network content in other rooms.

■ Playing photo/music/video

- 1 Press **HOME**, then select **Media** > **Photo, Music** or **Video** > the desired media server.
- 2 Select files or folders to play from the list.



- The server is required to be DLNA Certified™.
- Files from a network device need to be in the following formats:
 - Still images: JPEG
 - Music: MP3, linear PCM, WMA
 - Video: AVCHD, MPEG2, MPEG1, MP4 (AVC), MP4 (MPEG4), WMV
- Depending on the file, playback may not be possible even when using the supported formats.

Renderer

You can play back photo, music and video files stored in network devices (e.g. digital still cameras, mobile phones, PC) on the TV screen by directly operating the target device. The network should also be renderer-compatible.

■ Adjusting the renderer settings

Press **HOME**, then select **Settings** > **Setup** > **Network** > **Home Network Setup** > **Renderer** > the desired setting.

Display Settings for Media Servers

Select home network servers to be displayed in the Home Menu. Up to 10 servers can be displayed in the Home Menu automatically.

- 1 Press **HOME**, then select **Settings** > **Setup** > **Network** > **Home Network Setup** > **Show/Hide Media Servers**.
- 2 Select the server to display in the Home Menu.

Photo Frame

Photo Frame displays the clock and calendar at the same time as displaying a photo and listening to music.

- 1 Press **HOME**.
- 2 Press **▲/▼** then **(+)** to select **Photo Frame Mode**.



■ To select photo or music from USB memory

- 1 Press **OPTIONS** while playing back a photo or music file.
- 2 Press **▲/▼** then **(+)** to select **Photo Frame Mode** to launch **Photo Frame**.

■ To select Display mode

You can change the photo frame display by selecting **Display Mode** in the **Photo Frame Settings** (page 45).

■ To select Clock Display mode

You can select among three clock display modes by selecting **Clock Display** in the **Photo Frame Settings** (page 45).



- This TV does not have a battery powered backup for the clock. Therefore, if there is a power failure or if you disconnect the power cord, be sure to reset the current date and time.

■ Duration

To save power, the TV continually plays back in photo frame mode for up to 24 hours before powering off automatically. After automatic power off, do not use photo frame mode for at least one hour to avoid panel burn-in.

You can change the setting of the **Duration** in the **Photo Frame Settings** (page 45).

To avoid panel burn-in, the position of the photo, clock and calendar are switched automatically every hour.

Using Home Network Features

When you connect this TV to the Internet, you can enjoy multiple functions: enjoying Internet video, etc.



- You will need to contract with an Internet service provider to connect to the Internet.

Preparing a Wired Network

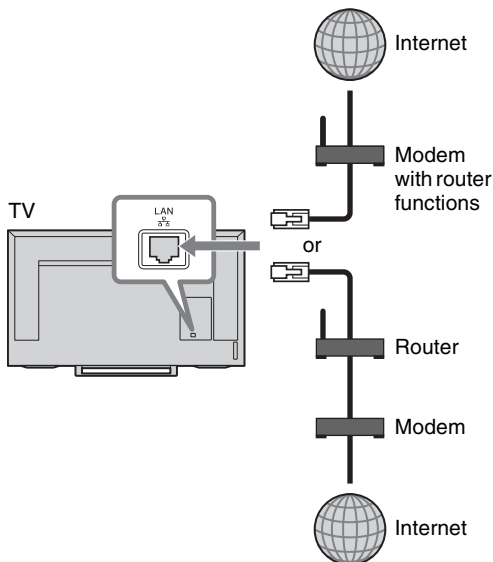

- For LAN connections, use a Category 7 cable (not supplied).

Setting up the Internet Connection

Using the network feature you can connect the TV to the Internet. The set-up procedure differs depending on the type of network and LAN router. Before setting up the Internet connection, be sure to set up a LAN router. Check your wireless LAN environment using the following chart.

Wireless LAN

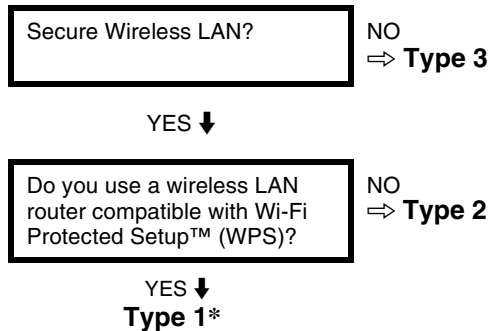

Wired LAN → Type 4

* Type 1 is easier to set up if your router has an automatic setting button, e.g. Air Station One-Touch Secure System (AOSS). Most of the latest routers have this function. Check your router.

Type 1: Follow the configuration for **Secured network with Wi-Fi Protected Setup™ (WPS)**.

Type 2: Follow the configuration for **Secured network without Wi-Fi Protected Setup™ (WPS)**.

Type 3: Follow the configuration for **Unsecured network with any type of wireless LAN router**.

Type 4: Follow the configuration for **Wired network set-up**.

Type 1: Secured network with Wi-Fi Protected Setup™ (WPS)

The WPS standard makes security of a wireless home network as straightforward as pressing the WPS button on the wireless LAN router. Before setting up a wireless LAN, check the location of the WPS button on the router and verify how to use it.

For security purpose, **WPS (PIN)** provides a PIN code for your router. PIN code is renewed every time you select **WPS (PIN)**.

- 1 Press **HOME**, then select **Settings > Setup > Network > Network Setup**.
- 2 IP Address setting/Proxy server:
 - automatic setting:
Set up network connection > Auto
 - manual setting:
Set up network connection > Custom > Wireless Setup
- 3 Select **WPS (Push Button)** for Push Button method or **WPS (PIN)** for PIN method.



- Button name of the WPS may differ depending on the router (e.g. AOSS button).

- 4 Follow the instructions on the set-up screen.



- To use the network with IPv6, select **Settings > Setup > Network > IPv6/IPv4 Priority > IPv6**, then select **Auto** in **Set up network connection**.
- When IPv6 is selected, HTTP Proxy cannot be set.

Type 2: Secured network without Wi-Fi Protected Setup™ (WPS)

To set up a wireless LAN, SSID (wireless network name) and security key (WEP or WPA key) will be required. If you do not know them, consult the instruction manual of your router.

- 1 Press **HOME**, then select **Settings > Setup > Network > Network Setup**.
- 2 IP Address setting/Proxy server:
 - automatic setting:
Set up network connection > Auto
 - manual setting:
Set up network connection > Custom > Wireless Setup
- 3 Select **Scan**, then select a network from the list of scanned wireless networks.
- 4 Follow the instructions on the set-up screen.



- If you use WPS for network set-up, the security settings of the wireless LAN router activate, and any equipment previously connected to the wireless LAN in a non-secure status will be disconnected from the network. In this case, activate the security settings of the disconnected equipment and then reconnect. Or, you can deactivate the security settings of the wireless LAN router, and then connect the equipment to a TV in a non-secure status.
- To use the network with IPv6, select **Settings > Setup > Network > IPv6/IPv4 Priority > IPv6**, then select **Auto** in **Set up network connection**.
- When IPv6 is selected, HTTP Proxy cannot be set.

Type 3: Unsecured network with any type of wireless LAN router

To set up a wireless LAN, SSID (wireless network name) will be required.

- 1 Press **HOME**, then select **Settings > Setup > Network > Network Setup**.
- 2 IP Address setting/Proxy server:
 - automatic setting:
Set up network connection > Auto
 - manual setting:
Set up network connection > Custom > Wireless Setup
- 3 Select **Scan**, then select a network from the list of scanned wireless networks.
- 4 Follow the instructions on the set-up screen.



- Security key (WEP or WPA key) will not be required because you do not need to select any security method in this procedure.
- To use the network with IPv6, select **Settings > Setup > Network > IPv6/IPv4 Priority > IPv6**, then select **Auto** in **Set up network connection**.
- When IPv6 is selected, HTTP Proxy cannot be set.

Type 4: Wired network set-up

Enter the respective alphanumeric values for your router if necessary. The items that need to be set (e.g. IP Address, Subnet Mask, DHCP) may differ depending on the Internet service provider or router. For details, refer to the instruction manuals provided by your Internet service provider, or those supplied with the router.

- 1 Press **HOME**, then select **Settings > Setup > Network > Network Setup**.
- 2 IP Address setting/Proxy server:
 - automatic setting:
Set up network connection > Auto
 - manual setting:
Set up network connection > Custom > Wired Setup
- 3 Follow the instructions on the set-up screen.

Network Setup can also be set from **Initial Setup** menu.



- Allows automatic configuration of your wired/wireless network.
 - When connecting with LAN cable: **Wired**
 - When connecting with built-in Wireless LAN: **Wireless**
 - When connecting with both of the cables: **Wired**
- Set to **Auto**, sets the IP address automatically. For proxy server is not use.
- To use the network with IPv6, select **Settings > Setup > Network > IPv6/IPv4 Priority > IPv6**, then select **Auto** in **Set up network connection**.
- When IPv6 is selected, HTTP Proxy cannot be set.

Viewing the Network Status

You can confirm your network status.

- 1 Press **HOME**, then select **Settings > Setup > Network > Network Setup**.
- 2 Select **View Network settings and status**.

If You Cannot Connect to the Internet

Use the diagnosis to check possible causes for network connection failures, and settings.

- 1 Press **HOME**, then select **Settings > Setup > Network > Network Setup**.
- 2 Select **View Network settings and status**.
- 3 Select **Check Connection**.
This may take several minutes. You cannot cancel the diagnosis after selecting **Check Connection**.

Adjusting the Server Display Settings

You can select home network servers to be displayed on the Home Menu. Up to 10 servers can be displayed in the Home Menu automatically.

- 1 Press **HOME**, then select **Settings > Setup > Network > Home Network Setup**.
- 2 Select **Show/Hide Media Servers**.
- 3 Select the server you want to display on the Home Menu, and adjust the settings.

■ If you cannot connect to your home network

The TV detects if the server is being correctly recognised when you cannot connect it to your home network. If the diagnostic results indicate a failure, check possible causes, and network connections and settings.

- 1 Press **HOME**, then select **Settings > Setup > Network > Home Network Setup**.
- 2 Select **Media Server Troubleshooting**.
Press **Yes**, then the server diagnostic starts. When the server diagnostic is complete, the diagnostic result list appears.

Browsing Websites

When the TV is connected to the Internet, you can browse websites.

Press **HOME**, then select **Internet Browser** to launch the browser.

You can bookmark your favorite sites for easy access.



- Web content may not be displayed correctly, or some functions may not work properly, if the TV does not support functions provided by certain Internet services. Also, the TV may not support functions developed in the future.

■ Note on Internet Browser

In no event shall Sony be liable for any damage caused or associated with the use of Internet browser, malfunction (including software) or communication failure.

■ When using a USB mouse/USB keyboard

- You can move the cursor with the USB mouse.
- You can enter text with a keyboard.



- Depending on the USB equipment, you may not be able to control the browser.

Enjoying Sony Entertainment Network

Sony Entertainment Network serves as a gateway to Internet content, delivering a variety of on-demand entertainment straight to your TV. By making a broadband Internet connection, you can enjoy video content, including movies and cartoons.



- Be sure to connect your TV to the broadband Internet and complete **Network Setup** (page 44).

■ To use Sony Entertainment Network

- 1 Press **HOME**, then select **Sony Entertainment Network**.
- 2 Press **▲/▼/◀/▶** to select the desired video service in Service list and press **⊕**.
- 3 Highlight the desired content, then press **⊕**.

■ To exit Sony Entertainment Network

Press **HOME**.

■ To launch Internet Video

Internet Video can also be launched by pressing the **SEN** button on the remote control.



- If you experience difficulties with this feature, check that the Internet connection is set up properly.
- Information about the highlighted icon appears in the information banner.
- The interface to Internet content depends on the Internet content providers.
- Services block video content is based on the **Parental Lock** setting of the TV. Some service providers do not support this function (page 41).

(Continued) **33**

- To update Sony Entertainment Network content services, Press **HOME**, then select **Settings > Setup > Network > Refresh Internet Content**.

■ Seeking forward/backward in video content

Press the buttons on the remote controls that correspond with the control indications on the screen.



Control indications

■ To use NETFLIX

Press **NETFLIX** button on the remote control to launch menu.

■ To use YouTube Leanback

Follow the steps in “**To use Sony Entertainment Network**” (page 33) to launch **Sony Entertainment Network**, then select YouTube to launch the YouTube Leanback.



- It is possible that Netflix cannot be used via a Proxy server.

Enjoying Applications

With the applications, you can display a variety of information on the screen. Applications provide easy access to interactive content when your TV is connected to the Internet.



- Be sure to connect your TV to the Internet, and complete **Network Setup**.
- If you experience difficulties with this feature, check that the Internet connection is set up properly.

- 1 Press **HOME**.
- 2 Press **▲/▼** to select **Applications**, and press **⊕**.
- 3 Select applications to display on the screen.

■ To launch applications

Applications can be also launched by pressing the **SEN** button on the remote control.

Navigating through TV Menu

The **HOME** button allows you to access a variety of TV settings and USB media files.

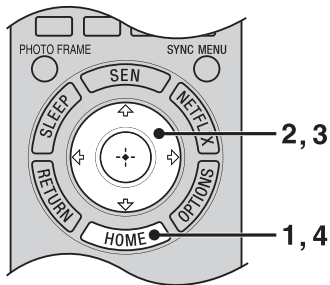

- 1 Press on the remote control to display the menu options.
- 2 Press to navigate on the menu or adjust the settings.
- 3 Press to select or confirm.
- 4 Press to exit.



Sony Entertainment Network serves as a gateway to Internet content, delivering a variety of on-demand entertainment straight to your TV.



Enables access to Internet services for TV. For details, see page 33.



Internet Apps are small downloadable applications that provide easy access to interactive content when your TV is connected to the Internet. You can display a variety of information on the screen.

Internet Apps may not be available in some region/country. For details, see page 34.



When the TV is connected to the Internet, you can browse websites. Select the browser and enter a URL. For details, see page 33.



The Favorites feature provides quick access to your frequently used items, such as preferred TV channels or external inputs (e.g. game console, DVD player). For details, see page 24.



Media



Photo



Music



Video

The **Photo**, **Music**, and **Video** icons organize your photo, music, and video files from DLNA Certified™ networked equipment or Sony USB connected equipment. Be sure to select the correct icon when accessing files. Refer to the feature section for more information on these icons.



Photo Frame Mode

You can select the frame image which enables you to enjoy with photo, music and clock. For details, see page 28.



Settings

The **Settings** icon contains all of the necessary configurations to customize your TV settings. The options you can select may vary. Unavailable options are grayed out or not displayed.



Picture: adjust the picture on your TV to fit your viewing preference.



Sound: customize your sound settings to suit your audio preference. You can also change the settings to output the sound to your connected audio equipment.



Screen: adjust the size and shape of the images you see on the screen.



Channel: navigate your favorite channels and inputs and select the signal type, as well as autoprogram channels. You can also customize the channels you see and the labels assigned to them.



Parental Lock: set the password and limit access to programming based on rating levels. You can also block channels and inputs.



Setup: modify and customize a variety of general setting options.



Eco: changes the settings related to power consumption.



Using the Picture Settings

Option	Description
Picture Mode	Displays the options selected in the Scene Select settings.
Customized picture viewing	Vivid Select for enhanced picture contrast and sharpness.
	Standard Select for standard picture settings. Recommended for home entertainment.
	Custom Select to store your preferred settings.
	Cinema For film-based content. Suitable in a theater-like environment.
	Graphics Optimizes picture quality for viewing graphics.
Reset	Resets the current Picture settings to their defaults, except Picture Mode .
Backlight	Adjust to brighten or darken the backlight.
Picture	Adjust to increase or decrease picture contrast.

Option	Description
Brightness	Adjust to brighten or darken the picture.
Color	Adjust to increase or decrease color intensity.
Hue	Adjust to increase or decrease the green tones.
Sharpness	Adjust to sharpen or soften the picture.
Color Temperature	Cool Select to give the white colors a bluish tint.
White adjustment	Neutral Select to give the white colors a neutral tint.
	Warm Select to give the white colors a reddish tint.
Noise Reduction	Select to reduce the picture noise level. Select from Auto , High , Medium , Low and Off .
MPEG Noise Reduction	Select to reduce the picture noise in MPEG-compressed videos. This is effective when viewing a DVD or digital broadcast. Select from High , Medium , Low and Off .
Motionflow	Provides smoother picture movement and reduces picture blur.
	High Provides smoother picture movement such as for film-based contents.
	Standard Provides smooth picture movement. Use this setting for standard use.
	Off Use this setting when the High and Standard settings result in noise.



- You can change the IPTV picture setting, only when watching Internet video.

Option	Description
CineMotion	Provides improved picture movement and reduces picture blur and graininess for film-based content. Select Auto 1 to represent original film-based content as is, or Auto 2 for standard use. (Setting items vary depending on the TV model.)
Advanced Settings	Reset Resets the advanced settings to the default values.
	Adv. Contrast Enhancer Automatically adjusts backlight and contrast to the most suitable settings judging from the brightness of the screen. This setting is especially effective for dark scenes, and will increase the contrast distinction of the darker picture scenes. Select from High , Medium , Low and Off .
	Black Corrector Enhances black areas of the picture for stronger contrast. Select from High , Medium , Low and Off .
	Gamma Adjusts the balance between bright and dark areas of the picture.
	Clear White Emphasizes white colors. Select from High , Low and Off .
	Live Color Makes colors more vivid. Select from High , Medium , Low and Off .
	LED Motion Mode Lights up the backlight adequately, reducing blur in movies, but the brightness decreases.

(Continued) **37**



- Available **Picture** options, including options in **Advanced Settings** depend on **Scene Select** and **Picture Mode**.

Using the Sound Settings

Option	Description
Sound Mode Customized sound listening	Sets a sound mode. Sound Mode includes options best suited for video and photographs, respectively.
	Standard Optimizes sound quality for general content.
	Music Lets you experience dynamic and clear sound, like that of a concert.
	Cinema Optimizes surround sound for movies.
	Game Broadens your game-playing experience with superb sound quality.
	Sports Reproduces realistic sound, like that in a stadium.
Reset	Resets the current Sound settings to their defaults, except MTS Audio , Alternate Audio , Speakers , Audio Out and Digital Audio Out .
Equalizer	Adjust allows you to select your frequency response curve. Select Reset to reset the Equalizer settings to the default values.
Sound Booster	Select On to enhance treble/bass and reproduces dynamic sound, or Off to provide natural sound.
Clear Voice	Select On for spoken dialog.
Steady Sound	Select On to stabilize the volume across all programs and commercials. Select Off to disable this function.
Balance	Adjust to emphasize left or right speaker balance.
Volume Offset	Adjust the volume level of the current input relative to other inputs.
MTS Audio Enjoy stereo, bilingual and mono programs	Stereo Select for stereo reception when viewing a program broadcast in stereo.
	Auto SAP Select to automatically switch the TV to second audio programs when a signal is received. If no SAP signal is present, the TV remains in Stereo mode.
	Mono Select for mono reception. Use to reduce noise during weak stereo broadcasts.
Alternate Audio Digital channels only	Select among the available options to switch among the alternate audio streams. The program you are tuned to may be broadcasted in a different language in the alternate audio streams.
Speakers	TV Speakers Select to use the TV speakers.
	Audio System Select to use an external audio system for the TV sound. By selecting this option you are disabling the TV speakers.

Option	Description
Audio Out	Variable Adjusts the volume with the TV's remote control, when using an external audio system.
	Fixed Adjusts the volume using the connected audio system's remote control.
Digital Audio Out	Select Auto if the device connected via DIGITAL AUDIO OUT (OPTICAL) is compatible with Dolby Digital. Select PCM if the device is not compatible with Dolby Digital.



- **MTS Audio** is only available for analog programs.
- **Alternate Audio** is only available if the program is broadcast with alternate audio streams.
- You can also access **Sound Mode**, **MTS Audio**, **Alternate Audio** and **Speakers** by using the **OPTIONS** button on the remote control.



Using the Screen Settings

Option	Description
Wide Mode	Wide Zoom Fills the screen with minimum distortion.
	Normal Select to display 4:3 picture in original size when the original source is 4:3.
	Full Select to enlarge the picture horizontally to fill the screen when the original source is 4:3 (Standard definition source). When the original source is 16:9 (High-definition source), select this mode to display the 16:9 picture in its original size.
	Zoom Select to enlarge the original picture without distorting the aspect ratio.
Auto Wide	On Select On to automatically change Wide Mode setting based on the content.
	Off If frequent screen changes are disturbing to you, select Off . Choose one of the Wide Mode options when this function is set to Off .
4:3 Default Select the default Screen Mode to use for 4:3 sources	Wide Zoom Enlarges the 4:3 picture to fill the 16:9 screen, displaying as much of the original image as possible.
	Normal Select to display the 4:3 picture in its original size.
	Off Select to continue using the current Wide Mode setting when the channel or input is changed.
Auto Display Area	Automatically adjusts the picture to the most appropriate display area.

Option	Description
Display Area	Each setting depends on the resolution you are watching.
Full Pixel	Displays pictures in their original size when parts of the picture are cut off (available depending on the TV model).
+1	Displays pictures in their original size.
Normal	Displays pictures in their recommended size.
-1	Enlarges the picture so that the edges are outside the visible display area.
Horizontal Center	Allows you to move the position of the picture left and right. (Available in Wide Zoom and Zoom .)
Vertical Center	Allows you to move the position of the picture up and down. (Available in Wide Zoom and Zoom .)



- **Normal** in the **Wide Mode** setting is not available when you are watching a 720p, 1080i or 1080p source.
- If **4:3 Default** is set to anything but **Off**, the **Wide Mode** setting changes only for the current channel. When you change channels (or inputs), **Wide Mode** is automatically replaced with the **4:3 Default** setting for 4:3 sources. To retain the current **Wide Mode** setting as channels and inputs are changed, set **4:3 Default** to **Off**.
- **4:3 Default** is not available if **Auto Wide** is set to **Off**.

Option	Description						
PC Settings	When a PC is connected to the TV, the PC settings screen appears instead of the Screen settings. You can also select the PIP feature which allows you to view two pictures simultaneously from OPTIONS button (page 23).						
Wide Mode	<table border="1"> <tr> <td>Normal</td> <td>Select to display in the original image size.</td> </tr> <tr> <td>Full 1</td> <td>Select to enlarge the picture to fill the display area, keeping its original aspect ratio.</td> </tr> <tr> <td>Full 2</td> <td>Select to enlarge the picture to fill the display area.</td> </tr> </table>	Normal	Select to display in the original image size.	Full 1	Select to enlarge the picture to fill the display area, keeping its original aspect ratio.	Full 2	Select to enlarge the picture to fill the display area.
Normal	Select to display in the original image size.						
Full 1	Select to enlarge the picture to fill the display area, keeping its original aspect ratio.						
Full 2	Select to enlarge the picture to fill the display area.						
Reset	Resets all PC settings to the default values.						
Horizontal Center	Allows you to move the position of the picture left and right.						
Vertical Center	Allows you to move the position of the picture up and down.						



- For the PC Input Signal Reference Chart, see page 50.



Using the Channel Settings

Option	Description
Signal Type	Cable Select if you are receiving cable channels via Cable TV provider.
	Antenna Select if you are using an antenna.
Auto Program	Automatically sets up the channel list on the TV for all receivable channels. <ol style="list-style-type: none"> 1 Select Auto Program. 2 Select OK to start Auto Program.
Add Digital Channels	<ol style="list-style-type: none"> 1 Select Add Digital Channels. 2 Select OK to add digital channels.
Show/Hide Channels	Allows you to show or hide channels that appear when you use the CH +/- buttons. <ol style="list-style-type: none"> 1 Press ▲/▼ to scroll through the channels until you find the channel you want to show or hide. Then press (+) to select it. 2 Press ▲/▼ to determine if the channel will be shown or hidden. Then press (+) to select it.
Edit Channel Labels	Allows you to assign labels (such as station call letters) to channel numbers. <ol style="list-style-type: none"> 1 Press ▲/▼ to scroll through the channel numbers. Then press (+) to select the channel number that you want to assign a label. 2 Press ▲/▼ to scroll through the label characters (A-Z, 0-9, etc.). Press ▶ to move to the next character. Repeat the previous steps to add up to seven characters to the label. When finished, press (+).
Analog Fine Tune	Allows you to fine-tune the selected analog channel manually if you feel that a slight tuning adjustment may improve picture quality. Select Auto to adjust to the most appropriate analog channel.



- You should run **Auto Program** after changing the **Signal Type** setting.
- Running **Auto Program** will clear the **Favorites** list.
- Channels that you set to be hidden can be accessed by the **0-9** and  buttons.
- You can set channels to be hidden that are automatically set in **Auto Program**.



Using the Parental Lock Settings

Option	Description
Password	The Parental Lock settings allow you to set up the TV to block programs according to their content and rating levels. Use 0-9 on the remote control to enter a four-digit password. The first time you create a password, confirm the password by entering it again.
Change Password	Select to change your password.

Option	Description
Country	U.S.A. Select to use U.S.A. ratings (page 43).
	Canada Select to use Canadian ratings (page 43).
Rating	Off Turn Parental Lock off. No programs are blocked from viewing.
	Child Maximum ratings permitted are: U.S.: TV-Y, TV-G, G Canada: C, G, TV-Y
	Youth Maximum ratings permitted are: U.S.: TV-PG, PG Canada: C8+, PG, 8 ans+, TV-PG
	Young Adult Maximum ratings permitted are: U.S.: TV-14, PG-13 Canada: 14+, 13 ans+, TV-14
	Custom Select to set ratings manually. U.S.: See page 43 for details. Canada: See page 43 for details.
Downloadable U.S. Rating (Available only in U.S.A. where advanced ratings exist)	Off Turn Downloadable U.S. Rating off. No programs that contain downloadable ratings are blocked from viewing.
	Custom Select to block programs based on downloadable ratings.
	Clear All Select to clear the entire downloadable rating system.
Unrated (Available only when Country is set to U.S.A.)	Allow Allows programs and movies that are broadcasted without a rating.
	Block Blocks all programs and movies that are broadcasted without a rating.
Channel Block	Allows you to block channels regardless of program ratings.
	To View a Blocked Channel Press (+) when tuned to the blocked channel then enter the password.
External Input Block	Allows you to block external inputs regardless of program ratings.
	To View a Blocked External Input Press (+) when tuned to the blocked input then enter the password.



- You need your password for any future access into the **Parental Lock** settings. If you lose your password, see “Lost password” on page 57.
- Selecting **Clear All** will delete the current **Downloadable U.S. Rating** menu and the menu will no longer be available until the TV is tuned to a channel that contains downloadable ratings.
- If you block unrated TV programs, be aware that the following types of programs may be blocked: programs broadcasted from another country, emergency broadcasts, political programs, sports, news, public service announcements, religious programs and weather.

■ US Models: Selecting Custom Parental Lock Rating Options

To select custom rating options for the U.S., select **U.S.A.** in the **Country** setting (page 42).

Option	Description
Movie Rating	G All children and general audience.
	PG Parental guidance suggested.
	PG-13 Parental guidance for children under 13.
	R Restricted viewing, parental guidance is suggested for children under 17.
	NC-17 and X No one 17 or under allowed.
TV Rating Block programs by their rating, content or both	Age-Based Ratings
	TV-Y All children.
	TV-Y7 Directed to children age 7 and older.
	TV-G General audience.
	TV-PG Parental guidance suggested.
	TV-14 Parents strongly cautioned.
	TV-MA Mature audience only.
	Content-Based Ratings
	FV Fantasy violence.
	D Suggestive dialog.
	L Strong language.
	S Sexual situations.
	V Violence.



- To ensure maximum blocking capability, set the Age-Based Ratings.

■ Canadian Models: Selecting Custom Parental Lock Rating Options

To select custom rating options for Canada, select **Canada** in the **Country** setting (page 42).

Option	Description
English Rating	C All children.
	C8+ Children 8 years and older.
	G General programming.
	PG Parental guidance.
	14+ Viewers 14 and older.
	18+ Adult programming.

Option	Description
French Rating	G General programming.
	8 ans+ Not recommended for young children.
	13 ans+ Not recommended for ages under 13.
	16 ans+ Not recommended for ages under 16.
	18 ans+ Programming restricted to adults.
U.S.A. Rating	See "US Models" on page 43 for details.

■ Viewing Blocked Programs

You can view blocked programs by entering your password. Press ⊕ when tuned to a blocked program, then enter the password. This temporarily deactivates the parental control feature. To reactivate the **Parental Lock** settings, turn off the TV. When the TV is turned on again, your **Parental Lock** settings are reactivated.



Using the Setup Settings

Option	Description	
Network	Network Setup Sets the network status settings.	
	IPv6/IPv4 Priority	
	 <ul style="list-style-type: none"> • To use the network with IPv6, select IPv6, then select Auto in Set up network connection. • When IPv6 is selected, HTTP Proxy cannot be set. • When IPv6 is selected, some Internet browser sites, applications or content cannot be watched. 	
	Built-in Wireless LAN	Turns the built-in wireless LAN On or Off . Set to Off , if you do not use the built-in wireless LAN. When you switch from Off to On , make the settings in Network Setup .
	Device Name	Select to change the name of the TV shown on DLNA Certified™ media servers.
Refresh Internet Content	Reconnects to the Internet to receive available Internet content services.	

Option	Description	
Home Network Setup	Show/Hide Media Servers Displays the connected server list. You can select the server to display in the Home menu.	
	Media Server Troubleshooting Diagnoses whether the TV can connect to each server on the home network.	
	Renderer Renderer Enables the TV to play photo/music/video files on a device (e.g. digital still camera) by operating the device via the network.	
	Renderer Access Control Allows access from a specified control device.	
Photo Frame Settings	Renderer Options Adjusts the Renderer Options detailed settings.	
	Display Mode Allows you to select the display mode. Select from Image and Clock , Full Screen Image and Full Screen Clock . See page 28.	
	Clock Display Allows you to select the clock display. Select from Calendar , Analog Clock , Digital Clock , Calendar and Clock or Clock . Calendar and Clock and Clock can be displayed only when Display Mode is Full Screen Clock .	
	Audio Music You can enjoy music with this function.	
	Application Off Turns off the music.	
	Image Selection Select image.	
	Music Selection Select music.	
	Slideshow Setting	Slideshow You can play a slideshow of photos.
		Single View Displays one photo only.
	Music Playback Setting	All Tracks Listen to all music tracks.
		Single Track Set to listen to a single music track.
	Duration Selects the time period (1h , 2h , 4h or 24h) after which the TV automatically switches to standby mode.	
	First day of the week Set Sunday or Monday as the first day of the week on the calendar.	
USB Auto Start Select On to start photo/music/video playback automatically when the TV is turned on and a digital still camera or other device containing photo, music or video files is still connected to the USB port then turned on.		

Option	Description	
Closed Captions (CC)	Allows you to select from several closed caption modes (for programs that are broadcast with closed captioning).	
	CC Display	
	On	Closed Captions (CC) is turned on.
	Off	Closed Captions (CC) is turned off.
	On when Muting	Closed Captions (CC) is turned on when the TV is muted.
	Analog CC	Allows you to select basic analog (EIA-608) closed caption options.
	CC1, CC2, CC3, CC4	Displays a printed version of the dialog or sound effects of a program. (Should be set to CC1 for most programs.)
	Text1, Text2, Text3, Text4	Displays network/station information presented using either half or the whole screen (if available).
	Digital CC	When the digital closed caption service is available, select from the Service 1-6 or CC1-4 .
	Digital CC Options	Allows you to make additional settings for digital closed caption options. Select As Broadcast or Custom . The Custom option is available on the Digital CC setting.
	Custom	Allows you to customize the following settings:
	Character Size	Small, Standard, Large
	Character Style	Style 1-7
	Character Color	Color 1-8
	Character Opacity	Solid, Translucent
	Edge Type	None, Raised, Depressed, Outline, Left Shadow, Right Shadow
	Edge Color	Color 1-8
	Background Color	Color 1-8
	Background Opacity	Solid, Translucent
Audio Description	Provides an audio description (narration) of visual information, when available.	



- You can turn on **Closed Captions (CC)** options (**On**, **Off** or **On when Muting**) by pressing the **CC** button on the remote control.

Option	Description
Info Banner	Select Small to display minimal channel and program title or select Large to display detailed channel and program information along with the TV icon if you are viewing the TV. Select Hidden to hide information about the TV channel or program. This information will appear if it is available from the broadcaster. Info Banner appears on the screen each time the channel and external inputs are changed or when DISPLAY on the remote control is pressed.
Clock/Timers	<p>Sleep Timer Set the time in minutes (Off, 15, 30, 45, 60, 90, or 120) that you would like the TV to remain on before shutting off automatically.</p> <p>On Timer Turns on the TV from standby mode at a time you set, and tuned to a channel or input of your preference or photo frame mode. Before setting this function, make sure you set the correct current Time.</p> <p>Current Time Set the current time manually. This can be set from Initial Setup or Clock/Timers. Adjust the Current Time for Daylight Saving Time.</p>
	 <ul style="list-style-type: none"> This TV does not have a battery powered backup for the clock. Therefore, if there is a power failure or if you disconnect the power cord, be sure to reset the current date and time.
Initial Setup	If you miss the Initial Setup when you first connected the TV or if you want to scan all receivable channels, select Initial Setup . Follow the instructions on the screen. Some settings such as Picture, Sound, and Parental Lock will not be affected by this Initial Setup . If you wish to return your TV to factory settings, please see the Troubleshooting section on page 57.
Language	Select to display all on-screen settings in your language of choice: English, Español, Français.
Startup Logo	Select On to display the logo when the TV is turned on. Select Off to disable it.
AV Setup	<p>Manage Inputs Assigns name to external equipment. Select Auto to display names when the equipment is connected and/or the signal of the equipment is ready to be shown, or Always to display regardless of connection status or Off to disable input (only for TV).</p> <p>Video/Component Selection Select Auto to have the TV detect and switch between the Video or Component when Video or Component is connected.</p>



- Favorite channel list will be cleared each time you run the **Initial Setup**.
- You can assign following labels for each input (except TV):
-, Cable, Satellite, VCR, DVD/BD, Home Theater, Game, Camcorder, Digital Camera, PC, Edit
- “-” indicates that no labels are assigned.
- If you select **Edit**, you can edit video labels. Follow the same steps for **Edit Channel Labels** on page 41.

Option	Description
BRAVIA Sync Settings	Communicates with equipment compatible with the BRAVIA Sync Control function.
BRAVIA Sync Control	Links the operations of the TV and the equipment. For specific Sony equipment compatible with BRAVIA Sync Control , this setting is applied automatically to the connected equipment when set to On .
Device Auto Power Off	Select On to have your connected equipment with BRAVIA Sync Control function power off automatically when the TV is turned off. Select Off to disable this function. This feature is available when BRAVIA Sync Control is On .
TV Auto Power On	Select On to control your TV's power on from your connected equipment (except MHL-compatible device) with BRAVIA Sync Control function. Select Off to disable this function. This feature is available when BRAVIA Sync Control is On .
Auto Input Change(MHL)	Select On to switch the TV input to the corresponding device connected with an MHL cable.
BRAVIA Sync Device List	Displays a list of equipment with BRAVIA Sync Control function connected to the TV.
Device Control Keys	Select button functions of the TV's remote control to operate the connected equipment. <ul style="list-style-type: none"> None Deactivates the control by the TV's remote control. Normal Enables basic operations, such as navigation buttons (up, down, left or right, etc.). Tuning Keys For basic operations and operation of channel-related buttons, such as CH +/- or 0-9, etc. Useful when you control a tuner or set-top box, etc; via the remote control. Menu Keys For basic operations and operation of the HOME/OPTIONS buttons. Useful when you select menus of a BD player, etc; via the remote control. Tuning and Menu Keys For basic operations and operation of channel-related buttons and HOME/OPTIONS buttons.
	<ul style="list-style-type: none"> • Press OPTIONS while the equipment supporting BRAVIA Sync Control is connected to display the Device Control options. The Device Control option provides access to the Home (Menu), Options and Content List of your connected equipment with your TV remote control. • Some equipment with BRAVIA Sync Control does not support the Device Control feature. • BRAVIA Sync Settings must be setup on the connected equipment.
Picture Adjustments Lock	Select Lock so no adjustment can be made to items grayed out, except Picture Mode and CineMotion . Select Unlock to allow adjustment to any of the Picture settings.

Option	Description
Software Update	Updates the TV system using USB memory or through Network. Select USB or Network to update.
Automatic Software Download	Select On to download the software automatically. Select Off to disable it.
Product Support	<p>Contact Sony Sony contact information is available on this screen for your convenience. TV specific information such as Model Name, Serial Number, Software Version and downloadable ratings (if available from the TV) are displayed here.</p> <p>Signal Diagnostics Press to display the diagnostics information for the current signal.</p> <p>Initialize Personal Information You can erase your personal information stored in the TV.</p>



Using the Eco Settings

Option	Description
Reset	Resets the current Eco settings to the default values.
Power Saving	<p>Select from Off, Low, High, Picture Off to adjust your TV's power consumption. By selecting the High option, you will reduce the power consumption more than the other available settings.</p> <p>While Picture Off is set, pressing VOL +/- or MUTING buttons will not disable this function. Press other buttons to disable it.</p>
Idle TV Standby	Select to automatically power off the TV after 1h , 2h , or 4h when no buttons are pressed on the remote control or the TV. Select Off to disable this function. This setting is not available if Internet Contents , Applications or Internet Browser are running.
Auto Shut Off	Select On to automatically power off the TV when no input signal is detected for a certain period of time. Select Off to disable this function.

PC Input Signal Reference Chart for HDMI/MHL IN

After connecting the PC to the TV, set the output signal from the PC according to the chart below.

Resolution				Horizontal frequency (kHz)	Vertical frequency (Hz)	Standard
Signals	Horizontal (Pixel)	x	Vertical (Line)			
VGA	640	x	480	31.5	60	VGA
SVGA	800	x	600	37.9	60	VESA Guidelines
XGA	1,024	x	768	48.4	60	VESA Guidelines
WXGA	1,280	x	768	47.4	60	VESA
	1,280	x	768	47.8	60	VESA
	1,360	x	768	47.7	60	VESA
SXGA	1,280	x	1,024	64.0	60	VESA
HDTV*	1,920	x	1,080	67.5	60	CEA-861*

* The 1080p timing when applied to the HDMI/MHL input will be treated as a video timing and not PC timing. This affects **Picture** settings and **Wide Mode** settings. To view PC content set **Wide Mode** to **Full**, and **Display Area** to **Full Pixel**.



- This TV's HDMI input does not support Sync on Green or Composite Sync.
- Your PC must support one of the above PC input signals to display on the television.
- In plug and play, signals with a 60 Hz vertical frequency will be detected automatically. (PC reboot may be necessary.)

Using a Wall-Mount Bracket

This TV's instruction manual only shows the steps on preparing the installation of the TV before installing to the wall.

Your TV can be mounted on a wall using a Wall-Mount Bracket (not supplied) out of the box as packaged. If the Table-Top Stand is attached to the TV, the TV may require detaching the Table-Top Stand.

Prepare the TV for the Wall-Mount Bracket before making cable connections.

Sony does not supply the Wall-Mount Bracket or the installing service. For product protection and safety reasons, Sony strongly recommends that installing of your TV on the wall be performed by qualified professionals. Do not attempt to install it yourself.

- Follow the instruction guide provided with the Wall-Mount Bracket for your model. Sufficient expertise is required in installing this TV, especially to determine the strength of the wall for withstanding the TV's weight.
- The length of the screw for Wall-Mount Bracket differs depending on the mounting hook thickness. Please see below illustration.

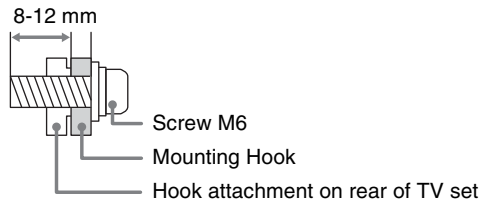

- Be sure to store the unused screws and Table-Top Stand in a safe place until you are ready to attach the Table-Top Stand. Keep the screws away from small children.



- Read the supplied Safety Booklet for additional safety information.

Troubleshooting

Many of the poor pictures and poor sound conditions are related to improper connection of the cables; refer to the Quick Setup Guide provided for connections.

If you have questions, service needs, or require technical assistance related to the use of your Sony TV even after you read this operating instructions manual, contact the following:

For US Support:

<http://www.sony.com/tvsupport> or call 1-800-222-SONY (7669)

For Canadian Support:

<http://www.sony.ca/support> or call 1-877-899-SONY (7669)

■ Things to consider

- Check the input selection by pressing the **INPUT** button. You may be watching the wrong input.
- If you cannot hear sound from the TV, you may have accidentally pressed the **MUTING** button on your remote control; press the **MUTING** button again or press **VOL +** to deactivate muting.
- If the remote control is not functioning properly, the batteries may be installed incorrectly or may be low or an object or light may be interfering with the remote control.
- To reset the TV to factory default settings:
 - 1 Turn on the TV.
 - 2 Press and hold down the **▲** button on the remote, press the **I/⏻** button on the TV set. (The TV will turn itself off, then back on again.)
 - 3 Release the **▲** button when the TV is turned on.

IMPORTANT: The factory reset will clear all of your customized settings including the **Parental Lock** setting.

When the Password is lost or cannot be remembered, enter the master password: 4357. This password clears your previous password and allows you to enter a new password.

Condition	Explanation/Solution
No picture	<ul style="list-style-type: none">• Check the Power Saving settings (see page 49).
Cannot receive any channels	<ul style="list-style-type: none">• Make sure the power cord is connected securely.• Turn on the power of the TV.• Check cable/antenna connections.• Make sure the Signal Type setting is correct for your TV signal source.



Condition	Explanation/Solution
TV is locked to one channel	<ul style="list-style-type: none"> Perform Auto Program to add receivable channels that are not present in the TV's memory (see pages 17 and 41).
Cannot receive or select channels	<ul style="list-style-type: none"> Perform Auto Program to add receivable channels that are not present in the TV's memory (see pages 17 and 41). To receive or select cable channels, make sure that Signal Type in the Channel settings is set to Cable (see page 41). To receive or select UHF channels over an antenna, make sure Signal Type is set to Antenna.
The TV turns off automatically	<ul style="list-style-type: none"> Check if Sleep Timer is activated (see page 47). Check Idle TV Standby in the Eco settings.
No picture from some video sources	<ul style="list-style-type: none"> Check the connection between the optional video equipment and the TV. Press INPUT on the remote control.
Poor picture	
Picture quality not as good as viewed at the store	<ul style="list-style-type: none"> Picture quality depends on the signal content. See Quick Setup Guide (supplied) to display the best possible picture for that signal.
Broadcast HD formats have poor quality	<ul style="list-style-type: none"> Content and signal quality are controlled by the signal provider. Many HD channels and content are actually upscaled versions of standard-definition broadcasts. The picture is affected by the quality of the signal received, which varies between channel and program.
Double images or ghosts	<ul style="list-style-type: none"> Check cable/antenna connections. Check the antenna location and direction.
Only snow and noise appear on the screen	<ul style="list-style-type: none"> Check if the antenna is broken or bent. Check if the antenna has reached the end of its serviceable life. (3-5 years in normal use, 1-2 years at the seaside.)
Dotted lines or stripes	<ul style="list-style-type: none"> Keep the TV away from noise sources such as cars, motorcycles, or hair-dryers. If using 300 ohm twin lead, move the excess lead away from the TV or try using 75-ohm coaxial cable instead.
No color / Dark picture / Color is not correct / The picture is too bright	<ul style="list-style-type: none"> Adjust the Picture Mode options in the Picture settings (see page 36). If you set the Power Saving mode to Low or High, it will enhance the black level.
Noisy picture	<ul style="list-style-type: none"> Make sure that the antenna is connected using a 75-ohm coaxial cable (not supplied). Keep the antenna cable away from other connecting cords. To avoid TV interference, make sure to use an undamaged antenna cable.
Blurry picture / Poor color	<ul style="list-style-type: none"> Transporting the TV from a cold to a warm location or a sudden change in room temperature may cause moisture condensation, resulting in a blurry picture or poor color. Turn off your TV and wait a few hours before powering on again.

Condition	Explanation/Solution
No sound / Noisy sound	
No sound but good picture	<ul style="list-style-type: none"> • Check the volume control. • Press MUTING or VOL + so that "Muting" disappears from the screen (see page 20). • Set Speakers to TV Speakers in the Sound settings (see page 38). If it is set to Audio System, sound is not output from the TV's speakers regardless of the TV's volume control. • When using HDMI input with Super Audio CD or DVD-Audio, DIGITAL AUDIO OUT (OPTICAL) may not provide an audio signal. • When tuned to a digital channel with Alternate Audio, the broadcaster may not be broadcasting your preferred Alternate Audio language. Press OPTIONS, highlight and select Alternate Audio, and change the Alternate Audio language (see page 38).
Audio noise	<ul style="list-style-type: none"> • Make sure that the antenna is connected using a 75-ohm coaxial cable (not supplied). • Keep the antenna cable away from other connecting cords. • To avoid TV interference, make sure to use an undamaged antenna cable.
No audio or low audio with Home Theater System	<ul style="list-style-type: none"> • Set Speakers to Audio System in the Sound settings (see page 38). • Set Audio Out to Fixed in the Sound settings (see page 39).
No color / Irregular picture	<ul style="list-style-type: none"> • Verify that the Video/Component Selection (see page 47) is set to the current input type in use. We suggest leaving this setting to Auto.
BRAVIA Sync	
Cannot find connected BRAVIA Sync HDMI/MHL device	<ul style="list-style-type: none"> • Make sure that the BRAVIA Sync Control is set up on both the TV and the optional device compatible with BRAVIA Sync.
Second A/V receiver is not listed on the BRAVIA Sync Device List	<ul style="list-style-type: none"> • Only one A/V receiver may be used with the BRAVIA Sync and BRAVIA Sync Control functions at one time (see page 48).
PC connection	
No picture / No signal	<ul style="list-style-type: none"> • Confirm the PC is correctly connected to the TV with the HDMI IN. • Ensure the output signal from the PC is one of the formats listed on page 50. • Turn the PC off. Confirm the PC connection and restart the PC. Plug-and-play will auto-detect the TV and correctly set up PC timing. • Verify the PC is not in standby or hibernation mode.
Poor Picture	<ul style="list-style-type: none"> • Adjust the resolution (see page 50).

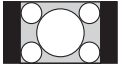
Condition	Explanation/Solution
Applications	
Apps are inaccessible	<ul style="list-style-type: none"> • Check that the LAN cable or AC power cord of the router/modem* has been connected properly. * Your router/modem must be set in advance to connect to the Internet. Contact your Internet service provider for router/modem settings. • Try using apps later. The app content provider's server may be out of service.
General	
TV screen feels warm	<ul style="list-style-type: none"> • Due to the thin profile of this television, the heat generated by the LCD panel backlight and supporting electronics will be more noticeable. This is normal operation and not a cause for concern.
One or more promotional logo(s) appears (appear) on the screen. (Demo Mode)	<ul style="list-style-type: none"> • Press RETURN on the remote control to suspend Demo Mode. Then, press HOME, select Settings and proceed with Initial Setup in the Setup settings. Be sure to select Home on the viewing environment (Location) step.
Wide Mode changes automatically	<ul style="list-style-type: none"> • The current Wide Mode setting is automatically replaced with the 4:3 Default setting when you change the channel or video input, if 4:3 Default in the Screen settings is set to other than Off. If you want to lock in Wide Mode selected with WIDE on the remote control, set 4:3 Default to Off in the Screen settings (see page 39). • Check the Auto Wide option in the Screen settings (see page 39).
Suddenly the picture gets smaller 	<ul style="list-style-type: none"> • The picture gets smaller during the commercials due to the method in which the provider broadcasts their content. When HD content channels switch to SD content (commercials), the picture may be small with a black border. • Auto Wide will not expand the picture during these content changes since the content information is regulated by the channel signal provider. You can manually change the Wide Mode if you prefer (see page 24). This setting will remain in effect until you change the channel or input or manually change the Wide Mode again.
"Black box" on screen	<ul style="list-style-type: none"> • You have selected a text option and no text is available (see page 46). To turn off this feature, set the CC Display option to Off. If you were trying to select closed captioning, select CC1 instead of Text1-4.

Condition	Explanation/Solution
<p>Black bands appear at the edges of the screen</p> 	<ul style="list-style-type: none"> • Some wide screen programs are filmed in aspect ratios that are greater than 16:9 (this is especially common with theatrical releases). Your TV will show these programs with black bands at the top and bottom of the screen. For more details, check the documentation that came with your DVD/Blu-ray (or contact your program provider). • Programs in 4:3 aspect ratio will have bands on left and right sides of the screen. • Programs broadcast in HD formats (720p and 1080i) with 4:3 content will commonly have black bands on the left and right sides of the screen which are added by the broadcaster (see image on left). • Some cable and satellite set-top boxes can also control the size of the picture. If you are using a set-top box, refer to the manufacturer of the set-box for more information. • Auto Wide will not expand the picture when the black bands on the sides of the screen are added by the broadcaster. You can manually change the Wide Mode to Wide Zoom, or Zoom to fill the screen, which will remain in effect until you change the channel or input or manually change the Wide Mode again.
<p>Certain programs on DVD or other digital sources display a loss of detail, especially during fast-motion or dark scenes</p>	<ul style="list-style-type: none"> • This is due to the digital compression of the source content used by certain digital broadcasts and DVDs which may cause your TV's screen to display less detail than usual, or cause artifacts (small blocks or dots, pixelations) to appear on your screen. These signal compressions are more visible and are dependent on the clarity and resolution of the TV.
<p>Remote control does not operate</p>	<ul style="list-style-type: none"> • To determine if the problem is with the remote control or not, press a button on the TV. • Check the polarity of the batteries or replace the batteries. • Point the remote control at the remote control sensor located at the front of the TV. • Keep the remote control sensor area clear from obstacles. • Fluorescent lamps can interfere with your remote control operation; try turning off the fluorescent lamps.
<p>Some digital cable channels are not being displayed</p>	<ul style="list-style-type: none"> • Certain cable companies have limitations on the broadcast of digital cable channels. Check with your cable company for more information. • The digital cable channel may be set to Hidden in the Show/Hide Channels setting (see page 41).
<p>Some photo, music, or video files are not displaying from my USB equipment</p>	<ul style="list-style-type: none"> • The accessible file or folder limit in a directory is 1,000 for USB connected equipment. This limit includes non-supported files or just folders. Files or folders are populated based on their time stamps. Photo, music files or folders exceeding the limit will not be displayed.
<p>TV does not output picture and/or sound from the MHL device</p>	<ul style="list-style-type: none"> • Disconnect the MHL cable, then reconnect it, or power the MHL device off then on again and release its lock.

Condition	Explanation/Solution
Photo images appear small in the screen	<ul style="list-style-type: none"> • Set display size to expanded. • Whether photo images can be displayed in full screen or not depends on the resolution or aspect ratio of the file.
Photo images or folders take time to display	<ul style="list-style-type: none"> • Depending on the image dimension, file size, and number of files in a folder, some photo images or folders take time to display. • The first time a camera is connected to the TV via USB cable, it may take up to a couple of minutes for the photos to display.
Lost password	<ul style="list-style-type: none"> • Select the Password settings on the Parental Lock settings, then enter the following master password: 4357. This password clears your previous password and allows you to enter a new password (see page 41).
How to reset the TV to factory settings	<ul style="list-style-type: none"> • Turn on the TV. While holding down ▲ on the remote control, press ⏻ on the TV. (The TV will turn itself off, then back on again.) Release ▲. IMPORTANT: The reset will clear all of your customized settings including the Parental Lock setting.
Sometimes video streaming quality is poor when using the wireless LAN	<ul style="list-style-type: none"> • The wireless network connection quality varies depending on the distance or obstacles (e.g. wall) between the TV and the wireless router (access point), environment interference, and quality of the wireless router (access point).
Wireless LAN connection fails or radio reception conditions are poor	<ul style="list-style-type: none"> • Check the installation location of the TV and wireless router (access point). Signal condition may be affected for the following reasons. <ul style="list-style-type: none"> - Other wireless devices, microwaves, fluorescent lights, etc., are placed nearby. - There are floors or walls between the wireless router (access point) and TV. If the problem persists even after checking the above, try making a wired LAN connection.
Poor picture on Internet Video	<ul style="list-style-type: none"> • Quality depends on the original video provided by the video content provider and your connection bandwidth.
Small picture on Internet Video	<ul style="list-style-type: none"> • Use the color buttons to zoom in and out.
Certain Internet video content displays a loss of detail, especially during fast-motion or dark scenes	<ul style="list-style-type: none"> • Video quality and picture size depend on broadband speed and delivery by content providers.
Good picture quality but no sound on the Internet video content	<ul style="list-style-type: none"> • Quality depends on the original content provided by the video content provider and your connection bandwidth. • Due to the nature of Internet video, not all videos will contain sound.
You do not see many videos in the Internet Video Guide	<ul style="list-style-type: none"> • Press OPTIONS and select categories to view more content. • Check the Parental Lock ratings on the TV; some Internet content may be blocked based on the rating.

Condition	Explanation/Solution
Your TV cannot connect to the server	<ul style="list-style-type: none"> • Check the LAN cable or connection to your server and your TV. • Check if your network is properly configured on your TV.
A message appears starting that the TV cannot connect to your network	<ul style="list-style-type: none"> • Check the current network settings. Press HOME, then select Settings > Setup > Network > Network Setup > View Network settings and status. If all of your network settings are “-”, your server may not be connected properly. Check your network connections and/or server’s instruction manual for connection information. • Reconfigure your network settings. • If the LAN cable is connected to an active server and the TV has acquired an IP address, check your DLNA Certified™ media server’s connections and configurations.  <ul style="list-style-type: none"> • Your IP address configuration can be viewed by selecting the View Network settings and status option.
DLNA Certified™ media server is inaccessible although it is listed under  [Media] in the Home Menu	<ul style="list-style-type: none"> • Check your LAN cable/connection or your server connections. The TV may have lost connection with the server. • Perform Media Server Troubleshooting to check if your media server is properly communicating with the TV. Press HOME, then select Settings > Setup > Network > Home Network Setup > Media Server Troubleshooting.
Some photos, music, video files in the connected USB device or DLNA Certified™ media server are not displayed	<ul style="list-style-type: none"> • Unsupported files may not be displayed. • The accessible file or folder limit in a directory is 1,000 for USB and a DLNA Certified™ media server. This limit includes non-supported files or just folders. Files or folders are populated based on their timestamps. Photo, music files or folders exceeding the limit will not be displayed.
When using the renderer function, music files cannot be played back	<ul style="list-style-type: none"> • Some applications display a photo file pre-installed in the PC simultaneously with music playback when using the renderer function. Depending on the pre-installed photo file, music playback may not be possible, but may become possible by changing the photo file.
The TV surrounds become warm.	<ul style="list-style-type: none"> • When the TV is used for an extended period, the TV surrounds become warm. You may feel hot when touching there by the hand.

Important Notices

Declaration of Conformity

Trade Name: SONY
Model: KDL-60R510A
Responsible Party: Sony Electronics Inc.
Address: 16530 Via Esprillo,
San Diego, CA 92127 U.S.A.
Telephone Number: 858-942-2230

This device complies with part 15 of the FCC rules. Operation is subject to the following two conditions: (1) This device may not cause harmful interference, and (2) this device must accept any interference received, including interference that may cause undesired operation.

FCC Related Information

This equipment has been tested and found to comply with the limits for a Class B digital device, pursuant to Part 15 of the FCC Rules. These limits are designed to provide reasonable protection against harmful interference in a residential installation. This equipment generates, uses and can radiate radio frequency energy and, if not installed and used in accordance with the instructions, may cause harmful interference to radio communications. However, there is no guarantee that interference will not occur in a particular installation. If this equipment does cause harmful interference to radio or television reception, which can be determined by turning the equipment off and on, the user is encouraged to try to correct the interference by one or more of the following measures:

- Reorient or relocate the receiving antenna.
- Increase the separation between the equipment and receiver.
- Connect the equipment into an outlet on a circuit different from that to which the receiver is connected.
- Consult the dealer or an experienced radio/TV technician for help.

Pursuant to FCC regulations, you are cautioned that any changes or modifications not expressly approved in this manual could void your authority to operate this equipment.

Safety and Regulatory

This device complies with Industry Canada licence-exempt RSS standard (s). Operation is subject to the following two conditions: (1) this device may not cause interference, and (2) this device must accept any interference, including interference that may cause undesired operation of the device.

This equipment complies with FCC/IC radiation exposure limits set forth for uncontrolled equipment and meets the FCC radio frequency (RF) Exposure Guidelines in Supplement C to OET65 and RSS-102 of the IC radio frequency (RF) Exposure rules. This equipment has very low levels of RF energy that it deemed to comply without maximum permissive exposure evaluation (MPE). But it is desirable that it should be installed and operated with at least 20 cm and more between the radiator and person's body (excluding extremities: hands, wrists, feet and ankles).

This device and its antenna(s) must not be co-located or operating with any other antenna or transmitter except Grant condition.

Note

This television includes a QAM demodulator which should allow you to receive unscrambled digital cable television programming via subscription service to a cable service provider. Availability of digital cable television programming in your area depends on the type of programming and signal provided by your cable service provider.

Specifications

System	
Television system	NTSC: American TV standard ATSC (8VSB terrestrial): ATSC compliant 8VSB QAM on cable: ANSI/SCTE 07 2000 (Does not include CableCARD functionality)
Channel coverage	Analog terrestrial: 2 - 69 / Digital terrestrial: 2 - 69 Analog Cable: 1 - 135 / Digital Cable: 1 - 135
Panel system	LCD (Liquid Crystal Display) Panel (LED backlight)
Speaker output	10 W + 10 W
Input/Output jacks	
CABLE/ANTENNA	75-ohm external terminal for RF inputs
VIDEO IN	VIDEO: 1 Vp-p, 75 ohms unbalanced, sync negative AUDIO: 500 mVrms (Typical) / Impedance: 47 kilohms
COMPONENT IN	YPbPr (Component Video): Y: 1.0 Vp-p, 75 ohms unbalanced, sync negative / PB: 0.7 Vp-p, 75 ohms PR: 0.7 Vp-p, 75 ohms / Signal format: 480i, 480p, 720p, 1080i, 1080p AUDIO: 500 mVrms (Typical) / Impedance: 47 kilohms
HDMI IN 1 (ARC) HDMI IN 2/MHL HDMI IN 3	HDMI: Video: 480i, 480p, 720p, 1080i, 1080p, 1080/24p MHL: Video: 480i, 480p, 720p, 720/30p, 1080i, 1080/30p, 1080/24p Audio: Two channel linear PCM 32, 44.1 and 48 kHz, 16, 20 and 24bits, Dolby Digital PC Input (see page 50)
AUDIO OUT	500 mVrms (typical)
DIGITAL AUDIO OUT (OPTICAL)	PCM/Dolby Digital optical signal
USB	Compliant with USB mass storage e.g. digital camera or USB memory.
DLNA	DLNA Certified™ codec is the same as USB. (Some DLNA Certified™ servers may not be able to play back.)
LAN	10BASE-T/100BASE-TX connector (Depending on the operating environment of the network, connection speed may differ. 10BASE-T/100BASE-TX communication rate and communication quality are not guaranteed for this TV.)

Model name KDL-	60R510A
Power and others	
Power requirement	110-240 V AC, 50/60 Hz (U.S.A./Canada 120 V AC, 60 Hz)
Power consumption in use	175 W
in standby	Less than 0.3 W with 120 V AC and with 240 V AC less than 0.3 W
Screen size* (measured diagonally) (inches)	60
(cm)	152.5
Display resolution	1,920 dots (horizontal) × 1,080 lines (vertical)
Speaker/Full range (2) (mm) (inches)	48 × 148 (1 15/16 × 5 7/8)
Dimensions* with Table-Top Stand (mm) (inches)	1,357 × 838 × 259 53 1/2 × 33 × 10 1/4
without Table-Top Stand (mm) (inches)	1,357 × 799 × 86 53 1/2 × 31 1/2 × 3 1/2
wall-mount hole pattern (mm)	400 × 300
wall-mount screw size (mm)	M6 (length: refer to diagram on page 51)
Mass* with Table-Top Stand (kg) (lb.)	20.1 44.3
without Table-Top Stand (kg) (lb.)	19.1 42.1
Supplied accessories common to all models	Remote control RM-YD096 (1)/Size AAA batteries (2)/Operating Instructions (2)/Quick Setup Guide (2)/Warranty Card (1)/Safety and Regulatory Booklet (1)/Software License (2)/Stand installation guide (1)/Table-Top Stand (1 set)/Screw (4)
Optional accessories	Connecting cables

- Optional accessories availability depends on its stock.
- Design and specifications are subject to change without notice.
- * Dimensions and mass are approximate values.

Index

I/⏻ button 22
0-9 buttons 20
4:3 Default 39

A

Add Digital Channels 41
Advanced Settings 37
Alternate Audio 38
Analog Fine Tune 41
Applications 34
Audio Description 46
AUDIO OUT 9
Audio Out 39
Auto Display Area 39
Auto Program 17, 41
Auto Shut Off 49
Auto Wide 39
Automatic Software Download 49
AV Setup 47

B

Backlight 36
Balance 38
BRAVIA Sync Settings 48
Brightness 37

C

CABLE/ANTENNA 9
CC/SUBTITLE button 21
CH +/- button 21
CH/INPUT button 22
Change Password 41
Channel Block 42
CineMotion 37
Clear Voice 38
Clock/Timers 47
Closed Captions (CC) 46
Color 37
Color Temperature 37
Colored buttons 19
COMPONENT IN 8
Country 42

D

Digital Audio Out 39
DIGITAL AUDIO OUT (OPTICAL)
9
Display Area 40
DISPLAY button 20
Downloadable U.S. Rating 42

E

Edit Channel Labels 41
English Rating 43
Equalizer 38
Equipment Control button 19
External Input Block 42

F

Favorites 24
French Rating 44

H

HDMI IN 8
HOME button 20
Horizontal Center 40
Hue 37

I

Idle TV Standby 49
Info Banner 47
Initial Setup 47
INPUT button 19
Installing the TV on a wall 51
Internet Browser 33

J

JUMP button 21

L

LAN 9
Language 47
LED indicator 22

M

Motionflow 37
Movie Rating 43
MPEG Noise Reduction 37
MTS Audio 38
Music 25
MUTING button 20

N

Netflix 34
NETFLIX button 21
Network 44
Noise Reduction 37

O

OPTIONS button 21

P

PAP 23
Password 41
PC Settings 40
Photo 25
Photo Frame 28
PHOTO FRAME button 20
Photo Frame Settings 45
PIC OFF button 19
Picture 36
Picture Adjustments Lock 48
Picture Mode 36
PIP 23
POWER button 20

Power Saving 49
Product Support 49

R

Rating 42
Reset 36, 38, 49, 57
RETURN button 20

S

SEN button 21
Settings
Channel 41
Eco 49
Parental Lock 41
Picture 36
Screen 39
Setup 44
Sound 38
Sharpness 37
Show/Hide Channels 41
Signal Type 41
SLEEP button 20
Software Update 49
Sony Entertainment Network 33
Sound Booster 38
Sound Mode 38
Speakers 38
Startup Logo 47
Steady Sound 38
SYNC MENU button 21

T

Troubleshooting 52–58
TV Rating 43

U

U.S.A. Rating 44
Unrated 42
USB 9
USB Auto Start 45

V

Vertical Center 40
Video 25
VIDEO IN 8
Viewing Blocked Programs 44
VOL (↔) +/- button 20, 22
Volume Offset 38

W

WIDE button 19
Wide Mode 39

Y

YouTube Leanback 34

For Your Convenience

Online Registration:

Be sure to register your TV.

United States <http://productregistration.sony.com>

Canada <http://www.sony.ca/registration>

Software Updates:

Your TV is capable of receiving software updates. For the latest information about software updates for your TV, visit:

United States <http://www.sony.com/tvsupport>

Canada <http://www.sony.ca/support>

NOTE: If your TV is connected to the Internet, you can check for software updates by selecting **Settings**, **Setup** and then **Software Update**.

Free Manuals Download Website

<http://myh66.com>

<http://usermanuals.us>

<http://www.somanuals.com>

<http://www.4manuals.cc>

<http://www.manual-lib.com>

<http://www.404manual.com>

<http://www.luxmanual.com>

<http://aubethermostatmanual.com>

Golf course search by state

<http://golfingnear.com>

Email search by domain

<http://emailbydomain.com>

Auto manuals search

<http://auto.somanuals.com>

TV manuals search

<http://tv.somanuals.com>