

**SONY**<sup>®</sup>

4-082-171-31(1)



# ***100 Hz WIDE Projection TV***

---

***Instruction Manual***

**GB**

## ***KP-44PS2U***

© 2001 by Sony Corporation

## NOTICE FOR CUSTOMERS IN THE UNITED KINGDOM

A moulded plug complying with BS1363 is fitted to this equipment for your safety and convenience.

Should the fuse in the plug supplied need to be replaced, a 5 AMP fuse approved by ASTA or BSI to BS 1362 (i.e. marked with  $\diamond$  or  $\heartsuit$  must be used.

When an alternative type of plug is used it should be fitted with a 5 AMP FUSE, otherwise the circuit should be protected by a 5 AMP FUSE at the distribution board.

If the plug supplied with this equipment has a detachable fuse cover, be sure to attach the fuse cover after you change the fuse. Never use the plug without the fuse cover. If you should lose the fuse cover, please contact your nearest Sony service centre.

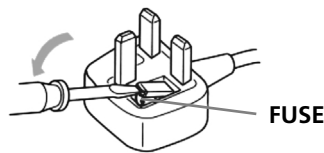

### How to replace the fuse

Open the fuse compartment with a blade screwdriver, and replace the fuse.

#### • **IMPORTANT**

If the plug supplied is not suitable for the socket outlets in your home, it should be cut off and an appropriate plug fitted in accordance with the following instructions:

The wires in this mains lead are coloured in accordance with the following code:

Blue        Neutral

Brown      Live

As the colours of the wires in the mains lead of this apparatus may not correspond with the coloured markings identifying the terminals in your plug, proceed as follows:

The wire which is coloured blue must be connected to the terminal which is marked with the letter N or coloured black. The wire which is coloured brown must be connected to the terminal which is marked with the letter L or coloured red. Do not connect either wire to the earth terminal in the plug which is marked by the letter E or by the safety earth symbol  $\perp$  or coloured green or green and yellow.





#### **WARNING**

- To prevent shock hazard, do not insert the plug cut off from the mains lead into a socket outlet. This plug cannot be used and should be destroyed.
- To prevent fire or shock hazard, do not expose the unit to rain or moisture.
- Dangerously high voltages are present inside the set. Do not open the cabinet. Refer servicing to qualified personnel only.

# Introduction

Thank you for choosing this Sony 100 Hz Projection TV model.  
Before operating the set, please read this manual thoroughly and retain it for future reference.





• Symbols used in the manual:

-  Informs you of possible hazards.
-  Important information.
-  Information on a feature.
- **1,2...** Sequence of instructions.
-  Shaded buttons on the remote control show the buttons you have to press to follow the sequence of instructions.
-  Informs you of the result of the instructions.

## Table of Contents

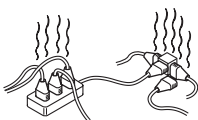
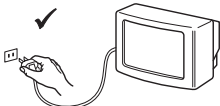
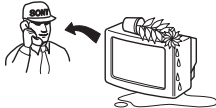
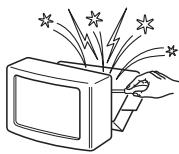
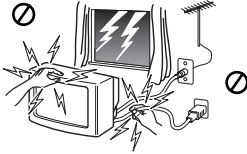
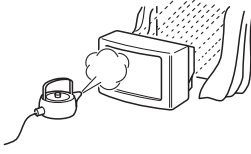
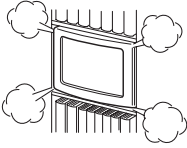
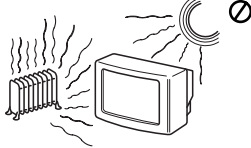
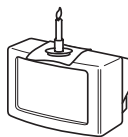
Notice for Customers in the United Kingdom.....	2
Introduction .....	3
Safety Information.....	4
<b>Overview</b>	
Checking the Accessories Supplied.....	5
Overview of TV Buttons .....	5
Overview of Remote Control Buttons.....	6
<b>Installation</b>	
Inserting Batteries into the Remote Control.....	7
Connecting the Aerial and VCR .....	7
<b>First Time Operation</b>	
Switching on the set and Automatically Tuning.....	8
Adjusting Colour Registration (Convergence) .....	9
<b>Menu System</b>	
Changing the Screen Format .....	10
Introducing the Menu System.....	10
Using the Menu System:	
Adjusting the Picture .....	11
Adjusting the Sound .....	12
Using the Features menu.....	14
Manually Tuning the TV .....	15
Labelling a channel .....	16
Skipping programme positions.....	17
Using the "Further Programme Preset" function.....	18
Inputting your personal ID.....	19
Using the Demo Mode.....	20
Adjusting the H Centre picture for an RGB source.....	21
Labelling and Selecting the screen format of Input Sources .....	22
Using Multi PIP (Picture In Picture).....	23
Using PAP (Picture And Picture).....	23
<b>Teletext</b> .....	24
<b>NexTVView</b> .....	26
<b>Optional Connections</b>	
Connecting Optional Equipment.....	28
Using Optional Equipment.....	29
Smartlink .....	30
Remote Control of other Sony Equipment.....	30
<b>Additional Information</b>	
Optimum Viewing Area .....	31
Specifications .....	32
Troubleshooting .....	33
Television Channel Number Guide for United Kingdom .....	34

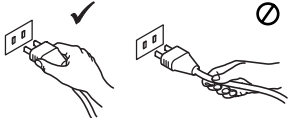
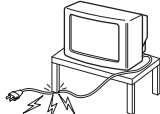
# Safety Information

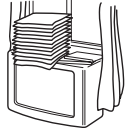
 <p>This set is to operate on a 220-240V AC supply only. Take care not to connect too many appliances to the same power socket as this could result in fire or electric shock.</p>	 <p>For environmental and safety reasons, it is recommended that the TV set is not left in standby mode when not in use. Disconnect from the mains.</p>	 <p>Never push objects of any kind into the set as this could result in a fire or electric shock. Never spill liquid of any kind on the set. If any liquid or solid object does fall through, do not operate the TV. Have it checked immediately by qualified personnel.</p>
 <p>Do not open the cabinet and the rear cover of the TV. Refer to qualified service personnel only.</p>	 <p>For your own safety, do not touch any part of the TV, power lead or aerial lead during lightning storms.</p>	 <p>To prevent fire or shock hazard, do not expose the TV to rain or moisture.</p>
 <p>Do not cover the ventilation openings of the TV. For ventilation, leave a space of at least 10cm all around the set.</p>	 <p>Never place the TV in hot, humid or excessively dusty places. Do not install the TV where it may be exposed to mechanical vibrations.</p>	 <p>To prevent fire, keep inflammable objects or naked lights (eg candles) away from the TV.</p>
 <p>Clean the TV with a soft, lightly dampened cloth. Do not use benzine, thinner or any other chemicals to clean the TV. Do not scratch the TV screen. As a safety precaution, unplug the TV before cleaning it.</p>	 <p>Pull out the power lead by the plug. Do not pull on the power lead itself.</p>	 <p>Take care not to place heavy objects on the power lead as this could result in damage. We recommend you wind any excess lead around the holders provided on the rear of the TV.</p>
 <p>Place the TV on a secure stable stand. Do not allow children to climb on to it. Do not place the TV on its side or face up.</p>	 <p>Unplug the power lead before moving the TV. Avoid uneven surfaces, quick steps or excessive force. If the set has been dropped or damaged, have it checked immediately by qualified service personnel.</p>	 <p>Do not cover the ventilation openings of the TV with items such as curtains or newspapers etc.</p>

## Additional Safety Information

-  After transporting the projection TV directly from a cold to a warm location, or if the room temperature has changed suddenly, pictures may be blurred or show poor colour over portions of the picture. This is because moisture has condensed on the mirrors or lenses inside the projection TV. Let the moisture evaporate before using the projection TV.
- To obtain a clear picture, do not expose the screen to direct illumination or direct sunlight. If possible, use spot lighting directed down from the ceiling.
- Displaying a still picture for long periods of time, for instance, when operating a video game or personal computer and viewing a programme in 16:9 mode, may damage the picture tube. To avoid this, keep the picture contrast level low.
- Avoid touching the screen, and take care not to scratch the surface with hard objects.

## Overview

# Checking the Accessories Supplied



One Remote Control  
(RM-903)



Two batteries (R6 type)

GB

# Overview of TV Buttons

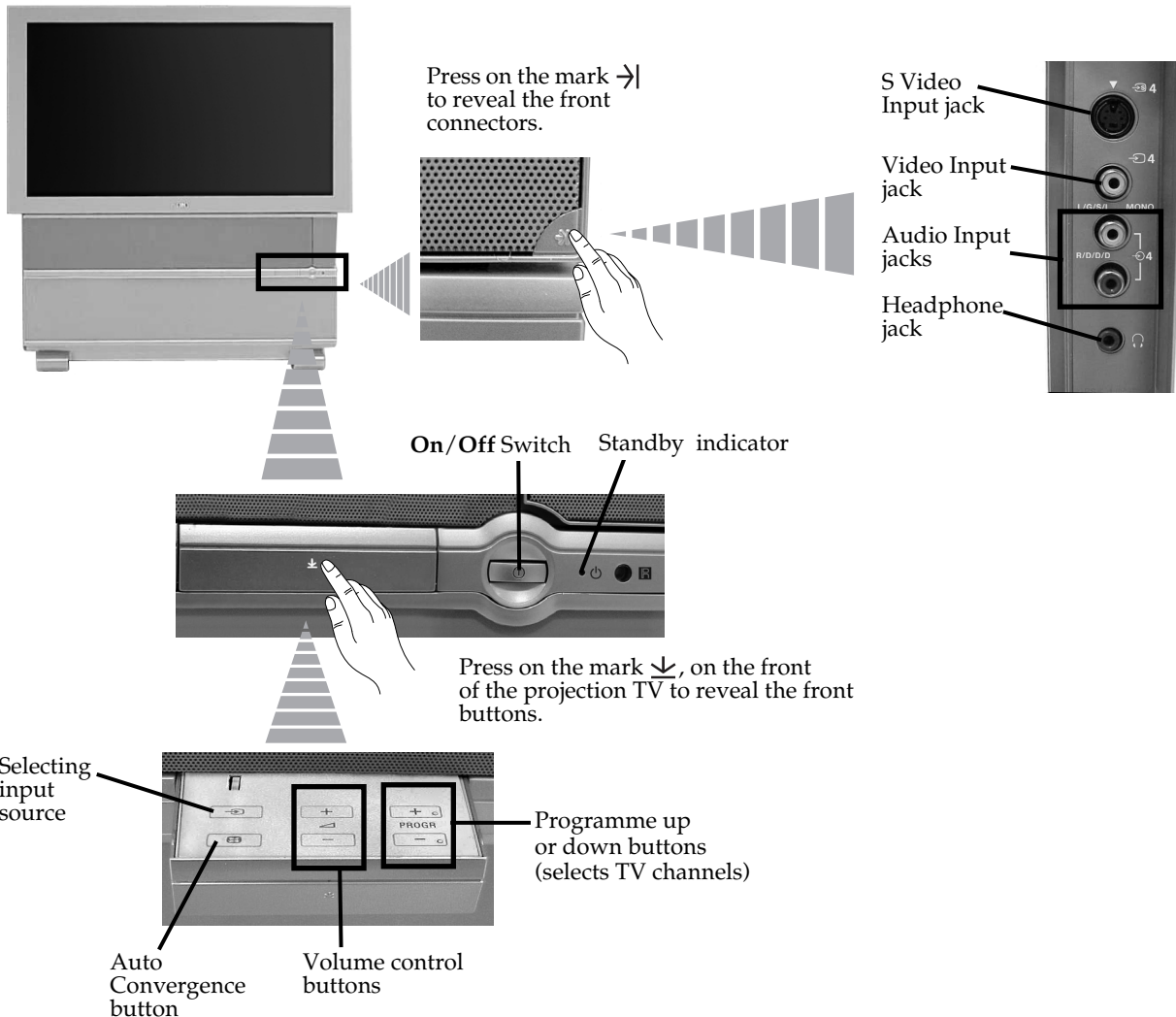

# Overview of Remote Control Buttons

## Resetting to factory set levels

Press the to return the picture and sound settings to factory set levels. This will also return the set to the install condition, the "Auto Tuning" menu will appear on the screen, refer to the section "Switching on the set and automatically Tuning" (step 4) of this manual.



## Displaying the time

Press to switch the time on or off (available only when teletext is broadcast).

## VCR operation

For more details, please refer to the section "Remote Control of other Sony Equipment".

## VCR on/off

Press to switch your VCR on or off.

## Muting the Sound

Press to mute TV sound.  
Press again to restore the sound.

## Selecting TV mode

Press to switch off Teletext or video input.

## PAP (Picture And Picture)

For more details, please refer to the section "Using PAP (Picture And Picture)".

## Selecting Teletext

Press to switch on Teletext.

## Displaying EPG

Press to display the Electronic Programme Guide (EPG). Press again to switch off EPG.

## Freezing the picture

Press to freeze the picture. Press again to return to the normal picture.

## Selecting channels

Press to select channels.

For double-digit programme numbers, e.g. 23, press -/-- first, then the buttons 2 and 3. If you enter an incorrect first digit, this should be corrected by entering another digit (0-9) and then selecting -/-- button again to enter the programme number of your choice.

## Selecting Sound mode

Press repeatedly to change the sound mode.

## Selecting Picture mode

Press repeatedly to change the picture mode.

## Adjusting TV Volume

Press to adjust the volume of the TV.

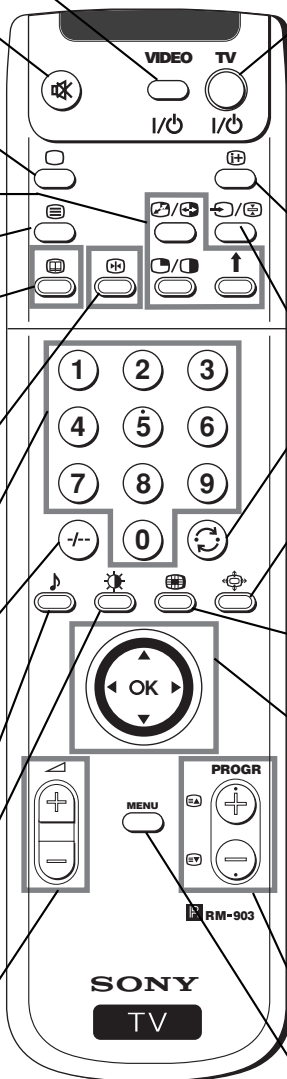

## To Temporarily Switch Off

Press to temporarily switch off TV (the standby indicator on the set lights up in red). Press again to switch on TV from standby mode.

⚠ After 15-30 minutes without a signal and without any button being pressed, the set switches automatically into standby mode.

## Displaying On Screen Information

Press to display all on-screen indications. Press again to cancel.

## Selecting Input source

Press repeatedly until the desired input symbol of the source appears on the screen.

## Back to the channel last watched

Press to watch the last channel selected (watched for at least 5 seconds).

## Selecting Screen format

Press repeatedly to change the format of the screen (for more details, please refer to the section "Changing the Screen format").

## Displaying Multi PIP (Picture In Picture)

Press to display Multi PIP mode. Press again to cancel.

## Joystick for menu selection

- When MENU is switched on:
  - ▲ Scroll Up
  - ▼ Scroll Down
  - ◀ Previous menu or selection
  - ▶ Next menu or selection
  - OK Confirms your selection
- When MENU is switched off:
  - ◀ Return to the last menu screen.
  - OK Shows a channel overview

## Selecting channels

Press to select the next or previous channel.

## Displaying the menu system

Press to display the menu on the screen. Press again to remove the menu display from the screen.

**i** Besides TV functions, all coloured buttons as well as green symbols are also used for Teletext operation. For more details, please refer to the "Teletext" section of this instruction manual.

## Installation

# Inserting Batteries into the Remote Control

-  Make sure you insert the batteries using the correct polarities.  
Always remember to dispose of used batteries in an environmental friendly way.





# Connecting the Aerial and VCR

-  Connecting cables are not supplied.

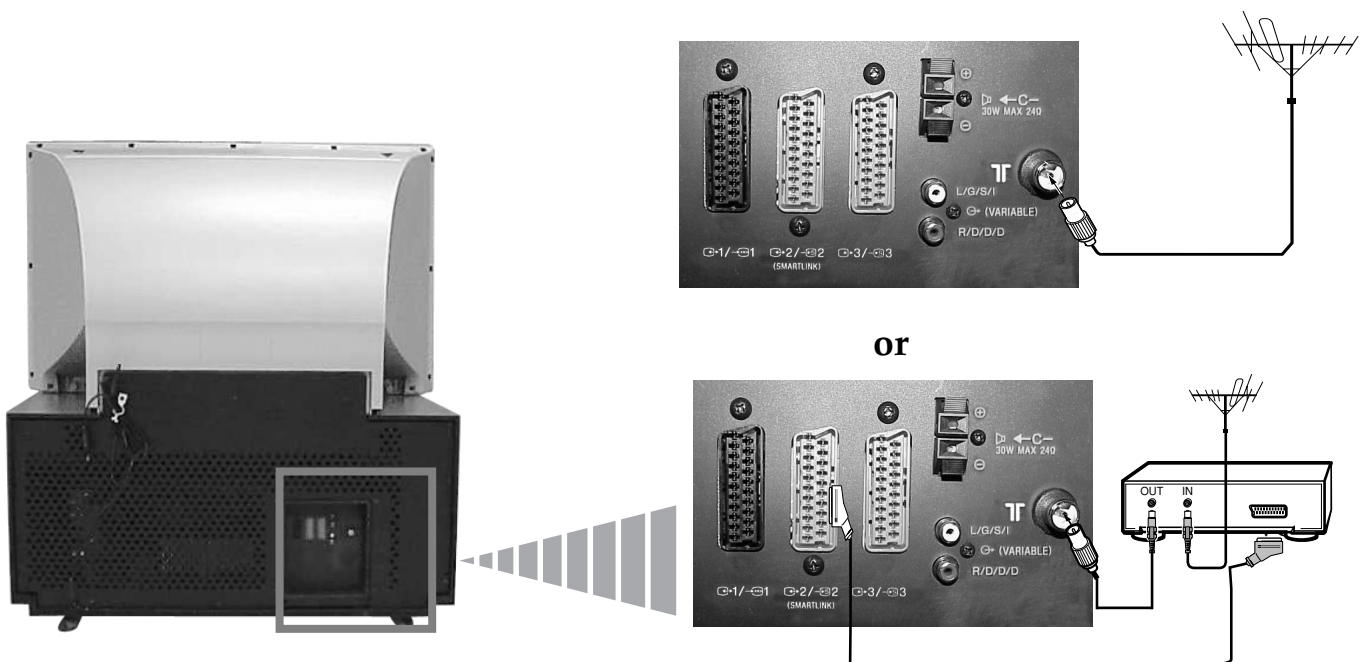
GB



-  The Scart lead is optional.  
If you use this optional connection it can improve picture and sound quality when using a VCR.
-  If you do not use a SCART lead, after automatically tuning the projection TV refer to the "Manually Tuning the TV" section of this instruction manual, to tune in the set to the output of your VCR. Also refer to your VCR instruction manual to find out how to find the output channel of your VCR.

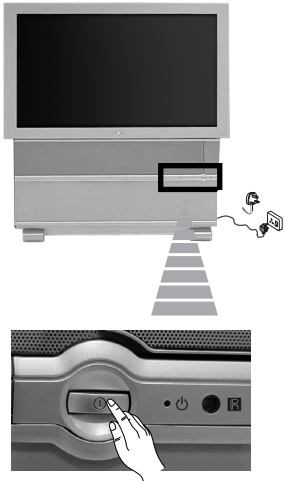

# Switching on the set and Automatically Tuning

**i** The first time you switch on your TV, a sequence of menu screens appear on the TV enabling you to 1) choose the language of the menu screen, 2) choose the country in which you wish to operate the set, 3) search and store all available broadcast channels and 4) change the order in which the broadcast channels appear on the screen. However, if you need to change the language menu, change the country, change or repeat the tuning (e.g. when you move house) or rearrange the order of the broadcast channels, you can do that by selecting the appropriate menu in the  (Set Up).



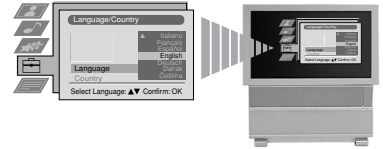

**1** Connect the set plug to the mains socket (220-240V AC, 50 Hz). The first time the TV set is connected, it is usually turned on. If the TV is off, press the  **on/off** button on your set to switch on. The first time you press this button the **Language/Country** menu displays automatically on the screen.

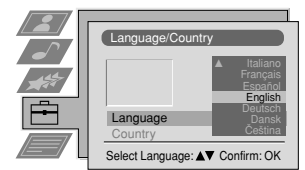

**2** Push the joystick on the remote control  or  to select the language, then press **OK** to confirm your selection. From now on all the menus will appear in the selected language.



**3** Push the joystick  or  to select the country in which you will operate the set, then press **OK** to confirm your selection.

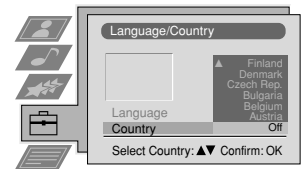

**i** If the country in which you want to use the TV set does not appear in the list, select “-” instead of a country.

**i** If you are operating the projection TV in the UK, we recommend you not to select “Off”. Otherwise the On Screen clock will not show the correct UK time.

**4** The Auto Tuning menu appears on the screen in the selected language, then press the **OK** button on the remote control to select **Yes**.

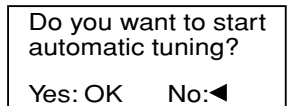

**5** A new menu appears automatically on the screen asking you to check that the aerial is connected. Confirm that the aerial is connected and then press the **OK** button to start the automatic tuning.

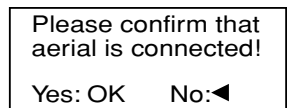

- i** The TV starts to automatically search and store all available broadcast channels for you.
- If you have selected the “Off” option in the Country menu and you activate autotuning again, the TV broadcasts channels will be stored from the programme number selected at that time.

**⚠** This procedure could take some minutes. Please, be patient and do not press any button, otherwise the automatic tuning will not be completed.

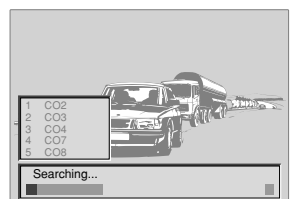

continued...



## First Time Operation

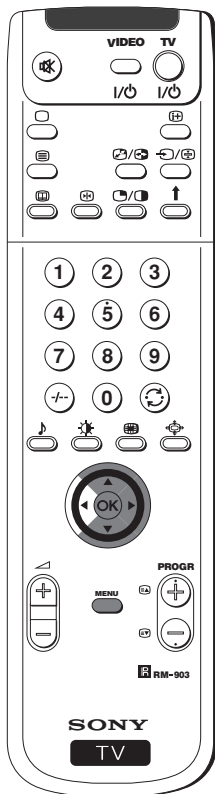

**6** After all available channels are captured and stored, the Programme Sorting menu appears automatically on the screen enabling you to change the order in which the channels appear on the screen.

a) If you do not wish to change the broadcast channel order, go to step 7.

b) If you wish to change the channel order:

**1** Push the joystick on the remote control or to select the programme number with the broadcast channel you wish to rearrange, then push to enter.

**2** Push the joystick or to select the new programme number position for your selected broadcast channel, then press **OK**.

The selected channel now moves to its new programme position and the other broadcast channels move accordingly.

**3** Repeat steps b1) and b2) if you wish to change the order of the other broadcast channels.

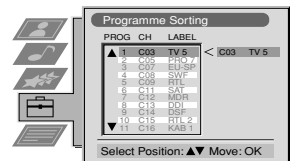
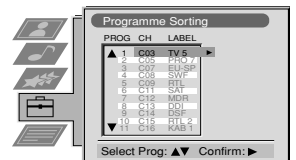

**7** Press the **MENU** button to exit and return to the normal TV screen.

The set is now ready for use.

GB

## Adjusting Colour Registration (Convergence)

Due to the earth's magnetism, the picture might become undefined and you could see different colours on the outlines of the images. In that case, proceed as follows.

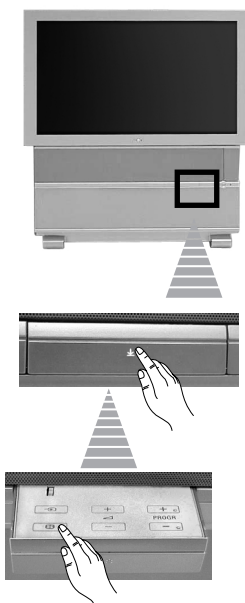

### Auto converge the Red, Green, and Blue Lines

**1** Press on the mark , on the front of the projection TV.

**2** Press button.

The Auto Convergence function works for about 10 seconds. When the white cross disappears from the screen, your projection TV is ready for use.

#### Notes:

The Auto Convergence function does not work when:

- no signal is input.
- the input signal is weak.
- the screen is exposed to spotlights or direct sunlight.
- you watch the teletext broadcast.
- you watch NexTVview.

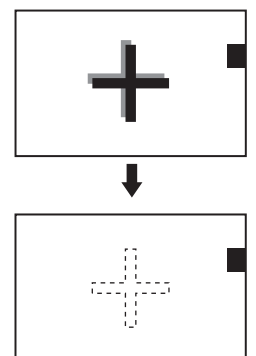

## Menu System

# Changing the Screen Format

**i** This feature allows you to change the size of the TV picture.



**1** Press the  button on the remote control repeatedly to select one of the following formats.

- Smart:** imitation of wide screen effect for 4:3 broadcast.
- 4:3:** conventional 4:3 picture size, full picture information.
- 14:9:** compromise between 4:3 and 16:9 picture size.
- Zoom:** widescreen format for letterbox movies.
- Wide:** for 16:9 broadcast.

In **Smart**, **Zoom** and **14:9** modes parts of the top and bottom of the screen are cut off. Press **▼** or **▲** to adjust the position of the image on screen (eg to read subtitles).

**2** Press the **OK** button to confirm your selection.

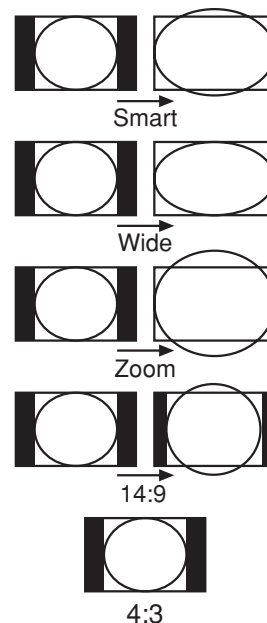

## Introducing the Menu system

**i** Your set uses an on-screen menu system to guide you through the operations. Use the following buttons on the Remote Control to operate the menu system:



**1** Press the **MENU** button to switch the first level menu on.

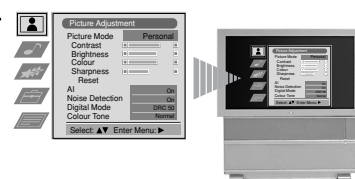

- 2**
- To highlight the desired menu or option, push the joystick **▲** or **▼**.
  - To enter to the selected menu or option, push **▶**
  - To return to the last menu or option, push **◀**.
  - To alter settings of your selected option, push **▼/▲/◀** or **▶**.
  - To confirm and store your selection, press **OK**.

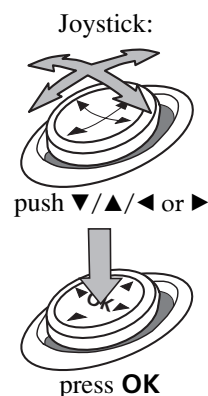

**3** Press the **MENU** button to remove the menu from the screen.

# Adjusting the Picture

**i** Although the picture is adjusted at the factory, you can modify it to suit your own taste.



**1** Press the **MENU** button on the remote control to display the menu on the screen.

**2** Push the joystick **▶** to enter the **Picture Adjustment** menu.

**3** Push the joystick **▼** or **▲** to select the item you wish to change, then push **▶** to enter. Refer to the table below to choose the item and for the effect of each control:

<b>Picture Mode</b>	▼ <b>Live</b> (for live broadcast programmes) <b>Personal</b> (for individual settings) <b>Movie</b> (for films) ▲ <b>Game</b> (for computer games)
<b>Contrast</b>	◀ Less      ▶ More
<b>Brightness*</b>	◀ Darker    ▶ Brighter
<b>Colour*</b>	◀ Less      ▶ More
<b>Sharpness*</b>	◀ Softer    ▶ Sharper
<b>Hue**</b>	◀ Reddish   ▶ Greenish
<b>Reset</b>	Ⓞ Resets picture to the factory preset levels.
<b>AI (Artificial Intelligence)</b>	▲ <b>Off:</b> Normal ▼ <b>On:</b> Automatic optimization of contrast level according to the TV signal
<b>Noise Detection</b>	▲ <b>Off:</b> Normal ▼ <b>On:</b> Reduces picture noise in the case of a weak/noisy broadcast signal.
<b>Digital Mode</b>	▼ <b>DRC 50:</b> improves picture resolution and is optimal for viewing scrolling characters. <b>DRC 100:</b> improves picture resolution creating flicker-free pictures. ▲ <b>Normal:</b> Basic 100Hz picture quality.
<b>Colour Tone</b>	▼ <b>Warm:</b> Gives a warm tint to the picture. <b>Normal:</b> Normal. ▲ <b>Cool:</b> Gives a cool tint to the picture.

\* Can only be altered if Personal Picture Mode is selected.  
\*\* Only available for NTSC colour signal (e.g: USA video tapes).

**4** Push the joystick **▲**, **▼**, **◀** or **▶** to alter the selected item, then press the **OK** button to store the new adjustment.

**5** Repeat steps 3 and 4 to alter the other items.

**6** Press the **MENU** button to exit and return to the normal TV screen.

## Changing the Picture Mode Quickly

**i** You can quickly change the Picture Mode without entering the Picture Control menu screen.

**1** Press the **Picture Mode** button on the remote control repeatedly to directly access and select your desired picture mode (**Live**, **Personal**, **Movie**, or **Game**).

**2** Press the **OK** button to remove the display from the screen.

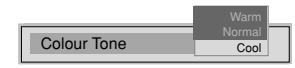
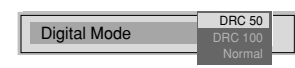
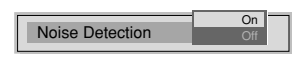
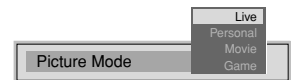
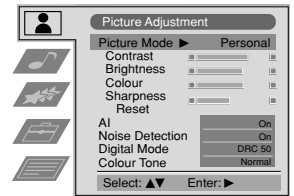
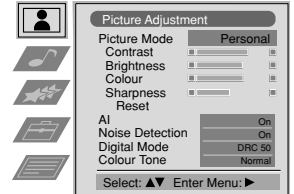

**GB**

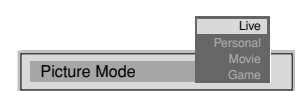

# Adjusting the Sound

**i** Although the sound is adjusted at the factory, you can modify it to suit your own taste.



- 1** Press the **MENU** button on the remote control to display the menu on the screen.
- 2** Push the joystick **▼** to select the **♪** symbol, then push **▶** to enter to the **Audio Adjustment** menu.
- 3** Push the joystick **▼** or **▲** to select the item you wish to change, then push **▶** to enter.  
Refer to the table below to choose the item and for the effect of each control:

<b>Equaliser Mode</b>	<ul style="list-style-type: none"> <li>▼ <b>Personal</b> (for individual settings)</li> <li><b>Vocal</b></li> <li><b>Jazz</b></li> <li><b>Rock</b></li> <li><b>Pop</b></li> <li>▲ <b>Flat</b> (fixed setting, cannot be adjusted)</li> </ul>
<b>*Equaliser Adjustment</b>	Push to <b>▶</b> or <b>◀</b> to select the frequency band you want to alter and push to <b>▼</b> or <b>▲</b> to adjust. Finally, press the <b>OK</b> button to store the new adjustment.
<b>Balance</b>	<b>◀</b> Left <b>▶</b> Right
<b>Loudness</b>	<ul style="list-style-type: none"> <li>▼ <b>Off</b>: normal</li> <li>▲ <b>On</b>: for music broadcasts</li> </ul>
<b>Space</b>	<ul style="list-style-type: none"> <li>▼ <b>Off</b>: normal</li> <li>▲ <b>On</b>: acoustic sound effect</li> </ul>
<b>Auto Vol. Control</b>	<ul style="list-style-type: none"> <li>▼ <b>Off</b>: volume level changes according to the broadcast signal</li> <li>▲ <b>On</b>: volume level of the broadcast channels will stay the same independent of the broadcast signal (e.g. in case of advertisement)</li> </ul>
<b>Dual Sound</b>	<ul style="list-style-type: none"> <li>• For a stereo broadcast:                             <ul style="list-style-type: none"> <li>▼ <b>Mono</b></li> <li>▲ <b>Stereo</b></li> </ul> </li> <li>• For a bilingual broadcast:                             <ul style="list-style-type: none"> <li>▼ <b>Mono</b> (for mono broadcast channel if available)</li> <li>    <b>A</b> (for channel 1)</li> <li>    <b>B</b> (for channel 2)</li> </ul> </li> </ul>
<b>Headphones:</b>	
<b>Volume</b>	<b>◀</b> Less <b>▶</b> More
<b>Dual Sound</b>	<ul style="list-style-type: none"> <li>• For a stereo broadcast:                             <ul style="list-style-type: none"> <li>▼ <b>Mono</b></li> <li>▲ <b>Stereo</b></li> </ul> </li> <li>• For a bilingual broadcast:                             <ul style="list-style-type: none"> <li>▼ <b>Mono</b> (for mono broadcast channel if available)</li> <li>    <b>A</b> (for channel 1)</li> <li>    <b>B</b> (for channel 2)</li> <li>▲ <b>PAP</b> (only when PAP is switched on)</li> </ul> </li> </ul>

\* Can only be permanently stored if Personal Equaliser Mode is selected, the other modes (Vocal, Jazz, Rock or Pop) store until the next mode change.

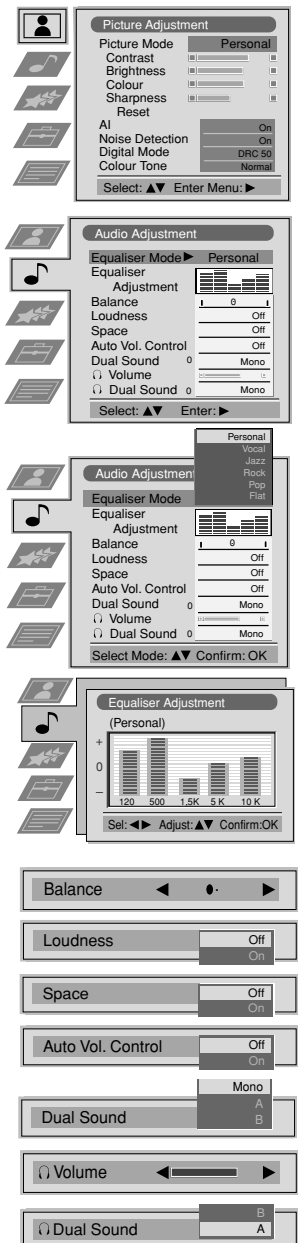

continued...



- 4 Push the joystick **▼**, **▲**, **◀** or **▶** to alter the selected item, then press the **OK** button to store the new adjustment.
- 5 Repeat steps 3 and 4 to alter the other items.
- 6 Press the **MENU** button to exit and return to the normal TV screen.

## Changing Sound Mode Quickly

**i** You can quickly change Sound mode without entering the Sound Control menu screen.

- 1 Press the **♪** button on the remote control repeatedly to directly access and select your desired sound mode (**Personal**, **Vocal**, **Jazz**, **Rock**, **Pop** or **Flat**).
- 2 Press the **OK** button to remove the display from the screen.

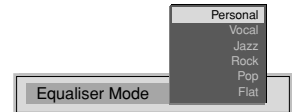

# Using the Features Menu

- i** Using the Features menu you can:
- Select if you want to listen to the sound from the set directly or through an external amplifier.
  - Adjust automatically the size of picture.
  - Select a time period after which the set switches itself into standby mode.
  - Lock the buttons on the set. In this way, the set only works by using the remote control buttons.
  - Select the source to be output from the Scart connector  $\text{↔}2/\text{—}2$  (SMARTLINK). In this way you can record from this scart connector while watching another source. If your VCR supports Smartlink, this procedure is not necessary.



- Press the **MENU** button on the remote control to display the menu on the screen.
- Push the joystick  $\blacktriangledown$  to select the  $\star$  symbol, then push  $\blacktriangleright$  to enter to the **Features** menu.
- Push the joystick  $\blacktriangledown$  or  $\blacktriangle$  to select the desired menu item, then push  $\blacktriangleright$  to enter (see the table below for the effect of each menu item).
- Push  $\blacktriangledown$  or  $\blacktriangle$  to select the desired setting and press the **OK** button to store.
- Press the **MENU** button to exit and return to the normal TV screen.

Features	Effect / Operation
<b>Speaker</b>	<ul style="list-style-type: none"> <li><math>\blacktriangledown</math> <b>Main</b> (sound from the set)</li> <li><math>\blacktriangle</math> <b>Centre In</b> (sound from external amplifier)</li> </ul>
<b>Auto Format</b> (only for aerial signal)	<ul style="list-style-type: none"> <li><math>\blacktriangledown</math> <b>Off</b>: Size of picture is not automatically adjusted.</li> <li><math>\blacktriangle</math> <b>On</b>: Size of picture is automatically adjusted according to the broadcaster information.</li> </ul>
<b>Format Correction</b> (only if Auto Format is set to "Normal" or "Full")	<ul style="list-style-type: none"> <li><math>\blacktriangledown</math> <b>Off</b>: 4:3/14:9 is selected.</li> <li><math>\blacktriangle</math> <b>On</b>: Smart mode is selected automatically for 4:3/14:9 broadcast.</li> </ul>
<b>Sleep Timer</b>	<ul style="list-style-type: none"> <li><math>\blacktriangle</math> <b>Off</b></li> <li><b>10 min.</b></li> <li><b>20 min.</b></li> <li>...</li> <li><math>\blacktriangledown</math> <b>90 min.</b></li> </ul> <p><b>i</b> • One minute before the set switches into standby mode, the time remaining is displayed on the screen automatically.</p> <ul style="list-style-type: none"> <li>• When watching the TV, press the <math>\text{⏏}</math> button on the remote control to display the time remaining.</li> <li>• To return to normal operation from standby mode, press the <b>TV I/O</b> button on the remote control.</li> </ul>
<b>Parental lock</b>	<ul style="list-style-type: none"> <li><math>\blacktriangledown</math> <b>Off</b> (Normal mode)</li> <li><math>\blacktriangle</math> <b>On</b> (The set can only be switched on using the remote control, the buttons on the TV do not work)</li> </ul>
<b>AV2 Output</b>	<ul style="list-style-type: none"> <li><math>\blacktriangledown</math> <b>TV</b> (audio/video signal from the aerial)</li> <li><b>AV1</b> (audio/video signal from the Scart connector <math>\text{↔}1/\text{—}1</math>).</li> <li><b>AV2</b> (audio/video signal from the Scart connector <math>\text{↔}2/\text{—}2</math> (SMARTLINK)).</li> <li><b>AV3</b> (audio/video signal from the Scart connector <math>\text{↔}3/\text{—}3</math>).</li> <li><math>\blacktriangle</math> <b>AV4</b> (audio/video signal from the connector <math>\text{—}4</math> placed in the front of the set).</li> </ul>

**⚠** If you have connected a decoder, please remember to change back the AV2 Output to "TV" for correct unscrambling.

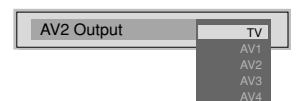
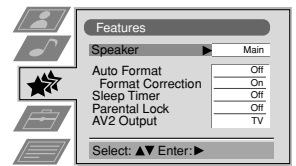
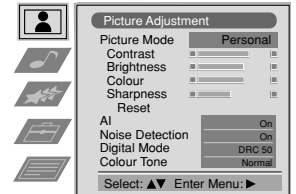

# Manually Tuning the TV

**i** Use this function to preset broadcast channels or a video input source one by one to the programme order of your choice.



- 1** Press the **MENU** button on the remote control to display the menu on the screen.
- 2** Push the joystick **▼** to select the  symbol, then push **▶** to enter the **Set Up** menu.
- 3** Push the joystick **▼** or **▲** to select **Manual Set Up**, then push **▶** to enter.
- 4** Push the joystick **▼** or **▲** to select **Manual Programme Preset**, then push **▶** to enter.
- 5** Push the joystick **▼** or **▲** to select on which programme number you want to preset a broadcast channel (for VCR select programme number "0"), then push twice **▶**. The column **SYS** is highlighted.
- 6** Push the joystick **▼** or **▲** to select the system for TV Broadcast system and VCR channel (**I** for Great Britain) or an external input source (**EXT**), then push **▶**. The column **CH** is highlighted.
- 7** Push the joystick **▼** or **▲** to select the channel tuning, **"C"** for terrestrial channels (for TV Broadcast or VCR channel) or **F** for direct frequency input then push **▶**.
- 8**
  - a) If you know the channel number of the TV Broadcast, the VCR test signal channel or the frequency, press the number buttons to enter directly the channel number. Then press the **OK** button to store.
  - b) If you do not know the channel number, push the joystick **▼** to select **SEARCH** and the set starts automatically to search for the next available TV Broadcast channel or the channel of the VCR signal. Then press the **OK** button to store or push **▼** to continue searching the desired channel.
  - c) For external input sources (**EXT**), push **▼** to select the input source where you have connected your equipment (**AV1**, **AV2**, **AV3** or **AV4**). Then press the **OK** button to store.
- 9** Repeat steps 4 to 8 a), b) or c) if you wish to store more broadcast channels.
- 10** Press the **MENU** button to exit and return to the normal TV screen.

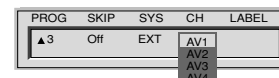
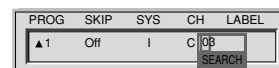
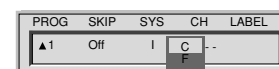
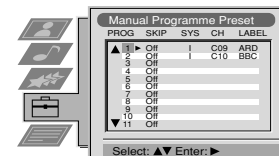
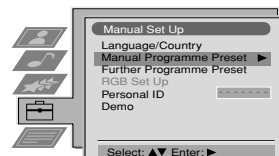
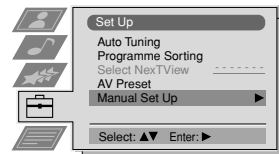
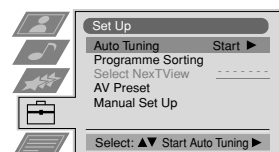
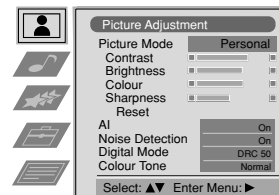

GB

 The set is now ready for use.

# Labelling a channel

**1** Names for broadcast channels are usually taken automatically from Teletext if available. You can however name a broadcast channel or an input video source using up to five characters (letters or numbers). Using this function, you can easily identify which broadcast channel or video source you are watching.



- 1** Press the **MENU** button on the remote control to display the menu on the screen.
- 2** Push the joystick **▼** to select the  symbol, then push **▶** to enter the **Set Up** menu.
- 3** Push the joystick **▼** or **▲** to select **Manual Set Up**, then push **▶** to enter.
- 4** Push the joystick **▼** or **▲** to select **Manual Programme Preset**, then push **▶** to enter.
- 5** Push the joystick **▼** or **▲** to select the programme number with the channel you wish to name.
- 6** Push the joystick **▶** repeatedly until the first element of the **LABEL** column is highlighted.
- 7** Push the joystick **▼** or **▲** to select a letter, number, "+" or a blank, then push **▶** to confirm this character. Select the other four characters in the same way.
- 8** After selecting all the characters, press the **OK** button.
- 9** Repeat steps 5 to 8 if you wish to label other channels.
- 10** Press the **MENU** button to exit and return to the normal TV screen.

 When you select a named channel, the name appears for a few seconds on the screen.

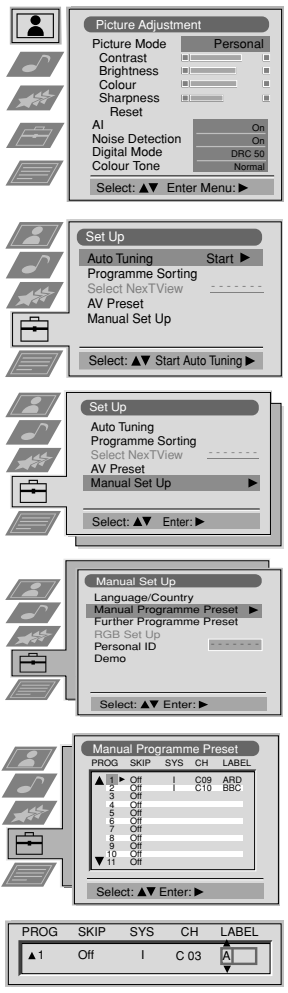



# Skipping Programme positions

**i** You can programme this set to skip any unwanted programme numbers when they are selected with the **PROGR +/-** buttons. To cancel this function afterwards, proceed in the same way as described below by selecting **Off** instead of **On** in step 6.



**1** Press the **MENU** button on the remote control to display the menu on the screen.

**2** Push the joystick **▼** to select the  symbol, then push **▶** to enter the **Set Up** menu.

**3** Push the joystick **▼** or **▲** to select **Manual Set Up**, then push **▶** to enter.

**4** Push the joystick **▼** or **▲** to select **Manual Programme Preset**, then push **▶** to enter.

**5** Push the joystick **▼** or **▲** to select the programme position you want to skip, then push **▶** to enter the **SKIP** column.

**6** Push the joystick **▼** to select **On**, then press the **OK** button to store.

**7** Repeat steps 5 and 6 to skip other unused programme positions.

**8** Press the **MENU** button to exit and return to the normal TV screen.

 When changing broadcast channels with the **PROGR +/-** buttons, the skipped programme positions do not appear. You can, however, still select them using the number buttons.

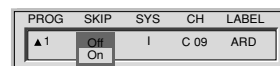
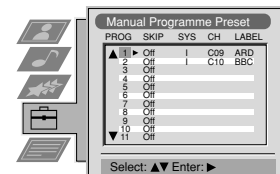
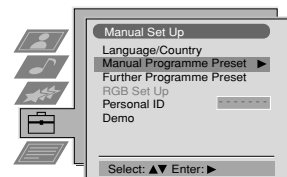
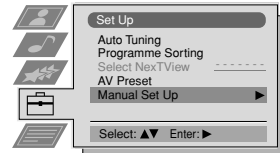
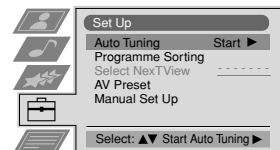
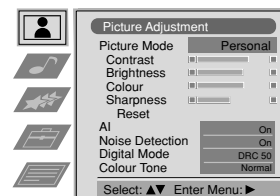





GB



# Using the "Further Programme Preset" function

- 1** With this feature you can:
- a) Individually attenuate the strength of a channel signal in case of a strong local aerial signal (striped picture).
  - b) Individually adjust the volume level of each broadcast channel.
  - c) Normally the automatic fine tuning (AFT) is operating, however you can manually fine-tune the TV to obtain better reception if the picture is distorted.
  - d) Preset the AV output for the programme positions of broadcast channels with scrambled signals (eg from a pay TV decoder). In this way a connected VCR records the unscrambled signal.



- 1** Press the **MENU** button on the remote control to display the menu on the screen.
  - 2** Push the joystick **▼** to select the  symbol, then push **▶** to enter the **Set Up** menu.
  - 3** Push the joystick **▼** or **▲** to select **Manual Set Up** then push **▶** to enter.
  - 4** Push the joystick **▼** or **▲** to select **Further Programme Preset**, then push **▶** to enter.
  - 5** Push the joystick **▼** or **▲** to select the relevant programme number, then push **▶** repeatedly to select:
    - a) **ATT** (RF attenuator)
    - b) **VOL** (Volume Offset)
    - c) **AFT** (Automatic Fine Tuning) or
    - d) **DECODER**

The selected item changes colour.
  - 6**
    - a) **ATT**  
Push the joystick **▼** to select **On**, then press the **OK** button. Repeat steps 5 and 6 a) to attenuate other channels.
    - b) **VOL**  
Push the joystick **▼** or **▲** to adjust the volume level of the broadcast channel over a range of -7 to +7, then press the **OK** button. Repeat steps 5 and 6b) to adjust the volume level of the other broadcast channels.
    - c) **AFT**  
Push the joystick **▼** or **▲** to fine tune the channel frequency over a range of -15 to +15, then press the **OK** button. Repeat steps 5 and 6c) if you wish to fine tune other broadcast channels.
    - d) **DECODER**  
Push the joystick **▼** or **▲** to select **AV1** (for a decoder connected to the Scart  or ) or **AV2** (for a decoder connected to the Scart ) (SMARTLINK)), then press the **OK** button. Repeat steps 5 and 6d) to select the AV1 or AV2 output for other programme positions.
- 7** Press the **MENU** button to exit and return to the normal TV screen.

**i** The picture from the decoder connected to the Scart connector  or  (SMARTLINK) on the back of the set will appear on this programme number.

 The set is now ready for use.

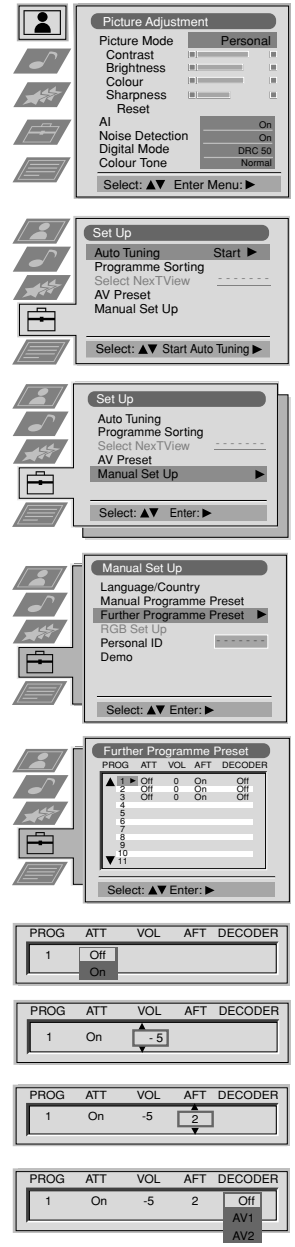

## Menu System

# Inputting Your Personal ID

**i** You can programme this set with a personal code, using up to eleven characters (letters and numbers). Then using this function it will be possible to identify your set if it was ever stolen.

**A** This code can only be input once!  
Make sure to write it down in this instruction manual.



**1** Press the **MENU** button on the remote control to display the menu on the screen.

**2** Push the joystick **▼** to select the  symbol, then push **▶** to enter the **Set Up** menu.

**3** Push the joystick **▼** or **▲** to select **Manual Set Up**, then push **▶** to enter.

**4** Push **▼** or **▲** to select **Personal ID**, then push **▶** to enter.

**5** Push the joystick **▼** or **▲** to select a letter, number, + or a blank; then push **▶** to confirm this character. Select the other ten characters in the same way.

**6** After selecting all the characters, press the **OK** button. A new menu appears automatically on the screen asking you to be sure that you want to save this ID.

**7** a) If you do not wish to store this ID, push the joystick **◀** and repeat steps 4 to 6 to enter a new ID.

b) If you wish to store this ID, press the **OK** button.

**A** Remember that this code can only be input once.

**8** Press the **MENU** button to return to the normal TV screen.

 When you enter the **Manual Set Up** menu, in the "Personal ID" option the code you entered above will be displayed. You will not be able to select and change this option.

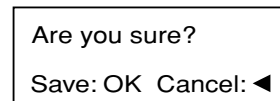
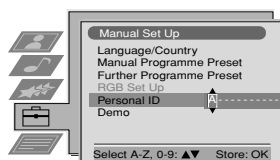
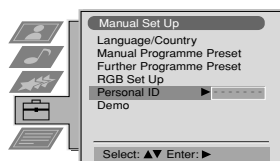
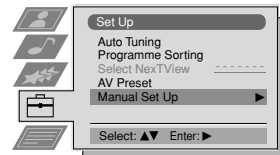
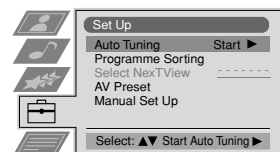
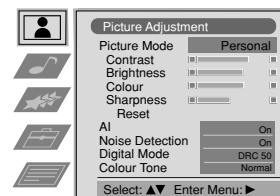

GB

## Using the Demo Mode

**i** This function provides an overview of some of the features available on this set.

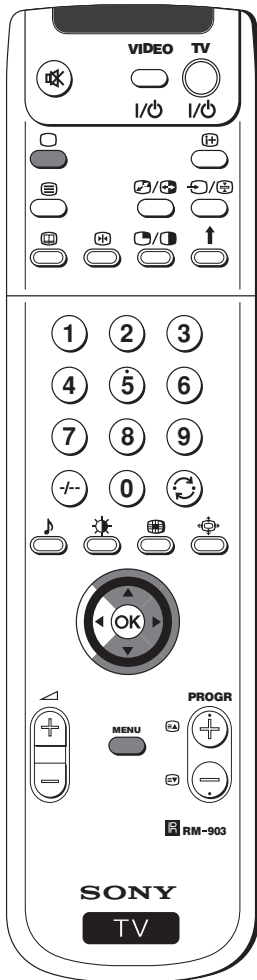

**1** Press the **MENU** button on the remote control to display the menu on the screen.

**2** Push the joystick **▼** to select the  symbol, then push **▶** to enter the **Set Up** menu.

**3** Push the joystick **▼** or **▲** to select **Manual Set Up**, then push **▶** to enter.

**4** Push **▼** or **▲** to select **Demo**, then push **▶** to enter and start the demonstration.

 *The set starts the demonstration and shows most of the available picture functions.*

**Note:**

Press the  button on the remote control to stop the Demo mode and return to the normal TV screen.

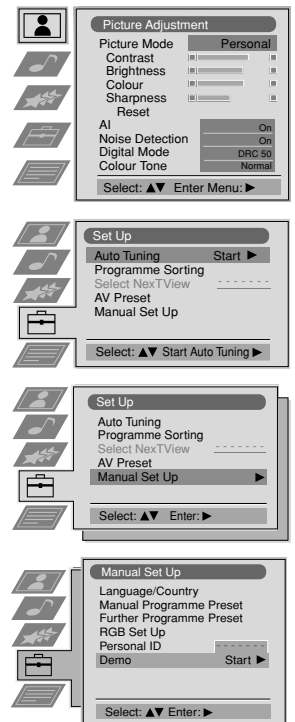







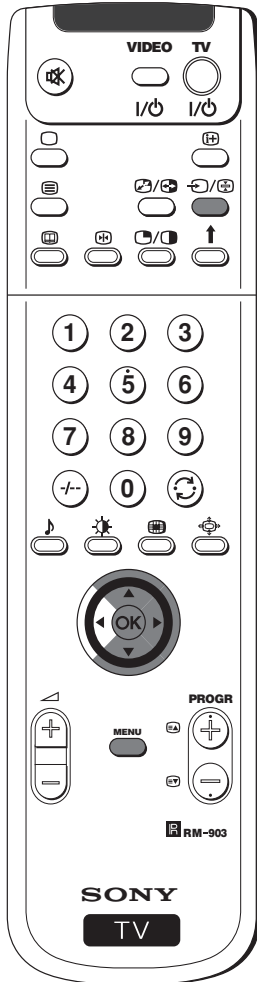







## Menu System

# Adjusting the H Centre picture for an RGB source

**i** When connecting an RGB source, such as a DVD player, to the Scart connector  you may need to readjust the H Centre of the picture.



- 1** Press the  button repeatedly on the remote control until the symbol  appears on the screen.
- 2** Push the **MENU** button to display the menu on the screen.
- 3** Push the joystick  to select the  symbol, then push  to enter the **Set Up** menu.
- 4** Push  or  to select **Manual Set Up** then push  to enter.
- 5** Push the joystick  or  to select **RGB Set Up** then push  to enter.
- 6** Push the joystick  to enter **H Centre**, then push  or  to adjust the centre of the picture over a range of -10 to +10. Press the **OK** button to store.
- 7** Press the **MENU** button to exit and return to the normal TV screen.

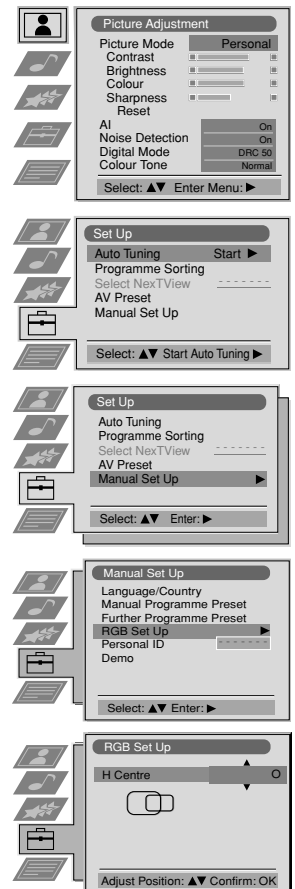

GB

# Labelling and Selecting the screen format of Input Sources

**1** This function enables you to select the size of the picture coming from the input source as well as designate a name to the optional equipment you have connected to the sockets of this set. This name can contain up to 5 characters (letters or numbers).

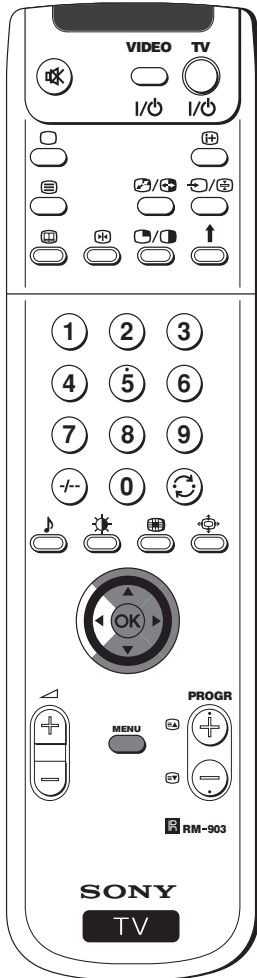

**1** Press the **MENU** button on the remote control to display the menu on the screen.

**2** Push the joystick **▼** to select the  symbol, then push **▶** to enter the **Set Up** menu.

**3** Push the joystick **▼** or **▲** to select **AV Preset**, then push **▶** to enter.

**4** Push the joystick **▼** or **▲** to select the input source. Then push **▶** to enter.

**5** Push the joystick **▼** or **▲** to select:

- ▼ Off** (size of picture is not automatically adjusted).
- ▲ On** (size of picture is automatically adjusted according to the broadcaster information).

Next push **▶**.

**6** With the first element of the **LABEL** column highlighted, push the joystick **▼** or **▲** to select a letter, number, "+" or blank; then push **▶** to confirm this character. Select the other four characters in the same way.

**7** After selecting all the characters, press the **OK** button.

**8** Repeat steps 4 to 7 if you wish to select the picture size or label other input sources.

**9** Press the **MENU** button to exit and return to the normal TV screen.

 Whenever the equipment with the labelled input is selected for use, the name appears for a few seconds on the screen

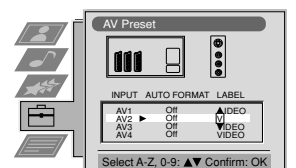
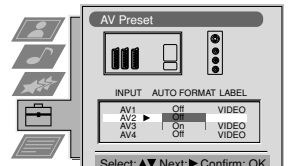
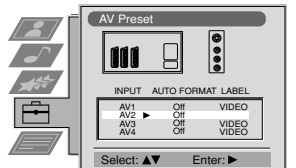
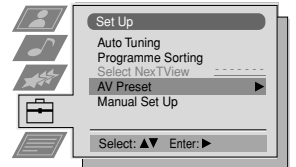
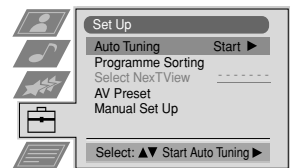
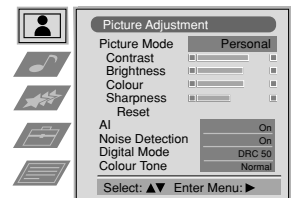







## Menu System

# Using Multi PIP (Picture In Picture)

**i** Multi PIP (Picture in Picture) mode displays a succession of 12 still pictures and a 13th that is live. You can manually select which channel you wish to watch, either full-screen or in the PIP.



- 1 Press the  button on the remote control to select the PIP mode. Now 13 programme positions appear on the screen, with the current channel in the centre.
- 2 Push the joystick , ,  or  to move within the 13 displayed broadcast channels.
- 3 Press the OK button to select the framed broadcast channel. The selected channel moves to the centre.
- 4 Press  to return to the normal TV mode.

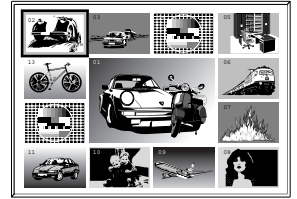



GB

# Using PAP (Picture And Picture)





**i** PAP divides the screen into two for watching two channels simultaneously. One of the pictures can be selected to come from a video source. The sound of the left screen comes through the set loudspeakers, the sound of the right screen is selectable via headphones.



## Switching PAP on and off

Press the button  on the remote control to display the two screens in format 4:3. Press  again to switch PAP off.



## Selecting PAP source

- 1 To change the source of the left screen:  
With PAP switched on, press the number buttons to select a TV broadcast channel or press  to select a video source.
- 2 To change the source of the right screen:  
With PAP switched on, press the button  on the remote control. When the symbol  appears at the bottom of the right screen, press the number buttons (to select a TV broadcast channel) or press  (to select a video source).

## Swapping screens

With PAP switched on, press the  /  button on the remote control to swap the two screens.

## Zooming the screens

With PAP switched on, push the joystick repeatedly  or  to change the size of the two screens.

## Selecting the sound of the right screen

You can select the sound of the right screen via headphones. With PAP switched on, refer to the "Adjusting the Sound" section of this instruction manual and set the option "Dual Sound" to "PAP".

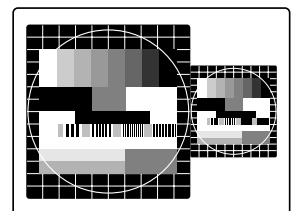
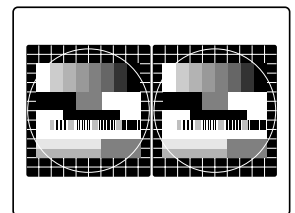

# Teletext

**i** Most TV stations broadcast information via Teletext. The index page of the teletext service (usually page 100) gives you information on how to use the service.

**A** Please use a broadcast channel with a strong signal, otherwise there may be Teletext errors.



## Switching Teletext on and off

- 1 Select the TV channel which carries the teletext service you want to view.
- 2 Press the **≡** button once for Picture and Teletext (P&T). The screen is divided in two, with the TV channel in the right corner and the Teletext display on the left.
  - i** P&T mode: Press **↔** / **↔** then press **PROGR +/-** to change the channel of the TV screen. Push the joystick **◀** or **▶** to change the size of the TV screen then press **↔** / **↔** again to resume normal teletext reception.
- 3 Press **≡** twice to get Teletext only.
- 4 Press **≡** three times for Mix mode.
- 5 Press **≡** a fourth time or press **□** to switch off Teletext.

## Selecting a Teletext page

Input three digits for the page number using the numbered buttons on the control. If you make a mistake, type in any three digits then re-enter the correct page number.

## Using Other Teletext Functions

### Selecting the next or preceding page

Press the **⏪** (**PROG+**) or **⏩** (**PROG-**) buttons on the remote control to select the previous or next page.

### Selecting a sub page

A teletext page may consist of several sub pages. In this case, after a few seconds, an information line is displayed showing the number of subpages.

Select the sub page by pressing **▲** or **▼**.

### To freeze a Teletext page

Press the **⏸** button to freeze the page. Press again to cancel the freeze.

### Revealing the index page

Press the **⊕** button to reveal the index page (normally page 100).

### Fastext

(only available if the TV station broadcasts Fastext signals)

When the colour coded menu appears at the bottom of a teletext page, press a coloured button on the remote control (red, green, yellow or blue) to access the corresponding page.

### Using the feature "Page Catching"

- 1 Press the numbered buttons on the remote control to select a teletext page which has several page numbers on it (eg the index page).
- 2 Press the **OK** button.
- 3 Push the joystick **▲** or **▼** to select the desired page number then press the **OK** buttons. The requested page is displayed after some seconds.

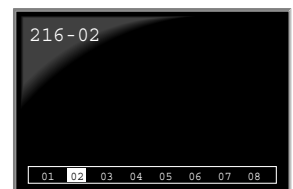
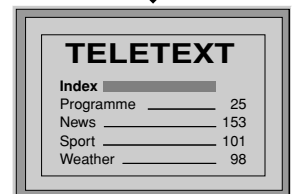
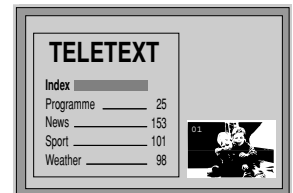

continued...





## Using the Teletext menu

- 1 With Teletext switched on (in mode "Teletext only"), press the **MENU** button on the remote control to display the teletext menu on the TV screen.
- 2 Push the joystick **▲** or **▼** to select your chosen item, then push to **▶** to display the relevant sub menu.
- 3 To remove the teletext menu from the screen, press the **MENU** button.

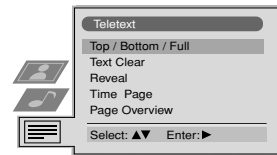



### Top / Bottom / Full

The Top/Bottom/Full sub menu allows you to enlarge different sections of the Teletext page. Push the joystick **▲** to enlarge the upper half of the screen, push **▼** to enlarge the lower half. Press the **OK** button to restore the page to normal size.

Top: **▲** Bottom: **▼** Full: **OK**

### Text Clear

After having selected this function, you can watch a broadcast channel while waiting for a requested Teletext page. As soon as the page is available, the symbol  changes colour. To view the page, press .

### Reveal

Some teletext pages contain hidden information (eg for a quiz), which you can reveal. The hidden information appears on screen.

### Time Page

(depending on availability of teletext service)

You can call up a time-coded page such as an alarm page at a time specified by you. After you have displayed the Time Page sub menu:

- 1 Press the numbered buttons on the remote control to enter the three digits of the desired page.
- 2 Press the numbered buttons again to enter the four digits of the desired time.
- 3 Press the **OK** button to store the desired time. The time is displayed in the top left corner of the screen. At the requested time the page is displayed.

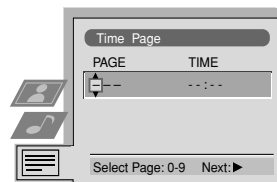

### Page Overview

(depending on availability of teletext service)

In the Page Overview menu the block and group pages of TOP- Text are sorted into two columns, so that the customer can easily select this page. For each block page in the first column, the corresponding group pages are shown in the second column. Push the joystick **▲** or **▼** to select the desired block page, then push **▶** to enter to the group pages column. Push **▲** or **▼** to select the desired group page. Finally, press the **OK** button to display the page.

# NexTVview \*

\* (depending on availability of service)

**i** NexTVview is an on-screen electronic programme guide (EPG), providing you with programme information for different broadcasters.



## Selecting your NexTVview provider

**i** The set automatically selects the best NexTVview provider for you. This provider is available about 30 minutes after the channel tuning. You can however change this selection of provider if you wish.



- 1 Press the **MENU** button on the remote control to display the menu on the screen.
- 2 Push the joystick **▲** or **▼** to select the  symbol, then push **▶** to enter the **Set Up** menu.
- 3 Push **▲** or **▼** to highlight **Select NexTVview** then push **▶** to enter. A list is displayed containing all available NexTVview providers.
- 4 Push **▲** or **▼** to select the desired provider then press the **OK** button to store.
- 5 Press the **MENU** button to remove the menu from the screen.

## Displaying NexTVview

- 1 Press the  button repeatedly on the remote control to switch NexTVview on and off.
  - \* In some cases, you may also need to push the joystick **◀** to display the Sony electronic programme guide.
- 2 Push the joystick **▲**, **▼**, **◀** or **▶** to move the cursor around the screen.
- 3 Press the **OK** button to confirm a selection.
  - a) If you press the **OK** button in the date, time or icon (themes) columns, you change the programme list according to the selection.
  - b) If you press the **OK** button in the programme list, you directly display the broadcast channel if the broadcast is currently running, or, you display the "Long Info" menu if the broadcast is running at some future time.

## Using the "Individual Setting" menu

**i** You can make a personal list of the types of programmes you wish to view on the programme guide.

- 1 Push the joystick **▲** or **▼** to select the  icon then push to **▶** to display the "Individual Setting" menu.
- 2 Push the joystick **▲** or **▼** to select your chosen item on the screen then press the **OK** button to confirm your choice.
- 3 Repeat step 2 for all the items you wish to have in your list.
- 4 When you have finished the list, push **▶** to select the  icon.
- 5 Press the **OK** button to return to the previous menu.
- 6 Push the joystick **▲** or **▼** to select the  icon then press the **OK** button again to activate your "Individual Setting" filter.

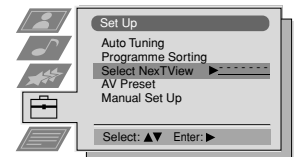
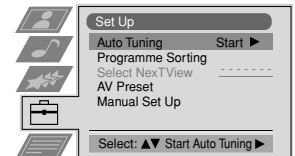
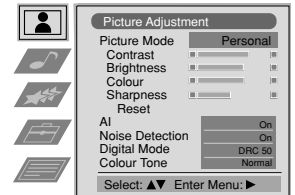

Index	
	full selection list
	personal selection
	news broadcasts
	movies
	sports
	entertainment
	children
	return to last menu

continued...



## Using the Long Info menu

**i** With this menu screen, you can set timers or record selected programmes.

- 1 Push **▲** or **▼** to select a future programme in the programme list column.
- 2 Press the **OK** button to display the **Long Info** menu on the TV screen.

### To set the timer

Push the joystick **▲** or **▼** to highlight the **⌚** icon then press the **OK** button repeatedly to "set the timer" or "cancel the timer". If you choose to set the timer, the programme is marked with a clock symbol and a message appears on the screen shortly before the programme is due to start asking whether you wish to still view this programme.

### To view the timer table

Push the joystick **◀** or **▶** to highlight the **📅** icon then press the **OK** button repeatedly to switch on/off the timer table. This table shows the programmes on which you have already set a timer. (You can set a timer on up to 5 programmes).

### To record programmes

(only with Smartlink VCRs)

- 1 Connect your Smartlink VCR.
- 2 Push the joystick **◀** or **▶** to select **📺** then press the **OK** button to download the information to your VCR.
- 3 To set up the VCR:

#### VPS/PDC

Push the joystick **◀** or **▶** to select **VPS/PDC** then press the **OK** button repeatedly to select **On** or **Off**. With this setting on you have the guaranteed recording of the whole broadcast should there be a change in the TV programme. This only works if the selected TV channel broadcasts a VPS/PDC signal.

#### Speed

Push the joystick **▼** to select **Speed** then press the **OK** button repeatedly to select between **SP** for standardplay or **LP** for longplay. With longplay you can record twice as much on a videotape. The picture quality however may suffer.

#### VCR Setup

Push the joystick **▼** to select **VCR Setup** then press the **OK** button repeatedly to select which **VCR** you wish to programme, namely **VCR1** or **VCR2**.

- 4 Finally, push the joystick **▶** to select the **↩** icon then press the **OK** button to remove the menu from the TV screen.

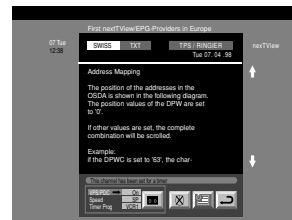

GB

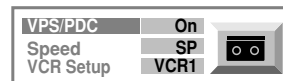

## Optional Connections

# Connecting Optional Equipment

**1** Using the following instructions, you can connect a wide range of optional equipment to this set.

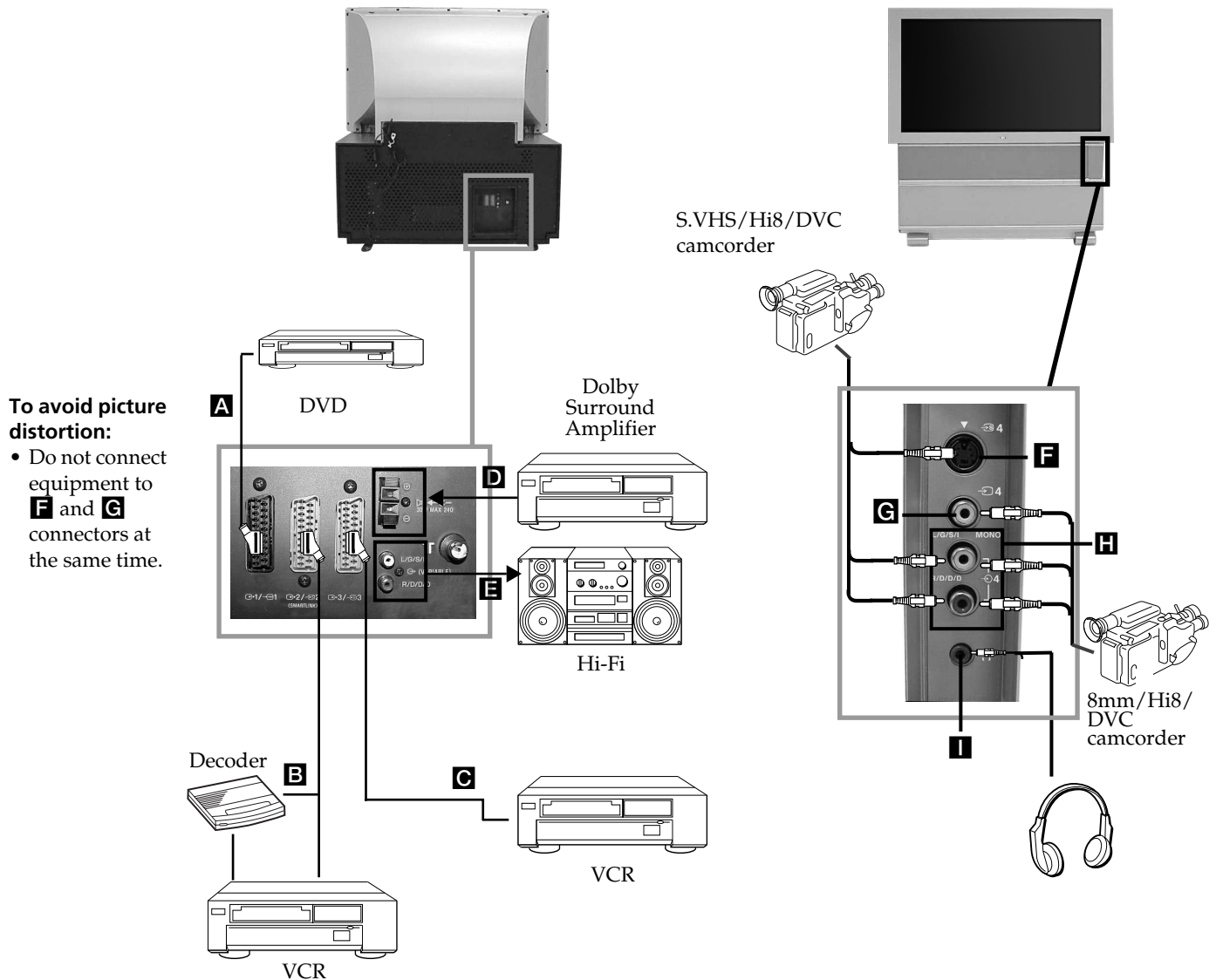

### Acceptable input signal

- A** Audio/video and RGB signal
- B** Audio/video and S video signal
- C** Audio/video and S video signal
- D** Centre speaker input. On the "Features", set "Speaker" to "Centre in".
- E** No inputs
- F** S Video signal
- G** Video signal
- H** Audio signal
- I** No input

### Available output signal

- Video/audio from TV tuner.
- Video/audio from selected source.
- Video/audio displayed on TV screen (monitor out).
- No outputs.
- Audio signal.
- No output.
- No output.
- No output.
- Audio signal to headphones.

# Using Optional Equipment

## Additional Information when connecting equipment

### Connecting a VCR

We recommend you connect your VCR to the **B** or **C** socket using a scart lead. If you do not have a scart lead, use the "Manually Tuning the TV" section of this instruction manual to tune in the channel of the VCR test signal to TV programme number "0". Also refer to your VCR instruction manual to find out how to find the output channel of your VCR. If your video supports Smartlink please refer to the "Smartlink" section of this instruction manual.

### Connecting to External Audio Equipment

#### 1 To listen to the audio of the set on the Hi-Fi equipment:

Plug in your Hi-Fi equipment to the **E** sockets on the rear of the set if you wish to amplify the audio output from the TV.

The output level from **E** sockets can be varied by adjusting the volume of the headphones. Refer to the "Adjusting the sound" section of this instruction manual to adjust the volume of the headphones.

#### 2 To listen to the Dolby Prologic system sound on the set speakers:





Plug in your Dolby Prologic system decoder amplifier to the **D** socket on the rear of the set if you wish to listen to the audio output from your equipment on the TV speaker. If you have a Dolby amplifier, connect the centre output from your amplifier to the **D** socket to use the set as a centre speaker. Refer to the "Using the Features menu" section of this instruction manual and set the option "Speaker" to "Centre in".

 Remember that the maximum input level of this input is 30 W. Be careful never to over this limit.

### For mono equipment

Connect the phono plug to the L/G/S/I socket on the front of the TV and select the  4 input signal using the instructions on this page below.

## Select and View the Input Signal

 In order to get the input signal of a connected equipment onto the TV screen, you need to select the symbol of the connector to which you have connected the device.  
e. g. : Your VCR is connected to the connector with the symbol  1. Press the button  on the remote control repeatedly until you see the symbol  1 on the screen.

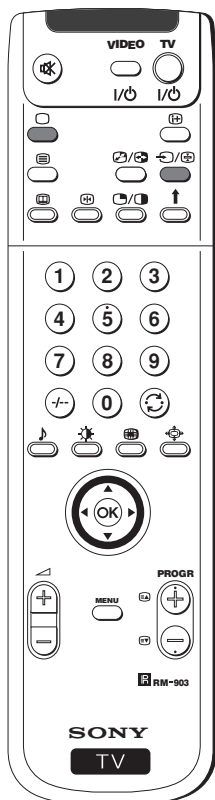





**1** Connect your equipment to the designated socket, as it is indicated on the previous page.

**2** Switch on the connected equipment.

**3** Press the  button repeatedly on your remote control until the correct input symbol appears on the screen.

#### Symbol      Input signals

-  1 • Audio/video input signal through the Scart connector **A** or \* RGB through Scart connector **A**.
  -  2 • Audio/Video input signal through the Scart connector **B** or \* S Video through Scart connector **B**.
  -  3 • Audio/Video input signal through the Scart connector **C** or \* S Video through Scart connector **C**.
  -  4 • S Video input signal through the 4-pin DIN connector **F** or \* video input signal through phono jack **G** and audio input signal through phono jacks **H**.
- \* (automatic detection of the signal according to the connected equipment)



**4** To return to the normal TV picture, press the  button on the remote control.

## Optional Connections

# Smartlink

**i** Smartlink is a direct link between the set and a VCR.

## For Smartlink you need:

- A VCR which supports Smartlink, NextView Link, Easy Link or Megalagic.
- **i** Megalagic is a trademark of Grundig Corporation.  
EasyLink is a trademark of Philips Corporation.
- A fully-wired 21 pin SCART cable to connect your VCR to the Scart connector 2/2 (SMARTLINK) on the rear of the set.

## The features of Smartlink are:

- Tuning information such as the channel overview are downloaded from the set to the VCR.
- Direct recording: While watching TV you need to press just one button on the VCR to record this programme.
- Automatically switching on: With the set in standby mode, pressing the "Play ▶" button on your VCR automatically switches the TV on.

**A** If you have connected a decoder to a VCR which supports Smartlink feature, select the menu "Further Programme Preset" in the  (Manual Set Up) menu and select **DECODER AV2** to each coded channel. For more details, please refer to the section "Using the Further Programme Preset function" of this instruction manual.

**A** For more information on Smartlink, please refer to the Instruction Manual of your VCR.

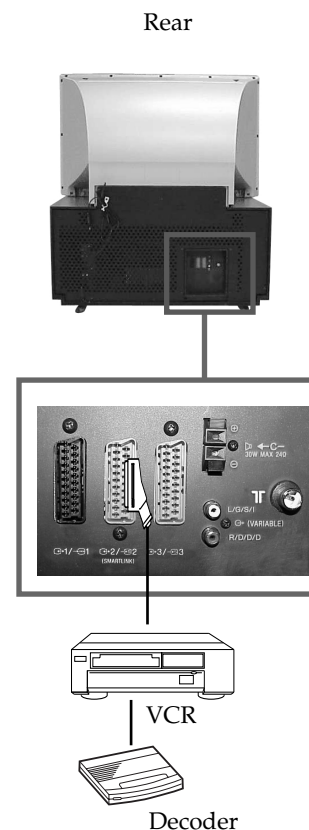

## Remote Control of other Sony Equipment

**i** Using the buttons underneath the cover of the remote control you can control other Sony equipment.

- 1** Open the cover of the Remote Control.
- 2** Set the selector VTR 1234 DVD according to the equipment you want to control:  
VTR 1 Beta VCR  
VTR 2 8 mm VCR  
VTR 3 VHS VCR  
VTR 4 Digital Video (DCR-VX 1000/9000 E, VHR-1000)  
DVD Digital Video Disk
- 3** Use the buttons underneath the cover on the remote control to operate the equipment.

- **A** If your equipment has a COMMAND MODE selector, set this selector to the same position as the VTR 1234 DVD selector on this set Remote Control.
- If the equipment does not have a certain function, the corresponding button on the remote control will not work.

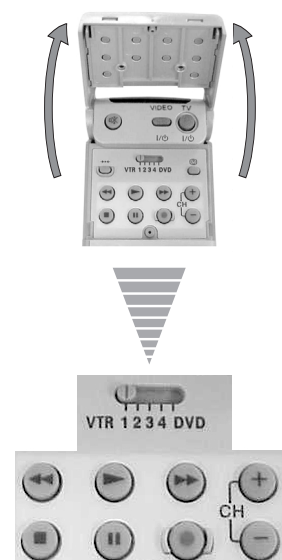

## Additional Information

# Optimum Viewing Area

**i** For the best picture quality, try to position the set so that you can view the screen from within the areas shown below.

### Horizontal viewing area

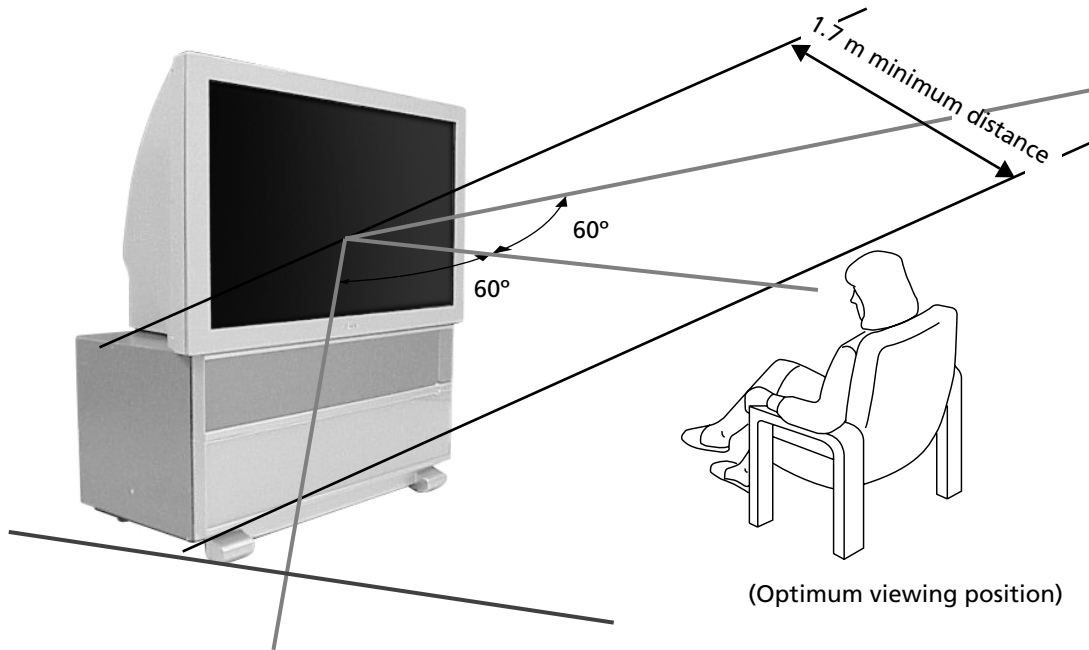

GB

### Vertical viewing area

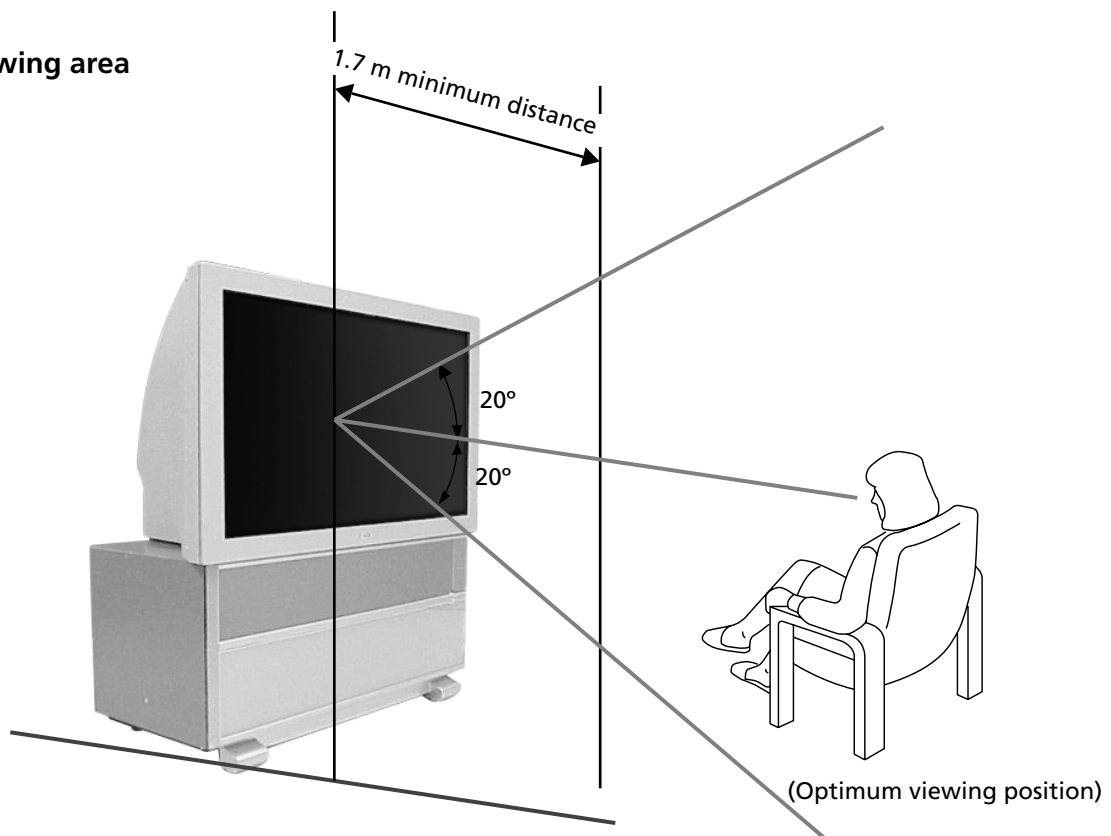

# Specifications

### TV system

I

### Colour system

PAL

SECAM, NTSC 3.58, 4.43 (only Video In)





### Channel coverage

UHF: B21-B69





### Projected picture size

44 inches (approx. 112 measured diagonally).

### Rear Terminals

-  Centre speaker input terminals (2 terminals)
-  (L, R) audio outputs (phono jacks)
-  21-pin Euro connector (CENELEC standard) including audio/video input, RGB input, TV audio/video output.
-  21-pin Euro connector (CENELEC standard) including audio/video input, S video input, selectable audio/video output and Smartlink interface.
-  21-pin Euro connector (CENELEC standard) including audio/video input, S video input, audio/video output (monitor out).

### Front Terminals

-  4 S video input - 4 pin DIN
-  4 video input - phono jack
-  4 audio inputs - phono jacks
-  Headphones jack - minijack stereo

### Sound output

2 x 30 W (music power)

2 x 15 W (RMS)

### Centre SP input

30 W (RMS) (using as the centre speaker)

### Power consumption

225 W

### Standby Power consumption

< 0.7 W

### Dimensions (w x h x d)

Approx. 1100 x 1161 x 543 mm

### Weight

Approx. 75 kg

### Accessories supplied

1 Remote Control (RM-903)

2 Batteries (IEC designated)

### Other features

DRC 100 Hz picture

Digital Comb filter (High resolution)

TELETEXT, Fasttext, TOPtext (2000 page TEXT memory)

NexTVView

NICAM

Sleep Timer

Smartlink

Digital Noise detection

Graphic Equaliser

Personal ID

Auto Format picture

**Design and specifications are subject to change without notice.**









**Ecological Paper - Totally Chlorine Free**





# Troubleshooting

 Here are some simple solutions to the problems which may affect the picture and sound.

<b>Problem</b>	<b>Solution</b>
No picture (screen is dark), no sound.	<ul style="list-style-type: none"> <li>• Plug the set in.</li> <li>• Press the  button on the front of the set.</li> <li>• If the  indicator is on in red colour, press <b>TV I/</b> button on the remote control.</li> <li>• Check the aerial connection.</li> <li>• Turn the set off for 3 or 4 seconds and then turn it on again using the  button on the front of the set.</li> </ul>
Poor or no picture (screen is dark), but good sound.	<ul style="list-style-type: none"> <li>• Using the MENU system, select the "Picture Adjustment" menu. Adjust the brightness, contrast and colour balance levels.</li> </ul>
Poor picture quality when watching a RGB video source.	<ul style="list-style-type: none"> <li>• Press the  button repeatedly on the remote control until the RGB symbol  1 is displayed on the screen.</li> </ul>
Good picture, no sound	<ul style="list-style-type: none"> <li>• Press the  +/- button on the remote control.</li> <li>• Check that "Main" speaker is selected in the "Features" menu.</li> </ul>
No colour on colour programmes	<ul style="list-style-type: none"> <li>• Using the MENU system, select the Picture Adjustment menu. Adjust the colour balance.</li> </ul>
Distorted picture when changing programmes or selecting teletext	<ul style="list-style-type: none"> <li>• Turn off any equipment connected to the Scart connectors on the rear of the set.</li> </ul>
Wrong characters appear when viewing teletext.	<ul style="list-style-type: none"> <li>• Using the menu system, enter to the "Language/Country menu and select the country in which you operate the TV set.</li> </ul>
Striped picture	<ul style="list-style-type: none"> <li>• Adjust the RF Attenuator (ATT). For details, please refer to the section "Using the Further Programme Preset function".</li> </ul>
Noisy picture when viewing TV channel	<ul style="list-style-type: none"> <li>• Adjust Fine Tuning (AFT) to obtain better picture reception. For details, please refer to the section "Using the Further Programme Preset function"</li> </ul>
Remote control does not function	<ul style="list-style-type: none"> <li>• Replace the batteries.</li> </ul>
The standby indicator  on the set flashes.	<ul style="list-style-type: none"> <li>• Contact your nearest Sony service centre.</li> </ul>

**GB**

-  **• If you continue to have these problems, have your TV serviced by qualified personnel.**
- NEVER open the casing yourself.**

## Additional Information

# Television Channel Number Guide for United Kingdom

**i** Only the main transmitters are listed. Information regarding the regional sub-relay channel numbers can be obtained by contacting The BBC Engineering Information Dept. (0181) 752 5040.

MAIN TRANSMITTERS	BBC1	BBC2	ITV	CH4	CH5
<b>London &amp; South East</b>					
① Bluebell Hill	40	46	43	65	-
② Crystal Palace	26	33	23	30	-
③ Dover	50	56	66	53	-
④ Heathfield	49	52	64	67	-
⑤ Oxford	57	63	60	53	49
<b>South-West</b>					
⑥ Beacon Hill	57	63	60	53	-
⑦ Caradon Hill	22	28	25	32	-
⑧ Huntshaw Cross	55	62	59	65	67
⑨ Redruth	51	44	41	47	37
⑩ Stockland Hill	33	26	23	29	-
<b>Channel Islands</b>					
⑪ Fremont Point	51	44	41	47	-
<b>South</b>					
⑫ Hannington	39	45	42	66	-
⑬ Midhurst	61	55	58	68	-
⑭ Rowridge	31	24	27	21	-
<b>West</b>					
⑮ Mendip	58	64	61	54	37
<b>East</b>					
⑯ Sandy Heath	31	27	24	21	39
⑰ Sudbury	51	44	41	47	-
⑱ Tacolneston	62	55	59	65	52
<b>Midlands (West)</b>					
⑲ Ridge Hill	22	28	25	32	-
⑳ Sutton Coldfield	46	40	43	50	-
㉑ The Wrekin	26	33	23	29	-
<b>Midlands (East)</b>					
㉒ Waltham	58	64	61	54	-
<b>Northern Ireland</b>					
㉓ Brougher Mountain	22	28	25	32	-
㉔ Divis	31	27	24	21	-
㉕ Limavady	55	62	59	65	-
<b>North</b>					
㉖ Belmont	22	28	25	32	56
㉗ Emley Moor	44	51	47	41	37
<b>North-West</b>					
㉘ Winter Hill	55	62	59	65	48
<b>North-East</b>					
㉙ Bilsdale West Moor	33	26	29	23	-
㉚ Caldbeck	30	34	28	32	56
㉛ Chatton	39	45	49	42	-
㉜ Pontop Pike	58	64	61	54	-
<b>Scotland</b>					
㉝ Angus	57	63	60	53	-
㉞ Black Hill	40	46	43	50	37
㉟ Sandale	22	28	25	32	-
㊱ Caldbeck	-	-	28	32	56
㊲ Craigkelly	31	27	24	21	48
㊳ Darvel	33	26	23	29	-
㊴ Durriss	22	28	25	32	67
㊵ Eitshal (Lewis)	33	26	23	29	-
㊶ Keelylang Hill	40	46	43	50	-
㊷ Knock More	33	26	23	29	-
㊸ Rosemarkie	39	45	49	42	-
㊹ Rumster Forest	31	27	24	21	-
㊺ Selkirk	55	62	59	65	52
<b>Wales</b>					
㊻ Blaenplwyf	31	27	24	21	56
㊼ Carmel	57	63	60	53	-
㊽ Llanddona	57	63	60	53	-
㊾ Moel-y-Parc	52	45	49	42	-
㊿ Presely	46	40	43	50	37
① Wenvoe	44	51	41	47	-

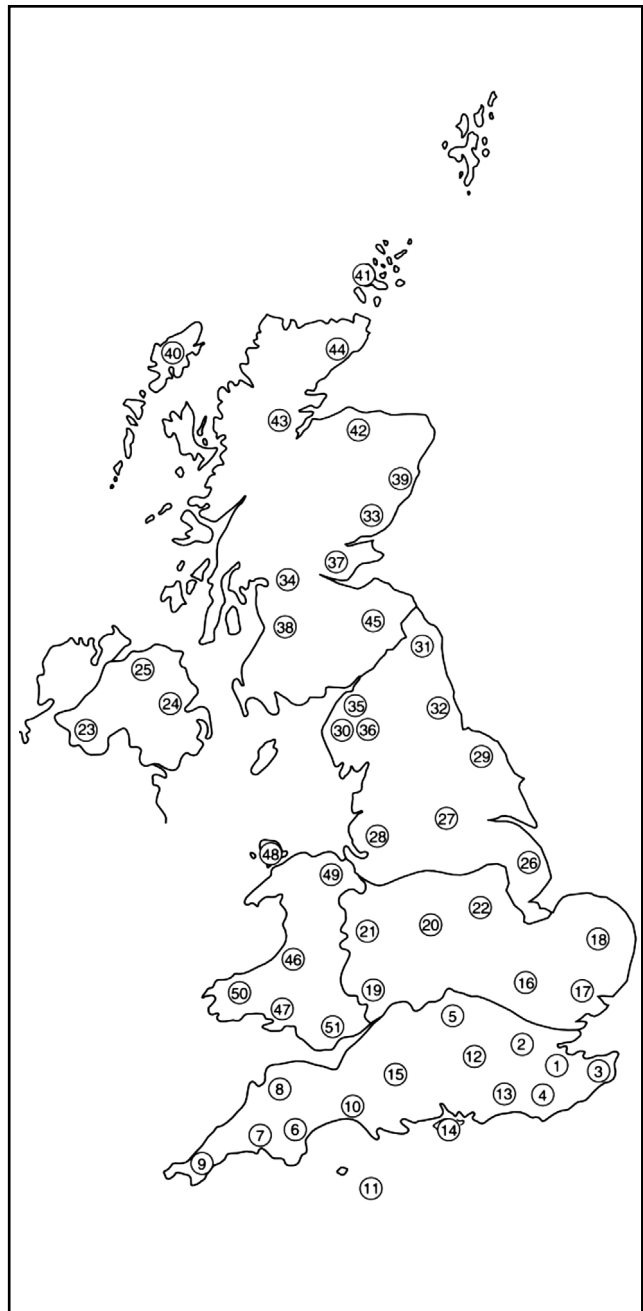

**Sony España, S.A.**  
Printed in Spain

Ecological Paper - Totally Chlorine Free



## Free Manuals Download Website

<http://myh66.com>

<http://usermanuals.us>

<http://www.somanuals.com>

<http://www.4manuals.cc>

<http://www.manual-lib.com>

<http://www.404manual.com>

<http://www.luxmanual.com>

<http://aubethermostatmanual.com>

Golf course search by state

<http://golfingnear.com>

Email search by domain

<http://emailbydomain.com>

Auto manuals search

<http://auto.somanuals.com>

TV manuals search

<http://tv.somanuals.com>