

Trinitron® Color TV

KV-13EXR90/13EXR91**KV-13TR27/13TR24/
13TR14****KV-1427R****Operating Instructions**

Before operating the unit, please read this manual thoroughly and retain it for future reference.

Owner's Record

The model and serial numbers are located at the rear of the unit. Record these numbers in the spaces provided below. Refer to them whenever you call upon your Sony dealer regarding this product.

Model No. _____ Serial No. _____

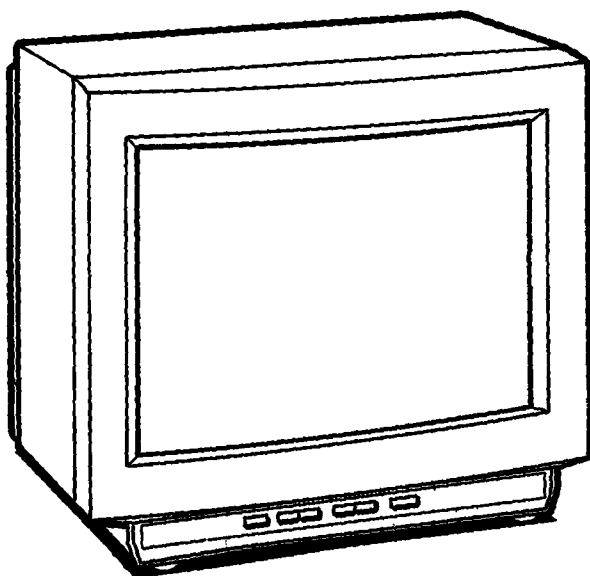

WARNING

To prevent fire or shock hazard, do not expose the unit to rain or moisture.



CAUTION

RISK OF ELECTRIC SHOCK
DO NOT OPEN



**CAUTION : TO REDUCE THE RISK OF ELECTRIC SHOCK,
DO NOT REMOVE COVER (OR BACK).
NO USER-SERVICEABLE PARTS INSIDE.
REFER SERVICING TO QUALIFIED SERVICE PERSONNEL.**

CAUTION:

TO PREVENT ELECTRIC SHOCK, DO NOT USE THIS POLARIZED AC PLUG WITH AN EXTENSION CORD, RECEPTACLE OR OTHER OUTLET UNLESS THE BLADES CAN BE FULLY INSERTED TO PREVENT BLADE EXPOSURE.

Note to CATV system installer in the U.S.A.

This reminder is provided to call the CATV system installer's attention to Article 820-40 of the NEC that provides guidelines for proper grounding and, in particular, specifies that the cable ground shall be connected to the grounding system of the building, as close to the point of cable entry as practical.



This symbol is intended to alert the user to the presence of uninsulated "dangerous voltage" within the product's enclosure that may be of sufficient magnitude to constitute a risk of electric shock to persons.



This symbol is intended to alert the user to the presence of important operating and maintenance (servicing) instructions in the literature accompanying the appliance.

Identify Your TV Before Use

In this manual, the instructions are given using the model with maximum functions. Please disregard information in the manual which contradicts with your TV.

First of all, please check the model number of your TV set. This manual applies to six models and there are slight differences among them. Please check the table below to see what is equipped with your TV before you begin the operation.

Table for each model YES: equipped NO: not equipped

	KV-13EXR90	KV-13EXR91	KV-13TR27/13TR24	KV-13TR14	KV-1427R
AUDIO/VIDEO input jacks	YES (3 phono jacks)	YES (3 phono jacks)	YES (2 phono jacks)	NO	NO
AUDIO output jacks	YES (variable)	YES (variable)	NO	NO	NO
TV/VIDEO button	YES	YES	YES	NO	NO
Supplied Remote Commander	RM-783	RM-783	RM-781	RM-780	RM-780
Model destination	U.S.A/Canada Latin America and other areas	U.S.A Latin America and other areas	U.S.A/Canada	U.S.A/Canada	Central and South America, and other areas

Contents

Before Use

Features	4
Precautions	4
Location of controls	5

Set-Up

Connecting TV antenna/cable	7
Connecting other optional equipment	10
Presetting TV channels	12

Operation

Watching TV programs	14
Adjusting the picture	15
Enjoying the convenient features	16
Timer/Block	17

General

Specifications	21
Troubleshooting	21

Features

Color monitor featuring a Mirrorblack™ Trinitron picture tube for high resolution, high contrast picture.

- **Multi-band VHF/UHF/CATV tuner** receives up to 125 cable channels for a total of 181 possible off-air and cable channels.
- **Built-in video input jack** for better quality picture of the connected VCR or other equipment (For KV-13EXR90, 13EXR91, 13TR24, 13TR27)
- **Variable audio output jacks** let you reproduce TV or video sound through an audio system. (For KV-13EXR90, 13EXR91)
- **On-screen displays**

Supplied Remote Commander provides you many other convenient features.

- **Timer/Block** for automatic program starting and channel blocking.
- **Sleep timer** automatically turns off the TV after approximately one hour.
- **Automatic programming** to preset all receivable channels instantly.
- **Jump button** to switch quickly between two channels.

And other features for high quality picture...

- **Dynamic color™ system** for superior color reproduction with natural facial color tones and dazzling whites.
- **Dynamic picture™ system** adjusts picture contrast automatically to produce more detail in both bright and dark areas of every scene.

Precautions

Safety

- Operate the unit only on 120 V AC.
- One blade of the plug is wider than the other for the purpose of safety and will fit into the power outlet only one way. If you are unable to insert the plug fully into the outlet, contact your dealer.
- Should any liquid or solid object fall into the cabinet, unplug the unit and have it checked by qualified personnel before operating it any further.
- Unplug the unit from the wall outlet if it is not going to be used for several days or more. To disconnect the cord, pull it out by the plug. Never pull the cord itself.

Installation

- To prevent internal heat build-up, do not block the ventilation openings.
- Do not install the unit in a hot or humid place or in a place subject to excessive dust or mechanical vibration.

Cleaning

Clean the unit with a slightly damp soft cloth. Use a mild household detergent. Never use strong solvents such as thinner or benzene as they might damage the finish of the cabinet.

Repacking

Retain the original carton and packing materials for safe transport of this unit in the future.

Use of this television receiver for other than private viewing of programs broadcast on UHF or VHF or transmitted by cable companies for the use of the general public may require authorization from the broadcaster/cable company and/or program owner.

If you have any questions or problems concerning your unit, please contact your nearest Sony dealer.

For details safety precautions, see the leaflet "IMPORTANT SAFEGUARDS".

Location of Controls

Refer to the page indicated in ● for details.

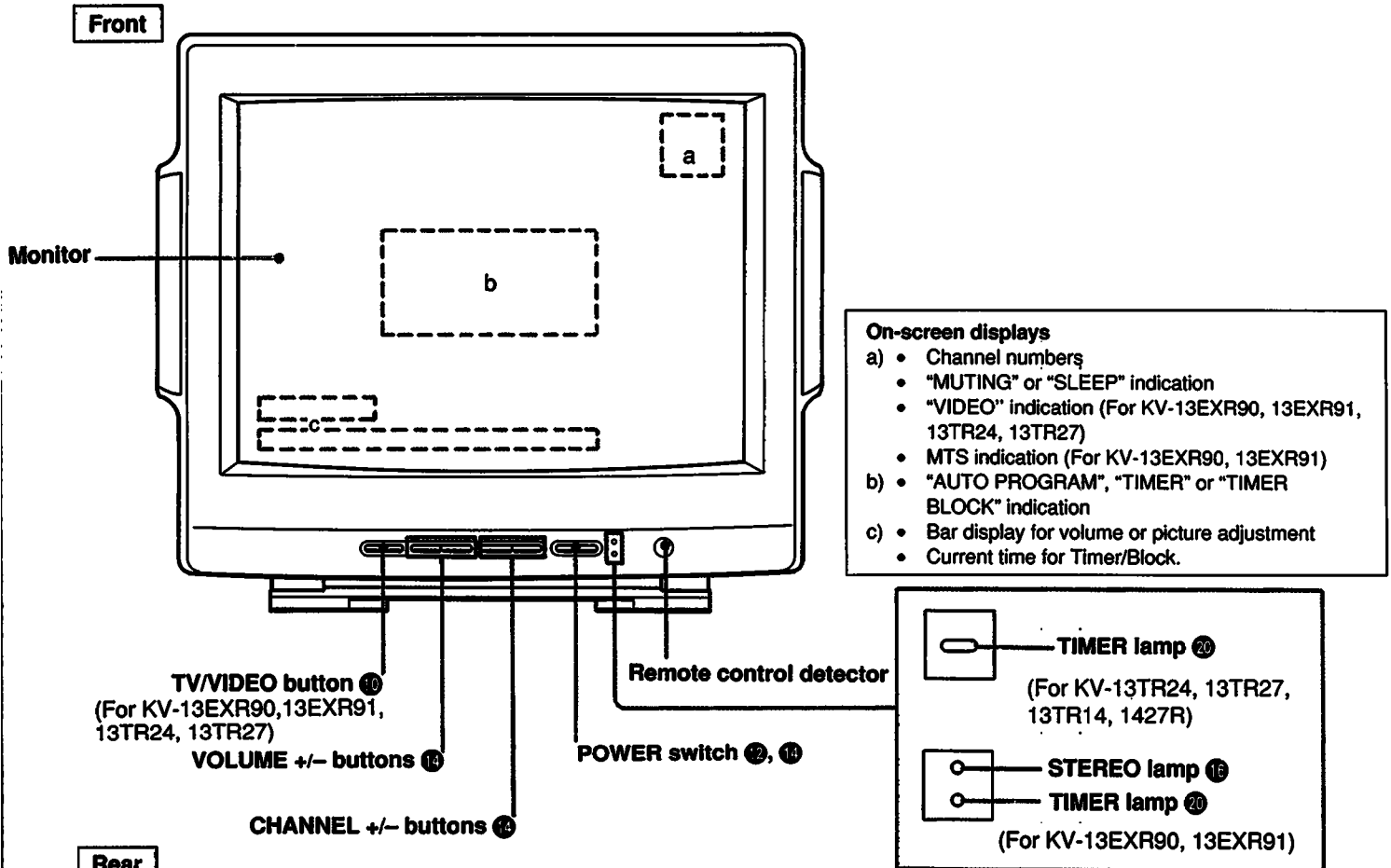

Rear

For KV-13TR24, 13TR27, 13TR14, 1427R

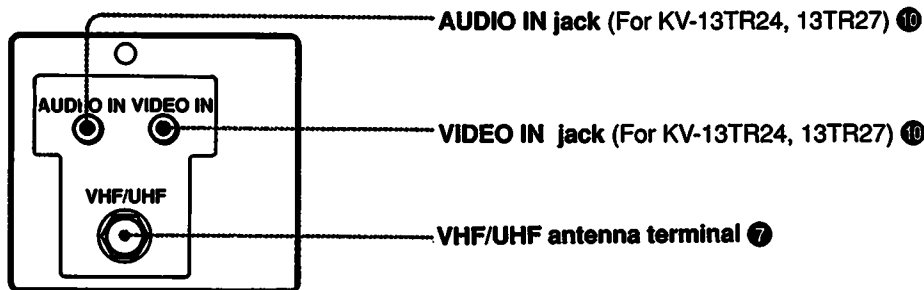

For KV-13EXR90, 13EXR91

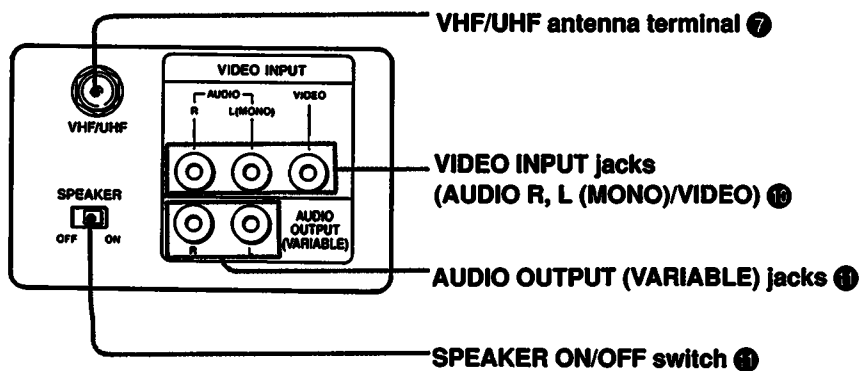

Location of Controls

Remote Commander RM-780/781/783

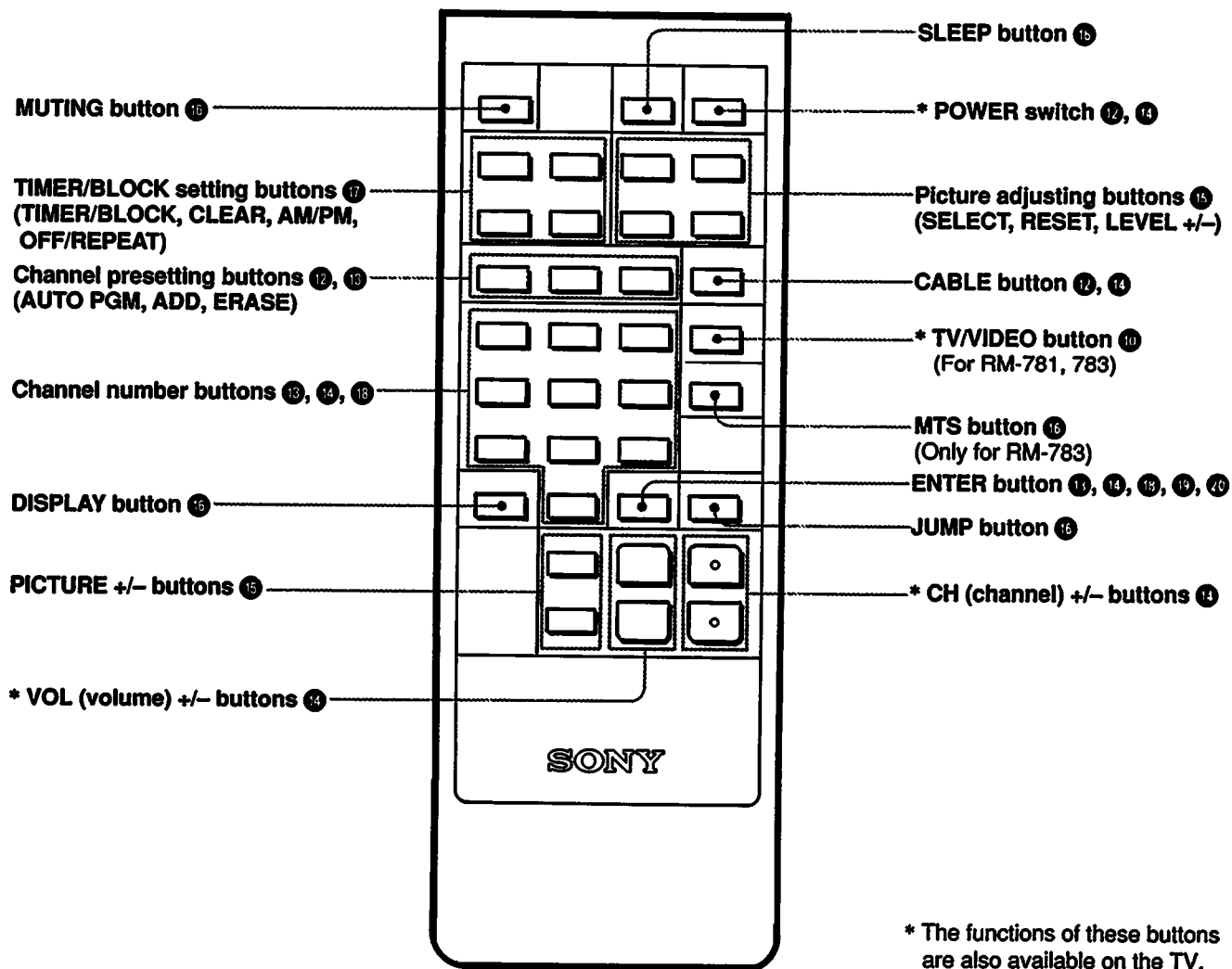

* The functions of these buttons are also available on the TV.

Battery Installation

1 Open the lid.

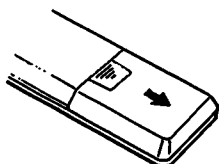

2 Insert two size AA (R6) batteries with correct polarity.

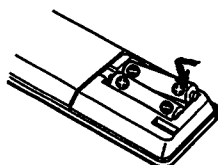

- In normal operation, batteries will last up to half a year. If the Commander does not operate properly, the batteries might be exhausted. Replace them with new ones.
- To avoid damage from possible battery leakage, remove the batteries when the Commander will not be used for a long time.
- If a Remote Commander that is not recommended is used to operate this TV, or if the supplied Remote Commander is used to operate another TV, the TV may not operate properly.

Connecting TV Antenna/Cable

Indoor Antenna Adjustment

For VHF/UHF reception, use the supplied telescopic dipole antenna.

Adjust the length, direction and angle of both elements symmetrically until the picture is clear.

For
KV-13TR24,
13TR27,
13TR14,
1427R

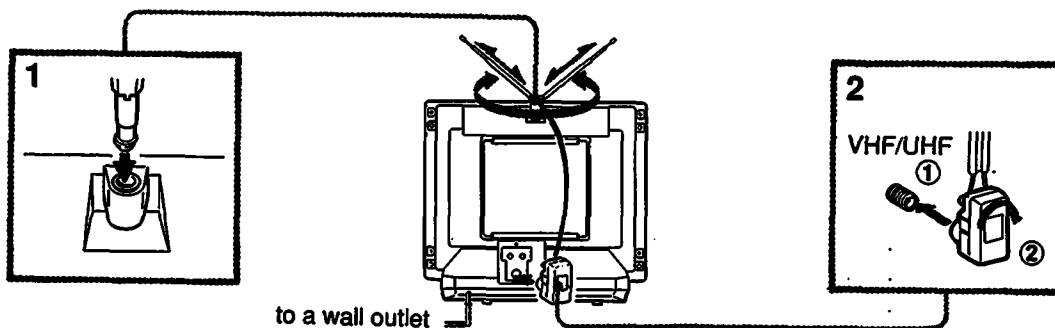

For
KV-13EXR90,
13EXR91

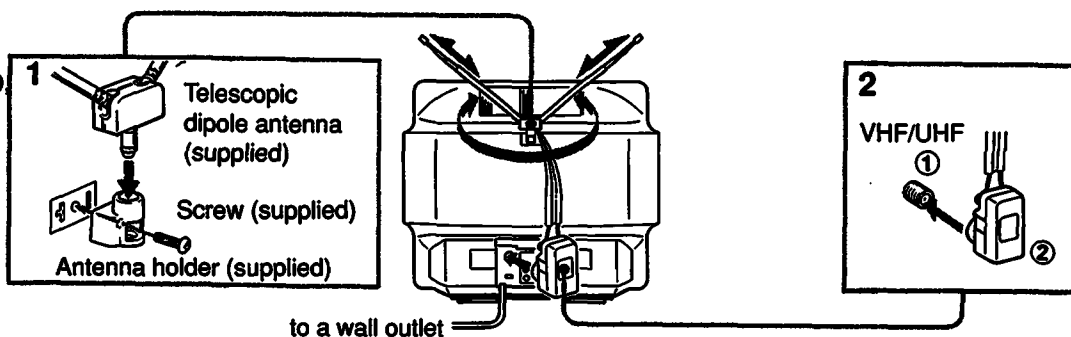

Connecting TV Antenna/Cable

Outdoor Antenna Connection

If you cannot obtain satisfactory reception with an indoor antenna, use an outdoor antenna.
Cable TV reception is only possible by connecting a cable supplied by your local cable operator.

To connect a VHF, UHF, or VHF/UHF combination antenna* or CATV cable

1 Check the cable type and prepare the cable end using the appropriate connector.

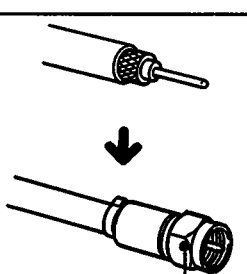
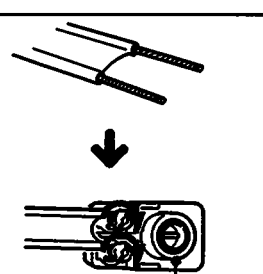

75-ohm coaxial cable (round)	300-ohm twin-lead cable (flat)
 Attach an optional F-type connector.	 Fasten with a screwdriver. Antenna connector

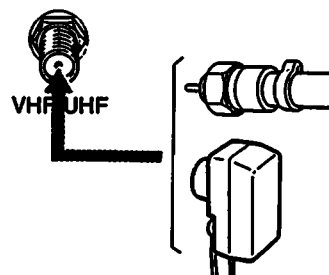
2 Plug the connector into VHF/UHF on the rear of the TV.

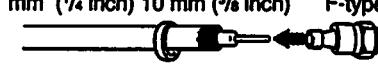

* Most combination antennas are equipped with a signal splitter. Remove the splitter and attach the appropriate connector.

How to attach an F-type connector to the 75-ohm coaxial cable

- 
- 
- 
- 

When you connect both VHF and UHF antennas

Use the optional EAC-66 U/V mixer.

- 1 Prepare the VHF antenna end using the appropriate connector.
- 2 Connect the cables to the mixer.
- 3 Plug the mixer to VHF/UHF.

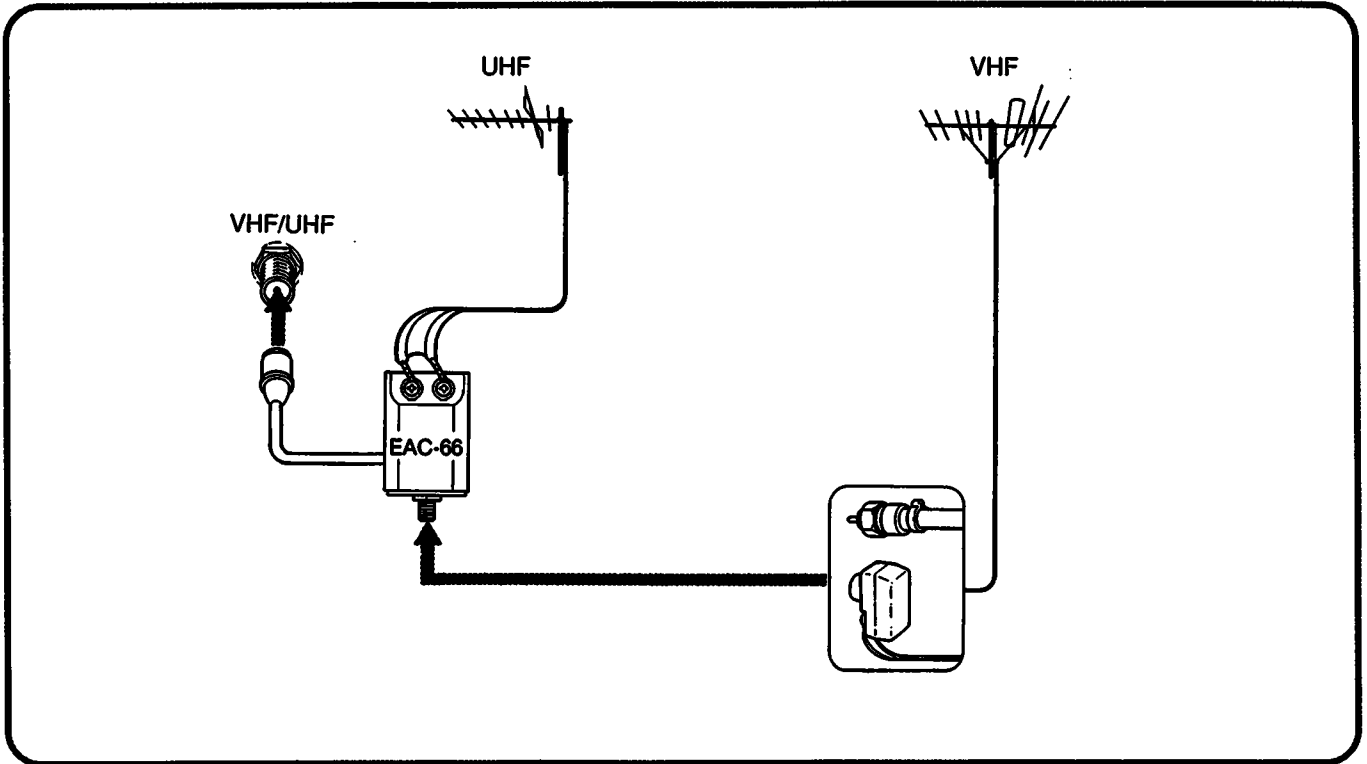

When the U/V mixer is used

Snow and noise may appear in the pictures of the cable TV channels over 37 (W + 1).

Connecting Other Optional Equipment

The AUDIO IN and VIDEO IN jacks are only equipped for KV-13EXR90, 13EXR91, 13TR24, 13TR27.

Connecting a VCR

KV-13EXR90, 13EXR91

Note: If you connect a monaural VCR, connect the audio output of the VCR to the L jack of the TV. The monaural sound is heard from both speakers.

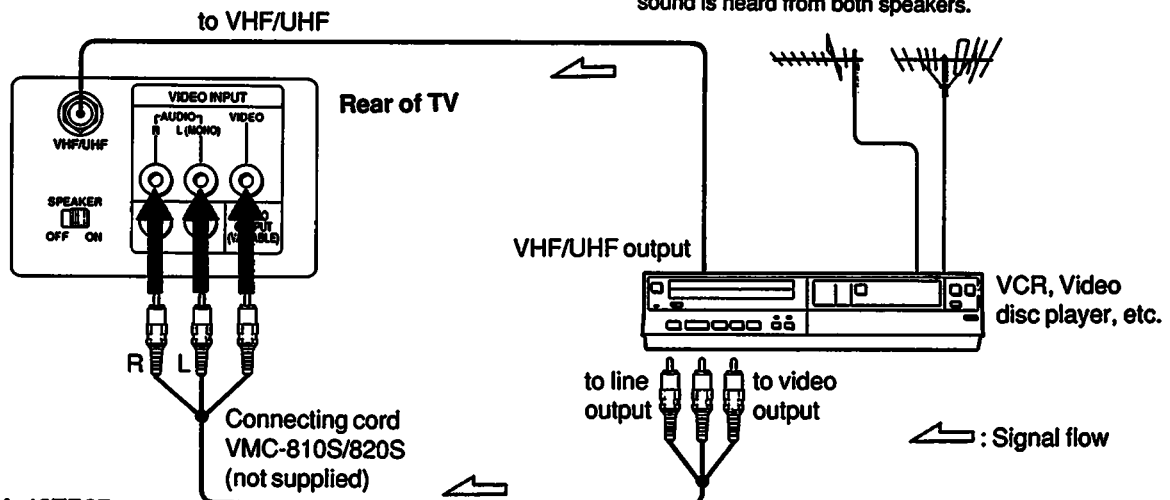

KV-13TR24, 13TR27

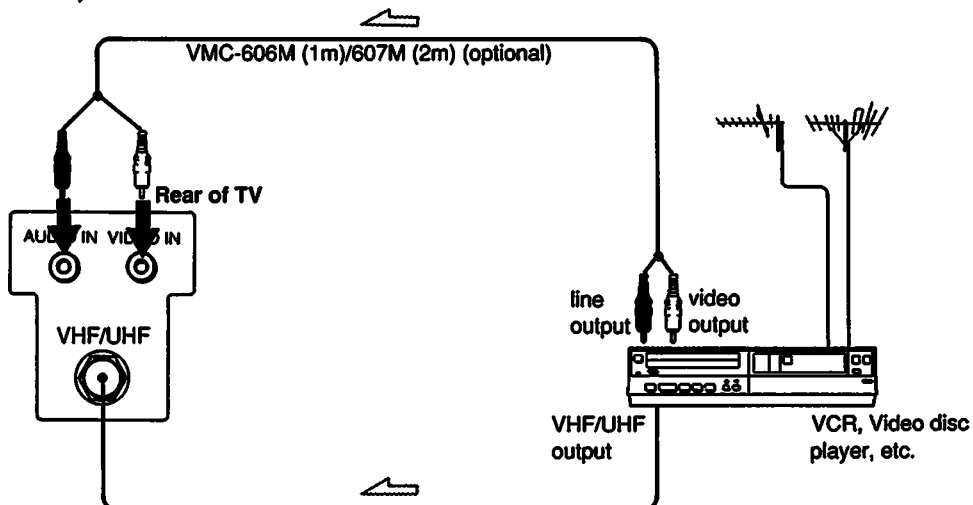

With this connection, you will be able to ...

- View the playback of video tapes
- Record TV programs
- Record a TV program while viewing another

To watch the VCR picture

- 1 Turn on the TV.
- 2 Press the TV/VIDEO button so that the "VIDEO" indication appears on the screen.
- 3 Set the VCR in playback mode.

To return to the TV mode

Press the TV/VIDEO button until a channel number appears on the screen.

- For operation, refer to the instruction manual furnished with the VCR.
- Keep the VCR away from the TV, if the picture or sound is affected.

- When no signal is fed through the VIDEO IN jack even though the TV is in the video mode, "VIDEO" indication will appear on the screen.

The AUDIO OUTPUT jacks are included only with models KV-13EXR90, 13EXR91.

Connecting an Audio System

KV-13EXR90, 13EXR91

To listen to the TV or connected VCR sound through an audio system

Rear of TV

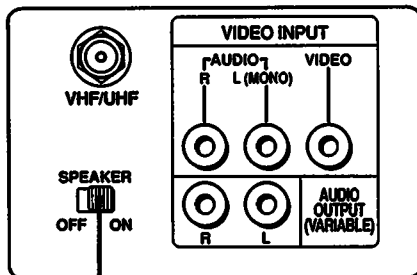

When an audio system is connected to **AUDIO OUTPUT**, be sure to set the **SPEAKER** switch at the rear of the TV to **OFF**. The sound from the TV's speakers will be cut off.

To adjust sound level

Leave the amplifier volume, bass and treble controls at their mid position, and adjust the level with the **VOLUME +/-** buttons on the TV or the **VOL +/-** buttons on the Commander.

Rear of TV

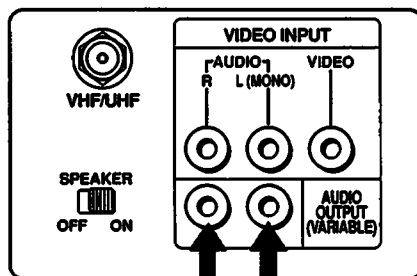

to AUDIO
OUTPUT
(VARIABLE)

R L

RK-74A connecting cord
(not supplied)

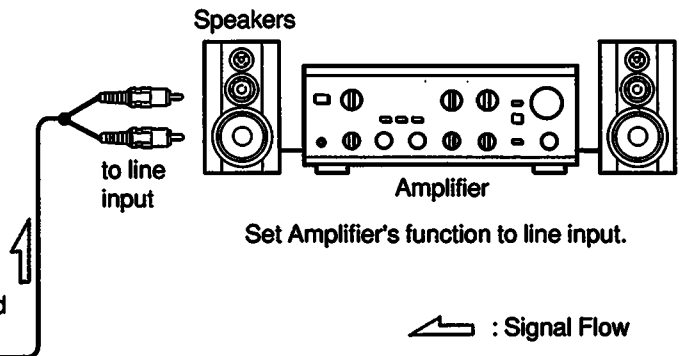

Presetting TV Channels

To Preset All Receivable Channels Automatically

KV-13TR24

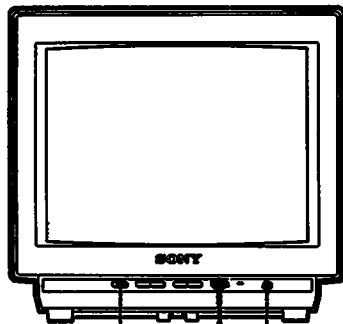

TV/VIDEO

1

Remote control detector

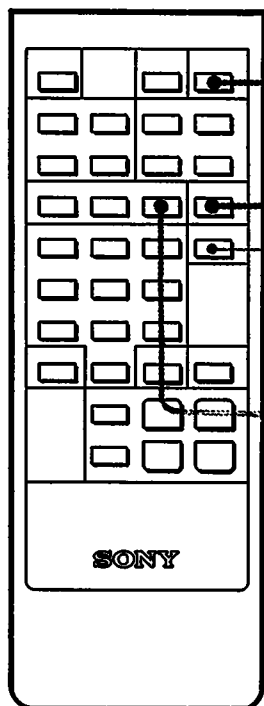

1

2

3

TV/VIDEO
(For
KV-13EXR90,
13EXR91,
13TR24,
13TR27)

SONY

RM-781

1

Press **POWER** on the TV or the Remote Commander to turn the TV on.



2

Press **CABLE** so that the appropriate mode appears.

CABLE



To preset VHF or UHF channels

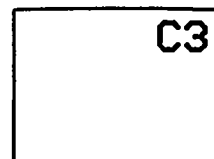

To preset cable TV channels

3

Press **AUTO PGM.**

AUTO PGM

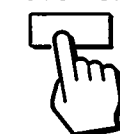

"AUTO PROGRAM" is displayed on the screen and receivable channels (other than the channels already preset) will be preset in numerical sequence. The channels previously preset remain in the unit's memory.

When no more channels can be found, the programming stops and the lowest numbered channel is displayed.

Receivable channels of this TV are:

VHF: 2-13

UHF: 14-69

Cable: 1-125

To add the channels that could not be preset with automatic programming because their signal strength was too weak, or to erase unnecessary channels, follow the steps in "To preset only the desired channels" on the next page.

To check preset channels

Press CH +/-.

For KV-13EXR90, 13EXR91, 13TR24, 13TR27

If the "VIDEO" indication is displayed on the screen Press the TV/VIDEO button on the TV or the Remote Commander so that a channel number appears.

To Preset Only the Desired Channel or to Erase Unnecessary Channels

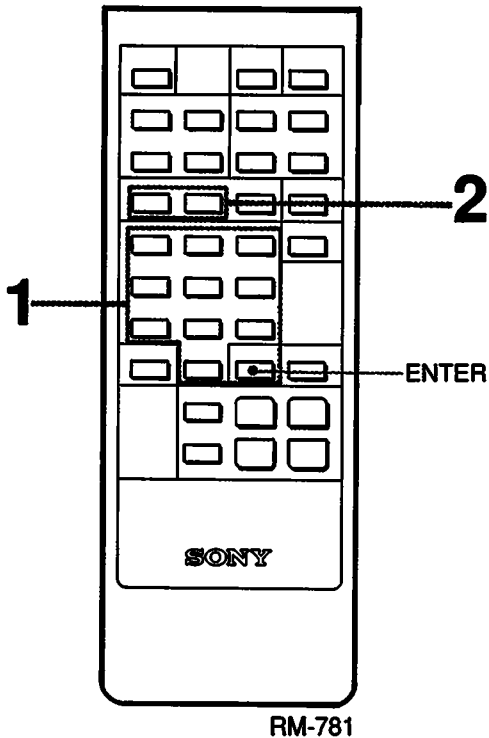

1 Press the channel number button(s) and then ENTER to select the channel to be added or erased.

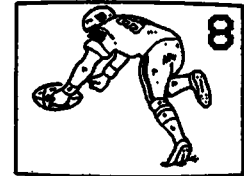
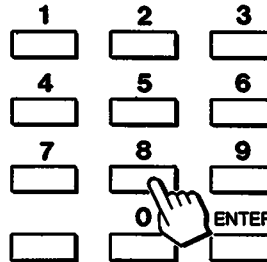

2 To add channels - Press ADD.



A "+" appears for a moment.
This channel has now been added to the channel scan memory.

To erase channels - Press ERASE.



A "-" appears for a moment.
This channel has now been erased from the channel scan memory.
The next time the CH +/- button is pressed, this channel will be skipped.

Repeat steps 1 and 2 for other channels to be added or erased.

When a VHF or UHF channel is erased
The cable TV channel with the same number is also erased and vice versa.

Cable TV channel chart*
Cable TV systems use letters or numbers to designate channels.
To tune in a channel, refer to the chart below.

Number on this TV	1	5	6	14	15	16	17	18	19	20	21	22	23	24	25	26	27	28	29	30				
Corresponding CATV channel	A-8	A-7	A-6	A	B	C	D	E	F	G	H	I	J	K	L	M	N	O	P	Q				
	31	32	33	34	35	36	37	38	39	93	94	95	96	97	98	99	100	101	102	123	124	125
	R	S	T	U	V	W	W+1	W+2	W+3	W+57	W+58	A-5	A-4	A-3	A-2	A-1	W+59	W+60	W+61	W+82	W+83	W+84

Check with your local cable TV company for more complete information on the available channels.

* The designation of the cable TV channels conforms to the EIA/NCTA recommendation.

Note

Pay cable TV systems use scrambled or encoded signals and require special converters (decoders) in addition to the normal cable connection.

Watching TV Programs

KV-13TR24

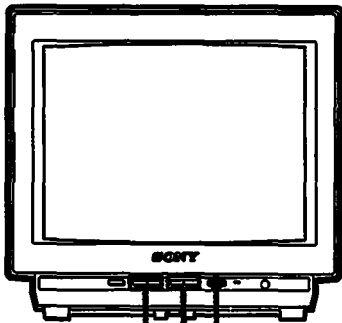

4 3 1

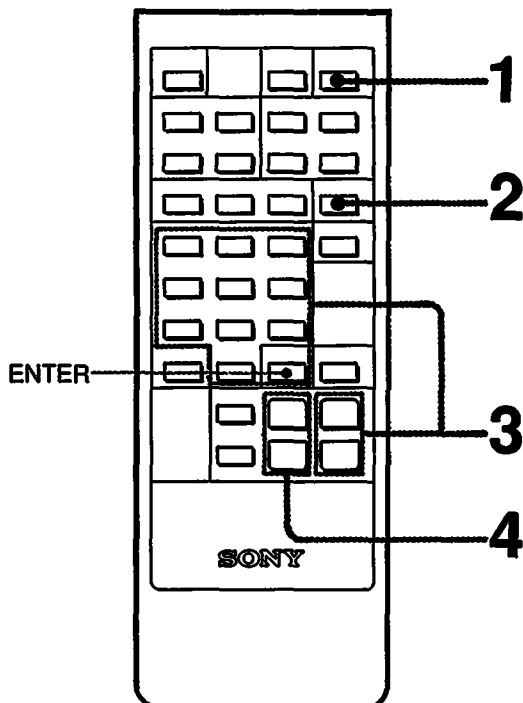

RM-781

- 1** Press **POWER** on the TV or the Remote Commander to turn the TV on.



- 2** Press **CABLE** so that the appropriate mode appears.

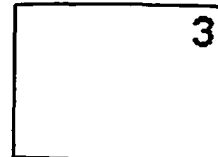
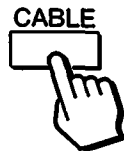

To view VHF or UHF channels

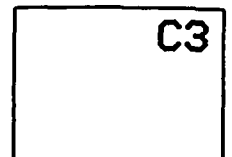

To view cable TV channels

- 3** Select a channel in one of the following two ways:

To scan the preset channels in numerical sequence, press CH +/-.

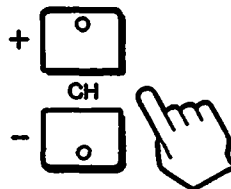

To select a channel directly, press the channel number button(s) and then ENTER. For example, to select channel 10, press 1, 0 and ENTER.

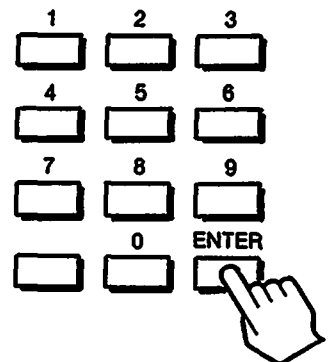

- 4** Press **VOL +** or **-** to adjust the volume.

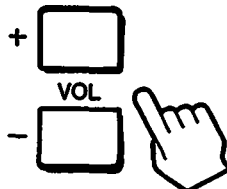

Note

To turn off the TV

Press **POWER** on the TV or the Remote Commander again.

Adjusting the Picture

Press **SELECT** repeatedly until the on-screen display of the item to be adjusted appears, then press **LEVEL +/-**.

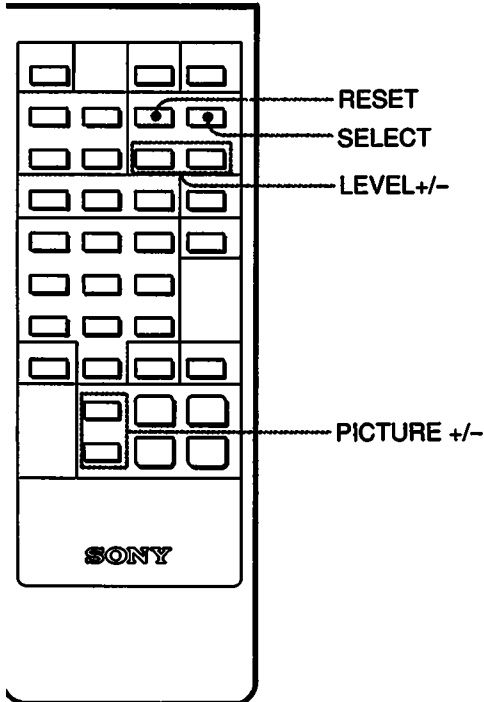

RM-781

HUE

- LEVEL +

Skin tones become purplish

Skin tones become greenish

COLOR

- LEVEL +

To decrease color intensity

To increase color intensity

BRIGHT (brightness)

- LEVEL +

Darker

Brighter

SHARP (sharpness)

- LEVEL +

Softer

Sharper

To adjust picture contrast

Press to increase picture contrast with vivid color.

Press to decrease picture contrast with soft color.

To clear the adjustment levels and restore the factory preset levels at once, press **RESET**.

Enjoying the Convenient Features

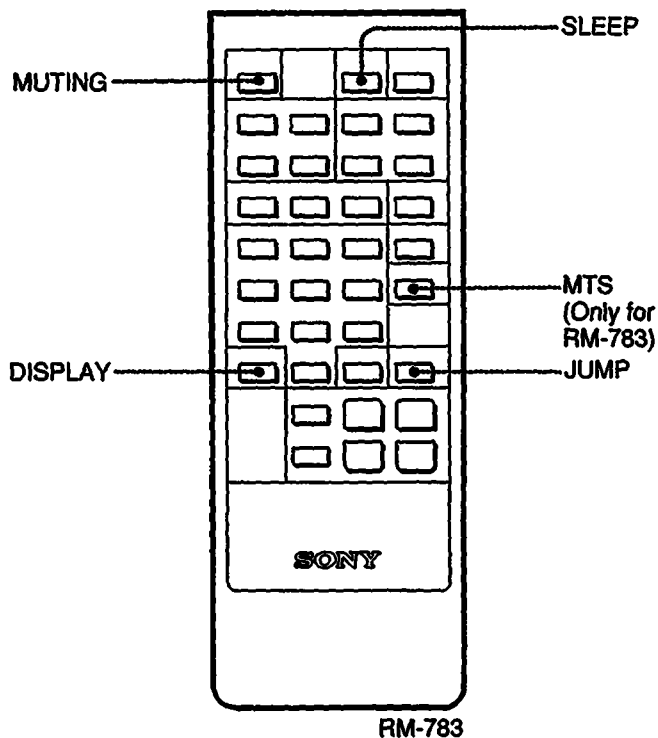

RM-783

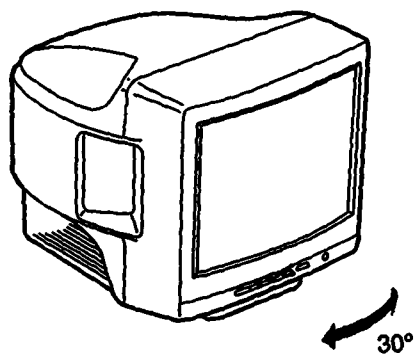

Muting the sound

Press **MUTING**.

The "MUTING" indication will appear on the screen. To restore the sound, press **MUTING** again or **VOL +**.

Keeping the channel displayed

Press **DISPLAY**.

To make the channel display disappear, press **DISPLAY** again.

Using the SLEEP timer

Press **SLEEP**.

The TV will be turned off automatically after about one hour. The green "SLEEP ON" indication will appear on the screen for a few seconds when **SLEEP** is pressed and the red "SLEEP" indication will appear one minute before the TV is turned off.

To cancel the **SLEEP** timer, press **SLEEP** again, or turn off the TV. The "SLEEP OFF" indication will appear when **SLEEP** is pressed again.

Switching quickly between two channels

Press **JUMP**.

Each time **JUMP** is pressed, the channel which appeared on the screen directly before is recalled. This button enables you to keep track of two programs alternately.

Adjusting the Swivel (For KV-13EXR90, 13EXR91)

You can adjust the angle by 15 degrees in each direction.

Receiving a Multichannel TV Sound Program - MTS button (For KV-13EXR90, 13EXR91)

Each time you press **MTS**, the **MAIN**, **SAP** (Second Audio Program) and **MONO** modes are selected in sequence. The display (in green) for each mode will appear on the screen for a few seconds.

(NOTE: During **SAP** mode, the sound of non-**SAP** programs will be muted.)

TO LISTEN TO STEREO SOUND:

1. Press **MTS** to select the **MAIN** mode.
2. The **MAIN** display will appear on screen.
3. The **STEREO** indicator lamp on the TV will light up whenever a stereo broadcast is received.

NOTE

A weak incoming signal may cause excessive noise with some stereo broadcasts. Switch to **MONO** mode to eliminate this noise.

Timer/Block

Available Functions

Internal clock	Once the internal clock is set, the current time will appear on the screen. It is necessary to set the clock correctly to activate the program start TIMER and channel BLOCK .
Program start TIMER	Makes a program of your choice appear on the screen automatically at the desired time.
Channel BLOCK	Blocks a channel from appearing on the screen for 12 hours. Use channel BLOCK to prevent children from watching undesirable programs.

The buttons used for the above functions are located on the Remote Commander.

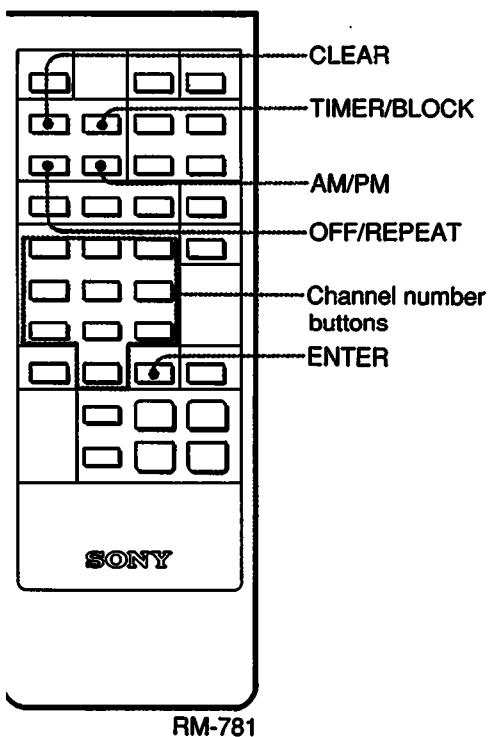

To set the internal clock, program start **TIMER** and channel **BLOCK**, you must summon the corresponding "pages": "clock page," "TIMER page" and "BLOCK page."
To change the "pages", press **TIMER/BLOCK**.
T/B stands for the **TIMER/BLOCK** button.

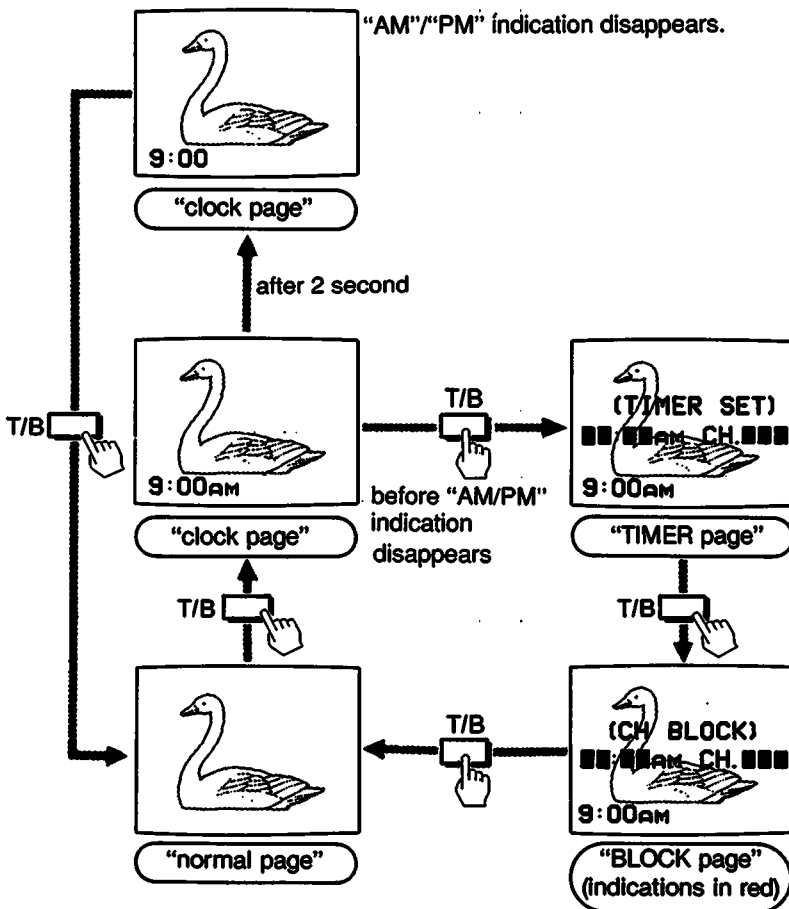

- All settings will be erased from the unit's memory if the unit is unplugged, or if a power failure occurs.
- The **TIMER** and **BLOCK** will operate only if the clock is set correctly.
- If the **TIMER** and **BLOCK** are set for overlapping times on the same channel, the blocked channel will appear on the screen at the time set on the **TIMER**.

How to Set the Internal Clock

Example: To set the clock to 8:05 PM

- 1** Press TIMER/BLOCK once to change from "normal page" to "clock page."

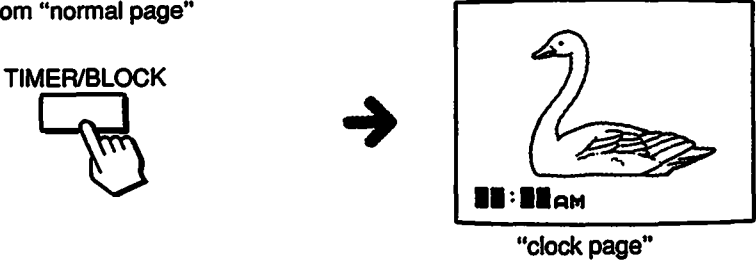
- 2** Press 0, 8, 0, 5 AM/PM (0 necessary).

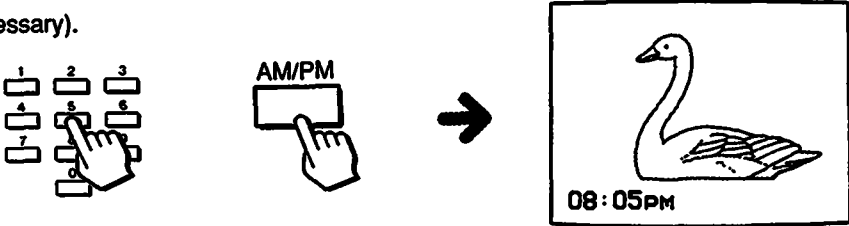
- 3** If you have performed the operation correctly, press ENTER. The numbers will "wink" to indicate that the clock has been set. (The 0 in front will disappear.)

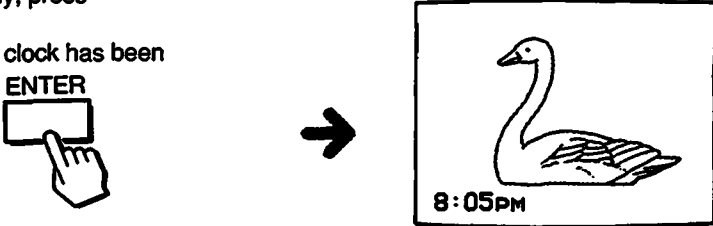

If you have made a mistake, press CLEAR and return to step 2. The "AM/PM" indication will disappear after 2 seconds.

To summon "TIMER page," press TIMER/BLOCK before the "AM"/"PM" indication disappears.

To return to "normal page," press TIMER/BLOCK after the "AM"/"PM" indication has disappeared.

To reset the clock, summon "clock page" and press CLEAR before the "AM"/"PM" indication disappears. Then follow the steps above from step 2.

12:00 AM stands for midnight.
12:00 PM stands for noon.

How to Set the Channel BLOCK

Make sure that the clock has been set correctly before setting the channel BLOCK.

Example: To set the BLOCK for a program which begins at 9:30 AM on channel 8

- 1** Press TIMER/BLOCK three times to change from "normal page" to "BLOCK page."

TIMER/BLOCK

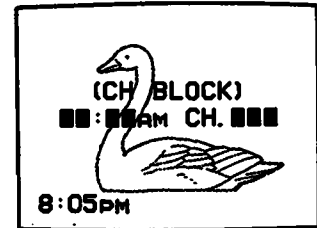

"BLOCK page"
(indications in red)

- 2** Press 0, 9, 3, 0, ENTER (0 necessary). Numbers will "wink" to indicate that the time has been set. Press 8, ENTER (0 not necessary). Numbers will "wink" to indicate that the channel has been set.

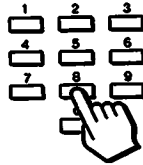

ENTER

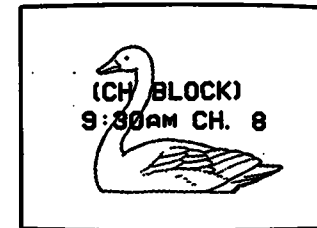

The BLOCK has now been set.

If you have made a mistake, press CLEAR and return to step 2.

At the preset time, the picture of the selected channel will be blocked from view and the sound will be muted. A red "BLOCKED" indication will appear on the screen while the channel is blocked. Normal reception will be resumed after 12 hours.

To return to normal reception while the channel is blocked, recall "BLOCK page" and press CLEAR.

The BLOCK setting blocks a specified channel for the same 12-hour period everyday.



To clear BLOCK setting, summon "BLOCK page" and press CLEAR.

To reset, clear the setting and follow the steps above from step 2.

How to Set the Program Start TIMER

Make sure that the clock has been set correctly before setting the program start TIMER.

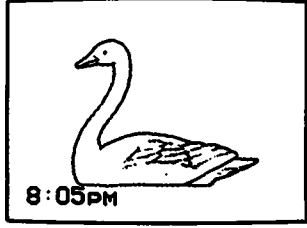
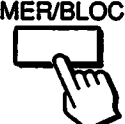
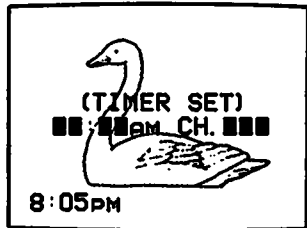
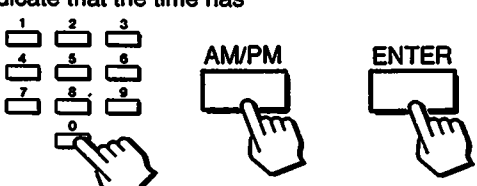
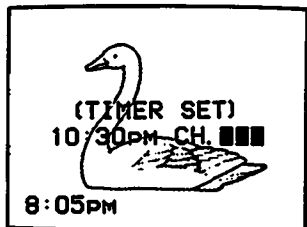
Example: To set the TIMER for a program which begins at 10:30 PM on channel 12

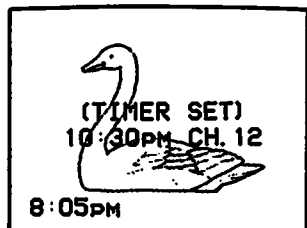
<p>1 Press TIMER/BLOCK once to change from "normal page" to "clock page."</p>	<p>TIMER/BLOCK</p> 	 <p>8:05PM</p> <p>"clock page"</p>
<p>2 Press TIMER/BLOCK before the "AM"/"PM" indication disappears and summon "TIMER page."</p>	<p>TIMER/BLOCK</p> 	 <p>(TIMER SET) 8:05PM CH. ■■■</p> <p>8:05PM</p> <p>"TIMER page"</p>
<p>3 Press 1, 0, 3, 0, AM/PM, ENTER. Numbers will "wink" to indicate that the time has been set.</p>		 <p>(TIMER SET) 10:30PM CH. ■■■</p> <p>8:05PM</p>
<p>4 Press 1, 2, ENTER (0-not necessary). Numbers will "wink" to indicate that the channel has been set.</p> <p>The TIMER lamp will light up to indicate that the TIMER has been set.</p>		 <p>(TIMER SET) 10:30PM CH. 12</p> <p>8:05PM</p>

If you have made a mistake, press CLEAR and return to step 3.

At the preset time, the selected channel will appear on the screen and the TIMER lamp will go out. The TIMER will operate whether you are watching a TV program or a VCR playback, or even if you have turned off the TV.

If no button is pressed within 2 hours after the preset time, an "OFF" indication will appear on the screen for 1 minute. If a button is still not touched during the 1 minute, the TV will turn off automatically as a safety precaution.

The TIMER operates only once, but the time and the channel will remain in the unit's memory.

If you want to preset the same channel at the same time for a future date, press OFF/REPEAT. The TIMER lamp will light up to indicate that the TIMER has been reactivated.

If you want to deactivate the TIMER, press OFF/REPEAT again so that the TIMER lamp goes out. It is not necessary to summon "TIMER page" to use the OFF/REPEAT button. Furthermore, this button is effective even if the TV has been turned off.

To clear the TIMER setting, summon "TIMER page" and press CLEAR.

To reset, clear the setting and follow the steps from step 3.



Specifications

- Television system** American TV standards
- Channel coverage** VHF: 2-13
UHF: 14-69
Cable TV: 1-125
- Picture tube** Mirrorblack Trinitron tube
13-inch picture measured diagonally
14-inch picture tube measured diagonally
- Input** (KV-13EXR90, 13EXR91)
VIDEO INPUT (phono jacks)
Video: 1 Vp-p, 75-ohms unbalanced, sync negative
Audio: 500 mVrms (100% modulation)
Impedance: 10 kilohms
- (KV-13TR24, 13TR27)
VIDEO IN (phono jack): 1 Vp-p, 75-ohms unbalanced, sync negative
AUDIO IN (phono jack): 408 mVrms (100% modulation)
Impedance: 47 kilohms
- Output** (Only for KV-13EXR90, 13EXR91)
AUDIO OUTPUT (VARIABLE) (phono jacks)
More than 408 mVrms at the maximum volume setting (variable) (100 % modulation)
- Power requirements** 120 V AC, 60 Hz
- Power consumption** 97 W (max.) (KV-13TR24, 13TR27, 13TR14, 1427R)
100 W (max.) (KV-13EXR90, 13EXR91)
- Accessories supplied**
Remote Commander RM-780 (1) size AA (R6) EVEREADY batteries (2) (KV-13TR14, KV-1427R)
Remote Commander RM-781 (1) size AA (R6) EVEREADY batteries (2) (KV-13TR24, 13TR27)
Remote Commander RM-783 (1) size AA (R6) EVEREADY batteries (2) (KV-13EXR90, 13EXR91)
VHF/UHF telescopic dipole antenna (1)
Antenna connector (1)
Antenna holder (1) (KV-13EXR90, 13EXR91)
Screw (1) (KV-13EXR90, 13EXR91)
- Optional accessories**
U/V mixer EAC-66
Connecting cord VMC-606M/607M, etc.

Design and specifications are subject to change without notice.

Troubleshooting

Disturbances in picture and sound can often be eliminated by checking the symptoms and following the suggestions listed below.

	SYMPTOM	CHECK AND ADJUST
GENERAL	Poor or no picture (screen not lit), good sound	<ul style="list-style-type: none"> Adjust PICTURE. Adjust BRIGHT. Check antenna/cable connections.
	Good picture, no sound	<ul style="list-style-type: none"> Press VOLUME +. Release MUTING. Check that the TV/ VIDEO button is set correctly.
	No picture (screen not lit), no sound	<ul style="list-style-type: none"> Is POWER switched on? Power in outlet? Check that the TV/ VIDEO button is set correctly.
	No color	<ul style="list-style-type: none"> Is it a color program? Adjust COLOR.
	Snow and noise only	<ul style="list-style-type: none"> Is it an active or the correct channel? Check the CABLE selector setting. Check antenna/cable connections.
	 Dotted lines or stripes	This is often caused by local interference. (e.g. cars, neon signs, hairdryers, etc.) Adjust antenna for minimum interference.
 Double images or ghosts	Reflections from nearby mountains or buildings often cause this problem. A highly directional outdoor antenna or a CATV cable may improve the picture.	
	Try another channel. It could be station trouble.	
TIMER/BLOCK	Program start TIMER and/or channel BLOCK does not operate properly.	<ul style="list-style-type: none"> Is the clock set correctly? Is the setting correct? Have you unplugged the unit? Has a power failure occurred? If so, the settings have been erased.

If the problem persists, contact your nearest service facility.

Free Manuals Download Website

<http://myh66.com>

<http://usermanuals.us>

<http://www.somanuals.com>

<http://www.4manuals.cc>

<http://www.manual-lib.com>

<http://www.404manual.com>

<http://www.luxmanual.com>

<http://aubethermostatmanual.com>

Golf course search by state

<http://golfingnear.com>

Email search by domain

<http://emailbydomain.com>

Auto manuals search

<http://auto.somanuals.com>

TV manuals search

<http://tv.somanuals.com>