



FD Trinitron
WEGA[®]

Operating Instructions

KV-20FS120
KV-24FS120

WARNING

To reduce the risk of fire or electric shock, do not expose the TV to rain or moisture.

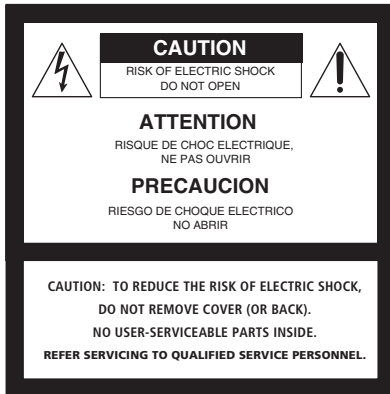

This symbol is intended to alert the user to the presence of uninsulated “dangerous voltage” within the product’s enclosure that may be of sufficient magnitude to constitute a risk of electric shock to persons.



This symbol is intended to alert the user to the presence of important operating and maintenance (servicing) instructions in the literature accompanying the appliance.

Note to the CATV Installer

This reminder is provided to call the CATV system installer’s attention to Article 820-40 of the NEC that provides guidelines for proper grounding and, in particular, specifies that the cable ground shall be connected to the grounding system of the building as close to the point of cable entry as practical.

SAFETY PRECAUTIONS

- Operate the TV only on 120 V AC.
- One blade of the power plug is wider than the other for safety purposes and will fit into the power outlet only one way. If you are unable to insert the plug fully into the outlet, contact your dealer.
- If any liquid or solid object falls into the TV, unplug it and have it checked by qualified personnel before operating it further.

CAUTION

When using TV games, computers, and similar products with your TV, keep the brightness and contrast functions at low settings. If a fixed (non-moving) pattern is left on the screen for long periods of time at a high brightness or contrast setting, the image can be permanently imprinted onto the screen. Continuously watching the same channel can cause the imprint of station logos onto the TV screen. These types of imprints are not covered by your warranty because they are the results of misuse.



To reduce the risk of electric shock, do not use this polarized plug with an extension cord, receptacle, or other outlet unless the blades can be fully inserted to prevent blade exposure.



You are cautioned that any changes or modifications not expressly approved in this manual could void your authority to operate this equipment.

NOTIFICATION

This equipment has been tested and found to comply with the limits for a Class B digital device pursuant to Part 15 of the FCC Rules. These limits are designed to provide reasonable protection against harmful interference in a residential installation. This equipment generates, uses, and can radiate radio frequency energy and, if not installed and used in accordance with the instructions, may cause harmful interference with radio communications. However, there is no guarantee that interference will not occur in a particular installation. If this equipment does cause harmful interference to radio or television reception, which can be determined by turning the equipment off and on, the user is encouraged to try to correct the interference by one or more of the following measures:

- Reorient or relocate the receiving antennas.
- Increase the separation between the equipment and receiver.
- Connect the equipment into an outlet on a circuit different from that to which the receiver is connected.
- Consult the dealer or an experienced radio/TV technician for help.

Protecting the TV

- To prevent internal heat build-up, do not block the ventilation openings.
- Do not install the TV in a hot or humid place, or in a place subject to excessive dust or mechanical vibration.

Note on Caption Vision

This television receiver provides display of television closed captioning in accordance with § 15.119 of the FCC rules. Use of this television for other than private viewing of programs broadcast on UHF or VHF or transmitted by cable companies for the use of the general public may require authorization from the broadcaster-cable company and/or program owner.

Owner’s Record

The model and serial numbers are located on the front cover of this manual and at the rear of your TV.

Trademarks and Copyrights

ENERGY STAR® is a registered mark.

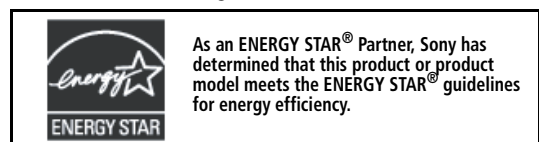

WEGA®, FD Trinitron, Caption Vision and Steady Sound are registered trademarks of Sony Corporation.

IMPORTANT SAFEGUARDS

For your protection, please read these instructions completely, and keep this manual for future reference. Carefully observe and comply with all warnings, cautions and instructions placed on the set, or described in the operating instructions or service manual.

WARNING

To guard against injury, the following basic safety precautions should be observed in the installation, use, and servicing of the set.

Use

Power Sources

This set should be operated only from the type of power source indicated on the serial/model plate. If you are not sure of the type of electrical power supplied to your home, consult your dealer or local power company. For those sets designed to operate from battery power, refer to the operating instructions.



Grounding or Polarization

This set may be equipped with a polarized alternating current line plug (a plug having one blade wider than other). This plug will fit into the power outlet only one way. This is a safety feature. If you are unable to insert the plug fully into the outlet, try reversing the plug. If the plug still fails to fit, contact your electrician to replace your obsolete outlet. Do not defeat the safety purpose of the polarized plug.

For the set with a polarized AC power cord plug

This plug will fit into the power outlet only one way. This is a safety feature. If you are unable to insert the plug fully into the outlet, try reversing the plug. If the plug still fails to fit, contact your electrician to have a suitable outlet installed. Do not defeat the safety purpose of the polarized plug by forcing it in.



Alternate Warning

For the set with a three-wire grounding type AC plug

This plug will only fit into a grounding-type power outlet. This is a safety feature. If you are unable to insert the plug into the outlet, contact your electrician to have a suitable outlet installed. Do not defeat the safety purpose of the grounding plug.

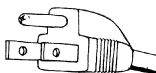

Overloading

Do not overload wall outlets, extension cords, or convenience receptacles beyond their capacity, since this can result in fire or electric shock.

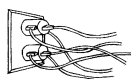

Always turn the set off when it is not to be used. When the set is left unattended and unused for long periods of time, unplug it from the wall outlet as a precaution against the possibility of an internal malfunction that could create a fire hazard.

Do not disconnect the antenna or the power cord during a heavy storm. Lightning may strike while you are holding the cable or cord, causing serious injury. Turn off your TV and wait for the weather to improve.

Object and Liquid Entry

Never push objects of any kind into the set through the cabinet slots as they may touch dangerous voltage points or short out parts that could result in a fire or electric shock. Never spill liquid of any kind on the set.



Attachments

Do not use attachments not recommended by the manufacturer, as they may cause hazards.

Do not place any objects, especially heavy objects, on top of the set. The object may fall from the set, causing injury.



Cleaning

Unplug the set from the wall outlet before cleaning or polishing it. Do not use liquid cleaners or aerosol cleaners. Use a cloth lightly dampened with water for cleaning the exterior of the set.



If a snapping or popping sound from a TV set is continuous or frequent while the TV is operating, unplug the TV and consult your dealer or service technician. It is normal for some TV sets to make occasional snapping or popping sounds, particularly when being turned on or off.



Installation

Always use two or more people to lift or move the set. The set is heavy and the bottom surface is flat. Serious injury can result from trying to move the set by yourself alone, or from unsteady handling.

Install the set on a stable, level surface.

Water and Moisture

Do not use power-line operated sets near water — for example, near a bathtub, washbowl, kitchen sink, or laundry tub, in a wet basement, or near a swimming pool, etc.



Accessories

Do not place the set on an unstable cart, stand, tripod, bracket, table, or shelf. The set may fall, causing serious injury to a child or an adult, and serious damage to the set.

Use only a cart or stand recommended by the manufacturer for the specific model of TV. Any mounting of the product should follow the manufacturer's instructions, and should use a mounting accessory recommended by the manufacturer. An appliance and cart combination should be moved with care. Quick stops, excessive force, and uneven surfaces may cause the appliance and cart combination to overturn.



Ventilation

The slots and openings in the cabinet and in the back or bottom are provided for necessary ventilation. To ensure reliable operation of the set, and to protect it from overheating, these slots and openings must never be blocked or covered.

- **Never cover the slots and openings with a cloth or other materials.**



- **Never block the slots and openings by placing the set on a bed, sofa, rug or other similar surface.**

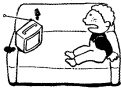

- **Never place the set in a confined space, such as a bookcase or built-in cabinet, unless proper ventilation is provided.**



- **Do not place the set near or over a radiator or heat register, or where it is exposed to direct sunlight.**



Power-Cord Protection

Do not allow anything to rest on or roll over the power cord, and do not place the set where the power cord is subject to wear or abuse.



Antennas

Outdoor Antenna Grounding

If an outdoor antenna is installed, follow the precautions below. An outdoor antenna system should not be located in the vicinity of overhead power lines or other electric light or power circuits, or where it can come in contact with such power lines or circuits.

WHEN INSTALLING AN OUTDOOR ANTENNA SYSTEM, EXTREME CARE SHOULD BE TAKEN TO KEEP FROM CONTACTING SUCH POWER LINES OR CIRCUITS AS CONTACT WITH THEM IS ALMOST INVARIABLY FATAL.

Be sure the antenna system is grounded so as to provide some protection against voltage surges and built-up static charges. Section 810 of the National Electrical Code (NEC) in USA and Section 54 of the Canadian Electrical Code in Canada provides information with respect to proper grounding of the mast and supporting structure, grounding of the lead-in wire to an antenna discharge unit, size of grounding conductors, location of antenna discharge unit, connection to grounding electrodes, and requirements for the grounding electrode.

Antenna Grounding According to the NEC

Antenna Grounding According to the National Electrical Code, ANSI/NFPA 70.

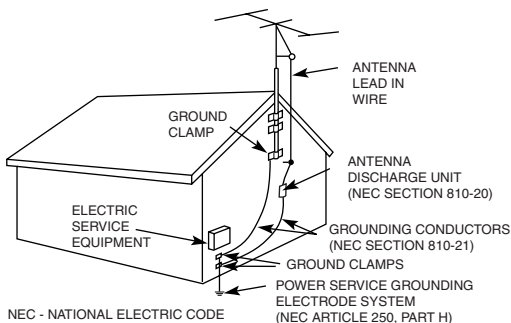

Lightning

For added protection for this television receiver during a lightning storm, or when it is left unattended and unused for long periods of time, unplug it from the wall outlet and disconnect the antenna. This will prevent damage to the receiver due to lightning and power-line surges.

Service

Damage Requiring Service

Unplug the set from the wall outlet and refer servicing to qualified service personnel under the following conditions:

- **When the power cord or plug is damaged or frayed.**



- **If liquid has been spilled into the set or objects have fallen into the product.**



- **If the set has been exposed to rain or water.**



- **If the set has been subject to excessive shock by being dropped, or the cabinet has been damaged.**



- **If the set does not operate normally when following the operating instructions. Adjust only those controls that are specified in the operating instructions. Improper adjustment of other controls may result in damage and will often require extensive work by a qualified technician to restore the set to normal operation.**



- **When the set exhibits a distinct change in performance — this indicates a need for service.**

Servicing

Do not attempt to service the set yourself since opening the cabinet may expose you to dangerous voltage or other hazards. Refer all servicing to qualified service personnel.



Replacement Parts

When replacement parts are required, be sure the service technician certifies in writing that he has used replacement parts specified by the manufacturer that have the same characteristics as the original parts. Unauthorized substitutions may result in fire, electric shock, or other hazards.



Safety Check

Upon completion of any service or repairs to the set, ask the service technician to perform routine safety checks (as specified by the manufacturer) to determine that the set is in safe operating condition, and to so certify. When the set reaches the end of its useful life, improper disposal could result in a picture tube implosion. Ask a qualified service technician to dispose of the set.



Contents

Introduction

Introducing the FD Trinitron WEGA [®] Features	1
About this Manual	2
Batteries for the Remote Control	2
Front Panel Menu Controls	2

Using the Remote Control

Remote Control Description.....	3
---------------------------------	---







Connecting Your TV

TV Rear Panel.....	5
Basic Connections	6
Connecting Additional Equipment.....	7

Using Basic Functions

Quick Start to the Menus	16
--------------------------------	----

Using the Menus

How to Access Menus.....	19
Using the Video Menu 	20
Using the Audio Menu 	21
Using the Channel Setup Menu 	22
Using the Parental Control Menu 	24
Parental Control.....	25
United States: Selecting Custom Rating Options	27
Canada: Selecting Custom Rating Options	29
Using the Timer Menu 	30
Using the Setup Menu 	31

Other Information

Troubleshooting	33
Specifications	36

Index.....	37
------------	----

Introduction

Congratulations on your purchase of the Sony FD Trinitron WEGA[®]. Before you begin using this manual, please check the model number located on the rear of your TV or on the front cover of this manual.

Introducing the FD Trinitron WEGA[®] Features

Some of the features you will enjoy include:

- ❑ **FD Trinitron FLAT CRT** — Technologically advanced tube delivers a picture with uncompromising accuracy and outstanding image detail.
- ❑ **Surround** — Simulates theater quality sound for stereo programs.
- ❑ **16:9 Enhanced** — Provides enhanced picture resolution for widescreen sources such as DVD.
- ❑ **Y, P_B, P_R Inputs** — A component video input connection for a superior picture quality.
- ❑ **Parental Control (V-Chip)** — A tool to help parents monitor what their children watch on TV by establishing rating limits.
- ❑ **Favorite Channels** — Instant access to your favorite channels with the touch of a button.
- ❑ **Energy Star[®]** — A recognized symbol of energy efficiency.
- ❑ **Direct MTS** — Allows direct access for changing your Multi-Channel TV Sound: Stereo, Mono, or Auto SAP (Second Audio Program) with the touch of a button.
- ❑ **Front Panel Controls** — Allows access to the on-screen menus without the use of a remote control.
- ❑ **Front A/V Inputs** — A quick connection for video games, camcorders, stereo/mono equipment, or headphones.
- ❑ **Auto Mute** — A friendly feature designed to automatically mute your TV when no signal is received.

About this Manual

This manual provides instructions to help you enjoy your new TV. It shows you how to connect to an antenna or cable, cable box, VCR, DVD, satellite receiver, stereo system, or camcorder. Once you're connected, follow the instructions and use the remote control to access the on-screen menus.

Batteries for the Remote Control

Insert two AA (R6) batteries (supplied) into the remote control using the following illustration as a guide.

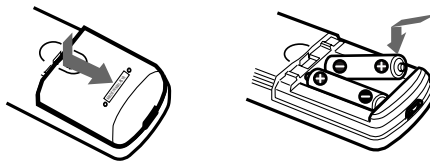







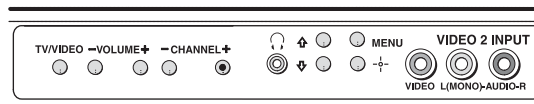



 Under normal conditions, batteries will last up to six months. If the remote control does not operate properly, the batteries might be worn out.

 If you will not be using the remote control for an extended period of time, remove the batteries to avoid possible damage from battery leakage.

Front Panel Menu Controls



The front Audio/Video panel controls allows you to access the menu without the remote control. Press  to display the on-screen menu. Use the  and  buttons on the front Audio/Video panel instead of the  and  buttons on the remote control. Use the  button on the front Audio/Video panel instead of the , , and  buttons on the remote control. Press  again when the setting or adjustment is complete.

 To navigate the menus with your remote control, see "Using the Menus" on page 19.

Using the Remote Control

Remote Control Description

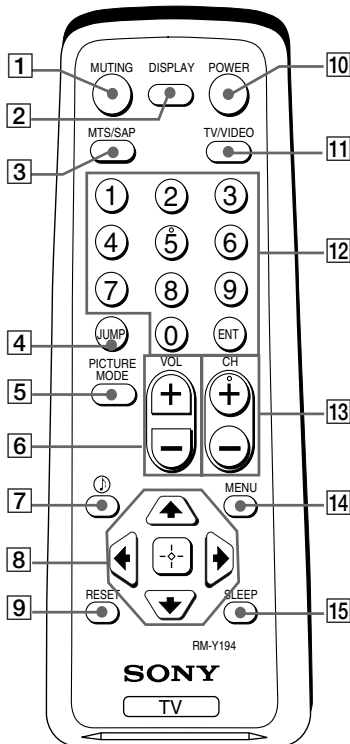

Button	Description
1 MUTING	Instantly turns off the sound. Press again or press $\overset{\text{VOL}}{\oplus}$ to restore the sound.
2 DISPLAY	Press to display the current time (if set) and channel number. Press again to turn DISPLAY off.
3 MTS/SAP	Cycles through the Multi-channel TV Sound (MTS) options: Stereo, Mono, and Auto SAP (Second Audio Program).
4 JUMP	Press to jump back and forth between two channels. The TV alternates between current channel and the last channel that was selected.
5 PICTURE MODE	Cycles through the available Video Mode settings.
6 VOL (volume)	Press when you want to adjust the volume.
7	Press for a direct selection of Effect settings (Simulated, Surround, Off).
8	Moves the cursor in the on-screen menus. Press the arrow buttons to move the cursor, then press the center button to select or access an option.
9 RESET	Press to return to factory settings while in an on-screen menu.
10 POWER	Press when you want to turn the TV on or off.
11 TV/VIDEO	Cycles through available video inputs.
12 0-9 and ENTER	Change the channels directly. Press 0-9 buttons to select a channel, then press ENTER.
13 CH (channel)	Press when you want to change channels.
14 MENU	Displays the on-screen menu. Press again to exit the menu at any time.
15 SLEEP	Turns the TV off automatically in approximately 15, 30, 45, 60, or 90 minutes. Cancel by pressing until Sleep off appears.

If you lose your remote control, see page 34.

Connecting Your TV

Read this section before setting up your TV for the first time. This section covers basic connections in addition to any optional equipment you may be connecting.

TV Rear Panel

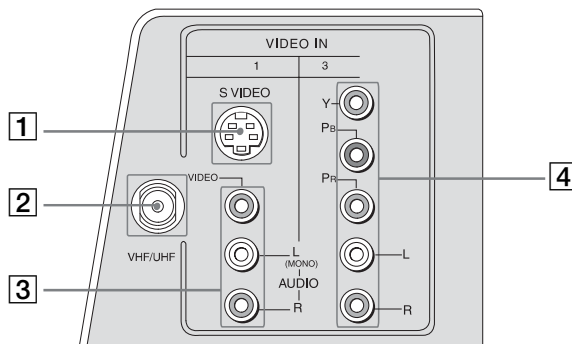

Jack	Description
1 S VIDEO	Connects to the S VIDEO OUT jack on your VCR or other video equipment that has S VIDEO. S VIDEO provides better picture quality than the VHF/UHF jacks or the video input jack. S VIDEO does not provide sound; the audio cables must still be connected.
2 VHF/UHF	Connects to your VHF/UHF antenna or cable.
3 Video/Audio L(Mono),R	Connects to the AUDIO and VIDEO output jacks on your VCR or other video equipment. A second video input jack (VIDEO 2) is located on the front panel of the TV. These AUDIO/VIDEO input jacks provide better picture quality than the VHF/UHF jack.
4 Y, Pb, Pr/L, R	Connects to the component video Y, Pb, Pr to AUDIO L and R output jacks on your DVD player or Digital Set-top box.

S-VIDEO is only for KV-24FS120.

The rear panels illustrated in this manual are for KV-24FS120. The real panels on your TV may not look exactly like those illustrated.

Basic Connections

TV with indoor or outdoor antenna, or CATV cable

Depending on the cable available in your home, choose one of the connections below:

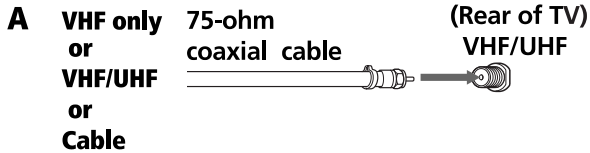

Use this to connect the TV to a cable system or an antenna with a 75-ohms cable (usually built into newer homes).

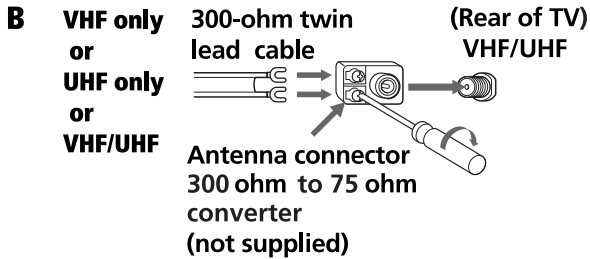

Use this to connect the TV to a dipole antenna, also known as “rabbit ears” antenna (usually found in to older homes).

 If you are connecting to an indoor or outdoor antenna, you may need to adjust the orientation of the antenna for best reception.

Connecting Additional Equipment

TV and VCR

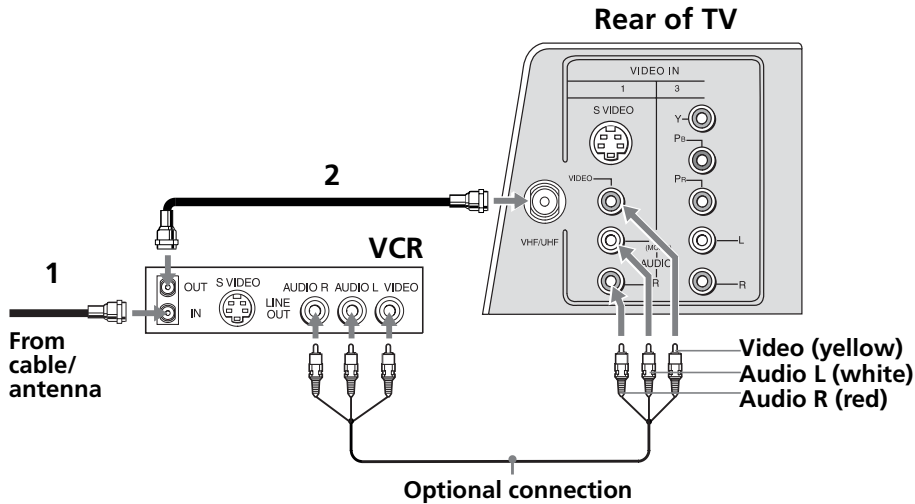

To watch video programs from your VCR, tune your TV to channel 3 or 4 (as set on the rear of your VCR).

- 1** Connect the coaxial cable from your TV antenna or cable service to the IN jack on your VCR.
- 2** Connect a coaxial cable (not supplied) from the OUT jack on your VCR to the VHF/UHF jack on the TV.

Optional connection

- If your VCR is equipped with video outputs, you can get better picture quality by connecting Audio/Video cables (not supplied) from AUDIO and VIDEO OUT on your VCR to AUDIO/VIDEO IN on your TV.
- For better picture quality, use S VIDEO instead of the yellow Audio/Video cable. S-VIDEO does not provide sound; the audio cables must still be connected.

S-VIDEO is only for KV-24FS120 model.

You can use the button to switch between the VHF/UHF and VIDEO inputs.

TV and Cable Box

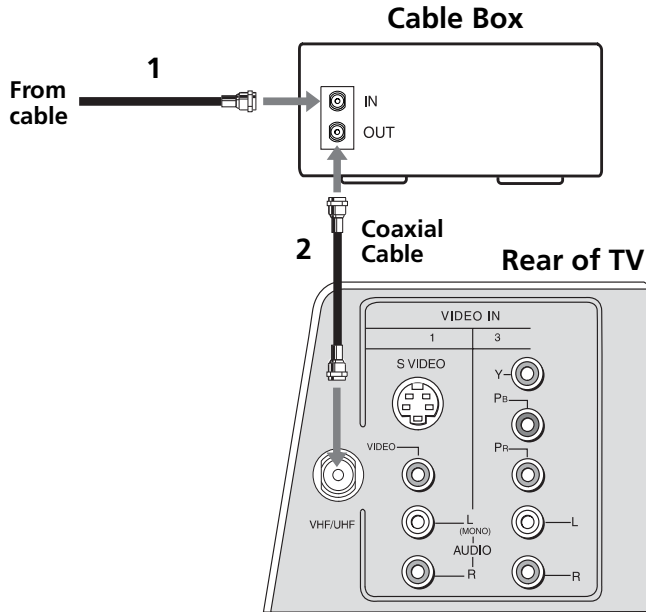

- 1** Connect the coaxial cable from your cable service to the IN jack on your cable box.
- 2** Connect a coaxial cable (not supplied) from the OUT jack on your cable box to the VHF/UHF jack on the TV.

Optional Connection

- To view channels from your cable box, tune your TV to channel 3 or 4 (as set on the rear panel of your cable box) and use the cable box's remote control to change channels.
- If you will be controlling all channel selection through your cable box, you should consider using the Channel Fix feature by setting your TV to channel 3 or 4 (see page 22).

TV, VCR, and Cable Box

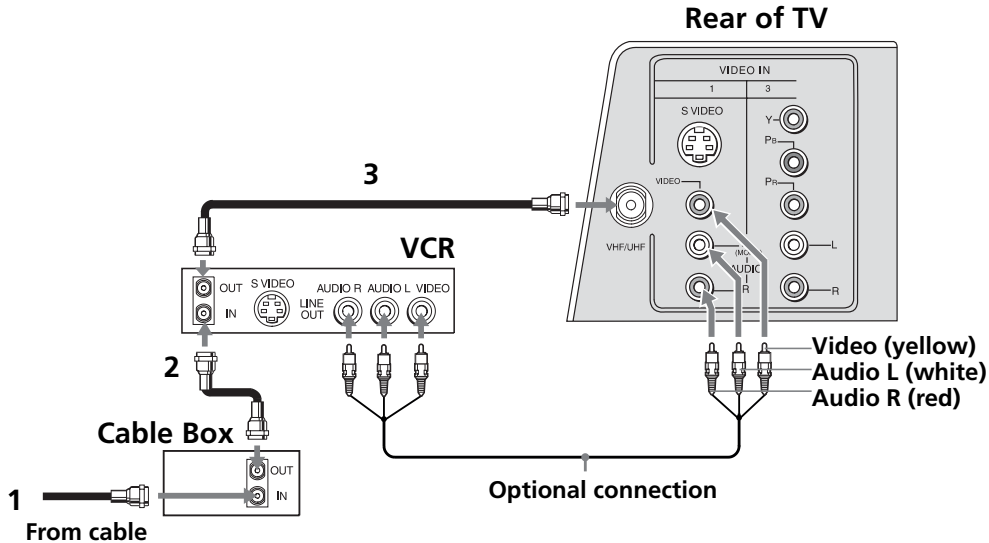

- 1** Connect the coaxial cable from your cable service to the IN jack on your cable box.
- 2** Connect a coaxial cable (not supplied) from the OUT jack on your cable box to the IN jack on your VCR.
- 3** Connect a coaxial cable (not supplied) from the OUT jack on your VCR to the VHF/UHF jack on the TV.

If you will be controlling all channel selection through your cable box, you should consider using the Channel Fix feature by setting your TV to channel 3 or 4 (see page 22).

Optional connection

- If your VCR is equipped with video outputs, you can get better picture quality by connecting Audio/Video cables (not supplied) from Audio and Video OUT on your VCR to Audio/Video IN on your TV.
- For better picture quality, use S VIDEO instead of the yellow Audio/ Video cable. S-VIDEO does not provide sound; the audio cables must still be connected.

S-VIDEO is only for KV-24FS120 model.

You can use the button to switch between the VHF/UHF and VIDEO inputs.

TV and Satellite Receiver

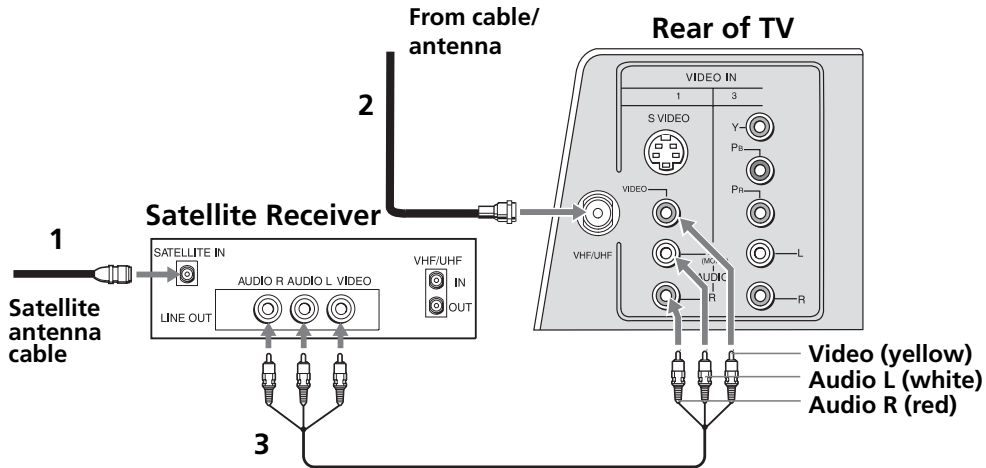



- 1** Connect the cable from your satellite antenna to SATELLITE IN on your satellite receiver.
- 2** Connect the coaxial cable from your cable service or antenna to the VHF/UHF jack on your TV.
- 3** Using audio/video cables (not supplied), connect AUDIO and VIDEO OUT on your satellite receiver to AUDIO and VIDEO IN on your TV.

 To watch video programs from your Satellite receiver, tune your TV to channel 3 or 4.

Optional Connection

- For better picture quality, use S VIDEO instead of the yellow audio/video cable. S-VIDEO does not provide sound; the audio cables must still be connected.

 S-VIDEO is only for KV-24F5120 model.

 You can use the  button to switch between the VHF/UHF and VIDEO inputs.

TV, Satellite Receiver, and VCR

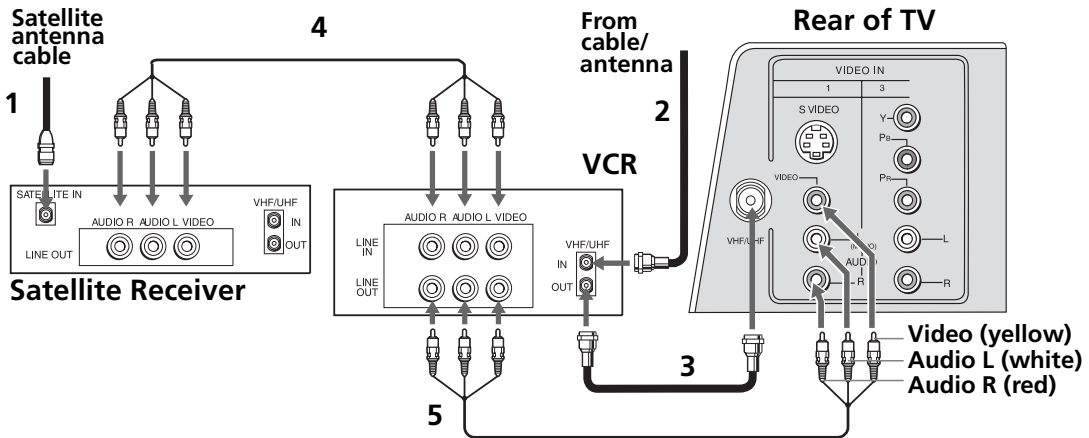

- 1** Connect the cable from your satellite antenna to SATELLITE IN on the satellite receiver.
- 2** Connect the coaxial cable from your cable service or antenna to the IN jack on your VCR.
- 3** Using a coaxial cable (not supplied), connect the OUT jack on your VCR to the VHF/UHF jack on your TV.
- 4** Using audio/video cables (not supplied), connect AUDIO and VIDEO OUT on your satellite receiver to AUDIO and VIDEO IN on your VCR.
- 5** Using audio/video cables (not supplied), connect AUDIO and VIDEO OUT on your VCR to AUDIO and VIDEO IN on your TV.

Optional Connection

- To view from the satellite receiver or VCR, select the video input to which your satellite receiver or VCR is connected by pressing  on the remote control.

Connecting a DVD Player using Composite Video (Video/Audio L(Mono), R)

Using audio/video cables (not supplied), connect AUDIO/VIDEO OUT on your DVD player to AUDIO/VIDEO IN on your TV.

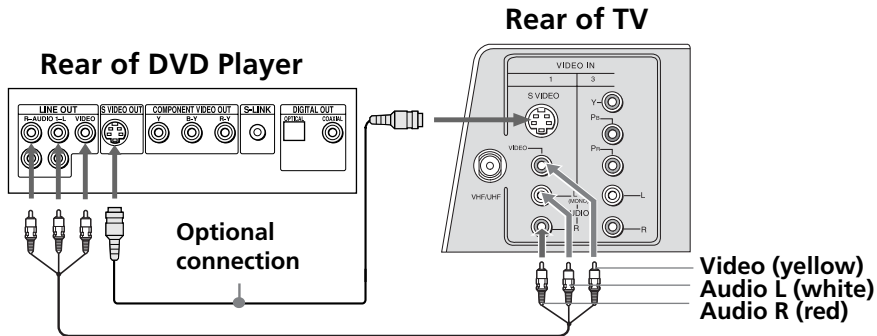

Optional connection

- ❑ For better picture quality, use S VIDEO instead of the yellow audio/video cable. S-VIDEO does not provide sound, so you still must connect the audio cables.

Connecting a DVD Player using Component Video (Y, Pb, Pr)

- ❑ If your DVD player is equipped with component video outputs (Y, Pb, Pr/L, R), you can improve the picture quality by using component video cables (480i only).

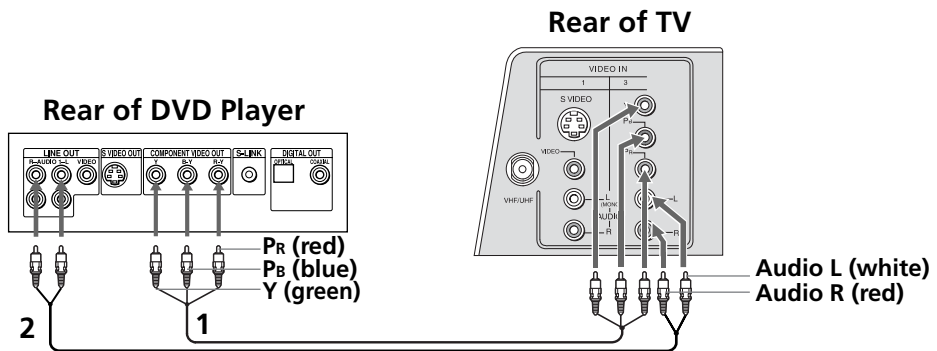

- 1 Using component video cables (not supplied), connect the Y, Pb, Pr OUT on your DVD player to Y, Pb, Pr IN on your TV.
- 2 Connect AUDIO OUT on your DVD player to AUDIO IN on your TV.

 The Y, Pb, Pr outputs on your DVD player are sometimes labeled Y, Cb, and Cr or Y, B-Y, and R-Y. If so, connect the cables to like colors.

Connecting Headphones

Connect the headphones to the  jack on the front of your TV. Headphone jack is STEREO.

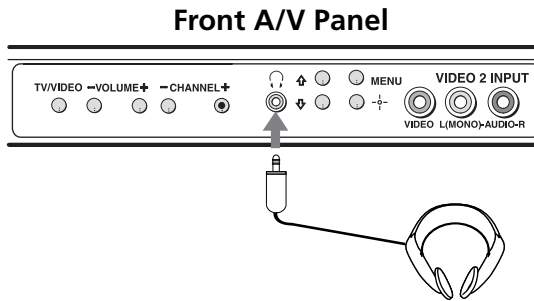

Connecting a Camcorder

Using audio/video cables (not supplied), connect AUDIO and VIDEO OUT on your camcorder to AUDIO and VIDEO IN on your TV.

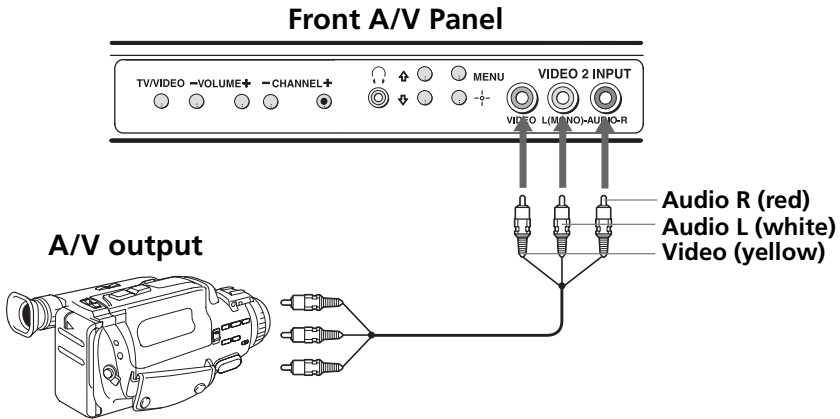

Connecting for Video Tape Editing (VCR and Camcorder)

Camcorder (for playback)



A/V output

VCR (for playback)

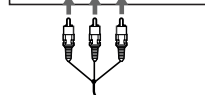
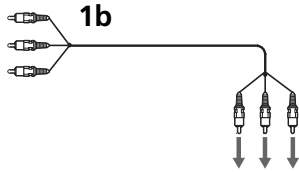

1a



VCR (for recording)

2

Rear of TV

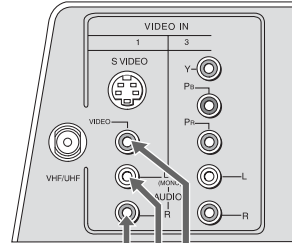

Video (yellow)
Audio L (white)
Audio R (red)

- 1 For video tape editing connect to the VCR the following sources (VCR or Camcorder):
 - a) Using audio/video cables (not supplied), connect AUDIO/VIDEO OUT on your first VCR to AUDIO/VIDEO IN on your second VCR
 - b) Using audio/video cables (not supplied), connect the AUDIO/VIDEO OUT on your Camcorder to the AUDIO/VIDEO IN on your second VCR
- 2 Using audio/video cables (not supplied), connect AUDIO/VIDEO OUT on the second VCR to the AUDIO/VIDEO IN on your TV.

Using Basic Functions



Setting Up the TV

After you have finished connecting your TV, you can use Auto Program to set up your channels. During Auto Program, the TV will automatically search for available channels and program receivable channels.

 When you start Auto Program wait until it is finished; otherwise it will skip over channels that are available. Perform Auto Program again to program receivable channels.

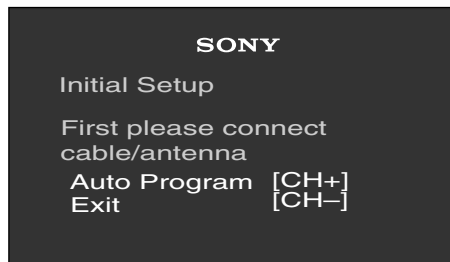









- 1 Press  to turn on the TV. The Initial Setup screen appears.





- 2 Press  on the remote control or on the TV front panel to start Auto Program, or press  to exit.

 The Initial Setup screen appears each time you turn on the TV until you perform Auto Program.

To perform Auto Program again

- 1 Press .
- 2 Press  to highlight Channel Menu.
- 3 Press  to highlight Cable. Press  to select.
- 4 Press  or  to highlight On or Off according to how you connected your TV. Press  to select.
- 5 Press  to highlight Auto Program. Press  to search for channels.
- 6 After Auto Program finishes, press  to exit.

To reset the TV to factory settings

- 1 Turn the TV on.
- 2 Hold down  on the remote control.
- 3 Press and release the POWER button on the TV front panel. The TV will turn itself off, then back on.
- 4 Release .

Quick Start to the Menus

The following settings are available in your on-screen menus:

Menu	Allows you to
------	---------------



Make adjustments to your picture settings.

Basic Functions



Change your audio settings.



Customize your channel settings.



Set rating limits on your TV based on a program's rating or content.

Menu**Allows you to**



Set the clock on your TV and program scheduled viewing using Timer 1 and Timer 2.



Select closed captioning options, label video inputs, adjust tilt correction, select menu languages, or run a demo of the menus.

Using the Menu

This section shows the options available for setting up and adjusting your TV.

Using the Remote Control to Navigate on the On-Screen Menus

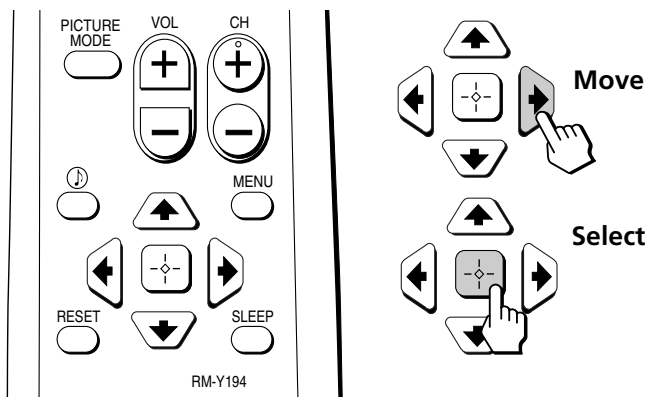

To navigate on the on-screen menus, use the “arrow” buttons (↑, ↓, ←, →) to move the cursor. Pressing these arrows will cause the cursor to move in the corresponding direction. Pressing center button (↵) will allow you to select an option.

How to Access Menus

To Access a Menu

- 1 Press to display the on-screen menu.
- 2 Use the ← or → buttons to highlight the desired menu icon. Press to select it.
- 3 Use the ↑ or ↓ buttons to scroll up and down through the features.
- 4 Follow the instructions on the screen.
- 5 For instructions on using a specific menu, see the page in this section that talks about that menu.
- 6 Press to exit the menu.

Press once to display the on-screen menu, and press again to return to normal viewing. If no buttons are pressed, the menu closes automatically after about 90 seconds.

Using the Video Menu

To access the Video menu, refer to the following steps:

To Display





To Select

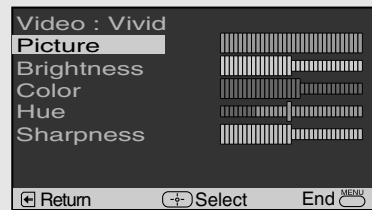

Picture Controls Menu



Press  to highlight an option, then .

Mode

Customized picture viewing

Use the  or  buttons to highlight one of the following options, then press  to select it.

Vivid: Select for enhanced picture contrast and sharpness.

Standard: Select for a standard picture.

Movie: Select for a finely detailed picture.

Pro: Select for natural picture and sharpness.







Press







on the remote control for direct access to the picture modes (Vivid, Standard, Movie, Pro).



Picture Control



With the Picture Controls menu open, press  or  to select one of the following option:

Picture: Press  to decrease the contrast. Press  to increase contrast.

Brightness: Press  to darken the picture. Press  to brighten the picture.



Color: Press  to decrease color saturation. Press  to increase color saturation.

Hue: Press  to increase the red tones. Press  to increase the green tones.

Sharpness: Press  to soften the picture. Press  to sharpen the picture.

Color Temp.

White color tint adjustment

Use the  or  buttons to select from one of the following options:



Cool: Gives the white colors a blue tint.

Neutral: Gives the white colors a neutral tint.

Warm: Gives the white colors a red tint.

VM

Velocity Modulation

Sharpens picture definition to give objects a sharp, clean edge. Use the  or  buttons to select from one of the following options: **Off**, **High**,

Low.

Using the Audio Menu

To access the Audio menu, refer to the following steps:

To Display











To Highlight 



To Select



Press  to highlight an option, then .

Audio

Treble 



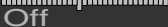

Bass 













Balance 

Steady Sound : Off



Effect : Off

MTS : Stereo

Move  
Select 
End 

Treble	Press  to decrease the higher pitched sounds. Press  to increase the higher pitched sounds.
Bass	Press  to decrease the lower pitched sounds. Press  to increase the lower pitched sounds.
Balance	Press  to emphasize the left speaker. Press  to emphasize the right speaker.
Steady Sound	Use the  or  buttons to highlight one of the following options, then press  to select it. On: Select to stabilize the volume when changing the channels. Off: Select to turn Steady Sound Off.
Effect	Use the  or  buttons to highlight one of the following options, then press  to select it. Simulated: Simulates theater quality sound for mono programs. Surround: Simulates theater quality sound for stereo programs. Off: Provides normal stereo or mono reception.

 Press  to directly select Effect settings (Simulated, Surround, Off).

MTS <i>Multi-Channel TV Sound</i>	Use the  or  buttons to highlight one of the following options, then press  to select it. Stereo: Select when viewing a broadcast in stereo. Auto SAP: Select to have the TV automatically switch to a Second Audio Program (SAP) when a signal is received. Mono: Select to reduce noise in areas of poor reception.
---------------------------------------------	--------------------------------------------------------------------------------------------------------------------------------------------------------------------------------------------------------------------------------------------------------------------------------------------------------------------------------------------------------------------------------------------------------------------------------------------------------------------------------------------------------------------------------------------------------------------------------------------------------------

 Press  to directly select MTS settings (Stereo, Auto SAP, Mono).

 If your TV is set to Auto SAP, some programs may be muted or distorted. If your TV does not output sound, change your Audio MTS setting to Stereo or Mono.

Using the Channel Setup Menu

To access the Channel Setup menu, refer to the following steps:

To Display





To Highlight 



To Select











Press  to highlight an option, then .







Favorite Channels

Quick access to favorite channels

Press  to open the Favorite Channels menu:

- 1 Use the  or  buttons to select the position (1-5) where you want to set a favorite channel, then press .
- 2 Using the  or  button, select the desired channel.
- 3 Press  to change to the channel selected.
- 4 Press  to return to the Channel Setup menu or press  to exit.



To use Favorite Channels: Exit all menus and press . Press  or  to move the cursor to the desired channel number and press .

Cable

On: Select if you are receiving cable channels with a CATV cable.

Off: Select if you are using a TV antenna.



After changing your cable settings, you will need to perform Auto Program. When Channel Fix is set, you will not be able to use your Cable settings.

Channel Fix

2-6: Select when you want to control all channel selection through a cable box or VCR. Select the appropriate channel (usually 3 or 4) and use the cable box's or VCR's remote control for channel selection.

Video 1: Select from available video inputs when you have connected video equipment (e.g. satellite receiver) and you want your TV fixed to it.

Off: Channel Fix is not set.



You cannot use Favorite Channels, Channels Skip/Add, or Channel Cable with Channel Fix is set.

Auto Program

Press  to perform Auto Program.

The TV will scan through all available channels and program receivable channels.

Channel Skip/Add

Use this feature after you run Auto Program to skip unwanted channels or add new ones. Press \Rightarrow to open the Channel Skip/Add menu:

- 1 Use the \uparrow or \downarrow buttons to select the position of the desired channel, then press $\boxed{\uparrow\downarrow}$.
- 2 Use the \uparrow or \downarrow buttons to select Skip or Add, then press $\boxed{\uparrow\downarrow}$.
- 3 Press \leftarrow to return to the Channel Setup menu or press $\boxed{\text{MENU}}$ to exit.

 Pressing CH+ or CH- will skip over channels that have been skipped. You can still use the 0-9 buttons to directly tune to skipped channels.

Channel Label

Label up to 40 channels with their call letters

Press \Rightarrow to open the Channel Label menu:

- 1 Press $\boxed{\uparrow\downarrow}$, then press \uparrow or \downarrow until you reach the desired channel number. Press $\boxed{\uparrow\downarrow}$ to activate the channel.
 - 2 Press $\boxed{\uparrow\downarrow}$, then use the \uparrow or \downarrow button to display the first call letter or number of the caption, then press $\boxed{\uparrow\downarrow}$ to select it. When finished, press $\boxed{\uparrow\downarrow}$ to activate.
-

Using the Parental Control Menu

To access the Parental Control menu, refer to the following steps:

To Display





To Highlight 





To Select



Press  to highlight an option; then press .



In the Parental Control  menu, you will be asked to set a 4-digit password for any further access into Parental Control.

1 Press , then use the  buttons to enter a 4-digit password.

 Keep this manual in a safe place. If you forget your password, see page 33.

2 Confirm your password by entering it again.

Once your password is set correctly, the next Parental Control menu appears. For future access to this menu, use your password. A password is needed every time you want to access Parental Control menu.

Parental Control

Setting the Rating

You can change the Rating by selecting one of the Lock options.





- 1 With **Lock** highlighted, press .

If you are not familiar with the Parental Guidelines rating system, use one of the following preselected categories to simplify the rating selections: Child, Youth, Young Adult.

- 2 Use the  or  buttons to select the desired rating, then press .



Rating	TV will allow a maximum rating of
Child	TV-Y, TV-G, G (U.S. models only), G (Canadian models only)
Youth	TV-PG, PG (U.S. models only), PG (Canadian models only)
Young Adult	TV-14, PG-13 (U.S. models only), 14+ (Canadian models only)
Custom	Select to set more restrictive ratings (see next section)
Off	No rating limit

Changing your Password

- 1 Use the  or  button to move the cursor to Change Password and press .
- 2 Follow steps 1 and 2 for “Using the Parental Control Menu” on page 24.

Information for Parents

To view a program that exceeds the TV rating

- Press , then use the - buttons to enter your password.

 Entering your password to view a blocked program will temporarily turn Lock to Off. To reactivate your Lock settings, turn the TV off. When you turn the TV on, your Lock settings are restored.

Using the Custom Menu

Before setting Custom ratings, see pages 24-25, "Overview of the Ratings," for a description of the available rating systems.

Follow the instructions on the screen to make your custom settings. Select the country desired for your TV's rating limit. See page 27 for U.S. models and page 29 for Canadian models for more information.



Once you have blocked a rating or content, all higher ratings or content will be automatically blocked.

United States: Selecting Custom Rating Options

For the United States, the Custom Rating menu includes the following options: Movie Rating, TV Rating and Unrated. (For Canada, see page 29.)

Movie Rating

This system defines the rating levels of movies shown in theaters and on prime cable channels.

Rating	Defined as
G	General audience
PG	Parental guidance suggested
PG-13	Parents strongly cautioned
R	Restricted
NC-17	No one 17 and under admitted
X	Adult audience only

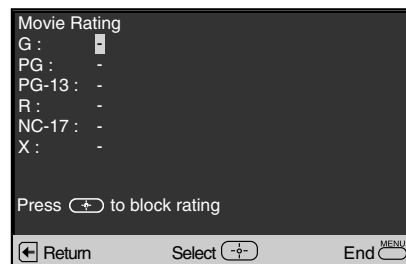

TV Rating

The TV rating is divided into two groups: age-based and content-based.

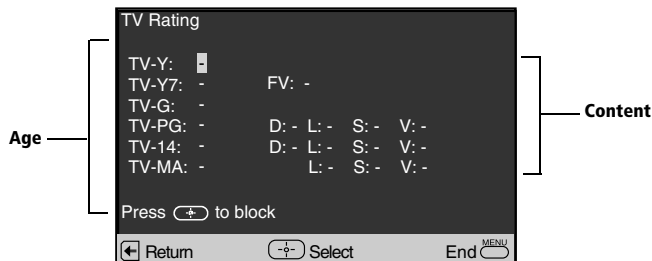

Age	Defined as
TV-Y	All children
TV-Y7	Directed to older children
TV-G	General audience
TV-PG	Parental guidance suggested
TV-14	Parents strongly cautioned
TV-MA	Mature audience only

Content	Defined as
FV	Fantasy violence
D	Suggestive dialogue
L	Strong language
S	Sexual situations
V	Violence

 The content ratings will increase depending on the level of the age-based rating. For example, a program with a TV-PG V (Violence) rating may contain moderate violence, while a TV-14 V (Violence) rating may contain intense violence.

Unrated

You have the option of blocking TV programs or movies that are not rated.

Allow	Allows all unrated programs
Block	Blocks all unrated programs

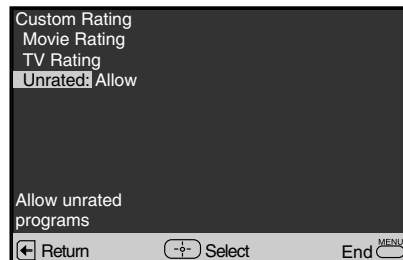

 If you choose to block unrated TV programs, please be aware that the following programs may be blocked: emergency broadcasts, political programs, pro, news, public service announcements, religious programs, and weather.

Canada: Selecting Custom Rating Options

For Canada, the Custom Rating menu includes the following options: English Rating, French Rating, and U.S.A. Rating.

English Rating

These ratings are for Canadian programs that are broadcast in English.

Rating	Defined as
C	Children
C8+	Children 8 years and older
G	General programming
PG	Parental guidance
14+	Viewers 14 and older
18+	Adult programming

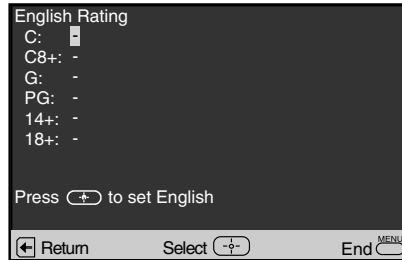

French Rating

These ratings are for Canadian programs that are broadcast in French.

Rating	Defined as
G	General
8 ans+	Not recommended for younger children
13 ans+	Not recommended for children under age 13
16 ans+	Not recommended for ages under 16
18 ans+	This program is restricted to adults

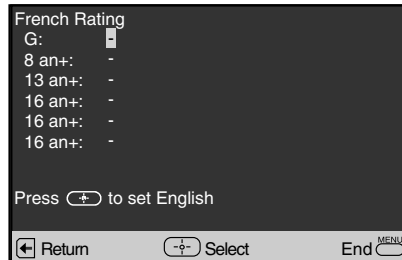

U.S.A. Rating

For programs from the United States, see "TV Rating" on page 27.

Using the Timer ⌚ Menu

To access the Timer menu, refer to the following steps:

To Display



To Highlight ⌚



To Select



Press to highlight an option, then press .



Current Time

Set your TV to the current day and time.

Press to open Current Time menu:

- 1 Use the or to enter the day and time, then press .
- 2 Press to exit the menu.

You must set the Current Time before you can use Timer 1 and Timer 2.

Timer 1 and Timer 2

*Scheduled
viewing*

Use your timers settings to program your TV by day, time, duration and channel. The timer's duration is maximum of 6 hours. When the channel is fixed, it is not necessary to set the channel.

With the menu open, set cursor on Timer 1 or Timer 2:

- 1 Press or to select Timer 1 or Timer 2, then press .
- 2 Press or to enter the desired day, time, duration and channel, then press . The Timer status should be On when the Timer has been set.
- 3 Press to exit the menu.

You can set the Timer to On, Off, or Set. Once the timer is set, you can turn it On or Off without having to go through the settings. When you set Timer 1 or Timer 2, a red light on the front panel of your TV will turn on.



When you perform Auto Program, Timer 1 and Timer 2 settings will be cleared. Also, in the event of any loss of power, Current Time and Timer 1 and Timer 2 settings will be cleared.

Using the Setup Menu

To access the Setup menu, refer to the following steps:



To Display **To Highlight**  **To Select**



Press  to highlight an option, then press .





Caption Vision Allows you to select from three closed caption modes (for programs that are broadcast with closed caption).

Closed-Captioning Press  or  to select one of the following options:

CC1, 2, 3, 4: Displays printed dialogue and sound effects of a program.



Text1, 2, 3, 4: Displays network/station information.



Off: Caption Vision is not activated.





Info Banner Displays the name of the current program and its remaining time (if available) when you change the channel or press the DISPLAY button. Use the  or  buttons to highlight one of the following options: **On, Off**. Then press .



Video Label Allows you to label the audio/video components you connected to the TV: VHS, DVD, etc. When you press TV/VIDEO to switch inputs, the Video Label will display on-screen.

Label connected equipment Press  to open the Video Label menu:

1 Press  or  to access the input you want to label and press .

2 Press  or  to choose a label and press .

Tilt Correction Press  to open Tilt Correction:
Press  or  to correct any tilt of the picture from -5 to +5, then press  to activate and return to the Setup menu.

Language Display all menus in the language of your choice.
Use the  or  buttons to select desired language and press .

16:9 Enhanced Provides enhanced picture resolution for wide-screen sources such as DVD. This is only available when the TV is in Video mode.

Other Information

Troubleshooting

If you have a problem with your TV, try the suggestions below. If the problem persists, see “Contacting Sony” at the end of this section.

General

Problem	Possible Remedies
I want to reset the TV to the factory settings	<input type="checkbox"/> Turn on the TV. While holding down the RESET button on the remote control, press POWER button on the TV front panel. The TV will turn itself off, then back on again. Release the RESET button.
The TV is dirty	<input type="checkbox"/> Clean the TV with a soft dry cloth. Never use strong solvents such as thinner or benzine, which might damage the finish of the cabinet.
I lost the parental control password	<input type="checkbox"/> In the password screen, enter the following master password: 4357. After using the master password, you must create a new password. You cannot use the master to unlock currently blocked channels.
There is a black box on the screen	<input type="checkbox"/> You have selected a text option in the Setup menu (page 31) and no text is available. To turn off this feature, select Off in the Caption Vision option. If you were trying to select closed captioning, select CC1-4 instead of Text1-4.
There was a blackout or power outage, and now the TV won't turn on and the timer LED is flashing	<input type="checkbox"/> Press the POWER button on your remote control or on the TV front panel.
Digital cable box does not work	<input type="checkbox"/> Be sure that you have not connected the digital cable box to the TV's jack. This jack is not compatible with digital cable boxes. <input type="checkbox"/> If you are connecting a VCR and digital cable box using a splitter, as described in pages 9, you must use a special bi-directional splitter that is designed to work with your digital cable box.

Remote Control

Problem	Possible Remedies
I cannot operate the remote control	<ul style="list-style-type: none">❑ Check the orientation of the batteries.❑ Batteries could be weak. Replace them (page 2).❑ Move the TV three to four feet away from fluorescent lights.
I cannot change channels with the remote control	<ul style="list-style-type: none">❑ Make sure you have not inadvertently switched your TV from the channel 3 or 4 setting if you are using another device to change channels.
I lost the remote control	<ul style="list-style-type: none">❑ You can use the front panel controls to access your menus, change channels, adjust the volume, or change video inputs (page 2). Contact your nearest Sony Dealer to order a replacement, please call our Sony Direct Accessory and Part Center at 1-800-488-7669 (U.S. residents only).

Video

Problem	Possible Remedies
No picture, no sound	<ul style="list-style-type: none">❑ Make sure the power cord is plugged in.❑ If a red light is flashing on the front of your TV for more than a few minutes, disconnect and reconnect the power cord. If the problem continues, call your local service center.❑ Check the TV/VIDEO setting: when watching TV, set it to TV; when watching video equipment, set it to VIDEO 1, 2 or 3 (page 3).❑ Try another channel to rule out station trouble.
Poor or no picture, good sound	<ul style="list-style-type: none">❑ Adjust the Picture setting in the Video menu (page 20).❑ Adjust the Brightness setting in the Video menu (page 20).❑ Check the antenna and/or cable connections (page 6).
No color	<ul style="list-style-type: none">❑ Adjust the Color setting in the Video menu (page 20).
Only snow appears on the screen	<ul style="list-style-type: none">❑ Check the Cable setting in the Channel menu (page 22).❑ Check the antenna and/or cable connections (page 6).❑ Make sure the channel selected is currently broadcasting.
Dotted lines or stripes	<ul style="list-style-type: none">❑ Adjust the antenna.❑ Move the TV away from other electronic equipment. Some electronic equipment creates electrical noise, which can interfere with TV reception.
Double images or ghosts	<ul style="list-style-type: none">❑ Check your outdoor antenna or call your cable service.

Audio

Problem	Possible Remedies
Good picture, no sound	<ul style="list-style-type: none"><input type="checkbox"/> Press  so that Muting disappears from the screen (page 3).<input type="checkbox"/> Check your Audio settings. Your TV may be set to Auto SAP in the MTS feature (page 21).<input type="checkbox"/> Adjust your TV's volume.
Low or no audio (TV and Cable box)	<ul style="list-style-type: none"><input type="checkbox"/> Some cables boxes have volume level controls. Check and see if your cable box or cable box remote has a volume control.

Channels

Problem	Possible Remedies
I cannot receive higher number channels (UHF) when using an antenna	<ul style="list-style-type: none"><input type="checkbox"/> Make sure Cable is set to Off in the Channel menu (page 22).<input type="checkbox"/> Perform Auto Program to add channels that are not presently in the memory (page 15).
Cable stations don't seem to work	<ul style="list-style-type: none"><input type="checkbox"/> Make sure Cable is set to On in the Channel menu (page 22).<input type="checkbox"/> Perform Auto Program to add channels that are not presently in the memory (page 15).

Contacting Sony

Before calling our Customer Information Services Center, reset the TV to factory settings (see page 23). Please have your TV serial number ready. The number is located on the rear of your TV and on the front cover of this manual.

Our Customer Information Services Center phone number is 1-800-222-SONY (7669) (US residents only) or 1-877-899-SONY (7669) (Canadian residents only).

Specifications

For all models (except as noted)

Television system	American TV standard/NTSC
Channel coverage	VHF: 2-13/UHF: 14-69/CATV: 1-125
Antenna	75-ohm external antenna terminal for VHF/UHF
Picture tube	FD Trinitron [®] tube
Power requirements	120V, 60 Hz
Supplied Accessories	Size AA (R6) batteries (2) Remote Control RM-Y194 (1)
Optional Accessories	Connecting cables VMC-810S/820S, VMC-720M, YC-YC-15V/30V, RK74A EAC-66 U/V mixer

KV-20FS120

Screen size	Visible screen size: 20 inches (507 mm) measured diagonally Actual screen size: 21 inches (533.4 mm) measured diagonally
Inputs	1 video, 1 audio (front) 1 video, 1 audio (back) 1 Y, P _B , P _R , 1 audio (back)
Outputs	1 headphone jack (front)
Speaker output	10 W x 2
Power Consumption	140 W in use Less than 1 W in standby
Dimensions (W/H/D)	631 x 468 x 490.5 mm (24 ⁷ / ₈ x 18 ³ / ₈ x 19 ¹ / ₄ in.)
Mass	25.2 kg (55 lbs. 9 oz.)

KV-24FS120

Screen size	Visible screen size: 24 inches (598 mm) measured diagonally Actual screen size: 25 inches (635 mm) measured diagonally
Inputs	1 video, 1 audio (back) 1 video, 1 audio (front) 1 Y, P _B , P _R , 1 audio (back) 1 headphone jack (front)
Outputs	1 S VIDEO (back)
Speaker output	10 W x 2
Power Consumption	165 W in use Less than 1 W in standby
Dimensions (W/H/D)	718 x 526.5 x 480 mm (28 ¹ / ₄ x 20 ³ / ₄ x 18 ⁷ / ₈ in.)
Mass	32.8 kg (72 lbs. 5 oz.)

Index

16:9 Enhanced 31

A

Auto Program 15, 22

Auto SAP 21

B

Batteries Installation 2

Brightness 20

C

Cable 22

Caption Vision 31

Channel Fix 22

Channel Label 23

Channel Setup Menu 22

Channel Skip/Add 23

Color 20

Connections

 Cable and antenna 6

 Connecting a Camcorder 13

 Connecting a DVD Player 12

 Connecting Headphones 13

 Connecting Your TV 5

 TV and Satellite Receiver 10

 TV and VCR 7

 TV, Satellite Receiver, and VCR 11

 TV, VCR, and Cable Box 9

Current Time 30

F

Favorite Channels 22

Front A/V Panel (see TV Front Panel) 2

H

Hue 20

L

Language 31

M

Menus 19

 Audio  21

 Channel Setup  22

 Parental Control  24

 Setup Menu  31

 Timer  30

 Video  20

MTS

 Auto SAP 21

 Mono 21

 Stereo 21

P

Parental Control 24

Parental Control Menu 24

Picture 20

Picture Control 20

Picture Controls

 Brightness 20

 Color 20

 Hue 20

 Picture 20

 Sharpness 20

R

Ratings

 English Rating 29

 French Rating 29

 Movie Rating 27

 TV Rating 27

 U.S.A. Rating 29

 Unrated 28

Remote Control 3

S

Setup  Menu 31

Specifications 36

Stereo 21

T

Tilt Correction 31

Timer 1 and Timer 2 30

Timer  Menu 30

Troubleshooting 33

TV Features 1

TV Front Panel 2

TV Rating 27

TV Rear Panel 5

V

Video Label 31

Video  Menu 20

VM 20

Sony Corporation
<http://www.sony.net>

Printed in U.S.A.

Thank you for purchasing this Sony television. Proper registration will enable us to send you periodic mailings about new products and other important announcements. Registering your product will also allow us to contact you in the unlikely event that your television needs adjustment or modification. Please take the time to register the product at our web site:

<http://www.sony.com/productregistration>

If you have any operational questions regarding your new purchase, please contact your retailer. For the location of a Sony dealer in your area, or for any other questions, please call 1-800-222-SONY (7669).

Thank you.

A black and white photograph of a man and a woman in a home office. The man is sitting at a desk, looking at a laptop. The woman is standing behind him, looking at a large computer monitor. Both screens display the Sony Rewards website. The man is wearing a light-colored shirt and the woman is wearing a dark top. The background shows a window with blinds and a framed picture on the wall.

REWARD YOURSELF

SONY SAVINGS, SPECIALS
AND SENSATIONAL OFFERS ARE
ALL SIMPLY A CLICK AWAY.

Log on to

www.sonyrewards.com

Explore our special offers, obtain eligible rebates,
and find special savings, all designed for our
Sony customers.

THANK YOU

THE JOY OF OWNERSHIP HAS JUST BEGUN...
With your new purchase, we welcome you to the Sony family. And you'll find that being part of the family has its privileges at www.sonyrewards.com. To make your life a little less hectic, we have created an easy way for you to complete eligible rebate forms, warranty registration, learn about valuable accessories, and find links to sites answering questions about your product. Keep this card as a convenient reminder and visit us periodically for updates. Again, thank you for choosing Sony.

SonyCardSM

REWARDS

www.sonyrewards.com

LIKE NO OTHERSM

Please detach and keep as a reference of future rebates and offers available at www.sonyrewards.com. Offer open to legal residents of the fifty states of the U.S. and D.C. Terms and conditions of individual offers may apply. Site may not apply to all rebates. See www.sonyrewards.com for complete details. © 2005 Sony Electronics Inc. 2-539-752-0710

SONY®Color TV
Color Video TV

LIMITED WARRANTY

Sony Electronics Inc. ("Sony") warrants this Product (including any accessories) against defects in material or workmanship, subject to any conditions set forth as follows:

1. **LABOR:** For a period of 90 days from the date of purchase, if this Product is determined to be defective, Sony will repair or replace the Product, at its option, at no charge, or pay the labor charges to any Sony authorized service facility. After the Warranty Period, you must pay for all labor charges.

2. **PARTS:** In addition, Sony will supply, at no charge, new or rebuilt replacements in exchange for defective parts for a period of one (1) year (color picture tube - two (2) years). After 90 days from the date of purchase, labor for removal and installation is available from Sony authorized service facilities or a Sony Service Center at your expense.

3. **ACCESSORIES:** Parts and labor for all accessories are for one (1) year.

In-home diagnostic warranty service is provided during the initial 90 day period for 19" (measured diagonally), or larger screen size through a Sony authorized service facility.

To obtain warranty service, you must take the Product, or deliver the Product freight prepaid, in either its original packaging or packaging affording an equal degree of protection, to any authorized Sony service facility.

This warranty does not cover customer instruction, installation, set up adjustments or signal reception problems.

This warranty does not cover cosmetic damage or damage due to acts of God, accident, misuse, abuse, negligence, commercial use, or modification of, or to any part of the Product, including the antenna. This warranty does not cover damage due to improper operation or maintenance, connection to improper voltage supply, or attempted repair by anyone other than a facility authorized by Sony to service the Product. This warranty does not cover Products sold AS IS or WITH ALL FAULTS, or consumables (such as fuses or batteries). This warranty is valid only in the United States.

Proof of purchase in the form of a bill of sale or receipted invoice which is evidence that the unit is within the Warranty period must be presented to obtain warranty service.

This warranty is invalid if the factory applied serial number has been altered or removed from the Product.

REPAIR OR REPLACEMENT AS PROVIDED UNDER THIS WARRANTY IS THE EXCLUSIVE REMEDY OF THE CONSUMER. SONY SHALL NOT BE LIABLE FOR ANY INCIDENTAL OR CONSEQUENTIAL DAMAGES FOR BREACH OF ANY EXPRESS OR IMPLIED WARRANTY ON THIS PRODUCT. EXCEPT TO THE EXTENT PROHIBITED BY APPLICABLE LAW, ANY IMPLIED WARRANTY OF MERCHANTABILITY OR FITNESS FOR A PARTICULAR PURPOSE ON THIS PRODUCT IS LIMITED IN DURATION TO THE DURATION OF THIS WARRANTY.

Some states do not allow the exclusion or limitation of incidental or consequential damages, or allow limitations on how long an implied warranty lasts, so the above limitations or exclusions may not apply to you. In addition, if you enter into a service contract with the Sony Partnership within 90 days of the date of sale, the limitation on how long an implied warranty lasts does not apply to you. This warranty gives you specific legal rights, and you may have other rights which vary from state to state.

For your convenience, Sony Electronics Inc. has established telephone numbers for frequently asked questions:

To locate the servicer or dealer nearest you, or for service assistance or resolution of a service problem, or for product information or operation, call:

Sony Customer Information Services Center

1-800-222-7669

or visit the Sony Web Site:

www.sony.com

For an accessory or part not available from your authorized dealer, call:

1-800-488-SONY (7669)

Free Manuals Download Website

<http://myh66.com>

<http://usermanuals.us>

<http://www.somanuals.com>

<http://www.4manuals.cc>

<http://www.manual-lib.com>

<http://www.404manual.com>

<http://www.luxmanual.com>

<http://aubethermostatmanual.com>

Golf course search by state

<http://golfingnear.com>

Email search by domain

<http://emailbydomain.com>

Auto manuals search

<http://auto.somanuals.com>

TV manuals search

<http://tv.somanuals.com>