

# SERVICE MANUAL

# BG-3S CHASSIS

<u>MODEL</u>	<u>COMMANDER</u>	<u>DEST.</u>	<u>CHASSIS NO.</u>	<u>MODEL</u>	<u>COMMANDER</u>	<u>DEST.</u>	<u>CHASSIS NO.</u>
<i>KV-HF51P50</i>	<i>RM-952</i>	<i>Indonesia</i>	<i>SCC-U20K-A</i>				
<i>KV-XF21M80</i>	<i>RM-952</i>	<i>E</i>	<i>SCC-U13C-A</i>				
<i>KV-XF21M80</i>	<i>RM-952</i>	<i>ME</i>	<i>SCC-U16W-A</i>				
<i>KV-XF21M80</i>	<i>RM-952</i>	<i>Vietnam</i>	<i>SCC-U28A-A</i>				
<i>KV-XF21M83</i>	<i>RM-952</i>	<i>Vietnam</i>	<i>SCC-U28B-A</i>				
<i>KV-XF21N90</i>	<i>RM-915</i>	<i>Taiwan</i>	<i>SCC-P13D-A</i>				
<i>KV-XF51M65</i>	<i>RM-952</i>	<i>Indonesia</i>	<i>SCC-U20F-A</i>				

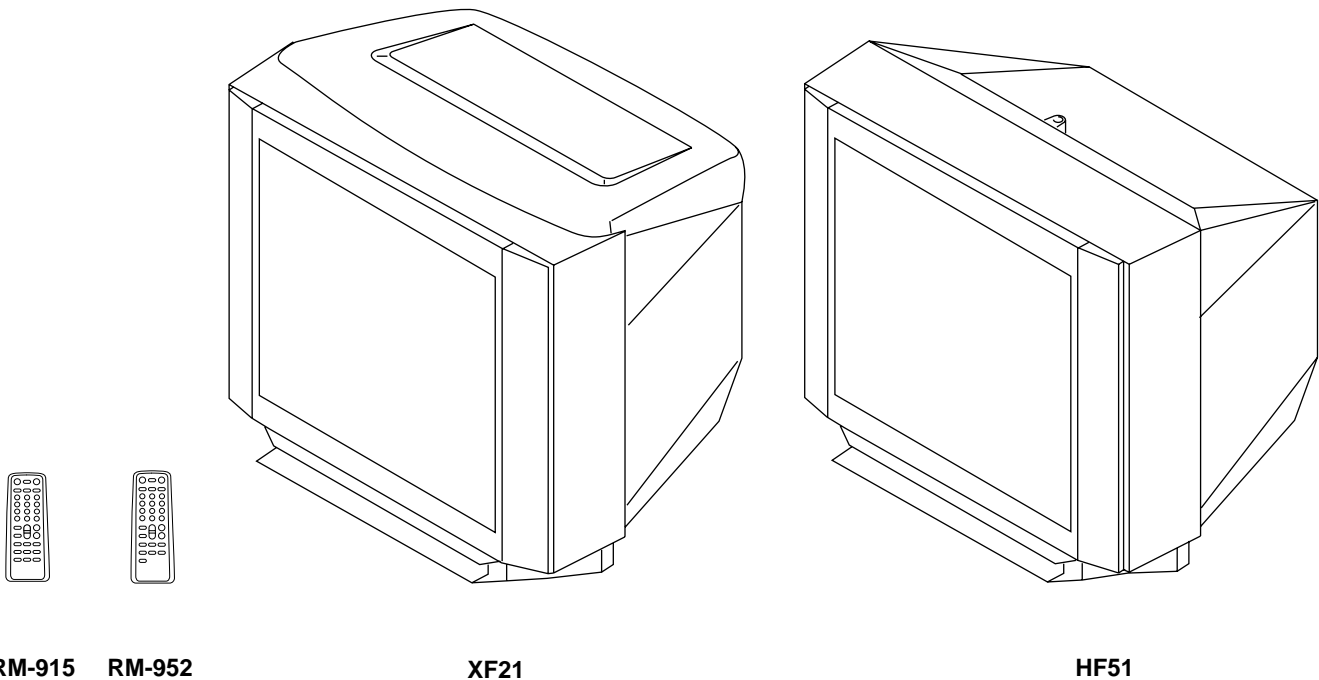

RM-915 RM-952

XF21

HF51



TRINITRON® COLOR TV  
**SONY®**

## SPECIFICATIONS (KV-HF51P50)

		Note
<b>Power requirements</b>	110-240 V AC, 50/60 Hz	
<b>Power consumption (W)</b>	Indicated on the rear of the TV	
<b>Television system</b>	B/G	
<b>Color system</b>	PAL, PAL 60, NTSC4.43, NTSC3.58 (AV IN)	
<b>Channel coverage</b>	VHF: E2 to E12 / UHF: E21 to E69 / CATV: S01 to S03, S1 to S41	
<b>⏏ (Antenna)</b>	75-ohm external terminal	
<b>Audio output</b>	5W + 5W	
<b>Number of terminal</b>		
📺 (Video)	Input: 2 Output: 1	Phono jacks; 1 V <sub>P-P</sub> , 75 ohms
🎵 (Audio)	Input: 2 Output: 1	Phono jacks; 500 mV <sub>rms</sub>
🎧 (Headphone)	Output: 1	Minijack
<b>Picture tube</b>		
<b>Tube size (mm)</b>	545	Measured diagonally
<b>Screen size (mm)</b>	507	Measured diagonally
<b>Dimension (w/h/d, mm)</b>	640 × 456 × 495	
<b>Mass (kg)</b>	27	

Design and specifications are subject to change without notice.

**CAUTION**

SHORT CIRCUIT THE ANODE OF THE PICTURE TUBE AND THE ANODE CAP TO THE METAL CHASSIS, CRT SHIELD, OR CARBON PAINTED ON THE CRT, AFTER REMOVING THE ANODE.

**SAFETY-RELATED COMPONENT WARNING!!**

COMPONENTS IDENTIFIED BY SHADING AND MARK  $\triangle$  ON THE SCHEMATIC DIAGRAMS, EXPLODED VIEWS AND IN THE PARTS LIST ARE CRITICAL TO SAFE OPERATION. REPLACE THESE COMPONENTS WITH SONY PARTS WHOSE PART NUMBERS APPEAR AS SHOWN IN THIS MANUAL OR IN SUPPLEMENTS PUBLISHED BY SONY.

## SPECIFICATIONS (KV-XF21M80/XF21M83/XF51M65)

		Note
<b>Power requirements</b>	110-240 V AC, 50/60 Hz	
<b>Power consumption (W)</b>	Indicated on the rear of the TV	
<b>Television system</b>	B/G, I, D/K, M	
<b>Color system</b>	PAL, PAL 60, SECAM, NTSC4.43, NTSC3.58	
<b>Stereo/Bilingual system</b>	NICAM Stereo/Bilingual B/G; I; A2 Stereo/Bilingual (German) B/G	KV-XF51M65 only
<b>Teletext Language</b>	English, Arabic, French	KV-XF51M65 only
<b>Channel coverage</b>	VHF: E2 to E12 / UHF: E21 to E69 / CATV: S01 to S03, S1 to S41	
<b>⏏ (Antenna)</b>	75-ohm external terminal	
<b>Audio output</b>	3W + 3W	KV-XF21M83/ XF51M65
	5W + 5W	KV-XF21M80
<b>3D WOOFER</b>	9W	KV-XF21M83/ XF51M65 only
<b>Number of terminal</b>		
<b>📺 (Video)</b>	Input: 2 Output: 1	Phono jacks; 1 V <sub>P-P</sub> , 75 ohms
<b>🎵 (Audio)</b>	Input: 2 Output: 1	Phono jacks; 500 mV <sub>rms</sub>
<b>🎧 (Headphone)</b>	Output: 1	Minijack
<b>Picture tube</b>	21 inch	
<b>Tube size</b>	54 cm	Measured diagonally
	545 mm	
<b>Screen size</b>	51 cm	Measured diagonally
	507 mm	
<b>Dimension (w/h/d, mm)</b>	640 × 470 × 498	KV-XF21M83/ XF51M65
	640 × 456 × 498	KV-XF21M80
<b>Mass (kg)</b>	29	KV-XF21M83/ XF51M65
	27	KV-XF21M80

Design and specifications are subject to change without notice.

**CAUTION**

SHORT CIRCUIT THE ANODE OF THE PICTURE TUBE AND THE ANODE CAP TO THE METAL CHASSIS, CRT SHIELD, OR CARBON PAINTED ON THE CRT, AFTER REMOVING THE ANODE.

**SAFETY-RELATED COMPONENT WARNING!!**

COMPONENTS IDENTIFIED BY SHADING AND MARK  $\triangle$  ON THE SCHEMATIC DIAGRAMS, EXPLODED VIEWS AND IN THE PARTS LIST ARE CRITICAL TO SAFE OPERATION. REPLACE THESE COMPONENTS WITH SONY PARTS WHOSE PART NUMBERS APPEAR AS SHOWN IN THIS MANUAL OR IN SUPPLEMENTS PUBLISHED BY SONY.

## SPECIFICATIONS (KV-XF21N90)

		Note
<b>Power requirements</b>	110 V AC, 60 Hz	
<b>Power consumption (W)</b>	Indicated on the rear of the TV	
<b>Television system</b>	M	
<b>Color system</b>	NTSC3.58, PAL*, PAL 60*, SECAM*, NTSC 4.43*	*AV only
<b>Stereo system</b>	MTS	
<b>Channel coverage</b>	VHF: 2 to 13/ UHF: 14 to 69 CATV: A-8 to A-1, A-W, W+1 to W+84	
<b>⌈ (Antenna)</b>	75-ohm external terminal	
<b>Audio output</b>	5W + 5W	
<b>Number of terminal</b>		
<b>Video</b>	Input: 2 Output: 1	Phono jacks; 1 V <sub>P-P</sub> , 75 ohms
<b>Audio</b>	Input: 2 Output: 1	Phono jacks; 500 mV <sub>rms</sub>
<b>Headphone</b>	Output: 1	Minijack
<b>Picture tube</b>	21 inch	
<b>Tube size (mm)</b>	545	Measured diagonally
<b>Screen size (mm)</b>	510	Measured diagonally
<b>Dimension (w/h/d, mm)</b>	640 × 456 × 498	
<b>Mass (kg)</b>	27	

Design and specifications are subject to change without notice.

**CAUTION**

SHORT CIRCUIT THE ANODE OF THE PICTURE TUBE AND THE ANODE CAP TO THE METAL CHASSIS, CRT SHIELD, OR CARBON PAINTED ON THE CRT, AFTER REMOVING THE ANODE.

**SAFETY-RELATED COMPONENT WARNING!!**

COMPONENTS IDENTIFIED BY SHADING AND MARK  $\triangle$  ON THE SCHEMATIC DIAGRAMS, EXPLODED VIEWS AND IN THE PARTS LIST ARE CRITICAL TO SAFE OPERATION. REPLACE THESE COMPONENTS WITH SONY PARTS WHOSE PART NUMBERS APPEAR AS SHOWN IN THIS MANUAL OR IN SUPPLEMENTS PUBLISHED BY SONY.

## TABLE OF CONTENTS

<u>Section</u>	<u>Title</u>	<u>Page</u>	<u>Section</u>	<u>Title</u>	<u>Page</u>
	<b>SELF DIAGNOSIS FUNCTION</b> .....	6	<b>5. DIAGRAMS</b>		
<b>1. GENERAL</b> .....		10	5-1. Block Diagram .....		67
<b>2. DISASSEMBLY</b>			5-2. Frame Schematic Diagram .....		70
2-1. 3D Speaker Box Removal .....		46	5-3. Circuit Boards Location .....		73
2-2. Rear Cover Removal .....		46	5-4. Schematic Diagrams and Printed Wiring Boards ...		74
2-3. Chassis Assy Removal .....		46	(1) Schematic Diagram of A (1/2) Board .....		77
2-4. F Bracket Removal .....		46	(2) Schematic Diagrams of A (2/2) and K1 and VM1 Boards .....		82
2-5. Service Position .....		47	(3) Schematic Diagrams of C5 and V1 Boards .....		91
2-6. Replacement of Parts .....		47	(4) Schematic Diagrams of J3, H4 and F Boards .....		99
2-6-1. Replacement of Control Button .....		47	5-5. Semiconductors .....		102
2-6-2. Replacement of Light Guide .....		47	<b>6. EXPLODED VIEWS</b>		
2-7. H4 and K1 Board Removal .....		48	6-1. Chassis (except KV-HF51P50) .....		105
2-8. Terminal Bracket Removal .....		48	6-2. Chassis (KV-HF51P50) .....		108
2-9. Degauss Coil Removal .....		48	6-3. 3D Speaker .....		110
2-10. Picture Tube Removal .....		49	<b>7. ELECTRICAL PARTS LIST</b> .....		111
<b>3. SET-UP ADJUSTMENTS</b>					
3-1. Beam Landing .....		51			
3-2. Convergence .....		52			
3-3. Focus Adjustment .....		54			
3-4. G2 (Screen) and White Balance Adjustments .....		54			
<b>4. CIRCUIT ADJUSTMENT</b>					
4-1. Adjustments with Commander .....		55			
4-2. Adjustment Method .....		56			
4-3. Picture Quality Adjustments .....		64			
4-4. A Board Adjustment After IC003 (Memory) Replacement .....		64			
4-5. Picture Distortion Adjustment .....		65			

## SELF DIAGNOSTIC FUNCTION

The units in this manual contain a self-diagnostic function. If an error occurs, the STANDBY/TIMER lamp will automatically begin to flash.

The number of times the lamp flashes translates to a probable source of the problem. A definition of the STANDBY/TIMER lamp flash indicators is listed in the instruction manual for the user's knowledge and reference. If an error symptom cannot be reproduced, the remote commander can be used to review the failure occurrence data stored in memory to reveal past problems and how often these problems occur.

### 1. DIAGNOSTIC TEST INDICATORS

When an error occurs, the STANDBY/TIMER lamp will flash a set number of times to indicate the possible cause of the problem. If there is more than one error, the lamp will identify the first of the problem areas.

Result for all of the following diagnostic items are displayed on screen. No error has occurred if the screen displays a "0".

Diagnostic Item Description	No. of times STANDBY/TIMER lamp flashes	Self-diagnostic display/Diagnostic result	Probable Cause Location	Detected Symptoms
• Power does not turn on	Does not light	—	<ul style="list-style-type: none"> <li>• Power cord is not plugged in.</li> <li>• Fuse is burned out F4601 (F)</li> </ul>	<ul style="list-style-type: none"> <li>• Power does not come on.</li> <li>• No power is supplied to the TV.</li> <li>• AC power supply is faulty.</li> </ul>
<ul style="list-style-type: none"> <li>• +B overcurrent (OCP) or overvoltage (OVP)</li> <li>• Vertical deflection stopped</li> <li>• Horizontal deflection overdrive</li> </ul>	2 times	002:000 or 002:001~255 003:001~255 004:001~255 at the same time	<ul style="list-style-type: none"> <li>• H.OUT Q511 is shorted. (A board)</li> <li>• IC1800 is shorted. (C5 board)</li> <li>• -13V is not supplied. (A board)</li> <li>• IC 503 faulty (A board)</li> <li>• IC 301 faulty (A board)</li> </ul>	<ul style="list-style-type: none"> <li>• Power does not come on.</li> <li>• Load on power line is shorted.</li> <li>• Has entered standby state after horizontal raster.</li> <li>• Vertical deflection pulse is stopped.</li> <li>• Power line is shorted or power supply is stopped.</li> </ul>
• White balance failure (no PICTURE)	5 times	005:000 or 005:001~225	<ul style="list-style-type: none"> <li>• G2 is improperly adjusted. (Note 2)</li> <li>• CRT problem.</li> <li>• Video OUT IC1800 is faulty. (C5 board)</li> <li>• IC301 is faulty. (A board)</li> <li>• No connection A board to C5 board.</li> </ul>	<ul style="list-style-type: none"> <li>• No raster is generated.</li> <li>• CRT cathode current detection reference pulse output is small.</li> </ul>
• Micro reset	—	101:00 or 101:001~225	<ul style="list-style-type: none"> <li>• Discharge CRT (C5 Board)</li> <li>• Static discharge</li> <li>• External noise</li> </ul>	<ul style="list-style-type: none"> <li>• Power is shut down shortly, after this return back to normal.</li> <li>• Detect Micro latch up.</li> </ul>

Note 1: If a + B overcurrent is detected, stoppage of the vertical deflection is detected simultaneously.

The symptom that is diagnosed first by the microcontroller is displayed on the screen.

Note 2: Refer to screen (G2) Adjustment in section 3-4 of this manual.

## 2. DISPLAY OF STANDBY/TIMER LIGHT FLASH COUNT

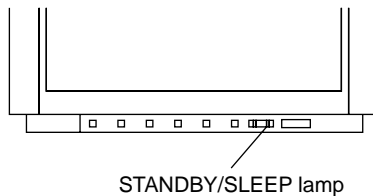
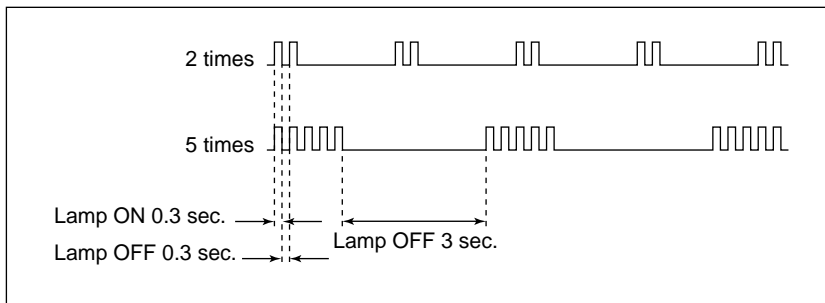

<u>Diagnostic Item</u>	<u>Flash Count*</u>
+B overcurrent/overvoltage Vertical deflection stopped	2 times
White balance failure	5 times

\* One flash count is not used for self-diagnostic.

## 3. STOPPING THE STANDBY/TIMER FLASH

Turn off the power switch on the TV main unit or unplug the power cord from the outlet to stop the STANDBY/TIMER lamp from flashing.

#### 4. SELF-DIAGNOSTIC SCREEN DISPLAY

For errors with symptoms such as “power sometimes shuts off” or “screen sometimes goes out” that cannot be confirmed, it is possible to bring up past occurrences of failure for confirmation on the screen:

##### [To Bring Up Screen Test]

In standby mode, press buttons on the remote commander sequentially in rapid succession as shown below:

Screen display → channel [5] → Sound volume [−] → Power ON  
 ↑

Note that this differs from entering the service mode (mode volume [+]).

##### Self-Diagnosis screen display

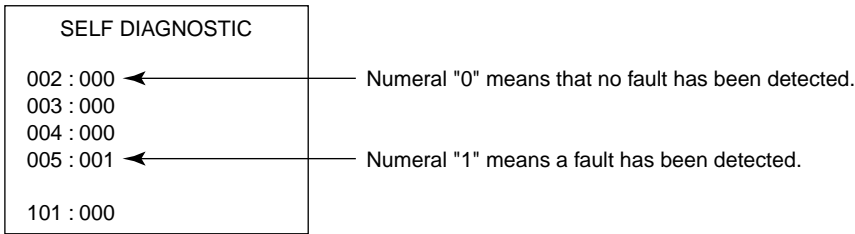

#### 5. HANDLING OF SELF-DIAGNOSTIC SCREEN DISPLAY

Since the diagnostic results displayed on the screen are not automatically cleared, always check the self-diagnostic screen during repairs. When you have completed the repairs, clear the result display to “0”.

Unless the result display is cleared to “0”, the self-diagnostic function will not be able to detect subsequent faults after completion of the repairs.

##### [Clearing the result display]

To clear the result display to “0”, press buttons on the remote commander sequentially as shown below when the diagnostic screen is being displayed.

Channel [8] → 0

##### [Quitting Self-diagnostic screen]

To quit the entire self-diagnostic screen, turn off the power switch on the remote commander or the main unit.



## 6. SELF-DIAGNOSTIC CIRCUIT

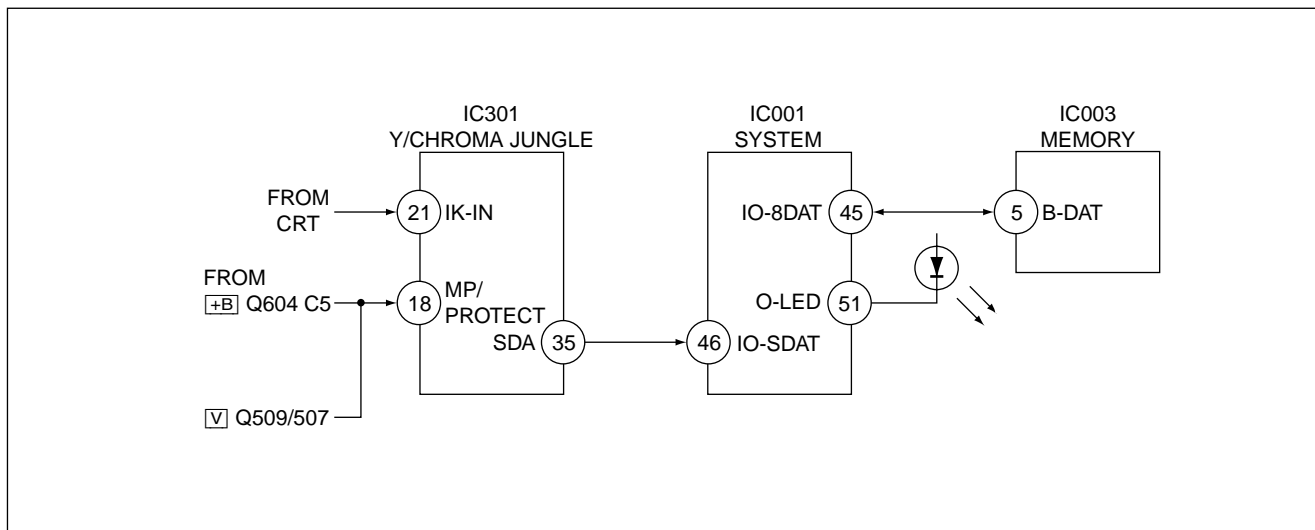

### +B overcurrent (OCP)

Occurs when an overcurrent on the +B(135) line is detected by Q604. If Q604 go to ON and the voltage to pin 18 of IC301 should go down when V.SYNC is more than seven verticals in a period, the unit will automatically turn off.

### Vertical deflection stopped

Occurs when an absence of the vertical deflection pulse is detected by Q509 and IC001 shut down the power supply.

### Vertical deflection overcurrent

Occurs when an overcurrent on V drive line is detected by Q507. Power supply will be shut down when detect this by IC001.

### White balance failure

If the RGB levels\* do not balance or become low level within 5 seconds, this error will be detected by IC301. TV will stay on, but there will be no picture.



\* (Refers to the RGB levels of the AKB detection Ref pulse that detects IK.)

The operating instructions mentioned here are partial abstracts from the Operating Instruction Manual. The page numbers of the Operating Instruction Manual remain as in the manual.

## SECTION 1-1 GENERAL (KV-HF51P50)

### WARNING

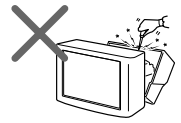
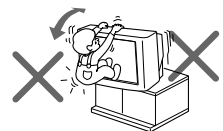
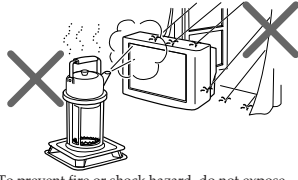
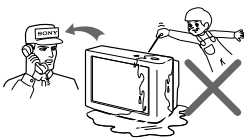
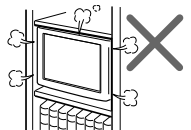
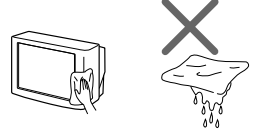
- Dangerously high voltages are present inside the TV.
- Operate the TV only between 110 – 240 V AC.

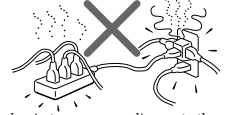
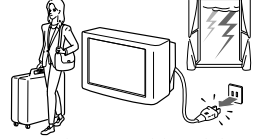
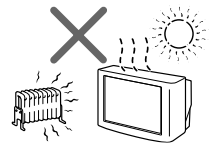
 <p>Do not open the cabinet and the rear cover of the TV. Refer servicing to qualified personnel.</p>	 <p>Install the TV in a stable position. Do not allow children to climb onto it.</p>
 <p>To prevent fire or shock hazard, do not expose the TV to rain or moisture.</p>	 <p>Do not operate the TV if any liquid or solid object falls into it. Have it checked immediately by qualified personnel only.</p>
 <p>Do not install the TV in a confined space, such as a bookcase or built-in cabinet. Do not block the ventilation openings of the TV.</p>	 <p>Clean the TV with a dry and soft cloth. Do not use benzene, thinner, or any other chemicals to clean the TV. Do not scratch the picture tube.</p>
 <p>Do not pull the power cord to disconnect the TV. Pull it out by the plug.</p>	 <p>Do not plug in too many appliances to the same power socket. Do not damage the power cord.</p>
 <p>Disconnect the power cord during lightning storms or if you are not going to use the TV for several days.</p>	 <p>Do not install the TV in hot, humid or excessively dusty places.</p>

### Using Your New TV

## Getting Started

### Step 1

#### Connect the antenna

If you wish to connect a VCR, see the "Connecting a VCR" diagram below.

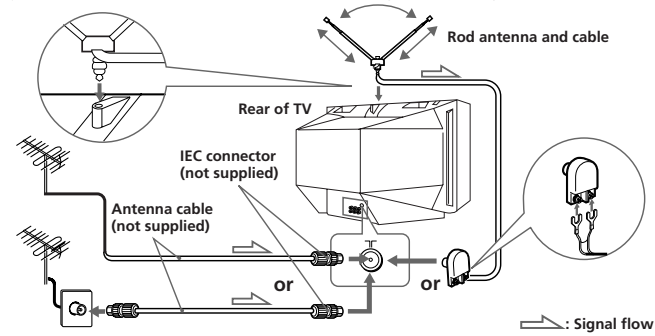

- Note**
- You are advised to use an outdoor antenna for better reception.

#### Connecting a VCR

To watch the video, press (see page 12).

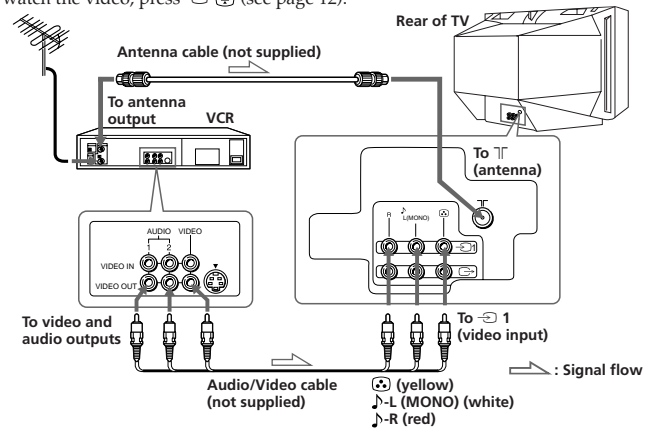

#### Notes

- If you connect a monaural VCR, connect the yellow plug to (yellow jack) and the black plug to L-L (MONO) (the white jack).
- If you connect a VCR to the T (antenna) terminal, preset the signal output from the VCR to the program number 0 on the TV.
- When no signal is input to the connected video equipment, the TV screen becomes blue.

#### CAUTION

Do not connect the power cord until you have completed making all other connections; otherwise a minimum leakage current might flow through the antenna and other terminals to ground.

### Step 2

#### Insert the batteries into the remote

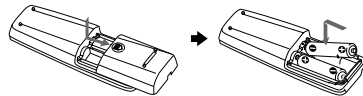

#### Note

- Do not use old batteries nor use different types of batteries together.

### Step 3

#### Preset the channels automatically

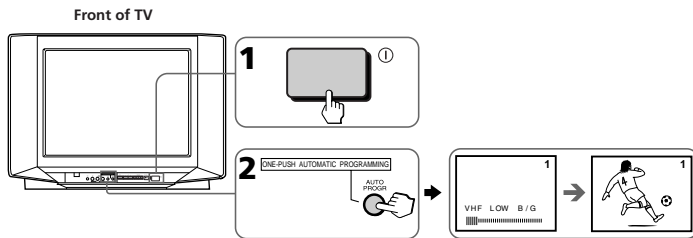

#### Tips

- If you want to exit automatic channel presetting, press SELECT twice.
- If your TV has preset an unwanted channel or cannot preset a particular channel, then preset your TV manually (see page 9).

#### Now You Are Ready...

To watch your TV, see page 11.

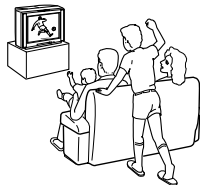

Using Your New TV | 5

Using Your New TV

## Connecting optional components

You can connect optional audio/video components, such as a VCR, multi disc player, camcorder, video game or stereo system.

To watch the picture of the connected equipment, press (see page 12).

### Connecting a camcorder/video game equipment using the (video input) jacks

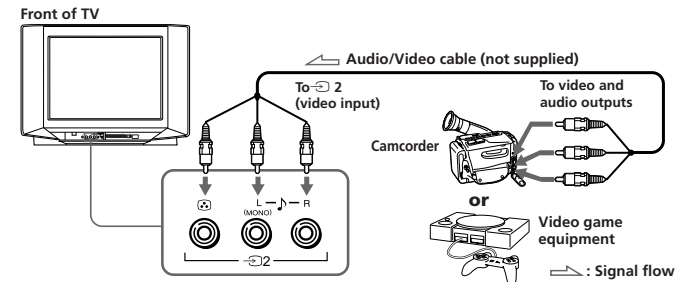

#### Note

- You can also connect video equipment to the (video input) jacks at the rear of your TV.

### Connecting audio/video equipment using the (monitor output) jacks

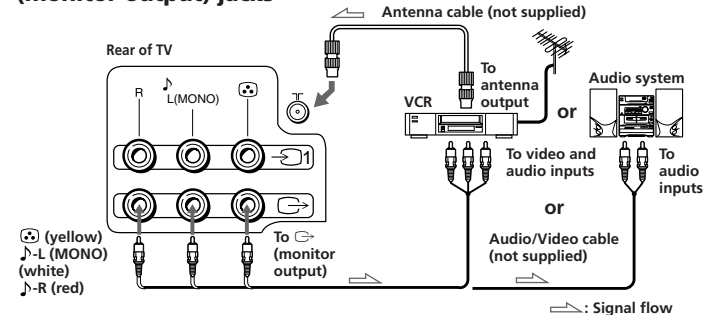

#### Note

- When connecting a monaural VCR, connect the yellow plug to (yellow jack) and the black plug to L-L (MONO) (the white jack).

6 | Using Your New TV

## Securing the TV

To prevent the TV from falling, secure the TV using one of the following methods:

**A** With the supplied screws, attach the band to the TV stand and to the rear of the TV using the provided hole.

or

**B** Put the cord or chain through the clamps to secure the TV against a wall or pillar.

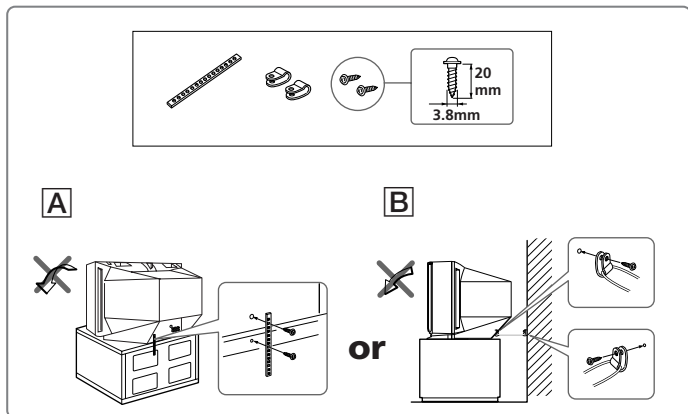

**Note**

- Use only the supplied screws. Use of other screws may damage the TV.

Using Your New TV

## Presetting channels

You can preset up to 100 TV channels in numerical sequence from program number 1 using the remote and the buttons on your TV as well.

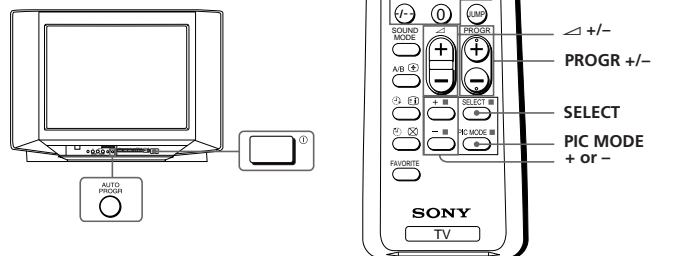

### Presetting channels automatically

**1** Press **⏻** to turn on the TV.



**2** Press **AUTO PROGR.**





### To preset channels automatically from a specified program number

- (1) Press **SELECT** until "AUTO PROGRAM" appears.
- (2) Press **+ or -**.  
The on-screen display will start flashing.
- (3) Press **PROGR +/-** or the number buttons until the desired program number appears.
- (4) Press **+ or -**.

### Presetting channels manually

- 1** Press SELECT until "MANUAL PROGRAM" appears.

- 2** Press + or -.

- 3** Press PROGR +/- or the number buttons until the desired program number appears.

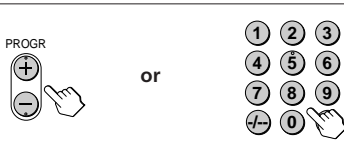
- 4** Press + or - until the desired channel picture appears.

- 5** Press SELECT.



Using Your New TV

continued

Using Your New TV | 9

### Presetting channels (continued)

#### To change the color system setting

If the color is abnormal when receiving programs through the ㄗ (antenna) terminal or the ㄎ (video input) jack

- (1) Press SELECT until "COL SYS" appears.



- (2) Press + or - to select the appropriate color system until the color is optimal.

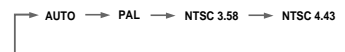

**Tip**

- Normally set "COL SYS" to "AUTO".

#### Skipping program numbers

- 1** Press PROGR +/- or the number buttons until the unused or unwanted program number appears.
- 2** Press SELECT until "MANUAL PROGRAM" appears.
- 3** Press + or -.
- 4** Press PIC MODE.
- 5** Press SELECT.

#### To preset the skipped program number again

Preset the channel automatically or manually.

**Tip**

- You can also use SELECT and ㄎ +/- on the TV to preset channels and skip program numbers.

#### To use the fine tuning (FINE) function

The fine tuning (FINE) function may help to reduce the following problems: double images and lines moving across the TV screen.

You can use the fine tuning function as below:

- (1) Select the program number you want to adjust.
- (2) Press SELECT until "MANUAL PROGRAM" appears on the screen.
- (3) Press + or - on the remote control once.
- (4) Press ㄎ to display "FINE" on the screen.
- (5) Press + or - continuously until the above problems are minimized.  
The + or - icon on the screen flashes while tuning.
- (6) Press SELECT to return to normal screen.

10 | Using Your New TV

## Watching the TV

This section explains functions used while watching the TV. Most operations can be done using the remote.

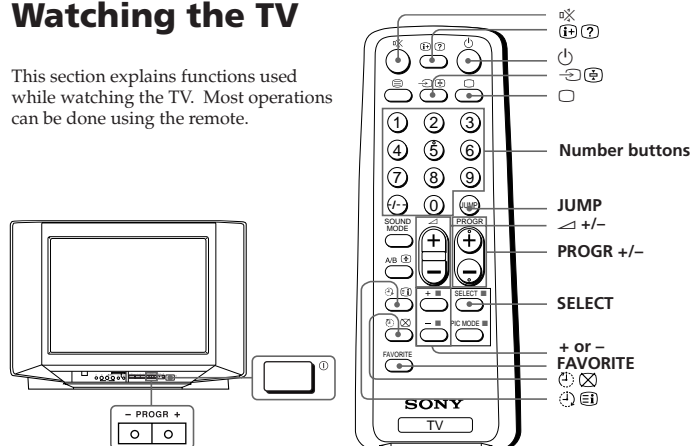

Using Your New TV

### 1 Press ① to turn on the TV.

When the TV is in the standby mode (the ① indicator on the TV is lit red), press ① on the remote or PROGR +/- on the TV.



### 2 Press PROGR +/- or the number buttons to select the TV program.

For double digit numbers, press +/-, then the number (e.g., for 25, press +/-, then 2 and 5).

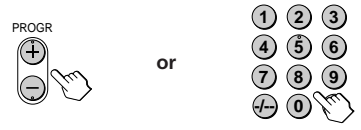

### 3 Press +/- to adjust the volume.



## Watching the TV (continued)

### Additional tasks

To	Do this
Turn off temporarily	Press ①. The ① indicator on the TV lights up red.
Turn off completely	Press ① on the TV.
Mute the sound	Press ②.
Watch the video input (VCR, camcorder, etc.)	Press ③ to select "VIDEO 1" or "VIDEO 2". To return to the TV program, press ④.
Jump back to the previous channel	Press JUMP.
Display the on-screen information*	Press ⑤.
Adjust the volume of each TV program automatically	Press SELECT repeatedly until "INTELLIGENT VOL" appears, then press + or - to select "ON". To cancel, select "OFF".
Adjust the picture position when it is not aligned to the TV screen	Press SELECT repeatedly until "PIC ROTATION" appears, then press + or - to adjust the alignment of the picture position

### PIC ROTATION

The ⑥ or ⑦ icon on the screen flashes while adjusting.

\* The picture, sound, and either the program number or video mode are displayed. The on-screen display for the picture and sound information disappears after about 3 seconds.

## Changing the on-screen display language

### 1 Press SELECT until "LANGUAGE / 语言: ENGLISH" appears on the screen.



### 2 Press + or - to select "中文".



**Tip**  
 • You can also use SELECT and +/- on the TV to select the on-screen display language.

continued

### Setting the Wake Up timer

1 Press until the desired period of time appears.

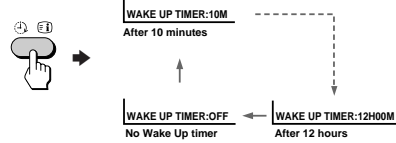

2 Select the TV program or video mode you want to display when you wake up.

3 Press or set the Sleep timer if you want the TV to turn off automatically.

The indicator on the TV lights up orange.

### To cancel the Wake Up timer

Press until "WAKE UP TIMER: OFF" appears or turn off the TV's main power.

#### Notes

- The Wake Up timer starts immediately after the on-screen display disappears.
- If no buttons or controls are pressed for more than two hours after the TV is turned on using the Wake Up timer, the TV automatically goes into the standby mode. To continue watching the TV, press any button or control on the TV or the remote.

### Setting the Sleep timer

Press until the desired period of time appears.

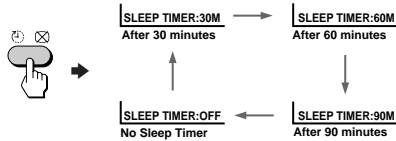

### To cancel the Sleep timer

Press until "SLEEP TIMER: OFF" appears or turn the TV off.

## Advanced Operations

### Customizing the picture and sound

You can customize the picture and sound by selecting the picture and sound modes or by adjusting its settings.

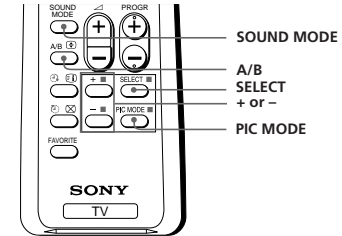

### Selecting the picture and sound modes

#### To select the picture mode

Press PIC MODE repeatedly until you get the desired picture mode.

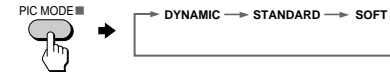

Select	To
DYNAMIC	receive high contrast pictures.
STANDARD	receive normal contrast pictures.
SOFT	receive mild pictures.

#### To select the sound mode

Press SOUND MODE repeatedly until you get the desired sound mode.



Select	To
DYNAMIC	listen to dynamic and clear sound that emphasizes the low and high sound.
DRAMA	listen to sound that emphasizes vocals and background music.
SOFT	receive soft sound.

## Adjusting the picture and sound settings

- 1 Press SELECT until the desired setting appears.



Each time you press SELECT, the setting item will change as follows:

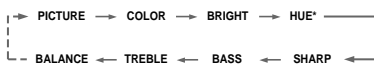

- 2 Press + or - to adjust the item.



- 3 To adjust other items, repeat steps 1 to 2.

\* "HUE" can be adjusted for NTSC system only.

### Notes

- When you select a picture or sound mode, the adjusted settings will be reset according to the selected mode.
- You can also use SELECT and  $\Delta$  +/- on the TV to adjust the sound and picture settings.

## Selecting the surround mode

- 1 Press SELECT repeatedly until "SURROUND" appears.



- 2 Press + or - to select the desired surround sound.



Select	To
MOVIE	listen to sound that spreads out over a large area, giving the feeling of being at a movie theatre.
MUSIC	listen to the sound that gives the feeling of being at a live concert.
OFF	turn off the surround sound.

## Viewing your favorite channels

You can display six of your favorite channels for quick and easy selection. You can change the favorite channel setting as well.

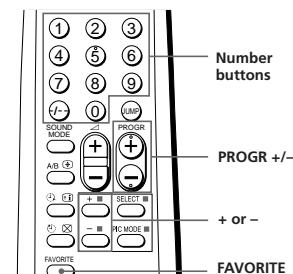

### Selecting a favorite channel

- 1 Press FAVORITE.

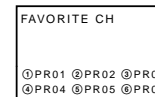

- 2 Press the number button from 1 to 6 to select the desired channel.

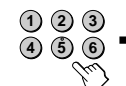

When you use the FAVORITE CH feature for the first time, six preset channels will appear.

### Changing the favorite channel setting

- 1 Press SELECT until "FAVORITE CH SET UP" appears.



- 2 Press + or - to select the favorite channel you want to change (e.g. ③ PR03).

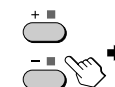

- 3 Press PROG +/-, or the number buttons to change the program number.

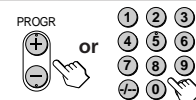

- 4 Repeat steps 2 and 3 to set other favorite channels.

- 5 Press SELECT.



## Blocking the channels (CHILD LOCK)

You can prevent a child from watching certain programs by using the buttons on the remote control.

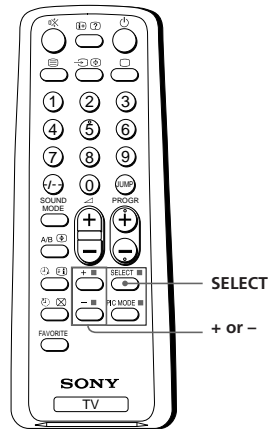



**1** Select the TV program you want to lock.

**2** Press SELECT until "CHILD LOCK" appears on the screen.



**3** Press + or - to select "ON".

The  symbol appears on the screen.

To unlock the channel, press + or - to select "OFF". The  symbol disappears from the screen.





### Note

- If you preset a locked channel, that particular channel will be unlocked automatically.

## Additional Information

### Self-diagnosis function

Your TV is equipped with a self-diagnosis function. If there is a problem with your TV, the  indicator flashes red. The number of times the  indicator flashes indicates the possible causes.

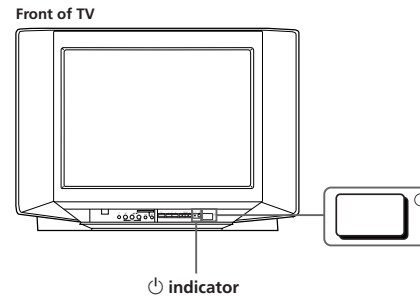

**1** Check that the  indicator flashes red a number of times between 3-second intervals.









**2** Count the number of times the  indicator flashes.

**3** Press  (main power) to turn off your TV.

**4** Inform your nearest Sony service center about the number of times the  indicator flashes. Be sure to note the model name and serial number located on the rear of your TV.







## Troubleshooting



If you find any problem while viewing your TV, please check the following guide. If any problem persists, contact your Sony dealer .

Symptom	Solutions	Possible cause
<b>Snowy picture</b> 	<ul style="list-style-type: none"> <li>Check the antenna cable and connection on the TV, VCR and on the wall. (page 4)</li> <li>Press SELECT until "MANUAL PROGRAM" appears on the screen then preset the channel again. (page 9)</li> </ul>	<ul style="list-style-type: none"> <li>Connection is loose or the cable is damaged.</li> <li>Channel presetting is inappropriate or incomplete.</li> </ul>
<b>Noisy sound</b> 	<ul style="list-style-type: none"> <li>Check the antenna type (VHF/UHF). Contact a Sony dealer for advice.</li> <li>Adjust the antenna direction. Contact a Sony dealer for advice.</li> <li>Try using a booster.</li> </ul>	<ul style="list-style-type: none"> <li>The antenna type is inappropriate.</li> <li>The antenna direction is inappropriate.</li> <li>Signal transmission is low.</li> </ul>
<b>Distorted picture</b> 	<ul style="list-style-type: none"> <li>Turn off or disconnect the booster if it is in use.</li> </ul>	<ul style="list-style-type: none"> <li>Broadcast signals are too strong.</li> </ul>
<b>Noisy sound</b> 		
<b>Good picture</b> 	<ul style="list-style-type: none"> <li>If the sound of all the channels are noisy, press AUTO PROGR to preset the channels again. (page 8)</li> </ul>	<ul style="list-style-type: none"> <li>Channel presetting is inappropriate or incomplete.</li> </ul>
<b>Noisy sound</b> 		
<b>No picture</b> 	<ul style="list-style-type: none"> <li>Check the power cord, antenna and the VCR connections.</li> <li>Press ⏻ (power).</li> <li>Press ⏻ (main power) on the TV to turn off the TV for about five seconds, then turn it on again.</li> </ul>	<ul style="list-style-type: none"> <li>The power cord, antenna or VCR is not connected.</li> <li>The TV is not turned on.</li> </ul>
<b>No sound</b> 		

Additional Information

## Troubleshooting (continued)

Symptom	Solutions	Possible cause
<b>Good picture</b> 	<ul style="list-style-type: none"> <li>Press <math>\triangleleft</math> + to increase the volume level.</li> <li>Press <math>\times</math> to cancel the muting.</li> </ul>	<ul style="list-style-type: none"> <li>The volume level is too low.</li> <li>The sound is muted.</li> </ul>
<b>No sound</b> 		
<b>Dotted lines or stripes</b> 	<ul style="list-style-type: none"> <li>Do not use a hair dryer or other equipment near the TV.</li> <li>Adjust the antenna direction for minimum interference. Contact a Sony dealer for advice.</li> </ul>	<ul style="list-style-type: none"> <li>There is local interference from cars, neon signs, hair dryers, power generators, etc.</li> </ul>
<b>Double images or "ghosts"</b> 	<ul style="list-style-type: none"> <li>Use a highly directional antenna.</li> <li>Use the fine tuning (FINE) function. (page 10)</li> <li>Adjust the antenna direction. Contact a Sony dealer for advice.</li> <li>Turn off or disconnect the booster if it is in use.</li> </ul>	<ul style="list-style-type: none"> <li>Broadcast signals are reflected by nearby mountains or buildings.</li> <li>The antenna direction is inappropriate.</li> <li>Use of a booster is inappropriate.</li> </ul>
<b>No color</b> 	<ul style="list-style-type: none"> <li>Press SELECT until "COLOR" appears on the screen, then press + or - to adjust the color level. (page 15)</li> <li>Press SELECT until "COL.SYS" appears on the screen, then check the color system setting (usually set this to "AUTO"). (page 10).</li> <li>Adjust the antenna direction. Contact a Sony dealer for advice.</li> </ul>	<ul style="list-style-type: none"> <li>The color level setting is too low.</li> <li>The color system setting is inappropriate.</li> <li>The antenna direction is inappropriate.</li> </ul>
<b>Abnormal color patches</b> 	<ul style="list-style-type: none"> <li>Locate the TV away from external speakers or other equipment. Do not move the TV while the TV is turned on. Press ⏻ (main power) on the TV to turn off the TV for about five minutes, then turn it on again.</li> </ul>	<ul style="list-style-type: none"> <li>The magnetic disturbance from external speakers or other equipment, or the direction of the earth's magnetic field may affect the TV.</li> </ul>



Symptom	Solutions	Possible cause
<b>Picture slant</b> 	<ul style="list-style-type: none"> <li>Press SELECT until "PIC ROTATION" appears on the screen, then press + or - to align the picture to the TV screen. (page 12)</li> </ul>	<ul style="list-style-type: none"> <li>The terrestrial magnetism affects your TV set.</li> </ul>
Lines moving across the TV screen.	<ul style="list-style-type: none"> <li>Use the fine tuning (FINE) function. (page 10)</li> </ul>	<ul style="list-style-type: none"> <li>There is interference from external sources, e.g., heavy machineries, nearby broadcast station.</li> </ul>
The  indication on your TV flashes red a number of times between 3-second intervals.	<ul style="list-style-type: none"> <li>Contact your nearest Sony service center. (page 18)</li> </ul>	<ul style="list-style-type: none"> <li>Your TV may need service.</li> </ul>
TV cabinet creaks.	—	<ul style="list-style-type: none"> <li>Changes in room temperature sometimes make the TV cabinet expand or contract, making a noise. This does not indicate a malfunction.</li> </ul>
A "boom" sound is heard when the TV is turned on.	—	<ul style="list-style-type: none"> <li>The TV's demagnetizing function is working. This does not indicate a malfunction.</li> </ul>

## Identifying parts and controls

Refer to the pages indicated in parentheses ( ) for details.

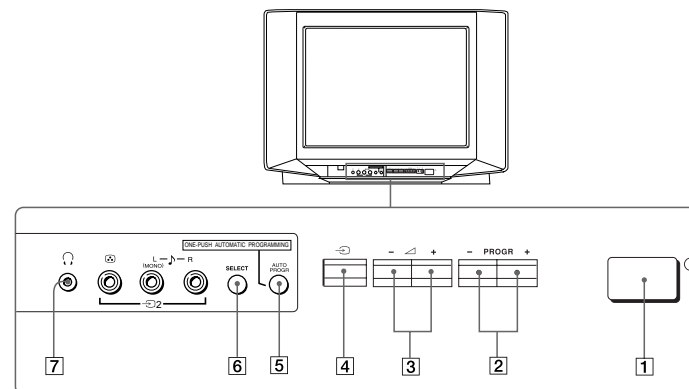
### Front panel



- 1 ① (main power) button (11)
- 2 PROGR +/- (program) buttons (11)
- 3 +/- (volume) buttons (11)
- 4  (TV/video) button (12)
- 5 AUTO PROGR (program) button (5)
- 6 SELECT button (10)
- 7  (headphone) jack

## Remote Control

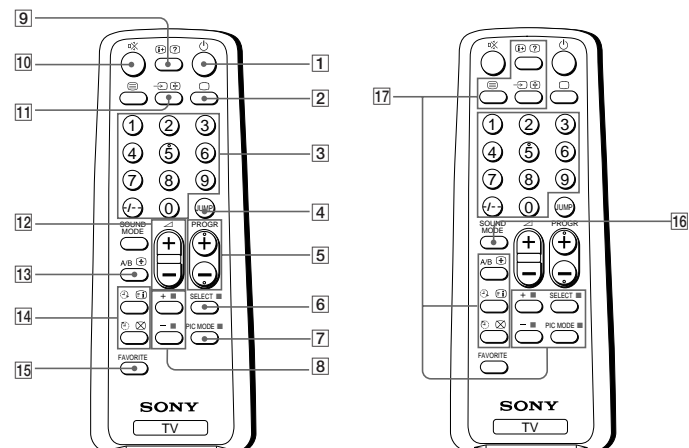

- 1** ⏻ (power) button (11)
- 2** □ (TV) button (12)
- 3** Number buttons (11)
- 4** JUMP button (12)
- 5** PROGR +/- buttons (11)
- 6** SELECT button (9)
- 7** PIC MODE button (14)
- 8** +/- buttons (8)
- 9** Ⓜ (display) button (12)
- 10** ⓧ (muting) button (12)
- 11** Ⓜ (video) button (12)
- 12** ⚡ +/- (volume) buttons (11)
- 13** A/B button  
(not used for KV-HF51P50)
- 14** Timer setting buttons (13)
  - ⌚ (wake up timer)
  - ⌚ (sleep timer)
- 15** FAVORITE button (16)

- 16** SOUND MODE button (14)
- 17** Teletext operation buttons  
(not used for KV-HF51P50)
  - Ⓜ (text)      Ⓜ (enlarge)
  - Ⓜ (reveal)      Ⓜ (hold)
  - Ⓜ (index)      Ⓜ (text clear)
  - (FASTEXT: red, green, yellow, blue)

Names/symbols of buttons on the remote are indicated in different colors to represent the available functions.

Label color	Button function
White	For general TV operations
Green	For Teletext operations





The operating instructions mentioned here are partial abstracts from the Operating Instruction Manual. The page numbers of the Operating Instruction Manual remain as in the manual.

## SECTION 1-2 GENERAL

(KV-XF21M80/XF21M83/XF51M65)

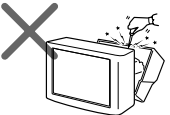
### WARNING

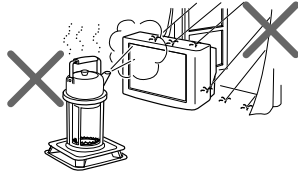
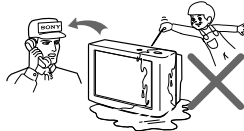
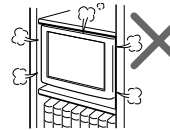
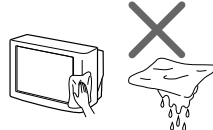
- Dangerously high voltages are present inside the TV.
- Operate the TV only between 110 – 240 V AC.

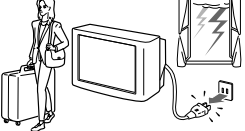
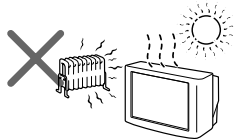
 <p>Do not open the cabinet and the rear cover of the TV. Refer servicing to qualified personnel.</p>	 <p>Install the TV in a stable position. Do not allow children to climb onto it.</p>
 <p>To prevent fire or shock hazard, do not expose the TV to rain or moisture.</p>	 <p>Do not operate the TV if any liquid or solid object falls into it. Have it checked immediately by qualified personnel only.</p>
 <p>Do not install the TV in a confined space, such as a bookcase or built-in cabinet. Do not block the ventilation openings of the TV.</p>	 <p>Clean the TV with a dry and soft cloth. Do not use benzine, thinner, or any other chemicals to clean the TV. Do not scratch the picture tube.</p>
 <p>Do not pull the power cord to disconnect the TV. Pull it out by the plug.</p>	 <p>Do not plug in too many appliances to the same power socket. Do not damage the power cord.</p>
 <p>Disconnect the power cord during lightning storms or if you are not going to use the TV for several days.</p>	 <p>Do not install the TV in hot, humid or excessively dusty places.</p>

### Using Your New TV

## Getting Started

### Step 1

#### Connect the antenna

If you wish to connect a VCR, see the "Connecting a VCR" diagram below.

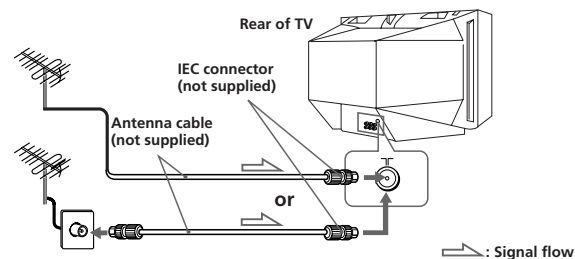

#### Note

- Rod antenna and cable are supplied for KV-XF21M80 only.

#### Connecting a VCR

To watch the video, press   (see page 13).

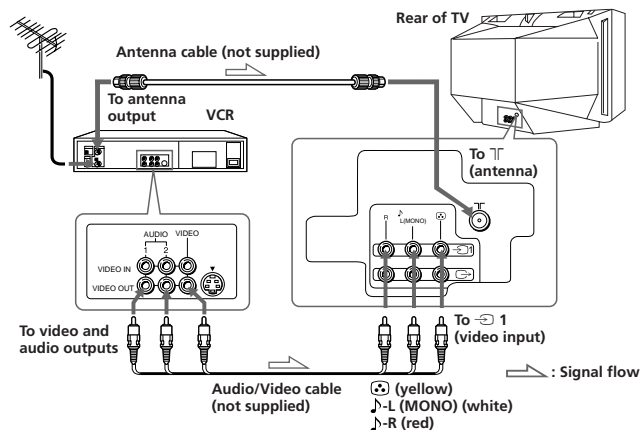

**Notes**

- If you connect a monaural VCR, connect the yellow plug to (Ⓜ) (the yellow jack) and the black plug to (MONO) (the white jack).
- If you connect a VCR to the (ANT) (antenna) terminal, preset the signal output from the VCR to the program number 0 on the TV.
- When no signal is input to the connected video equipment, the TV screen becomes blue.

**CAUTION**

Do not connect the power cord until you have completed making all other connections; otherwise a minimum leakage current might flow through the antenna and other terminals to ground.

**Step 2**

**Insert the batteries into the remote**

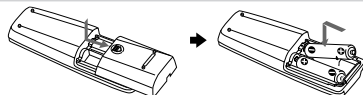

**Note**

- Do not use old batteries nor use different types of batteries together.

**Step 3**

**Preset the channels automatically**

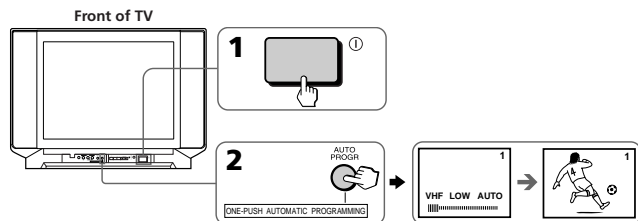

**Tips**

- If you want to stop automatic channel presetting, press SELECT twice.
- If your TV has preset an unwanted channel or cannot preset a particular channel, then preset your TV manually (see page 10).

**Note (KV-XF21M80/XF21M83 only)**

- During automatic channel presetting, your TV screen will indicate "B/G", "I", "D/K" or "M" for the TV system.

**Now You Are Ready. . .**

To watch your TV, see page 12.

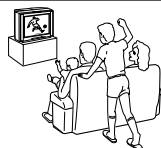

**Connecting the 3D WOOFER**

(KV-XF21M83/XF51M65 only)

You can enjoy high quality sound by connecting the 3D WOOFER.

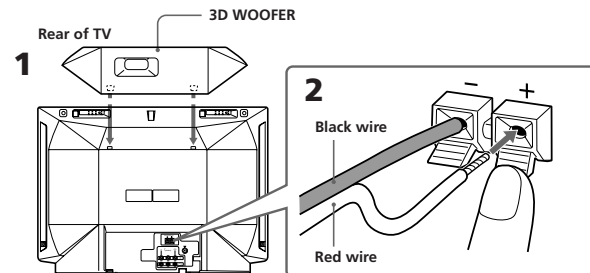

**1** Attach the 3D WOOFER into the footholds on the top of your TV.

**2** Connect the wires to the 3D WOOFER (8Ω) terminals at the rear of your TV. The red wire should be connected to the ⊕ red terminal and the black wire to the ⊖ black terminal.

**Notes**

- Connect only the supplied 3D WOOFER; otherwise your TV may malfunction.
- Unplug your TV from the wall outlet when connecting the 3D WOOFER.
- To prevent a malfunction caused by a short circuit of the terminals, make sure that none of the 3D WOOFER wire strands stick out, making contact with the neighbouring speaker terminal.

## Connecting optional components

You can connect optional audio/video components, such as a VCR, multi disc player, camcorder, video game or stereo system.

To watch the picture of the connected equipment, press  $\rightarrow$   $\oplus$  (see page 13).

### Connecting a camcorder/video game equipment using the $\rightarrow$ 2 (video input) jacks

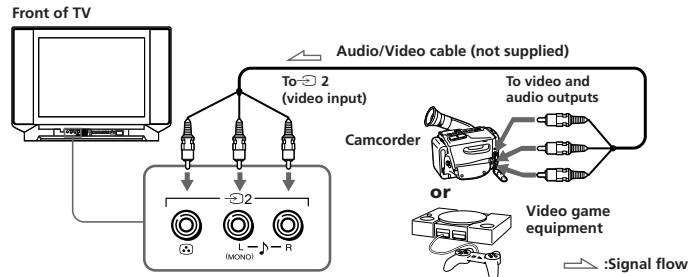

**Note**

- You can also connect video equipment to the  $\rightarrow$  1 (video input) jacks at the rear of your TV.

### Connecting audio/video equipment using the $\rightarrow$ (monitor output) jacks

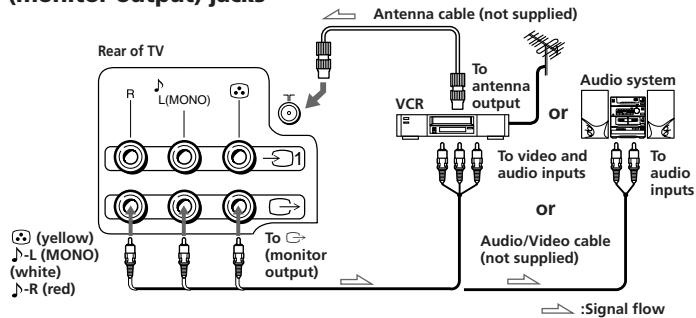

**Note**

- When connecting a monaural VCR, connect the yellow plug to  $\rightarrow$  (the yellow jack) and the black plug to  $\rightarrow$ -L (MONO) (the white jack).

## Securing the TV

To prevent the TV from falling, secure the TV using one of the following methods:

- A** With the supplied screws, attach the band to the TV stand and to the rear of the TV using the provided hole.

or

- B** Put the cord or chain through the clamps to secure the TV against a wall or pillar.

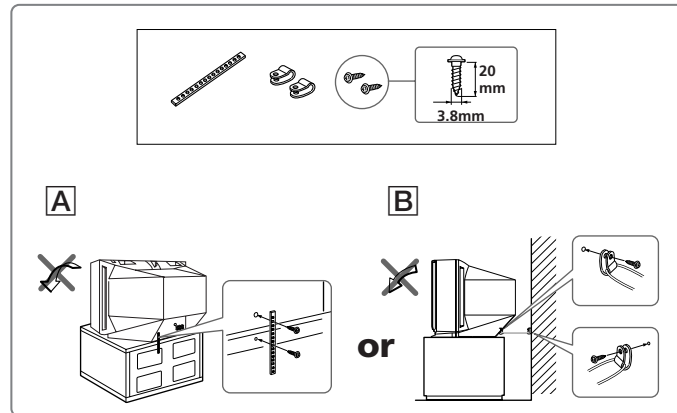

## Presetting channels

You can preset up to 100 TV channels in numerical sequence from program number 1 using the remote and the buttons on your TV as well.

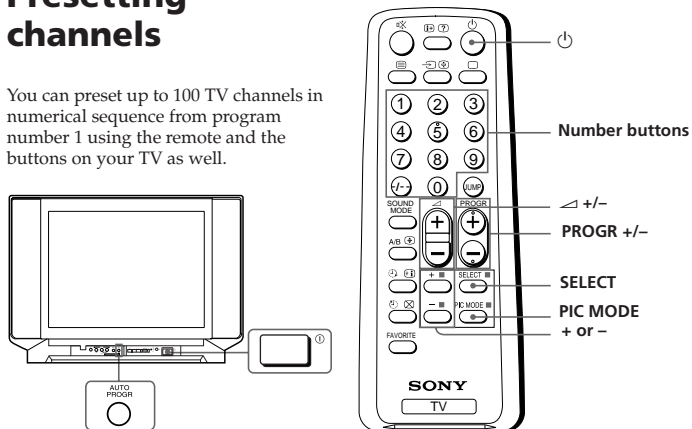

Using Your New TV

### Presetting channels automatically

- 1 Press ① to turn on the TV.
- 2 Press AUTO PROGR.

**Note (KV-XF21M80/XF21M83 only)**

- During automatic channel presetting, your TV screen will indicate "B/G", "I", "D/K" or "M" for the TV system.

### To preset channels automatically from a specified program number

- (1) Press SELECT until "AUTO PROGRAM" appears.
- (2) Press + or -. The on-screen display will start flashing.
- (3) Press PROGR +/- or the number buttons until the desired program number appears.
- (4) Press + or -.

continued

### Presetting channels (continued)

#### Presetting channels manually

- 1 Press SELECT until "MANUAL PROGRAM" appears.
- 2 Press + or -.
- 3 Press PROGR +/- or the number buttons until the desired program number appears.
- 4 Press + or - until the desired channel picture appears.
- 5 Press SELECT.

### To change the TV system setting

If the picture or sound is abnormal when receiving programs through the ㊦ (antenna) terminal

- (1) Press SELECT until "TV SYS" appears.



- (2) Press + or - to select the appropriate TV system until the picture or sound quality is optimal.

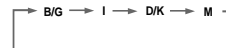



### To change the color system setting

If the color is abnormal when receiving programs through the ㊂ (antenna) terminal or the ㊂ (video input) jack

- Press SELECT until "COL SYS" appears.



- Press + or - to select the appropriate color system until the color is optimal.

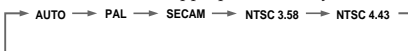

**Tip**

- Normally set "COL SYS" to "AUTO".

### Skipping program numbers

- Press PROG +/- or the number buttons until the unused or unwanted program number appears.
- Press SELECT until "MANUAL PROGRAM" appears.
- Press + or -.
- Press PIC MODE.
- Press SELECT.

### To preset the skipped program number again

Preset the channel automatically or manually.

**Tip**

- You can also use SELECT and ㄨ +/- on the TV to preset channels and skip program numbers.

### To use the fine tuning (FINE) function

The fine tuning (FINE) function may help to reduce the following problems: incomplete Teletext display (KV-XF51M65 only), double images and lines moving across the TV screen.

You can use the fine tuning function as below:

- Select the program number you want to adjust.
- Press SELECT until "MANUAL PROGRAM" appears on the screen.
- Press + or - on the remote control once.
- Press ㊂ (?) to display "FINE" on the screen.
- Press + or - continuously until the above problems are minimized. The + or - icon on the screen flashes while tuning.
- Press SELECT to return to normal screen.

## Watching the TV

This section explains functions used while watching the TV. Most operations can be done using the remote.

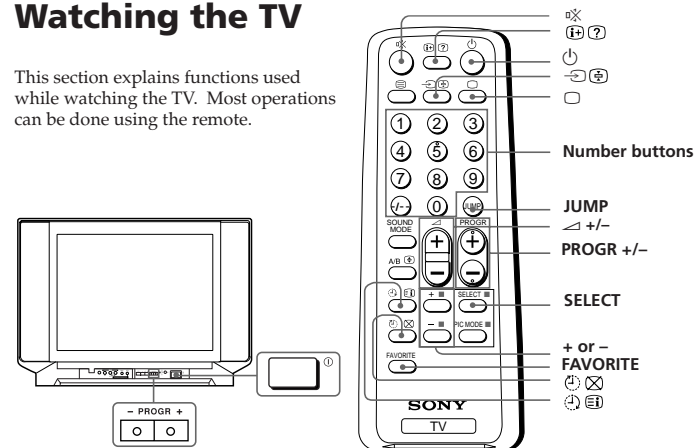

- Press ㊂ to turn on the TV.

When the TV is in the standby mode (the ㊂ indicator on the TV is lit red), press ㊂ on the remote or PROG +/- on the TV.



- Press PROG +/- or the number buttons to select the TV program.

For double digit numbers, press +/-, then the number (e.g., for 25, press +/-, then 2 and 5).

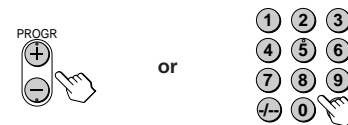

- Press ㄨ +/- to adjust the volume.



### Additional tasks



To	Do this
Turn off temporarily	Press . The  indicator on the TV lights up red.
Turn off completely	Press  on the TV.
Mute the sound	Press .
Watch the video input (VCR, camcorder, etc.)	Press  to select "VIDEO 1" or "VIDEO 2". To return to the TV program, press .
Jump back to the previous channel	Press JUMP.
Display the on-screen information*	Press .
Adjust the volume of each TV program automatically	Press SELECT repeatedly until "INTELLIGENT VOL" appears, then press + or - to select "ON". To cancel, select "OFF".
Adjust the picture position when it is not aligned to the TV screen	Press SELECT repeatedly until "PIC ROTATION" appears, then press + or - to adjust the alignment of the picture position.

**PIC ROTATION**

The or icon on the screen flashes while adjusting.

\* The picture, sound, and either the program number or video mode are displayed. The on-screen display for the picture and sound information disappears after about 3 seconds.

### Changing the on-screen display language (KV-XF21M80(ME))

- Press SELECT until "LANGUAGE / اللغة: ENGLISH" appears on the screen.
 
- Press + or - to select "عربي".
 

**Tip**

- You can also use SELECT and +/- on the TV to select the on-screen display language.

**continued**

### Changing the on-screen display language (KV-XF21M80(E,Vietnam)/XF21M83/XF51M65)

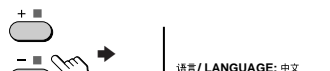
- Press SELECT until "LANGUAGE / 语言: ENGLISH" appears on the screen.
 
- Press + or - to select "中文".
 

**Tip**

- You can also use SELECT and +/- on the TV to select the on-screen display language.

## Setting the Wake Up timer

- 1 Press until the desired period of time appears.

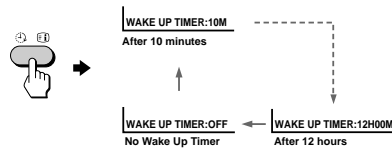

- 2 Select the TV program or video mode you want to display when you wake up.

- 3 Press or set the Sleep timer if you want the TV to turn off automatically.

The indicator on the TV lights up orange.

## To cancel the Wake Up timer

Press until "WAKE UP TIMER: OFF" appears or turn off the TV's main power.

### Notes

- The Wake Up timer starts immediately after the on-screen display disappears.
- If no buttons or controls are pressed for more than two hours after the TV is turned on using the Wake Up timer, the TV automatically goes into the standby mode. To continue watching the TV, press any button or control on the TV or the remote.

## Setting the Sleep timer

Press until the desired period of time appears.

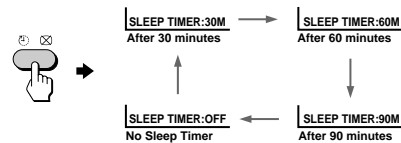

## To cancel the Sleep timer

Press until "SLEEP TIMER: OFF" appears or turn the TV off.

## Advanced Operations

### Customizing the picture and sound

You can customize the picture and sound by selecting the picture and sound modes or by adjusting its settings.

You can change the sound effect by selecting the surround mode.

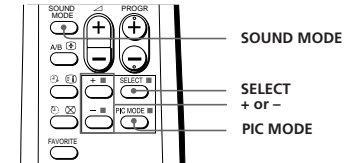

### Selecting the picture and sound modes

#### To select the picture mode

Press PIC MODE repeatedly until you get the desired picture mode.

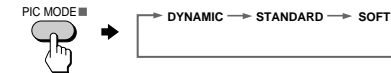

Select	To
DYNAMIC	receive high contrast pictures.
STANDARD	receive normal contrast pictures.
SOFT	receive mild pictures.

#### To select the sound mode

Press SOUND MODE repeatedly until you get the desired sound mode.

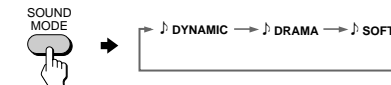

Select	To
DYNAMIC	listen to dynamic and clear sound that emphasizes the low and high sound.
DRAMA	listen to sound that emphasizes vocals and background music.
SOFT	receive soft sound.

Advanced Operations

## Adjusting the picture and sound settings

- 1 Press SELECT until the desired setting appears.



Each time you press SELECT, the setting item will change as follows:

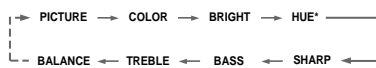

- 2 Press + or - to adjust the item.



- 3 To adjust other items, repeat steps 1 to 2.

\* "HUE" can be adjusted for the NTSC system only.

### Notes

- When you select a picture or sound mode, the adjusted settings will be reset according to the selected mode.
- You can also use SELECT and  $\Delta$  +/- on the TV to adjust the picture and sound settings.

## Selecting the surround mode

- 1 Press SELECT repeatedly until "SURROUND" appears.



- 2 Press + or - to select the desired surround sound.



Select	To
MOVIE	listen to sound that spreads out over a large area, giving the feeling of being at a movie theatre.
MUSIC	listen to the sound that gives the feeling of being at a live concert.
OFF	turn off the surround sound.

## Viewing your favorite channels

You can display six of your favorite channels for quick and easy selection. You can change the favorite channel setting as well.

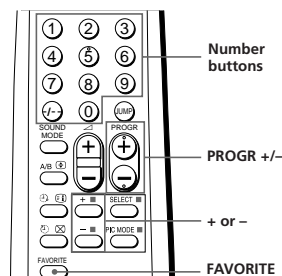

### Selecting a favorite channel

- 1 Press FAVORITE.

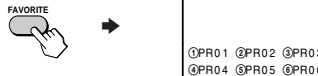

- 2 Press the number button from 1 to 6 to select the desired channel.

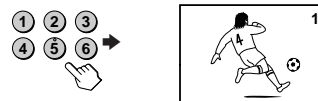

When you use the FAVORITE CH feature for the first time, six preset channels will appear.

### Changing the favorite channel setting

- 1 Press SELECT until "FAVORITE CH SET UP" appears.



- 2 Press + or - to select the favorite channel you want to change (e.g. ③ PR03).

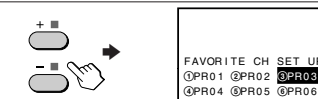

- 3 Press PROGR +/-, or number buttons to change the program number.

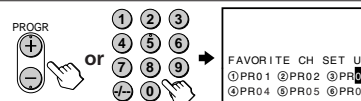

- 4 Repeat steps 2 and 3 to set other favorite channels.

- 5 Press SELECT.

## Blocking the channels (CHILD LOCK)

You can prevent a child from watching certain programs by using the buttons on the remote control.

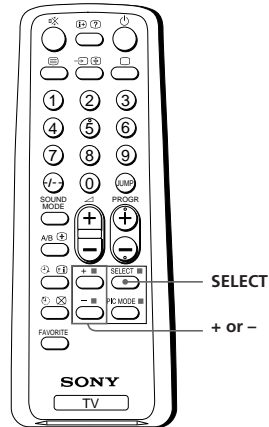

**1** Select the TV program you want to lock.

**2** Press SELECT until "CHILD LOCK" appears on the screen.

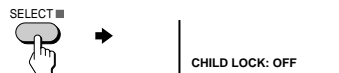

**3** Press + or - to select "ON".

The symbol appears on the screen.

To unlock the channel, press + or - to select "OFF". The symbol disappears from the screen.

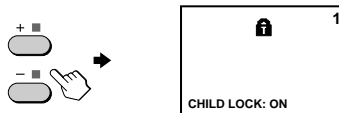

### Note

- If you preset a locked channel, that particular channel will be unlocked automatically.

## Selecting a stereo or bilingual program

(KV-XF51M65 only)

You can enjoy stereo sound or bilingual programs of NICAM and A2 (German) stereo systems.

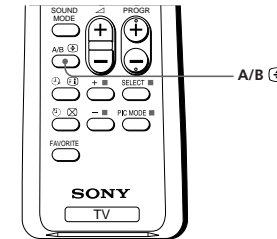

Press A/B repeatedly until you receive the sound you want.

The on-screen display changes to show the selected sound and the indicator on the TV lights up red.



### When receiving a NICAM program

Broadcasting	On-screen display (Selected sound)
NICAM stereo	
NICAM bilingual	
NICAM monaural	

### When receiving an A2 (German) program

Broadcasting	On-screen display (Selected sound)
A2 (German) stereo	<div style="border: 1px solid black; padding: 5px; display: inline-block;"> <div style="display: flex; justify-content: space-between; width: 100%;"> <span>MONO (Regular sound)</span> <span>STEREO (Stereo sound)</span> </div> </div>
A2 (German) bilingual	<div style="border: 1px solid black; padding: 5px; display: inline-block;"> <div style="display: flex; justify-content: space-between; width: 100%;"> <span>MAIN (Main sound)</span> <span>SUB (Sub sound)</span> </div> </div>

**Notes**

- If the signal is very weak, the sound becomes monaural automatically.
- If the stereo sound is noisy when receiving a NICAM program, select "MONO". The sound becomes monaural, but the noise is reduced.

### If the sound is distorted or noisy when receiving a monaural program through the (antenna) terminal

Press A/B repeatedly until "MONO" appears on the screen.  
 To cancel the monaural sound setting, press A/B again until "AUTO" appears on the screen.



**Notes**

- The "MONO" or "AUTO" setting is memorized for each program position.
- You cannot receive stereo broadcast signal when the TV is in the "MONO" setting. Normally set the TV to "AUTO."

## Viewing Teletext

(KV-XF51M65 only)

TV stations broadcast an information service called Teletext via some TV channels. Teletext allows you to receive various information, such as shares market or news.

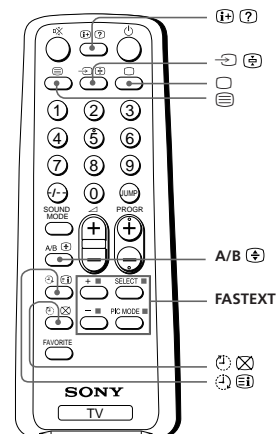

### Displaying Teletext

**1** Select a TV channel that carries the Teletext broadcast you want to watch.

**2** Press to display the text.

A Teletext page (normally the index page) is displayed. If there is no Teletext broadcast, "100" is displayed at the top left corner of the screen.

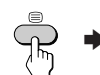

Additional Information

### To turn off Teletext

Press .

continued

## Viewing Teletext (continued)

### Additional Teletext tasks

To	Do this
display a Teletext page on the TV picture	Press . Each time you press , the screen changes as follows: Teletext → Teletext and TV → TV.
check the contents of a Teletext service	Press . An overview of the Teletext contents and page numbers appear on the screen.
select a Teletext page	Press the number buttons to enter the three-digit page number of the desired Teletext page.* If you make a mistake, reenter the correct page number. To access the next or previous page, press <b>PROGR +/-</b> .
hold a Teletext page (stop the page from scrolling)	Press  to display the symbol "Ⓜ" at the top left corner of the screen. To resume normal Teletext operation, press  or .
reveal concealed information (e.g., an answer to a quiz)	Press . To conceal the information, press the button again.
enlarge the Teletext display	Press <b>A/B</b> . Each time you press <b>A/B</b> , the Teletext display changes as follows: Enlarge upper half → Enlarge lower half → Normal size.
wait for a Teletext page while watching a TV program	1 Enter the Teletext page number that you want to refer to, then press . 2 When the page number is displayed, press  to show the text.

\* You can also select a Teletext page of any page number that appears in the colored column at the bottom of the screen using the corresponding color-coded button on the remote.

### Using FASTEXT

This feature allows you to quickly access a Teletext page that uses FASTEXT. When a FASTEXT program is broadcasted, the colored menus appear at the bottom of the screen. The colors of the menus correspond to the red, green, yellow, and blue color-coded buttons on the remote.

#### To access a FASTEXT menu

Press the color-coded button on the remote corresponding to the menu you want. The menu page appears on the screen after several seconds.

## Self-diagnosis function



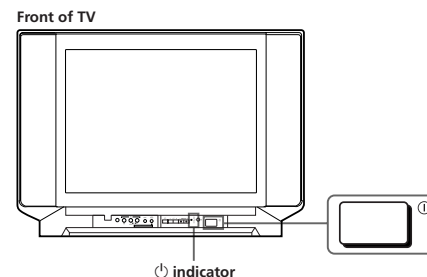





Your TV is equipped with a self-diagnosis function. If there is a problem with your TV, the indicator flashes red. The number of times the indicator flashes indicates the possible causes.

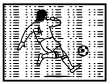







- 1 Check that the indicator flashes red a number of times between 3-second intervals.
- 2 Count the number of times the indicator flashes.
- 3 Press (main power) to turn off your TV.
- 4 Inform your nearest Sony service center about the number of times the indicator flashes.  
Be sure to note the model name and serial number located on the rear of your TV.

## Troubleshooting

If you find any problem while viewing your TV, please check the following guide. If any problem persists, contact your Sony dealer .

Symptom	Solutions	Possible cause
<b>Snowy picture</b> 	<ul style="list-style-type: none"> <li>Check the antenna cable and connection on the TV, VCR and on the wall. (page 4)</li> <li>Press SELECT until "MANUAL PROGRAM" appears on the screen then preset the channel again. (page 10)</li> </ul>	<ul style="list-style-type: none"> <li>Connection is loose or the cable is damaged.</li> <li>Channel presetting is inappropriate or incomplete.</li> </ul>
<b>Noisy sound</b> 	<ul style="list-style-type: none"> <li>Check the antenna type (VHF/UHF). Contact a Sony dealer for advice.</li> <li>Adjust the antenna direction. Contact a Sony dealer for advice.</li> <li>Try using a booster.</li> </ul>	<ul style="list-style-type: none"> <li>The antenna type is inappropriate.</li> <li>The antenna direction is inappropriate.</li> <li>Signal transmission is low.</li> </ul>
<b>Distorted picture</b> 	<ul style="list-style-type: none"> <li>Turn off or disconnect the booster if it is in use.</li> </ul>	<ul style="list-style-type: none"> <li>Broadcast signals are too strong.</li> </ul>
<b>Noisy sound</b> 		
<b>Good picture</b> 	<ul style="list-style-type: none"> <li>If the sound of all the channels are noisy, check the TV system (TV SYS) setting (page 10), then press AUTO PROGR to preset the channels again (page 9).</li> </ul>	<ul style="list-style-type: none"> <li>The TV system setting or channel presetting is inappropriate or incomplete.</li> </ul>
<b>Noisy sound</b> 	<ul style="list-style-type: none"> <li>If the sound of some channels are noisy, select the channel, then select the appropriate TV system (TV SYS). (page 10)</li> </ul>	
<b>No picture</b> 	<ul style="list-style-type: none"> <li>Check the power cord, antenna and the VCR connections.</li> <li>Press ⏻ (power).</li> <li>Press ⏻ (main power) on the TV to turn off the TV for about five seconds, then turn it on again.</li> </ul>	<ul style="list-style-type: none"> <li>The power cord, antenna or VCR is not connected.</li> <li>The TV is not turned on.</li> </ul>
<b>No sound</b> 		

Symptom	Solutions	Possible cause
<b>Good picture</b> 	<ul style="list-style-type: none"> <li>Press <math>\triangle</math> + to increase the volume level.</li> <li>Press <math>\times</math> to cancel the muting.</li> <li>Press A/B <math>\oplus</math> until a better sound is heard. (KV-XF51M65 only)</li> </ul>	<ul style="list-style-type: none"> <li>The volume level is too low.</li> <li>The sound is muted.</li> <li>Broadcast signal has a transmission problem.</li> </ul>
<b>No sound</b> 		
<b>Dotted lines or stripes</b> 	<ul style="list-style-type: none"> <li>Do not use a hair dryer or other equipment near the TV.</li> <li>Adjust the antenna direction for minimum interference. Contact a Sony dealer for advice.</li> </ul>	<ul style="list-style-type: none"> <li>There is local interference from cars, neon signs, hair dryers, power generators, etc.</li> </ul>
<b>Double images or "ghosts"</b> 	<ul style="list-style-type: none"> <li>Use a highly directional antenna.</li> <li>Use the fine tuning (FINE) function. (page 11)</li> <li>Adjust the antenna direction. Contact a Sony dealer for advice.</li> <li>Turn off or disconnect the booster if it is in use.</li> </ul>	<ul style="list-style-type: none"> <li>Broadcast signals are reflected by nearby mountains or buildings.</li> <li>The antenna direction is inappropriate.</li> <li>Use of a booster is inappropriate.</li> </ul>
<b>No color</b> 	<ul style="list-style-type: none"> <li>Press SELECT until "COLOR" appears on the screen, then press + or - to adjust the color level. (page 16)</li> <li>Press SELECT until "COL SYS " appears on the screen, then check the color system setting (usually set this to "AUTO"). (page 11).</li> <li>Adjust the antenna direction. Contact a Sony dealer for advice.</li> </ul>	<ul style="list-style-type: none"> <li>The color level setting is too low.</li> <li>The color system setting is inappropriate.</li> <li>The antenna direction is inappropriate.</li> </ul>
<b>Abnormal color patches</b> 	<ul style="list-style-type: none"> <li>Keep external speakers or other electrical equipment away from the TV. Do not move the TV while the TV is turned on. Press ⏻ (main power) on the TV to turn off the TV for about five minutes, then turn it on again.</li> </ul>	<ul style="list-style-type: none"> <li>The magnetic disturbance from external speakers or other equipment, or the direction of the earth's magnetic field may affect the TV.</li> </ul>
<b>TV cannot receive stereo broadcast signal (KV-XF51M65 only)</b>	<ul style="list-style-type: none"> <li>Press A/B <math>\oplus</math> until "AUTO" appears on the screen</li> </ul>	<ul style="list-style-type: none"> <li>The stereo reception setting is inappropriate.</li> </ul>

continued



Symptom	Solutions	Possible cause
<p>Stereo broadcast sound switches on and off or is distorted.</p> <p><b>OR</b></p> <p>The sound switches between monaural and stereo frequently. (KV-XF51M65 only)</p>	<ul style="list-style-type: none"> <li>Check the antenna cable and connection on the TV, VCR and on the wall. (page 4)</li> <li>Adjust the antenna direction. Contact a Sony dealer for advice.</li> <li>Press A/B (⏪) until a better sound is heard.</li> </ul>	<ul style="list-style-type: none"> <li>Connection is loose or the cable is damaged.</li> <li>The antenna direction is inappropriate.</li> <li>Broadcast signal has a transmission problem.</li> </ul>
<p>"100" appears on the top of the screen and there is no Teletext display. (KV-XF51M65 only)</p>	—	<ul style="list-style-type: none"> <li>The channel carries no Teletext broadcast.</li> </ul>
<p>Teletext display is incomplete (snowy picture or double images). (KV-XF51M65 only)</p>	<ul style="list-style-type: none"> <li>Check the antenna cable and connection on the TV, VCR, and at the wall. (page 4)</li> <li>Adjust the antenna direction. Contact a Sony dealer for advice.</li> <li>Try using a booster.</li> <li>Use the fine tuning (FINE) function. (page 11)</li> </ul>	<ul style="list-style-type: none"> <li>Connection is loose or the cable is damaged.</li> <li>The antenna direction is inappropriate.</li> <li>Signal transmission is too low.</li> </ul>
<p>Picture slant</p> 	<ul style="list-style-type: none"> <li>Press SELECT until "PIC ROTATION" appears on the screen, then press + or - to align the picture to the TV screen. (page 13)</li> </ul>	<ul style="list-style-type: none"> <li>The terrestrial magnetism affects your TV set.</li> </ul>
<p>Lines moving across the TV screen.</p>	<ul style="list-style-type: none"> <li>Use the fine tuning (FINE) function. (page 11)</li> </ul>	<ul style="list-style-type: none"> <li>There is interference from external sources, e.g., heavy machineries, nearby broadcast station.</li> </ul>
<p>The ⏻ indicator on your TV flashes red a number of times between 3-second intervals.</p>	<ul style="list-style-type: none"> <li>Contact your nearest Sony service center. (page 23)</li> </ul>	<ul style="list-style-type: none"> <li>Your TV may need service.</li> </ul>
<p>TV cabinet creaks.</p>	—	<ul style="list-style-type: none"> <li>Changes in room temperature sometimes make the TV cabinet expand or contract, making a noise. This does not indicate a malfunction.</li> </ul>
<p>A "boom" sound is heard when the TV is turned on.</p>	—	<ul style="list-style-type: none"> <li>The TV's demagnetizing function is working. This does not indicate a malfunction.</li> </ul>

## Identifying parts and controls

Refer to the pages indicated in parentheses ( ) for details.

### Front panel

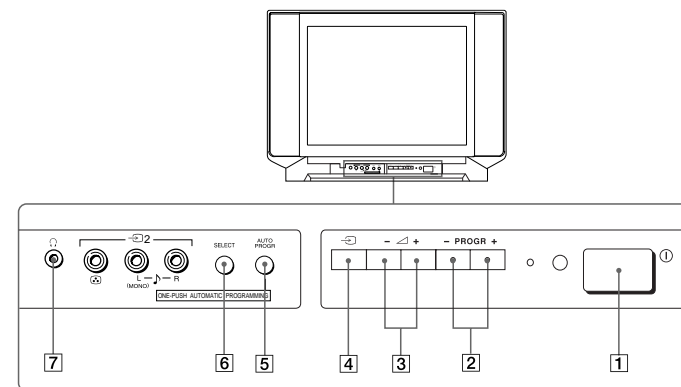

- 1 ① (main power) button (12)
- 2 PROGR +/- (program) buttons (12)
- 3 +/- (volume) buttons (12)
- 4 (TV/video) button (13)
- 5 AUTO PROGR (program) button (5)
- 6 SELECT button (10)
- 7 (headphone) jack

## Remote Control

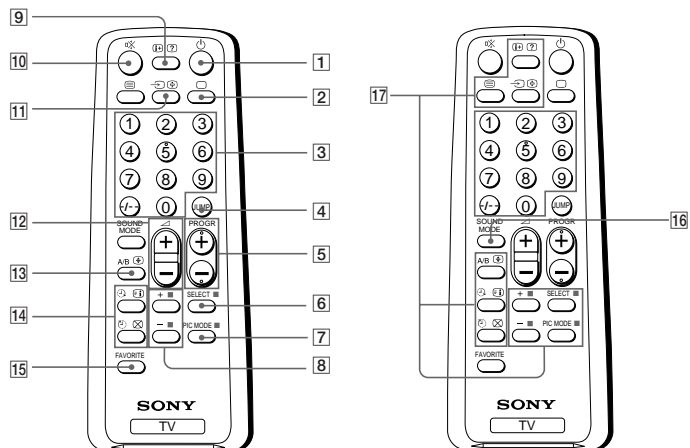

- 1 ⏻ (power) button (12)
- 2 □ (TV) button (13)
- 3 Number buttons (12)
- 4 JUMP button (13)
- 5 PROGR +/- buttons (12)
- 6 SELECT button (10)
- 7 PIC MODE button (15)
- 8 +/- buttons (10)
- 9 Ⓜ (display) button (13)
- 10 ✖ (muting) button (13)
- 11 📺 (video) button (13)
- 12 ⏮ +/- (volume) buttons (12)
- 13 A/B button  
(KV-XF51M65 only)
- 14 Timer setting buttons (14)  
⌚ (wake up timer)  
⌚ (sleep timer)
- 15 FAVORITE button (17)

- 16 SOUND MODE button (15)
- 17 Teletext operation buttons  
(KV-XF51M65 only)  
 ☰ (text)    ⏏ (enlarge)  
 ? (reveal)    ⏏ (hold)  
 Ⓜ (index)    ✖ (text clear)  
 ■ (FASTEXT: red, green, yellow, blue)

Names/symbols of buttons on the remote are indicated in different colors to represent the available functions.

Label color	Button function
White	For general TV operations
Green	For Teletext operations

## SECTION 2 DISASSEMBLY

### 2-1. 3D SPEAKER BOX REMOVAL (KV-XF21M83/XF51M65 only)

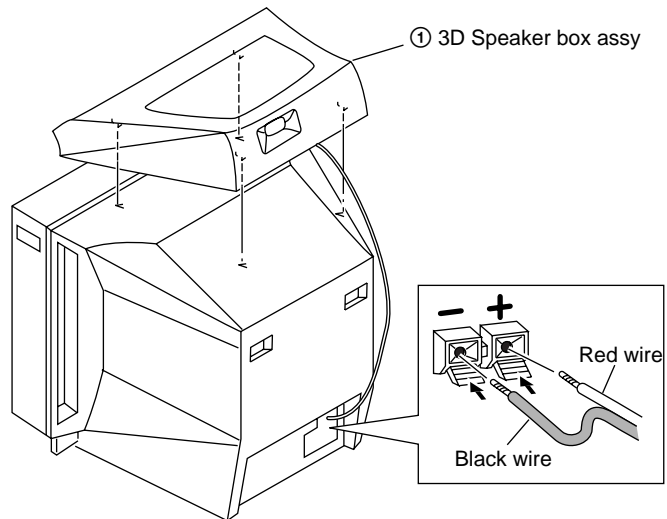

### 2-3. CHASSIS ASSY REMOVAL

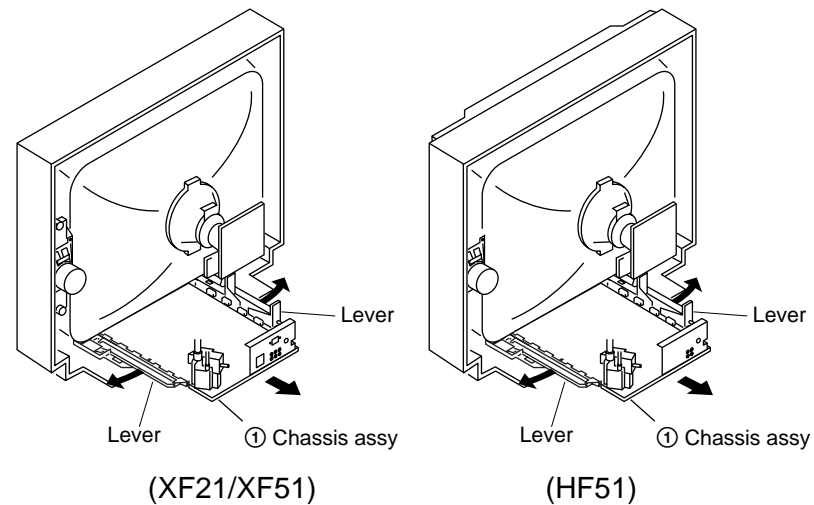

### 2-2. REAR COVER REMOVAL

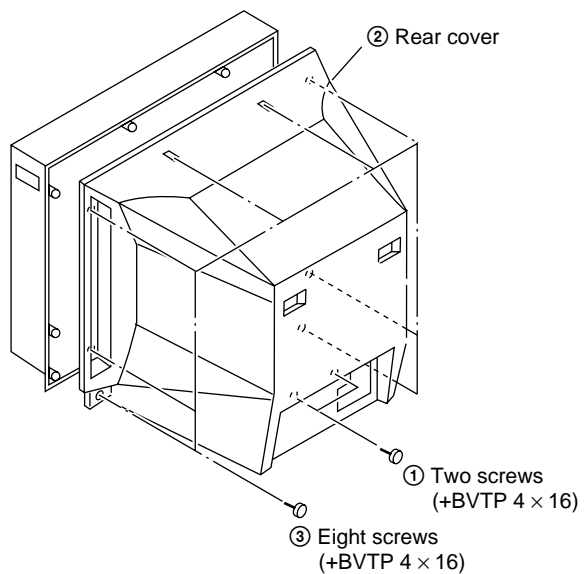

### 2-4. F BRACKET REMOVAL

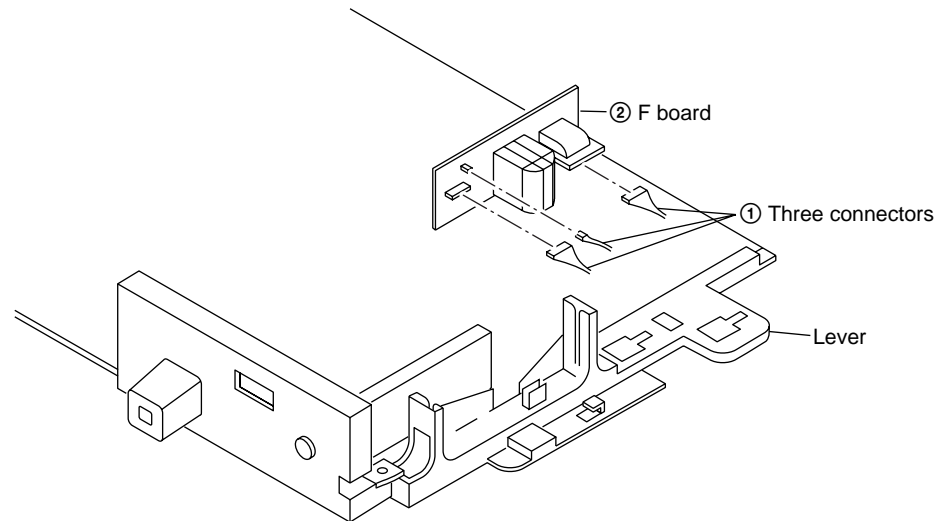

## 2-5. SERVICE POSITION

(Note: Remove F Bracket first.)

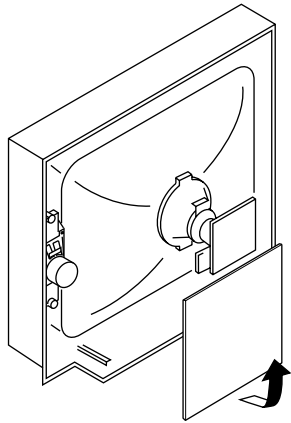

(XF21/XF51)

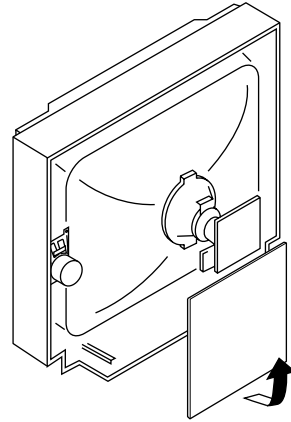

(HF51)

For replacement of the Multi Button (HF51), unscrew it to exchange with the new part, and fix it with screws (+BVTP).

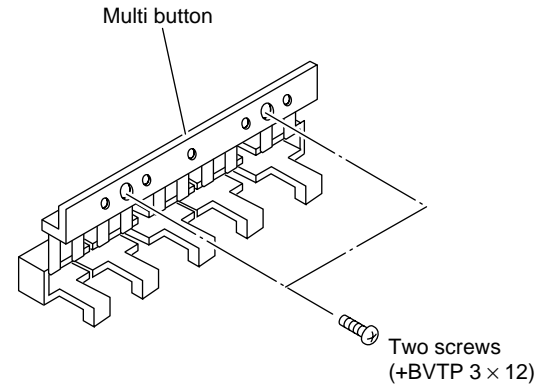

(HF51)

## 2-6. REPLACEMENT OF PARTS

### 2-6-1. REPLACEMENT OF MULTI BUTTON

For replacement of the Multi Button (XF21/XF51), cut the welded portions from it, exchange with the new part, and fix it with screws (+BVTP).

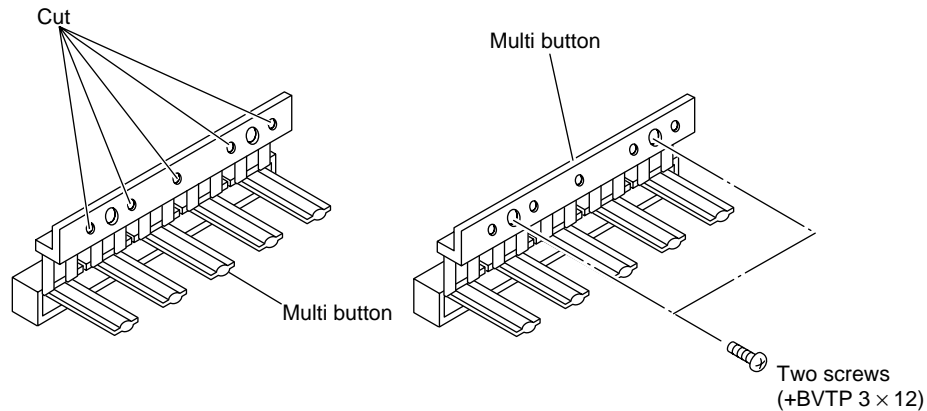

(XF21/XF51)

### 2-6-2. REPLACEMENT OF LIGHT GUIDE

For replacement of the Light Guide (XF21/XF51), cut the welded portions from it, exchange with the new part, and fix it with screw (+BVTP).

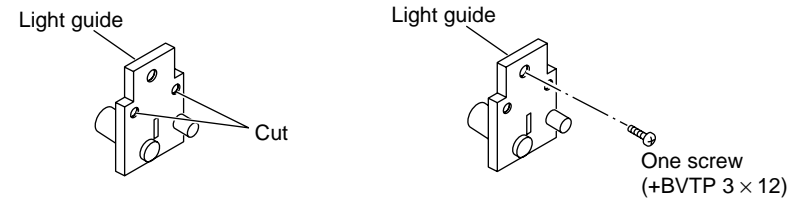

(XF21/XF51)

For replacement of the Light Guide (HF51), pull it out to exchange with the new part.

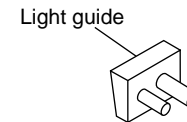

(HF51)

### 2-7. H4 AND K1 BOARD REMOVAL (KV-XF21M83/XF51M65 only)

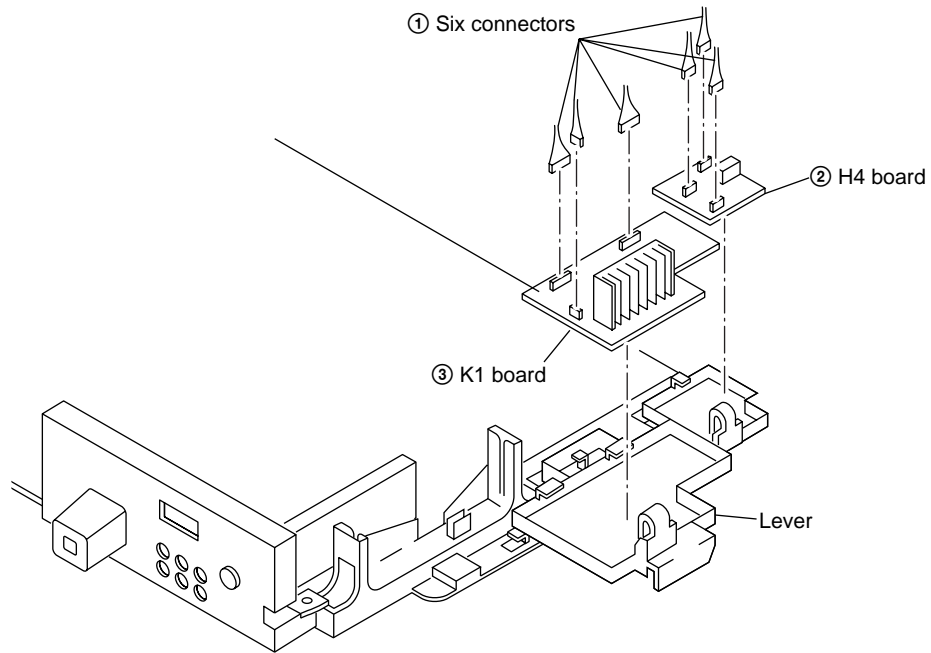

### 2-9. TERMINAL BRACKET REMOVAL

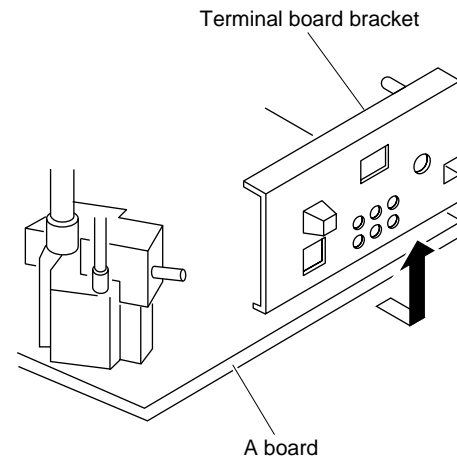

(XF21/XF51)

### 2-8. V1 BOARD REMOVAL (KV-XF51M65 only)

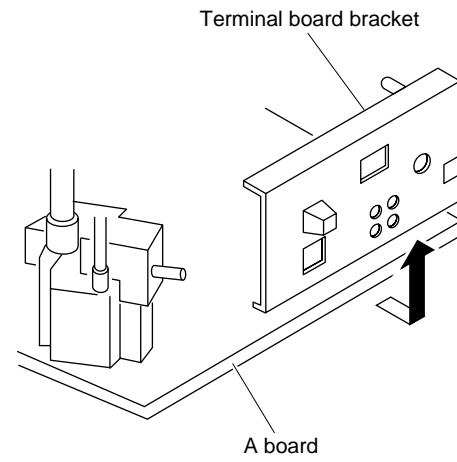
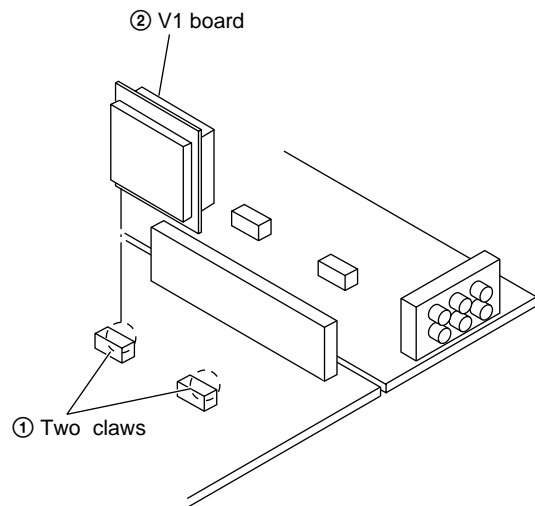

(HF51)

## 2-10. DEGAUSS COIL REMOVAL

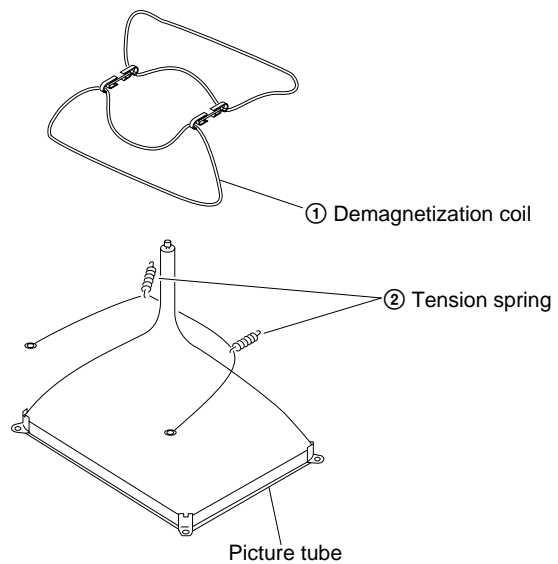

## 2-11. PICTURE TUBE REMOVAL

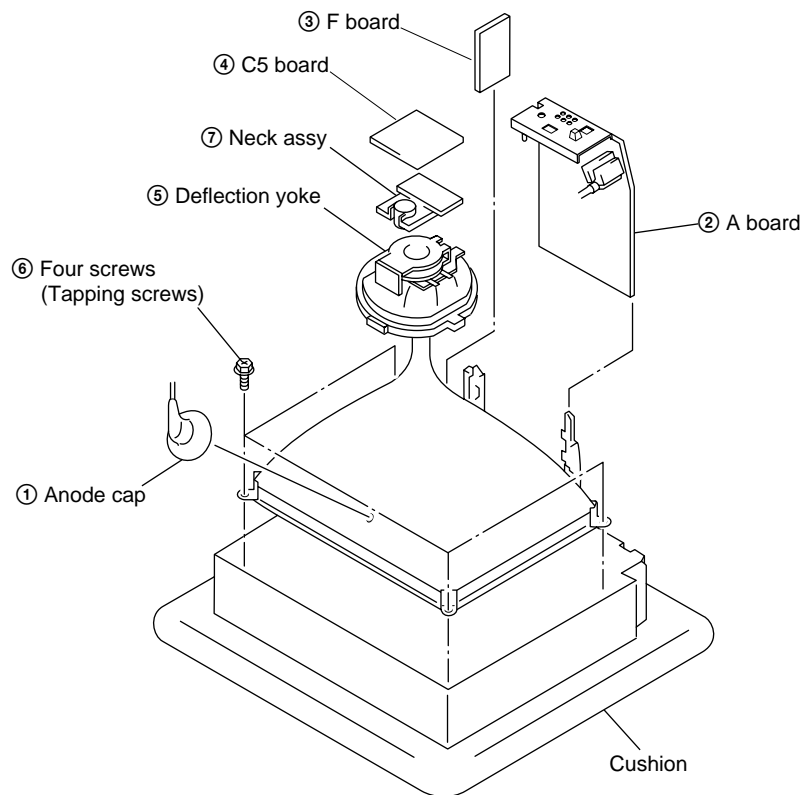

• **REMOVAL OF ANODE-CAP**

NOTE : After removing the anode, short circuit the anode of the picture tube and the anode cap to the metal chassis, CRT shield or carbon paint on the CRT.

• **REMOVING PROCEDURES**

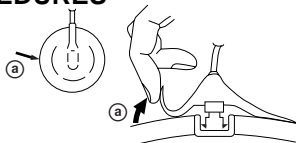

① Turn up one side of the rubber cap in the direction indicated by the arrow ①.

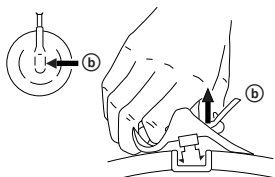

② Using a thumb pull up the rubber cap firmly in the direction indicated by the arrow ②.

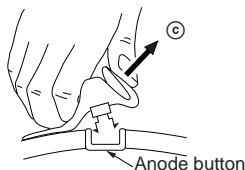

③ When one side of the rubber cap is separated from the anode button, the anode-cap can be removed by turning up the rubber cap and pulling it up in the direction of the arrow ③.

• **HOW TO HANDLE AN ANODE-CAP**

- ① Do not damage the surface of anode-caps with sharp shaped objects.
- ② Do not press the rubber too hard so as not to damage the inside of anode-cap. A metal fitting called the shatter-hook terminal is built into the rubber.
- ③ Do not turn the foot of rubber over too hard. The shatter-hook terminal will stick out or damage the rubber.

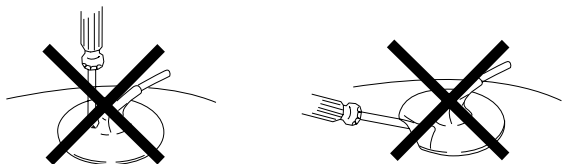

## SECTION 3

### SET-UP ADJUSTMENTS

- The following adjustments should be made when a complete realignment is required or a new picture tube is installed.
- These adjustments should be performed with rated power supply voltage unless otherwise noted.

Controls and switches should be set as follows unless otherwise noted:

PICTURE control ..... normal

BRIGHTNESS control ..... normal

Perform the adjustments in the following order :

1. Beam Landing
2. Convergence
3. Focus
4. White Balance

**Note :** Test Equipment Required.

1. Color-bar/Pattern Generator
2. Degausser
3. Oscilloscope

#### Preparation :

- In order to reduce the influence of geomagnetism on the set's picture tube, face it east or west.
- Switch on the set's power and degauss with the degausser.

#### 3-1. BEAM LANDING

1. Input a white signal with the pattern generator.

Contrast } normal  
Brightness }

2. Position neck assy as shown in Fig3-2.
3. Set the pattern generator raster signal to a green raster.
4. Move the deflection yoke to the rear and adjust with the purity control so that the green is at the center and the blue and the red take up equally sized areas on each side.  
(See Figures 3-1 through 3-3.)
5. Move the deflection yoke forward and adjust so that the entire screen is green. (See Figure 3-1.)
6. Switch the raster signal to blue, then to red and verify the condition.
7. When the position of the deflection yoke has been decided, fasten the deflection yoke with the screws and DY spacers.
8. If the beam does not land correctly in all the corners, use a magnet to adjust it.  
(See Figure 3-4.)

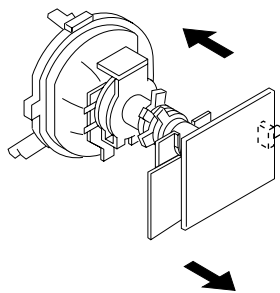
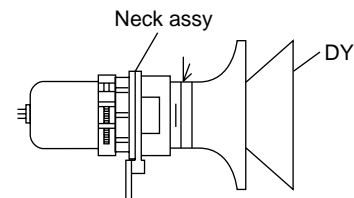

Fig. 3-1



Note:

Neck Assy is exactly behind DY (no gap between Neck Assy and DY)

Fig. 3-2

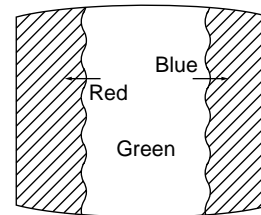

Fig. 3-3

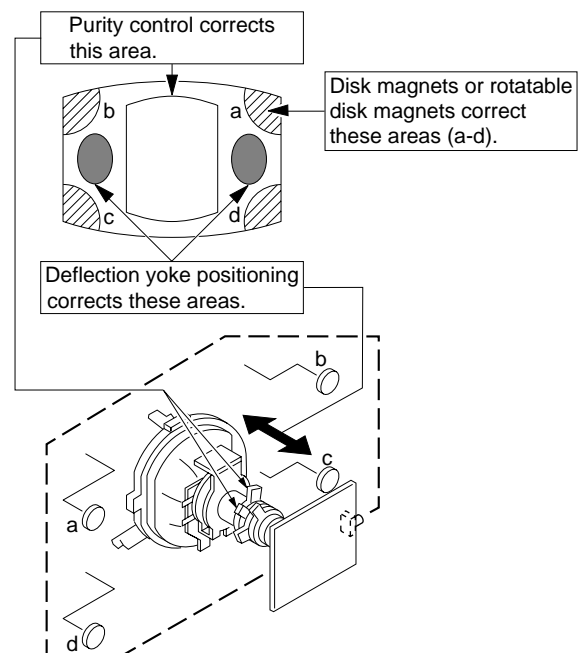

Fig. 3-4



### 3-2. CONVERGENCE

#### Preparation :

- Before starting this adjustment, adjust the focus, horizontal size and vertical size.
- Minimize the brightness setting.
- Provide dot pattern.

#### (1) Horizontal and Vertical Static Convergence

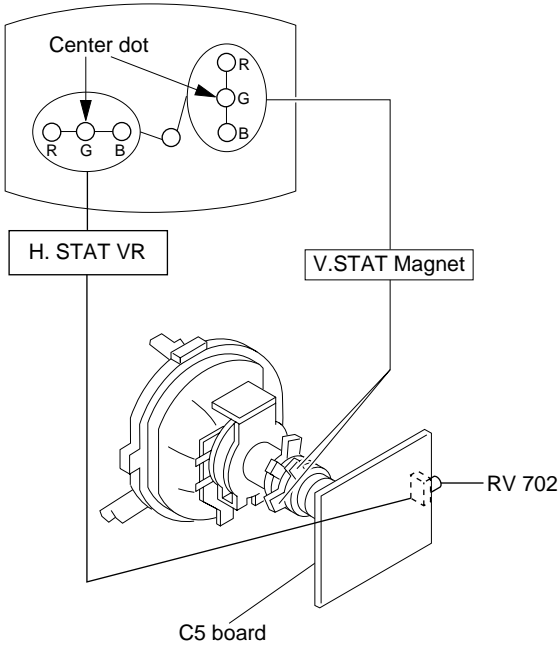

(Moving vertically), adjust the V.STAT magnet so that the red, green and blue dots are on top of each other at the center of the screen.

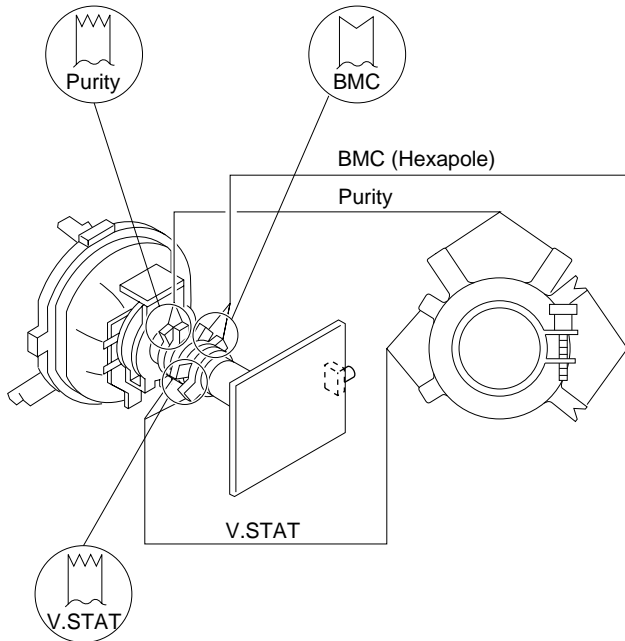

#### ① V. STAT

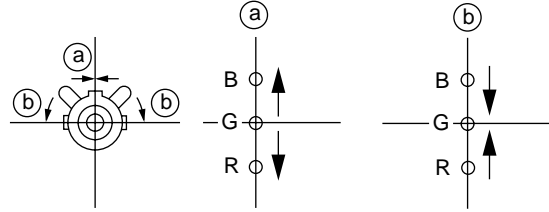

#### ② H. STAT VR

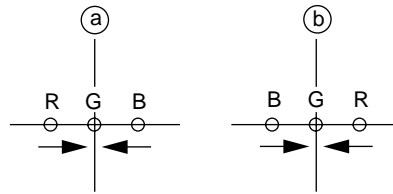

#### ③

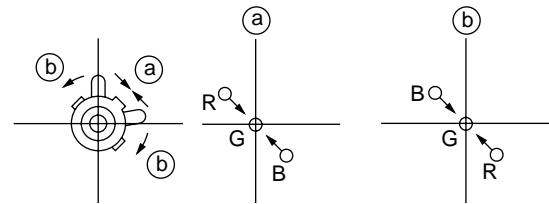

#### ④ BMC (Hexapole) Magnet.

If the red, green and blue dots are not balanced or aligned, then use the BMC magnet to adjust in the manner described below.

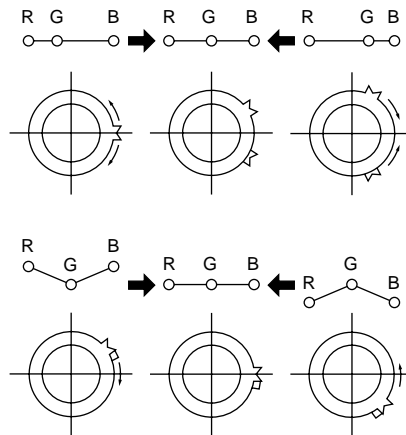

④ Y separation axis correction magnet adjustment.

1. Receive the cross-hatch signal and adjust [PICTURE] to [MIN] and [BRIGHTNESS] to [STANDARD] .
2. Adjust the Y separation axis correction magnet on the neck assembly so that the horizontal lines at the top and bottom of the screen are straight.

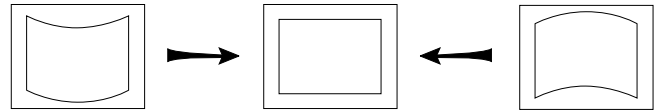
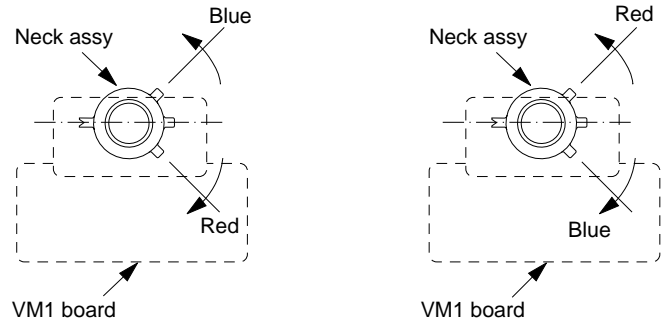

**Note**

1. The Red and Blue magnets should be equally far from the horizontal center line.
2. Do not separate the Red and Blue magnets too far. (Less than 8 mm)

**(2) Dynamic Convergence Adjustment**

**Preparation:**

- Before starting this adjustment, adjust the horizontal static convergence and the vertical static convergence

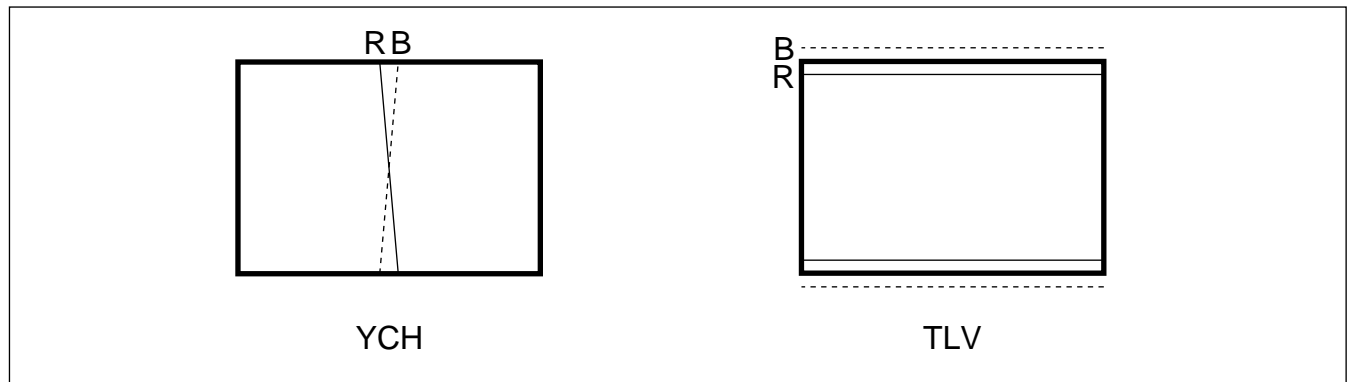

on DY

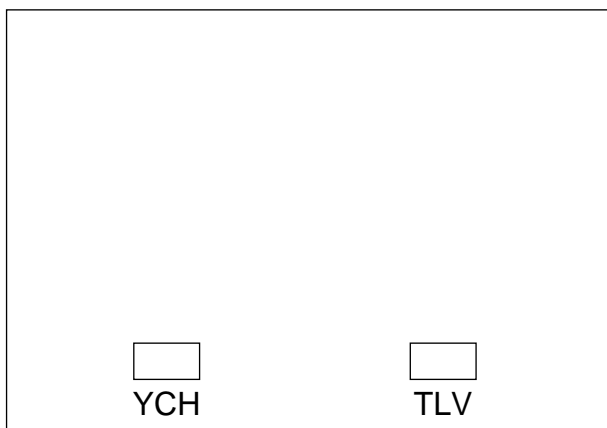

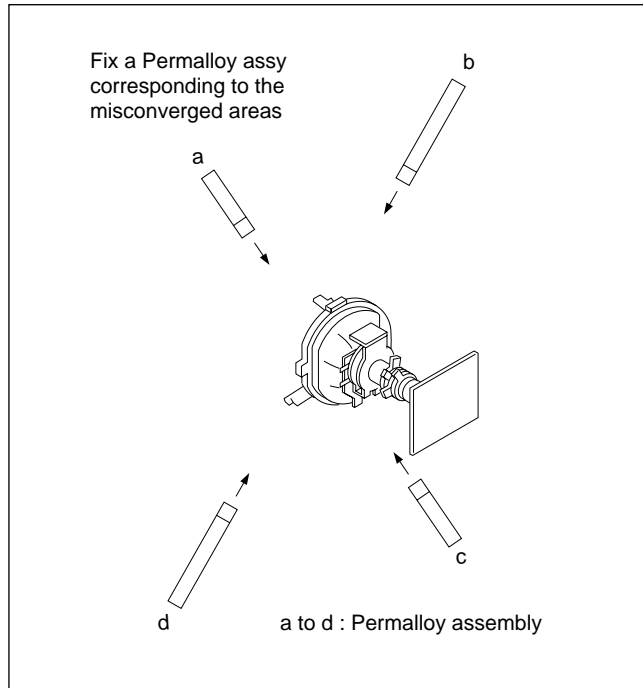
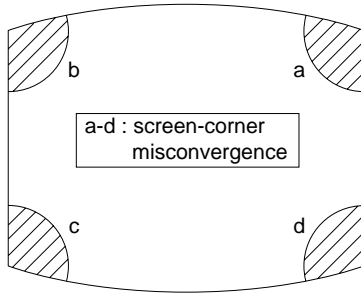
**(3) Screen-corner Convergence****3-3. FOCUS ADJUSTMENT**

Adjust FOCUS control on the flyback transformer for the best focus.

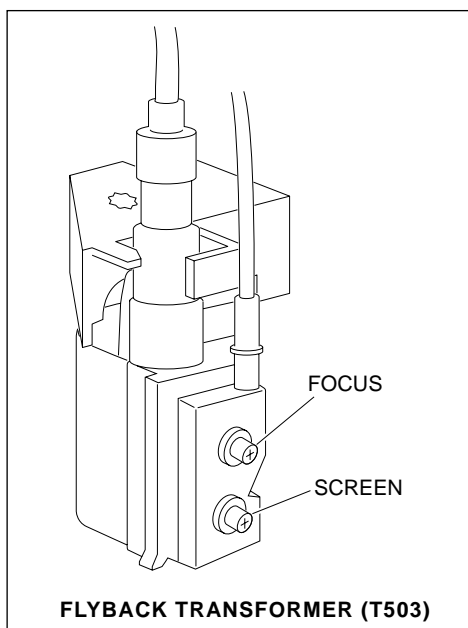
**3-4. G2 (SCREEN) AND WHITE BALANCE****ADJUSTMENTS****1. G2 (SCREEN) ADJUSTMENT**

- 1) Set the PICTURE to normal.
- 2) Put to VIDEO input mode without signals.
- 3) Connect R, G and B of the C5 board cathode to the oscilloscope.
- 4) Adjust BRIGHTNESS to obtain the cathode voltage to the value below.
- 5) Adjust G2 (Screen) on FBT until picture shows the point before cut-off.

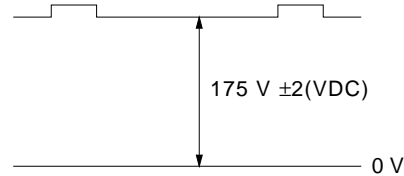
**2. WHITE BALANCE ADJUSTMENT**

- 1) Set to Service Mode (Refer Section 4-1: ADJUSTMENTS WITH COMMANDER).
- 2) Input white raster signal.
- 3) Set the PICTURE to minimum.
- 4) Select GCT (WHB 4) and BCT (WHB 5) with [1] and [4], and adjust the level with [3] and [6] for the best white balance.
- 5) Set the PICTURE to maximum.
- 6) Select GDR (WHB 1) and BDR (WHB 2) with [1] and [4], and adjust the level with [3] and [6] for the best white balance.
- 7) Write into the memory by pressing [MUTING] then [0].

**3. SUB BRIGHT ADJUSTMENT**

- 1) Set to service mode.
- 2) Input a staircase signal of black to white from the pattern generator.
- 3) BRIGHTNESS .....50%.  
PICTURE .....MINIMUM
- 4) Select SBR (WHB7) with [1] and [4], and adjust SBR (WHB7) level with [3] and [6] so that the second stripe from the right is dimly lit.

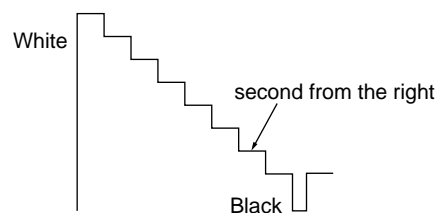

## SECTION 4

### CIRCUIT ADJUSTMENTS

#### 4-1. ADJUSTMENTS WITH COMMANDER

Service adjustments are made with the RM-952 for XF21/XF51 and RM-915 for HF51 that comes with this unit.

##### a. ENTERING SERVICE MODE

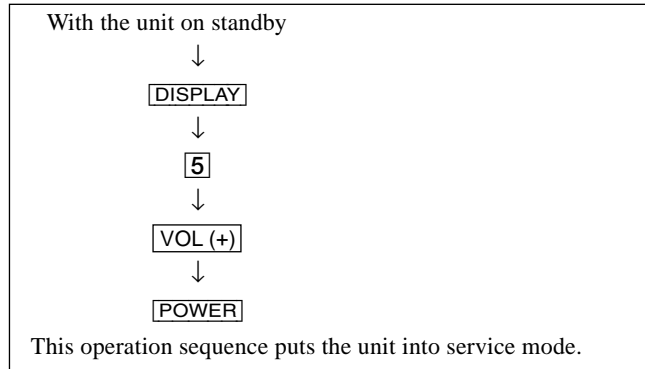

##### b. METHOD OF CANCELLATION FROM SERVICE MODE

Set the standby condition (Press **POWER** button on the commander), then press **POWER** button again, hereupon it becomes TV mode.

##### c. METHOD OF WRITE INTO MEMORY

- 1) Set to Service Mode.
- 2) Press **1** (UP) and **4** (DOWN), select an item of adjustment.
- 3) Press **MUTING** button and it will indicate WRITE on the screen.
- 4) Press **0** button to write into memory.

##### d. MEMORY WRITE CONFIRMATION METHOD

- 1) After adjustment, pull out the plug from AC outlet, and then plug into AC outlet again.
- 2) Turn the power switch ON and set to Service Mode.
- 3) Call the adjusted items again to confirm adjustments were made.

The screen display is :

Device Name    Item Name    Marking of virgin NVM

Device Name	Item No	Item Name	Data	Marking of virgin NVM	Mode
GEO	00	HPS	1C	■	SERVICE 50
601S	1.0C	59	7F	0	000A
Suffix No (OEM Code)	Software version			Total Power-On time (hours)	

PAL, SECAM : 50

NTSC : 60

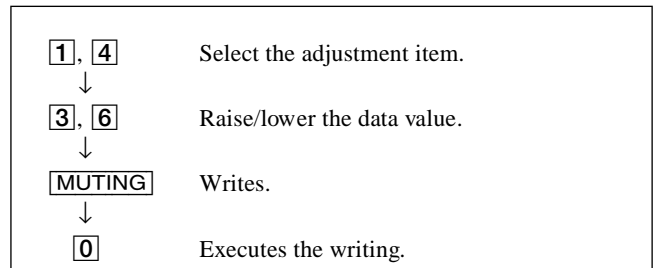

**7, 0**

All the data becomes the values in memory.

**8, 0**

All user control goes to the standard state.

**5, 0**

Service data initialization (Be sure not to use usually.)

**2, 0**

Write 50Hz adjustment data to 60Hz, or vice versa.

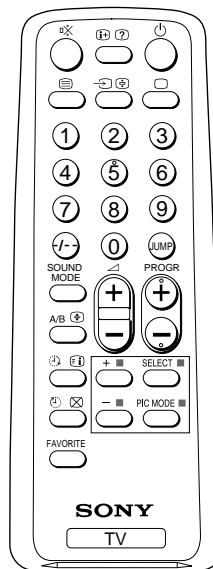

RM-952

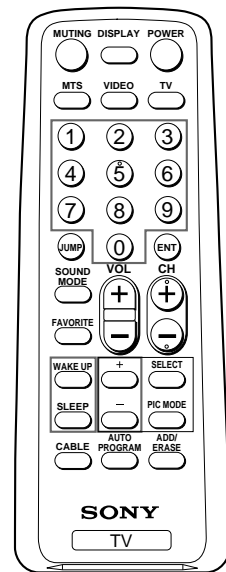

RM-915

## 4-2. ADJUSTMENT METHOD

Item Number 00 of device GEO

This explanation uses H-Position as an example.

1. Select "GEO 00 HPS" with the **[1]** and **[4]** buttons.
2. Raise/lower the data with the **[3]** and **[6]** buttons.
3. Select the optimum state. (The standard is 1F for PAL reception.)
4. Write with the **[MUTING]** button. (The display changes to WRITE.)
5. Execute the writing with the **[0]** button. (The WRITE display will be changed to red color while excuting, and back to SERVICE.)

Use the same method for all Items. Use **[1]** and **[4]** to select the adjustment item, use **[3]** and **[6]** to adjust, write with **[MUTING]**, then execute the write with **[0]**.

**Note** : 1. In **[WRITE]**, the data for all items are written into memory together.

2. For adjustment items that have different standard data between 50Hz or 60Hz, be sure to use the respective input signal after adjustment.

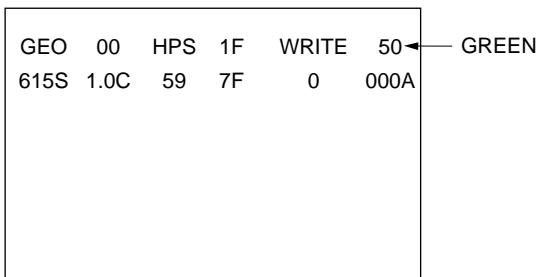
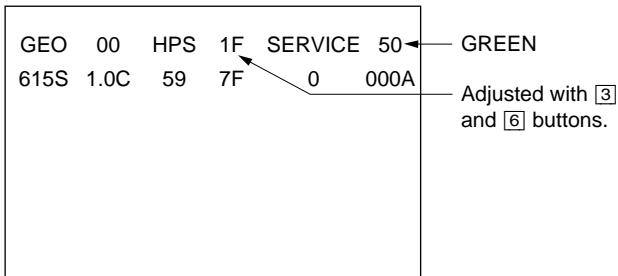

Written with **[MUTING]**

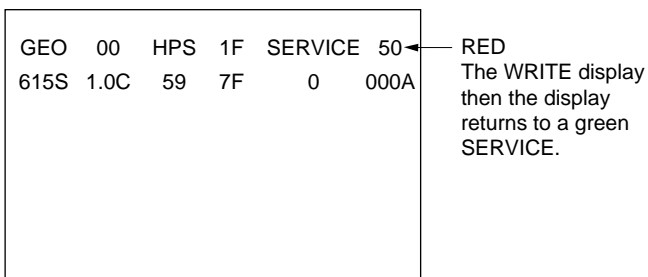

Write executed with **[0]**

**Adjustment Item Table (Except KV-XF21N90)**

Device Name	Functionality		Note	Data Range	Function	Note for Different Data	Register No. (bit)	Slava Address	RAM Address (bit)
	No	Name							
GEO	0	HPS	7	3F	H Position	50/60HZ	12 (7-2)	CXA2130S(88H)	82 (7-2)
	1	HSZ	1F	3F	H Size	50/60HZ	11 (7-2)		81 (7-2)
	2	PAP	1F	3F	Pin Amp	50/60HZ	13 (7-2)		83 (7-2)
	3	TLT	7	0F	Trapezium	50/60HZ	15 (7-4)		85 (7-4)
	4	VPS	1F	3F	V Position	50/60HZ	0F (7-2)		7F (7-2)
	5	VSZ	1F	3F	V Size	50/60HZ	0E (7-2)		7E (7-2)
	6	SCO	7	0F	S Correction	50/60HZ	10 (7-4)		80 (7-4)
	7	VLN	7	0F	V Linearity	50/60HZ	10 (3-0)		80 (3-0)
	8	BOW	7	0F	AFC Bow	50/60HZ	16 (7-4)		86 (7-4)
	9	AGL	7	0F	AFC-Angle	50/60HZ	16 (3-0)		86 (3-0)
	10	UPN	1F	3F	Upper Pin	50/60HZ	14 (7-2)		84 (7-2)
	11	LPN	1F	3F	Lower Pin	50/60HZ	18 (7-2)		88 (7-2)
	12	HBL	0	1	H Blanking on/off		18 (1)		67 (1)
	13	LBL	7	0F	Left H Blanking	50/60HZ	17 (7-4)		87 (7-4)
14	RBL	7	0F	Right H Blanking	50/60HZ	17 (3-0)	87 (3-0)		
WHB	0	RDR	2A	3F	R Drive	DYNAMIC/others	09 (7-2)	CXA2130S(88H)	8F (7-2)
	1	GDR	2A	3F	G Drive	DYNAMIC/others	0A (7-2)		90 (7-2)
	2	BDR	2A	3F	B Drive	DYNAMIC/others	0B (7-2)		91 (7-2)
	3	RCT	7	0F	R Cutoff	SECAM/others	07 (3-0)		93 (3-0)
	4	GCT	7	0F	G Cutoff	SECAM/others	08 (7-4)		94 (7-4)
	5	BCT	7	0F	B Cutoff	SECAM/others	08 (3-0)		94 (3-0)
	6	BMN	15	1F	Brightness Minimum Data				97
7	SBR	28	3F	Sub Brightness Control			98		
SAJ	0	PMX	33	3F	Picture Maximum Data			CXA2130S(88H)	96
	1	SHU	8	0F	Sub Hue Control	TV/Video			99
	2	SSH	3	0F	Sub Sharpness Control	TV/Video			9A
	3	SCL	1F	3F	Sub Color Control	NTSC/others			9B
VP	0	EHT	4	0F	EHT Comp	50/60HZ	15 (3-0)	CXA2130S(88H)	85 (3-0)
	1	GMA	2	03	Gamma Correction	Refer NVM Map A4	0B (1-0)		1A3 (1-0)
	2	YDL	6	0F	Y Delay	PAL/SECAM/NTSC	0C (3-0)		8C (3-0)
	3	SST	1	03	SECAM ID Start Position		1B (1-0)		6A (1-0)
	4	SSP	1	03	SECAM ID Stop Position		1B (3-2)		6A (3-2)
	5	SLV	2	03	SECAM ID Level		1C (1-0)		6B (1-0)
	6	SBF	22	3F	SECAM BELL f0		1C (7-2)		6B (7-2)
	7	DYC	0	1	Dynamic Color on/off		0A (1)		59 (1)
	8	ABL	1	1	ABL Mode Switching (STANDARD ALWAYS 0)		09 (1)		58 (1)
	9	VTH	1	1	ABL Detection Vth Switching		09 (0)		58 (0)
	10	SFO	1	1	FO Switching for Sharpness	NTSC/others	05 (1)		198 (1)
	11	DCX	1	1	DC Trans. Ratio Switching		06 (1)		55 (1)
12	SHT	1	1	Pre-/Overshoot ratio Switch	NTSC/others	06 (0)	199 (0)		

Adjustment Item Table

Device Name	Functionality		Note	Data Range	Function	Note for Different Data	Register No. (bit)	Slava Address	RAM Address (bit)
	No	Name							
VP	13	HDW	0	1	H Drive Pulse Width Switch	TV/Video/Text	00 (6)	TDA7429	4F (6)
	14	AFC	1	03	AFC Gain Control		0F (1-0)		8D (1-0)
	15	HOS	7	0F	H Oscillation		0C (7-4)		5B (7-4)
	16	HSS	0	1	Slice Level of H Sync Sep.		0D (1)		5C (1)
	17	VSS	0	1	Slice Level of V Sync Sep.	0D (0)	5C (0)		
	18	HMS	0	1	Macro Vision C/m off/on	50/60Hz 0E (0)	7E (0)		
	19	YUV	0	1	YUV Switch Control	01 (0)	50 (0)		
	20	CDV	2	3	CD mode for Video	Video only 0D (5-4)	1A1 (5-4)		
	21	RON	1	1	R ON	not memorized 01 (3)	50 (3)		
	22	GON	1	1	G ON	not memorized 01 (2)	50 (2)		
	23	BON	1	1	B ON	not memorized 01 (1)	50 (1)		
	24	PON	1	1	P ON	not memorized 00 (7)	4F (7)		
	25	BLK	0	1	BLK Off	12 (0)	61 (0)		
	26	VMC	0	1	VM Off	13 (0)	62 (0)		
AP	0	INF	0	3F	Input Attenuation When surround off		00 (5-0)		19F (5-0)
	1	INS	0	3F	Input Attenuation When surround on				1A0 (5-0)
	2	PH1	0	3	Phase 1 Register Selection		02		76 (1-0)
	3	PH2	0	3	Phase 2 Register Selection				76 (3-2)
	4	PH3	0	3	Phase 3 Register Selection				76 (5-4)
	5	PH4	0	3	Phase 4 Register Selection				76 (7-6)
	6	BCS	2	3	Bass Center Shift		#4 (3-0)		1A8 (1-0)
	7	TCS	2	3	Treble Center Shift		#5 (3-0)		1A9 (1-0)
8	TRF	2	3	RF Treble Offset		#5 (3-0)		1A9 (5-4)	
MSP	0	WST	15	FF	W/G Stereo Threshold			MSP3415D(84H)	157 (7-0)
	1	WBT	EA	FF	W/G Bilingual Threshold				158 (7-0)
	2	WLL	5	FF	W/G Monaural Threshold				159 (7-0)
	3	WAC	0	0F	W/G Agreement Count				15A (3-0)
	4	WDL	30	FF	W/G Search Delay				15B (7-0)
	5	NDL	20	FF	NICAM Search Delay				15C (7-0)
	6	SDL	10	FF	Stereo status Read Delay				15D (7-0)
	7	AGC	0	1	AGC Switch Auto/Constant		BB (7)		108 (7)
	8	REL	0D	3F	AGC Gain at Constant Mode		BB (6-1)		108 (6-1)
	9	CRM	0	1	Carrier muting on/off		BB (9)		107 (1)
	10	ACO	1	1	Audio Clock out on/off		83 (5)		10C (5)
	11	FP	1B	7F	FM Prescale for non-M system		0E (7-0)		16C (6-0)
	12	FPM	32	7F	FM Prescale for M system		0E (7-0)		16D (6-0)
	13	FH	36	7F	FM Prescale for HDEV		0E (7-0)		16E (6-0)
	14	FHM	65	7F	FM Prescale for HDEV and M		0E (7-0)		16F (6-0)
	15	WGP	2A	7F	W/G Prescale		0E (7-0)		170 (6-0)
	16	NIP	6D	7F	NICAM Prescale		10 (7-0)		138 (6-0)
	17	ERR	50	FF	Auto FM switch Threshold		21 (10-3)		166 (7-0)
18	VOL	6D	FF	Loud Speaker gain 7000h to 7f0h		0000 (15-4)		1A7 (7-0)	

## Adjustment Item Table

Device Name	Functionality		Note	Data Range	Function	Note for Different Data	Register No. (bit)	Slava Address	RAM Address (bit)
	No	Name							
TXT	0	TXH	1	3	Teletext Horizontal Position			(58H)	18D (1-0)
	1	TXV	0	3	Teletext Vertical Position				18D (6-4)
OPM	0	OSH	0A	3F	OSD H Position	Option-Misc			AC (7-2)
	1	COM	0	03	Comb Selection				A5 (7-6)
	2	APC	1	1	APC Switch				A4 (5)
	3	TSY	0	03	TV Sys at Auto TV Sys				A4 (4-3)
	4	MUT	0	1	No Signal Mute				A4 (0)
	5	AFM	0	1	Auto FM switch				A4 (1)
	6	RFB	0	3	C-BPF Control				A5 (5-4)
	7	TVO	0	7	Tilt to V-Angle Offset				A5 (2-0)
8	DBL	0	1	Disable Blueback Function	A4 (2)				
OPB	0	OP1	0	FF	Optional Bits 1 (see below)	Option-Bits			45
	1	OP2	0	FF	Optional Bits 2 (see below)				46
	2	OP3	0	FF	Optional Bits 3 (see below)				47

### NOTE

- shaded items are fixed data.
- Standard data listed on the Adjustment Item Table are reference values, therefore it may be different for each model and for each mode.
- Note for Different Data Those are the standard data values written on the microprocessor. Therefore, the data values of the modes and stored respectively in the memory.  
In case of a device replacement, adjustment by rewriting the data value is necessary for some items.



Adjustment Item Table (KV-XF21N90)

Device Name	Functionality		Note	Data Range	Function	Note for Different Data	Register No. (bit)	Slava Address	RAM Address (bit)
	No	Name							
GEO	0	HPS	7	3F	H Position	50/60HZ	12 (7-2)	CXA2130S(88H)	84 (7-2)
	1	HSZ	1F	3F	H Size	50/60HZ	11 (7-2)		83 (7-2)
	2	PAP	1F	3F	Pin Amp	50/60HZ	13 (7-2)		85 (7-2)
	3	TLT	7	0F	Trapezium	50/60HZ	15 (7-4)		87 (7-4)
	4	VPS	1F	3F	V Position	50/60HZ	0F (7-2)		81 (7-2)
	5	VSZ	1F	3F	V Size	50/60HZ	0E (7-2)		80 (7-2)
	6	SCO	7	0F	S Correction	50/60HZ	10 (7-4)		82 (7-4)
	7	VLN	7	0F	V Linearity	50/60HZ	10 (3-0)		82 (3-0)
	8	BOW	7	0F	AFC Bow	50/60HZ	16 (7-4)		88 (7-4)
	9	AGL	7	0F	AFC-Angle	50/60HZ	16 (3-0)		88 (3-0)
	10	UPN	1F	3F	Upper Pin	50/60HZ	14 (7-2)		86 (7-2)
	11	LPN	1F	3F	Lower Pin	50/60HZ	18 (7-2)		8A (7-2)
	12	HBL	0	1	H Blanking on/off		18 (1)		69 (1)
	13	LBL	7	0F	Left H Blanking	50/60HZ	17 (7-4)		89 (7-4)
14	RBL	7	0F	Right H Blanking	50/60HZ	17 (3-0)	89 (3-0)		
WHB	0	RDR	25/2A	3F	R Drive	DYNAMIC/others	09 (7-2)	CXA2130S(88H)	91 (7-2)
	1	GDR	2A	3F	G Drive	DYNAMIC/others	0A (7-2)		92 (7-2)
	2	BDR	2A	3F	B Drive	DYNAMIC/others	0B (7-2)		93 (7-2)
	3	RCT	7	0F	R Cutoff	SECAM/others	07 (3-0)		95 (3-0)
	4	GCT	7	0F	G Cutoff	SECAM/others	08 (7-4)		96 (7-4)
	5	BCT	7	0F	B Cutoff	SECAM/others	08 (3-0)		96 (3-0)
	6	BMN	15	1F	Brightness Minimum Data				99
7	SBR	28	3F	Sub Brightness Control			9A		
SAJ	0	PMX	37	3F	Picture Maximum Data			CXA2130S(88H)	98
	1	SHU	8	0F	Sub Hue Control	TV/Video			9B
	2	SSH	03/08	0F	Sub Sharpness Control	TV/Video			9C
	3	SCL	1F	3F	Sub Color Control	NTSC/others			9D
VP	0	EHT	07/07	0F	EHT Comp	50/60HZ	15 (3-0)	CXA2130S(88H)	87 (3-0)
	1	GMA	*	03	Gamma Correction	Refer NVM Map A4	0B (1-0)		1A4 (1-0)
	2	YDL	08/09/08	0F	Y Delay	PAL/SECAM/NTSC	0C (3-0)		8E (3-0)
	3	SST	3	03	SECAM ID Start Position		1B (1-0)		6C (1-0)
	4	SSP	1	03	SECAM ID Stop Position		1B (3-2)		6C (3-2)
	5	SLV	2	03	SECAM ID Level		1C (1-0)		6D (1-0)
	6	SBF	22	3F	SECAM BELL fO		1C (7-2)		6D (7-2)
	7	DYC	1	1	Dynamic Color on/off		0A (1)		5B (1)
	8	ABL	1	1	ABL Mode Switching (STANDARD ALWAYS 0)		09 (1)		5A (1)
	9	VTH	1	1	ABL Detection Vth Switching		09 (0)		5A (0)
	10	SFO	01/01	1	FO Switching for Sharpness	NTSC/others	05 (1)		199 (1)
	11	DCX	1	1	DC Trans. Ratio Switching		06 (1)		57 (1)
12	SHT	01/01	1	Pre-/Overshoot ratio Switch	NTSC/others	06 (0)	19A (0)		

### Adjustment Item Table

Device Name	Functionality		Note	Data Range	Function	Note for Different Data	Register No. (bit)	Slava Address	RAM Address (bit)
	No	Name							
VP	13	HDW	0	1	H Drive Pulse Width Switch	TV/Video	00 (6)		51(6)
	14	AFC	1	03	AFC Gain Control		0F (1-0)		8F (1-0)
	15	HOS	7	0F	H Oscillation		0C (7-4)		5D (7-4)
	16	HSS	0	1	Slice Level of H Sync Sep.		0D (1)		5E (1)
	17	VSS	0	1	Slice Level of V Sync Sep.	0D (0)	5E (0)		
	18	HMS	0	1	Macro Vision C/m off/on	50/60Hz	0E (0)		80 (0)
	19	YUV	0	1	YUV Switch Control	01 (0)	52 (0)		
	20	CDV	1	3	CD mode for Video/ RF no signal	0D (5-4)	1A2 (5-4)		
	21	RON	1	1	R ON	not memorized	01 (3)		52 (3)
	22	GON	1	1	G ON	not memorized	01 (2)		52 (2)
	23	BON	1	1	B ON	not memorized	01 (1)		52 (1)
	24	PON	1	1	P ON	not memorized	00 (7)		51 (7)
	25	BLK	0	1	BLK Off		12 (0)		63 (0)
	26	VMC	0	1	VM Off		13 (0)		64 (0)
AP	0	INF	0	3F	Input Attenuation When surround on		00 (5-0)	TDA7429	1A0 (5-0)
	1	INS	0	3F	Input Attenuation When surround off				1A1 (5-0)
	2	PH1	0	3	Phase 1 Register Selection		02		78 (1-0)
	3	PH2	0	3	Phase 2 Register Selection				78 (3-2)
	4	PH3	0	3	Phase 3 Register Selection				78 (5-4)
	5	PH4	0	3	Phase 4 Register Selection				78 (7-6)
	6	BCS	2	3	Bass Center Shift		#4 (3-0)		1A9 (1-0)
	7	TCS	2	3	Treble Center Shift		#5 (3-0)		1AA (1-0)
8	TRF	2	3	RF Treble Offset		#5 (3-0)		1AA (5-4)	
MSP	0	WST	15	FF	W/G Stereo Threshold			MSP3415D(84H)	157 (7-0)
	1	WBT	EA	FF	W/G Bilingual Threshold				158 (7-0)
	2	WLL	5	FF	W/G Monaural Threshold				159 (7-0)
	3	WAC	0	0F	W/G Agreement Count				15A (3-0)
	4	WDL	30	FF	W/G Search Delay				15B (7-0)
	5	NDL	20	FF	NICAM Search Delay				15C (7-0)
	6	SDL	10	FF	Stereo status Read Delay				15D (7-0)
	7	AGC	1	1	AGC Switch Auto/Constant		BB (7)		108 (7)
	8	REL	28	3F	AGC Gain at Constant Mode		BB (6-1)		108 (6-1)
	9	CRM	0	1	Carrier muting on/off		BB (9)		107 (1)
	10	ACO	1	1	Audio Clock out on/off		83 (5)		10C (5)
	11	FP	1B	7F	FM Prescale for non-M system		0E (7-0)		16C (6-0)
	12	FPM	32	7F	FM Prescale for M system		0E (7-0)		16D (6-0)
	13	FH	36	7F	FM Prescale for HDEV		0E (7-0)		16E (6-0)
	14	FHM	65	7F	FM Prescale for HDEV and M		0E (7-0)		16F (6-0)
	15	WGP	2A	7F	W/G Prescale		0E (7-0)		170 (6-0)
	16	NIP	6D	7F	NICAM Prescale		10 (7-0)		138 (6-0)
	17	ERR	50	FF	Auto FM switch Threshold		21 (10-3)		166 (7-0)
18	VOL	6D	FF	Loud Speaker gain 7000h to 7fah		0000 (15-4)		1A8 (7-0)	

### Adjustment Item Table

Device Name	Functionality		Note	Data Range	Function	Note for Different Data	Register No. (bit)	Slava Address	RAM Address (bit)
	No	Name							
TXT	0	TXH	1	3	Teletext Horizontal Position			(58H)	18D (6-4)
	1	TXV	0	3	Teletext Vertical Position				18D (1-0)
OPM	0	OSH	0A	3F	OSD HPosition	Option-Misc			81 (7-2)
	1	COM	0	03	Comb Selection				AE (7-6)
	2	APC	1	1	APC Switch				AD (5)
	3	TSY	0	03	TV Sys at Auto TV Sys				AD (4-3)
	4	MUT	1	1	No Signal Mute				AD (0)
	5	AFM	0	1	Auto FM switch				AD (1)
	6	RFB	0	3	C-BPF Control				AE (5-4)
	7	TVO	0	-	Tilt to V-Angle Offset				A5 (2-0)
	8	DBL	0	1	Disable Blueback Function				A4 (2)
OPB	0	OP1	F1	FF	Optional Bits 1 (see below)	Option-Bits			47
	1	OP2	1	FF	Optional Bits 2 (see below)				48
	2	OP3	28	FF	Optional Bits 3 (see below)				49

#### NOTE

- shaded items are fixed data.
- Standard data listed on the Adjustment Item Table are reference values, therefore it may be different for each model and for each mode.
- Note for Different Data Those are the standard data values written on the microprocessor. Therefore, the data values of the modes and stored respectively in the memory.  
In case of a device replacement, adjustment by rewriting the data value is necessary for some items.

## ITEM INFORMATION.

## No. OPB0 OP1

Item	XTAL 4.43	XTAL 3.58	SECAM	2nd. Lang	B/G	I	D/K	M
KV-HF51P50	1	1	0	1	1	0	0	0
KV-XF21M80(E)	1	1	1	1	1	1	1	1
KV-XF21M80(ME)	1	1	1	1	1	1	1	1
KV-XF21M80 (Vietnam)	1	1	1	1	1	1	1	1
KV-XF21M83	1	1	1	1	1	1	1	1
KV-XF21N90	1	1	1	1	0	0	0	1
KV-XF51M65	1	1	1	1	1	1	1	1

## No. OPB1 OP2

Item	TOP	NICAM	HDEV	Thai Bil	Dis Fav	DVD Input	AV Input	
KV-HF51P50	1	0	1	0	0	0	1	0
KV-XF21M80(E)	1	0	1	0	0	0	1	0
KV-XF21M80(ME)	1	0	1	0	0	0	1	0
KV-XF21M80 (Vietnam)	1	0	1	0	0	0	1	0
KV-XF21M83	1	0	1	0	0	0	1	0
KV-XF21N90	0	0	0	0	0	0	1	0
KV-XF51M65	1	1	1	0	0	0	1	0

## No. OPB2 OP3

Item	Pic Rot	2199 Curve	Auto PIC	Auto TV sys	US ST	AV Mono	11 KEY	Color SW
KV-HF51P50	0	0	0	0	0	0	0	0
KV-XF21M80(E)	1	0	0	0	0	0	0	0
KV-XF21M80(ME)	0	0	0	0	0	0	0	0
KV-XF21M80 (Vietnam)	1	0	0	0	0	0	0	0
KV-XF21M83	0	0	0	0	0	0	0	0
KV-XF21N90	1	0	1	0	1	1	0	0
KV-XF51M65	0	0	0	0	0	1	0	0

### 4-3. PICTURE QUALITY ADJUSTMENTS

#### SUB COLOR ADJUSTMENT

1. Input a PAL color-bar.
2. Set to the following condition:  
PICTURE 100%, BRIGHTNESS 50%, COLOR 50%
3. Connect an oscilloscope to pin ① (B OUT) of CN305, A board.
4. Set to Service Mode and select SAJ 3 'SCL' with **[1]** and **[4]** of the commander then adjust to VB2=VB3=VB4 with **[3]** and **[6]**.
5. Press **[MUTING]** → **[0]** of the commander to write the data.
6. Adjust SAJ 3 'SCL' as step 2 to 5 when receiving NTSC color-bar.

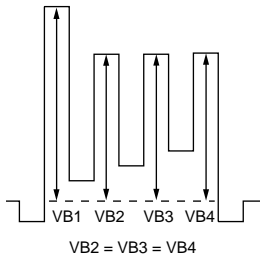

#### SUB HUE ADJUSTMENT

1. Select Video 1.
2. Input a NTSC color-bar, video into Video 1.
3. Set the following condition:  
PICTURE 100%, BRIGHTNESS 50%, COLOR 50%
4. Connect an oscilloscope to pin ① (B OUT) of CN305, A board.
5. Select SAJ 1 'SHU' with **[1]** and **[4]** of the commander by setting to Service Mode and adjust to VB1=VB2=VB3=VB4 with **[3]** and **[6]**.

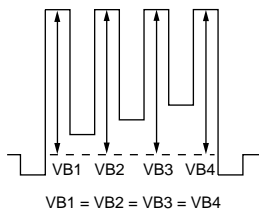

6. Press **[MUTING]** → **[0]** of the commander to write the data.

#### BELL FILTER ADJUSTMENT

1. Input SECAM color-bar signal.
2. Connect the dual-trace oscilloscope to the pin ⑨ (R-Y) of CN303 (not mounted).
3. Adjust SERVICE MODE, ITEMS 'SBF' as shown below.

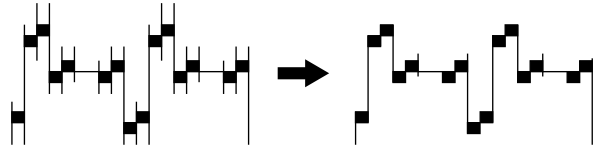

### 4-4. A BOARD ADJUSTMENT AFTER IC003 (MEMORY) REPLACEMENT

When replacing IC003 (MEMORY), be sure to change IC001 ( $\mu$ -COM) to the following new IC at the same time.

IC001( $\mu$ -CON):CXP86449-614S (KV-XF21M80(ME))

CXP86449-615S (Except KV-XF21M80(ME)

/XF21N90)

CXP86449-618S (KV-XF21N90)

1. Enter to Service Mode.M
2. Press commander buttons **[5]** and **[0]** (Data Initialize), and **[2]** and **[0]** (Data Copy) to initialize the data.
3. Call each item number and check if the respective screen shows the normal picture.  
In cases where items are not well adjusted, rectify the items with fine adjustment.  
Write the data per each item number (**[MUTING]** + **[0]**).
4. Select item numbers "OPB0" (OP1), "OPB1" (OP2) and "OPB2" (OP3) and respectively set the bit per model with command buttons **[3]** and **[6]**.
5. Press commander buttons **[8]** and **[0]** (Test Normal) to return to the data that was set on the shipment from the factory.  
(This will also cancel Service Mode.)

**4-5. PICTURE DISTORTION ADJUSTMENT**

Item Number 00 – 0B

GEO 0 HSH (H POSITION)

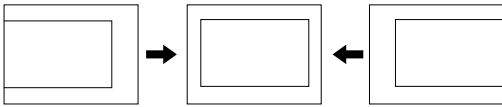

GEO 1 HSZ (H SIZE)

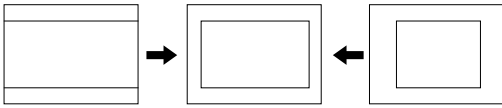

GEO 2 PAP (PIN AMP)

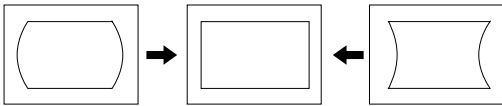

GEO 3 TILT (TRAPEZIUM)

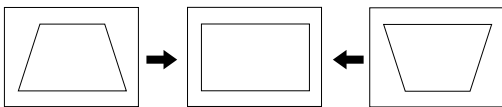

GEO 4 VSH (V POSITION)

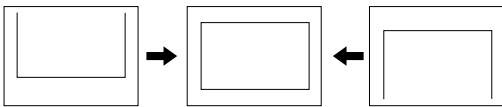

GEO 5 VSZ (V SIZE)

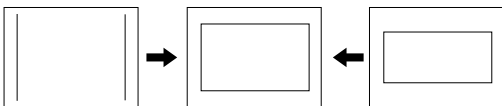

GEO 6 SCR (VERTICAL S-Correction)



GEO 7 VLN (V LINEARITY)

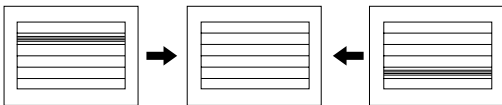

GEO 8 VBOW (AFC.BOW)

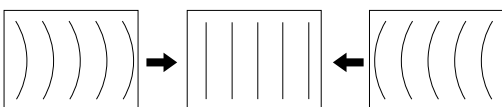

GEO 9 AGL (AFC.ANGLE)

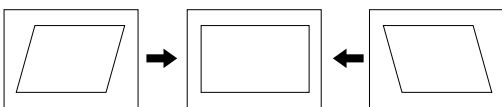

GEO 0A UCP (UPPER CORNER PIN)

GEO 0B LCP (LOWER CORNER PIN)

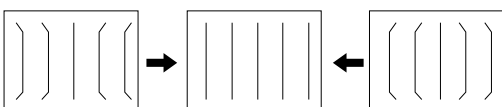



**SECTION 5  
DIAGRAM**

**5-1. BLOCK DIAGRAM**

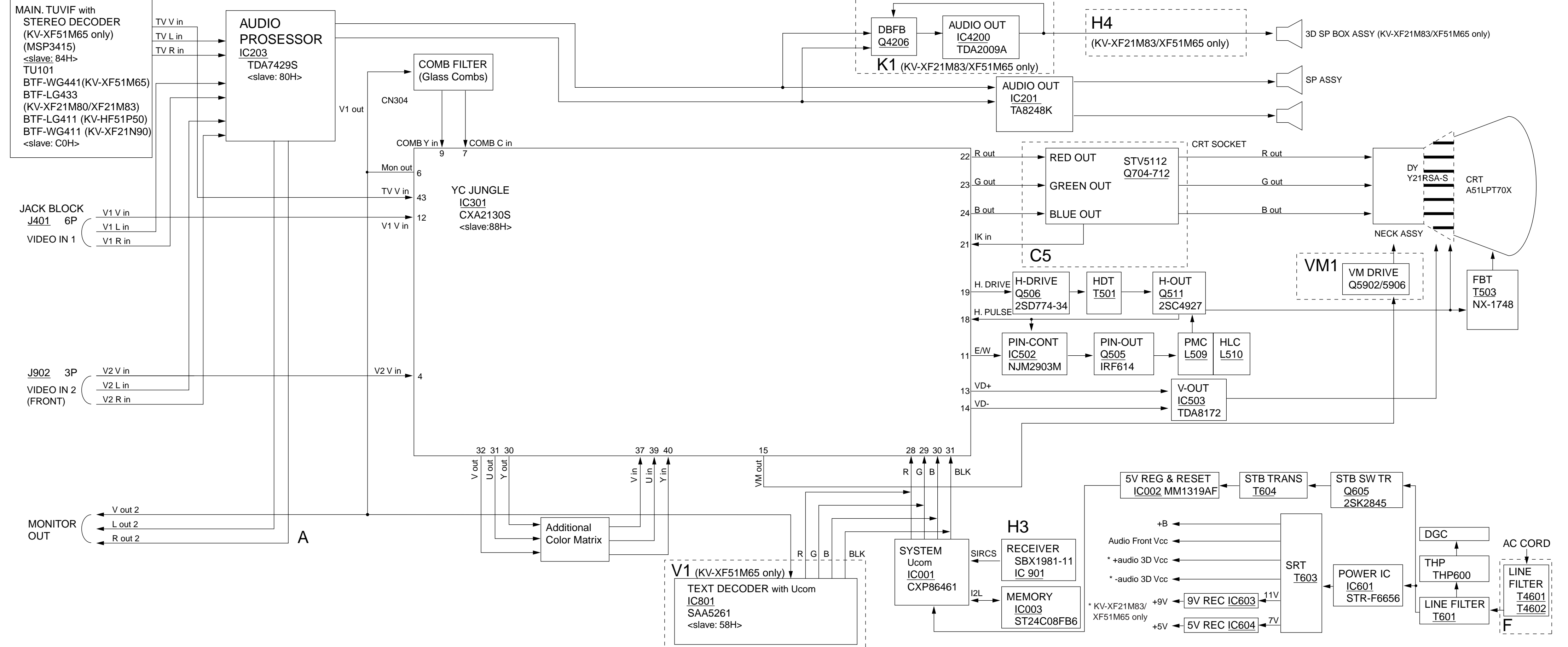



**SECTION 6**  
**EXPLODED VIEW**

**NOTE:**

- Items with no part number and no description are not stocked because they are seldom required for routine service.
- The construction parts of an assembled part are indicated with a collation number in the remark column.
- Items marked "\*" are not stocked since they are seldom required for routine service. Some delay should be anticipated when ordering these items.

The components identified by shading and mark  $\Delta$  are critical for safety. Replace only with part number specified.

**6-1. CHASSIS (Except KV-HF51P50)**

- : BVTP3 × 12 7-685-648-79
- : BVTP4 × 16 7-685-663-71

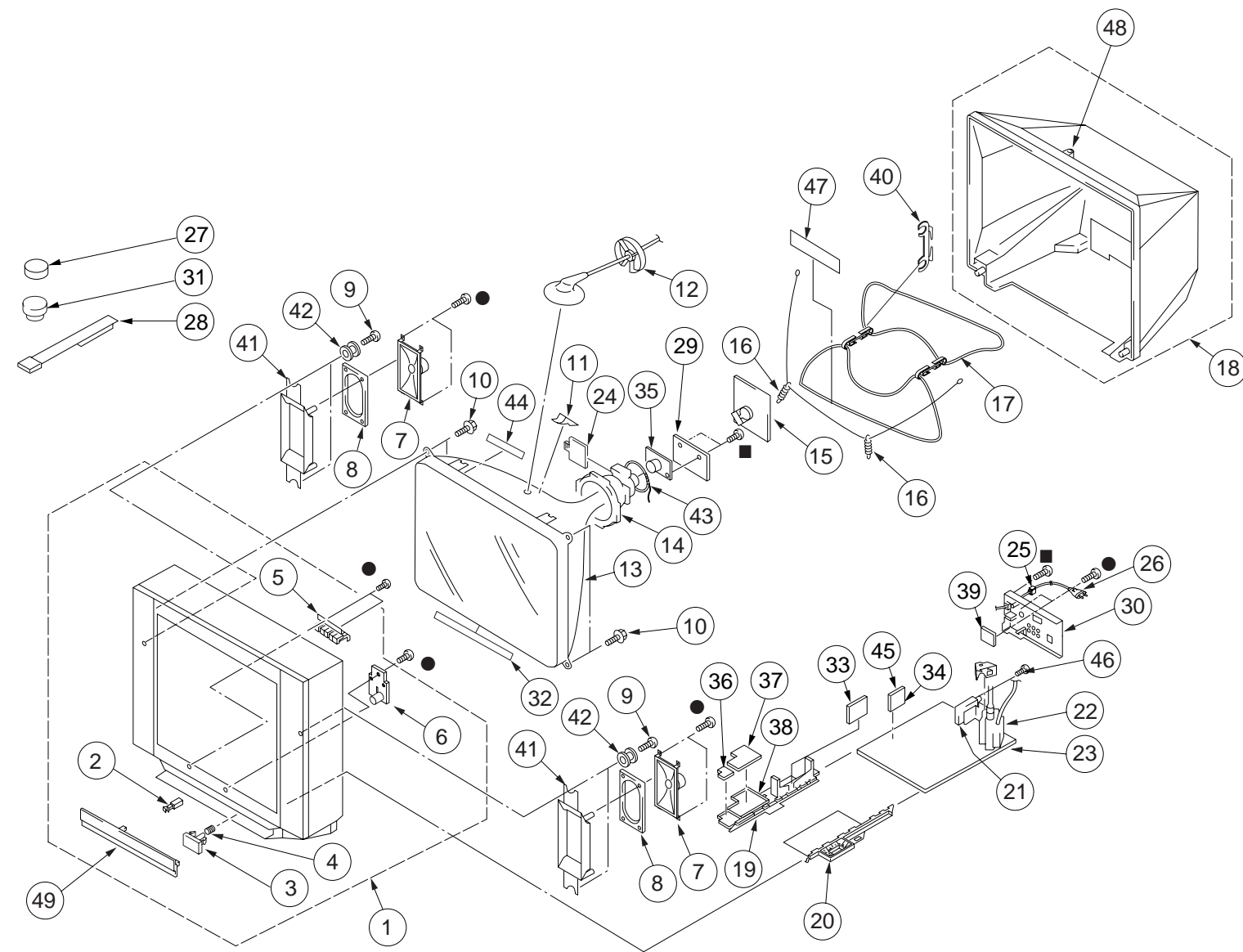

REF. NO.	PART NO.	DESCRIPTION	REMARK
(KV-XF21M80(E/ME))			
1	X-4036-788-1	BEZNET ASSY	2-6, 49
2	4-047-464-01	CATCHER, PUSH	
3	4-070-137-01	BUTTON, POWER	
4	4-036-405-41	SPRING, COMPRESSION	
5	4-070-135-01	BUTTON, MULTI	
6	* 4-070-136-01	GUIDE, LIGHT	
7	1-529-125-11	SPEAKER (13X7CM)	
8	* 4-069-797-31	CUSHION, SPEAKER(S)	
9	4-302-404-03	SCREW (WASHER HEAD) (+P 4X16)	
10	4-365-808-01	SCREW (5), TAPPING	
11	4-046-600-11	SPACER, DY	
12	* 3-704-372-41	HOLDER, HV CABLE	
13	$\Delta$ 8-738-809-05	PICTURE TUBE (A51LPT70X)	
14	8-451-505-11	DEFLECTION YOKE (Y21RSA-S)	
15	* A-1331-959-A	C5 BOARD, MOUNTED	
16	4-369-318-61	SPRING, TENSION	
17	$\Delta$ 1-416-946-11	COIL, DEMAGNETIC	
18	$\Delta$ X-4036-465-2	REAR COVER ASSY	
19	* 4-067-189-01	PWB(L), GUIDE (KV-XF21M80(E))	
20	* 4-070-139-01	PWB(L), GUIDE (KV-XF21M80(ME))	
21	* 4-067-187-01	PWB(R), GUIDE (KV-XF21M80(E))	
22	* 4-070-138-01	PWB(R), GUIDE (KV-XF21M80(ME))	
23	8-598-449-01	TUNER, FSS BTF-LG433	
24	$\Delta$ 1-453-293-11	TRANSFORMER ASSY, FLYBACK (NX-1748/M3A4)	
25	* A-1298-945-A	A BOARD, COMPLETE (KV-XF21M80(E))	
26	* A-1298-944-A	A BOARD, COMPLETE (KV-XF21M80(ME))	
27	4-057-714-01	PIECE ASSY, TLH CORRECTION	
28	$\Delta$ 4-022-115-21	HOLDER, AC CORD	
29	$\Delta$ 1-574-062-22	CORD, POWER (WITH CONNECTOR) 2.5A/250V	
30	1-452-032-00	MAGNET, DISC	
31	4-051-736-21	PIECE A(90), CONV. CORRECT	
32	* A-1342-492-A	VM1 BOARD, MOUNTED	
33	* 4-070-140-01	BRACKET, TERMINAL	
34	1-452-094-00	CIRCULAR DISC MAGNET B	
35	4-069-651-51	BLOTTING SHEET	
36	* A-1241-379-A	F BOARD, MOUNTED	
37	THIS IS NOT FOR THESE MODELS		
38	THIS IS NOT FOR THESE MODELS		
39	THIS IS NOT FOR THESE MODELS		
40	4-064-883-11	HOLDER, DGC	
41	4-070-142-01	BAFFLE, SPEAKER	
42	4-069-413-51	CUSHION (A)	
43	1-452-728-61	COIL, NA ROTATION (RT-154)	
44	4-069-652-51	CUSHION (HS BAND)	
45	THIS IS NOT FOR THESE MODELS		
46	THIS IS NOT FOR THESE MODELS		
47	4-069-653-51	CUSHION, DGC	
48	THIS IS NOT FOR THESE MODELS		
49	4-070-134-21	DOOR CONTROL	

REF. NO.	PART NO.	DESCRIPTION	REMARK
(KV-XF21M80(VIETNAM)/XF21M83/XF21N90/XF51M65)			
1	X-4036-828-1	BEZNET ASSY (KV-XF21M80(VIETNAM))	2-6
2	X-4036-827-1	BEZNET ASSY (KV-XF21M83)	2-6
3	X-4036-831-1	BEZNET ASSY (KV-XF21N90)	2-6
4	X-4036-832-1	BEZNET ASSY (KV-XF51M65)	2-6
5	4-047-464-01	CATCHER, PUSH	
6	4-067-183-01	BUTTON, POWER	
7	4-036-405-11	SPRING, COMPRESSION	
8	4-067-181-01	BUTTON, MULTI	
9	* 4-067-180-01	GUIDE, LIGHT	
10	1-529-125-11	SPEAKER (13X7CM)	
11	* 4-069-797-01	CUSHION, SPEAKER(S)	
12	4-302-404-03	SCREW (WASHER HEAD) (+P 4X16) (KV-XF21N90/XF51M65 ONLY)	
13	4-365-808-01	SCREW (5), TAPPING	
14	4-046-600-11	SPACER, DY	
15	* 3-704-372-41	HOLDER, HV CABLE (KV-XF21M80(VIETNAM)/XF21M83)	
16	* 4-047-349-41	HOLDER, HV CABLE (KV-XF21N90)	
17	* 4-047-349-01	HOLDER, HV CABLE (KV-XF51M65)	
18	$\Delta$ 8-738-812-05	PICTURE TUBE (A51LPT70X) (EXCEPT KV-XF21N90)	
19	$\Delta$ 8-738-809-05	PICTURE TUBE (A51LPT70X) (KV-XF21N90)	
20	8-451-505-11	DEFLECTION YOKE (Y21RSA-S)	
21	* A-1331-955-A	C5 BOARD, MOUNTED (KV-XF21M80(VIETNAM)/XF21M83))	
22	* A-1331-941-A	C5 BOARD, MOUNTED (KV-XF21N90)	
23	* A-1331-962-A	C5 BOARD, MOUNTED (KV-XF51M65)	
24	4-369-318-61	SPRING, TENSION (EXCEPT KV-XF51M65)	
25	4-369-318-81	SPRING, TENSION (KV-XF51M65)	
26	$\Delta$ 1-416-946-11	COIL, DEMAGNETIC (EXCEPT KV-XF21N90)	
27	$\Delta$ 1-416-946-31	COIL, DEMAGNETIC (KV-XF21N90)	
28	$\Delta$ X-4036-465-2	REAR COVER ASSY (KV-XF21M80(VIETNAM)/XF21M83/XF21N90)	
29	$\Delta$ X-4036-774-1	REAR COVER ASSY (KV-XF51M65)	
30	* 4-067-189-01	PWB(L), GUIDE	
31	* 4-067-187-01	PWB(R), GUIDE	
32	8-598-449-01	TUNER, FSS BTF-LG433 (KV-XF21M80(VIETNAM)/XF21M83)	
33	8-598-477-00	TUNER, FSS BTF-WG411 (KV-XF21N90)	
34	8-598-451-00	TUNER, FSS BTF-WG441 (KV-XF51M65)	
35	$\Delta$ 1-453-293-11	TRANSFORMER ASSY, FLYBACK (NX-1748/M3A4)	
36	* A-1298-933-A	A BOARD, COMPLETE (KV-XF21M80(VIETNAM))	
37	* A-1298-932-A	A BOARD, COMPLETE (KV-XF21M83)	
38	* A-1298-954-A	A BOARD, COMPLETE (KV-XF21N90)	
39	* A-1298-953-A	A BOARD, COMPLETE (KV-XF51M65)	
40	4-057-714-01	PIECE ASSY, TLH CORRECTION	
41	$\Delta$ 4-022-115-12	HOLDER, AC CORD	
42	$\Delta$ 1-782-173-11	CORD, POWER (WITH CONNECTOR) 2.5A/250V (KV-XF21M80(VIETNAM)/XF21M83)	
43	$\Delta$ 1-575-023-11	CORD, POWER (WITH CONNECTOR) 6A/250V (KV-XF21N90)	
44	$\Delta$ 1-574-062-52	CORD, POWER (WITH CONNECTOR) 2.5A/250V (KV-XF51M65)	
45	1-452-032-00	MAGNET, DISC	
46	4-051-736-21	PIECE A(90), CONV. CORRECT	
47	* A-1342-491-A	VM1 BOARD, MOUNTED (KV-XF21M80(VIETNAM)/XF21M83)	
48	* A-1342-453-A	VM1 BOARD, MOUNTED (KV-XF21N90)	
49	* A-1342-495-A	VM1 BOARD, MOUNTED (KV-XF51M65)	

REF. NO.	PART NO.	DESCRIPTION	REMARK
30	4-067-167-01	BRACKET, TERMINAL (KV-XF21M80(VIETNAM))	
31	4-067-167-11	BRACKET, TERMINAL (KV-XF21M83/XF51M65)	
32	4-067-167-31	BRACKET, TERMINAL (KV-XF21N90))	
33	1-452-094-00	CIRCULAR DISC MAGNET B	
34	4-069-651-02	BLOTTING SHEET (EXCEPT KV-XF51M65)	
35	* A-1241-378-A	F BOARD, MOUNTED (KV-XF21M80(Vietnam)/XF21M83)	
36	* A-1241-383-A	F BOARD, MOUNTED (KV-XF21N90)	
37	* A-1241-381-A	F BOARD, MOUNTED (KV-XF51M65)	
38	* 4-068-953-01	BRACKET, V1 (KV-XF51M65 ONLY)	
39	8-453-011-31	NA299-S2	
40	* A-1372-669-A	H4 BOARD, MOUNTED (KV-XF21M83)	
41	* A-1372-681-A	H4 BOARD, MOUNTED (KV-XF51M65)	
42	* A-1380-614-A	K1 BOARD, MOUNTED (KV-XF21M83)	
43	* A-1380-616-A	K1 BOARD, MOUNTED (KV-XF51M65)	
44	* 4-067-188-01	BRACKET, H4-K1 PCB (KV-XF21M83/XF51M65 ONLY)	
45	* A-1388-255-A	J3 BOARD, MOUNTED (KV-XF21M83)	
46	* A-1388-256-A	J3 BOARD, MOUNTED (KV-XF51M65)	
47	4-064-883-11	HOLDER, DGC	
48	4-067-184-01	BAFFLE, SPEAKER	
49	4-374-745-21	CUSHION (A) (KV-XF21M80(VIETNAM)/XF51M65 ONLY)	
50	1-452-728-61	COIL, NA ROTATION (RT-154)	
51	4-069-652-01	CUSHION (HS BAND) (EXCEPT KV-XF51M65)	
52	4-069-652-41	CUSHION (HS BAND) (KV-XF51M65)	
53	* A-1347-159-A	V1 BOARD, COMPLETE (KV-XF51M65 ONLY)	
54	1-573-657-21	PLUG, F-PIN (KV-XF21N90 ONLY)	
55	4-069-653-41	CUSHION, DGC	
56	4-038-462-01	CAP, ANTENNA (KV-XF21N90 ONLY)	
57	4-067-185-01	DOOR CONTROL (KV-XF21M80(Vietnam))	
58	4-069-984-11	DOOR CONTROL (KV-XF21M83)	
59	4-069-984-01	DOOR CONTROL (KV-XF21N90)	
60	4-067-185-21	DOOR CONTROL (KV-XF51M65)	

**6-2. CHASSIS (FOR KV-HF51P50)**

- : BVTP3 × 12 7-685-648-79
- : BVTP4 × 16 7-685-663-71

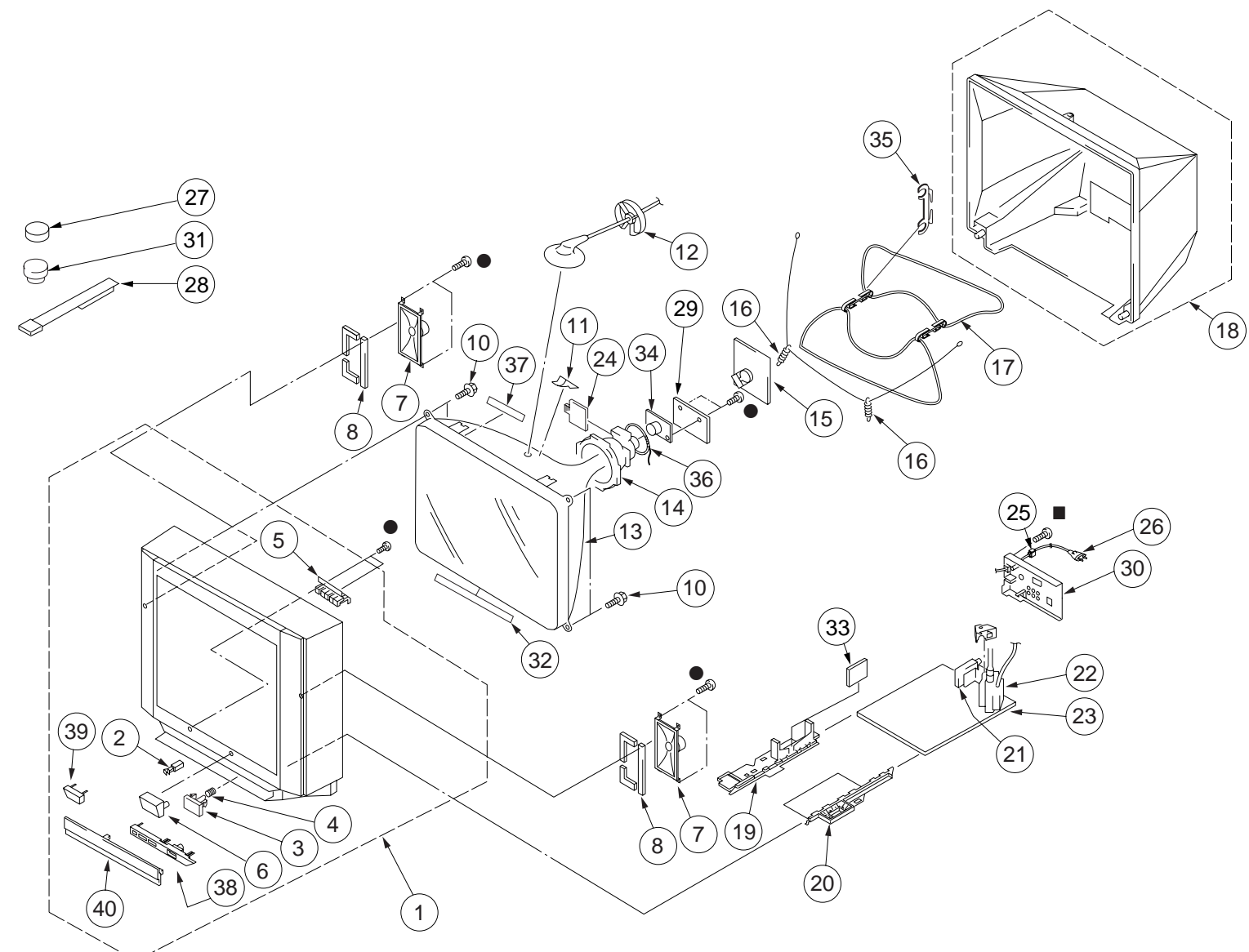

REF. NO. PART NO. DESCRIPTION REMARK

REF. NO.	PART NO.	DESCRIPTION	REMARK
(KV-HF51P50)			
1	X-4036-830-1	BEZNET ASSY	2-6, 38, 39, 40
2	4-047-464-01	CATCHER, PUSH	
3	4-067-190-01	BUTTON, POWER	
4	4-036-405-11	SPRING, COMPRESSION	
5	4-067-196-01	BUTTON, MULTI	
6	4-067-197-01	GUIDE, LIGHT	
7	1-503-902-11	SPEAKER (15X6.5 CM)	
8	* 4-379-189-11	CUSHION, SPEAKER	
9		THIS IS NOT FOR THESE MODELS	
10	4-365-808-51	SCREW (5), TAPPING	
11	4-060-267-01	SPACER, DY	
12	* 4-047-349-01	HOLDER, HV CABLE	
13	△ 8-738-812-05	PICTURE TUBE (A51LPT70X)	
14	8-451-505-11	DEFLECTION YOKE (Y21RSA-S)	
15	* A-1331-962-A	C5 BOARD, MOUNTED	
16	4-369-318-81	SPRING, TENSION	
17	△ 1-416-946-11	COIL, DEMAGNETIC	
18	△ X-4036-774-1	COVER ASSY, REAR	
19	4-067-189-01	PWB(L), GUIDE	
20	4-067-187-01	PWB(R), GUIDE	
21	8-598-447-00	TUNER, FSS BTF-LG411	
22	△ 1-453-293-11	TRANSFORMER ASSY, FLYBACK (NX-1748/M3A4)	
23	* A-1298-952-A	A BOARD, COMPLETE	
24	4-057-714-01	PIECE ASSY, TLH CORRECTION	
25	△ 4-022-115-12	HOLDER, AC CORD	
26	△ 1-574-062-52	CORD, POWER (WITH CONNECTOR) 2.5A/250V	
27	1-452-032-00	MAGNET, DISC	
28	4-051-736-21	PIECE A(90), CONV, CORRECT	
29	* A-1342-495-A	VM1 BOARD, MOUNTED	
30	4-067-167-01	BRACKET, TERMINAL	
31	1-452-094-00	CIRCULAR DISC MAGNET B	
32	4-069-651-01	BLOTTING SHEET	
33	* A-1241-381-A	F BOARD, MOUNTED	
34	8-453-011-31	NA299-S2	
35	4-064-883-11	HOLDER, DGC	
36	1-452-728-61	COIL, NA ROTATION (RT-154)	
37	4-069-652-41	CUSHION (HS BAND)	
38	4-067-191-01	PANEL (R)	
39	4-067-193-01	PANEL (L)	
40	4-067-192-81	DOOR, CONTROL	

**6-3. 3D SPEAKER (KV-XF21M83/XF51M65 only)**

- ▲ : 7-685-661-71 SCREW BVTP 4 x 12
- : 7-685-663-71 SVREW BVTP 4 x 16

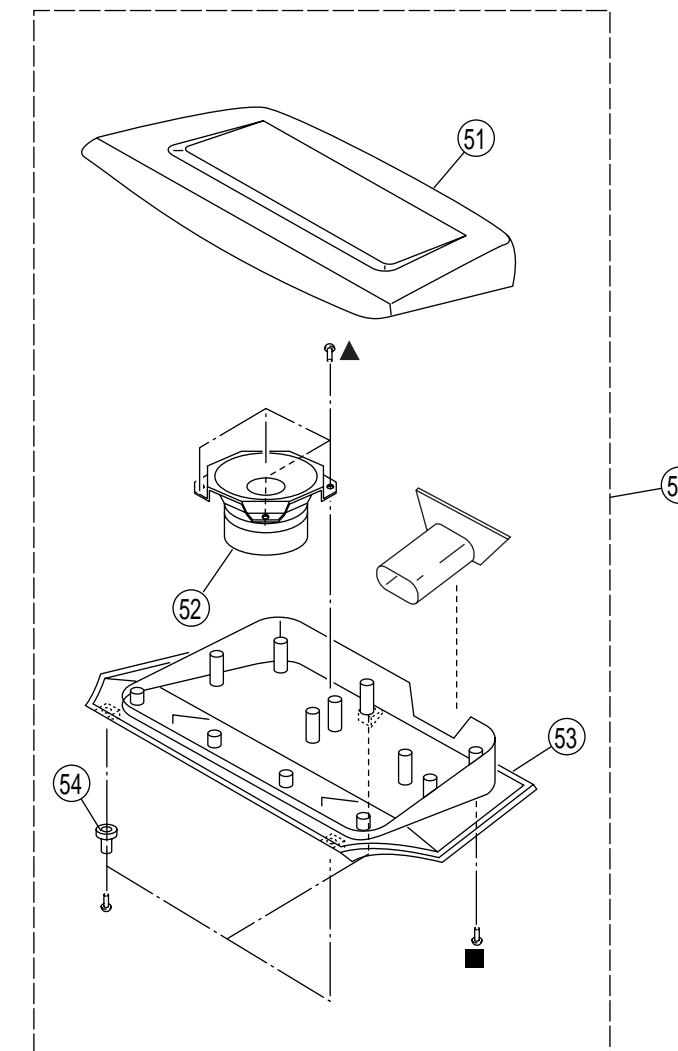

REF. NO. PART NO. DESCRIPTION REMARK

REF. NO.	PART NO.	DESCRIPTION	REMARK
51	* 4-067-201-01	3D WOOFER (UPPER)	
52	1-505-937-21	SPEAKER (10CM)	
53	* 4-067-199-01	3D WOOFER (LOWER)	
54	* 4-068-528-01	FOOT	
55	A-1501-446-B	BOX ASSY, SPEAKER (3D) (KV-XF51M65)	
	A-1501-494-A	BOX ASSY, SPEAKER (3D) (KV-XF21M83)	

5-5. SEMICONDUCTORS

DIODE

AK04V0  
 AU-01Z-V1  
 EL1Z  
 GP08D  
 RD33EB3T  
 RGP02-17EL-6433

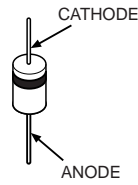

D4SB60L

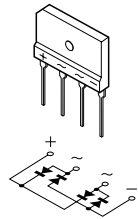

ERC04-06SE  
 ERC06-15S  
 RN4Z  
 31DQ06C5

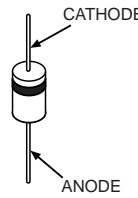

ERA22-08  
 ERD29-08J

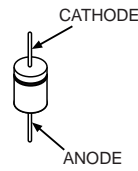

DTZ-TT11-15B  
 MA111-TX  
 RD10S-B  
 RD5.1SB-T2  
 RD9.1S-B  
 UDZS-TE17-6.8B  
 1SS355TE-17

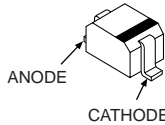

ON3171-R

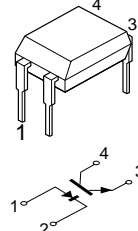

D1NS4  
 D1N20R  
 RD20ES-B2  
 RD30ESB2  
 RD39ES-B2  
 RD6.8ES-L1  
 RD9.1ES-L2  
 1SS119-25

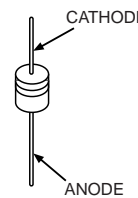

5P6M

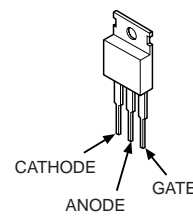

RD3.3M-B2  
 RD5.6M-B2

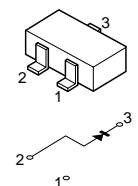

DAP202K

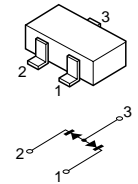

TRANSISTOR

DTA114EKA-T146  
 DTC114EK  
 UN2216  
 2SA1162-G  
 2SC1623-L5L6  
 2SC2712-YG  
 2SD2114K

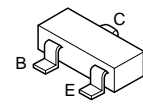

TR DTC144EKA  
 2SA1175-HFE  
 2SC2785-HFE

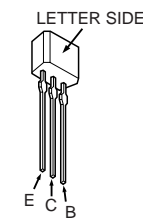

2SA1091-O

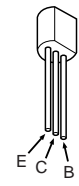

2SA1837  
 2SC4793  
 2SD2394-EF

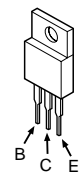

2SC2458-YGR  
 2SD2144S-UVW

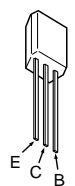

2SC2611

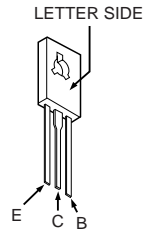

2SC4927-01

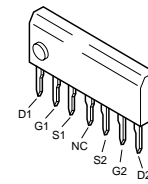

2SD774-34

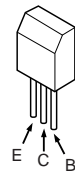

IRF614

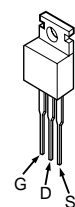

SK246-GR

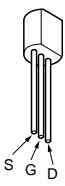

2SK2845-LB102



IC

CXA2130S (64PIN)  
 CXP86461-614S (64PIN)  
 CXP86461-615S (64PIN)  
 CXP86461-618S (64PIN)  
 SAA5261 (52PIN)  
 ST24C08FB6 (8PIN)  
 TDA7429S (42PIN)

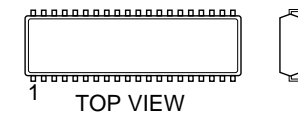

Dual In-line Package  
 Pin 6~98

MM1319AFBE (7PIN)  
 NJM2903M (8PIN)

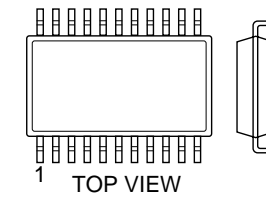

Single In-line Package  
 Pin 6~98

NJM78M09FA  
 TA7805S

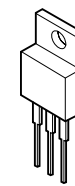

SBX1981-11(12)

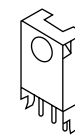

SE-135N

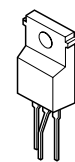

TDA8172

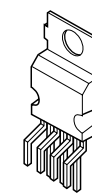

STR-F6654

MARKING SIDE VIEW

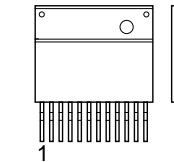

Zig-zag In-line Package  
 Pin 6~99

RU-1P

MARKING SIDE VIEW

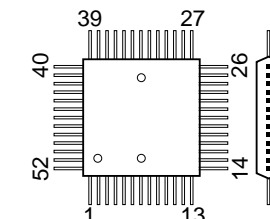

S-80743AL-A7-S

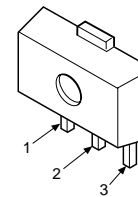

TA8223K  
 TA8248K

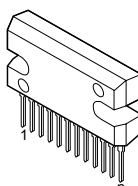

## SECTION 7

# ELECTRICAL PARTS LIST

# A (KV-HF51P50)

## NOTE:

The components identified by shading and mark  $\triangle$  are critical for safety. Replace only with part number specified.

When indicating parts by reference number, please include the board name.

- Items marked " \* " are not stocked since they are seldom required for routine service. Some delay should be anticipated when ordering these items.

- All variable and adjustable resistors have characteristic curve B, unless otherwise noted.

- All resistors are in ohms
- F : nonflammable

## CAPACITORS

- MF :  $\mu$ F, PF :  $\mu$ MF

## COILS

- MMH : mH, UH :  $\mu$ H

REF.NO.	PART NO.	DESCRIPTION	REMARK	REF.NO.	PART NO.	DESCRIPTION	REMARK
* A-1298-952-A	A BOARD, COMPLETE (KV-HF51P50)	*****		C108	1-126-933-11	ELECT 100MF	20% 16V
* 4-055-304-01	HOLDER, LED			C109	1-163-005-11	CERAMIC CHIP 470PF	10% 50V
* 4-067-182-02	HOLDER, FBT			C110	1-163-005-11	CERAMIC CHIP 470PF	10% 50V
4-382-854-11	SCREW (M3X10), P, SW (+)			C111	1-163-005-11	CERAMIC CHIP 470PF	10% 50V
4-382-854-21	SCREW (M3X14), P, SW (+)			C112	1-126-933-11	ELECT 100MF	20% 16V
7-685-648-79	SCREW +BVTP 3X12 TYPE2 IT-3			C113	1-126-967-11	ELECT 47MF	20% 50V
	<CAPACITOR>			C114	1-126-967-11	ELECT 47MF	20% 50V
C004	1-163-001-11	CERAMIC CHIP 220PF	10% 50V	C202	1-163-020-00	CERAMIC CHIP 0.0082MF	10% 50V
C005	1-163-001-11	CERAMIC CHIP 220PF	10% 50V	C203	1-163-020-00	CERAMIC CHIP 0.0082MF	10% 50V
C006	1-164-004-11	CERAMIC CHIP 0.1MF	10% 25V	C204	1-136-159-00	FILM 0.033MF	5% 50V
C007	1-126-933-11	ELECT 100MF	20% 16V	C205	1-164-182-11	CERAMIC CHIP 0.0033MF	10% 50V
C008	1-163-251-11	CERAMIC CHIP 100PF	5% 50V	C206	1-164-182-11	CERAMIC CHIP 0.0033MF	10% 50V
C010	1-163-251-11	CERAMIC CHIP 100PF	5% 50V	C207	1-136-159-00	FILM 0.033MF	5% 50V
C012	1-163-251-11	CERAMIC CHIP 100PF	5% 50V	C208	1-126-964-11	ELECT 10MF	20% 50V
C013	1-163-021-91	CERAMIC CHIP 0.01MF	10% 50V	C209	1-126-964-11	ELECT 10MF	20% 50V
C014	1-126-967-11	ELECT 47MF	20% 50V	C210	1-126-933-11	ELECT 100MF	20% 16V
C015	1-163-009-11	CERAMIC CHIP 0.001MF	10% 50V	C211	1-126-941-11	ELECT 470MF	20% 25V
C016	1-163-113-00	CERAMIC CHIP 68PF	5% 50V	C212	1-126-933-11	ELECT 100MF	20% 16V
C017	1-163-113-00	CERAMIC CHIP 68PF	5% 50V	C213	1-126-933-11	ELECT 100MF	20% 16V
C019	1-104-665-11	ELECT 100MF	20% 25V	C214	1-126-942-61	ELECT 1000MF	20% 25V
C022	1-163-227-11	CERAMIC CHIP 10PF	0.5PF 50V	C215	1-126-942-61	ELECT 1000MF	20% 25V
C023	1-163-227-11	CERAMIC CHIP 10PF	0.5PF 50V	C216	1-163-021-91	CERAMIC CHIP 0.01MF	10% 50V
C024	1-163-227-11	CERAMIC CHIP 10PF	0.5PF 50V	C217	1-126-964-11	ELECT 10MF	20% 50V
C026	1-164-004-11	CERAMIC CHIP 0.1MF	10% 25V	C218	1-136-167-00	FILM 0.15MF	5% 50V
C027	1-164-004-11	CERAMIC CHIP 0.1MF	10% 25V	C219	1-136-167-00	FILM 0.15MF	5% 50V
C028	1-163-037-11	CERAMIC CHIP 0.022MF	10% 50V	C220	1-126-942-61	ELECT 1000MF	20% 25V
C030	1-126-965-11	ELECT 22MF	20% 50V	C221	1-126-964-11	ELECT 10MF	20% 50V
C031	1-164-004-11	CERAMIC CHIP 0.1MF	10% 25V	C223	1-126-965-11	ELECT 22MF	20% 50V
C032	1-107-823-11	CERAMIC CHIP 0.47MF	10% 16V	C224	1-163-133-00	CERAMIC CHIP 470PF	5% 50V
C034	1-163-031-11	CERAMIC CHIP 0.01MF	50V	C225	1-109-982-11	CERAMIC CHIP 1MF	10% 10V
C041	1-163-251-11	CERAMIC CHIP 100PF	5% 50V	C226	1-109-982-11	CERAMIC CHIP 1MF	10% 10V
C042	1-163-251-11	CERAMIC CHIP 100PF	5% 50V	C227	1-163-037-11	CERAMIC CHIP 0.022MF	10% 50V
C043	1-163-251-11	CERAMIC CHIP 100PF	5% 50V	C228	1-163-024-00	CERAMIC CHIP 0.018MF	10% 50V
C044	1-163-251-11	CERAMIC CHIP 100PF	5% 50V	C229	1-163-018-00	CERAMIC CHIP 0.0056MF	10% 50V
C047	1-163-251-11	CERAMIC CHIP 100PF	5% 50V	C230	1-163-024-00	CERAMIC CHIP 0.018MF	10% 50V
C048	1-163-251-11	CERAMIC CHIP 100PF	5% 50V	C231	1-163-018-00	CERAMIC CHIP 0.0056MF	10% 50V
C050	1-163-251-11	CERAMIC CHIP 100PF	5% 50V	C232	1-163-037-11	CERAMIC CHIP 0.022MF	10% 50V
C051	1-163-251-11	CERAMIC CHIP 100PF	5% 50V	C233	1-164-004-11	CERAMIC CHIP 0.1MF	10% 25V
C053	1-163-251-11	CERAMIC CHIP 100PF	5% 50V	C234	1-164-004-11	CERAMIC CHIP 0.1MF	10% 25V
C054	1-163-251-11	CERAMIC CHIP 100PF	5% 50V	C235	1-164-004-11	CERAMIC CHIP 0.1MF	10% 25V
C055	1-163-251-11	CERAMIC CHIP 100PF	5% 50V	C236	1-164-004-11	CERAMIC CHIP 0.1MF	10% 25V
C103	1-164-004-11	CERAMIC CHIP 0.1MF	10% 25V	C238	1-164-505-11	CERAMIC CHIP 2.2MF	16V
C104	1-126-933-11	ELECT 100MF	20% 16V	C240	1-164-505-11	CERAMIC CHIP 2.2MF	16V
C107	1-163-005-11	CERAMIC CHIP 470PF	10% 50V	C241	1-164-346-11	CERAMIC CHIP 1MF	16V
				C242	1-164-505-11	CERAMIC CHIP 2.2MF	16V
				C243	1-216-295-91	SHORT 0	
				C244	1-164-700-11	CERAMIC CHIP 0.68MF	16V
				C245	1-164-346-11	CERAMIC CHIP 1MF	16V

The components identified by shading  
and mark  $\Delta$  are critical for safety.  
Replace only with part number specified.

**A (KV-HF51P50)**

REF. NO.	PART NO.	DESCRIPTION	REMARK	REF. NO.	PART NO.	DESCRIPTION	REMARK	
C246	1-163-018-00	CERAMIC CHIP	0.0056MF 10%	50V	C502	1-163-145-00	CERAMIC CHIP 0.0015MF 5%	50V
C247	1-164-346-11	CERAMIC CHIP	1MF	16V	C506	1-107-638-11	ELECT 33MF	20% 160V
C248	1-163-010-11	CERAMIC CHIP	0.0012MF 10%	50V	C507	1-161-830-00	CERAMIC 0.0047MF	500V
C249	1-164-004-11	CERAMIC CHIP	0.1MF	10% 25V	C510	1-102-112-00	CERAMIC 330PF	10% 50V
C250	1-216-295-91	SHORT	0		C512	1-163-989-11	CERAMIC CHIP 0.033MF	10% 25V
C251	1-163-017-00	CERAMIC CHIP	0.0047MF 10%	50V	C513	1-163-263-11	CERAMIC CHIP 330PF	5% 50V
C252	1-164-346-11	CERAMIC CHIP	1MF	16V	C514	1-107-368-11	MYLAR 0.047MF	99% 200V
C253	1-163-037-11	CERAMIC CHIP	0.022MF 10%	50V	C517	1-164-182-11	CERAMIC CHIP 0.0033MF	10% 50V
C254	1-126-965-11	ELECT	22MF	20% 50V	C518	1-104-665-11	ELECT 100MF	20% 10V
C255	1-163-037-11	CERAMIC CHIP	0.022MF 10%	50V	C519	1-102-212-00	CERAMIC 820PF	10% 500V
C256	1-164-004-11	CERAMIC CHIP	0.1MF 10%	25V	C521	1-126-934-11	ELECT 220MF	20% 16V
C259	1-126-933-11	ELECT	100MF	20% 16V	C522	1-126-933-11	ELECT 100MF	20% 16V
C264	1-164-505-11	CERAMIC CHIP	2.2MF	16V	C523	1-102-002-00	CERAMIC 680PF	10% 500V
C265	1-164-505-11	CERAMIC CHIP	2.2MF	16V	C524	1-126-967-11	ELECT 47MF	20% 50V
C301	1-126-935-11	ELECT	470MF	20% 16V	C526	1-130-495-00	MYLAR 0.1MF	5% 50V
C302	1-163-005-11	CERAMIC CHIP	470PF 10%	50V	C527	1-102-820-00	CERAMIC 330PF	5% 50V
C303	1-126-964-11	ELECT	10MF	20% 50V	C528	1-162-134-11	CERAMIC 470PF	10% 2KV
C304	1-126-967-11	ELECT	47MF	20% 50V	C530	1-137-372-11	FILM 0.022MF	5% 50V
C305	1-164-004-11	CERAMIC CHIP	0.1MF 10%	25V	C531	1-126-961-11	ELECT 2.2MF	20% 50V
C306	1-163-233-11	CERAMIC CHIP	18PF 5%	50V	C532	1-126-941-11	ELECT 470MF	20% 25V
C307	1-163-233-11	CERAMIC CHIP	18PF 5%	50V	C533	1-126-941-11	ELECT 470MF	20% 25V
C308	1-163-259-91	CERAMIC CHIP	220PF 5%	50V	C536	1-136-165-00	FILM 0.1MF	5% 50V
C309	1-126-957-11	ELECT	0.22MF 20%	50V	C537	1-126-969-11	ELECT 220MF	20% 50V
C310	1-126-963-11	ELECT	4.7MF	20% 50V	C538	1-136-076-00	FILM 0.0085MF	3% 2KV
C311	1-126-964-11	ELECT	10MF	20% 50V	C539	1-129-746-91	FILM 0.039MF	5% 400V
C312	1-164-346-11	CERAMIC CHIP	1MF	16V	C540	1-136-171-00	FILM 0.33MF	5% 50V
C313	1-164-346-11	CERAMIC CHIP	1MF	16V	C546	1-165-319-11	CERAMIC CHIP 0.1MF	50V
C315	1-164-004-11	CERAMIC CHIP	0.1MF 10%	25V	C549	1-163-017-00	CERAMIC CHIP 0.0047MF	10% 50V
C316	1-126-967-11	ELECT	47MF	20% 50V	C550	1-106-220-00	MYLAR 0.1MF	10% 100V
C317	1-164-004-11	CERAMIC CHIP	0.1MF 10%	25V	C551	1-126-960-11	ELECT 1MF	20% 50V
C318	1-163-031-11	CERAMIC CHIP	0.01MF	50V	C552	1-162-116-00	CERAMIC 680PF	10% 2KV
C319	1-163-031-11	CERAMIC CHIP	0.01MF	50V	C553	1-162-116-00	CERAMIC 680PF	10% 2KV
C320	1-163-031-11	CERAMIC CHIP	0.01MF	50V	C554	1-137-417-11	MYLAR 0.0047MF	10% 200V
C322	1-163-005-11	CERAMIC CHIP	470PF 10%	50V	C556	1-126-941-11	ELECT 470MF	20% 25V
C324	1-163-017-00	CERAMIC CHIP	0.0047MF 10%	50V	C557	1-126-941-11	ELECT 470MF	20% 25V
C325	1-126-960-11	ELECT	1MF	20% 50V	C558	1-123-024-21	ELECT 33MF	160V
C327	1-126-965-11	ELECT	22MF	20% 50V	C560	1-102-228-00	CERAMIC 470PF	10% 500V
C328	1-164-004-11	CERAMIC CHIP	0.1MF 10%	25V	C561	1-136-557-11	FILM 0.0033MF	5% 630V
C330	1-164-004-11	CERAMIC CHIP	0.1MF 10%	25V	C562	1-102-228-00	CERAMIC 470PF	10% 500V
C331	1-247-807-31	CARBON	100 5%	1/4W	C564	1-163-038-91	CERAMIC CHIP 0.1MF	25V
C332	1-126-963-11	ELECT	4.7MF	20% 50V	C565	1-107-655-11	ELECT 47MF	20% 250V
C335	1-164-004-11	CERAMIC CHIP	0.1MF 10%	25V	C566	1-102-244-00	CERAMIC 220PF	10% 500V
C336	1-164-004-11	CERAMIC CHIP	0.1MF 10%	25V	C567	1-115-521-11	FILM 0.82MF	5% 250V
C337	1-126-961-11	ELECT	2.2MF	20% 50V	C568	1-102-228-00	CERAMIC 470PF	10% 500V
C338	1-163-017-00	CERAMIC CHIP	0.0047MF 10%	50V	C570	1-115-520-11	FILM 0.68MF	5% 250V
C341	1-115-340-11	CERAMIC CHIP	0.22MF 10%	25V	C573	1-108-427-61	MYLAR 0.033MF	10% 200V
C342	1-163-259-91	CERAMIC CHIP	220PF 5%	50V	C574	1-107-636-11	ELECT 10MF	20% 160V
C401	1-164-346-11	CERAMIC CHIP	1MF	16V	C576	1-130-495-00	MYLAR 0.1MF	5% 50V
C402	1-164-346-11	CERAMIC CHIP	1MF	16V	C577	1-106-395-00	MYLAR 0.15MF	10% 200V
C403	1-163-005-11	CERAMIC CHIP	470PF 10%	50V	C582	1-164-004-11	CERAMIC CHIP 0.1MF	10% 25V
C404	1-163-005-11	CERAMIC CHIP	470PF 10%	50V	C600 $\Delta$	1-104-705-51	FILM 0.1MF	20% 250V
C405	1-126-935-11	ELECT	470MF	20% 16V	C604	1-163-009-11	CERAMIC CHIP 0.001MF	10% 50V
C406	1-164-346-11	CERAMIC CHIP	1MF	16V	C605 $\Delta$	1-127-942-51	CERAMIC 330PF	10% 250V
C407	1-164-346-11	CERAMIC CHIP	1MF	16V	C606 $\Delta$	1-127-942-51	CERAMIC 330PF	10% 250V
C408	1-163-133-00	CERAMIC CHIP	470PF 5%	50V	C607	1-161-830-00	CERAMIC 0.0047MF	99% 500V
C409	1-126-963-11	ELECT	4.7MF	20% 50V	C608	1-161-830-00	CERAMIC 0.0047MF	99% 500V
C415	1-163-133-00	CERAMIC CHIP	470PF 5%	50V	C609	1-126-968-11	ELECT 100MF	20% 50V

**A (KV-HF51P50)**

REF. NO.	PART NO.	DESCRIPTION	REMARK	REF. NO.	PART NO.	DESCRIPTION	REMARK
C610	1-126-964-11	ELECT	10MF 20%	50V	CN306	* 1-564-510-11	PLUG, CONNECTOR 7P
C611	1-161-830-00	CERAMIC	0.0047MF 99%	500V	CN505	1-508-765-00	PIN, CONNECTOR (5MM PITCH) 3P
C612	1-161-830-00	CERAMIC	0.0047MF 99%	500V	CN506	4-352-844-01	PIN, LEAD, COATING
C613	1-117-752-11	ELECT(BLOCK)	330MF 20%	450V	CN507	* 1-564-507-11	PLUG, CONNECTOR 4P
C614	1-126-964-11	ELECT	10MF 20%	50V	CN601	* 1-580-843-11	PIN, CONNECTOR (POWER)
C616	1-130-202-00	FILM	0.022MF 10%	400V	CN602	* 1-508-786-00	PIN, CONNECTOR (5MM PITCH) 2P
C617	1-107-792-11	CERAMIC	100PF 5%	1KV	CN604	* 1-573-963-11	PIN, CONNECTOR (PC BOARD) 3P
C618	1-125-893-11	FILM	680PF 3%	1.5KV	CN609	* 1-508-784-21	PIN, CONNECTOR (5MM PITCH) 1P
C619	1-119-886-51	CERAMIC	470PF 10%	250V	CN901	* 1-564-507-11	PLUG, CONNECTOR 4P
C620	1-163-133-00	CERAMIC CHIP	470PF 5%	50V			
C621	1-102-114-00	CERAMIC	470PF 10%	50V		<DIODE>	
C622	1-102-074-00	CERAMIC	0.001MF 10%	50V	D001	8-719-988-61	DIODE 1SS355TE-17
C623	1-104-665-11	ELECT	100MF 20%	25V	D005	8-719-988-61	DIODE 1SS355TE-17
C624	1-104-331-11	CERAMIC	0.0022MF 10%	1KV	D006	8-719-988-61	DIODE 1SS355TE-17
C627	1-102-002-00	CERAMIC	680PF 10%	500V	D203	8-719-914-42	DIODE DA204K
C628	1-126-942-61	ELECT	1000MF 20%	25V	D300	1-216-295-91	SHORT 0
C629	1-126-964-11	ELECT	10MF 20%	50V	D301	8-719-988-61	DIODE 1SS355TE-17
C630	1-123-024-21	ELECT	33MF 160V		D306	8-719-988-61	DIODE 1SS355TE-17
C633	1-104-999-11	MYLAR	0.1MF 10%	200V	D307	8-719-988-61	DIODE 1SS355TE-17
C634	1-126-933-11	ELECT	100MF 20%	16V	D308	8-719-988-61	DIODE 1SS355TE-17
C635	1-104-665-11	ELECT	100MF 20%	10V	D309	8-719-159-10	DIODE RD5.1SB-T2
C636	1-104-760-11	CERAMIC CHIP	0.047MF 10%	50V	D311	8-719-988-61	DIODE 1SS355TE-17
C639	1-164-004-11	CERAMIC CHIP	0.1MF 10%	25V	D312	8-719-988-61	DIODE 1SS355TE-17
C640	1-164-004-11	CERAMIC CHIP	0.1MF 10%	25V	D313	8-719-988-61	DIODE 1SS355TE-17
C641	1-102-002-00	CERAMIC	680PF 10%	500V	D314	8-719-988-61	DIODE 1SS355TE-17
C642	1-126-943-11	ELECT	2200MF 20%	25V	D315	8-719-988-61	DIODE 1SS355TE-17
C643	1-104-665-11	ELECT	100MF 20%	10V	D316	8-719-069-57	DIODE UDZS-TE17-6.8B
C644	1-104-331-11	CERAMIC	0.0022MF 10%	1KV	D401	8-719-158-35	DIODE RD9.1SB
C645	1-137-605-11	FILM	0.01MF 10%	250V	D402	8-719-158-35	DIODE RD9.1SB
C646	1-107-679-41	ELECT	10MF 20%	450V	D403	8-719-158-35	DIODE RD9.1SB
C647	1-163-275-11	CERAMIC CHIP	0.001MF 5%	50V	D404	8-719-158-35	DIODE RD9.1SB
C649	1-126-940-11	ELECT	330MF 20%	25V	D405	8-719-158-35	DIODE RD9.1SB
C650	1-163-275-11	CERAMIC CHIP	0.001MF 5%	50V	D406	8-719-158-35	DIODE RD9.1SB
C651	1-163-133-00	CERAMIC CHIP	470PF 5%	50V	D504	8-719-302-43	DIODE EL1Z
C652	1-126-965-11	ELECT	22MF 20%	50V	D505	8-719-988-61	DIODE 1SS355TE-17
C653	1-104-664-11	ELECT	47MF 20%	25V	D506	8-719-911-19	DIODE 1SS119-25
C657	1-101-821-00	CERAMIC	0.0022MF 500V		D507	8-719-988-61	DIODE 1SS355TE-17
C658	1-164-004-11	CERAMIC CHIP	0.1MF 10%	25V	D508	8-719-988-61	DIODE 1SS355TE-17
C901	1-136-153-00	FILM	0.01MF 5%	50V	D509	1-216-073-00	RES.CHIP 10K 5% 1/10W
C902	1-136-153-00	FILM	0.01MF 5%	50V	D510	8-719-988-61	DIODE 1SS355TE-17
C905	1-126-963-11	ELECT	4.7MF 20%	50V	D511	8-719-988-61	DIODE 1SS355TE-17
C906	1-164-346-11	CERAMIC CHIP	1MF 16V		D512	8-719-988-61	DIODE 1SS355TE-17
C907	1-163-133-00	CERAMIC CHIP	470PF 5%	50V	D513	8-719-908-03	DIODE GP08D
C908	1-163-133-00	CERAMIC CHIP	470PF 5%	50V	D517	8-719-945-80	DIODE ERC06-15S
C909	1-164-346-11	CERAMIC CHIP	1MF 16V		D518	8-719-900-26	DIODE ERD29-08J
C910	1-126-967-11	ELECT	47MF 20%	50V	D521	8-719-302-43	DIODE EL1Z
C911	1-126-967-11	ELECT	47MF 20%	50V	D522	8-719-302-43	DIODE EL1Z
C912	1-164-004-11	CERAMIC CHIP	0.1MF 10%	25V	D523	8-719-302-43	DIODE EL1Z
C913	1-126-933-11	ELECT	100MF 20%	16V	D527	8-719-908-03	DIODE GP08D
C914	1-163-133-00	CERAMIC CHIP	470PF 5%	50V	D528	8-719-908-03	DIODE GP08D
		<CONNECTOR>			D531	8-719-988-61	DIODE 1SS355TE-17
CN104	1-695-915-11	TAB (CONTACT)			D532	8-719-988-61	DIODE 1SS355TE-17
CN202	* 1-785-608-11	PIN, CONNECTOR 4P			D602	8-719-911-19	DIODE 1SS119-25
CN203	* 1-564-506-11	PLUG, CONNECTOR 3P			D603	8-719-150-92	DIODE RD33EB3T
CN204	* 1-564-506-11	PLUG, CONNECTOR 3P			D604	8-719-028-72	DIODE RGP02-17EL-6433
CN305	* 1-564-509-11	PLUG, CONNECTOR 6P			D605	8-719-510-53	DIODE D4SB60L

**A (KV-HF51P50)**

REF. NO.	PART NO.	DESCRIPTION	REMARK	REF. NO.	PART NO.	DESCRIPTION	REMARK
D606	8-719-108-18	THYRISTOR 5P6M		IC301	8-752-088-39	IC CXA2130S	
D607	8-719-404-50	DIODE MA111-TX		IC502	8-759-700-07	IC NJM2903M	
D608	8-719-110-53	DIODE RD20ESB2		IC503	8-759-980-58	IC TDA8172	
D609	8-719-311-31	DIODE RU-1P		IC601	8-749-013-75	IC STR-F6654	
D610	8-719-043-76	DIODE AK04V0		IC602	8-749-920-61	IC SE-135N	
D611	8-719-046-74	DIODE AU-01Z-V1		IC603	8-759-701-59	IC NJM78M09FA	
D613	8-719-046-74	DIODE AU-01Z-V1		IC604	8-759-231-53	IC TA7805S	
D614	8-719-046-74	DIODE AU-01Z-V1		IC901	8-742-014-11	HYB IC SBX1981-51	
D618	8-719-067-18	DIODE RN4Z				<JACK>	
D620	8-719-110-72	DIODE RD30ESB2		J401	1-779-850-11	JACK BLOCK, PIN 6P	
D622	8-719-071-39	DIODE FMU-G26S		J901	1-770-786-11	JACK	
D623	8-719-978-65	DIODE DTZ-TT11-15B		J902	1-770-329-11	JACK, PIN 3P	
D624	8-719-404-50	DIODE MA111-TX				<CHIP CONDUCTOR>	
D625	8-719-158-39	DIODE RD10SB		JR002	1-216-295-91	SHORT	0
D627	8-719-073-84	DIODE 31DQ06-FC5		JR003	1-216-295-91	SHORT	0
D628	8-719-911-19	DIODE ISS119-25		JR004	1-216-295-91	SHORT	0
D631	8-719-068-00	DIODE ERC04-06SE		JR005	1-216-295-91	SHORT	0
D632	8-719-068-00	DIODE ERC04-06SE		JR006	1-216-295-91	SHORT	0
D633	8-719-948-45	DIODE ERA22-08		JR007	1-216-295-91	SHORT	0
D634	8-719-404-50	DIODE MA111-TX		JR008	1-216-295-91	SHORT	0
D635	8-719-404-50	DIODE MA111-TX		JR009	1-216-295-91	SHORT	0
D636	8-719-510-02	DIODE D1NS4		JR010	1-216-295-91	SHORT	0
D637	8-719-109-96	DIODE RD6.8ESB1		JR011	1-216-295-91	SHORT	0
D638	8-719-510-48	DIODE D1N20R		JR012	1-216-295-91	SHORT	0
D901	8-719-158-35	DIODE RD9.1SB		JR013	1-216-295-91	SHORT	0
D902	8-719-158-35	DIODE RD9.1SB		JR014	1-216-295-91	SHORT	0
D903	8-719-158-35	DIODE RD9.1SB		JR015	1-216-295-91	SHORT	0
D904	8-719-158-35	DIODE RD9.1SB		JR016	1-216-295-91	SHORT	0
D905	8-719-158-35	DIODE RD9.1SB		JR018	1-216-295-91	SHORT	0
D906	8-719-045-19	DIODE SPB-26MVWF		JR019	1-216-295-91	SHORT	0
		<CONNECTOR>		JR102	1-216-295-91	SHORT	0
DY1	* 1-580-798-11	CONNECTOR PIN (DY) 6P		JR109	1-216-295-91	SHORT	0
		<FERRITE BEAD>		JR202	1-216-295-91	SHORT	0
FB103	1-410-397-21	FERRITE	1.1UH	JR301	1-216-295-91	SHORT	0
FB501	1-410-397-21	FERRITE	1.1UH	JR303	1-216-295-91	SHORT	0
FB502	1-410-397-21	FERRITE	1.1UH	JR401	1-216-295-91	SHORT	0
FB600	1-410-397-21	FERRITE	1.1UH	JR403	1-216-295-91	SHORT	0
FB601	1-410-397-21	FERRITE	1.1UH	JR404	1-216-295-91	SHORT	0
FB602	1-410-397-21	FERRITE	1.1UH	JR405	1-216-295-91	SHORT	0
FB603	1-410-397-21	FERRITE	1.1UH	JR500	1-216-295-91	SHORT	0
FB604	1-410-397-21	FERRITE	1.1UH	JR501	1-216-295-91	SHORT	0
FB607	1-410-397-21	FERRITE	1.1UH	JR600	1-216-295-91	SHORT	0
FB608	1-412-911-31	FERRITE	0UH			<COIL>	
FB611	1-410-397-21	FERRITE	1.1UH	L002	1-414-856-11	INDUCTOR	10UH
FB613	1-410-397-21	FERRITE	1.1UH	L003	1-414-180-11	INDUCTOR	3.3UH
FB615	1-410-397-21	FERRITE	1.1UH	L005	1-414-233-22	INDUCTOR CHIP	0UH
		<IC>		L101	1-414-856-11	INDUCTOR	10UH
IC001	8-752-905-21	IC CXP86449-615S		L102	1-414-856-11	INDUCTOR	10UH
IC002	8-759-371-21	IC MM1319AFBE		L103	1-414-856-11	INDUCTOR	10UH
IC003	8-759-370-34	IC ST24C08FB6		L104	1-414-856-11	INDUCTOR	10UH
IC201	8-759-336-30	IC TA8223K		L105	1-414-856-11	INDUCTOR	10UH
IC203	8-759-553-40	IC TDA7429S		L204	1-414-856-11	INDUCTOR	10UH
				L301	1-414-189-31	INDUCTOR	100UH

The components identified by shading  
and mark  $\Delta$  are critical for safety.  
Replace only with part number specified.

**A (KV-HF51P50)**

REF. NO.	PART NO.	DESCRIPTION	REMARK	REF. NO.	PART NO.	DESCRIPTION	REMARK
L302	1-414-185-41	INDUCTOR	22UH	Q506	8-729-140-96	TRANSISTOR 2SD774-34	
L501	1-412-525-31	INDUCTOR	10UH	Q507	8-729-216-22	TRANSISTOR 2SA1162-G	
L502	1-422-613-11	COIL, AIR CORE		Q509	8-729-230-49	TRANSISTOR 2SC2712-YG	
L503	1-412-525-31	INDUCTOR	10UH	Q511	8-729-048-07	TRANSISTOR 2SD2578-CA	
L504	1-412-525-31	INDUCTOR	10UH	Q601	8-729-023-22	TRANSISTOR 2SD2114K	
L505	1-412-525-31	INDUCTOR	10UH	Q602	8-729-230-49	TRANSISTOR 2SC2712-YG	
L506	1-412-525-31	INDUCTOR	10UH	Q603	8-729-424-08	TRANSISTOR UN2111	
L507	1-459-111-00	INDUCTOR	10MMH	Q604	8-729-200-17	TRANSISTOR 2SA1091-O	
L508	1-412-525-31	INDUCTOR	10UH	Q605	8-729-044-30	TRANSISTOR 2SK2845-LB102	
L509	1-459-390-00	INDUCTOR	390UH	Q606	8-729-230-49	TRANSISTOR 2SC2712-YG	
L510	1-416-972-11	COIL, HORIZONTAL LINEARITY		Q607	8-729-922-37	TRANSISTOR 2SD2144S-UVW	
L512	1-412-549-31	INDUCTOR	1MMH	Q608	8-729-230-49	TRANSISTOR 2SC2712-YG	
L513	1-412-549-31	INDUCTOR	1MMH	Q901	8-729-421-19	TRANSISTOR UN2213	
L515	1-459-104-00	COIL, WITH CORE		Q902	8-729-421-19	TRANSISTOR UN2213	
L518	1-408-611-31	INDUCTOR	47UH				
L601	1-412-527-11	INDUCTOR	15UH			<RESISTOR>	
L901	1-408-603-31	INDUCTOR	10UH	R001	1-414-233-22	INDUCTOR CHIP	0UH
L902	1-408-603-31	INDUCTOR	10UH	R002	1-216-025-91	RES,CHIP	100 5% 1/10W
L905	1-414-856-11	INDUCTOR	10UH	R003	1-216-073-00	RES,CHIP	10K 5% 1/10W
		<PHOTO COUPLER>		R004	1-216-025-91	RES,CHIP	100 5% 1/10W
PH600 $\Delta$	8-749-924-35	PHOTO COUPLER ON3171-R		R005	1-216-025-91	RES,CHIP	100 5% 1/10W
		<IC LINK>		R007	1-216-295-91	SHORT	0
PS200	1-532-675-21	LINK, IC 1.5A/150V		R008	1-216-065-91	RES,CHIP	4.7K 5% 1/10W
		<TRANSISTOR>		R010	1-216-065-91	RES,CHIP	4.7K 5% 1/10W
Q002	8-729-230-49	TRANSISTOR 2SC2712-YG		R011	1-216-065-91	RES,CHIP	4.7K 5% 1/10W
Q003	8-729-424-08	TRANSISTOR UN2111		R012	1-216-065-91	RES,CHIP	4.7K 5% 1/10W
Q004	8-729-421-22	TRANSISTOR UN2211		R013	1-216-065-91	RES,CHIP	4.7K 5% 1/10W
Q101	8-729-230-49	TRANSISTOR 2SC2712-YG		R014	1-216-025-91	RES,CHIP	100 5% 1/10W
Q201	8-729-424-67	TRANSISTOR UN2216		R015	1-216-025-91	RES,CHIP	100 5% 1/10W
Q202	8-729-424-67	TRANSISTOR UN2216		R016	1-216-025-91	RES,CHIP	100 5% 1/10W
Q203	8-729-421-19	TRANSISTOR UN2213		R017	1-216-049-91	RES,CHIP	1K 5% 1/10W
Q204	8-729-216-22	TRANSISTOR 2SA1162-G		R018	1-216-033-00	RES,CHIP	220 5% 1/10W
Q205	8-729-421-19	TRANSISTOR UN2213		R019	1-216-073-00	RES,CHIP	10K 5% 1/10W
Q206	8-729-421-19	TRANSISTOR UN2213		R021	1-216-073-00	RES,CHIP	10K 5% 1/10W
Q207	8-729-421-19	TRANSISTOR UN2213		R022	1-216-033-00	RES,CHIP	220 5% 1/10W
Q301	8-729-216-22	TRANSISTOR 2SA1162-G		R024	1-216-057-00	RES,CHIP	2.2K 5% 1/10W
Q302	8-729-230-49	TRANSISTOR 2SC2712-YG		R025	1-216-057-00	RES,CHIP	2.2K 5% 1/10W
Q303	8-729-216-22	TRANSISTOR 2SA1162-G		R026	1-216-057-00	RES,CHIP	2.2K 5% 1/10W
Q305	8-729-216-22	TRANSISTOR 2SA1162-G		R027	1-216-073-00	RES,CHIP	10K 5% 1/10W
Q306	8-729-216-22	TRANSISTOR 2SA1162-G		R029	1-216-049-91	RES,CHIP	1K 5% 1/10W
Q307	8-729-230-49	TRANSISTOR 2SC2712-YG		R031	1-216-049-91	RES,CHIP	1K 5% 1/10W
Q308	8-729-216-22	TRANSISTOR 2SA1162-G		R035	1-216-025-91	RES,CHIP	100 5% 1/10W
Q312	8-729-216-22	TRANSISTOR 2SA1162-G		R036	1-216-025-91	RES,CHIP	100 5% 1/10W
Q313	8-729-230-49	TRANSISTOR 2SC2712-YG		R037	1-216-025-91	RES,CHIP	100 5% 1/10W
Q315	8-729-421-19	TRANSISTOR UN2213		R040	1-216-025-91	RES,CHIP	100 5% 1/10W
Q401	8-729-424-67	TRANSISTOR UN2216		R041	1-216-025-91	RES,CHIP	100 5% 1/10W
Q402	8-729-424-67	TRANSISTOR UN2216		R042	1-216-295-91	SHORT	0
Q403	8-729-216-22	TRANSISTOR 2SA1162-G		R043	1-216-025-91	RES,CHIP	100 5% 1/10W
Q404	8-729-216-22	TRANSISTOR 2SA1162-G		R044	1-216-025-91	RES,CHIP	100 5% 1/10W
Q503	8-729-230-49	TRANSISTOR 2SC2712-YG		R045	1-414-233-22	INDUCTOR CHIP	0UH
Q505	8-729-931-45	TRANSISTOR IRF614		R046	1-216-049-91	RES,CHIP	1K 5% 1/10W
				R047	1-414-233-22	INDUCTOR CHIP	0UH
				R048	1-216-073-00	RES,CHIP	10K 5% 1/10W
				R050	1-216-073-00	RES,CHIP	10K 5% 1/10W
				R053	1-216-049-91	RES,CHIP	1K 5% 1/10W
				R055	1-216-073-00	RES,CHIP	10K 5% 1/10W



**A (KV-HF51P50)**

REF. NO.	PART NO.	DESCRIPTION	REMARK	REF. NO.	PART NO.	DESCRIPTION	REMARK				
R056	1-216-073-00	RES,CHIP	10K	5%	1/10W	R316	1-216-053-00	RES,CHIP	1.5K	5%	1/10W
R061	1-216-033-00	RES,CHIP	220	5%	1/10W	R317	1-216-077-00	RES,CHIP	15K	5%	1/10W
R062	1-216-041-00	RES,CHIP	470	5%	1/10W	R318	1-216-051-00	RES,CHIP	1.2K	5%	1/10W
R063	1-216-037-00	RES,CHIP	330	5%	1/10W	R319	1-216-025-91	RES,CHIP	100	5%	1/10W
R064	1-216-037-00	RES,CHIP	330	5%	1/10W	R320	1-216-065-91	RES,CHIP	4.7K	5%	1/10W
R065	1-216-037-00	RES,CHIP	330	5%	1/10W	R321	1-216-073-00	RES,CHIP	10K	5%	1/10W
R066	1-216-049-91	RES,CHIP	1K	5%	1/10W	R322	1-216-033-00	RES,CHIP	220	5%	1/10W
R105	1-216-295-91	SHORT	0			R326	1-216-295-91	SHORT	0		
R109	1-216-041-00	RES,CHIP	470	5%	1/10W	R331	1-216-295-91	SHORT	0		
R111	1-216-025-91	RES,CHIP	100	5%	1/10W	R332	1-216-033-00	RES,CHIP	220	5%	1/10W
R112	1-216-025-91	RES,CHIP	100	5%	1/10W	R333	1-216-073-00	RES,CHIP	10K	5%	1/10W
R113	1-216-047-91	RES,CHIP	820	5%	1/10W	R334	1-216-129-00	RES,CHIP	2.2M	5%	1/10W
R202	1-216-053-00	RES,CHIP	1.5K	5%	1/10W	R335	1-216-045-00	RES,CHIP	680	5%	1/10W
R203	1-216-063-91	RES,CHIP	3.9K	5%	1/10W	R338	1-216-033-00	RES,CHIP	220	5%	1/10W
R204	1-216-061-00	RES,CHIP	3.3K	5%	1/10W	R340	1-216-025-91	RES,CHIP	100	5%	1/10W
R205	1-216-061-00	RES,CHIP	3.3K	5%	1/10W	R345	1-216-081-00	RES,CHIP	22K	5%	1/10W
R206	1-216-063-91	RES,CHIP	3.9K	5%	1/10W	R348	1-216-675-11	METAL CHIP	10K	0.50%	1/10W
R207	1-216-053-00	RES,CHIP	1.5K	5%	1/10W	R349	1-216-073-00	RES,CHIP	10K	5%	1/10W
R208	1-216-061-00	RES,CHIP	3.3K	5%	1/10W	R350	1-216-061-00	RES,CHIP	3.3K	5%	1/10W
R209	1-216-061-00	RES,CHIP	3.3K	5%	1/10W	R351	1-216-053-00	RES,CHIP	1.5K	5%	1/10W
R210	1-216-027-00	RES,CHIP	120	5%	1/10W	R354	1-216-057-00	RES,CHIP	2.2K	5%	1/10W
R212	1-216-027-00	RES,CHIP	120	5%	1/10W	R355	1-216-057-00	RES,CHIP	2.2K	5%	1/10W
R213	1-216-073-00	RES,CHIP	10K	5%	1/10W	R356	1-216-057-00	RES,CHIP	2.2K	5%	1/10W
R214	1-216-073-00	RES,CHIP	10K	5%	1/10W	R357	1-216-079-00	RES,CHIP	18K	5%	1/10W
R215	1-216-059-00	RES,CHIP	2.7K	5%	1/10W	R358	1-216-049-91	RES,CHIP	1K	5%	1/10W
R216	1-216-059-00	RES,CHIP	2.7K	5%	1/10W	R359	1-216-033-00	RES,CHIP	220	5%	1/10W
R217	1-216-067-00	RES,CHIP	5.6K	5%	1/10W	R360	1-216-033-00	RES,CHIP	220	5%	1/10W
R218	1-216-067-00	RES,CHIP	5.6K	5%	1/10W	R361	1-216-073-00	RES,CHIP	10K	5%	1/10W
R219	1-216-025-91	RES,CHIP	100	5%	1/10W	R362	1-216-075-00	RES,CHIP	12K	5%	1/10W
R220	1-216-025-91	RES,CHIP	100	5%	1/10W	R363	1-216-079-00	RES,CHIP	18K	5%	1/10W
R221	1-216-295-91	SHORT	0			R364	1-216-295-91	SHORT	0		
R222	1-216-295-91	SHORT	0			R365	1-216-033-00	RES,CHIP	220	5%	1/10W
R225	1-216-033-00	RES,CHIP	220	5%	1/10W	R366	1-216-073-00	RES,CHIP	10K	5%	1/10W
R226	1-216-033-00	RES,CHIP	220	5%	1/10W	R367	1-216-073-00	RES,CHIP	10K	5%	1/10W
R227	1-216-033-00	RES,CHIP	220	5%	1/10W	R370	1-216-033-00	RES,CHIP	220	5%	1/10W
R228	1-249-389-11	CARBON	4.7	5%	1/4W	R376	1-216-081-00	RES,CHIP	22K	5%	1/10W
R229	1-216-073-00	RES,CHIP	10K	5%	1/10W	R377	1-216-121-91	RES,CHIP	1M	5%	1/10W
R230	1-216-069-00	RES,CHIP	6.8K	5%	1/10W	R378	1-216-031-00	RES,CHIP	180	5%	1/10W
R231	1-216-295-91	SHORT	0			R401	1-216-049-91	RES,CHIP	1K	5%	1/10W
R234	1-249-389-11	CARBON	4.7	5%	1/4W	R402	1-216-073-00	RES,CHIP	10K	5%	1/10W
R235	1-216-069-00	RES,CHIP	6.8K	5%	1/10W	R403	1-216-073-00	RES,CHIP	10K	5%	1/10W
R236	1-216-069-00	RES,CHIP	6.8K	5%	1/10W	R404	1-216-073-00	RES,CHIP	10K	5%	1/10W
R237	1-216-308-00	RES,CHIP	4.7	5%	1/10W	R405	1-216-049-91	RES,CHIP	1K	5%	1/10W
R301	1-216-073-00	RES,CHIP	10K	5%	1/10W	R406	1-216-073-00	RES,CHIP	10K	5%	1/10W
R302	1-216-295-91	SHORT	0			R407	1-216-049-91	RES,CHIP	1K	5%	1/10W
R303	1-216-049-91	RES,CHIP	1K	5%	1/10W	R408	1-216-049-91	RES,CHIP	1K	5%	1/10W
R304	1-216-073-00	RES,CHIP	10K	5%	1/10W	R409	1-216-041-00	RES,CHIP	470	5%	1/10W
R305	1-216-051-00	RES,CHIP	1.2K	5%	1/10W	R410	1-216-113-00	RES,CHIP	470K	5%	1/10W
R306	1-216-073-00	RES,CHIP	10K	5%	1/10W	R411	1-216-113-00	RES,CHIP	470K	5%	1/10W
R307	1-216-295-91	SHORT	0			R412	1-216-041-00	RES,CHIP	470	5%	1/10W
R308	1-216-025-91	RES,CHIP	100	5%	1/10W	R413	1-216-021-00	RES,CHIP	68	5%	1/10W
R309	1-216-025-91	RES,CHIP	100	5%	1/10W	R414	1-216-113-00	RES,CHIP	470K	5%	1/10W
R310	1-216-025-91	RES,CHIP	100	5%	1/10W	R415	1-216-113-00	RES,CHIP	470K	5%	1/10W
R311	1-216-017-91	RES,CHIP	47	5%	1/10W	R416	1-216-077-00	RES,CHIP	15K	5%	1/10W
R312	1-216-041-00	RES,CHIP	470	5%	1/10W	R417	1-216-077-00	RES,CHIP	15K	5%	1/10W
R313	1-216-053-00	RES,CHIP	1.5K	5%	1/10W	R418	1-216-113-00	RES,CHIP	470K	5%	1/10W
R314	1-216-045-00	RES,CHIP	680	5%	1/10W	R419	1-216-022-00	RES,CHIP	75	5%	1/10W
						R426	1-216-033-00	RES,CHIP	220	5%	1/10W

The components identified by shading and mark  $\Delta$  are critical for safety. Replace only with part number specified.

**A (KV-HF51P50)**

REF. NO.	PART NO.	DESCRIPTION		REMARK	REF. NO.	PART NO.	DESCRIPTION		REMARK
R505	1-216-099-00	RES,CHIP	120K	5% 1/10W	R593	1-260-288-11	CARBON	0.47	5% 1/2W F
R506	1-216-085-00	RES,CHIP	33K	5% 1/10W	R594	1-260-288-11	CARBON	0.47	5% 1/2W F
R507	1-249-389-11	CARBON	4.7	5% 1/4W F	R596	1-215-922-11	METAL OXIDE	6.8K	5% 3W F
R508	1-215-910-00	METAL OXIDE	68	5% 3W F	R597	1-247-750-11	CARBON	680	5% 1/2W F
R509	1-215-911-11	METAL OXIDE	100	5% 3W F	R598	1-249-438-11	CARBON	56K	5% 1/4W
R510	1-215-885-00	METAL OXIDE	68	5% 2W F	R599	1-249-389-11	CARBON	4.7	5% 1/4W
R511	1-215-911-11	METAL OXIDE	100	5% 3W F	R600	1-249-438-11	CARBON	56K	5% 1/4W
R516	1-216-081-00	RES,CHIP	22K	5% 1/10W	R601	1-249-418-11	CARBON	1.2K	5% 1/4W F
R518	1-247-807-31	CARBON	100	5% 1/4W	R602	1-249-389-11	CARBON	4.7	5% 1/4W F
R520	1-215-445-00	METAL	10K	1% 1/4W	R603	1-215-485-00	METAL	470K	1% 1/4W
R522	1-216-675-11	METAL CHIP	10K	0.50% 1/10W	R604	1-216-097-91	RES,CHIP	100K	5% 1/10W
R523	1-249-411-11	CARBON	330	5% 1/4W	R607	1-249-425-11	CARBON	4.7K	5% 1/4W
R525	1-216-699-11	METAL CHIP	100K	0.50% 1/10W	R608	1-240-205-91	CARBON	22M	5% 1/2W
R526	1-208-798-11	RES,CHIP	4.7K	0.50% 1/10W	R609	1-216-057-00	RES,CHIP	2.2K	5% 1/10W
R527	1-216-001-00	RES,CHIP	10	5% 1/10W	R610	1-216-073-00	RES,CHIP	10K	5% 1/10W
R528	1-216-683-11	METAL CHIP	22K	0.50% 1/10W	R611	1-216-089-91	RES,CHIP	47K	5% 1/10W
R529	1-216-635-11	METAL CHIP	220	0.50% 1/10W	R612	1-216-045-00	RES,CHIP	680	5% 1/10W
R531	1-247-843-11	CARBON	3.3K	5% 1/4W	R614	1-216-041-00	RES,CHIP	470	5% 1/10W
R533	1-249-417-11	CARBON	1K	5% 1/4W	R615	1-216-350-11	METAL OXIDE	1.2	5% 1W F
R534	1-216-361-21	METAL OXIDE	0.22	5% 2W F	R616	1-260-302-51	CARBON	6.8	5% 1/2W F
R535	1-216-067-00	RES,CHIP	5.6K	5% 1/10W	R617	1-247-791-91	CARBON	22	5% 1/4W
R536	1-216-067-00	RES,CHIP	5.6K	5% 1/10W	R619	1-260-128-11	CARBON	270K	5% 1/2W
R537	1-216-683-11	METAL CHIP	22K	0.50% 1/10W	R620	1-215-915-11	METAL OXIDE	470	5% 3W F
R540	1-216-065-91	RES,CHIP	4.7K	5% 1/10W	R622	1-215-908-00	METAL OXIDE	33	5% 3W F
R541	1-216-065-91	RES,CHIP	4.7K	5% 1/10W	R623	1-216-095-00	RES,CHIP	82K	5% 1/10W
R542	1-216-295-91	SHORT	0		R624	1-216-089-91	RES,CHIP	47K	5% 1/10W
R543	1-249-426-11	CARBON	5.6K	5% 1/4W F	R626	1-216-049-91	RES,CHIP	1K	5% 1/10W
R545	1-216-077-00	RES,CHIP	15K	5% 1/10W	R627	1-240-251-11	CMT,MELF	6.8	5% 10W
R546	1-216-077-00	RES,CHIP	15K	5% 1/10W	R629	1-247-747-11	CARBON	470	5% 1/2W F
R547	1-216-085-00	RES,CHIP	33K	5% 1/10W	R630	1-249-429-11	CARBON	10K	5% 1/4W F
R549	1-215-451-00	METAL	18K	1% 1/4W	R631	1-216-089-91	RES,CHIP	47K	5% 1/10W
R550	1-216-097-91	RES,CHIP	100K	5% 1/10W	R632	1-202-933-61	FUSIBLE	0.1	10% 1/2W F
R551	1-249-421-11	CARBON	2.2K	5% 1/4W	R634 $\Delta$	1-218-265-91	METAL	8.2M	5% 1W
R552	1-216-057-00	RES,CHIP	2.2K	5% 1/10W	R635	1-216-492-21	METAL OXIDE	82K	5% 3W F
R553	1-215-457-00	METAL	33K	1% 1/4W	R636	1-215-924-00	METAL OXIDE	15K	5% 3W F
R554	1-215-457-00	METAL	33K	1% 1/4W	R637	1-216-492-21	METAL OXIDE	82K	5% 3W F
R556	1-215-437-00	METAL	4.7K	1% 1/4W	R639	1-216-363-00	METAL OXIDE	0.33	5% 2W F
R558	1-249-421-11	CARBON	2.2K	5% 1/4W	R640	1-249-415-11	CARBON	680	5% 1/4W
R559	1-249-429-11	CARBON	10K	5% 1/4W	R641	1-216-362-11	METAL OXIDE	0.27	5% 2W F
R560	1-216-073-00	RES,CHIP	10K	5% 1/10W	R642	1-249-419-11	CARBON	1.5K	5% 1/4W
R562	1-249-401-11	CARBON	47	5% 1/4W	R643	1-247-843-11	CARBON	3.3K	5% 1/4W
R565	1-216-073-00	RES,CHIP	10K	5% 1/10W	R644	1-249-419-11	CARBON	1.5K	5% 1/4W
R567	1-216-105-91	RES,CHIP	220K	5% 1/10W	R646	1-215-924-00	METAL OXIDE	15K	5% 3W F
R568	1-249-383-11	CARBON	1.5	5% 1/4W F	R647	1-249-401-11	CARBON	47	5% 1/4W
R570	1-216-069-00	RES,CHIP	6.8K	5% 1/10W	R648	1-216-057-00	RES,CHIP	2.2K	5% 1/10W
R571	1-215-437-00	METAL	4.7K	1% 1/4W	R649	1-249-417-11	CARBON	1K	5% 1/4W
R573	1-216-089-91	RES,CHIP	47K	5% 1/10W	R650	1-215-882-00	METAL OXIDE	22	5% 2W F
R577	1-215-913-11	METAL OXIDE	220	5% 3W F	R652	1-215-900-11	METAL OXIDE	22K	5% 2W F
R578	1-216-369-00	METAL OXIDE	1	5% 2W F	R653	1-215-873-00	METAL OXIDE	4.7K	5% 1W F
R579	1-216-097-91	RES,CHIP	100K	5% 1/10W	R657	1-260-127-11	CARBON	220K	5% 1/2W
R580	1-216-699-11	METAL CHIP	100K	0.50% 1/10W	R659	1-216-049-91	RES,CHIP	1K	5% 1/10W
R581	1-208-798-11	RES,CHIP	4.7K	0.50% 1/10W	R660	1-216-073-00	RES,CHIP	10K	5% 1/10W
R585	1-249-391-11	CARBON	6.8	5% 1/4W F	R661	1-215-873-00	METAL OXIDE	4.7K	5% 1W F
R588	1-215-888-00	METAL OXIDE	220	5% 2W F	R680	1-216-308-00	RES,CHIP	4.7	5% 1/10W
R589	1-215-888-00	METAL OXIDE	220	5% 2W F	R901	1-249-411-11	CARBON	330	5% 1/4W
R590	1-215-465-00	METAL	68K	1% 1/4W	R902	1-249-411-11	CARBON	330	5% 1/4W
R591	1-260-288-11	CARBON	0.47	5% 1/2W F	R903	1-216-022-00	RES,CHIP	75	5% 1/10W
					R904	1-216-033-00	RES,CHIP	220	5% 1/10W

The components identified by shading and mark  $\Delta$  are critical for safety. Replace only with part number specified.

**A (KV-XF21M80)****A (KV-HF51P50)**

REF. NO.	PART NO.	DESCRIPTION	REMARK
R905	1-216-113-00	RES,CHIP 470K	5% 1/10W
R906	1-216-077-00	RES,CHIP 15K	5% 1/10W
R907	1-216-113-00	RES,CHIP 470K	5% 1/10W
R908	1-216-077-00	RES,CHIP 15K	5% 1/10W
R909	1-216-065-91	RES,CHIP 4.7K	5% 1/10W
R910	1-216-065-91	RES,CHIP 4.7K	5% 1/10W
R911	1-216-067-00	RES,CHIP 5.6K	5% 1/10W
R912	1-216-041-00	RES,CHIP 470	5% 1/10W
R913	1-216-049-91	RES,CHIP 1K	5% 1/10W
R914	1-216-055-00	RES,CHIP 1.8K	5% 1/10W
R915	1-216-061-00	RES,CHIP 3.3K	5% 1/10W
R916	1-216-017-91	RES,CHIP 47	5% 1/10W
R917	1-216-041-00	RES,CHIP 470	5% 1/10W
R918	1-216-041-00	RES,CHIP 470	5% 1/10W

## &lt;RELAY&gt;

RY601  $\Delta$  1-755-266-11 RELAY, AC POWER

## &lt;SWITCH&gt;

S502	1-572-707-11	SWITCH, LEVER
S600 $\Delta$	1-571-433-31	SWITCH, PUSH (AC POWER)
S901	1-692-431-21	SWITCH, TACTILE
S902	1-692-431-21	SWITCH, TACTILE
S903	1-692-431-21	SWITCH, TACTILE
S904	1-692-431-21	SWITCH, TACTILE
S905	1-692-431-21	SWITCH, TACTILE
S906	1-692-431-21	SWITCH, TACTILE
S907	1-692-431-21	SWITCH, TACTILE

## &lt;TRANSFORMER&gt;

T501	1-437-195-11	TRANSFORMER, HORIZONTAL DRIVE
T503 $\Delta$	1-453-293-11	TRANSFORMER ASSY, (NX-1748//M3A4)
T601	1-424-682-11	TRANSFORMER, LINE FILTER
T603 $\Delta$	1-433-513-31	TRANSFORMER, CONVERTER (SRT)
T604 $\Delta$	1-431-852-11	TRANSFORMER, CONVERTER (SRT)

## &lt;THERMISTOR&gt;

THP600 1-810-961-11 THERMISTOR, POSITIVE

## &lt;TUNER&gt;

TU101 8-598-447-00 TUNER, FSS BTF-LG411

## &lt;CRYSTAL&gt;

X001	1-579-125-11	VIBRATOR, CERAMIC
X301	1-781-134-21	VIBRATOR, CRYSTAL
X302	1-781-132-21	VIBRATOR, CRYSTAL

REF. NO.	PART NO.	DESCRIPTION	REMARK
* A-1298-945-A		A BOARD, COMPLETE (KV-XF21M80(E))	*****
* A-1298-944-A		A BOARD, COMPLETE (KV-XF21M80(ME))	*****
* A-1298-933-A		A BOARD, COMPLETE (KV-XF21M80(VIETNAM))	*****
* 4-040-983-41		TERMINAL BOARD (D) (KV-XF21M80 (E/ME)ONLY)	
* 4-055-304-01		HOLDER, LED	
* 4-067-182-02		HOLDER, FBT (KV-XF21M80(VIETNAM))	
* 4-070-141-01		HOLDER, FBT (KV-XF21M80(E/ME))	
4-382-854-11		SCREW (M3X10), P, SW (+)	
4-382-854-21		SCREW (M3X14), P, SW (+)	
7-685-648-79		SCREW +BVTP 3X12 TYPE2 N-S	
<CAPACITOR>			
C004	1-163-001-11	CERAMIC CHIP 220PF	10% 50V
C005	1-163-001-11	CERAMIC CHIP 220PF	10% 50V
C006	1-164-004-11	CERAMIC CHIP 0.1MF	10% 25V
C007	1-126-933-11	ELECT 100MF	20% 16V
C008	1-163-251-11	CERAMIC CHIP 100PF	5% 50V
C010	1-163-251-11	CERAMIC CHIP 100PF	5% 50V
C012	1-163-251-11	CERAMIC CHIP 100PF	5% 50V
C013	1-163-021-91	CERAMIC CHIP 0.01MF	10% 50V
C014	1-126-967-11	ELECT 47MF	20% 50V
C015	1-163-009-11	CERAMIC CHIP 0.001MF	10% 50V
C016	1-163-113-00	CERAMIC CHIP 68PF	5% 50V
C017	1-163-113-00	CERAMIC CHIP 68PF	5% 50V
C019	1-104-665-11	ELECT 100MF	20% 25V
C022	1-163-227-11	CERAMIC CHIP 10PF	0.5PF 50V
C023	1-163-227-11	CERAMIC CHIP 10PF	0.5PF 50V
C024	1-163-227-11	CERAMIC CHIP 10PF	0.5PF 50V
C026	1-164-004-11	CERAMIC CHIP 0.1MF	10% 25V
C027	1-164-004-11	CERAMIC CHIP 0.1MF	10% 25V
C028	1-163-037-11	CERAMIC CHIP 0.022MF	10% 50V
C030	1-126-965-11	ELECT 22MF	20% 50V
C031	1-164-004-11	CERAMIC CHIP 0.1MF	10% 25V
C032	1-107-823-11	CERAMIC CHIP 0.47MF	10% 16V
C034	1-163-031-11	CERAMIC CHIP 0.01MF	50V
C041	1-163-251-11	CERAMIC CHIP 100PF	5% 50V
C042	1-163-251-11	CERAMIC CHIP 100PF	5% 50V
C043	1-163-251-11	CERAMIC CHIP 100PF	5% 50V
C044	1-163-251-11	CERAMIC CHIP 100PF	5% 50V
C047	1-163-251-11	CERAMIC CHIP 100PF	5% 50V
C048	1-163-251-11	CERAMIC CHIP 100PF	5% 50V
C050	1-163-251-11	CERAMIC CHIP 100PF	5% 50V
C051	1-163-251-11	CERAMIC CHIP 100PF	5% 50V
C053	1-163-251-11	CERAMIC CHIP 100PF	5% 50V
C054	1-163-251-11	CERAMIC CHIP 100PF	5% 50V
C055	1-163-251-11	CERAMIC CHIP 100PF	5% 50V
C103	1-164-004-11	CERAMIC CHIP 0.1MF	10% 25V
C104	1-126-933-11	ELECT 100MF	20% 16V
C107	1-163-005-11	CERAMIC CHIP 470PF	10% 50V
C108	1-126-933-11	ELECT 100MF	20% 16V
C109	1-163-005-11	CERAMIC CHIP 470PF	10% 50V
C110	1-163-005-11	CERAMIC CHIP 470PF	10% 50V

\*\*\*\*\*

**A (KV-XF21M80)**

REF. NO.	PART NO.	DESCRIPTION	REMARK	REF. NO.	PART NO.	DESCRIPTION	REMARK
C111	1-163-005-11	CERAMIC CHIP	470PF 10% 50V	C265	1-164-505-11	CERAMIC CHIP	2.2MF 16V
C112	1-126-933-11	ELECT	100MF 20% 16V	C301	1-126-935-11	ELECT	470MF 20% 16V
C113	1-126-967-11	ELECT	47MF 20% 50V	C302	1-163-005-11	CERAMIC CHIP	470PF 10% 50V
C114	1-126-967-11	ELECT	47MF 20% 50V	C303	1-126-964-11	ELECT	10MF 20% 50V
C202	1-163-021-91	CERAMIC CHIP	0.01MF 10% 50V	C304	1-126-967-11	ELECT	47MF 20% 50V
C203	1-163-021-91	CERAMIC CHIP	0.01MF 10% 50V	C305	1-164-004-11	CERAMIC CHIP	0.1MF 10% 25V
C204	1-136-164-00	FILM	0.082MF 5% 50V	C306	1-163-233-11	CERAMIC CHIP	18PF 5% 50V
C205	1-163-017-00	CERAMIC CHIP	0.0047MF 10% 50V	C307	1-163-233-11	CERAMIC CHIP	18PF 5% 50V
C206	1-163-017-00	CERAMIC CHIP	0.0047MF 10% 50V	C308	1-163-259-91	CERAMIC CHIP	220PF 5% 50V
C207	1-136-164-00	FILM	0.082MF 5% 50V	C309	1-126-957-11	ELECT	0.22MF 20% 50V
C208	1-126-964-11	ELECT	10MF 20% 50V	C310	1-126-963-11	ELECT	4.7MF 20% 50V
C209	1-126-964-11	ELECT	10MF 20% 50V	C311	1-126-964-11	ELECT	10MF 20% 50V
C210	1-126-933-11	ELECT	100MF 20% 16V	C312	1-164-346-11	CERAMIC CHIP	1MF 16V
C211	1-126-941-11	ELECT	470MF 20% 25V	C313	1-164-346-11	CERAMIC CHIP	1MF 16V
C212	1-126-933-11	ELECT	100MF 20% 16V	C315	1-164-004-11	CERAMIC CHIP	0.1MF 10% 25V
C213	1-126-933-11	ELECT	100MF 20% 16V	C316	1-126-967-11	ELECT	47MF 20% 50V
C214	1-126-942-61	ELECT	1000MF 20% 25V	C317	1-164-004-11	CERAMIC CHIP	0.1MF 10% 25V
C215	1-126-942-61	ELECT	1000MF 20% 25V	C318	1-163-031-11	CERAMIC CHIP	0.01MF 50V
C216	1-163-021-91	CERAMIC CHIP	0.01MF 10% 50V	C319	1-163-031-11	CERAMIC CHIP	0.01MF 50V
C217	1-126-964-11	ELECT	10MF 20% 50V	C320	1-163-031-11	CERAMIC CHIP	0.01MF 50V
C218	1-136-167-00	FILM	0.15MF 5% 50V	C322	1-163-005-11	CERAMIC CHIP	470PF 10% 50V
C219	1-136-167-00	FILM	0.15MF 5% 50V	C323	1-126-965-11	ELECT	22MF 20% 50V
C220	1-126-942-61	ELECT	1000MF 20% 25V	C324	1-163-017-00	CERAMIC CHIP	0.0047MF 10% 50V
C221	1-126-964-11	ELECT	10MF 20% 50V	C325	1-126-960-11	ELECT	1MF 20% 50V
C223	1-126-965-11	ELECT	22MF 20% 50V	C327	1-126-965-11	ELECT	22MF 20% 50V
C224	1-163-133-00	CERAMIC CHIP	470PF 5% 50V	C328	1-164-004-11	CERAMIC CHIP	0.1MF 10% 25V
C225	1-109-982-11	CERAMIC CHIP	1MF 10% 10V	C329	1-126-965-11	ELECT	22MF 20% 50V
C226	1-109-982-11	CERAMIC CHIP	1MF 10% 10V	C330	1-164-004-11	CERAMIC CHIP	0.1MF 10% 25V
C227	1-163-037-11	CERAMIC CHIP	0.022MF 10% 50V	C331	1-247-807-31	CARBON	100 5% 1/4W
C228	1-163-024-00	CERAMIC CHIP	0.018MF 10% 50V	C332	1-126-963-11	ELECT	4.7MF 20% 50V
C229	1-163-018-00	CERAMIC CHIP	0.0056MF 10% 50V	C335	1-164-004-11	CERAMIC CHIP	0.1MF 10% 25V
C230	1-163-024-00	CERAMIC CHIP	0.018MF 10% 50V	C336	1-164-004-11	CERAMIC CHIP	0.1MF 10% 25V
C231	1-163-018-00	CERAMIC CHIP	0.0056MF 10% 50V	C337	1-126-961-11	ELECT	2.2MF 20% 50V
C232	1-163-037-11	CERAMIC CHIP	0.022MF 10% 50V	C338	1-163-017-00	CERAMIC CHIP	0.0047MF 10% 50V
C233	1-164-004-11	CERAMIC CHIP	0.1MF 10% 25V	C341	1-115-340-11	CERAMIC CHIP	0.22MF 10% 25V
C234	1-164-004-11	CERAMIC CHIP	0.1MF 10% 25V	C342	1-163-259-91	CERAMIC CHIP	220PF 5% 50V
C235	1-164-004-11	CERAMIC CHIP	0.1MF 10% 25V	C401	1-164-346-11	CERAMIC CHIP	1MF 16V
C236	1-164-004-11	CERAMIC CHIP	0.1MF 10% 25V	C402	1-164-346-11	CERAMIC CHIP	1MF 16V
C238	1-164-505-11	CERAMIC CHIP	2.2MF 16V	C403	1-163-005-11	CERAMIC CHIP	470PF 10% 50V
C240	1-164-505-11	CERAMIC CHIP	2.2MF 16V	C404	1-163-005-11	CERAMIC CHIP	470PF 10% 50V
C241	1-164-346-11	CERAMIC CHIP	1MF 16V	C405	1-126-935-11	ELECT	470MF 20% 16V
C242	1-164-505-11	CERAMIC CHIP	2.2MF 16V	C406	1-164-346-11	CERAMIC CHIP	1MF 16V
C243	1-216-295-91	SHORT	0	C407	1-164-346-11	CERAMIC CHIP	1MF 16V
C244	1-164-700-11	CERAMIC CHIP	0.68MF 16V	C408	1-163-133-00	CERAMIC CHIP	470PF 5% 50V
C245	1-164-346-11	CERAMIC CHIP	1MF 16V	C409	1-126-963-11	ELECT	4.7MF 20% 50V
C246	1-163-018-00	CERAMIC CHIP	0.0056MF 10% 50V	C415	1-163-133-00	CERAMIC CHIP	470PF 5% 50V
C247	1-164-346-11	CERAMIC CHIP	1MF 16V	C502	1-163-145-00	CERAMIC CHIP	0.0015MF 5% 50V
C248	1-163-010-11	CERAMIC CHIP	0.0012MF 10% 50V	C506	1-107-638-11	ELECT	33MF 20% 160V
C249	1-164-004-11	CERAMIC CHIP	0.1MF 10% 25V	C507	1-161-830-00	CERAMIC	0.0047MF 500V
C250	1-216-295-91	SHORT	0	C510	1-102-112-00	CERAMIC	330PF 10% 50V
C251	1-163-017-00	CERAMIC CHIP	0.0047MF 10% 50V	C512	1-163-989-11	CERAMIC CHIP	0.033MF 10% 25V
C252	1-164-346-11	CERAMIC CHIP	1MF 16V	C513	1-163-263-11	CERAMIC CHIP	330PF 5% 50V
C253	1-163-037-11	CERAMIC CHIP	0.022MF 10% 50V	C514	1-106-383-00	MYLAR	0.047MF 10% 200V
C254	1-126-965-11	ELECT	22MF 20% 50V	C517	1-164-182-11	CERAMIC CHIP	0.0033MF 10% 50V
C255	1-163-037-11	CERAMIC CHIP	0.022MF 10% 50V	C518	1-104-665-11	ELECT	100MF 20% 10V
C256	1-164-004-11	CERAMIC CHIP	0.1MF 10% 25V	C519	1-102-212-00	CERAMIC	820PF 10% 500V
C259	1-126-933-11	ELECT	100MF 20% 16V	C521	1-126-934-11	ELECT	220MF 20% 16V
C264	1-164-505-11	CERAMIC CHIP	2.2MF 16V				

The components identified by shading and mark  $\Delta$  are critical for safety. Replace only with part number specified.

# A (KV-XF21M80)

REF. NO.	PART NO.	DESCRIPTION	REMARK
C522	1-126-933-11	ELECT	100MF 20% 16V
C523	1-102-002-00	CERAMIC	680PF 10% 500V
C524	1-126-967-11	ELECT	47MF 20% 50V
C526	1-130-495-00	MYLAR	0.1MF 5% 50V
C527	1-102-820-00	CERAMIC	330PF 5% 50V
C528	1-162-134-11	CERAMIC	470PF 10% 2KV
C530	1-137-372-11	FILM	0.022MF 5% 50V
C531	1-126-961-11	ELECT	2.2MF 20% 50V
C532	1-126-941-11	ELECT	470MF 20% 25V
C533	1-126-941-11	ELECT	470MF 20% 25V
C536	1-136-165-00	FILM	0.1MF 5% 50V
C537	1-126-969-11	ELECT	220MF 20% 50V
C538	1-136-076-00	FILM	0.0085MF 3% 2KV
C539	1-129-746-91	FILM	0.039MF 5% 400V
C540	1-136-171-00	FILM	0.33MF 5% 50V
C546	1-165-319-11	CERAMIC CHIP	0.1MF 50V
C549	1-163-017-00	CERAMIC CHIP	0.0047MF 10% 50V
C550	1-106-220-00	MYLAR	0.1MF 10% 100V
C551	1-126-960-11	ELECT	1MF 20% 50V
C552	1-162-116-00	CERAMIC	680PF 10% 2KV
C553	1-162-116-00	CERAMIC	680PF 10% 2KV
C554	1-137-417-11	MYLAR	0.0047MF 10% 200V
C556	1-126-941-11	ELECT	470MF 20% 25V
C557	1-126-941-11	ELECT	470MF 20% 25V
C558	1-123-024-21	ELECT	33MF 160V
C560	1-102-228-00	CERAMIC	470PF 10% 500V
C561	1-136-557-11	FILM	0.0033MF 5% 630V
C562	1-102-228-00	CERAMIC	470PF 10% 500V
C564	1-163-038-91	CERAMIC CHIP	0.1MF 25V
C565	1-107-655-11	ELECT	47MF 20% 250V
C566	1-102-244-00	CERAMIC	220PF 10% 500V
C567	1-115-521-11	FILM	0.82MF 5% 250V
C568	1-102-228-00	CERAMIC	470PF 10% 500V
C570	1-115-520-11	FILM	0.68MF 5% 250V
C573	1-106-379-12	MYLAR	0.033MF 10% 200V
C574	1-107-636-11	ELECT	10MF 20% 160V
C576	1-130-495-00	MYLAR	0.1MF 5% 50V
C577	1-106-395-00	MYLAR	0.15MF 10% 200V
C582	1-164-004-11	CERAMIC CHIP	0.1MF 10% 25V
C600 $\Delta$	1-104-705-51	FILM	0.1MF 20% 250V
C604	1-163-009-11	CERAMIC CHIP	0.001MF 10% 50V
C605 $\Delta$	1-127-942-51	CERAMIC	330PF 10% 250V
C606 $\Delta$	1-127-942-51	CERAMIC	330PF 10% 250V
C607	1-161-830-00	CERAMIC	0.0047MF 99% 500V
C608	1-161-830-00	CERAMIC	0.0047MF 99% 500V
C609	1-126-968-11	ELECT	100MF 20% 50V
C610	1-126-964-11	ELECT	10MF 20% 50V
C611	1-161-830-00	CERAMIC	0.0047MF 99% 500V
C612	1-161-830-00	CERAMIC	0.0047MF 99% 500V
C613	1-117-752-11	ELECT(BLOCK)	330MF 20% 450V
C614	1-126-964-11	ELECT	10MF 20% 50V
C616	1-130-202-00	FILM	0.022MF 10% 400V
C617	1-107-792-11	CERAMIC	100PF 5% 1KV
C618	1-125-893-11	FILM	680PF 3% 1.5KV
C619	1-119-886-51	CERAMIC	470PF 10% 250V
C620	1-163-133-00	CERAMIC CHIP	470PF 5% 50V
C621	1-102-114-00	CERAMIC	470PF 10% 50V
C622	1-102-074-00	CERAMIC	0.001MF 10% 50V

REF. NO.	PART NO.	DESCRIPTION	REMARK
C623	1-104-665-11	ELECT	100MF 20% 25V
C624	1-104-331-11	CERAMIC	0.0022MF 10% 1KV
C627	1-102-002-00	CERAMIC	680PF 10% 500V
C628	1-126-942-61	ELECT	1000MF 20% 25V
C629	1-126-964-11	ELECT	10MF 20% 50V
C630	1-123-024-21	ELECT	33MF 160V
C633	1-104-999-11	MYLAR	0.1MF 10% 200V
C634	1-126-933-11	ELECT	100MF 20% 16V
C635	1-104-665-11	ELECT	100MF 20% 10V
C636	1-104-760-11	CERAMIC CHIP	0.047MF 10% 50V
C639	1-164-004-11	CERAMIC CHIP	0.1MF 10% 25V
C640	1-164-004-11	CERAMIC CHIP	0.1MF 10% 25V
C641	1-102-002-00	CERAMIC	680PF 10% 500V
C642	1-126-943-11	ELECT	2200MF 20% 25V
C643	1-104-665-11	ELECT	100MF 20% 10V
C644	1-104-331-11	CERAMIC	0.0022MF 10% 1KV
C645	1-137-605-11	FILM	0.01MF 10% 250V
C646	1-107-679-91	ELECT	10MF 20% 450V
C647	1-163-275-11	CERAMIC CHIP	0.001MF 5% 50V
C649	1-126-940-11	ELECT	330MF 20% 25V
C650	1-163-275-11	CERAMIC CHIP	0.001MF 5% 50V
C651	1-163-133-00	CERAMIC CHIP	470PF 5% 50V
C652	1-126-965-11	ELECT	22MF 20% 50V
C653	1-104-664-11	ELECT	47MF 20% 25V
C657	1-101-821-00	CERAMIC	0.0022MF 500V
C658	1-164-004-11	CERAMIC CHIP	0.1MF 10% 25V
C901	1-136-153-00	FILM	0.01MF 5% 50V
C902	1-136-153-00	FILM	0.01MF 5% 50V
C905	1-126-963-11	ELECT	4.7MF 20% 50V
C906	1-164-346-11	CERAMIC CHIP	1MF 16V
C907	1-163-133-00	CERAMIC CHIP	470PF 5% 50V
C908	1-163-133-00	CERAMIC CHIP	470PF 5% 50V
C909	1-164-346-11	CERAMIC CHIP	1MF 16V
C910	1-126-967-11	ELECT	47MF 20% 50V
C911	1-126-967-11	ELECT	47MF 20% 50V
C912	1-164-004-11	CERAMIC CHIP	0.1MF 10% 25V
C913	1-126-933-11	ELECT	100MF 20% 16V
C914	1-163-133-00	CERAMIC CHIP	470PF 5% 50V
CN104	1-695-915-11	TAB (CONTACT)	
CN202 *	1-785-608-11	PIN, CONNECTOR 4P	
CN203 *	1-564-506-11	PLUG, CONNECTOR 3P	
CN204 *	1-564-506-11	PLUG, CONNECTOR 3P	
CN305 *	1-564-509-11	PLUG, CONNECTOR 6P	
CN306 *	1-564-510-11	PLUG, CONNECTOR 7P	
CN505	1-508-765-00	PIN, CONNECTOR (5MM PITCH) 3P	
CN506	4-352-844-01	PIN, LEAD, COATING	
CN507 *	1-564-507-11	PLUG, CONNECTOR 4P	
CN601 *	1-580-843-11	PIN, CONNECTOR (POWER)	
CN602 *	1-508-786-00	PIN, CONNECTOR (5MM PITCH) 2P	
CN604 *	1-573-963-11	PIN, CONNECTOR (PC BOARD) 3P	
CN609 *	1-508-784-21	PIN, CONNECTOR (5MM PITCH) 1P	
CN901 *	1-564-507-11	PLUG, CONNECTOR 4P	

**A (KV-XF21M80)**

REF. NO.	PART NO.	DESCRIPTION	REMARK	REF. NO.	PART NO.	DESCRIPTION	REMARK
<COMPOSITION CIRCUIT BLOCK>							
CP301	1-467-554-21	FILTER BLOCK, COMB		D614	8-719-046-74	DIODE AU-01Z-V1	
<DIODE>				D618	8-719-067-18	DIODE RN4Z	
D001	8-719-988-61	DIODE 1SS355TE-17		D620	8-719-110-72	DIODE RD30ESB2	
D005	8-719-988-61	DIODE 1SS355TE-17		D622	8-719-071-39	DIODE FMU-G26S	
D006	8-719-988-61	DIODE 1SS355TE-17		D623	8-719-978-65	DIODE DTZ-TT11-15B	
D203	8-719-914-42	DIODE DA204K		D624	8-719-404-50	DIODE MA111-TX	
D300	1-216-295-91	SHORT	0	D625	8-719-158-39	DIODE RD10SB	
D301	8-719-988-61	DIODE 1SS355TE-17		D627	8-719-073-84	DIODE 31DQ06-FC5	
D306	8-719-988-61	DIODE 1SS355TE-17		D628	8-719-911-19	DIODE 1SS119-25	
D307	8-719-988-61	DIODE 1SS355TE-17		D631	8-719-068-00	DIODE ERC04-06SE	
D308	8-719-988-61	DIODE 1SS355TE-17		D632	8-719-068-00	DIODE ERC04-06SE	
D309	8-719-159-10	DIODE RD5.1SB-T2		D633	8-719-948-45	DIODE ERA22-08	
D311	8-719-988-61	DIODE 1SS355TE-17		D634	8-719-404-50	DIODE MA111-TX	
D312	8-719-988-61	DIODE 1SS355TE-17		D635	8-719-404-50	DIODE MA111-TX	
D313	8-719-988-61	DIODE 1SS355TE-17		D636	8-719-510-02	DIODE D1NS4	
D314	8-719-988-61	DIODE 1SS355TE-17		D637	8-719-109-96	DIODE RD6.8ESB1	
D315	8-719-988-61	DIODE 1SS355TE-17		D638	8-719-510-48	DIODE D1N20R	
D316	8-719-069-57	DIODE UDZS-TE17-6.8B		D901	8-719-158-35	DIODE RD9.1SB	
D401	8-719-158-35	DIODE RD9.1SB		D902	8-719-158-35	DIODE RD9.1SB	
D402	8-719-158-35	DIODE RD9.1SB		D903	8-719-158-35	DIODE RD9.1SB	
D403	8-719-158-35	DIODE RD9.1SB		D904	8-719-158-35	DIODE RD9.1SB	
D404	8-719-158-35	DIODE RD9.1SB		D905	8-719-158-35	DIODE RD9.1SB	
D405	8-719-158-35	DIODE RD9.1SB		D906	8-719-045-19	DIODE SPB-26MVWF	
D406	8-719-158-35	DIODE RD9.1SB		<CONNECTOR>			
D504	8-719-302-43	DIODE EL1Z		DY1	* 1-580-798-11	CONNECTOR PIN (DY) 6P	
D505	8-719-988-61	DIODE 1SS355TE-17		<FERRITE BEAD>			
D506	8-719-911-19	DIODE 1SS119-25		FB103	1-410-397-21	FERRITE	1.1UH
D507	8-719-988-61	DIODE 1SS355TE-17		FB501	1-410-397-21	FERRITE	1.1UH
D508	8-719-988-61	DIODE 1SS355TE-17		FB502	1-410-397-21	FERRITE	1.1UH
D509	1-216-073-00	RES,CHIP 10K	5% 1/10W	FB600	1-410-397-21	FERRITE	1.1UH
D510	8-719-988-61	DIODE 1SS355TE-17		FB601	1-410-397-21	FERRITE	1.1UH
D511	8-719-988-61	DIODE 1SS355TE-17		FB602	1-410-397-21	FERRITE	1.1UH
D512	8-719-988-61	DIODE 1SS355TE-17		FB603	1-410-397-21	FERRITE	1.1UH
D513	8-719-908-03	DIODE GP08D		FB604	1-410-397-21	FERRITE	1.1UH
D517	8-719-945-80	DIODE ERC06-15S		FB607	1-410-397-21	FERRITE	1.1UH
D518	8-719-900-26	DIODE ERD29-08J		FB608	1-412-911-31	FERRITE	0UH
D521	8-719-302-43	DIODE EL1Z		FB611	1-410-397-21	FERRITE	1.1UH
D522	8-719-302-43	DIODE EL1Z		FB613	1-410-397-21	FERRITE	1.1UH
D523	8-719-302-43	DIODE EL1Z		FB615	1-410-397-21	FERRITE	1.1UH
D527	8-719-908-03	DIODE GP08D		<IC>			
D528	8-719-908-03	DIODE GP08D		IC001	8-752-905-21	IC CXP86449-615S (KV-XF21M80(E/VIETNAM))	
D531	8-719-988-61	DIODE 1SS355TE-17		IC001	8-752-905-20	IC CXP86449-614S (KV-XF21M80(ME))	
D532	8-719-988-61	DIODE 1SS355TE-17		IC002	8-759-371-21	IC MM1319AFBE	
D602	8-719-911-19	DIODE 1SS119-25		IC003	8-759-370-34	IC ST24C08FB6	
D603	8-719-150-92	DIODE RD33EB3T		IC201	8-759-336-30	IC TA8223K	
D604	8-719-028-72	DIODE RGP02-17EL-6433		IC203	8-759-553-40	IC TDA7429S	
D605	8-719-510-53	DIODE D4SB60L		IC301	8-752-088-39	IC CXA2130S	
D606	8-719-108-18	THYRISTOR 5P6M		IC502	8-759-700-07	IC NJM2903M	
D607	8-719-404-50	DIODE MA111-TX		IC503	8-759-980-58	IC TDA8172	
D608	8-719-110-53	DIODE RD20ESB2		IC601	8-749-013-75	IC STR-F6654	
D609	8-719-311-31	DIODE RU-1P					
D610	8-719-043-76	DIODE AK04V0					
D611	8-719-046-74	DIODE AU-01Z-V1					
D613	8-719-046-74	DIODE AU-01Z-V1					

The components identified by shading and mark  $\triangle$  are critical for safety. Replace only with part number specified.

# A (KV-XF21M80)

REF. NO.	PART NO.	DESCRIPTION	REMARK	REF. NO.	PART NO.	DESCRIPTION	REMARK
IC602	8-749-920-61	IC SE-135N		L503	1-412-525-31	INDUCTOR 10UH	
IC603	8-759-701-59	IC NJM78M09FA		L504	1-412-525-31	INDUCTOR 10UH	
IC604	8-759-231-53	IC TA7805S		L505	1-412-525-31	INDUCTOR 10UH	
IC901	8-742-014-11	HYB IC SBX1981-51		L506	1-412-525-31	INDUCTOR 10UH	
		<JACK>		L507	1-459-111-00	INDUCTOR 10MMH	
J401	1-779-850-11	JACK BLOCK, PIN 6P		L508	1-412-525-31	INDUCTOR 10UH	
J901	1-770-786-11	JACK		L509	1-459-390-00	INDUCTOR 390UH	
J902	1-770-329-11	JACK, PIN 3P		L510	1-416-972-11	COIL, HORIZONTAL LINEARITY	
		<CHIP CONDUCTOR>		L512	1-412-549-31	INDUCTOR 1MMH	
JR002	1-216-295-91	SHORT	0	L513	1-412-549-31	INDUCTOR 1MMH	
JR003	1-216-295-91	SHORT	0	L515	1-459-104-00	COIL, WITH CORE	
JR004	1-216-295-91	SHORT	0	L518	1-408-611-31	INDUCTOR 47UH	
JR005	1-216-295-91	SHORT	0	L601	1-412-527-11	INDUCTOR 15UH	
JR006	1-216-295-91	SHORT	0	L901	1-408-603-31	INDUCTOR 10UH	
JR007	1-216-295-91	SHORT	0	L902	1-408-603-31	INDUCTOR 10UH	
JR008	1-216-295-91	SHORT	0	L905	1-414-856-11	INDUCTOR 10UH	
JR009	1-216-295-91	SHORT	0			<PHOTO COUPLER>	
JR010	1-216-295-91	SHORT	0	PH600 $\triangle$	8-749-924-35	PHOTO COUPLER ON3171-R	
JR011	1-216-295-91	SHORT	0			<IC LINK>	
JR012	1-216-295-91	SHORT	0	PS200	1-532-675-21	LINK, IC 1.5A/150V	
JR013	1-216-295-91	SHORT	0			<TRANSISTOR>	
JR014	1-216-295-91	SHORT	0	Q002	8-729-230-49	TRANSISTOR 2SC2712-YG	
JR015	1-216-295-91	SHORT	0	Q003	8-729-424-08	TRANSISTOR UN2111	
JR016	1-216-295-91	SHORT	0	Q004	8-729-421-22	TRANSISTOR UN2211	
JR018	1-216-295-91	SHORT	0	Q101	8-729-230-49	TRANSISTOR 2SC2712-YG	
JR019	1-216-295-91	SHORT	0	Q201	8-729-424-67	TRANSISTOR UN2216	
JR102	1-216-295-91	SHORT	0	Q202	8-729-424-67	TRANSISTOR UN2216	
JR109	1-216-295-91	SHORT	0	Q203	1-801-806-11	TRANSISTOR DTC144EKA-T146	
JR202	1-216-295-91	SHORT	0	Q204	8-729-216-22	TRANSISTOR 2SA1162-G	
JR301	1-216-295-91	SHORT	0	Q205	1-801-806-11	TRANSISTOR DTC144EKA-T146	
JR303	1-216-295-91	SHORT	0	Q206	1-801-806-11	TRANSISTOR DTC144EKA-T146	
JR401	1-216-295-91	SHORT	0	Q207	1-801-806-11	TRANSISTOR DTC144EKA-T146	
JR403	1-216-295-91	SHORT	0	Q301	8-729-216-22	TRANSISTOR 2SA1162-G	
JR404	1-216-295-91	SHORT	0	Q302	8-729-230-49	TRANSISTOR 2SC2712-YG	
JR405	1-216-295-91	SHORT	0	Q303	8-729-216-22	TRANSISTOR 2SA1162-G	
JR500	1-216-295-91	SHORT	0	Q305	8-729-216-22	TRANSISTOR 2SA1162-G	
JR501	1-216-295-91	SHORT	0	Q306	8-729-216-22	TRANSISTOR 2SA1162-G	
JR600	1-216-295-91	SHORT	0	Q307	8-729-230-49	TRANSISTOR 2SC2712-YG	
		<COIL>		Q308	8-729-216-22	TRANSISTOR 2SA1162-G	
L002	1-414-856-11	INDUCTOR	10UH	Q312	8-729-216-22	TRANSISTOR 2SA1162-G	
L003	1-414-180-11	INDUCTOR	3.3UH	Q313	8-729-230-49	TRANSISTOR 2SC2712-YG	
L005	1-414-233-22	INDUCTOR CHIP	0UH	Q315	8-729-421-19	TRANSISTOR UN2213	
L101	1-414-856-11	INDUCTOR	10UH	Q401	8-729-424-67	TRANSISTOR UN2216	
L102	1-414-856-11	INDUCTOR	10UH	Q402	8-729-424-67	TRANSISTOR UN2216	
L103	1-414-856-11	INDUCTOR	10UH	Q403	8-729-216-22	TRANSISTOR 2SA1162-G	
L104	1-414-856-11	INDUCTOR	10UH	Q404	8-729-216-22	TRANSISTOR 2SA1162-G	
L105	1-414-856-11	INDUCTOR	10UH	Q503	8-729-230-49	TRANSISTOR 2SC2712-YG	
L204	1-414-856-11	INDUCTOR	10UH	Q505	8-729-931-45	TRANSISTOR IRF614	
L301	1-414-189-31	INDUCTOR	100UH	Q506	8-729-140-96	TRANSISTOR 2SD774-34	
L302	1-414-185-41	INDUCTOR	22UH	Q507	8-729-216-22	TRANSISTOR 2SA1162-G	
L501	1-412-525-31	INDUCTOR	10UH	Q509	8-729-230-49	TRANSISTOR 2SC2712-YG	
L502	1-422-613-11	COIL, AIR CORE					

**A (KV-XF21M80)**

REF. NO.	PART NO.	DESCRIPTION	REMARK	REF. NO.	PART NO.	DESCRIPTION	REMARK
Q511	8-729-016-32	TRANSISTOR 2SC4927-01		R063	1-216-037-00	RES,CHIP	330 5% 1/10W
Q601	8-729-023-22	TRANSISTOR 2SD2114K		R064	1-216-037-00	RES,CHIP	330 5% 1/10W
Q602	8-729-230-49	TRANSISTOR 2SC2712-YG		R065	1-216-037-00	RES,CHIP	330 5% 1/10W
Q603	8-729-424-08	TRANSISTOR UN2111		R066	1-216-049-91	RES,CHIP	1K 5% 1/10W
Q604	8-729-200-17	TRANSISTOR 2SA1091-O		R105	1-216-295-91	SHORT	0
Q605	8-729-044-30	TRANSISTOR 2SK2845-LB102		R109	1-216-041-00	RES,CHIP	470 5% 1/10W
Q606	8-729-230-49	TRANSISTOR 2SC2712-YG		R111	1-216-025-91	RES,CHIP	100 5% 1/10W
Q607	8-729-922-37	TRANSISTOR 2SD2144S-UVW		R112	1-216-025-91	RES,CHIP	100 5% 1/10W
Q608	8-729-230-49	TRANSISTOR 2SC2712-YG		R113	1-216-047-91	RES,CHIP	820 5% 1/10W
Q901	8-729-421-19	TRANSISTOR UN2213		R202	1-216-053-00	RES,CHIP	1.5K 5% 1/10W
Q902	8-729-421-19	TRANSISTOR UN2213		R203	1-216-057-00	RES,CHIP	2.2K 5% 1/10W
		<RESISTOR>		R204	1-216-069-00	RES,CHIP	6.8K 5% 1/10W
R001	1-414-233-22	INDUCTOR CHIP	0UH	R205	1-216-069-00	RES,CHIP	6.8K 5% 1/10W
R002	1-216-025-91	RES,CHIP	100 5% 1/10W	R206	1-216-057-00	RES,CHIP	2.2K 5% 1/10W
R003	1-216-073-00	RES,CHIP	10K 5% 1/10W	R207	1-216-053-00	RES,CHIP	1.5K 5% 1/10W
R004	1-216-025-91	RES,CHIP	100 5% 1/10W	R208	1-216-069-00	RES,CHIP	6.8K 5% 1/10W
R005	1-216-025-91	RES,CHIP	100 5% 1/10W	R209	1-216-069-00	RES,CHIP	6.8K 5% 1/10W
R007	1-216-295-91	SHORT	0	R210	1-216-029-00	RES,CHIP	150 5% 1/10W
R008	1-216-065-91	RES,CHIP	4.7K 5% 1/10W	R212	1-216-029-00	RES,CHIP	150 5% 1/10W
R010	1-216-065-91	RES,CHIP	4.7K 5% 1/10W	R213	1-216-073-00	RES,CHIP	10K 5% 1/10W
R011	1-216-065-91	RES,CHIP	4.7K 5% 1/10W	R214	1-216-073-00	RES,CHIP	10K 5% 1/10W
R012	1-216-065-91	RES,CHIP	4.7K 5% 1/10W	R215	1-216-059-00	RES,CHIP	2.7K 5% 1/10W
R013	1-216-065-91	RES,CHIP	4.7K 5% 1/10W	R216	1-216-059-00	RES,CHIP	2.7K 5% 1/10W
R014	1-216-025-91	RES,CHIP	100 5% 1/10W	R217	1-216-067-00	RES,CHIP	5.6K 5% 1/10W
R015	1-216-025-91	RES,CHIP	100 5% 1/10W	R218	1-216-067-00	RES,CHIP	5.6K 5% 1/10W
R016	1-216-025-91	RES,CHIP	100 5% 1/10W	R219	1-216-025-91	RES,CHIP	100 5% 1/10W
R017	1-216-049-91	RES,CHIP	1K 5% 1/10W	R220	1-216-025-91	RES,CHIP	100 5% 1/10W
R018	1-216-033-00	RES,CHIP	220 5% 1/10W	R221	1-216-295-91	SHORT	0
R019	1-216-073-00	RES,CHIP	10K 5% 1/10W	R222	1-216-295-91	SHORT	0
R021	1-216-073-00	RES,CHIP	10K 5% 1/10W	R225	1-216-033-00	RES,CHIP	220 5% 1/10W
R022	1-216-033-00	RES,CHIP	220 5% 1/10W	R226	1-216-033-00	RES,CHIP	220 5% 1/10W
R024	1-216-057-00	RES,CHIP	2.2K 5% 1/10W	R227	1-216-033-00	RES,CHIP	220 5% 1/10W
R025	1-216-057-00	RES,CHIP	2.2K 5% 1/10W	R228	1-249-389-11	CARBON	4.7 5% 1/4W
R026	1-216-057-00	RES,CHIP	2.2K 5% 1/10W	R229	1-216-073-00	RES,CHIP	10K 5% 1/10W
R027	1-216-073-00	RES,CHIP	10K 5% 1/10W	R230	1-216-069-00	RES,CHIP	6.8K 5% 1/10W
R029	1-216-049-91	RES,CHIP	1K 5% 1/10W	R231	1-216-295-91	SHORT	0
R031	1-216-049-91	RES,CHIP	1K 5% 1/10W	R234	1-249-389-11	CARBON	4.7 5% 1/4W
R035	1-216-025-91	RES,CHIP	100 5% 1/10W	R235	1-216-069-00	RES,CHIP	6.8K 5% 1/10W
R036	1-216-025-91	RES,CHIP	100 5% 1/10W	R236	1-216-069-00	RES,CHIP	6.8K 5% 1/10W
R037	1-216-025-91	RES,CHIP	100 5% 1/10W	R237	1-216-308-00	RES,CHIP	4.7 5% 1/10W
R040	1-216-025-91	RES,CHIP	100 5% 1/10W	R301	1-216-073-00	RES,CHIP	10K 5% 1/10W
R041	1-216-025-91	RES,CHIP	100 5% 1/10W	R302	1-216-295-91	SHORT	0
R042	1-216-295-91	SHORT	0	R303	1-216-049-91	RES,CHIP	1K 5% 1/10W
R043	1-216-025-91	RES,CHIP	100 5% 1/10W	R304	1-216-073-00	RES,CHIP	10K 5% 1/10W
R044	1-216-025-91	RES,CHIP	100 5% 1/10W	R305	1-216-051-00	RES,CHIP	1.2K 5% 1/10W
R045	1-414-233-22	INDUCTOR CHIP	0UH	R306	1-216-073-00	RES,CHIP	10K 5% 1/10W
R046	1-216-049-91	RES,CHIP	1K 5% 1/10W	R307	1-216-295-91	SHORT	0
R047	1-414-233-22	INDUCTOR CHIP	0UH	R308	1-216-025-91	RES,CHIP	100 5% 1/10W
R048	1-216-073-00	RES,CHIP	10K 5% 1/10W	R309	1-216-025-91	RES,CHIP	100 5% 1/10W
R050	1-216-073-00	RES,CHIP	10K 5% 1/10W	R310	1-216-025-91	RES,CHIP	100 5% 1/10W
R053	1-216-049-91	RES,CHIP	1K 5% 1/10W	R311	1-216-017-91	RES,CHIP	47 5% 1/10W
R055	1-216-073-00	RES,CHIP	10K 5% 1/10W	R312	1-216-041-00	RES,CHIP	470 5% 1/10W
R056	1-216-073-00	RES,CHIP	10K 5% 1/10W	R313	1-216-053-00	RES,CHIP	1.5K 5% 1/10W
R061	1-216-033-00	RES,CHIP	220 5% 1/10W	R314	1-216-045-00	RES,CHIP	680 5% 1/10W
R062	1-216-041-00	RES,CHIP	470 5% 1/10W	R316	1-216-053-00	RES,CHIP	1.5K 5% 1/10W
				R317	1-216-077-00	RES,CHIP	15K 5% 1/10W
				R318	1-216-051-00	RES,CHIP	1.2K 5% 1/10W



## KV-HF51P50/XF21M80/XF21M83/XF21N90/XF51M65

RM-952 RM-952 RM-952 RM-915 RM-952

**A** (KV-XF21M80)

REF. NO.	PART NO.	DESCRIPTION	REMARK	REF. NO.	PART NO.	DESCRIPTION	REMARK
R319	1-216-025-91	RES,CHIP	100 5%	R426	1-216-033-00	RES,CHIP	220 5%
R320	1-216-065-91	RES,CHIP	4.7K 5%	R505	1-216-099-00	RES,CHIP	120K 5%
R321	1-216-073-00	RES,CHIP	10K 5%	R506	1-216-085-00	RES,CHIP	33K 5%
R322	1-216-033-00	RES,CHIP	220 5%	R507	1-249-389-11	CARBON	4.7 5%
R326	1-216-295-91	SHORT	0	R508	1-215-910-00	METAL OXIDE	68 5%
R331	1-216-295-91	SHORT	0	R509	1-215-911-11	METAL OXIDE	100 5%
R332	1-216-033-00	RES,CHIP	220 5%	R510	1-215-885-00	METAL OXIDE	68 5%
R333	1-216-073-00	RES,CHIP	10K 5%	R511	1-215-911-11	METAL OXIDE	100 5%
R334	1-216-129-00	RES,CHIP	2.2M 5%	R516	1-216-081-00	RES,CHIP	22K 5%
R335	1-216-045-00	RES,CHIP	680 5%	R518	1-247-807-31	CARBON	100 5%
R338	1-216-033-00	RES,CHIP	220 5%	R520	1-215-445-00	METAL	10K 1%
R340	1-216-025-91	RES,CHIP	100 5%	R522	1-216-675-11	METAL CHIP	10K 0.50%
R345	1-216-081-00	RES,CHIP	22K 5%	R523	1-249-411-11	CARBON	330 5%
R346	1-216-051-00	RES,CHIP	1.2K 5%	R525	1-216-699-11	METAL CHIP	100K 0.50%
R347	1-216-051-00	RES,CHIP	1.2K 5%	R526	1-208-798-11	RES,CHIP	4.7K 0.50%
R348	1-216-675-11	METAL CHIP	10K 0.50%	R527	1-216-001-00	RES,CHIP	10 5%
R349	1-216-073-00	RES,CHIP	10K 5%	R528	1-216-683-11	METAL CHIP	22K 0.50%
R350	1-216-061-00	RES,CHIP	3.3K 5%	R529	1-216-635-11	METAL CHIP	220 0.50%
R351	1-216-053-00	RES,CHIP	1.5K 5%	R531	1-247-843-11	CARBON	3.3K 5%
R354	1-216-057-00	RES,CHIP	2.2K 5%	R533	1-249-417-11	CARBON	1K 5%
R355	1-216-057-00	RES,CHIP	2.2K 5%	R534	1-216-361-00	METAL OXIDE	0.22 5%
R356	1-216-057-00	RES,CHIP	2.2K 5%	R535	1-216-067-00	RES,CHIP	5.6K 5%
R357	1-216-079-00	RES,CHIP	18K 5%	R536	1-216-067-00	RES,CHIP	5.6K 5%
R358	1-216-049-91	RES,CHIP	1K 5%	R537	1-216-683-11	METAL CHIP	22K 0.50%
R359	1-216-033-00	RES,CHIP	220 5%	R540	1-216-065-91	RES,CHIP	4.7K 5%
R360	1-216-033-00	RES,CHIP	220 5%	R541	1-216-065-91	RES,CHIP	4.7K 5%
R361	1-216-073-00	RES,CHIP	10K 5%	R542	1-216-295-91	SHORT	0
R362	1-216-075-00	RES,CHIP	12K 5%	R543	1-249-426-11	CARBON	5.6K 5%
R363	1-216-079-00	RES,CHIP	18K 5%	R544	1-215-918-00	METAL OXIDE	1.5K 5%
R364	1-216-295-91	SHORT	0	R545	1-216-077-00	RES,CHIP	15K 5%
R365	1-216-033-00	RES,CHIP	220 5%	R546	1-216-077-00	RES,CHIP	15K 5%
R366	1-216-073-00	RES,CHIP	10K 5%	R547	1-216-085-00	RES,CHIP	33K 5%
R367	1-216-073-00	RES,CHIP	10K 5%	R549	1-215-451-00	METAL	18K 1%
R370	1-216-033-00	RES,CHIP	220 5%	R550	1-216-097-91	RES,CHIP	100K 5%
R376	1-216-081-00	RES,CHIP	22K 5%	R551	1-249-421-11	CARBON	2.2K 5%
R377	1-216-121-91	RES,CHIP	1M 5%	R552	1-216-057-00	RES,CHIP	2.2K 5%
R378	1-216-031-00	RES,CHIP	180 5%	R553	1-215-457-00	METAL	33K 1%
R401	1-216-049-91	RES,CHIP	1K 5%	R554	1-215-457-00	METAL	33K 1%
R402	1-216-073-00	RES,CHIP	10K 5%	R556	1-215-437-00	METAL	4.7K 1%
R403	1-216-073-00	RES,CHIP	10K 5%	R557	1-216-345-11	METAL OXIDE	0.47 5%
R403	1-216-295-91	SHORT	0	R558	1-249-421-11	CARBON	2.2K 5%
R404	1-216-073-00	RES,CHIP	10K 5%	R559	1-249-429-11	CARBON	10K 5%
R405	1-216-049-91	RES,CHIP	1K 5%	R560	1-216-073-00	RES,CHIP	10K 5%
R406	1-216-073-00	RES,CHIP	10K 5%	R562	1-249-401-11	CARBON	47 5%
R407	1-216-049-91	RES,CHIP	1K 5%	R565	1-216-073-00	RES,CHIP	10K 5%
R408	1-216-049-91	RES,CHIP	1K 5%	R567	1-216-105-91	RES,CHIP	220K 5%
R409	1-216-041-00	RES,CHIP	470 5%	R568	1-249-383-11	CARBON	1.5 5%
R410	1-216-113-00	RES,CHIP	470K 5%	R570	1-216-069-00	RES,CHIP	6.8K 5%
R411	1-216-113-00	RES,CHIP	470K 5%	R571	1-215-437-00	METAL	4.7K 1%
R412	1-216-041-00	RES,CHIP	470 5%	R573	1-216-089-91	RES,CHIP	47K 5%
R413	1-216-021-00	RES,CHIP	68 5%	R577	1-215-913-11	METAL OXIDE	220 5%
R414	1-216-113-00	RES,CHIP	470K 5%	R578	1-216-369-00	METAL OXIDE	1 5%
R415	1-216-113-00	RES,CHIP	470K 5%	R579	1-216-097-91	RES,CHIP	100K 5%
R416	1-216-077-00	RES,CHIP	15K 5%	R580	1-216-699-11	METAL CHIP	100K 0.50%
R417	1-216-077-00	RES,CHIP	15K 5%	R581	1-208-798-11	RES,CHIP	4.7K 0.50%
R418	1-216-113-00	RES,CHIP	470K 5%	R585	1-249-391-11	CARBON	6.8 5%
R419	1-216-022-00	RES,CHIP	75 5%				

The components identified by shading and mark  $\Delta$  are critical for safety. Replace only with part number specified.

**A (KV-XF21M80)**

REF. NO.	PART NO.	DESCRIPTION	REMARK	REF. NO.	PART NO.	DESCRIPTION	REMARK
R588	1-215-888-00	METAL OXIDE	220 5% 2W F	R661	1-215-873-00	METAL OXIDE	4.7K 5% 1W F
R589	1-215-888-00	METAL OXIDE	220 5% 2W F	R680	1-216-308-00	RES,CHIP	4.7 5% 1/10W
R590	1-215-465-00	METAL	68K 1% 1/4W	R901	1-249-411-11	CARBON	330 5% 1/4W
R591	1-260-288-11	CARBON	0.47 5% 1/2W F	R902	1-249-411-11	CARBON	330 5% 1/4W
R593	1-260-288-11	CARBON	0.47 5% 1/2W F	R903	1-216-022-00	RES,CHIP	75 5% 1/10W
R594	1-260-288-11	CARBON	0.47 5% 1/2W F	R904	1-216-033-00	RES,CHIP	220 5% 1/10W
R596	1-215-920-11	METAL OXIDE	3.3K 5% 3W F	R905	1-216-113-00	RES,CHIP	470K 5% 1/10W
R597	1-247-750-11	CARBON	680 5% 1/2W F	R906	1-216-077-00	RES,CHIP	15K 5% 1/10W
R598	1-249-438-11	CARBON	56K 5% 1/4W	R907	1-216-113-00	RES,CHIP	470K 5% 1/10W
R599	1-249-389-11	CARBON	4.7 5% 1/4W	R908	1-216-077-00	RES,CHIP	15K 5% 1/10W
R600	1-249-438-11	CARBON	56K 5% 1/4W	R909	1-216-065-91	RES,CHIP	4.7K 5% 1/10W
R601	1-249-418-11	CARBON	1.2K 5% 1/4W F	R910	1-216-065-91	RES,CHIP	4.7K 5% 1/10W
R602	1-249-389-11	CARBON	4.7 5% 1/4W F	R911	1-216-067-00	RES,CHIP	5.6K 5% 1/10W
R603	1-215-485-00	METAL	470K 1% 1/4W	R912	1-216-041-00	RES,CHIP	470 5% 1/10W
R604	1-216-097-91	RES,CHIP	100K 5% 1/10W	R913	1-216-049-91	RES,CHIP	1K 5% 1/10W
R607	1-249-425-11	CARBON	4.7K 5% 1/4W	R914	1-216-055-00	RES,CHIP	1.8K 5% 1/10W
R608	1-240-205-91	CARBON	22M 5% 1/2W	R915	1-216-061-00	RES,CHIP	3.3K 5% 1/10W
R609	1-216-057-00	RES,CHIP	2.2K 5% 1/10W	R916	1-216-017-91	RES,CHIP	47 5% 1/10W
R610	1-216-073-00	RES,CHIP	10K 5% 1/10W	R917	1-216-041-00	RES,CHIP	470 5% 1/10W
R611	1-216-089-91	RES,CHIP	47K 5% 1/10W	R918	1-216-041-00	RES,CHIP	470 5% 1/10W
R612	1-216-045-00	RES,CHIP	680 5% 1/10W			<RELAY>	
R614	1-216-041-00	RES,CHIP	470 5% 1/10W				
R615	1-216-350-11	METAL OXIDE	1.2 5% 1W F	R601 $\Delta$	1-755-266-11	RELAY, AC POWER	
R616	1-260-302-51	CARBON	6.8 5% 1/2W F			<SWITCH>	
R617	1-247-791-91	CARBON	22 5% 1/4W				
R619	1-260-128-11	CARBON	270K 5% 1/2W	S502	1-572-707-11	SWITCH, LEVER	
R620	1-215-915-11	METAL OXIDE	470 5% 3W F	S600 $\Delta$	1-571-433-31	SWITCH, PUSH (AC POWER)	
R622	1-215-908-00	METAL OXIDE	33 5% 3W F	S901	1-692-431-21	SWITCH, TACTILE	
R623	1-216-095-00	RES,CHIP	82K 5% 1/10W	S902	1-692-431-21	SWITCH, TACTILE	
R624	1-216-089-91	RES,CHIP	47K 5% 1/10W	S903	1-692-431-21	SWITCH, TACTILE	
R626	1-216-049-91	RES,CHIP	1K 5% 1/10W	S904	1-692-431-21	SWITCH, TACTILE	
R627	1-240-251-11	CMT,MELF	6.8 5% 10W	S905	1-692-431-21	SWITCH, TACTILE	
R629	1-247-747-11	CARBON	470 5% 1/2W F	S906	1-692-431-21	SWITCH, TACTILE	
R630	1-249-429-11	CARBON	10K 5% 1/4W F	S907	1-692-431-21	SWITCH, TACTILE	
R631	1-216-089-91	RES,CHIP	47K 5% 1/10W			<TRANSFORMER>	
R632	1-202-933-61	FUSIBLE	0.1 10% 1/2W F	T501	1-437-195-11	TRANSFORMER, HORIZONTAL DRIVE	
R634 $\Delta$	1-218-265-91	METAL	8.2M 5% 1W	T503 $\Delta$	1-453-293-11	TRANSFORMER ASSY, FLYBACK (NX-1748/M3A4)	
R635	1-216-492-11	METAL OXIDE	82K 5% 3W F	T601	1-424-682-11	TRANSFORMER, LINE FILTER	
R636	1-215-924-00	METAL OXIDE	15K 5% 3W F	T603 $\Delta$	1-433-513-31	TRANSFORMER, CONVERTER (SRT)	
R637	1-216-492-11	METAL OXIDE	82K 5% 3W F	T604 $\Delta$	1-431-852-11	TRANSFORMER, CONVERTER (SRT)	
R639	1-216-363-00	METAL OXIDE	0.33 5% 2W F			<THERMISTOR>	
R640	1-249-415-11	CARBON	680 5% 1/4W	THP600	1-810-961-11	THERMISTOR, POSITIVE	
R641	1-216-362-11	METAL OXIDE	0.27 5% 2W F			<TUNER>	
R642	1-249-419-11	CARBON	1.5K 5% 1/4W	TU101	8-598-449-01	TUNER, FSS BTF-LG433	
R643	1-247-843-11	CARBON	3.3K 5% 1/4W				
R644	1-249-419-11	CARBON	1.5K 5% 1/4W				
R646	1-215-924-00	METAL OXIDE	15K 5% 3W F				
R647	1-249-401-11	CARBON	47 5% 1/4W				
R648	1-216-057-00	RES,CHIP	2.2K 5% 1/10W				
R649	1-249-417-11	CARBON	1K 5% 1/4W				
R650	1-215-882-00	METAL OXIDE	22 5% 2W F				
R652	1-215-900-11	METAL OXIDE	22K 5% 2W F				
R653	1-215-873-00	METAL OXIDE	4.7K 5% 1W F				
R657	1-260-127-11	CARBON	220K 5% 1/2W				
R659	1-216-049-91	RES,CHIP	1K 5% 1/10W				
R660	1-216-073-00	RES,CHIP	10K 5% 1/10W				

**A (KV-XF21M83/XF51M65)**

REF. NO.	PART NO.	DESCRIPTION	REMARK	REF. NO.	PART NO.	DESCRIPTION	REMARK
		<CRYSTAL>					
X001	1-579-125-11	VIBRATOR, CERAMIC		C104	1-126-933-11	ELECT 100MF	20% 16V
X301	1-781-134-21	VIBRATOR, CRYSTAL		C107	1-163-005-11	CERAMIC CHIP 470PF	10% 50V
X302	1-781-132-21	VIBRATOR, CRYSTAL		C108	1-126-933-11	ELECT 100MF	20% 16V
				C109	1-163-005-11	CERAMIC CHIP 470PF	10% 50V
				C110	1-163-005-11	CERAMIC CHIP 470PF	10% 50V
*****							
* A-1298-932-A	A BOARD, COMPLETE (KV-XF21M83)	*****		C111	1-163-005-11	CERAMIC CHIP 470PF	10% 50V
* A-1298-953-A	A BOARD, COMPLETE (KV-XF51M65)	*****		C112	1-126-933-11	ELECT 100MF	20% 16V
* 4-055-304-01	HOLDER, LED			C113	1-126-967-11	ELECT 47MF	20% 50V
* 4-067-182-02	HOLDER, FBT			C114	1-126-967-11	ELECT 47MF	20% 50V
4-352-844-01	PIN, LEAD, COATING (KV-XF21M83 ONLY)			C202	1-163-017-00	CERAMIC CHIP 0.0047MF	10% 50V
4-382-854-11	SCREW (M3X10), P, SW (+)			C203	1-163-017-00	CERAMIC CHIP 0.0047MF	10% 50V
4-382-854-21	SCREW (M3X14), P, SW (+)			C204	1-136-169-00	FILM 0.22MF	5% 50V
7-685-648-79	SCREW +BVTP 3X12 TYPE2 IT-3			C205	1-163-019-00	CERAMIC CHIP 0.0068MF	10% 50V
				C206	1-163-019-00	CERAMIC CHIP 0.0068MF	10% 50V
				C207	1-136-169-00	FILM 0.22MF	5% 50V
				C208	1-126-963-11	ELECT 4.7MF	20% 50V
				C209	1-126-963-11	ELECT 4.7MF	20% 50V
				C210	1-126-933-11	ELECT 100MF	20% 16V
				C211	1-126-941-11	ELECT 470MF	20% 25V
				C212	1-126-933-11	ELECT 100MF	20% 16V
				C213	1-126-933-11	ELECT 100MF	20% 16V
				C214	1-126-942-61	ELECT 1000MF	20% 25V
				C215	1-126-942-61	ELECT 1000MF	20% 25V
				C216	1-163-021-91	CERAMIC CHIP 0.01MF	10% 50V
				C217	1-126-964-11	ELECT 10MF	20% 50V
C004	1-163-001-11	CERAMIC CHIP 220PF	10% 50V	C218	1-136-167-00	FILM 0.15MF	5% 50V
C005	1-163-001-11	CERAMIC CHIP 220PF	10% 50V	C219	1-136-167-00	FILM 0.15MF	5% 50V
C006	1-164-004-11	CERAMIC CHIP 0.1MF	10% 25V	C220	1-126-942-61	ELECT 1000MF	20% 25V
C007	1-126-933-11	ELECT 100MF	20% 16V	C221	1-126-964-11	ELECT 10MF	20% 50V
C008	1-163-251-11	CERAMIC CHIP 100PF	5% 50V	C223	1-126-965-11	ELECT 22MF	20% 50V
C010	1-163-251-11	CERAMIC CHIP 100PF	5% 50V	C224	1-163-133-00	CERAMIC CHIP 470PF	5% 50V
C012	1-163-251-11	CERAMIC CHIP 100PF	5% 50V	C225	1-109-982-11	CERAMIC CHIP 1MF	10% 10V
C013	1-163-021-91	CERAMIC CHIP 0.01MF	10% 50V	C226	1-109-982-11	CERAMIC CHIP 1MF	10% 10V
C014	1-126-967-11	ELECT 47MF	20% 50V	C227	1-163-037-11	CERAMIC CHIP 0.022MF	10% 50V
C015	1-163-009-11	CERAMIC CHIP 0.001MF	10% 50V	C228	1-163-024-00	CERAMIC CHIP 0.018MF	10% 50V
C016	1-163-113-00	CERAMIC CHIP 68PF	5% 50V	C229	1-163-018-00	CERAMIC CHIP 0.0056MF	10% 50V
C017	1-163-113-00	CERAMIC CHIP 68PF	5% 50V	C230	1-163-024-00	CERAMIC CHIP 0.018MF	10% 50V
C019	1-104-665-11	ELECT 100MF	20% 25V	C231	1-163-018-00	CERAMIC CHIP 0.0056MF	10% 50V
C022	1-163-227-11	CERAMIC CHIP 10PF	0.5PF 50V	C232	1-163-037-11	CERAMIC CHIP 0.022MF	10% 50V
C023	1-163-227-11	CERAMIC CHIP 10PF	0.5PF 50V	C233	1-164-004-11	CERAMIC CHIP 0.1MF	10% 25V
C024	1-163-227-11	CERAMIC CHIP 10PF	0.5PF 50V	C234	1-164-004-11	CERAMIC CHIP 0.1MF	10% 25V
C026	1-164-004-11	CERAMIC CHIP 0.1MF	10% 25V	C235	1-164-004-11	CERAMIC CHIP 0.1MF	10% 25V
C027	1-164-004-11	CERAMIC CHIP 0.1MF	10% 25V	C236	1-164-004-11	CERAMIC CHIP 0.1MF	10% 25V
C028	1-163-037-11	CERAMIC CHIP 0.022MF	10% 50V	C238	1-164-505-11	CERAMIC CHIP 2.2MF	16V
C030	1-126-965-11	ELECT 22MF	20% 50V	C240	1-164-505-11	CERAMIC CHIP 2.2MF	16V
C031	1-164-004-11	CERAMIC CHIP 0.1MF	10% 25V	C241	1-164-346-11	CERAMIC CHIP 1MF	16V
C032	1-107-823-11	CERAMIC CHIP 0.47MF	10% 16V	C242	1-164-505-11	CERAMIC CHIP 2.2MF	16V
C034	1-163-031-11	CERAMIC CHIP 0.01MF	50V	C243	1-216-295-91	SHORT 0	
C041	1-163-251-11	CERAMIC CHIP 100PF	5% 50V	C244	1-164-700-11	CERAMIC CHIP 0.68MF	16V
C042	1-163-251-11	CERAMIC CHIP 100PF	5% 50V	C245	1-164-346-11	CERAMIC CHIP 1MF	16V
C043	1-163-251-11	CERAMIC CHIP 100PF	5% 50V	C246	1-163-018-00	CERAMIC CHIP 0.0056MF	10% 50V
C044	1-163-251-11	CERAMIC CHIP 100PF	5% 50V	C247	1-164-346-11	CERAMIC CHIP 1MF	16V
C047	1-163-251-11	CERAMIC CHIP 100PF	5% 50V	C248	1-163-010-11	CERAMIC CHIP 0.0012MF	10% 50V
C048	1-163-251-11	CERAMIC CHIP 100PF	5% 50V	C249	1-164-004-11	CERAMIC CHIP 0.1MF	10% 25V
C050	1-163-251-11	CERAMIC CHIP 100PF	5% 50V	C250	1-216-295-91	SHORT 0	
C051	1-163-251-11	CERAMIC CHIP 100PF	5% 50V	C251	1-163-017-00	CERAMIC CHIP 0.0047MF	10% 50V
C053	1-163-251-11	CERAMIC CHIP 100PF	5% 50V	C252	1-164-346-11	CERAMIC CHIP 1MF	16V
C054	1-163-251-11	CERAMIC CHIP 100PF	5% 50V				
C055	1-163-251-11	CERAMIC CHIP 100PF	5% 50V				
C103	1-164-004-11	CERAMIC CHIP 0.1MF	10% 25V				

The components identified by shading and mark  $\Delta$  are critical for safety. Replace only with part number specified.

# A (KV-XF21M83/XF51M65)

REF. NO.	PART NO.	DESCRIPTION	REMARK	REF. NO.	PART NO.	DESCRIPTION	REMARK
C253	1-163-037-11	CERAMIC CHIP	0.022MF 10% 50V	C514	1-107-368-11	MYLAR	0.047MF 99% 200V
C254	1-126-965-11	ELECT	22MF 20% 50V	C517	1-164-182-11	CERAMIC CHIP	0.0033MF 10% 50V
C255	1-163-037-11	CERAMIC CHIP	0.022MF 10% 50V	C518	1-104-665-11	ELECT	100MF 20% 10V
C256	1-164-004-11	CERAMIC CHIP	0.1MF 10% 25V	C519	1-102-212-00	CERAMIC	820PF 10% 500V
C259	1-126-933-11	ELECT	100MF 20% 16V	C521	1-126-934-11	ELECT	220MF 20% 16V
C264	1-164-505-11	CERAMIC CHIP	2.2MF 16V	C522	1-126-933-11	ELECT	100MF 20% 16V
C265	1-164-505-11	CERAMIC CHIP	2.2MF 16V	C523	1-102-002-00	CERAMIC	680PF 10% 500V
C301	1-126-935-11	ELECT	470MF 20% 16V	C524	1-126-967-11	ELECT	47MF 20% 50V
C302	1-163-005-11	CERAMIC CHIP	470PF 10% 50V	C526	1-130-495-00	MYLAR	0.1MF 5% 50V
C303	1-126-964-11	ELECT	10MF 20% 50V	C527	1-102-820-00	CERAMIC	330PF 5% 50V
C304	1-126-967-11	ELECT	47MF 20% 50V	C528	1-162-134-11	CERAMIC	470PF 10% 2KV
C305	1-164-004-11	CERAMIC CHIP	0.1MF 10% 25V	C530	1-137-372-11	FILM	0.022MF 5% 50V
C306	1-163-233-11	CERAMIC CHIP	18PF 5% 50V	C531	1-126-961-11	ELECT	2.2MF 20% 50V
C307	1-163-233-11	CERAMIC CHIP	18PF 5% 50V	C532	1-126-941-11	ELECT	470MF 20% 25V
C308	1-163-259-91	CERAMIC CHIP	220PF 5% 50V	C533	1-126-941-11	ELECT	470MF 20% 25V
C309	1-126-957-11	ELECT	0.22MF 20% 50V	C536	1-136-165-00	FILM	0.1MF 5% 50V
C310	1-126-963-11	ELECT	4.7MF 20% 50V	C537	1-126-969-11	ELECT	220MF 20% 50V
C311	1-126-964-11	ELECT	10MF 20% 50V	C538	1-136-076-00	FILM	0.0085MF 3% 2KV
C312	1-164-346-11	CERAMIC CHIP	1MF 16V	C539	1-129-746-91	FILM	0.039MF 5% 400V
C313	1-164-346-11	CERAMIC CHIP	1MF 16V	C540	1-136-171-00	FILM	0.33MF 5% 50V
C315	1-164-004-11	CERAMIC CHIP	0.1MF 10% 25V	C546	1-165-319-11	CERAMIC CHIP	0.1MF 50V
C316	1-126-967-11	ELECT	47MF 20% 50V	C549	1-163-017-00	CERAMIC CHIP	0.0047MF 10% 50V
C317	1-164-004-11	CERAMIC CHIP	0.1MF 10% 25V	C550	1-106-220-00	MYLAR	0.1MF 10% 100V
C318	1-163-031-11	CERAMIC CHIP	0.01MF 50V	C551	1-126-960-11	ELECT	1MF 20% 50V
C319	1-163-031-11	CERAMIC CHIP	0.01MF 50V	C552	1-162-116-00	CERAMIC	680PF 10% 2KV
C320	1-163-031-11	CERAMIC CHIP	0.01MF 50V	C553	1-162-116-00	CERAMIC	680PF 10% 2KV
C322	1-163-005-11	CERAMIC CHIP	470PF 10% 50V	C554	1-137-417-11	MYLAR	0.0047MF 10% 200V
C323	1-126-965-11	ELECT	22MF 20% 50V	C556	1-126-941-11	ELECT	470MF 20% 25V
C324	1-163-017-00	CERAMIC CHIP	0.0047MF 10% 50V	C557	1-126-941-11	ELECT	470MF 20% 25V
C325	1-126-960-11	ELECT	1MF 20% 50V	C558	1-123-024-21	ELECT	33MF 160V
C327	1-126-965-11	ELECT	22MF 20% 50V	C560	1-102-228-00	CERAMIC	470PF 10% 500V
C328	1-164-004-11	CERAMIC CHIP	0.1MF 10% 25V	C561	1-136-557-11	FILM	0.0033MF 5% 630V
C329	1-126-965-11	ELECT	22MF 20% 50V	C562	1-102-228-00	CERAMIC	470PF 10% 500V
C330	1-164-004-11	CERAMIC CHIP	0.1MF 10% 25V	C564	1-163-038-91	CERAMIC CHIP	0.1MF 25V
C331	1-247-807-31	CARBON	100 5% 1/4W	C565	1-107-655-11	ELECT	47MF 20% 250V
C332	1-126-963-11	ELECT	4.7MF 20% 50V	C566	1-102-244-00	CERAMIC	220PF 10% 500V
C335	1-164-004-11	CERAMIC CHIP	0.1MF 10% 25V	C567	1-115-521-11	FILM	0.82MF 5% 250V
C336	1-164-004-11	CERAMIC CHIP	0.1MF 10% 25V	C568	1-102-228-00	CERAMIC	470PF 10% 500V
C337	1-126-961-11	ELECT	2.2MF 20% 50V	C570	1-115-520-11	FILM	0.68MF 5% 250V
C338	1-163-017-00	CERAMIC CHIP	0.0047MF 10% 50V	C573	1-108-427-61	MYLAR	0.033MF 10% 200V
C341	1-115-340-11	CERAMIC CHIP	0.22MF 10% 25V	C574	1-107-636-11	ELECT	10MF 20% 160V
C342	1-163-259-91	CERAMIC CHIP	220PF 5% 50V	C576	1-130-495-00	MYLAR	0.1MF 5% 50V
C401	1-164-346-11	CERAMIC CHIP	1MF 16V	C577	1-106-395-00	MYLAR	0.15MF 10% 200V
C402	1-164-346-11	CERAMIC CHIP	1MF 16V	C582	1-164-004-11	CERAMIC CHIP	0.1MF 10% 25V
C403	1-163-005-11	CERAMIC CHIP	470PF 10% 50V	C600 $\Delta$	1-104-705-51	FILM	0.1MF 20% 250V
C404	1-163-005-11	CERAMIC CHIP	470PF 10% 50V	C604	1-163-009-11	CERAMIC CHIP	0.001MF 10% 50V
C405	1-126-935-11	ELECT	470MF 20% 16V	C605 $\Delta$	1-127-942-51	CERAMIC	330PF 10% 250V
C406	1-164-346-11	CERAMIC CHIP	1MF 16V	C606 $\Delta$	1-127-942-51	CERAMIC	330PF 10% 250V
C407	1-164-346-11	CERAMIC CHIP	1MF 16V	C607	1-161-830-00	CERAMIC	0.0047MF 99% 500V
C408	1-163-133-00	CERAMIC CHIP	470PF 5% 50V	C608	1-161-830-00	CERAMIC	0.0047MF 99% 500V
C409	1-126-963-11	ELECT	4.7MF 20% 50V	C609	1-126-968-11	ELECT	100MF 20% 50V
C415	1-163-133-00	CERAMIC CHIP	470PF 5% 50V	C610	1-126-964-11	ELECT	10MF 20% 50V
C502	1-163-145-00	CERAMIC CHIP	0.0015MF 5% 50V	C611	1-161-830-00	CERAMIC	0.0047MF 99% 500V
C506	1-107-638-11	ELECT	33MF 20% 160V	C612	1-161-830-00	CERAMIC	0.0047MF 99% 500V
C507	1-161-830-00	CERAMIC	0.0047MF 500V	C613	1-117-752-11	ELECT(BLOCK)	330MF 20% 450V
C510	1-102-112-00	CERAMIC	330PF 10% 50V	C614	1-126-964-11	ELECT	10MF 20% 50V
C512	1-163-989-11	CERAMIC CHIP	0.033MF 10% 25V	C616	1-130-202-00	FILM	0.022MF 10% 400V
C513	1-163-263-11	CERAMIC CHIP	330PF 5% 50V				

**A (KV-XF21M83/XF51M65)**

REF. NO.	PART NO.	DESCRIPTION	REMARK	REF. NO.	PART NO.	DESCRIPTION	REMARK
C617	1-107-792-11	CERAMIC	100PF 5%	1KV	CN307	* 1-774-813-11	CONNECTOR, BOARD TO BOARD 7P (KV-XF51M65 ONLY)
C618	1-125-893-11	FILM	680PF 3%	1.5KV	CN505	1-508-765-00	PIN, CONNECTOR (5MM PITCH) 3P
C619	1-119-886-51	CERAMIC	470PF 10%	250V	CN506	4-352-844-01	PIN, LEAD, COATING
C620	1-163-133-00	CERAMIC CHIP	470PF 5%	50V	CN507	* 1-564-507-11	PLUG, CONNECTOR 4P
C621	1-102-114-00	CERAMIC	470PF 10%	50V	CN601	* 1-580-843-11	PIN, CONNECTOR (POWER)
C622	1-102-074-00	CERAMIC	0.001MF 10%	50V	CN602	* 1-508-786-00	PIN, CONNECTOR (5MM PITCH) 2P
C623	1-104-665-11	ELECT	100MF 20%	25V	CN604	* 1-573-963-11	PIN, CONNECTOR (PC BOARD) 3P
C624	1-104-331-11	CERAMIC	0.0022MF 10%	1KV	CN605	* 1-564-507-11	PLUG, CONNECTOR 4P
C625	1-102-002-00	CERAMIC	680PF 10%	500V	CN609	* 1-508-784-21	PIN, CONNECTOR (5MM PITCH) 1P
C627	1-102-002-00	CERAMIC	680PF 10%	500V	CN901	* 1-564-509-11	PLUG, CONNECTOR 6P
C628	1-126-942-61	ELECT	1000MF 20%	25V			<COMPOSITION CIRCUIT BLOCK>
C629	1-126-964-11	ELECT	10MF 20%	50V	CP301	1-467-554-21	FILTER BLOCK, COMB
C630	1-123-024-21	ELECT	33MF	160V			<DIODE>
C631	1-128-550-11	ELECT	2200MF 20%	50V	D001	8-719-988-61	DIODE 1SS355TE-17
C633	1-104-999-11	MYLAR	0.1MF 10%	200V	D005	8-719-988-61	DIODE 1SS355TE-17
C634	1-126-933-11	ELECT	100MF 20%	16V	D006	8-719-988-61	DIODE 1SS355TE-17
C635	1-104-665-11	ELECT	100MF 20%	10V	D100	8-719-404-50	DIODE MA1111-TX (KV-XF51M65 ONLY)
C636	1-104-760-11	CERAMIC CHIP	0.047MF 10%	50V	D203	8-719-914-42	DIODE DA204K
C639	1-164-004-11	CERAMIC CHIP	0.1MF 10%	25V	D300	1-216-295-91	SHORT 0
C640	1-164-004-11	CERAMIC CHIP	0.1MF 10%	25V	D301	8-719-988-61	DIODE 1SS355TE-17
C641	1-102-002-00	CERAMIC	680PF 10%	500V	D306	8-719-988-61	DIODE 1SS355TE-17
C642	1-126-943-11	ELECT	2200MF 20%	25V	D307	8-719-988-61	DIODE 1SS355TE-17
C643	1-104-665-11	ELECT	100MF 20%	10V	D308	8-719-988-61	DIODE 1SS355TE-17
C644	1-104-331-11	CERAMIC	0.0022MF 10%	1KV	D309	8-719-159-10	DIODE RD5.1SB-T2
C645	1-137-605-11	FILM	0.01MF 10%	250V	D311	8-719-988-61	DIODE 1SS355TE-17
C646	1-107-679-41	ELECT	10MF 20%	450V	D312	8-719-988-61	DIODE 1SS355TE-17
C647	1-163-275-11	CERAMIC CHIP	0.001MF 5%	50V	D313	8-719-988-61	DIODE 1SS355TE-17
C649	1-126-940-11	ELECT	330MF 20%	25V	D314	8-719-988-61	DIODE 1SS355TE-17
C650	1-163-275-11	CERAMIC CHIP	0.001MF 5%	50V	D315	8-719-988-61	DIODE 1SS355TE-17
C651	1-163-133-00	CERAMIC CHIP	470PF 5%	50V	D316	8-719-069-57	DIODE UDZS-TE17-6.8B
C652	1-126-965-11	ELECT	22MF 20%	50V	D401	8-719-158-35	DIODE RD9.1SB
C653	1-104-664-11	ELECT	47MF 20%	25V	D402	8-719-158-35	DIODE RD9.1SB
C657	1-101-821-00	CERAMIC	0.0022MF	500V	D403	8-719-158-35	DIODE RD9.1SB
C658	1-164-004-11	CERAMIC CHIP	0.1MF 10%	25V	D404	8-719-158-35	DIODE RD9.1SB
C901	1-136-153-00	FILM	0.01MF 5%	50V	D405	8-719-158-35	DIODE RD9.1SB
C902	1-136-153-00	FILM	0.01MF 5%	50V	D406	8-719-158-35	DIODE RD9.1SB
C905	1-126-963-11	ELECT	4.7MF 20%	50V	D504	8-719-302-43	DIODE EL1Z
C906	1-164-346-11	CERAMIC CHIP	1MF	16V	D505	8-719-988-61	DIODE 1SS355TE-17
C907	1-163-133-00	CERAMIC CHIP	470PF 5%	50V	D506	8-719-911-19	DIODE 1SS119-25
C908	1-163-133-00	CERAMIC CHIP	470PF 5%	50V	D507	8-719-988-61	DIODE 1SS355TE-17
C909	1-164-346-11	CERAMIC CHIP	1MF	16V	D508	8-719-988-61	DIODE 1SS355TE-17
C910	1-126-967-11	ELECT	47MF 20%	50V	D509	1-216-073-00	RES,CHIP 10K 5%
C911	1-126-967-11	ELECT	47MF 20%	50V	D510	8-719-988-61	DIODE 1SS355TE-17
C912	1-164-004-11	CERAMIC CHIP	0.1MF 10%	25V	D511	8-719-988-61	DIODE 1SS355TE-17
C913	1-126-933-11	ELECT	100MF 20%	16V	D512	8-719-988-61	DIODE 1SS355TE-17
C914	1-163-133-00	CERAMIC CHIP	470PF 5%	50V	D513	8-719-908-03	DIODE GP08D
		<CONNECTOR>			D517	8-719-945-80	DIODE ERC06-15S
CN104	1-695-915-11	TAB (CONTACT)			D518	8-719-900-26	DIODE ERD29-08J
CN201	* 1-564-510-11	PLUG, CONNECTOR 7P			D521	8-719-302-43	DIODE EL1Z
CN202	* 1-785-608-11	PIN, CONNECTOR 4P			D522	8-719-302-43	DIODE EL1Z
CN203	* 1-564-506-11	PLUG, CONNECTOR 3P			D523	8-719-302-43	DIODE EL1Z
CN204	* 1-564-506-11	PLUG, CONNECTOR 3P			D527	8-719-908-03	DIODE GP08D
CN301	* 1-774-813-11	CONNECTOR, BOARD TO BOARD 7P (KV-XF51M65 ONLY)			D528	8-719-908-03	DIODE GP08D
CN305	* 1-564-509-11	PLUG, CONNECTOR 6P					
CN306	* 1-564-510-11	PLUG, CONNECTOR 7P					

**A (KV-XF21M83/XF51M65)**

REF. NO.	PART NO.	DESCRIPTION	REMARK	REF. NO.	PART NO.	DESCRIPTION	REMARK
D531	8-719-988-61	DIODE 1SS355TE-17				<IC>	
D532	8-719-988-61	DIODE 1SS355TE-17					
D602	8-719-911-19	DIODE 1SS119-25		IC001	8-752-905-21	IC CXP86449-6155	
D603	8-719-150-92	DIODE RD33EB3T		IC002	8-759-371-21	IC MM1319AFBE	
D604	8-719-028-72	DIODE RGP02-17EL-6433		IC003	8-759-370-34	IC ST24C08FB6	
				IC100	8-759-042-02	IC S-80743AL-A7-S (KV-XF51M65 ONLY)	
D605	8-719-510-53	DIODE D4SB60L		IC201	8-759-339-60	IC TA8248K	
D606	8-719-108-18	THYRISTOR 5P6M					
D607	8-719-404-50	DIODE MA111-TX		IC203	8-759-553-40	IC TDA7429S	
D608	8-719-110-53	DIODE RD20ESB2		IC301	8-752-088-39	IC CXA2130S	
D609	8-719-311-31	DIODE RU-1P		IC502	8-759-700-07	IC NJM2903M	
				IC503	8-759-980-58	IC TDA8172	
D610	8-719-043-76	DIODE AK04V0		IC601	8-749-013-75	IC STR-F6654	
D611	8-719-046-74	DIODE AU-01Z-V1					
D613	8-719-046-74	DIODE AU-01Z-V1		IC602	8-749-920-61	IC SE-135N	
D614	8-719-046-74	DIODE AU-01Z-V1		IC603	8-759-701-59	IC NJM78M09FA	
D616	8-719-067-18	DIODE RN4Z		IC604	8-759-231-53	IC TA7805S	
				IC901	8-742-014-11	HYB IC SBX1981-51	
D618	8-719-067-18	DIODE RN4Z					
D620	8-719-110-72	DIODE RD30ESB2					
D622	8-719-071-39	DIODE FMU-G26S				<JACK>	
D623	8-719-978-65	DIODE DTZ-TT11-15B		J401	1-779-850-11	JACK BLOCK, PIN 6P	
D624	8-719-404-50	DIODE MA111-TX		J902	1-770-329-11	JACK, PIN 3P	
D625	8-719-158-39	DIODE RD10SB					
D627	8-719-073-84	DIODE 31DQ06-FC5					
D628	8-719-911-19	DIODE 1SS119-25				<CHIP CONDUCTOR>	
D631	8-719-068-00	DIODE ERC04-06SE		JR002	1-216-295-91	SHORT	0
D632	8-719-068-00	DIODE ERC04-06SE		JR003	1-216-295-91	SHORT	0
				JR004	1-216-295-91	SHORT	0
D633	8-719-948-45	DIODE ERA22-08		JR005	1-216-295-91	SHORT	0
D634	8-719-404-50	DIODE MA111-TX		JR006	1-216-295-91	SHORT	0
D635	8-719-404-50	DIODE MA111-TX					
D636	8-719-510-02	DIODE D1NS4		JR007	1-216-295-91	SHORT	0
D637	8-719-109-96	DIODE RD6.8ESB1		JR008	1-216-295-91	SHORT	0
				JR009	1-216-295-91	SHORT	0
D638	8-719-510-48	DIODE D1N20R		JR010	1-216-295-91	SHORT	0
D901	8-719-158-35	DIODE RD9.1SB		JR011	1-216-295-91	SHORT	0
D902	8-719-158-35	DIODE RD9.1SB					
D903	8-719-158-35	DIODE RD9.1SB		JR012	1-216-295-91	SHORT	0
D904	8-719-158-35	DIODE RD9.1SB		JR013	1-216-295-91	SHORT	0
				JR014	1-216-295-91	SHORT	0
D905	8-719-158-35	DIODE RD9.1SB		JR015	1-216-295-91	SHORT	0
D906	8-719-045-19	DIODE SPB-26MVWF		JR016	1-216-295-91	SHORT	0
		<CONNECTOR>		JR018	1-216-295-91	SHORT	0
				JR019	1-216-295-91	SHORT	0
DY1	* 1-580-798-11	CONNECTOR PIN (DY) 6P		JR102	1-216-295-91	SHORT	0
				JR107	1-216-295-91	SHORT	0 (KV-XF51M65 ONLY)
				JR109	1-216-295-91	SHORT	0 (KV-XF21M83 ONLY)
		<FERRITE BEAD>					
FB103	1-410-397-21	FERRITE	1.1UH	JR202	1-216-295-91	SHORT	0
FB501	1-410-397-21	FERRITE	1.1UH	JR301	1-216-295-91	SHORT	0
FB502	1-410-397-21	FERRITE	1.1UH	JR303	1-216-295-91	SHORT	0
FB600	1-410-397-21	FERRITE	1.1UH	JR401	1-216-295-91	SHORT	0
FB601	1-410-397-21	FERRITE	1.1UH	JR403	1-216-295-91	SHORT	0
FB602	1-410-397-21	FERRITE	1.1UH	JR404	1-216-295-91	SHORT	0
FB603	1-410-397-21	FERRITE	1.1UH	JR405	1-216-295-91	SHORT	0
FB604	1-410-397-21	FERRITE	1.1UH	JR500	1-216-295-91	SHORT	0
FB605	1-412-911-31	FERRITE	0UH	JR501	1-216-295-91	SHORT	0
FB607	1-410-397-21	FERRITE	1.1UH	JR600	1-216-295-91	SHORT	0
FB608	1-412-911-31	FERRITE	0UH			<COIL>	
FB611	1-410-397-21	FERRITE	1.1UH				
FB613	1-410-397-21	FERRITE	1.1UH	L002	1-414-856-11	INDUCTOR	10UH
FB615	1-410-397-21	FERRITE	1.1UH	L003	1-414-180-11	INDUCTOR	3.3UH

The components identified by shading and mark  $\Delta$  are critical for safety. Replace only with part number specified.

# A (KV-XF21M83/XF51M65)

REF. NO.	PART NO.	DESCRIPTION	REMARK	REF. NO.	PART NO.	DESCRIPTION	REMARK
L005	1-414-233-22	INDUCTOR CHIP	0UH	Q315	8-729-421-19	TRANSISTOR UN2213	
L101	1-414-856-11	INDUCTOR	10UH	Q401	8-729-424-67	TRANSISTOR UN2216	
L102	1-414-856-11	INDUCTOR	10UH	Q402	8-729-424-67	TRANSISTOR UN2216	
L103	1-414-856-11	INDUCTOR	10UH	Q403	8-729-216-22	TRANSISTOR 2SA1162-G	
L104	1-414-856-11	INDUCTOR	10UH	Q404	8-729-216-22	TRANSISTOR 2SA1162-G	
L105	1-414-856-11	INDUCTOR	10UH	Q503	8-729-230-49	TRANSISTOR 2SC2712-YG	
L204	1-414-856-11	INDUCTOR	10UH	Q505	8-729-931-45	TRANSISTOR IRF614	
L301	1-414-189-31	INDUCTOR	100UH	Q506	8-729-140-96	TRANSISTOR 2SD774-34	
L302	1-414-185-41	INDUCTOR	22UH	Q507	8-729-216-22	TRANSISTOR 2SA1162-G	
L501	1-412-525-31	INDUCTOR	10UH	Q509	8-729-230-49	TRANSISTOR 2SC2712-YG	
L502	1-422-613-11	COIL, AIR CORE		Q511	8-729-048-07	TRANSISTOR 2SD2578-CA	
L503	1-412-525-31	INDUCTOR	10UH	Q601	8-729-023-22	TRANSISTOR 2SD2114K	
L504	1-412-525-31	INDUCTOR	10UH	Q602	8-729-230-49	TRANSISTOR 2SC2712-YG	
L505	1-412-525-31	INDUCTOR	10UH	Q603	8-729-424-08	TRANSISTOR UN2111	
L506	1-412-525-31	INDUCTOR	10UH	Q604	8-729-200-17	TRANSISTOR 2SA1091-O	
L507	1-459-111-00	INDUCTOR	10MMH	Q605	8-729-044-30	TRANSISTOR 2SK2845-LB102	
L508	1-412-525-31	INDUCTOR	10UH	Q606	8-729-230-49	TRANSISTOR 2SC2712-YG	
L509	1-459-390-00	INDUCTOR	390UH	Q607	8-729-922-37	TRANSISTOR 2SD2144S-UVW	
L510	1-416-972-11	COIL, HORIZONTAL LINEARITY		Q608	8-729-230-49	TRANSISTOR 2SC2712-YG	
L512	1-412-549-31	INDUCTOR	1MMH	Q901	8-729-421-19	TRANSISTOR UN2213	
L513	1-412-549-31	INDUCTOR	1MMH	Q902	8-729-421-19	TRANSISTOR UN2213	
L515	1-459-104-00	COIL, WITH CORE				<RESISTOR>	
L518	1-408-611-31	INDUCTOR	47UH				
L601	1-412-527-11	INDUCTOR	15UH	R001	1-414-233-22	INDUCTOR CHIP	0UH
L901	1-408-603-31	INDUCTOR	10UH	R002	1-216-025-91	RES,CHIP	100 5% 1/10W
L902	1-408-603-31	INDUCTOR	10UH	R003	1-216-073-00	RES,CHIP	10K 5% 1/10W
L905	1-414-856-11	INDUCTOR	10UH	R004	1-216-025-91	RES,CHIP	100 5% 1/10W
		<PHOTO COUPLER>		R005	1-216-025-91	RES,CHIP	100 5% 1/10W
PH600 $\Delta$	8-749-924-35	PHOTO COUPLER ON3171-R		R007	1-216-295-91	SHORT	0
		<IC LINK>		R008	1-216-065-91	RES,CHIP	4.7K 5% 1/10W
PS200	1-532-675-21	LINK, IC 1.5A/150V		R010	1-216-065-91	RES,CHIP	4.7K 5% 1/10W
		<TRANSISTOR>		R011	1-216-065-91	RES,CHIP	4.7K 5% 1/10W
Q002	8-729-230-49	TRANSISTOR 2SC2712-YG		R012	1-216-065-91	RES,CHIP	4.7K 5% 1/10W
Q003	8-729-424-08	TRANSISTOR UN2111		R013	1-216-065-91	RES,CHIP	4.7K 5% 1/10W
Q004	8-729-421-22	TRANSISTOR UN2211		R014	1-216-025-91	RES,CHIP	100 5% 1/10W
Q101	8-729-230-49	TRANSISTOR 2SC2712-YG		R015	1-216-025-91	RES,CHIP	100 5% 1/10W
Q201	8-729-424-67	TRANSISTOR UN2216		R016	1-216-025-91	RES,CHIP	100 5% 1/10W
Q202	8-729-424-67	TRANSISTOR UN2216		R017	1-216-049-91	RES,CHIP	1K 5% 1/10W
Q203	8-729-421-19	TRANSISTOR UN2213		R018	1-216-033-00	RES,CHIP	220 5% 1/10W
Q204	8-729-216-22	TRANSISTOR 2SA1162-G		R019	1-216-073-00	RES,CHIP	10K 5% 1/10W
Q205	8-729-421-19	TRANSISTOR UN2213		R021	1-216-073-00	RES,CHIP	10K 5% 1/10W
Q206	8-729-421-19	TRANSISTOR UN2213		R022	1-216-033-00	RES,CHIP	220 5% 1/10W
Q207	8-729-421-19	TRANSISTOR UN2213		R024	1-216-057-00	RES,CHIP	2.2K 5% 1/10W
Q301	8-729-216-22	TRANSISTOR 2SA1162-G		R025	1-216-057-00	RES,CHIP	2.2K 5% 1/10W
Q302	8-729-230-49	TRANSISTOR 2SC2712-YG		R026	1-216-057-00	RES,CHIP	2.2K 5% 1/10W
Q303	8-729-216-22	TRANSISTOR 2SA1162-G		R027	1-216-073-00	RES,CHIP	10K 5% 1/10W
Q305	8-729-216-22	TRANSISTOR 2SA1162-G		R028	1-216-073-00	RES,CHIP	10K 5% 1/10W
Q306	8-729-216-22	TRANSISTOR 2SA1162-G				(KV-XF51M65 ONLY)	
Q307	8-729-230-49	TRANSISTOR 2SC2712-YG		R029	1-216-049-91	RES,CHIP	1K 5% 1/10W
Q308	8-729-216-22	TRANSISTOR 2SA1162-G		R031	1-216-049-91	RES,CHIP	1K 5% 1/10W
Q312	8-729-216-22	TRANSISTOR 2SA1162-G		R035	1-216-025-91	RES,CHIP	100 5% 1/10W
Q313	8-729-230-49	TRANSISTOR 2SC2712-YG		R036	1-216-025-91	RES,CHIP	100 5% 1/10W
				R037	1-216-025-91	RES,CHIP	100 5% 1/10W
				R040	1-216-025-91	RES,CHIP	100 5% 1/10W
				R041	1-216-025-91	RES,CHIP	100 5% 1/10W
				R042	1-216-295-91	SHORT	0
				R043	1-216-025-91	RES,CHIP	100 5% 1/10W

**A (KV-XF21M83/XF51M65)**

REF. NO.	PART NO.	DESCRIPTION		REMARK	REF. NO.	PART NO.	DESCRIPTION		REMARK		
R044	1-216-025-91	RES,CHIP	100	5%	1/10W	R301	1-216-073-00	RES,CHIP	10K	5%	1/10W
R045	1-414-233-22	INDUCTOR CHIP	0UH			R302	1-216-295-91	SHORT	0		
R046	1-216-049-91	RES,CHIP	1K	5%	1/10W	R303	1-216-049-91	RES,CHIP	1K	5%	1/10W
R047	1-414-233-22	INDUCTOR CHIP	0UH			R304	1-216-073-00	RES,CHIP	10K	5%	1/10W
R048	1-216-073-00	RES,CHIP	10K	5%	1/10W	R305	1-216-051-00	RES,CHIP	1.2K	5%	1/10W
R050	1-216-073-00	RES,CHIP	10K	5%	1/10W	R306	1-216-073-00	RES,CHIP	10K	5%	1/10W
R053	1-216-049-91	RES,CHIP	1K	5%	1/10W	R307	1-216-295-91	SHORT	0		
R055	1-216-073-00	RES,CHIP	10K	5%	1/10W	R308	1-216-025-91	RES,CHIP	100	5%	1/10W
R056	1-216-073-00	RES,CHIP	10K	5%	1/10W	R309	1-216-025-91	RES,CHIP	100	5%	1/10W
R061	1-216-033-00	RES,CHIP	220	5%	1/10W	R310	1-216-025-91	RES,CHIP	100	5%	1/10W
R062	1-216-041-00	RES,CHIP	470	5%	1/10W	R311	1-216-017-91	RES,CHIP	47	5%	1/10W
R063	1-216-037-00	RES,CHIP	330	5%	1/10W	R312	1-216-041-00	RES,CHIP	470	5%	1/10W
R064	1-216-037-00	RES,CHIP	330	5%	1/10W	R313	1-216-053-00	RES,CHIP	1.5K	5%	1/10W
R065	1-216-037-00	RES,CHIP	330	5%	1/10W	R314	1-216-045-00	RES,CHIP	680	5%	1/10W
R066	1-216-049-91	RES,CHIP	1K	5%	1/10W	R316	1-216-053-00	RES,CHIP	1.5K	5%	1/10W
R101	1-216-025-91	RES,CHIP	100	5%	1/10W	R317	1-216-077-00	RES,CHIP	15K	5%	1/10W
R102	1-216-025-91	RES,CHIP (KV-XF51M65 ONLY)	100	5%	1/10W	R318	1-216-051-00	RES,CHIP	1.2K	5%	1/10W
R105	1-216-295-91	SHORT	0			R319	1-216-025-91	RES,CHIP	100	5%	1/10W
R109	1-216-041-00	RES,CHIP	470	5%	1/10W	R320	1-216-065-91	RES,CHIP	4.7K	5%	1/10W
R111	1-216-025-91	RES,CHIP	100	5%	1/10W	R321	1-216-073-00	RES,CHIP	10K	5%	1/10W
R112	1-216-025-91	RES,CHIP	100	5%	1/10W	R322	1-216-033-00	RES,CHIP	220	5%	1/10W
R113	1-216-047-91	RES,CHIP	820	5%	1/10W	R326	1-216-295-91	SHORT	0		
R202	1-216-053-00	RES,CHIP	1.5K	5%	1/10W	R331	1-216-295-91	SHORT	0		
R203	1-216-049-91	RES,CHIP	1K	5%	1/10W	R332	1-216-033-00	RES,CHIP	220	5%	1/10W
R204	1-216-069-00	RES,CHIP	6.8K	5%	1/10W	R333	1-216-073-00	RES,CHIP	10K	5%	1/10W
R205	1-216-069-00	RES,CHIP	6.8K	5%	1/10W	R334	1-216-129-00	RES,CHIP	2.2M	5%	1/10W
R206	1-216-049-91	RES,CHIP	1K	5%	1/10W	R335	1-216-045-00	RES,CHIP	680	5%	1/10W
R207	1-216-053-00	RES,CHIP	1.5K	5%	1/10W	R338	1-216-033-00	RES,CHIP	220	5%	1/10W
R208	1-216-069-00	RES,CHIP	6.8K	5%	1/10W	R340	1-216-025-91	RES,CHIP	100	5%	1/10W
R209	1-216-069-00	RES,CHIP	6.8K	5%	1/10W	R345	1-216-081-00	RES,CHIP	22K	5%	1/10W
R211	1-216-033-00	RES,CHIP	220	5%	1/10W	R346	1-216-051-00	RES,CHIP	1.2K	5%	1/10W
R212	1-216-033-00	RES,CHIP	220	5%	1/10W	R347	1-216-051-00	RES,CHIP	1.2K	5%	1/10W
R213	1-216-073-00	RES,CHIP	10K	5%	1/10W	R348	1-216-675-11	METAL CHIP	10K	0.50%	1/10W
R214	1-216-073-00	RES,CHIP	10K	5%	1/10W	R349	1-216-073-00	RES,CHIP	10K	5%	1/10W
R215	1-216-059-00	RES,CHIP	2.7K	5%	1/10W	R350	1-216-061-00	RES,CHIP	3.3K	5%	1/10W
R216	1-216-059-00	RES,CHIP	2.7K	5%	1/10W	R351	1-216-053-00	RES,CHIP	1.5K	5%	1/10W
R217	1-216-067-00	RES,CHIP	5.6K	5%	1/10W	R354	1-216-057-00	RES,CHIP	2.2K	5%	1/10W
R218	1-216-067-00	RES,CHIP	5.6K	5%	1/10W	R355	1-216-057-00	RES,CHIP	2.2K	5%	1/10W
R219	1-216-025-91	RES,CHIP	100	5%	1/10W	R356	1-216-057-00	RES,CHIP	2.2K	5%	1/10W
R220	1-216-025-91	RES,CHIP	100	5%	1/10W	R357	1-216-079-00	RES,CHIP	18K	5%	1/10W
R221	1-216-295-91	SHORT	0			R358	1-216-049-91	RES,CHIP	1K	5%	1/10W
R222	1-216-295-91	SHORT	0			R359	1-216-033-00	RES,CHIP	220	5%	1/10W
R225	1-216-033-00	RES,CHIP	220	5%	1/10W	R360	1-216-033-00	RES,CHIP	220	5%	1/10W
R226	1-216-033-00	RES,CHIP	220	5%	1/10W	R361	1-216-073-00	RES,CHIP	10K	5%	1/10W
R227	1-216-033-00	RES,CHIP	220	5%	1/10W	R362	1-216-075-00	RES,CHIP	12K	5%	1/10W
R228	1-249-389-11	CARBON	4.7	5%	1/4W	R363	1-216-079-00	RES,CHIP	18K	5%	1/10W
R229	1-216-073-00	RES,CHIP	10K	5%	1/10W	R364	1-216-295-91	SHORT	0		
R230	1-216-069-00	RES,CHIP (KV-XF21M83)	6.8K	5%	1/10W	R365	1-216-033-00	RES,CHIP	220	5%	1/10W
R230	1-216-073-00	RES,CHIP (KV-XF51M65)	10K	5%	1/10W	R366	1-216-073-00	RES,CHIP	10K	5%	1/10W
R231	1-216-295-91	SHORT	0			R367	1-216-073-00	RES,CHIP	10K	5%	1/10W
R234	1-249-389-11	CARBON	4.7	5%	1/4W	R370	1-216-033-00	RES,CHIP	220	5%	1/10W
R235	1-216-069-00	RES,CHIP	6.8K	5%	1/10W	R375	1-216-025-91	RES,CHIP	100	5%	1/10W
R236	1-216-069-00	RES,CHIP	6.8K	5%	1/10W	R376	1-216-081-00	RES,CHIP	22K	5%	1/10W
R237	1-216-308-00	RES,CHIP	4.7	5%	1/10W	R377	1-216-121-91	RES,CHIP	1M	5%	1/10W
						R378	1-216-031-00	RES,CHIP	180	5%	1/10W
						R401	1-216-049-91	RES,CHIP	1K	5%	1/10W
						R402	1-216-073-00	RES,CHIP	10K	5%	1/10W
						R403	1-216-073-00	RES,CHIP	10K	5%	1/10W



The components identified by shading and mark  $\Delta$  are critical for safety. Replace only with part number specified.

# A (KV-XF21M83/XF51M65)

REF. NO.	PART NO.	DESCRIPTION	REMARK	REF. NO.	PART NO.	DESCRIPTION	REMARK
R404	1-216-073-00	RES,CHIP	10K 5% 1/10W	R562	1-249-401-11	CARBON	47 5% 1/4W
R405	1-216-049-91	RES,CHIP	1K 5% 1/10W	R565	1-216-073-00	RES,CHIP	10K 5% 1/10W
R406	1-216-073-00	RES,CHIP	10K 5% 1/10W	R567	1-216-105-91	RES,CHIP	220K 5% 1/10W
R407	1-216-049-91	RES,CHIP	1K 5% 1/10W	R568	1-249-383-11	CARBON	1.5 5% 1/4W F
R408	1-216-049-91	RES,CHIP	1K 5% 1/10W	R570	1-216-069-00	RES,CHIP	6.8K 5% 1/10W
R409	1-216-041-00	RES,CHIP	470 5% 1/10W	R571	1-215-437-00	METAL	4.7K 1% 1/4W
R410	1-216-113-00	RES,CHIP	470K 5% 1/10W	R573	1-216-089-91	RES,CHIP	47K 5% 1/10W
R411	1-216-113-00	RES,CHIP	470K 5% 1/10W	R577	1-215-913-11	METAL OXIDE	220 5% 3W F
R412	1-216-041-00	RES,CHIP	470 5% 1/10W	R578	1-216-369-00	METAL OXIDE	1 5% 2W F
R413	1-216-021-00	RES,CHIP	68 5% 1/10W	R579	1-216-097-91	RES,CHIP	100K 5% 1/10W
R414	1-216-113-00	RES,CHIP	470K 5% 1/10W	R580	1-216-699-11	METAL CHIP	100K 0.50% 1/10W
R415	1-216-113-00	RES,CHIP	470K 5% 1/10W	R581	1-208-798-11	RES,CHIP	4.7K 0.50% 1/10W
R416	1-216-077-00	RES,CHIP	15K 5% 1/10W	R585	1-249-391-11	CARBON	6.8 5% 1/4W F
R417	1-216-077-00	RES,CHIP	15K 5% 1/10W	R588	1-215-888-00	METAL OXIDE	220 5% 2W F
R418	1-216-113-00	RES,CHIP	470K 5% 1/10W	R589	1-215-888-00	METAL OXIDE	220 5% 2W F
R419	1-216-022-00	RES,CHIP	75 5% 1/10W	R590	1-215-465-00	METAL	68K 1% 1/4W
R426	1-216-033-00	RES,CHIP	220 5% 1/10W	R591	1-260-288-11	CARBON	0.47 5% 1/2W F
R505	1-216-099-00	RES,CHIP	120K 5% 1/10W	R593	1-260-288-11	CARBON	0.47 5% 1/2W F
R506	1-216-085-00	RES,CHIP	33K 5% 1/10W	R594	1-260-288-11	CARBON	0.47 5% 1/2W F
R507	1-249-389-11	CARBON	4.7 5% 1/4W F	R596	1-215-922-11	METAL OXIDE	6.8K 5% 3W F
R508	1-215-910-00	METAL OXIDE	68 5% 3W F	R597	1-247-750-11	CARBON	680 5% 1/2W F
R509	1-215-911-11	METAL OXIDE	100 5% 3W F	R598	1-249-438-11	CARBON	56K 5% 1/4W
R510	1-215-885-00	METAL OXIDE	68 5% 2W F	R599	1-249-389-11	CARBON	4.7 5% 1/4W
R511	1-215-911-11	METAL OXIDE	100 5% 3W F	R600	1-249-438-11	CARBON	56K 5% 1/4W
R516	1-216-081-00	RES,CHIP	22K 5% 1/10W	R601	1-249-418-11	CARBON	1.2K 5% 1/4W F
R518	1-247-807-31	CARBON	100 5% 1/4W	R602	1-249-389-11	CARBON	4.7 5% 1/4W F
R520	1-215-445-00	METAL	10K 1% 1/4W	R603	1-215-485-00	METAL	470K 1% 1/4W
R522	1-216-675-11	METAL CHIP	10K 0.50% 1/10W	R604	1-216-097-91	RES,CHIP	100K 5% 1/10W
R523	1-249-411-11	CARBON	330 5% 1/4W	R606	1-216-308-00	RES,CHIP	4.7 5% 1/10W
R525	1-216-699-11	METAL CHIP	100K 0.50% 1/10W	R607	1-249-425-11	CARBON	4.7K 5% 1/4W
R526	1-208-798-11	RES,CHIP	4.7K 0.50% 1/10W	R608	1-240-205-91	CARBON	22M 5% 1/2W
R527	1-216-001-00	RES,CHIP	10 5% 1/10W	R609	1-216-057-00	RES,CHIP	2.2K 5% 1/10W
R528	1-216-683-11	METAL CHIP	22K 0.50% 1/10W	R610	1-216-073-00	RES,CHIP	10K 5% 1/10W
R529	1-216-635-11	METAL CHIP	220 0.50% 1/10W	R611	1-216-089-91	RES,CHIP	47K 5% 1/10W
R531	1-247-843-11	CARBON	3.3K 5% 1/4W	R612	1-216-045-00	RES,CHIP	680 5% 1/10W
R533	1-249-417-11	CARBON	1K 5% 1/4W	R614	1-216-041-00	RES,CHIP	470 5% 1/10W
R534	1-216-361-21	METAL OXIDE	0.22 5% 2W F	R615	1-216-350-11	METAL OXIDE	1.2 5% 1W F
R535	1-216-067-00	RES,CHIP	5.6K 5% 1/10W	R616	1-260-302-51	CARBON	6.8 5% 1/2W F
R536	1-216-067-00	RES,CHIP	5.6K 5% 1/10W	R617	1-247-791-91	CARBON	22 5% 1/4W
R537	1-216-683-11	METAL CHIP	22K 0.50% 1/10W	R619	1-260-128-11	CARBON	270K 5% 1/2W
R540	1-216-065-91	RES,CHIP	4.7K 5% 1/10W	R620	1-215-915-11	METAL OXIDE	470 5% 3W F
R541	1-216-065-91	RES,CHIP	4.7K 5% 1/10W	R622	1-216-400-11	METAL OXIDE	8.2 5% 3W F
R542	1-216-295-91	SHORT	0	R623	1-216-095-00	RES,CHIP	82K 5% 1/10W
R543	1-249-426-11	CARBON	5.6K 5% 1/4W F	R624	1-216-089-91	RES,CHIP	47K 5% 1/10W
R545	1-216-077-00	RES,CHIP	15K 5% 1/10W	R626	1-216-049-91	RES,CHIP	1K 5% 1/10W
R546	1-216-077-00	RES,CHIP	15K 5% 1/10W	R627	1-240-251-11	CMT,MELF	6.8 5% 10W
R547	1-216-085-00	RES,CHIP	33K 5% 1/10W	R629	1-247-747-11	CARBON	470 5% 1/2W F
R549	1-215-451-00	METAL	18K 1% 1/4W	R630	1-249-429-11	CARBON	10K 5% 1/4W F
R550	1-216-097-91	RES,CHIP	100K 5% 1/10W	R631	1-216-089-91	RES,CHIP	47K 5% 1/10W
R551	1-249-421-11	CARBON	2.2K 5% 1/4W	R632	1-202-933-61	FUSIBLE	0.1 10% 1/2W F
R552	1-216-057-00	RES,CHIP	2.2K 5% 1/10W	R634	$\Delta$ 1-218-265-91	METAL	8.2M 5% 1W
R553	1-215-457-00	METAL	33K 1% 1/4W	R635	1-216-492-21	METAL OXIDE	82K 5% 3W F
R554	1-215-457-00	METAL	33K 1% 1/4W	R636	1-215-924-00	METAL OXIDE	15K 5% 3W F
R556	1-215-437-00	METAL	4.7K 1% 1/4W	R637	1-216-492-21	METAL OXIDE	82K 5% 3W F
R558	1-249-421-11	CARBON	2.2K 5% 1/4W	R639	1-216-363-00	METAL OXIDE	0.33 5% 2W F
R559	1-249-429-11	CARBON	10K 5% 1/4W	R640	1-249-415-11	CARBON	680 5% 1/4W
R560	1-216-073-00	RES,CHIP	10K 5% 1/10W	R641	1-216-362-11	METAL OXIDE	0.27 5% 2W F
				R642	1-249-419-11	CARBON	1.5K 5% 1/4W

The components identified by shading and mark **△** are critical for safety. Replace only with part number specified.

**A (KV-XF21M83/XF51M65)**

**A (KV-XF21N90)**

REF. NO.	PART NO.	DESCRIPTION	REMARK
R643	1-247-843-11	CARBON 3.3K 5%	1/4W
R644	1-249-419-11	CARBON 1.5K 5%	1/4W
R646	1-215-924-00	METAL OXIDE 15K 5%	3W F
R647	1-249-401-11	CARBON 47 5%	1/4W
R648	1-216-057-00	RES,CHIP 2.2K 5%	1/10W
R649	1-249-417-11	CARBON 1K 5%	1/4W
R650	1-215-882-00	METAL OXIDE 22 5%	2W F
R652	1-215-900-11	METAL OXIDE 22K 5%	2W F
R653	1-215-873-00	METAL OXIDE 4.7K 5%	1W F
R657	1-260-127-11	CARBON 220K 5%	1/2W
R659	1-216-049-91	RES,CHIP 1K 5%	1/10W
R660	1-216-073-00	RES,CHIP 10K 5%	1/10W
R661	1-215-873-00	METAL OXIDE 4.7K 5%	1W F
R680	1-216-308-00	RES,CHIP 4.7 5%	1/10W
R901	1-249-411-11	CARBON 330 5%	1/4W
R902	1-249-411-11	CARBON 330 5%	1/4W
R903	1-216-022-00	RES,CHIP 75 5%	1/10W
R904	1-216-033-00	RES,CHIP 220 5%	1/10W
R905	1-216-113-00	RES,CHIP 470K 5%	1/10W
R906	1-216-077-00	RES,CHIP 15K 5%	1/10W
R907	1-216-113-00	RES,CHIP 470K 5%	1/10W
R908	1-216-077-00	RES,CHIP 15K 5%	1/10W
R909	1-216-065-91	RES,CHIP 4.7K 5%	1/10W
R910	1-216-065-91	RES,CHIP 4.7K 5%	1/10W
R911	1-216-067-00	RES,CHIP 5.6K 5%	1/10W
R912	1-216-041-00	RES,CHIP 470 5%	1/10W
R913	1-216-049-91	RES,CHIP 1K 5%	1/10W
R914	1-216-055-00	RES,CHIP 1.8K 5%	1/10W
R915	1-216-061-00	RES,CHIP 3.3K 5%	1/10W
R916	1-216-017-91	RES,CHIP 47 5%	1/10W
R917	1-216-041-00	RES,CHIP 470 5%	1/10W
R918	1-216-041-00	RES,CHIP 470 5%	1/10W
		<RELAY>	
RY601 <b>△</b>	1-755-266-11	RELAY, AC POWER	
		<SWITCH>	
S502	1-572-707-11	SWITCH, LEVER	
S600 <b>△</b>	1-571-433-31	SWITCH, PUSH (AC POWER)	
S901	1-692-431-21	SWITCH, TACTILE	
S902	1-692-431-21	SWITCH, TACTILE	
S903	1-692-431-21	SWITCH, TACTILE	
S904	1-692-431-21	SWITCH, TACTILE	
S905	1-692-431-21	SWITCH, TACTILE	
S906	1-692-431-21	SWITCH, TACTILE	
S907	1-692-431-21	SWITCH, TACTILE	
		<TRANSFORMER>	
T501	1-437-195-11	TRANSFORMER, HORIZONTAL DRIVE	
T503 <b>△</b>	1-453-293-11	TRANSFORMER ASSY, FLYBACK (NX-1748//M3A4)	
T601	1-424-682-11	TRANSFORMER, LINE FILTER	
T603 <b>△</b>	1-433-512-31	TRANSFORMER, CONVERTER (SRT)	
T604 <b>△</b>	1-431-852-11	TRANSFORMER, CONVERTER (SRT)	

REF. NO.	PART NO.	DESCRIPTION	REMARK
		<THERMISTOR>	
THP600	1-810-961-11	THERMISTOR, POSITIVE	
		<TUNER>	
TU101	8-598-449-01	TUNER, FSS BTF-LG433 (KV-XF21M83)	
TU101	8-598-451-00	TUNER, FSS BTF-WG441 (KV-XF51M65)	
		<CRYSTAL>	
X001	1-579-125-11	VIBRATOR, CERAMIC	
X301	1-781-134-21	VIBRATOR, CRYSTAL	
X302	1-781-132-21	VIBRATOR, CRYSTAL	
		*****	
	* A-1298-954-A	A BOARD, COMPLETED (KV-XF21N90)	*****
	* 4-055-304-01	HOLDER, LED	
	* 4-067-182-02	HOLDER, FBT	
	4-382-854-11	SCREW (M3X10), P, SW (+)	
	4-382-854-21	SCREW (M3X14), P, SW (+)	
	7-685-648-79	SCREW +BVTP 3X12 TYPE2 IT-3	
		<CAPACITOR>	
C004	1-163-001-11	CERAMIC CHIP 220PF	10% 50V
C005	1-163-001-11	CERAMIC CHIP 220PF	10% 50V
C006	1-164-004-11	CERAMIC CHIP 0.1MF	10% 25V
C007	1-126-933-11	ELECT 100MF	20% 16V
C008	1-163-251-11	CERAMIC CHIP 100PF	5% 50V
C010	1-163-251-11	CERAMIC CHIP 100PF	5% 50V
C012	1-163-251-11	CERAMIC CHIP 100PF	5% 50V
C013	1-163-021-91	CERAMIC CHIP 0.01MF	10% 50V
C014	1-126-967-11	ELECT 47MF	20% 50V
C015	1-163-009-11	CERAMIC CHIP 0.001MF	10% 50V
C016	1-163-113-00	CERAMIC CHIP 68PF	5% 50V
C017	1-163-113-00	CERAMIC CHIP 68PF	5% 50V
C019	1-104-665-11	ELECT 100MF	20% 25V
C022	1-163-227-11	CERAMIC CHIP 10PF	0.5PF 50V
C023	1-163-227-11	CERAMIC CHIP 10PF	0.5PF 50V
C024	1-163-227-11	CERAMIC CHIP 10PF	0.5PF 50V
C026	1-164-004-11	CERAMIC CHIP 0.1MF	10% 25V
C027	1-164-004-11	CERAMIC CHIP 0.1MF	10% 25V
C028	1-163-037-11	CERAMIC CHIP 0.022MF	10% 50V
C030	1-126-965-11	ELECT 22MF	20% 50V
C031	1-164-004-11	CERAMIC CHIP 0.1MF	10% 25V
C032	1-107-823-11	CERAMIC CHIP 0.47MF	10% 16V
C034	1-163-031-11	CERAMIC CHIP 0.01MF	50V
C041	1-163-251-11	CERAMIC CHIP 100PF	5% 50V
C042	1-163-251-11	CERAMIC CHIP 100PF	5% 50V
C043	1-163-251-11	CERAMIC CHIP 100PF	5% 50V
C044	1-163-251-11	CERAMIC CHIP 100PF	5% 50V

**A (KV-XF21N90)**

REF. NO.	PART NO.	DESCRIPTION	REMARK	REF. NO.	PART NO.	DESCRIPTION	REMARK
C047	1-163-251-11	CERAMIC CHIP	100PF 5% 50V	C244	1-164-700-11	CERAMIC CHIP	0.68MF 16V
C048	1-163-251-11	CERAMIC CHIP	100PF 5% 50V	C245	1-164-346-11	CERAMIC CHIP	1MF 16V
C050	1-163-251-11	CERAMIC CHIP	100PF 5% 50V	C246	1-163-018-00	CERAMIC CHIP	0.0056MF 10% 50V
C051	1-163-251-11	CERAMIC CHIP	100PF 5% 50V	C247	1-164-346-11	CERAMIC CHIP	1MF 16V
C053	1-163-251-11	CERAMIC CHIP	100PF 5% 50V	C248	1-163-010-11	CERAMIC CHIP	0.0012MF 10% 50V
C055	1-163-251-11	CERAMIC CHIP	100PF 5% 50V	C249	1-164-004-11	CERAMIC CHIP	0.1MF 10% 25V
C101	1-126-964-11	ELECT	10MF 20% 50V	C250	1-216-295-91	SHORT	0
C103	1-164-004-11	CERAMIC CHIP	0.1MF 10% 25V	C251	1-163-017-00	CERAMIC CHIP	0.0047MF 10% 50V
C104	1-126-933-11	ELECT	100MF 20% 16V	C252	1-164-346-11	CERAMIC CHIP	1MF 16V
C107	1-163-005-11	CERAMIC CHIP	470PF 10% 50V	C253	1-163-037-11	CERAMIC CHIP	0.022MF 10% 50V
C108	1-126-933-11	ELECT	100MF 20% 16V	C254	1-126-965-11	ELECT	22MF 20% 50V
C109	1-163-005-11	CERAMIC CHIP	470PF 10% 50V	C255	1-163-037-11	CERAMIC CHIP	0.022MF 10% 50V
C110	1-163-005-11	CERAMIC CHIP	470PF 10% 50V	C256	1-164-004-11	CERAMIC CHIP	0.1MF 10% 25V
C111	1-163-005-11	CERAMIC CHIP	470PF 10% 50V	C259	1-126-933-11	ELECT	100MF 20% 16V
C112	1-126-933-11	ELECT	100MF 20% 16V	C264	1-164-505-11	CERAMIC CHIP	2.2MF 16V
C113	1-126-967-11	ELECT	47MF 20% 50V	C265	1-164-505-11	CERAMIC CHIP	2.2MF 16V
C114	1-126-967-11	ELECT	47MF 20% 50V	C301	1-126-935-11	ELECT	470MF 20% 16V
C202	1-163-021-91	CERAMIC CHIP	0.01MF 10% 50V	C302	1-163-005-11	CERAMIC CHIP	470PF 10% 50V
C203	1-163-021-91	CERAMIC CHIP	0.01MF 10% 50V	C303	1-126-964-11	ELECT	10MF 20% 50V
C204	1-136-164-00	FILM	0.082MF 5% 50V	C304	1-126-967-11	ELECT	47MF 20% 50V
C205	1-163-017-00	CERAMIC CHIP	0.0047MF 10% 50V	C305	1-164-004-11	CERAMIC CHIP	0.1MF 10% 25V
C206	1-163-017-00	CERAMIC CHIP	0.0047MF 10% 50V	C306	1-163-233-11	CERAMIC CHIP	18PF 5% 50V
C207	1-136-164-00	FILM	0.082MF 5% 50V	C307	1-163-233-11	CERAMIC CHIP	18PF 5% 50V
C208	1-126-964-11	ELECT	10MF 20% 50V	C308	1-163-259-91	CERAMIC CHIP	220PF 5% 50V
C209	1-126-964-11	ELECT	10MF 20% 50V	C309	1-126-957-11	ELECT	0.22MF 20% 50V
C210	1-126-933-11	ELECT	100MF 20% 16V	C310	1-126-963-11	ELECT	4.7MF 20% 50V
C211	1-126-941-11	ELECT	470MF 20% 25V	C311	1-126-964-11	ELECT	10MF 20% 50V
C212	1-126-933-11	ELECT	100MF 20% 16V	C312	1-164-346-11	CERAMIC CHIP	1MF 16V
C213	1-126-933-11	ELECT	100MF 20% 16V	C313	1-164-346-11	CERAMIC CHIP	1MF 16V
C214	1-126-942-61	ELECT	1000MF 20% 25V	C315	1-164-004-11	CERAMIC CHIP	0.1MF 10% 25V
C215	1-126-942-61	ELECT	1000MF 20% 25V	C316	1-126-967-11	ELECT	47MF 20% 50V
C216	1-163-021-91	CERAMIC CHIP	0.01MF 10% 50V	C317	1-164-004-11	CERAMIC CHIP	0.1MF 10% 25V
C217	1-126-964-11	ELECT	10MF 20% 50V	C318	1-163-031-11	CERAMIC CHIP	0.01MF 50V
C218	1-136-167-00	FILM	0.15MF 5% 50V	C319	1-163-031-11	CERAMIC CHIP	0.01MF 50V
C219	1-136-167-00	FILM	0.15MF 5% 50V	C320	1-163-031-11	CERAMIC CHIP	0.01MF 50V
C220	1-126-942-61	ELECT	1000MF 20% 25V	C322	1-163-005-11	CERAMIC CHIP	470PF 10% 50V
C221	1-126-964-11	ELECT	10MF 20% 50V	C323	1-126-965-11	ELECT	22MF 20% 50V
C223	1-126-965-11	ELECT	22MF 20% 50V	C324	1-163-017-00	CERAMIC CHIP	0.0047MF 10% 50V
C224	1-163-133-00	CERAMIC CHIP	470PF 5% 50V	C325	1-126-960-11	ELECT	1MF 20% 50V
C225	1-109-982-11	CERAMIC CHIP	1MF 10% 10V	C327	1-126-965-11	ELECT	22MF 20% 50V
C226	1-109-982-11	CERAMIC CHIP	1MF 10% 10V	C328	1-164-004-11	CERAMIC CHIP	0.1MF 10% 25V
C227	1-163-037-11	CERAMIC CHIP	0.022MF 10% 50V	C329	1-126-965-11	ELECT	22MF 20% 50V
C228	1-163-024-00	CERAMIC CHIP	0.018MF 10% 50V	C330	1-164-004-11	CERAMIC CHIP	0.1MF 10% 25V
C229	1-163-018-00	CERAMIC CHIP	0.0056MF 10% 50V	C331	1-247-807-31	CARBON	100 5% 1/4W
C230	1-163-024-00	CERAMIC CHIP	0.018MF 10% 50V	C332	1-126-963-11	ELECT	4.7MF 20% 50V
C231	1-163-018-00	CERAMIC CHIP	0.0056MF 10% 50V	C335	1-164-004-11	CERAMIC CHIP	0.1MF 10% 25V
C232	1-163-037-11	CERAMIC CHIP	0.022MF 10% 50V	C336	1-164-004-11	CERAMIC CHIP	0.1MF 10% 25V
C233	1-164-004-11	CERAMIC CHIP	0.1MF 10% 25V	C337	1-126-961-11	ELECT	2.2MF 20% 50V
C234	1-164-004-11	CERAMIC CHIP	0.1MF 10% 25V	C338	1-163-017-00	CERAMIC CHIP	0.0047MF 10% 50V
C235	1-164-004-11	CERAMIC CHIP	0.1MF 10% 25V	C341	1-115-340-11	CERAMIC CHIP	0.22MF 10% 25V
C236	1-164-004-11	CERAMIC CHIP	0.1MF 10% 25V	C342	1-163-259-91	CERAMIC CHIP	220PF 5% 50V
C238	1-164-505-11	CERAMIC CHIP	2.2MF 16V	C401	1-164-346-11	CERAMIC CHIP	1MF 16V
C240	1-164-505-11	CERAMIC CHIP	2.2MF 16V	C402	1-164-346-11	CERAMIC CHIP	1MF 16V
C241	1-164-346-11	CERAMIC CHIP	1MF 16V	C403	1-163-005-11	CERAMIC CHIP	470PF 10% 50V
C242	1-164-505-11	CERAMIC CHIP	2.2MF 16V	C404	1-163-005-11	CERAMIC CHIP	470PF 10% 50V
C243	1-216-295-91	SHORT	0	C405	1-126-935-11	ELECT	470MF 20% 16V
				C406	1-164-346-11	CERAMIC CHIP	1MF 16V

The components identified by shading  
and mark  $\Delta$  are critical for safety.  
Replace only with part number specified.

**A (KV-XF21N90)**

REF. NO.	PART NO.	DESCRIPTION	REMARK	REF. NO.	PART NO.	DESCRIPTION	REMARK
C407	1-164-346-11	CERAMIC CHIP	1MF	16V	C605	$\Delta$ 1-127-942-51	CERAMIC 330PF 10% 250V
C408	1-163-133-00	CERAMIC CHIP	470PF	5% 50V	C606	$\Delta$ 1-127-942-51	CERAMIC 330PF 10% 250V
C409	1-126-963-11	ELECT	4.7MF	20% 50V	C607	1-161-830-00	CERAMIC 0.0047MF 99% 500V
C415	1-163-133-00	CERAMIC CHIP	470PF	5% 50V	C608	1-161-830-00	CERAMIC 0.0047MF 99% 500V
C502	1-163-145-00	CERAMIC CHIP	0.0015MF	5% 50V	C609	1-126-968-11	ELECT 100MF 20% 50V
C506	1-107-638-11	ELECT	33MF	20% 160V	C610	1-126-964-11	ELECT 10MF 20% 50V
C507	1-161-830-00	CERAMIC	0.0047MF	500V	C611	1-161-830-00	CERAMIC 0.0047MF 99% 500V
C510	1-102-112-00	CERAMIC	330PF	10% 50V	C612	1-161-830-00	CERAMIC 0.0047MF 99% 500V
C512	1-163-989-11	CERAMIC CHIP	0.033MF	10% 25V	C613	1-117-942-11	ELECT(BLOCK) 560MF 20% 250V
C513	1-163-263-11	CERAMIC CHIP	330PF	5% 50V	C614	1-126-964-11	ELECT 10MF 20% 50V
C514	1-106-383-00	MYLAR	0.047MF	10% 200V	C616	1-130-202-00	FILM 0.022MF 10% 400V
C517	1-164-182-11	CERAMIC CHIP	0.0033MF	10% 50V	C617	1-107-792-11	CERAMIC 100PF 5% 1KV
C518	1-104-665-11	ELECT	100MF	20% 10V	C618	1-125-893-11	FILM 680PF 3% 1.5KV
C519	1-102-212-00	CERAMIC	820PF	10% 500V	C619	1-119-886-51	CERAMIC 470PF 10% 250V
C521	1-126-934-11	ELECT	220MF	20% 16V	C620	1-163-133-00	CERAMIC CHIP 470PF 5% 50V
C522	1-126-933-11	ELECT	100MF	20% 16V	C621	1-102-114-00	CERAMIC 470PF 10% 50V
C523	1-102-002-00	CERAMIC	680PF	10% 500V	C622	1-102-074-00	CERAMIC 0.001MF 10% 50V
C524	1-126-967-11	ELECT	47MF	20% 50V	C623	1-104-665-11	ELECT 100MF 20% 25V
C526	1-130-495-00	MYLAR	0.1MF	5% 50V	C624	1-104-331-11	CERAMIC 0.0022MF 10% 1KV
C527	1-102-820-00	CERAMIC	330PF	5% 50V	C627	1-102-002-00	CERAMIC 680PF 10% 500V
C528	1-162-134-11	CERAMIC	470PF	10% 2KV	C628	1-126-942-61	ELECT 1000MF 20% 25V
C530	1-137-372-11	FILM	0.022MF	5% 50V	C629	1-126-964-11	ELECT 10MF 20% 50V
C531	1-126-961-11	ELECT	2.2MF	20% 50V	C630	1-123-024-21	ELECT 33MF 160V
C532	1-126-941-11	ELECT	470MF	20% 25V	C633	1-104-999-11	MYLAR 0.1MF 10% 200V
C533	1-126-941-11	ELECT	470MF	20% 25V	C634	1-126-933-11	ELECT 100MF 20% 16V
C536	1-136-165-00	FILM	0.1MF	5% 50V	C635	1-104-665-11	ELECT 100MF 20% 10V
C537	1-126-969-11	ELECT	220MF	20% 50V	C636	1-104-760-11	CERAMIC CHIP 0.047MF 10% 50V
C538	1-136-076-00	FILM	0.0085MF	3% 2KV	C639	1-164-004-11	CERAMIC CHIP 0.1MF 10% 25V
C539	1-129-746-91	FILM	0.039MF	5% 400V	C640	1-164-004-11	CERAMIC CHIP 0.1MF 10% 25V
C540	1-136-171-00	FILM	0.33MF	5% 50V	C641	1-102-002-00	CERAMIC 680PF 10% 500V
C546	1-165-319-11	CERAMIC CHIP	0.1MF	50V	C642	1-126-943-11	ELECT 2200MF 20% 25V
C549	1-163-017-00	CERAMIC CHIP	0.0047MF	10% 50V	C643	1-104-665-11	ELECT 100MF 20% 10V
C550	1-106-220-00	MYLAR	0.1MF	10% 100V	C644	1-104-331-11	CERAMIC 0.0022MF 10% 1KV
C551	1-126-960-11	ELECT	1MF	20% 50V	C645	1-137-605-11	FILM 0.01MF 10% 250V
C552	1-162-116-00	CERAMIC	680PF	10% 2KV	C646	1-107-679-91	ELECT 10MF 20% 450V
C553	1-162-116-00	CERAMIC	680PF	10% 2KV	C647	1-163-275-11	CERAMIC CHIP 0.001MF 5% 50V
C554	1-137-417-11	MYLAR	0.0047MF	10% 200V	C649	1-126-940-11	ELECT 330MF 20% 25V
C556	1-126-941-11	ELECT	470MF	20% 25V	C650	1-163-275-11	CERAMIC CHIP 0.001MF 5% 50V
C557	1-126-941-11	ELECT	470MF	20% 25V	C651	1-163-133-00	CERAMIC CHIP 470PF 5% 50V
C558	1-123-024-21	ELECT	33MF	160V	C652	1-126-965-11	ELECT 22MF 20% 50V
C560	1-102-228-00	CERAMIC	470PF	10% 500V	C653	1-104-664-11	ELECT 47MF 20% 25V
C561	1-136-557-11	FILM	0.0033MF	5% 630V	C657	1-101-821-00	CERAMIC 0.0022MF 500V
C562	1-102-228-00	CERAMIC	470PF	10% 500V	C658	1-164-004-11	CERAMIC CHIP 0.1MF 10% 25V
C564	1-163-038-91	CERAMIC CHIP	0.1MF	25V	C901	1-136-153-00	FILM 0.01MF 5% 50V
C565	1-107-655-11	ELECT	47MF	20% 250V	C902	1-136-153-00	FILM 0.01MF 5% 50V
C566	1-102-244-00	CERAMIC	220PF	10% 500V	C905	1-126-963-11	ELECT 4.7MF 20% 50V
C567	1-115-521-11	FILM	0.82MF	5% 250V	C906	1-164-346-11	CERAMIC CHIP 1MF 16V
C568	1-102-228-00	CERAMIC	470PF	10% 500V	C907	1-163-133-00	CERAMIC CHIP 470PF 5% 50V
C570	1-115-520-11	FILM	0.68MF	5% 250V	C908	1-163-133-00	CERAMIC CHIP 470PF 5% 50V
C573	1-106-379-12	MYLAR	0.033MF	10% 200V	C909	1-164-346-11	CERAMIC CHIP 1MF 16V
C574	1-107-636-11	ELECT	10MF	20% 160V	C910	1-126-967-11	ELECT 47MF 20% 50V
C576	1-130-495-00	MYLAR	0.1MF	5% 50V	C911	1-126-967-11	ELECT 47MF 20% 50V
C577	1-106-395-00	MYLAR	0.15MF	10% 200V	C912	1-164-004-11	CERAMIC CHIP 0.1MF 10% 25V
C582	1-164-004-11	CERAMIC CHIP	0.1MF	10% 25V	C913	1-126-933-11	ELECT 100MF 20% 16V
C600	$\Delta$ 1-104-705-51	FILM	0.1MF	20% 250V	C914	1-163-133-00	CERAMIC CHIP 470PF 5% 50V
C603	1-104-664-11	ELECT	47MF	20% 25V			
C604	1-163-009-11	CERAMIC CHIP	0.001MF	10% 50V			

**A (KV-XF21N90)**

REF. NO.	PART NO.	DESCRIPTION	REMARK	REF. NO.	PART NO.	DESCRIPTION	REMARK
		<CONNECTOR>					
CN104	1-695-915-11	TAB (CONTACT)		D521	8-719-302-43	DIODE EL1Z	
CN202	* 1-785-608-11	PIN, CONNECTOR 4P		D522	8-719-302-43	DIODE EL1Z	
CN203	* 1-564-506-11	PLUG, CONNECTOR 3P		D523	8-719-302-43	DIODE EL1Z	
CN204	* 1-564-506-11	PLUG, CONNECTOR 3P		D527	8-719-908-03	DIODE GP08D	
CN305	* 1-564-509-11	PLUG, CONNECTOR 6P		D528	8-719-908-03	DIODE GP08D	
CN306	* 1-564-510-11	PLUG, CONNECTOR 7P		D531	8-719-988-61	DIODE 1SS355TE-17	
CN505	1-508-765-00	PIN, CONNECTOR (5MM PITCH) 3P		D532	8-719-988-61	DIODE 1SS355TE-17	
CN506	4-352-844-01	PIN, LEAD, COATING		D600	8-719-911-19	DIODE 1SS119-25	
CN507	* 1-564-507-11	PLUG, CONNECTOR 4P		D602	8-719-911-19	DIODE 1SS119-25	
CN601	* 1-580-843-11	PIN, CONNECTOR (POWER)		D603	8-719-150-92	DIODE RD33EB3T	
CN602	* 1-508-786-00	PIN, CONNECTOR (5MM PITCH) 2P		D604	8-719-028-72	DIODE RGP02-17EL-6433	
CN604	* 1-573-963-11	PIN, CONNECTOR (PC BOARD) 3P		D605	8-719-510-53	DIODE D4SB60L	
CN609	* 1-508-784-21	PIN, CONNECTOR (5MM PITCH) 1P		D606	8-719-108-18	THYRISTOR 5P6M	
CN901	* 1-564-507-11	PLUG, CONNECTOR 4P		D607	8-719-404-50	DIODE MA111-TX	
		<COMPOSITION CIRCUIT BLOCK>		D608	8-719-110-53	DIODE RD20ESB2	
CP301	1-467-554-21	FILTER BLOCK, COMB		D609	8-719-311-31	DIODE RU-1P	
		<DIODE>		D610	8-719-043-76	DIODE AK04V0	
D001	8-719-988-61	DIODE 1SS355TE-17		D611	8-719-046-74	DIODE AU-01Z-V1	
D005	8-719-988-61	DIODE 1SS355TE-17		D613	8-719-046-74	DIODE AU-01Z-V1	
D006	8-719-988-61	DIODE 1SS355TE-17		D614	8-719-046-74	DIODE AU-01Z-V1	
D203	8-719-914-42	DIODE DA204K		D618	8-719-067-18	DIODE RN4Z	
D300	1-216-295-91	SHORT 0		D620	8-719-110-72	DIODE RD30ESB2	
D301	8-719-988-61	DIODE 1SS355TE-17		D622	8-719-071-39	DIODE FMU-G26S	
D306	8-719-988-61	DIODE 1SS355TE-17		D623	8-719-978-65	DIODE DTZ-TT11-15B	
D307	8-719-988-61	DIODE 1SS355TE-17		D624	8-719-404-50	DIODE MA111-TX	
D308	8-719-988-61	DIODE 1SS355TE-17		D625	8-719-977-28	DIODE DTZ10B	
D309	8-719-069-54	DIODE UDZS-TE17-5		D627	8-719-073-84	DIODE 31DQ06-FC5	
D311	8-719-988-61	DIODE 1SS355TE-17		D628	8-719-911-19	DIODE 1SS119-25	
D312	8-719-988-61	DIODE 1SS355TE-17		D631	8-719-068-00	DIODE ERC04-06SE	
D313	8-719-988-61	DIODE 1SS355TE-17		D632	8-719-068-00	DIODE ERC04-06SE	
D314	8-719-988-61	DIODE 1SS355TE-17		D633	8-719-948-45	DIODE ERA22-08	
D315	8-719-988-61	DIODE 1SS355TE-17		D634	8-719-404-50	DIODE MA111-TX	
D316	8-719-069-57	DIODE UDZS-TE17-6.8B		D635	8-719-404-50	DIODE MA111-TX	
D319	8-719-069-60	DIODE UDZS-TE17-9.1B		D636	8-719-510-02	DIODE D1NS4	
D401	8-719-069-60	DIODE UDZS-TE17-9.1B		D637	8-719-109-96	DIODE RD6.8ESB1	
D402	8-719-069-60	DIODE UDZS-TE17-9.1B		D638	8-719-510-48	DIODE D1N20R	
D403	8-719-069-60	DIODE UDZS-TE17-9.1B		D901	8-719-069-60	DIODE UDZS-TE17-9.1B	
D404	8-719-069-60	DIODE UDZS-TE17-9.1B		D902	8-719-069-60	DIODE UDZS-TE17-9.1B	
D405	8-719-069-60	DIODE UDZS-TE17-9.1B		D903	8-719-069-60	DIODE UDZS-TE17-9.1B	
D406	8-719-069-60	DIODE UDZS-TE17-9.1B		D904	8-719-069-60	DIODE UDZS-TE17-9.1B	
D504	8-719-302-43	DIODE EL1Z		D905	8-719-069-60	DIODE UDZS-TE17-9.1B	
D505	8-719-988-61	DIODE 1SS355TE-17		D906	8-719-045-19	DIODE SPB-26MVWF	
D506	8-719-911-19	DIODE 1SS119-25				<CONNECTOR>	
D507	8-719-988-61	DIODE 1SS355TE-17		DY1	* 1-580-798-11	CONNECTOR PIN (DY) 6P	
D508	8-719-988-61	DIODE 1SS355TE-17				<FERRITE BEAD>	
D509	1-216-073-00	RES.CHIP 10K	5%	FB103	1-410-397-21	FERRITE	1.1UH
D510	8-719-988-61	DIODE 1SS355TE-17		FB501	1-410-397-21	FERRITE	1.1UH
D511	8-719-988-61	DIODE 1SS355TE-17		FB502	1-410-397-21	FERRITE	1.1UH
D512	8-719-988-61	DIODE 1SS355TE-17		FB600	1-410-397-21	FERRITE	1.1UH
D513	8-719-908-03	DIODE GP08D		FB601	1-410-397-21	FERRITE	1.1UH
D517	8-719-945-80	DIODE ERC06-15S		FB602	1-410-397-21	FERRITE	1.1UH
D518	8-719-900-26	DIODE ERD29-08J		FB603	1-410-397-21	FERRITE	1.1UH
				FB604	1-410-397-21	FERRITE	1.1UH

The components identified by shading and mark  $\triangle$  are critical for safety. Replace only with part number specified.

**A (KV-XF21N90)**

REF. NO.	PART NO.	DESCRIPTION	REMARK	REF. NO.	PART NO.	DESCRIPTION	REMARK
FB607	1-410-397-21	FERRITE	1.1UH	JR500	1-216-295-91	SHORT	0
FB608	1-412-911-31	FERRITE	0UH	JR501	1-216-295-91	SHORT	0
FB611	1-410-397-21	FERRITE	1.1UH	JR600	1-216-295-91	SHORT	0
FB612	1-410-397-21	FERRITE	1.1UH			<COIL>	
FB613	1-410-397-21	FERRITE	1.1UH	L002	1-414-856-11	INDUCTOR	10UH
FB615	1-410-397-21	FERRITE	1.1UH	L003	1-414-180-11	INDUCTOR	3.3UH
		<IC>		L005	1-414-233-22	INDUCTOR CHIP	0UH
IC001	8-752-905-24	IC CXP86449-618S		L101	1-414-856-11	INDUCTOR	10UH
IC002	8-759-371-21	IC MM1319AFBE		L102	1-414-856-11	INDUCTOR	10UH
IC003	8-759-370-34	IC ST24C08FB6		L103	1-414-856-11	INDUCTOR	10UH
IC201	8-759-336-30	IC TA8223K		L104	1-414-856-11	INDUCTOR	10UH
IC203	8-759-553-40	IC TDA7429S		L105	1-414-856-11	INDUCTOR	10UH
IC301	8-752-088-39	IC CXA2130S		L204	1-414-856-11	INDUCTOR	10UH
IC502	8-759-700-07	IC NJM2903M		L301	1-414-189-31	INDUCTOR	100UH
IC503	8-759-980-58	IC TDA8172		L302	1-414-185-41	INDUCTOR	22UH
IC601	8-749-013-75	IC STR-F6654		L501	1-412-525-31	INDUCTOR	10UH
IC602	8-749-920-61	IC SE-135N		L502	1-422-613-11	COIL, AIR CORE	
IC603	8-759-701-59	IC NJM78M09FA		L503	1-412-525-31	INDUCTOR	10UH
IC604	8-759-231-53	IC TA7805S		L504	1-412-525-31	INDUCTOR	10UH
IC901	8-742-014-11	HYB IC SBX1981-51		L505	1-412-525-31	INDUCTOR	10UH
		<JACK>		L506	1-412-525-31	INDUCTOR	10UH
J401	1-779-850-11	JACK BLOCK, PIN 6P		L507	1-459-111-00	INDUCTOR	10MMH
J901	1-770-786-11	JACK		L508	1-412-525-31	INDUCTOR	10UH
J902	1-770-329-11	JACK, PIN 3P		L509	1-459-390-00	INDUCTOR	390UH
		<CHIP CONDUCTOR>		L510	1-416-972-11	COIL, HORIZONTAL LINEARITY	
JR002	1-216-295-91	SHORT	0	L512	1-412-549-31	INDUCTOR	1MMH
JR003	1-216-295-91	SHORT	0	L513	1-412-549-31	INDUCTOR	1MMH
JR004	1-216-295-91	SHORT	0	L515	1-459-104-00	COIL, WITH CORE	
JR005	1-216-295-91	SHORT	0	L518	1-408-611-31	INDUCTOR	47UH
JR006	1-216-295-91	SHORT	0	L601	1-412-527-11	INDUCTOR	15UH
JR007	1-216-295-91	SHORT	0	L901	1-408-603-31	INDUCTOR	10UH
JR008	1-216-295-91	SHORT	0	L902	1-408-603-31	INDUCTOR	10UH
JR009	1-216-295-91	SHORT	0	L905	1-414-856-11	INDUCTOR	10UH
JR010	1-216-295-91	SHORT	0			<PHOTO COUPLER>	
JR011	1-216-295-91	SHORT	0	PH600 $\triangle$	8-749-924-35	PHOTO COUPLER ON3171-R	
JR012	1-216-295-91	SHORT	0			<IC LINK>	
JR013	1-216-295-91	SHORT	0	PS200	1-532-675-21	LINK, IC 1.5A/150V	
JR014	1-216-295-91	SHORT	0			<TRANSISTOR>	
JR015	1-216-295-91	SHORT	0	Q002	8-729-230-49	TRANSISTOR 2SC2712-YG	
JR016	1-216-295-91	SHORT	0	Q003	8-729-424-08	TRANSISTOR UN2111	
JR018	1-216-295-91	SHORT	0	Q004	8-729-421-22	TRANSISTOR UN2211	
JR019	1-216-295-91	SHORT	0	Q101	8-729-230-49	TRANSISTOR 2SC2712-YG	
JR107	1-216-295-91	SHORT	0	Q201	8-729-424-67	TRANSISTOR UN2216	
JR202	1-216-295-91	SHORT	0	Q202	8-729-424-67	TRANSISTOR UN2216	
JR301	1-216-295-91	SHORT	0	Q203	8-729-421-19	TRANSISTOR UN2213	
JR303	1-216-295-91	SHORT	0	Q204	8-729-216-22	TRANSISTOR 2SA1162-G	
JR401	1-216-295-91	SHORT	0	Q205	8-729-421-19	TRANSISTOR UN2213	
JR403	1-216-295-91	SHORT	0	Q206	8-729-421-19	TRANSISTOR UN2213	
JR404	1-216-295-91	SHORT	0	Q207	8-729-421-19	TRANSISTOR UN2213	
JR405	1-216-295-91	SHORT	0	Q301	8-729-216-22	TRANSISTOR 2SA1162-G	

**A (KV-XF21N90)**

REF. NO.	PART NO.	DESCRIPTION	REMARK	REF. NO.	PART NO.	DESCRIPTION	REMARK
Q302	8-729-230-49	TRANSISTOR 2SC2712-YG		R028	1-216-049-91	RES,CHIP 1K	5% 1/10W
Q303	8-729-216-22	TRANSISTOR 2SA1162-G		R029	1-216-049-91	RES,CHIP 1K	5% 1/10W
Q305	8-729-216-22	TRANSISTOR 2SA1162-G		R030	1-216-025-91	RES,CHIP 100	5% 1/10W
Q306	8-729-216-22	TRANSISTOR 2SA1162-G		R031	1-216-049-91	RES,CHIP 1K	5% 1/10W
Q307	8-729-230-49	TRANSISTOR 2SC2712-YG		R034	1-216-049-91	RES,CHIP 1K	5% 1/10W
Q308	8-729-216-22	TRANSISTOR 2SA1162-G		R035	1-216-025-91	RES,CHIP 100	5% 1/10W
Q312	8-729-216-22	TRANSISTOR 2SA1162-G		R036	1-216-025-91	RES,CHIP 100	5% 1/10W
Q313	8-729-230-49	TRANSISTOR 2SC2712-YG		R037	1-216-083-00	RES,CHIP 27K	5% 1/10W
Q315	8-729-421-19	TRANSISTOR UN2213		R040	1-216-025-91	RES,CHIP 100	5% 1/10W
Q401	8-729-424-67	TRANSISTOR UN2216		R041	1-216-025-91	RES,CHIP 100	5% 1/10W
Q402	8-729-424-67	TRANSISTOR UN2216		R042	1-216-295-91	SHORT 0	
Q403	8-729-216-22	TRANSISTOR 2SA1162-G		R043	1-216-049-91	RES,CHIP 1K	5% 1/10W
Q404	8-729-216-22	TRANSISTOR 2SA1162-G		R044	1-216-025-91	RES,CHIP 100	5% 1/10W
Q503	8-729-230-49	TRANSISTOR 2SC2712-YG		R045	1-414-233-22	INDUCTOR CHIP 0UH	
Q505	8-729-931-45	TRANSISTOR IRF614		R046	1-216-049-91	RES,CHIP 1K	5% 1/10W
Q506	8-729-140-96	TRANSISTOR 2SD774-34		R047	1-414-233-22	INDUCTOR CHIP 0UH	
Q507	8-729-216-22	TRANSISTOR 2SA1162-G		R048	1-216-073-00	RES,CHIP 10K	5% 1/10W
Q509	8-729-230-49	TRANSISTOR 2SC2712-YG		R050	1-216-073-00	RES,CHIP 10K	5% 1/10W
Q511	8-729-048-07	TRANSISTOR 2SD2578-CA		R053	1-216-049-91	RES,CHIP 1K	5% 1/10W
Q600	8-729-119-78	TRANSISTOR 2SC2785-HFE		R055	1-216-073-00	RES,CHIP 10K	5% 1/10W
Q601	8-729-023-22	TRANSISTOR 2SD2114K		R056	1-216-073-00	RES,CHIP 10K	5% 1/10W
Q602	8-729-230-49	TRANSISTOR 2SC2712-YG		R061	1-216-033-00	RES,CHIP 220	5% 1/10W
Q603	8-729-424-08	TRANSISTOR UN2111		R062	1-216-041-00	RES,CHIP 470	5% 1/10W
Q604	8-729-200-17	TRANSISTOR 2SA1091-O		R063	1-216-037-00	RES,CHIP 330	5% 1/10W
Q605	8-729-044-30	TRANSISTOR 2SK2845-LB102		R064	1-216-037-00	RES,CHIP 330	5% 1/10W
Q606	8-729-230-49	TRANSISTOR 2SC2712-YG		R065	1-216-037-00	RES,CHIP 330	5% 1/10W
Q607	8-729-922-37	TRANSISTOR 2SD2144S-UVW		R066	1-216-049-91	RES,CHIP 1K	5% 1/10W
Q608	8-729-230-49	TRANSISTOR 2SC2712-YG		R103	1-216-025-91	RES,CHIP 100	5% 1/10W
Q901	8-729-421-19	TRANSISTOR UN2213		R104	1-216-025-91	RES,CHIP 100	5% 1/10W
Q902	8-729-421-19	TRANSISTOR UN2213		R105	1-216-295-91	SHORT 0	
		<RESISTOR>		R106	1-216-049-91	RES,CHIP 1K	5% 1/10W
R001	1-414-233-22	INDUCTOR CHIP 0UH		R109	1-216-041-00	RES,CHIP 470	5% 1/10W
R002	1-216-025-91	RES,CHIP 100	5% 1/10W	R111	1-216-025-91	RES,CHIP 100	5% 1/10W
R003	1-216-073-00	RES,CHIP 10K	5% 1/10W	R112	1-216-025-91	RES,CHIP 100	5% 1/10W
R004	1-216-025-91	RES,CHIP 100	5% 1/10W	R113	1-216-047-91	RES,CHIP 820	5% 1/10W
R005	1-216-025-91	RES,CHIP 100	5% 1/10W	R114	1-216-065-91	RES,CHIP 4.7K	5% 1/10W
R006	1-216-689-11	RES,CHIP 39K	5% 1/10W	R115	1-216-065-91	RES,CHIP 4.7K	5% 1/10W
R007	1-216-033-00	RES,CHIP 220	5% 1/10W	R202	1-216-053-00	RES,CHIP 1.5K	5% 1/10W
R008	1-216-065-91	RES,CHIP 4.7K	5% 1/10W	R203	1-216-057-00	RES,CHIP 2.2K	5% 1/10W
R009	1-216-065-91	RES,CHIP 4.7K	5% 1/10W	R204	1-216-069-00	RES,CHIP 6.8K	5% 1/10W
R010	1-216-065-91	RES,CHIP 4.7K	5% 1/10W	R205	1-216-069-00	RES,CHIP 6.8K	5% 1/10W
R011	1-216-065-91	RES,CHIP 4.7K	5% 1/10W	R206	1-216-057-00	RES,CHIP 2.2K	5% 1/10W
R012	1-216-065-91	RES,CHIP 4.7K	5% 1/10W	R207	1-216-053-00	RES,CHIP 1.5K	5% 1/10W
R013	1-216-065-91	RES,CHIP 4.7K	5% 1/10W	R208	1-216-069-00	RES,CHIP 6.8K	5% 1/10W
R014	1-216-025-91	RES,CHIP 100	5% 1/10W	R209	1-216-069-00	RES,CHIP 6.8K	5% 1/10W
R015	1-216-025-91	RES,CHIP 100	5% 1/10W	R210	1-216-029-00	RES,CHIP 150	5% 1/10W
R016	1-216-025-91	RES,CHIP 100	5% 1/10W	R212	1-216-029-00	RES,CHIP 150	5% 1/10W
R017	1-216-049-91	RES,CHIP 1K	5% 1/10W	R213	1-216-073-00	RES,CHIP 10K	5% 1/10W
R018	1-216-033-00	RES,CHIP 220	5% 1/10W	R214	1-216-073-00	RES,CHIP 10K	5% 1/10W
R019	1-216-073-00	RES,CHIP 10K	5% 1/10W	R215	1-216-059-00	RES,CHIP 2.7K	5% 1/10W
R021	1-216-073-00	RES,CHIP 10K	5% 1/10W	R216	1-216-059-00	RES,CHIP 2.7K	5% 1/10W
R022	1-216-033-00	RES,CHIP 220	5% 1/10W	R217	1-216-067-00	RES,CHIP 5.6K	5% 1/10W
R024	1-216-057-00	RES,CHIP 2.2K	5% 1/10W	R218	1-216-067-00	RES,CHIP 5.6K	5% 1/10W
R025	1-216-057-00	RES,CHIP 2.2K	5% 1/10W	R219	1-216-025-91	RES,CHIP 100	5% 1/10W
R026	1-216-057-00	RES,CHIP 2.2K	5% 1/10W	R220	1-216-025-91	RES,CHIP 100	5% 1/10W
R027	1-216-073-00	RES,CHIP 10K	5% 1/10W	R221	1-216-295-91	SHORT 0	
				R222	1-216-295-91	SHORT 0	
				R225	1-216-033-00	RES,CHIP 220	5% 1/10W

**A (KV-XF21N90)**

REF. NO.	PART NO.	DESCRIPTION			REMARK	REF. NO.	PART NO.	DESCRIPTION			REMARK
R226	1-216-033-00	RES,CHIP	220	5%	1/10W	R365	1-216-033-00	RES,CHIP	220	5%	1/10W
R227	1-216-033-00	RES,CHIP	220	5%	1/10W	R366	1-216-073-00	RES,CHIP	10K	5%	1/10W
R228	1-249-389-11	CARBON	4.7	5%	1/4W	R367	1-216-073-00	RES,CHIP	10K	5%	1/10W
R229	1-216-073-00	RES,CHIP	10K	5%	1/10W	R370	1-216-033-00	RES,CHIP	220	5%	1/10W
R230	1-216-069-00	RES,CHIP	6.8K	5%	1/10W	R376	1-216-081-00	RES,CHIP	22K	5%	1/10W
R231	1-216-295-91	SHORT	0			R377	1-216-121-91	RES,CHIP	1M	5%	1/10W
R234	1-249-389-11	CARBON	4.7	5%	1/4W	R378	1-216-031-00	RES,CHIP	180	5%	1/10W
R235	1-216-069-00	RES,CHIP	6.8K	5%	1/10W	R401	1-216-049-91	RES,CHIP	1K	5%	1/10W
R236	1-216-069-00	RES,CHIP	6.8K	5%	1/10W	R402	1-216-073-00	RES,CHIP	10K	5%	1/10W
R237	1-216-308-00	RES,CHIP	4.7	5%	1/10W	R403	1-216-073-00	RES,CHIP	10K	5%	1/10W
R301	1-216-073-00	RES,CHIP	10K	5%	1/10W	R404	1-216-073-00	RES,CHIP	10K	5%	1/10W
R302	1-216-295-91	SHORT	0			R405	1-216-049-91	RES,CHIP	1K	5%	1/10W
R303	1-216-049-91	RES,CHIP	1K	5%	1/10W	R406	1-216-073-00	RES,CHIP	10K	5%	1/10W
R304	1-216-073-00	RES,CHIP	10K	5%	1/10W	R407	1-216-049-91	RES,CHIP	1K	5%	1/10W
R305	1-216-051-00	RES,CHIP	1.2K	5%	1/10W	R408	1-216-049-91	RES,CHIP	1K	5%	1/10W
R306	1-216-073-00	RES,CHIP	10K	5%	1/10W	R409	1-216-041-00	RES,CHIP	470	5%	1/10W
R307	1-216-295-91	SHORT	0			R410	1-216-113-00	RES,CHIP	470K	5%	1/10W
R308	1-216-025-91	RES,CHIP	100	5%	1/10W	R411	1-216-113-00	RES,CHIP	470K	5%	1/10W
R309	1-216-025-91	RES,CHIP	100	5%	1/10W	R412	1-216-041-00	RES,CHIP	470	5%	1/10W
R310	1-216-025-91	RES,CHIP	100	5%	1/10W	R413	1-216-021-00	RES,CHIP	68	5%	1/10W
R311	1-216-017-91	RES,CHIP	47	5%	1/10W	R414	1-216-113-00	RES,CHIP	470K	5%	1/10W
R312	1-216-041-00	RES,CHIP	470	5%	1/10W	R415	1-216-113-00	RES,CHIP	470K	5%	1/10W
R313	1-216-053-00	RES,CHIP	1.5K	5%	1/10W	R416	1-216-077-00	RES,CHIP	15K	5%	1/10W
R314	1-216-045-00	RES,CHIP	680	5%	1/10W	R417	1-216-077-00	RES,CHIP	15K	5%	1/10W
R316	1-216-053-00	RES,CHIP	1.5K	5%	1/10W	R418	1-216-113-00	RES,CHIP	470K	5%	1/10W
R317	1-216-077-00	RES,CHIP	15K	5%	1/10W	R419	1-216-022-00	RES,CHIP	75	5%	1/10W
R318	1-216-051-00	RES,CHIP	1.2K	5%	1/10W	R426	1-216-033-00	RES,CHIP	220	5%	1/10W
R319	1-216-025-91	RES,CHIP	100	5%	1/10W	R505	1-216-099-00	RES,CHIP	120K	5%	1/10W
R320	1-216-065-91	RES,CHIP	4.7K	5%	1/10W	R506	1-216-085-00	RES,CHIP	33K	5%	1/10W
R321	1-216-073-00	RES,CHIP	10K	5%	1/10W	R507	1-249-389-11	CARBON	4.7	5%	1/4W F
R322	1-216-033-00	RES,CHIP	220	5%	1/10W	R508	1-215-910-00	METAL OXIDE	68	5%	3W F
R326	1-216-295-91	SHORT	0			R509	1-215-911-11	METAL OXIDE	100	5%	3W F
R331	1-216-295-91	SHORT	0			R510	1-215-885-00	METAL OXIDE	68	5%	2W F
R332	1-216-033-00	RES,CHIP	220	5%	1/10W	R511	1-215-911-11	METAL OXIDE	100	5%	3W F
R333	1-216-073-00	RES,CHIP	10K	5%	1/10W	R516	1-216-081-00	RES,CHIP	22K	5%	1/10W
R334	1-216-129-00	RES,CHIP	2.2M	5%	1/10W	R518	1-247-807-31	CARBON	100	5%	1/4W
R335	1-216-045-00	RES,CHIP	680	5%	1/10W	R520	1-215-445-00	METAL	10K	1%	1/4W
R338	1-216-033-00	RES,CHIP	220	5%	1/10W	R522	1-216-675-11	METAL CHIP	10K	0.50%	1/10W
R340	1-216-025-91	RES,CHIP	100	5%	1/10W	R523	1-249-411-11	CARBON	330	5%	1/4W
R345	1-216-081-00	RES,CHIP	22K	5%	1/10W	R525	1-216-699-11	METAL CHIP	100K	0.50%	1/10W
R346	1-216-051-00	RES,CHIP	1.2K	5%	1/10W	R526	1-208-798-11	RES,CHIP	4.7K	0.50%	1/10W
R347	1-216-051-00	RES,CHIP	1.2K	5%	1/10W	R527	1-216-001-00	RES,CHIP	10	5%	1/10W
R348	1-216-675-11	METAL CHIP	10K	0.50%	1/10W	R528	1-216-683-11	METAL CHIP	22K	0.50%	1/10W
R349	1-216-073-00	RES,CHIP	10K	5%	1/10W	R529	1-216-635-11	METAL CHIP	220	0.50%	1/10W
R350	1-216-061-00	RES,CHIP	3.3K	5%	1/10W	R531	1-247-843-11	CARBON	3.3K	5%	1/4W
R351	1-216-053-00	RES,CHIP	1.5K	5%	1/10W	R533	1-249-417-11	CARBON	1K	5%	1/4W
R354	1-216-057-00	RES,CHIP	2.2K	5%	1/10W	R534	1-216-361-00	METAL OXIDE	0.22	5%	2W F
R355	1-216-057-00	RES,CHIP	2.2K	5%	1/10W	R535	1-216-067-00	RES,CHIP	5.6K	5%	1/10W
R356	1-216-057-00	RES,CHIP	2.2K	5%	1/10W	R536	1-216-067-00	RES,CHIP	5.6K	5%	1/10W
R357	1-216-079-00	RES,CHIP	18K	5%	1/10W	R537	1-216-683-11	METAL CHIP	22K	0.50%	1/10W
R358	1-216-049-91	RES,CHIP	1K	5%	1/10W	R540	1-216-065-91	RES,CHIP	4.7K	5%	1/10W
R359	1-216-033-00	RES,CHIP	220	5%	1/10W	R541	1-216-065-91	RES,CHIP	4.7K	5%	1/10W
R360	1-216-033-00	RES,CHIP	220	5%	1/10W	R542	1-216-295-91	SHORT	0		
R361	1-216-073-00	RES,CHIP	10K	5%	1/10W	R543	1-249-426-11	CARBON	5.6K	5%	1/4W F
R362	1-216-075-00	RES,CHIP	12K	5%	1/10W	R545	1-216-077-00	RES,CHIP	15K	5%	1/10W
R363	1-216-079-00	RES,CHIP	18K	5%	1/10W	R546	1-216-077-00	RES,CHIP	15K	5%	1/10W
R364	1-216-295-91	SHORT	0			R547	1-216-085-00	RES,CHIP	33K	5%	1/10W
						R549	1-215-451-00	METAL	18K	1%	1/4W



## KV-HF51P50/XF21M80/XF21M83/XF21N90/XF51M65

RM-952 RM-952 RM-952 RM-915 RM-952

**A** (KV-XF21N90)The components identified by shading and mark  $\Delta$  are critical for safety. Replace only with part number specified.

REF. NO.	PART NO.	DESCRIPTION	REMARK
R550	1-216-097-91	RES,CHIP	100K 5% 1/10W
R551	1-249-421-11	CARBON	2.2K 5% 1/4W
R552	1-216-057-00	RES,CHIP	2.2K 5% 1/10W
R553	1-215-457-00	METAL	33K 1% 1/4W
R554	1-215-457-00	METAL	33K 1% 1/4W
R556	1-215-437-00	METAL	4.7K 1% 1/4W
R558	1-249-421-11	CARBON	2.2K 5% 1/4W
R559	1-249-429-11	CARBON	10K 5% 1/4W
R560	1-216-073-00	RES,CHIP	10K 5% 1/10W
R562	1-249-401-11	CARBON	47 5% 1/4W
R565	1-216-073-00	RES,CHIP	10K 5% 1/10W
R567	1-216-105-91	RES,CHIP	220K 5% 1/10W
R568	1-249-383-11	CARBON	1.5 5% 1/4W F
R570	1-216-069-00	RES,CHIP	6.8K 5% 1/10W
R571	1-215-437-00	METAL	4.7K 1% 1/4W
R573	1-216-089-91	RES,CHIP	47K 5% 1/10W
R577	1-215-913-11	METAL OXIDE	220 5% 3W F
R578	1-216-369-00	METAL OXIDE	1 5% 2W F
R579	1-216-097-91	RES,CHIP	100K 5% 1/10W
R580	1-216-699-11	METAL CHIP	100K 0.50% 1/10W
R581	1-208-798-11	RES,CHIP	4.7K 0.50% 1/10W
R585	1-249-391-11	CARBON	6.8 5% 1/4W F
R588	1-215-888-00	METAL OXIDE	220 5% 2W F
R589	1-215-888-00	METAL OXIDE	220 5% 2W F
R590	1-215-465-00	METAL	68K 1% 1/4W
R591	1-260-288-11	CARBON	0.47 5% 1/2W F
R593	1-260-288-11	CARBON	0.47 5% 1/2W F
R594	1-260-288-11	CARBON	0.47 5% 1/2W F
R596	1-215-922-11	METAL OXIDE	6.8K 5% 3W F
R597	1-247-750-11	CARBON	680 5% 1/2W F
R598	1-249-438-11	CARBON	56K 5% 1/4W
R599	1-249-389-11	CARBON	4.7 5% 1/4W
R600	1-249-438-11	CARBON	56K 5% 1/4W
R601	1-249-418-11	CARBON	1.2K 5% 1/4W F
R602	1-249-389-11	CARBON	4.7 5% 1/4W F
R603	1-215-485-00	METAL	470K 1% 1/4W
R604	1-216-097-91	RES,CHIP	100K 5% 1/10W
R607	1-249-425-11	CARBON	4.7K 5% 1/4W
R608	1-240-205-91	CARBON	22M 5% 1/2W
R609	1-216-057-00	RES,CHIP	2.2K 5% 1/10W
R610	1-216-073-00	RES,CHIP	10K 5% 1/10W
R611	1-216-089-91	RES,CHIP	47K 5% 1/10W
R612	1-216-045-00	RES,CHIP	680 5% 1/10W
R614	1-216-041-00	RES,CHIP	470 5% 1/10W
R615	1-216-350-11	METAL OXIDE	1.2 5% 1W F
R616	1-260-302-51	CARBON	6.8 5% 1/2W F
R617	1-247-791-91	CARBON	22 5% 1/4W
R619	1-260-128-11	CARBON	270K 5% 1/2W
R620	1-215-915-11	METAL OXIDE	470 5% 3W F
R621	1-215-859-00	METAL OXIDE	22 5% 1W F
R622	1-216-400-11	METAL OXIDE	8.2 5% 3W F
R623	1-216-095-00	RES,CHIP	82K 5% 1/10W
R624	1-216-089-91	RES,CHIP	47K 5% 1/10W
R626	1-216-049-91	RES,CHIP	1K 5% 1/10W
R627	1-240-251-11	CMT,MELF	6.8 5% 10W
R629	1-247-747-11	CARBON	470 5% 1/2W F
R630	1-249-429-11	CARBON	10K 5% 1/4W F

REF. NO.	PART NO.	DESCRIPTION	REMARK
R631	1-216-089-91	RES,CHIP	47K 5% 1/10W
R632	1-202-933-61	FUSIBLE	0.1 10% 1/2W F
R634	$\Delta$ 1-218-265-91	METAL	8.2M 5% 1W
R635	1-216-492-11	METAL OXIDE	82K 5% 3W F
R636	1-215-924-00	METAL OXIDE	15K 5% 3W F
R637	1-216-492-11	METAL OXIDE	82K 5% 3W F
R639	1-216-363-00	METAL OXIDE	0.33 5% 2W F
R640	1-249-415-11	CARBON	680 5% 1/4W
R641	1-216-362-11	METAL OXIDE	0.27 5% 2W F
R642	1-249-419-11	CARBON	1.5K 5% 1/4W
R643	1-247-843-11	CARBON	3.3K 5% 1/4W
R644	1-249-419-11	CARBON	1.5K 5% 1/4W
R646	1-215-924-00	METAL OXIDE	15K 5% 3W F
R647	1-249-401-11	CARBON	47 5% 1/4W
R648	1-216-057-00	RES,CHIP	2.2K 5% 1/10W
R649	1-249-417-11	CARBON	1K 5% 1/4W
R650	1-215-882-00	METAL OXIDE	22 5% 2W F
R652	1-215-900-11	METAL OXIDE	22K 5% 2W F
R653	1-215-873-00	METAL OXIDE	4.7K 5% 1W F
R656	1-249-417-11	CARBON	1K 5% 1/4W
R657	1-260-127-11	CARBON	220K 5% 1/2W
R659	1-216-049-91	RES,CHIP	1K 5% 1/10W
R660	1-216-073-00	RES,CHIP	10K 5% 1/10W
R661	1-215-873-00	METAL OXIDE	4.7K 5% 1W F
R680	1-216-308-00	RES,CHIP	4.7 5% 1/10W
R901	1-249-411-11	CARBON	330 5% 1/4W
R902	1-249-411-11	CARBON	330 5% 1/4W
R903	1-216-022-00	RES,CHIP	75 5% 1/10W
R904	1-216-033-00	RES,CHIP	220 5% 1/10W
R905	1-216-113-00	RES,CHIP	470K 5% 1/10W
R906	1-216-077-00	RES,CHIP	15K 5% 1/10W
R907	1-216-113-00	RES,CHIP	470K 5% 1/10W
R908	1-216-077-00	RES,CHIP	15K 5% 1/10W
R909	1-216-065-91	RES,CHIP	4.7K 5% 1/10W
R910	1-216-065-91	RES,CHIP	4.7K 5% 1/10W
R911	1-216-067-00	RES,CHIP	5.6K 5% 1/10W
R912	1-216-041-00	RES,CHIP	470 5% 1/10W
R913	1-216-049-91	RES,CHIP	1K 5% 1/10W
R914	1-216-055-00	RES,CHIP	1.8K 5% 1/10W
R915	1-216-061-00	RES,CHIP	3.3K 5% 1/10W
R916	1-216-017-91	RES,CHIP	47 5% 1/10W
R917	1-216-041-00	RES,CHIP	470 5% 1/10W
R918	1-216-041-00	RES,CHIP	470 5% 1/10W
RY600	$\Delta$ 1-755-040-11	RELAY	
RY601	$\Delta$ 1-755-266-11	RELAY, AC POWER	
		<RELAY>	
		<SWITCH>	
S502	1-572-707-11	SWITCH, LEVER	
S600	$\Delta$ 1-571-433-31	SWITCH, PUSH (AC POWER)	
S901	1-692-431-21	SWITCH, TACTILE	
S902	1-692-431-21	SWITCH, TACTILE	
S903	1-692-431-21	SWITCH, TACTILE	

The components identified by shading and mark  $\Delta$  are critical for safety. Replace only with part number specified.

A (KV-XF21N90)

C5

REF. NO.	PART NO.	DESCRIPTION	REMARK	REF. NO.	PART NO.	DESCRIPTION	REMARK
S904	1-692-431-21	SWITCH, TACTILE		C746	1-102-114-00	CERAMIC	470PF 10% 50V
S905	1-692-431-21	SWITCH, TACTILE		C1803	1-126-964-11	ELECT	10MF 20% 50V
S906	1-692-431-21	SWITCH, TACTILE		C1804	1-126-964-11	ELECT	10MF 20% 50V
S907	1-692-431-21	SWITCH, TACTILE		C1809	1-126-942-61	ELECT	1000MF 20% 25V
<TRANSFORMER>				<CONNECTOR>			
T501	1-437-195-11	TRANSFORMER, HORIZONTAL DRIVE		CN701	1-508-765-00	PIN, CONNECTOR (5MM PITCH) 3P	
T503	$\Delta$ 1-453-293-11	TRANSFORMER ASSY, FLYBACK (NX-1748//M3A4)		CN702	1-695-915-11	TAB (CONTACT)	
T601	1-424-682-11	TRANSFORMER, LINE FILTER		CN703	* 1-564-509-11	PLUG, CONNECTOR 6P	
T603	$\Delta$ 1-433-513-31	TRANSFORMER, CONVERTER (SRT)		CN704	1-695-915-11	TAB (CONTACT)	
T604	$\Delta$ 1-431-852-11	TRANSFORMER, CONVERTER (SRT)		CN1801	* 1-564-507-11	PLUG, CONNECTOR 4P	
<THERMISTOR>				<DIODE>			
THP600	1-809-539-11	THERMISTOR, POSITIVE		D701	8-719-911-19	DIODE 1SS119-25	
<TUNER>				D702	8-719-911-19	DIODE 1SS119-25	
TU101	8-598-477-10	TUNER, FSS BTF-WG411		D703	8-719-911-19	DIODE 1SS119-25	
<CRYSTAL>				D707	8-719-911-19	DIODE 1SS119-25	
X001	1-579-125-11	VIBRATOR, CERAMIC		D708	8-719-911-19	DIODE 1SS119-25	
X302	1-781-132-21	VIBRATOR, CRYSTAL		D709	8-719-911-19	DIODE 1SS119-25	
*****				D710	8-719-911-19	DIODE 1SS119-25	
* A-1331-962-A	C5 BOARD, MOUNTED (KV-HF51P50/XF51M65)	*****		D711	8-719-911-19	DIODE 1SS119-25	
* A-1331-959-A	C5 BOARD, MOUNTED (KV-XF21M80(E/ME))	*****		D712	8-719-911-19	DIODE 1SS119-25	
* A-1331-955-A	C5 BOARD, MOUNTED (KV-XF21M80(VIETNAM)/XF21M83)	*****		D713	8-719-911-19	DIODE 1SS119-25	
* A-1331-941-A	C5 BOARD, MOUNTED (KV-XF21N90)	*****		D714	8-719-911-19	DIODE 1SS119-25	
7-682-948-01	SCREW +PSW 3X8			D715	8-719-911-19	DIODE 1SS119-25	
<CAPACITOR>				D716	8-719-911-19	DIODE 1SS119-25	
C701	1-115-350-51	CERAMIC	0.0047MF 2KV	D717	8-719-121-26	DIODE RD9.1ESL2	
C702	1-102-074-00	CERAMIC	0.001MF 10% 50V	D1803	8-719-911-19	DIODE 1SS119-25	
C703	1-107-651-11	ELECT	4.7MF 20% 250V	D1804	8-719-911-19	DIODE 1SS119-25	
C704	1-130-202-00	FILM	0.022MF 5% 400V	D1808	8-719-908-03	DIODE GP08D	
C706	1-104-664-11	ELECT	47MF 20% 16V	<IC>			
C708	1-102-114-00	CERAMIC	470PF 10% 50V	IC1800	8-759-822-38	IC LA6510	
C709	1-102-114-00	CERAMIC	470PF 10% 50V	<JACK>			
C710	1-102-114-00	CERAMIC	470PF 10% 50V	J701	$\Delta$ 1-540-071-22	SOCKET, CRT	
C712	1-102-116-00	CERAMIC	680PF 10% 50V	<COIL>			
C713	1-102-116-00	CERAMIC	680PF 10% 50V	L701	1-410-667-31	INDUCTOR	22UH
C714	1-102-116-00	CERAMIC	680PF 10% 50V	L710	1-408-609-41	INDUCTOR	33UH
C716	1-126-933-11	ELECT	100MF 20% 16V	L711	1-408-609-41	INDUCTOR	33UH
C717	1-101-880-00	CERAMIC	47PF 5% 50V	L712	1-408-609-41	INDUCTOR	33UH
C736	1-102-114-00	CERAMIC	470PF 10% 50V	<TRANSISTOR>			
C737	1-102-114-00	CERAMIC	470PF 10% 50V	Q704	8-729-326-11	TRANSISTOR 2SC2611	
				Q705	8-729-326-11	TRANSISTOR 2SC2611	
				Q706	8-729-326-11	TRANSISTOR 2SC2611	
				Q707	8-729-200-17	TRANSISTOR 2SA1091-O	
				Q708	8-729-200-17	TRANSISTOR 2SA1091-O	

The components identified by shading and mark  $\Delta$  are critical for safety. Replace only with part number specified.

**H4 (KV-XF21M83/XF51M65 only)****F****C5**

REF. NO.	PART NO.	DESCRIPTION	REMARK
Q709	8-729-200-17	TRANSISTOR 2SA1091-O	
Q710	8-729-119-78	TRANSISTOR 2SC2785-HFE	
Q711	8-729-119-78	TRANSISTOR 2SC2785-HFE	
Q712	8-729-119-78	TRANSISTOR 2SC2785-HFE	
Q1802	8-729-119-78	TRANSISTOR 2SC2785-HFE	
		<RESISTOR>	
R703	1-249-496-11	CARBON 100K	5% 1/2W
R705	1-216-380-11	METAL OXIDE 8.2	5% 2W F
R706	1-215-417-00	METAL 680	1% 1/4W
R707	1-215-413-00	METAL 470	1% 1/4W
R708	1-216-379-11	METAL OXIDE 6.8	5% 2W F
R710	1-215-922-11	METAL OXIDE 6.8K	5% 3W F
R711	1-247-752-11	CARBON 1K	5% 1/2W
R712	1-215-922-11	METAL OXIDE 6.8K	5% 3W F
R713	1-247-752-11	CARBON 1K	5% 1/2W
R714	1-215-922-11	METAL OXIDE 6.8K	5% 3W F
R715	1-247-752-11	CARBON 1K	5% 1/2W
R719	1-215-480-00	METAL 300K	1% 1/4W
R720	1-249-923-11	CARBON 1K	5% 1/4W F
R721	1-215-489-00	METAL 680K	1% 1/4W
R722	1-249-923-11	CARBON 1K	5% 1/4W F
R723	1-215-479-00	METAL 270K	1% 1/4W
R724	1-249-923-11	CARBON 1K	5% 1/4W F
R725	1-249-421-11	CARBON 2.2K	5% 1/4W
R726	1-249-421-11	CARBON 2.2K	5% 1/4W
R727	1-249-421-11	CARBON 2.2K	5% 1/4W
R728	1-249-407-11	CARBON 150	5% 1/4W
R729	1-249-407-11	CARBON 150	5% 1/4W
R730	1-249-407-11	CARBON 150	5% 1/4W
R731	1-249-399-11	CARBON 33	5% 1/4W
R732	1-249-399-11	CARBON 33	5% 1/4W
R733	1-249-399-11	CARBON 33	5% 1/4W
R734	1-247-739-11	CARBON 100	5% 1/2W
R738	1-247-807-31	CARBON 100	5% 1/4W
R739	1-247-807-31	CARBON 100	5% 1/4W
R740	1-247-807-31	CARBON 100	5% 1/4W
R755	1-249-418-11	CARBON 1.2K	5% 1/4W
R756	1-249-418-11	CARBON 1.2K	5% 1/4W
R757	1-249-418-11	CARBON 1.2K	5% 1/4W
R1802	1-249-387-11	CARBON 3.3	5% 1/4W F
R1803	1-249-387-11	CARBON 3.3	5% 1/4W F
R1805	1-249-429-11	CARBON 10K	5% 1/4W
R1806	1-249-425-11	CARBON 4.7K	5% 1/4W
R1808	1-249-425-11	CARBON 4.7K	5% 1/4W
R1809	1-249-435-11	CARBON 33K	5% 1/4W
R1810	1-249-435-11	CARBON 33K	5% 1/4W
R1811	1-249-440-11	CARBON 82K	5% 1/4W
R1812	1-249-435-11	CARBON 33K	5% 1/4W
R1821	1-249-440-11	CARBON 82K	5% 1/4W
R1822	1-249-435-11	CARBON 33K	5% 1/4W
R1823	1-249-426-11	CARBON 5.6K	5% 1/4W
R1824	1-249-435-11	CARBON 33K	5% 1/4W

REF. NO.	PART NO.	DESCRIPTION	REMARK
		<VARIABLE RESISTOR>	
RV702	1-241-656-21	RES, ADJ, METAL FILM 110M	
*****			
* A-1241-381-A		F BOARD, MOUNTED (KV-HF51P50/XF51M65)	
		*****	
* A-1241-379-A		F BOARD, MOUNTED (KV-XF21M80(E/ME))	
		*****	
* A-1241-378-A		F BOARD, MOUNTED (KV-XF21M80(VIETNAM)/XF21M83)	
		*****	
* A-1241-383-A		F BOARD, MOUNTED (KV-XF21N90)	
		*****	
1-533-223-11		CLIP, FUSE	
* 4-374-846-01		COVER, CAPACITOR, CAP TYPE	
C654 $\Delta$ 1-117-703-51		CERAMIC 0.0047MF 99% 250V	
C4602 $\Delta$ 1-104-708-51		FILM 0.47MF 20% 250V	
		<CONNECTOR>	
CN4601*	1-580-843-11	PIN, CONNECTOR (POWER)	
CN4602*	1-580-843-11	PIN, CONNECTOR (POWER)	
CN4603	1-695-915-11	TAB (CONTACT)	
		<FUSE>	
F4601 $\Delta$ 1-532-237-11		FUSE, TIME-LAG (BET) 3.15A/250V	
		<RESISTOR>	
R4601 $\Delta$ 1-202-719-91		SOLID 1M 10% 1/2W	
		<TRANSFORMER>	
T4601	1-424-682-11	TRANSFORMER, LINE FILTER	
T4602	1-424-682-11	TRANSFORMER, LINE FILTER	
		<VARISTOR>	
VDR461	1-801-073-31	VARISTOR TNR14V471K660 (except KV-XF21N90)	
VDR461	1-801-451-51	VARISTOR TNR14V271K660 (KV-XF21N90 only)	
*****			
* A-1372-669-A		H4 BOARD, MOUNTED (KV-XF21M83)	
		*****	
* A-1372-681-A		H4 BOARD, MOUNTED (KV-XF51M65)	
		*****	



**V1(KV-XF51M65 only)**

REF. NO.	PART NO.	DESCRIPTION	REMARK	REF. NO.	PART NO.	DESCRIPTION	REMARK
R4217	1-216-025-91	RES,CHIP	100 5%			<IC>	
R4218	1-249-441-11	CARBON	100K 5%				
R4219	1-216-097-91	RES,CHIP	100K 5%				
R4221	1-249-426-11	CARBON	5.6K 5%				
R4222	1-249-429-11	CARBON	10K 5%				
R4230	1-216-057-00	RES,CHIP	2.2K 5%				
*****							
	* A-1347-159-A	V1 BOARD, COMPLETE (KV-XF51M65 ONLY)					
*****							
<CAPACITOR>							
C801	1-104-664-11	ELECT	47MF 20%				
C805	1-163-038-91	CERAMIC CHIP	0.1MF 25V				
C806	1-163-038-91	CERAMIC CHIP	0.1MF 25V				
C815	1-163-251-11	CERAMIC CHIP	100PF 5%				
C816	1-164-505-11	CERAMIC CHIP	2.2MF 16V				
C817	1-164-004-11	CERAMIC CHIP	0.1MF 10%				
C818	1-163-239-11	CERAMIC CHIP	33PF 5%				
C820	1-163-239-11	CERAMIC CHIP	33PF 5%				
C821	1-163-038-91	CERAMIC CHIP	0.1MF 25V				
C822	1-163-009-11	CERAMIC CHIP	0.001MF 10%				
C823	1-126-933-11	ELECT	100MF 20%				
C826	1-126-963-11	ELECT	4.7MF 20%				
C829	1-163-113-00	CERAMIC CHIP	68PF 5%				
C830	1-163-038-91	CERAMIC CHIP	0.1MF 25V				
C831	1-126-933-11	ELECT	100MF 20%				
C832	1-126-964-11	ELECT	10MF 20%				
C835	1-163-038-91	CERAMIC CHIP	0.1MF 25V				
C837	1-126-933-11	ELECT	100MF 20%				
<CONNECTOR>							
CN801	* 1-774-812-11	CONNECTOR, BOARD TO BOARD 7P					
CN803	* 1-774-812-11	CONNECTOR, BOARD TO BOARD 7P					
<DIODE>							
D802	8-719-914-44	DIODE DAP202K					
D803	8-719-105-46	DIODE RD3.3M-B2					
D804	8-719-105-91	DIODE RD5.6M-B2					
D806	8-719-988-61	DIODE 1SS355TE-17					
D807	8-719-988-61	DIODE 1SS355TE-17					
<FERRITE BEAD>							
FB801	1-410-397-21	FERRITE	1.1UH				
FB802	1-410-397-21	FERRITE	1.1UH				
FB803	1-410-397-21	FERRITE	1.1UH				
FB804	1-410-682-31	INDUCTOR	470UH				
FB805	1-410-397-21	FERRITE	1.1UH				
IC801	8-759-476-87	IC SAA5261					
<CHIP CONDUCTOR>							
JR801	1-216-295-91	SHORT	0				
JR802	1-216-295-91	SHORT	0				
JR804	1-216-295-91	SHORT	0				
JR805	1-216-295-91	SHORT	0				
JR806	1-216-295-91	SHORT	0				
JR807	1-216-295-91	SHORT	0				
JR808	1-216-295-91	SHORT	0				
<TRANSISTOR>							
Q801	8-729-120-28	TRANSISTOR 2SC1623-L5L6					
Q803	8-729-120-28	TRANSISTOR 2SC1623-L5L6					
Q805	8-729-120-28	TRANSISTOR 2SC1623-L5L6					
Q806	8-729-120-28	TRANSISTOR 2SC1623-L5L6					
Q807	8-729-120-28	TRANSISTOR 2SC1623-L5L6					
Q808	8-729-120-28	TRANSISTOR 2SC1623-L5L6					
Q810	8-729-120-28	TRANSISTOR 2SC1623-L5L6					
Q811	8-729-019-01	TRANSISTOR 2SD2394-EF					
Q812	8-729-120-28	TRANSISTOR 2SC1623-L5L6					
Q813	8-729-120-28	TRANSISTOR 2SC1623-L5L6					
Q814	8-729-120-28	TRANSISTOR 2SC1623-L5L6					
Q817	8-729-900-53	TRANSISTOR DTC114EK					
Q818	8-729-120-28	TRANSISTOR 2SC1623-L5L6					
<RESISTOR>							
R800	1-216-675-11	METAL CHIP	10K 0.50%				1/10W
R801	1-216-295-91	SHORT	0				
R802	1-216-025-91	RES,CHIP	100 5%				1/10W
R803	1-216-295-91	SHORT	0				
R804	1-216-295-91	SHORT	0				
R805	1-216-295-91	SHORT	0				
R807	1-216-295-91	SHORT	0				
R813	1-216-295-91	SHORT	0				
R820	1-216-073-00	RES,CHIP	10K 5%				1/10W
R821	1-216-083-00	RES,CHIP	27K 5%				1/10W
R822	1-216-025-91	RES,CHIP	100 5%				1/10W
R824	1-216-295-91	SHORT	0				
R825	1-216-295-91	SHORT	0				
R827	1-216-295-91	SHORT	0				
R828	1-216-025-91	RES,CHIP	100 5%				1/10W
R829	1-216-025-91	RES,CHIP	100 5%				1/10W
R830	1-216-295-91	SHORT	0				
R831	1-216-295-91	SHORT	0				
R832	1-216-659-11	METAL CHIP	2.2K 0.50%				1/10W
R835	1-216-295-91	SHORT	0				
R839	1-216-655-11	METAL CHIP	1.5K 0.50%				1/10W
R841	1-216-025-91	RES,CHIP	100 5%				1/10W
R842	1-216-065-91	RES,CHIP	4.7K 5%				1/10W
R843	1-216-065-91	RES,CHIP	4.7K 5%				1/10W
R844	1-216-057-00	RES,CHIP	2.2K 5%				1/10W

V1(KV-XF51M65 only)

VM1

REF. NO.	PART NO.	DESCRIPTION	REMARK	REF. NO.	PART NO.	DESCRIPTION	REMARK
R845	1-216-049-91	RES,CHIP	1K 5% 1/10W	C5910	1-130-471-00	MYLAR	0.001MF 5% 50V
R846	1-216-049-91	RES,CHIP	1K 5% 1/10W	C5911	1-107-949-11	ELECT	2.2MF 20% 160V
R847	1-216-049-91	RES,CHIP	1K 5% 1/10W	C5912	1-104-999-11	MYLAR	0.1MF 10% 200V
R848	1-216-049-91	RES,CHIP	1K 5% 1/10W	C5913	1-130-471-00	MYLAR	0.001MF 5% 50V
R849	1-216-049-91	RES,CHIP	1K 5% 1/10W	C5914	1-126-933-11	ELECT	100MF 20% 16V
R850	1-216-105-91	RES,CHIP	220K 5% 1/10W	C5916	1-130-491-00	MYLAR	0.047MF 5% 50V
R851	1-216-057-00	RES,CHIP	2.2K 5% 1/10W	C5917	1-126-925-11	ELECT	470MF 20% 10V
R853	1-216-067-00	RES,CHIP	5.6K 5% 1/10W	C5918	1-115-341-51	CERAMIC	120PF 10% 500V
R857	1-216-081-00	RES,CHIP	22K 5% 1/10W	C5920	1-126-964-11	ELECT	10MF 20% 50V
R858	1-216-067-00	RES,CHIP	5.6K 5% 1/10W	C5921	1-101-888-00	CERAMIC	68PF 5% 50V
R861	1-216-049-91	RES,CHIP	1K 5% 1/10W			<CONNECTOR>	
R862	1-260-095-11	CARBON	470 5% 1/2W	CN5901*	1-564-510-11	PLUG, CONNECTOR 7P	
R863	1-216-049-91	RES,CHIP	1K 5% 1/10W	CN5904*	1-770-723-11	CONNECTOR, BOARD TO BOARD 8P	
R864	1-216-041-00	RES,CHIP	470 5% 1/10W			<DIODE>	
R866	1-215-880-00	METAL OXIDE	10 5% 2W F	D5901	8-719-911-19	DIODE ISS119-25	
R871	1-216-037-00	RES,CHIP	330 5% 1/10W	D5902	8-719-110-88	DIODE RD39ESB2	
R879	1-216-073-00	RES,CHIP	10K 5% 1/10W	D5903	8-719-911-19	DIODE ISS119-25	
R880	1-216-041-00	RES,CHIP	470 5% 1/10W	D5904	8-719-110-88	DIODE RD39ESB2	
R882	1-216-049-91	RES,CHIP	1K 5% 1/10W	D5905	8-719-911-19	DIODE ISS119-25	
R884	1-216-025-91	RES,CHIP	100 5% 1/10W	D5906	1-249-406-11	CARBON	120 5% 1/4W
R888	1-216-065-91	RES,CHIP	4.7K 5% 1/10W	D5907	1-249-406-11	CARBON	120 5% 1/4W
R889	1-216-073-00	RES,CHIP	10K 5% 1/10W			<COIL>	
R890	1-216-081-00	RES,CHIP	22K 5% 1/10W	L5901	1-414-187-11	INDUCTOR	47UH
R894	1-216-073-00	RES,CHIP	10K 5% 1/10W	L5902	1-414-856-11	INDUCTOR	10UH
R895	1-216-065-91	RES,CHIP	4.7K 5% 1/10W			<TRANSISTOR>	
R896	1-216-073-00	RES,CHIP	10K 5% 1/10W	Q5901	8-729-230-45	TRANSISTOR 2SC2458-YGR	
R897	1-216-073-00	RES,CHIP	10K 5% 1/10W	Q5902	8-729-017-05	TRANSISTOR 2SA1837	
R898	1-216-065-91	RES,CHIP	4.7K 5% 1/10W	Q5903	8-729-230-45	TRANSISTOR 2SC2458-YGR	
		<CRYSTAL>		Q5904	8-729-119-76	TRANSISTOR 2SA1175-HFE	
X801	1-578-774-11	VIBRATOR, CRYSTAL		Q5905	8-729-230-45	TRANSISTOR 2SC2458-YGR	
				Q5906	8-729-017-06	TRANSISTOR 2SC4793	
				Q5908	8-729-119-78	TRANSISTOR 2SC2785-HFE	
				Q5909	8-729-119-78	TRANSISTOR 2SC2785-HFE	
						<RESISTOR>	
				R5901	1-247-815-91	CARBON	220 5% 1/4W
				R5902	1-249-414-11	CARBON	560 5% 1/4W F
				R5903	1-247-735-11	CARBON	47 5% 1/2W F
				R5904	1-249-411-11	CARBON	330 5% 1/4W
				R5905	1-249-417-11	CARBON	1K 5% 1/4W
				R5906	1-249-417-11	CARBON	1K 5% 1/4W
				R5907	1-249-417-11	CARBON	1K 5% 1/4W
				R5908	1-249-383-11	CARBON	1.5 5% 1/4W F
				R5909	1-247-815-91	CARBON	220 5% 1/4W
				R5910	1-249-403-11	CARBON	68 5% 1/4W
C5902	1-104-661-91	ELECT	330MF 20% 16V			<CAPACITOR>	
C5903	1-161-830-00	CERAMIC	0.0047MF 500V				
C5905	1-126-925-11	ELECT	470MF 20% 10V				
C5906	1-130-491-00	MYLAR	0.047MF 5% 50V				
C5907	1-107-638-11	ELECT	33MF 20% 160V				
C5908	1-106-383-00	MYLAR	0.047MF 10% 200V				
C5909	1-126-933-11	ELECT	100MF 20% 16V				

**KV-HF51P50/XF21M80/XF21M83/XF21N90/XF51M65**

RM-952 RM-952 RM-952 RM-915 RM-952

The components identified by shading and mark  $\Delta$  are critical for safety. Replace only with part number specified.



REF. NO.	PART NO.	DESCRIPTION	REMARK
R5911	1-249-439-11	CARBON 68K 5%	1/4W
R5912	1-249-437-11	CARBON 47K 5%	1/4W
R5914	1-249-403-11	CARBON 68 5%	1/4W
R5915	1-249-429-11	CARBON 10K 5%	1/4W
R5916	1-249-419-11	CARBON 1.5K 5%	1/4W
R5917	1-249-416-11	CARBON 820 5%	1/4W
R5918	1-249-429-11	CARBON 10K 5%	1/4W
R5919	1-249-417-11	CARBON 1K 5%	1/4W F
R5920	1-249-439-11	CARBON 68K 5%	1/4W
R5921	1-215-912-11	METAL OXIDE 150 5%	3W F
R5922	1-249-414-11	CARBON 560 5%	1/4W
R5923	1-249-383-11	CARBON 1.5 5%	1/4W F
R5925	1-249-401-11	CARBON 47 5%	1/4W F
R5929	1-215-880-00	METAL OXIDE 10 5%	2W F
R5930	1-249-413-11	CARBON 470 5%	1/4W
R5931	1-249-413-11	CARBON 470 5%	1/4W
R5932	1-249-413-11	CARBON 470 5%	1/4W
R5933	1-249-413-11	CARBON 470 5%	1/4W
R5934	1-249-430-11	CARBON 12K 5%	1/4W
R5935	1-249-429-11	CARBON 10K 5%	1/4W

\*\*\*\*\*

MISCELLANEOUS  
\*\*\*\*\*

$\Delta$ 1-416-946-11	COIL, DEMAGNETIC (EXCEPT KV-XF21N90)
$\Delta$ 1-416-946-31	COIL, DEMAGNETIC (KV-XF21N90)
1-452-032-00	MAGNET, DISC
1-452-094-00	CIRCULAR DISC MAGNET B
1-452-728-61	COIL, NA ROTATION (RT-154)
1-503-902-11	SPEAKER (15X6.5CM) (KV-HF51P50)
1-505-937-21	SPEAKER (10CM) (KV-XF21M83/XF51M65 ONLY)
1-529-125-11	SPEAKER (13X7CM) (EXCEPT KV-HF51P50)
$\Delta$ 1-574-062-22	CORD, POWER (WITH CONNECTOR) 2.5A/250V (KV-XF21M80(E/ME))
$\Delta$ 1-574-062-52	CORD, POWER (WITH CONNECTOR) 2.5A/250V (KV-HF51P50/XF51M65)
$\Delta$ 1-575-023-11	CORD, POWER (WITH CONNECTOR) 6A/250V (KV-XF21N90)
$\Delta$ 1-782-173-11	CORD, POWER (WITH CONNECTOR) 2.5A/250V (KV-XF21M80(VIETNAM)/XF21M83)
8-451-505-11	DEFLECTION YOKE (Y21RSA-S)
8-453-011-31	NA299-S2
$\Delta$ 8-738-809-05	PICTURE TUBE (A51LPT70X) (KV-XF21M80(E/ME)/XF21N90)
$\Delta$ 8-738-812-05	PICTURE TUBE (A51LPT70X) (KV-HF51P50/XF21M80(VIETNAM)/XF21M83/XF51M65)

\*\*\*\*\*

ACCESSORIES AND PACKING MATERIALS (KV-HF51P50)  
\*\*\*\*\*

REF. NO.	PART NO.	DESCRIPTION	REMARK
	1-417-151-21	MATCHING TRANSFORMER, ANTENNA	
	1-501-372-81	ANTENNA, TELESCOPIC	
	3-701-910-00	SCREW, SPECIAL (DIA. 3.8X20)	
	3-867-177-11	MANUAL, INSTRUCTION	
*	4-055-210-21	BAG, PROTECTION	
*	4-070-980-01	CUSHION (LOWER)(ASS'Y)	
*	4-070-981-01	CUSHION (UPPER)(ASS'Y)	
*	4-070-986-01	INDIVIDUAL CARTON	
	4-070-990-11	LABEL, CARTON	
	4-392-003-41	BAND, HOLD	
	4-392-004-11	CLIP	

\*\*\*\*\*

ACCESSORIES AND PACKING MATERIALS (KV-XF21M80(E/ME))  
\*\*\*\*\* 1

1-417-151-21	MATCHING TRANSFORMER, ANTENNA
1-501-372-81	ANTENNA, TELESCOPIC
1-569-008-21	ADAPTOR, CONVERSION 2P
3-701-910-00	SCREW, SPECIAL (DIA. 3.8X20)
3-866-882-21	MANUAL, INSTRUCTION (KV-XF21M80(ME))
3-866-882-31	MANUAL, INSTRUCTION (KV-XF21M80(E))
* 4-053-003-01	BAG, PROTECTION
* 4-067-168-01	INDIVIDUAL CARTON
* 4-070-796-01	CUSHION (UPPER)(ASS'Y)
* 4-070-797-01	CUSHION (LOWER)(ASS'Y)
4-392-003-31	BAND, HOLD
4-392-004-21	CLIP

\*\*\*\*\*

ACCESSORIES AND PACKING MATERIALS (KV-XF21M80(VIETNAM)/XF21M83/XF21N90)  
\*\*\*\*\*

1-417-151-21	MATCHING TRANSFORMER, ANTENNA (KV-XF21M80(VIETNAM) ONLY)
1-501-730-41	ANTENNA, TELESCOPIC (KV-XF21M80(VIETNAM) ONLY)
3-701-910-00	SCREW, SPECIAL (DIA. 3.8X20)
3-865-541-41	MANUAL, INSTRUCTION (KV-XF21N90)
3-867-918-11	MANUAL, INSTRUCTION (KV-XF21M80(VIETNAM)/XF21M83)
* 4-039-372-01	BAG, PROTECTION (KV-XF21N90)
* 4-062-162-11	BAG, PROTECTION (KV-XF21M80(VIETNAM)/XF21M83)
* 4-067-169-01	CUSHION (UPPER)(ASS'Y) (KV-XF21N90)
* 4-067-170-01	CUSHION (LOWER)(ASS'Y) (KV-XF21N90)
* 4-070-538-01	CUSHION (LOWER)(ASS'Y) (KV-XF21M80(VIETNAM)/XF21M83)
* 4-070-539-01	CUSHION (UPPER)(ASS'Y) (KV-XF21M80(VIETNAM)/XF21M83)
* 4-070-537-01	INDIVIDUAL CARTON (KV-XF21M80(VIETNAM)/XF21M83)

<u>REF. NO.</u>	<u>PART NO.</u>	<u>DESCRIPTION</u>	<u>REMARK</u>	<u>REF. NO.</u>	<u>PART NO.</u>	<u>DESCRIPTION</u>	<u>REMARK</u>
	* 4-071-006-01	INDIVIDUAL CARTON (KV-XF21N90)					
	4-392-003-11	BAND, HOLD					
	4-392-004-11	CLIP					
*****							
ACCESSORIES AND PACKING MATERIALS (KV-XF51M65)							
*****							
	3-701-910-00	SCREW, SPECIAL (DIA. 3.8X20)					
	3-867-181-11	MANUAL, INSTRUCTION					
	* 4-055-210-21	BAG, PROTECTION					
	4-070-990-11	LABEL, CARTON					
	* 4-070-993-01	INDIVIDUAL CARTON					
	* 4-070-994-01	CUSHION (LOWER)(ASS'Y)					
	* 4-070-995-01	CUSHION (UPPER)(ASS'Y)					
	4-392-003-41	BAND, HOLD					
	4-392-004-31	CLIP					
*****							
REMOTE COMMANDER							
*****							
	1-418-163-11	REMOTE COMMANDER (RM-952) (EXCEPT KV-XF21N90)					
	1-418-417-11	REMOTE COMMANDER (RM-915) (KV-XF21N90)					
	9-939-697-01	BATTERY COVER, REMOTE COMMANDER					



**KV-HF51P50/XF21M80/XF21M83/XF21N90/XF51M65**

RM-952

RM-952

RM-952

RM-915

RM-952

**9-965-744-01**

**Sony Corporation**  
**SONY TV Industries (M) Sdn. Bhd.**  
**TV Business of General Area**

**English**  
**99EG70193-1**  
**Printed in Malaysia**  
**© 1999. 5**

## Free Manuals Download Website

<http://myh66.com>

<http://usermanuals.us>

<http://www.somanuals.com>

<http://www.4manuals.cc>

<http://www.manual-lib.com>

<http://www.404manual.com>

<http://www.luxmanual.com>

<http://aubethermostatmanual.com>

Golf course search by state

<http://golfingnear.com>

Email search by domain

<http://emailbydomain.com>

Auto manuals search

<http://auto.somanuals.com>

TV manuals search

<http://tv.somanuals.com>