

# ***Trinitron Color TV***

---

## Operating Instructions

- Before operating the unit, please read this manual thoroughly and retain it for future reference.

**FD Trinitron**  
**WEGA**



***KV-HR36***  
***KV-HR32***

# WARNING

- Dangerously high voltages are present inside the TV.
- TV operating voltage: 220–240 V AC.
- Do not plug in the power cord until you have completed making all other connections; otherwise a minimum leakage current might flow through the antenna and other terminals to ground.
- To avoid battery leakage and damage to the remote, remove the batteries from the remote if you are not going to use it for several days. If any liquid leaks from the batteries and touches your skin, immediately wash it away with water.

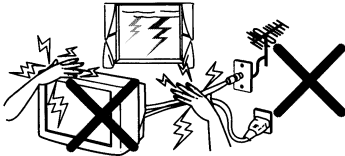

For your own safety, do not touch any part of the TV, the power cord and the antenna cable during lightning storms.

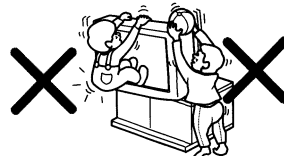

For children's safety, do not leave children alone with the TV. Do not allow children to climb onto it.

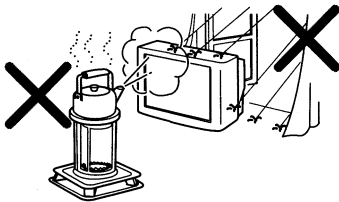

To prevent fire or shock hazard, do not expose the TV to rain or moisture.

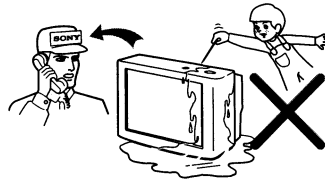

Do not operate the TV if any liquid or solid object falls into it. Have it checked immediately by qualified personnel only.

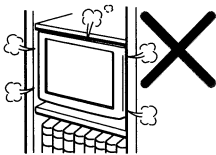

Do not block the ventilation openings of the TV. Do not install the TV in a confined space, such as a bookcase or built-in cabinet.

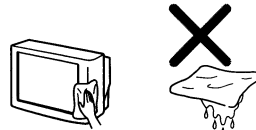

Clean the TV with a dry and soft cloth. Do not use benzene, thinner, or any other chemicals to clean the TV. Do not attach anything (e.g., adhesive tape, cellophane tape, glue) on the painted cabinet of the TV. Do not scratch the picture tube.

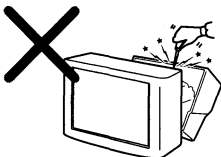

Do not open the cabinet and the rear cover of the TV as high voltages and other hazards are present inside the TV. Refer servicing and disposal of the TV to qualified personnel.

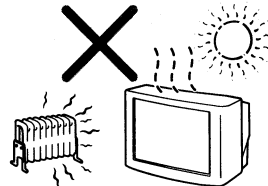

Your TV is recommended for home use only. Do not use the TV in any vehicle or where it may be subject to excessive dust, heat, moisture or vibrations.

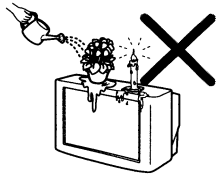

Do not place any objects on the TV. The apparatus shall not be exposed to dripping or splashing and that no objects filled with liquids, such as vases, shall be placed on the apparatus.

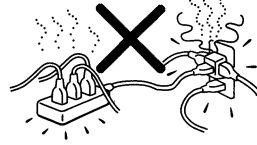

Do not plug in too many appliances to the same power socket. Do not damage the power cord.

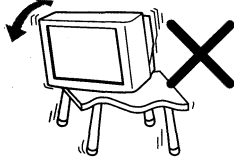

Install the TV on a stable TV stand and floor which can support the TV set weight. Ensure that the TV stand surface is flat and its area is larger than the bottom area of the TV.



Pull the power cord out by the plug. Do not pull the power cord itself. Even if your TV is turned off, it is still connected to the AC power source (mains) as long as the power cord is plugged in. Unplug the TV before moving it or if you are not going to use it for several days.

## About the glazed finish on the top and side panels of your TV

The top and side panels of your TV are glaze finished.

To keep them from discoloring, deterioration or scratching:

- Avoid hitting your TV with an object.
- Do not put a hot object such as a cup of coffee, or heavy object such as a flower vase with water, on the TV top. If any liquid fall into the cabinet, it may cause fire or shock hazard.

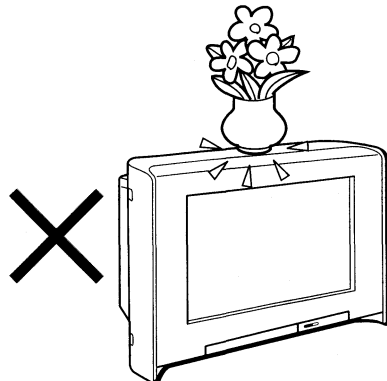
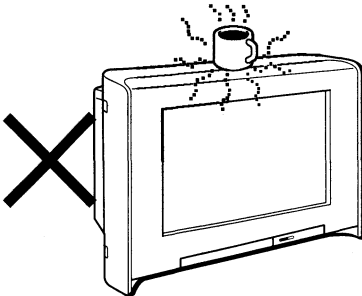

***The features you will enjoy include:***

- “DRC-MF” for viewing higher quality pictures (page 21)
- “TWIN” for viewing two programs (page 28)
- “PROGRAM INDEX” for displaying multiple programs (page 31)
- “Picture Mode” / “Sound Mode” / “Surround” for customizing your TV (pages 20 and 33)
- “Wide Screen” to enjoy wide mode pictures (page 24)
- “MEMORY STICK” button on the remote control for viewing still pictures and movies stored in a “Memory Stick”(page 42)

***Your TV also offers the following features:***

- Initial Setup function for on-screen language selection, picture position adjustment and automatic channel presetting. (page 9)
- Menu language options — English/Chinese/ Arabic (page 84)
- “Program Block” for locking out specific channels (page 93)
- “Intelligent Volume” for automatic volume adjustment (page 78)
- “Fine” tuning feature (page 89)
- Button Joystick  on the remote control for easier operation (page 73)
- “Eco Mode” to save energy (page 85)
- “Game Mode” for video games (page 85)

# Table of Contents

## WARNING

### Using Your New TV

Getting Started .....	6
Step 1 Secure the TV .....	6
Step 2 Connect the antenna .....	7
Step 3 Insert the batteries into the remote.....	8
Step 4 Set up your TV automatically .....	9
Connecting optional components .....	11
Watching the TV .....	17

### Advanced Operations

Selecting the picture and sound modes .....	20
Viewing higher quality pictures .....	21
Customizing the picture Reality and Clarity levels .....	22
Using wide screen mode .....	24
Watching two programs at the same time .....	28
Displaying multiple programs .....	31
Listening with surround sound .....	33
Enjoying stereo or bilingual programs .....	34
Viewing Teletext .....	36
Operating optional components .....	38
Using the TV's center speaker .....	41
Using the "Memory Stick" viewer ..	42

### Adjusting Your Setup (MENU)

Introducing the menu system .....	70
Changing the "Picture" setting .....	74
Changing the "Sound" setting .....	77
Entering the "Memory Stick" menu .....	80
Changing the "Wide Screen" setting .....	81
Operating the "Multi Picture" using the menu .....	83
Changing the "Setup" setting .....	84

### Additional Information

Troubleshooting .....	96
Self-diagnosis function.....	102
Identifying parts and controls .....	103
Specifications .....	Back cover

# Getting Started

## Step 1

### Secure the TV

To prevent the TV from falling, use the supplied screws, clamps and band to secure the TV.

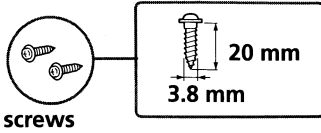

screws



clamps

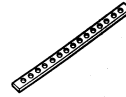

band

Screw the band to the TV stand and to the provided hole at the rear of your TV.

or

- (1) Put a cord or chain through the clamps.
- (2) Screw one clamp to a wall or pillar and the other clamp to the provided hole at the rear of your TV.

or

- (1) Attach each end of a cord or chain to the provided holders at the rear of your TV.
- (2) Securely fix the attached cord or chain to a wall or pillar using an attachment which can support the TV set weight.

**Note**

- Use only the supplied screws. Use of other screws may damage the TV.

## Step 2

### Connect the antenna

If you wish to connect a VCR, see the "Connect a VCR" diagram on page 8.

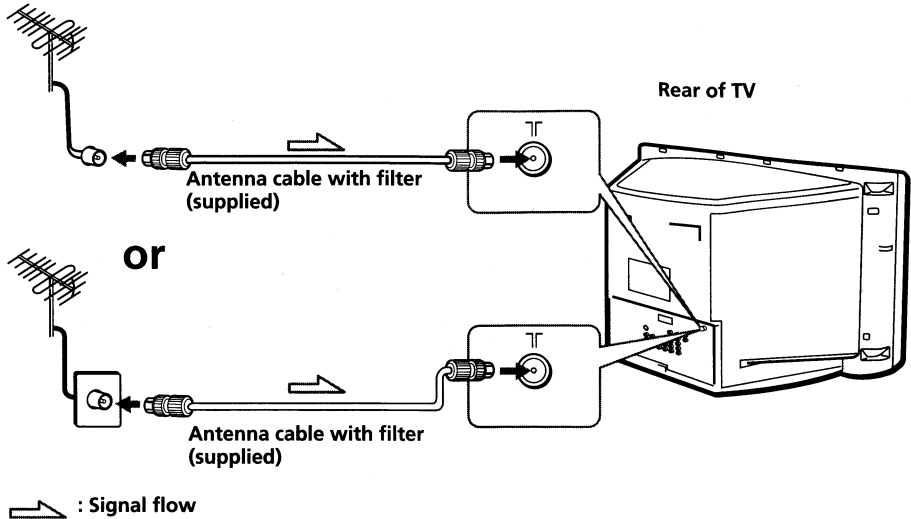

### For optimum Performance

To connect the TV to the antenna or the VCR, use the supplied antenna cable with filter.

Note that one end of the cable has a male plug fitted while the other end is fitted with a female socket. Connect the male plug to the T (antenna) terminal of the TV.

### CAUTION

Do not connect the power cord until all other connections are complete; otherwise, a minimal current leakage through the antenna and/or other terminals to the ground could occur.



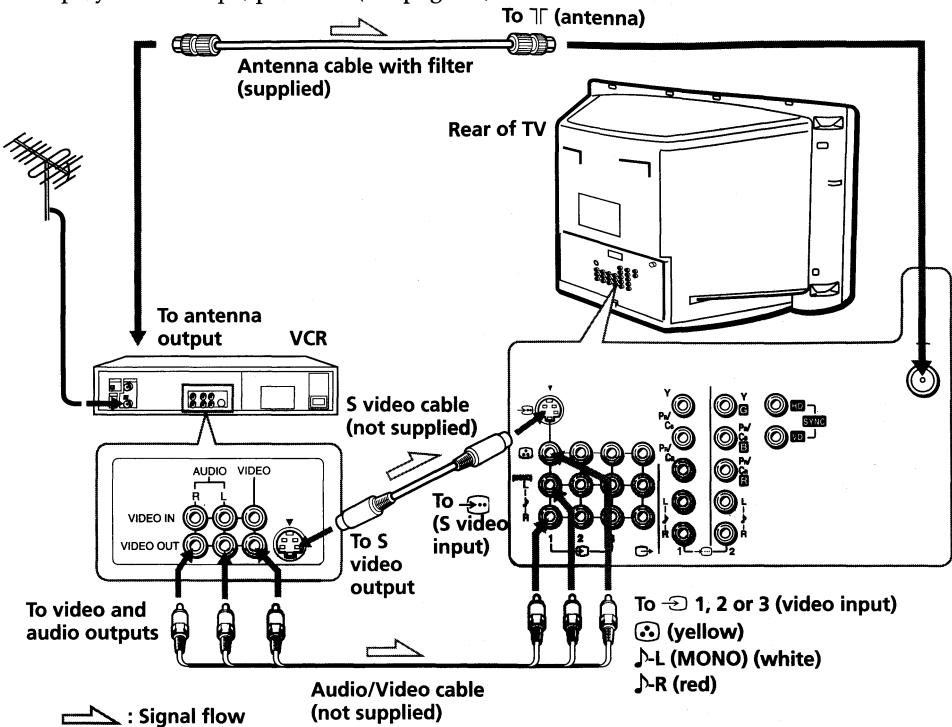

## Getting Started (continued)

### Connect a VCR

To play a video tape, press  (see page 18).



#### Notes

- If you connect a monaural VCR, connect the yellow plug to  (the yellow jack) and the black plug to  $\curvearrowright$ -L (MONO) (the white jack).
- If you connect a VCR to the  $\Upsilon$  (antenna) terminal, preset the signal output from the VCR to the program number 0 on the TV.
- When you connect a VCR to the S video input, display the "Setup" menu and select "Auto" for "S Input" (see page 86). If the signals are input to both  (S video input) and  (video input), the S video signal is automatically selected. To view the video signal input to  (video input), select "Off" for "S Input".

## Step 3

### Insert the batteries into the remote

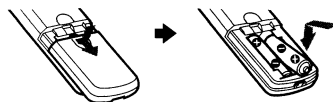

#### Note

- Do not use old batteries or different types of batteries together.



# Step 4

## Set up your TV automatically

When you first turned on the TV, the "Picture Rotation" and "Picture V-Position" menus will appear in the process of "Initial Setup". These menus allow you to adjust the inclination of picture, shift of the picture vertical position, and color patches caused by the earth's magnetic field. (These phenomena do not indicate the TV's problem.) Adjust "Picture Rotation" and "Picture V-Position" appropriately.

**Tip**

- When you install the TV to another location, make sure to adjust "Picture Rotation" and "Picture V-Position" using the menu (see page 87).

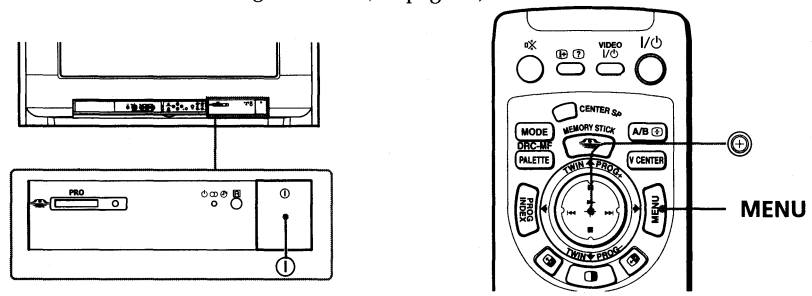

**1 Press 1 to turn on the TV.**

The "Initial Setup" menu appears, and you can select the on-screen language.



**2 Move + up or down to select the desired language, then press +.**

"Start auto program now?" appears.

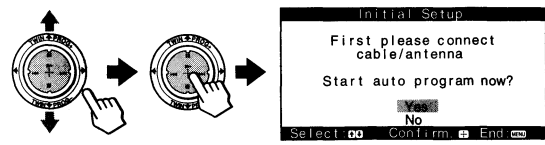

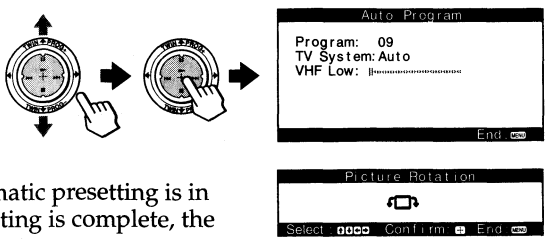

**3 Move + up or down to select "Yes", then press + to preset the channels automatically.**

The screen will indicate automatic presetting is in progress. After channel presetting is complete, the "Picture Rotation" menu appears.





continued

## Getting Started (continued)

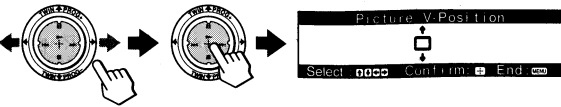
- 4** If the upper and lower bars are slanted, move  left or right so that they become horizontal, then press .



"Picture V-Position" menu appears.

- 5** If the upper and lower bars are not equally positioned to the top and bottom of the screen, move  up or down to adjust them, then press .

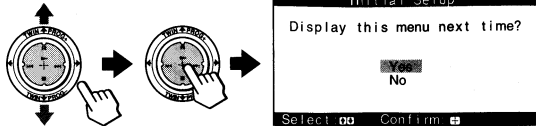

"Display this menu next time?" appears.

- 6** Move  up or down to select "No", then press .

The "Initial Setup" menu will not appear again the next time you turn on the TV by pressing .

To allow this menu to appear again, select "Yes", then press .

### Tips

- You can immediately go to the end of the "Initial Setup" menu by pressing MENU.
- If your TV has preset an unwanted channel or cannot preset a particular channel, then preset your TV manually (see page 88).

### Notes

- Before adjusting "Picture Rotation" and "Picture V-Position", keep external speakers or other electrical equipment away from the TV. The magnetic disturbance from these equipment or the direction of the earth's magnetic field may affect the TV.
- If you do not succeed in adjusting "Picture Rotation" and "Picture V-Position", turn off the TV and change its location or direction, then try to adjust using the menu. Do not move the TV while the TV is turned on. If you do, abnormal color patches may appear on the picture. Press  on the TV to turn off the TV for about 15 minutes, then turn it on again to demagnetize the TV.
- When adjusting "Picture Rotation", adjust the value step by step. If you rotate the bars largely at a time, color distortion may occur.
- You cannot adjust "Picture Rotation" and "Picture V-Position" when HD signals are input or "Memory Stick" mode is selected.



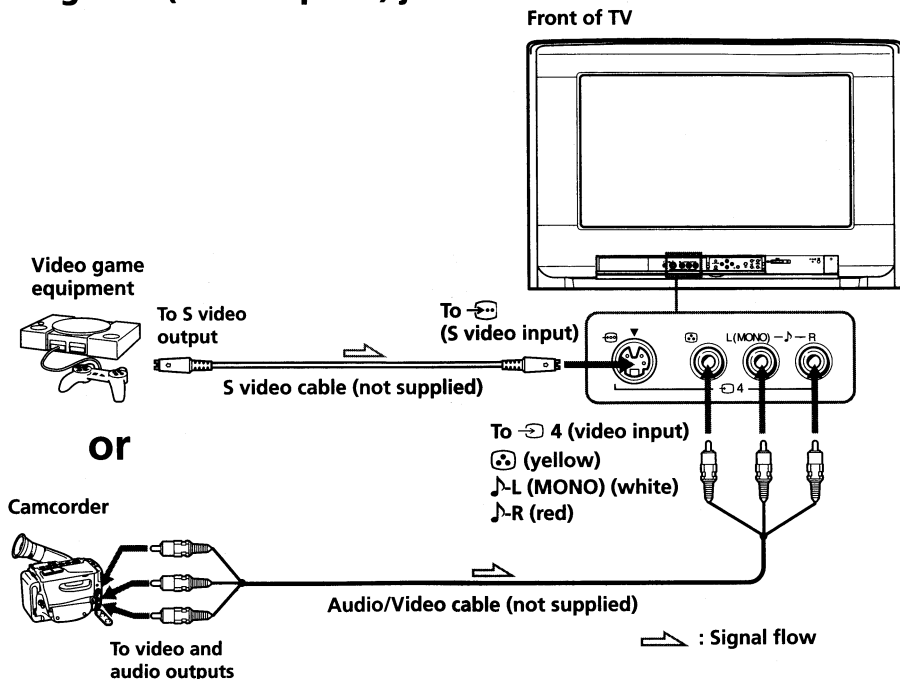

# Connecting optional components

You can connect optional audio/video components, such as a VCR, a DTV (Digital Television) receiver, multi disc player, camcorder, video game, or stereo system. To watch and operate the connected equipment, see pages 18 and 38.

## Connecting a camcorder/video game equipment using 4 (video input 4) jacks



### Notes

- When connecting video game equipment, display the "Setup" menu and select "On" for "Game Mode" to adjust the picture setting that is suitable for video games (see page 85).
- You can also connect video equipment to the  1, 2, or 3 (video input) jacks at the rear of your TV.
- When you connect video equipment to the S video input, display the "Setup" menu and select "Auto" for "S Input" (see page 86). If the signals are input to both  (S video input) and  (video input), the S video signal is automatically selected. To view the video signal input to  (video input), select "Off" for "S Input".

**continued**

## Connecting optional components (continued)

### Connecting audio/video equipment using the (monitor output) jacks

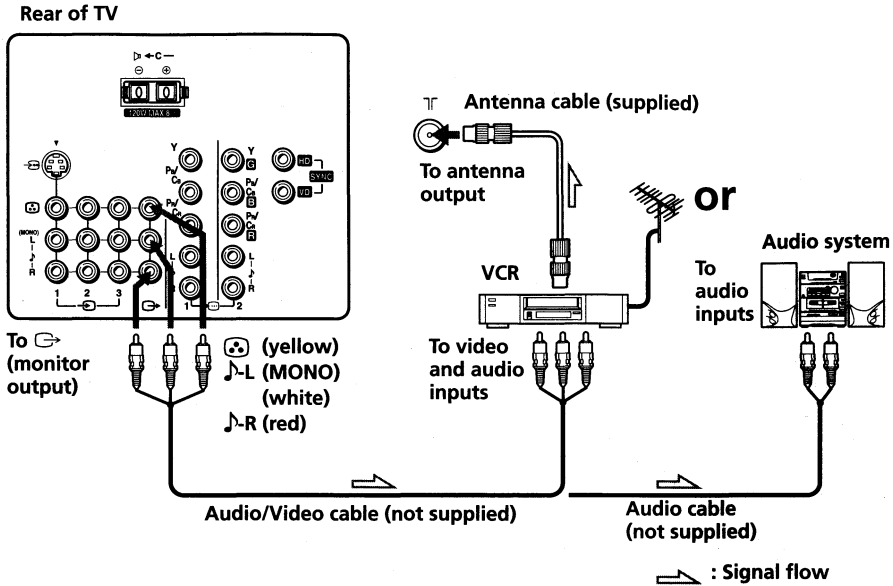

#### Note

- If you select "HD/DVD 1" or "HD/DVD 2" on your TV screen (see page 18), sound will be heard but no picture will be output from  (monitor output). This does not indicate a malfunction.

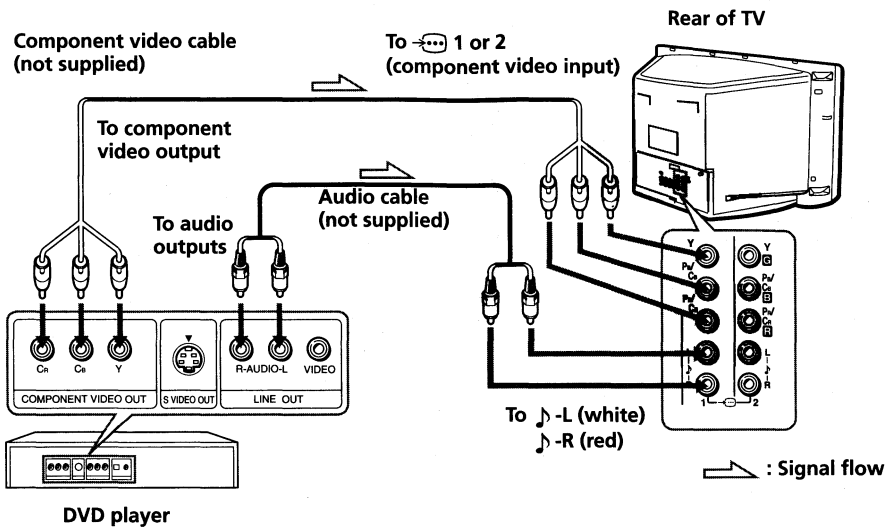

# Connecting a DVD player to (component video input) 1 or 2 jacks



## Notes

- Some DVD player terminals may be labeled differently:

Connect	To (on the DVD player)
Y (green)	Y
PB/Cb (blue)	Cb, B-Y or Pb
Pr/CR (red)	Cr, R-Y or Pr

- Connect nothing to the HD/VD jacks when connecting a DVD player to  1 or 2 (component video input).
- If you select "HD/DVD 1" or "HD/DVD 2" on your TV screen (see page 18), sound will be heard but no picture will be output from  (monitor output). This does not indicate a malfunction.
- When receiving a progressive signal through  (component video input), TWIN pictures and PROGRAM INDEX features are not available, and "DRC-MF", "DRC Palette" and "Game Mode" are not selectable.

continued

## Connecting optional components (continued)

### Connecting a DVD player to (video input) 1, 2 or 3 jacks

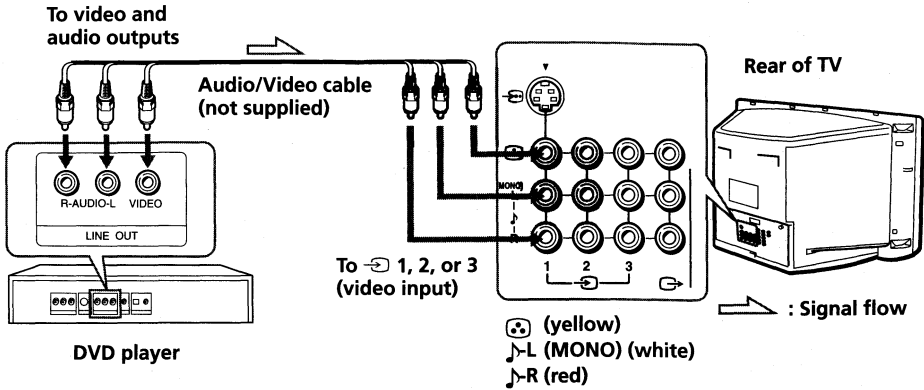

#### Notes

- Since the high quality pictures on a DVD disc contain a lot of information, picture noise may appear. In this case, display the "Picture" menu and select "Personal" for "Picture Mode", then adjust the sharpness ("Sharpness") under "Picture Adjustment" (see page 76).
- You can also connect a DVD player to  (S video input) on the TV.

## Connecting a DTV (digital television) receiver to 1 or 2 (component video input) jacks

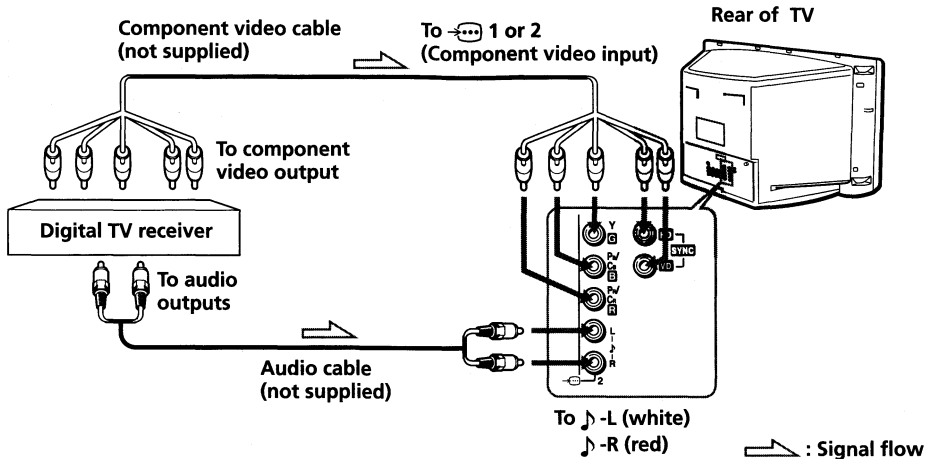

### Note

- The TV is equipped with the G/B/R/HD/VD inputs.  
If your DTV receiver is equipped with the Y/P<sub>B</sub>/P<sub>R</sub> output connectors, connect it to the Y/P<sub>B</sub>/P<sub>R</sub> connectors of 1 or 2. Connect nothing to the HD/VD connectors of 2.
- If your DTV receiver is not equipped with the Y/P<sub>B</sub>/P<sub>R</sub> output connectors, connect it to the G/B/R/HD/VD connectors of 2.

### Tip

- The TV accepts the following signal formats:

Total scanning line	Effective scanning line	fV (Hz)
1125i	1080i	50/60
750p	720p	50/60
625p	576p	50
625i	576i	50
525p	480p	60
525i	480i	60

continued





# Watching the TV

This section explains various functions and operations used while watching the TV. Most operations can be done using the remote.

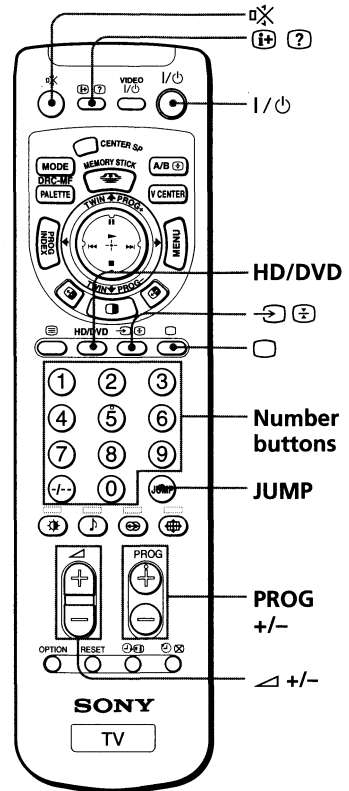
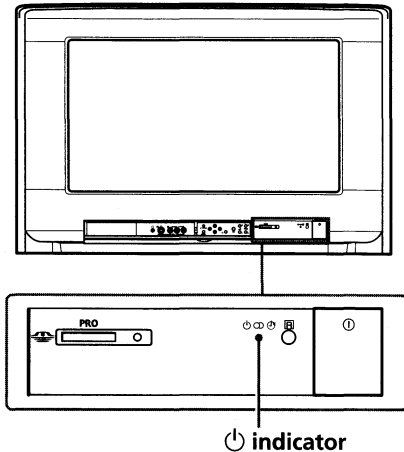

## 1 Press ① to turn on the TV.

When the TV is in standby mode (the indicator on the TV is lit red), press on the remote.



## 2 Press PROG +/- or the number buttons to select the TV channel.

For double digit numbers, press then the number (e.g., for 25, press , then 2 and 5).

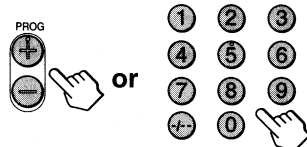

### Note

- When you turn on the TV, either the program number or video mode is displayed for approximately 40 seconds. The Eco Mode () icon will also appear if "Eco Mode" in the "Setup" menu is set to "On" (see page 85).

**continued**

## Watching the TV (continued)

### To select a TV program quickly

- 1 Press and hold PROG +/-.
- 2 Release PROG +/- when the desired program number appears.

#### Note

- When you select a TV program quickly, the picture may be disrupted. This does not indicate a malfunction.

### Additional tasks

To	Press
Turn off temporarily	I/⏻. The ⏻ indicator on the TV lights up red.
Turn off completely	⏻ on the TV.
Adjust the volume	◀ +/-.
Mute the sound	⊘.
Watch the video input (VCR, camcorder, etc.)	↵ (or ↵ on the TV) to select "VIDEO 1", "VIDEO 2", "VIDEO 3", "VIDEO 4", "HD/DVD 1" or "HD/DVD 2". To return to the TV screen, press □ (or ↵ on the TV).
Watch the component input (DVD, DTV receiver)	HD/DVD to select "HD/DVD 1" or "HD/DVD 2". To return to the TV screen, press □ (or ↵ on the TV).
Jump back to the previous channel	JUMP.
Display the on-screen information*	ⓘ.

- \* Some picture/sound settings, and either the program number or video mode are displayed. The on-screen display for the picture/sound settings disappears after about 3 seconds.

## Setting the Wake Up timer

- 1 Press until the desired period of time appears.

The Wake Up timer starts immediately after you have set it.

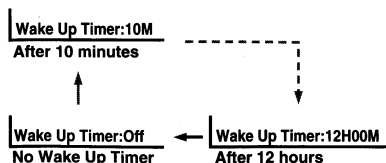

- 2 Select the TV channel or video mode you want to wake up to.
- 3 Press , or set the Sleep timer if you want the TV to turn off automatically. The indicator on the TV lights up orange.

### To cancel the Wake Up timer

Press until “Wake Up Timer: Off” appears, or press on the TV to turn it off.

#### Note

- If no buttons or controls are pressed for more than two hours after the TV is turned on using the Wake Up timer, the TV automatically goes into standby mode. To resume watching the TV, press any button on the TV or the remote.

## Setting the Sleep timer

Press until the desired period of time appears.

You can select the period of time from among 15, 30, 45, 60, 75 and 90 minutes.

The Sleep timer starts immediately after you have set it.

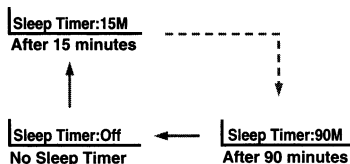

### To cancel the Sleep timer

Press until “Sleep Timer: Off” appears, or turn the TV off.

## Selecting the picture and sound modes

You can select picture and sound modes and adjust the setting to your preference in the "Personal" option.

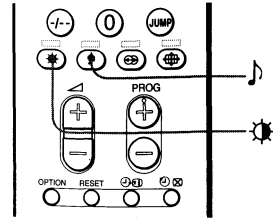

### Selecting the picture mode

Press  repeatedly until the desired picture mode is selected.

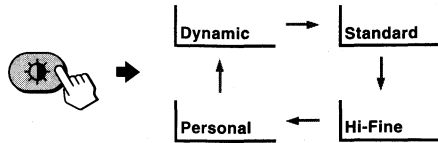

Select	To
"Dynamic"	receive high contrast pictures.
"Standard"	receive normal pictures.
"Hi-Fine"	receive higher resolution pictures with mild contrast.
"Personal"	receive the last adjusted picture setting from the "Picture Adjustment" menu under the "Picture" menu (see page 76).

### Selecting the sound mode

Press  repeatedly until the desired sound mode is selected.

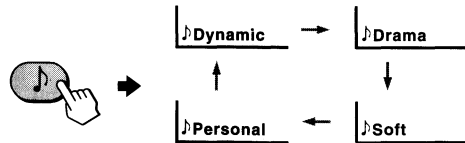

Select	To
"Dynamic"	listen to dynamic and clear sound that emphasizes both the low and high tones.
"Drama"	listen to sound that emphasizes voice and high tones.
"Soft"	receive soft sound.
"Personal"	receive the last adjusted sound setting from the "Sound Adjustment" menu under the "Sound" menu (see page 79).

#### Tip

- You can also set the picture and sound modes using the menu (see "Changing the "Picture" setting" on page 74 and "Changing the "Sound" setting" on page 77).



# Customizing the picture Reality and Clarity levels

## — “DRC-MF PALETTE”

The DRC-MF PALETTE feature allows you to customize the level of detail (Reality) and smoothness (Clarity) for various input sources. For example, you can create one Custom setting to optimize your antenna input’s picture, and create another to optimize your DVD player’s picture. You can create up to three Custom settings for each of the antenna input’s signal, the signals input to video 1 to 4 inputs, and the component input signal separately, and each for the “Dynamic” and “Standard/Hi-Fine/Personal” picture modes, separately (max. 18 settings).

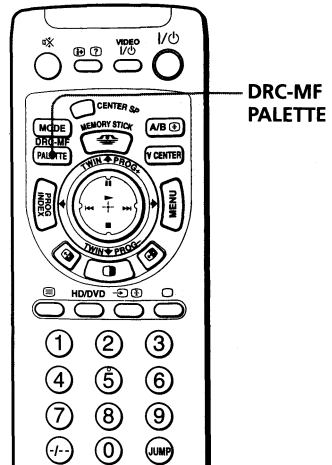

- 1 Press DRC-MF PALETTE repeatedly to select “Custom 1”, “Custom 2” or “Custom 3” to which you want to create the setting.

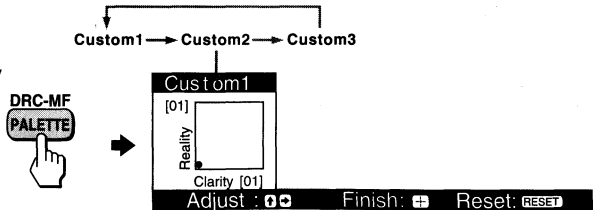

- 2 Move  up, down, right or left to adjust the position of the marker “•”.

As you move “•” higher along the “Reality” axis, the picture becomes more detailed.

As you move “•” to the right, along the “Clarity” axis, the picture becomes smoother.

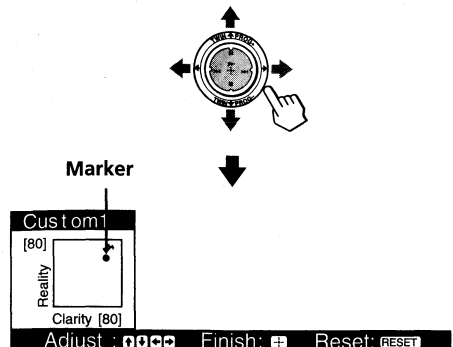

- 
- 3** Press  to return to the normal screen.



---

### To switch to the last adjusted Custom setting

Display the picture and press DRC-MF PALETTE repeatedly to select your desired Custom setting.

### To reset to the factory preset values

Press RESET on the remote.

**Note**

- The DRC-MF PALETTE is not selectable when using the PROGRAM INDEX feature, or when the "Game Mode" or "Twin" mode is turned "On". The mode is not available for HD (high-definition) or progressive input signal, or the picture recorded on a "Memory Stick".

# Using wide screen mode

The wide screen mode feature allows you to watch the picture filling the 16:9 screen of the TV.

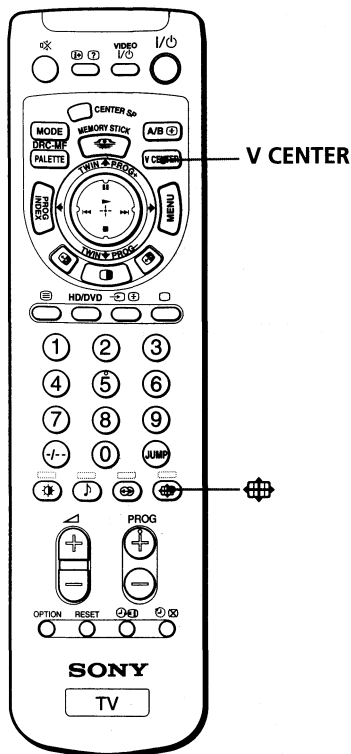

## Watching the picture in wide screen mode automatically — AUTO WIDE

The TV automatically selects optimum wide screen mode according to the signal input and displays the picture to fill the 16:9 screen.

### Notes

- The AUTO WIDE feature may not work correctly depending on the quality of signal. In this case, select the wide screen mode manually using the  button (see page 26).
- The examples in the table on page 25 show the settings preset at the factory; "Auto Wide" is set to "On" and "4:3 Default" is set to "Wide Zoom" in the "Wide Screen" menu (see page 81).



When receiving ...	AUTO WIDE functions to select ...	The picture changes to ...
normal 4:3 aspect ratio picture with an ID-1 or S1 signal or a signal without ID-1.	Wide Zoom* →	enlarge the 4:3 picture, with the upper and lower parts condensed to fit the 16:9 screen.
4:3 letter box movie or a video or DVD with an ID-1 signal.	Zoom →	enlarge the picture horizontally and vertically in an equal aspect ratio that fills the 16:9 screen**.
4:3 squeezed video camera picture with an ID-1 or S1 signal.	Full →	enlarge the picture horizontally only, to fill the 16:9 screen.
HDTV 16:9 picture	Full →	An HDTV 16:9 picture is always displayed in "Full" mode.

\* When a normal 4:3 picture is received, "Wide Zoom" mode is automatically selected with the factory setting. You can display that picture as it is without enlarging it ("Normal" mode) if you set "4:3 Default" in the "Wide Screen" menu to "Normal" (see page 81).

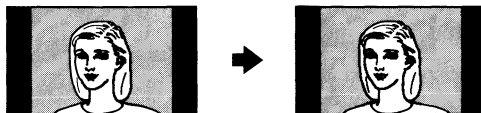

\*\* Black bands may appear on the top and bottom of the screen.

**Note**

- The 720p/1080i format signal is always displayed in "Full" mode even if it has no ID-1 signal.

**continued**

## Using wide screen mode (continued)

### Watching the picture in wide screen mode manually



You can select the desired wide screen mode manually.

Press  repeatedly until the mode indication you want is displayed on the screen.

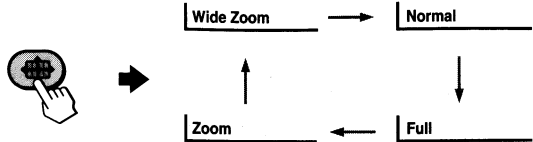
For details on each mode, see "Watching the picture in wide screen mode automatically".



#### Notes

- You can also select the wide screen mode manually using the menu (see page 81).
- When the wide screen mode is selected by pressing the  button on the remote or using the menu, the AUTO WIDE feature does not work temporarily.  
The AUTO WIDE feature functions again when:
  - you change a TV channel with PROG +/-.
  - you change the video input with .
  - the TV is turned off and on again.
- The 720p/1080i format signal (HDTV 16:9 picture) is always displayed in "Full" mode.
- You can adjust the vertical position of the picture when wide screen mode is set to "Wide Zoom" or "Zoom" (see page 27).

## Adjusting the position of the picture

You can adjust the vertical position of the picture when

- the upper or lower part of the picture cannot be seen in "Wide Zoom" mode.
- you want to adjust the vertical position of the picture in the screen for "Zoom" mode.

This feature is available only for "Wide Zoom" and "Zoom" modes.

**1** Press V CENTER.

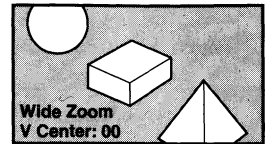

**2** Move  $\odot$  up or down to move the picture up or down.

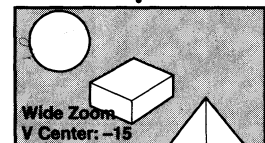
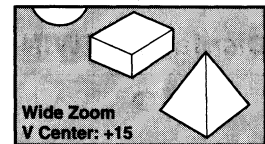
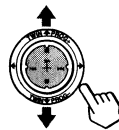

**3** Press  $\odot$ .



### Notes

- The adjusted V Center value remains stored even after the TV is turned off.
- You can also adjust the position of the picture in "Wide Zoom" and "Zoom" modes using the menu (see page 81).

# Watching two programs at the same time

## — "TWIN"

With the TWIN pictures feature, you can display a different TV program beside the main picture.

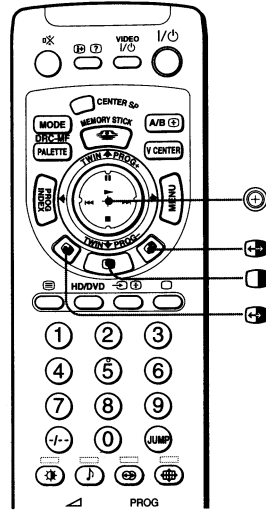

## Displaying TWIN pictures

Press .

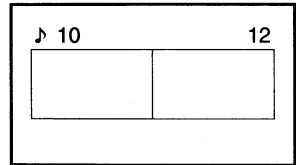

## To return to the normal screen

Press .

The left picture is displayed in full screen.

### Tip

- You can also display the Twin pictures using the menu (see "Operating the "Multi Picture" using the menu" on page 83).

## Additional tasks

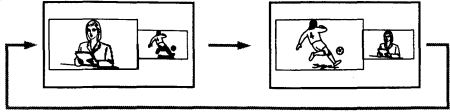
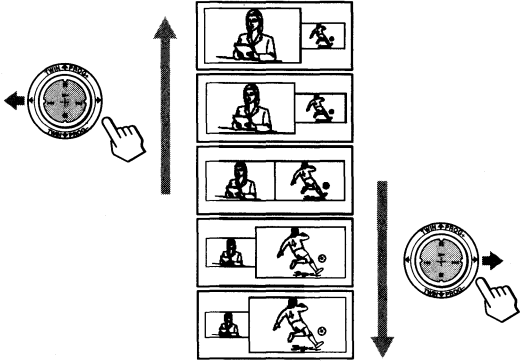
To	Press/Move
change a TV program in the right picture	Move <b>⊕</b> up or down (TWIN PROG + or -).
swap the left and right pictures	Press <b>↔</b> . 
swap sound between the left and right pictures.	Press <b>🎵</b> . The "🎵" symbol will appear to indicate which screen you are hearing.
change the screen size of the TWIN pictures	Move <b>⊕</b> left to increase the left screen size. Move <b>⊕</b> right to increase the right screen size. 

### Notes

- Swapping the pictures is not available for HD or DVD input signal.
- The TWIN pictures feature is not available for HD (high-definition) and progressive signals. If you change the left main picture to an HD or progressive signal, a message appears and the TWIN pictures feature is cancelled. The selected HD or progressive picture will be displayed in full screen.
- The TWIN pictures feature is not available when the TV is in the center speaker mode (page 41) and you cannot set the TV to the center speaker mode while viewing the TWIN pictures.
- You cannot enjoy stereo sound in the right picture.
- You cannot change the picture to a video input in the right picture. You can only display a video input, except for HD and progressive signals, in the right picture by swapping the pictures when a video input is displayed in the left picture.
- When the **□** button is pressed, the TV screen flickers or goes blank for about one second before the TWIN pictures appear. This does not indicate a malfunction of the TV.

**continued**

## Watching two programs at the same time — "TWIN" (continued)

### Selecting a TV program using PAP (Picture And Picture)

You can select your desired TV program directly from the right picture by using  (TWIN PROG +/-).

- 1 Move  up or down (TWIN PROG +/-).  
The two pictures of the same channel appear on the screen (PAP).

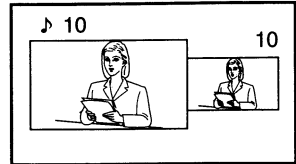
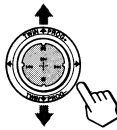

- 2 Move  up or down (TWIN PROG +/-) until the desired program appears on the right screen.

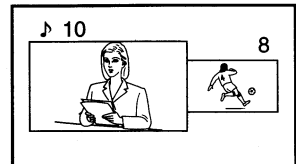
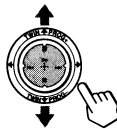

- 3 Press  to display the right picture in full screen.



### To change the left picture channel

Press PROG +/- or the number buttons.

### To return to the normal screen from the PAP mode

Press .

The left picture is displayed in full screen.

#### Notes

- You cannot change the picture size or swap the two pictures in the PAP mode. (You can swap the sounds of the two pictures.)
- The PAP feature is not available for HD (high-definition) and progressive signals. If you change the left main picture to an HD or progressive signal, a message appears and the PAP feature is cancelled. The selected HD or progressive picture will be displayed in full screen.

# Displaying multiple programs

## — "PROGRAM INDEX"

The PROGRAM INDEX feature displays all tuned TV programs scrolling on the screen for direct selection.

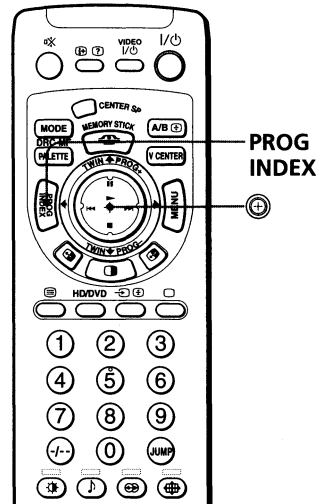

### 1 Press PROG INDEX.

The current program is reduced in size and displayed on the left. The first tuned program is briefly displayed on the bottom-right side of the screen, then frozen. It scrolls up and the next program appears on the bottom-right, and all tuned programs appear one by one.

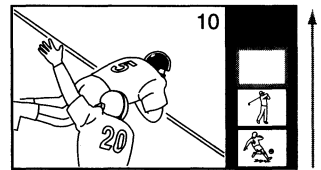

### 2 Move up or down so that the program you want to view is displayed in the frame, and press .

To return to scrolling, move  up or down again.

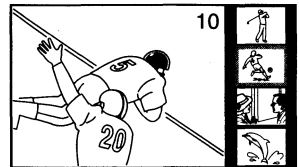
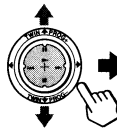

continued

## Displaying multiple programs — “PROGRAM INDEX” (continued)

- 3** Press  again to enlarge the selected program into the left frame.

The selected program is displayed in normal motion picture, and the sound also switches to this program.

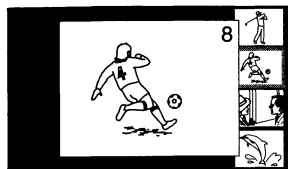

- 4** Press PROG INDEX.

The selected program is displayed in full screen.



### Tip

- To change the direction of scrolling, move  up or down once. To increase scrolling speed, hold  up or down.

### To return to the normal screen

Press PROG INDEX again, or:

- 1 Select “Program Index” from the “Multi Picture” menu.
- 2 Press .

### Tip

- You can also display multiple programs using the menu (see “Operating the “Multi Picture” using the menu” on page 83).

### Notes

- When displaying multiple programs, only the sound of the left screen is heard.
- The PROGRAM INDEX feature is not available for HD (high-definition) and progressive signals. The selected HD or progressive picture will be displayed in full screen.



# Listening with surround sound

The surround feature enables you to enjoy the sound effects of a concert hall or movie theater.

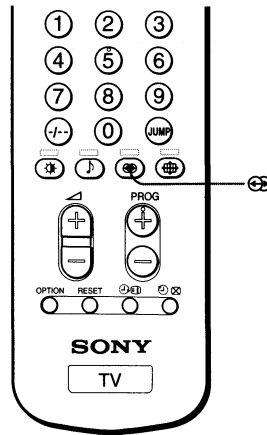

Press  repeatedly until you receive the desired surround sound.

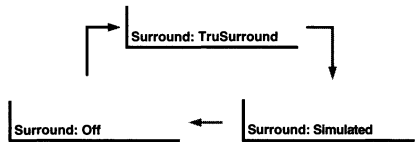

Select	To
"TruSurround"*	listen to the surround sound that spreads out to the rear of a room.
"Simulated"	listen to monaural sound with a stereo-like effect.
"Off"	turn off the surround sound.

\* TruSurround, SRS and the ® symbol are trademarks of SRS Labs, Inc. TruSurround technology is incorporated under license from SRS Labs, Inc.

### Note

- You cannot change the surround sound when the TV is in the center speaker mode (page 41).

# Enjoying stereo or bilingual programs

You can enjoy stereo sound or bilingual programs of NICAM and A2 (German) stereo systems.

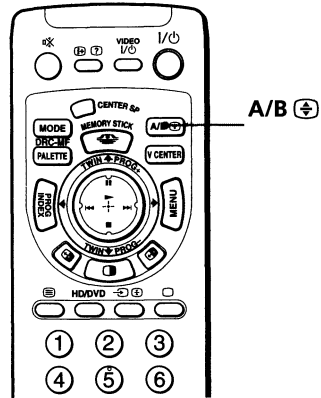

Press A/B repeatedly until you receive the sound you want.

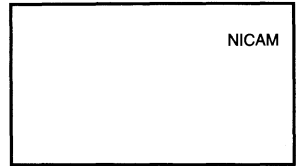

## When receiving a NICAM program

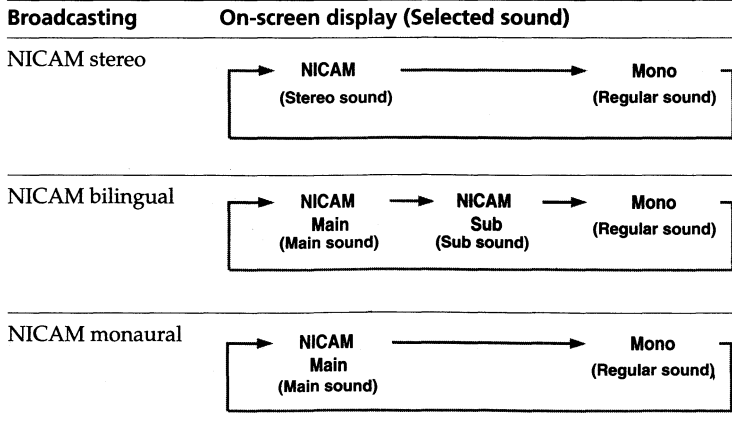

## When receiving an A2 (German) program

Broadcasting	On-screen display (Selected sound)
A2 (German) stereo	
A2 (German) bilingual	

## Receiving area for NICAM and A2 (German) programs

System	Receiving area
NICAM	Hong Kong, Singapore, New Zealand, Malaysia, Thailand, etc.
A2 (German)	Australia, Malaysia, Thailand, etc.

### Notes

- If the signal is very weak, the sound becomes monaural automatically.
- If the stereo sound is noisy when receiving a NICAM program, select "Mono". The sound becomes monaural, but the noise is reduced.
- Before receiving a NICAM stereo program in China, please check the NICAM broadcast condition at your area. When receiving a NICAM stereo program, the receiving conditions might vary depending on area. In addition, different strength of the NICAM broadcast signal might affect the receiving quality.

## If the sound is distorted or noisy when receiving a monaural program through the ㄗ (antenna) terminal

Press A/B repeatedly until "Mono" appears on the screen.

To cancel the monaural sound setting, press A/B again until "Auto" appears on the screen.

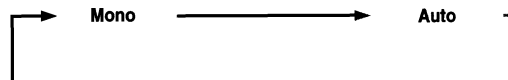

### Notes

- The "Mono" or "Auto" setting is memorized for each program position.
- You cannot receive a stereo broadcast signal when the TV is in the "Mono" setting. Normally, set the TV to "Auto".

# Viewing Teletext

Some TV stations broadcast an information service called Teletext which allows you to receive various information, such as stock market reports and news.

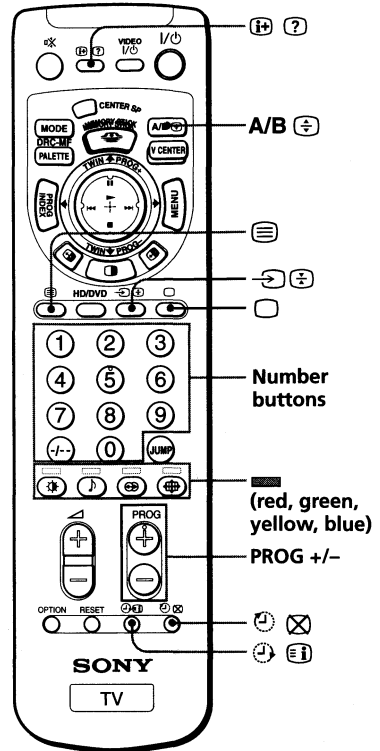

## Displaying Teletext

**1** Select a TV channel that carries the Teletext broadcast you want to watch.

**2** Press to display the text.

A Teletext page (normally the index page) is displayed. If there is no Teletext broadcast, "100" is displayed at the top left corner of the screen.















P100 SECTEXT 106 FR1 MAR 03:59:00

From Singapore	Day	Dep/Air	Flight	Aircraft
To PARIS	1 6	220/0588	SC26	747
	2	2130/1225	PA115	L15
To OSAKA	2	2115/1330	SG26	747
	4 6	0930/2015	CX522	L10
To ROMA	2 7	2130/0745	SG24	747
	4	2350/0915	AZ487	747
To SYDNEY	1	2210/0610	SG21A	747
	2	2150/0635	SG21A	747

## To turn off Teletext





Press .

## Additional Teletext tasks

To	Do this
display a Teletext page on the TV picture	Press  . Each time you press  , the screen changes as follows: Teletext → Teletext and TV → TV.
check the contents of a Teletext service	Press  . An overview of the Teletext contents, including page numbers, appears on the screen.
select a Teletext page	Press the number buttons to enter the three-digit page number of the desired Teletext page.* If you make a mistake, reenter the correct page number. To access the next or previous page, press PROG +/-.
hold (pause) a Teletext page (stop the page from scrolling)	Press  to display the symbol "  " at the top left corner of the screen. To resume normal Teletext viewing, press  or  .
reveal concealed information (e.g., an answer to a quiz)	Press  . To conceal the information, press the button again.
enlarge the Teletext display	Press  . Each time you press  , the Teletext display changes as follows: Enlarge upper half → Enlarge lower half → Normal size.
stand by for a Teletext page while watching a TV program	<ol style="list-style-type: none"> <li>1 Enter the Teletext page number that you want to refer to, then press .</li> <li>2 When the page number is displayed, press  to show the text.</li> </ol>

\* You can also select a Teletext page of any page number that appears in the colored column at the bottom of the screen using the corresponding color-coded button on the remote.

## Using FASTEXT

This feature allows you to quickly access a Teletext page that uses FASTEXT. When a FASTEXT program is broadcast, colored menus appear at the bottom of the screen. The color of each menu corresponds to the color-coded buttons on the remote (red , green , yellow , and blue ).

### To access a FASTEXT menu

Press the color-coded button on the remote corresponding to the menu you want. The menu page appears on the screen after a few seconds.

# Operating optional components

You can use the supplied remote to operate Sony video equipment such as Beta, 8 mm, VHS or DVD.

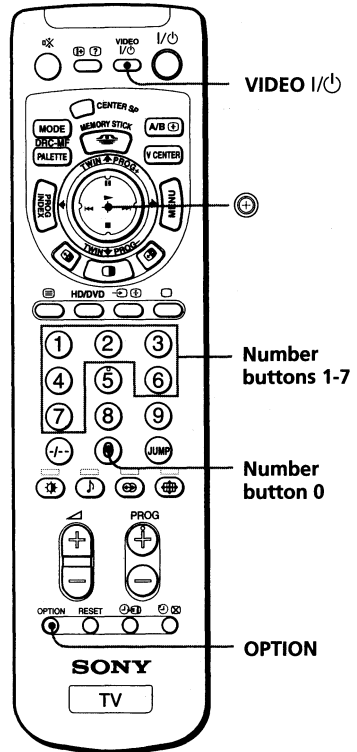

## Setting up the remote to work with other connected equipment

While keeping VIDEO I/⏻ pressed, press the number button 0, then the corresponding number button for the desired equipment (see the chart below).

For example, to operate a Sony 8 mm VCR:

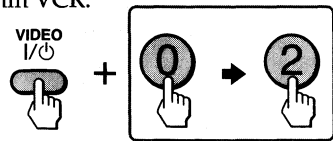

To control	While holding down	First press the number button	Next press the number button
DVD	VIDEO I/⏻	0	0
VTR1 (Beta)	VIDEO I/⏻	0	1
VTR2 (8 mm)	VIDEO I/⏻	0	2
VTR3 (VHS)	VIDEO I/⏻	0	3
MDP	VIDEO I/⏻	0	4
CD	VIDEO I/⏻	0	6
MD	VIDEO I/⏻	0	7

### Note

- If the equipment does not have a certain function, the corresponding button on the remote will not operate.

## Operating video equipment

Press VIDEO I/⏻, or while keeping OPTION pressed, press ⏪ (▶) or move ⏪ (▶) up (⏪), down (⏩), left (⏪) or right (⏩) (see the chart below).



## Operating a VCR using the remote

To	Press/Move
turn on/off	VIDEO I/⏻
play	▶ while keeping OPTION pressed.
stop	■ while keeping OPTION pressed.
fast forward (▶▶)	▶▶ while keeping OPTION pressed.
rewind the tape (◀◀)	◀◀ while keeping OPTION pressed.
pause	⏪ while keeping OPTION pressed. Press again to resume normal playback.
search the picture forward (▶▶) or backward (◀◀)	▶▶ or ◀◀ during playback while keeping OPTION pressed. Release to resume normal playback.

## Operating a DVD player using the remote

To	Press/Move
turn on/off	VIDEO I/⏻
play	▶ while keeping OPTION pressed.
stop	■ while keeping OPTION pressed.
pause	⏪ while keeping OPTION pressed. Press again to resume normal playback.
step through different tracks of an audio disc	▶▶ to step forward or ◀◀ to step backward while keeping OPTION pressed.

continued

---

## Operating optional components (continued)

### Operating an MDP using the remote

To	Press/Move
turn on/off	VIDEO I/⏻
play	▶ while keeping OPTION pressed.
stop	■ while keeping OPTION pressed.
pause	⏸ while keeping OPTION pressed. Press again to resume normal playback.
search the picture forward or backward	▶▶ or ◀◀ during playback while keeping OPTION pressed. Release to resume normal playback.

### Operating a CD or MD player using the remote

To	Press/Move
turn on/off	VIDEO I/⏻
play	▶ while keeping OPTION pressed.
stop	■ while keeping OPTION pressed.
pause	⏸ while keeping OPTION pressed. Press again to resume normal playback.
step through different tracks	▶▶ to step forward or ◀◀ to step backward while keeping OPTION pressed.



# Using the TV's center speaker

You can use the TV's speakers as the center speaker of your audio system and control its sound volume from the remote of the TV.

## Notes

- For the speaker connection, see "Connecting an amplifier" on page 16.
- You cannot switch to the center speaker mode while viewing the TWIN pictures.

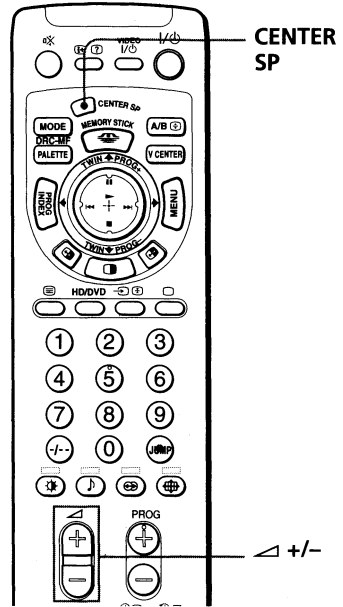

## To switch to the center speaker mode

- 1 Press CENTER SP.



- 2 Press  $\triangle$  +/- to adjust the volume of the sound from the TV's center speaker.



CENTER IN Speaker  
 $\triangle$  |||||..... 50

## To return to the normal speaker mode

Press CENTER SP again.

### Tip

- The center speaker mode is automatically cancelled when you select the video input or the "Memory Stick" viewer, or turn the TV off and on again. It is not cancelled, however, when using the PROGRAM INDEX feature.

### Notes

- If "CENTER IN" is selected for "Speaker" in the "Sound" menu and nothing is connected to the center speaker input terminals on the rear of the TV, no sound is heard from the TV's speakers.
- No sound is heard from the TV's center speakers if the sound source emitted from the amplifier does not contain the center speaker channel.
- When the TV is in the center speaker mode, you cannot use the TWIN pictures feature or change the surround sound or the "BBE" mode.

---

# Using the "Memory Stick" viewer

## About "Memory Stick"

"Memory Stick" (sold separately) is a new, compact, portable, and versatile Integrated Circuit recording medium with a data capacity that exceeds that of a floppy disk. "Memory Stick" is specially designed for exchanging and sharing digital data among "Memory Stick" compatible products such as digital cameras and digital video cameras. Because it is removable, "Memory Stick" can also be used for external data storage.

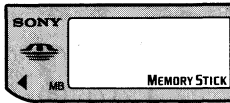

The "Memory Stick" viewer on your TV allows you to view still images (JPEG\* files) and movies (MPEG1\*\* files) stored on "Memory Stick" media.

For more information on using "Memory Stick" media, see "Notes on using "Memory Stick", "Memory Stick PRO" media" on page 44 and "Notes on Memory Stick Duo" on page 45.

"Memory Stick", "Memory Stick PRO", "Memory Stick Duo" and "  " are registered trademarks of Sony Corporation.

### Notes

- The data loading speed may differ depending on the "Memory Stick".
- When you view a picture stored on "Memory Stick" media, the sound is not output from the TV's speakers. Do not attempt to adjust the volume.
- A "Memory Stick" formatted by a computer may not be used with this TV.

## File Compatibility

The "Memory Stick" viewer can display still images and movies that are stored on "Memory Stick" media using the following compression format:

- JPEG\* files (DCF compliant\*) with an extension, .jpg
- MPEG1\*\* files, MPEG MOVIE, MPEG MOVIE AD, MPEG MOVIE EX, MPEG MOVIE HQ, MPEG MOVIE HQX, MPEG MOVIE CV, VAIO Giga Pocket MPEG1.
- Images with more than 16 horizontal and/or vertical dots per line
- Images with less than 4096 horizontal and/or vertical dots per line

Example: Still images recorded with a Sony digital still camera  
Folder name: /DCIM/101MSDCF  
File name: DSC00001.JPG

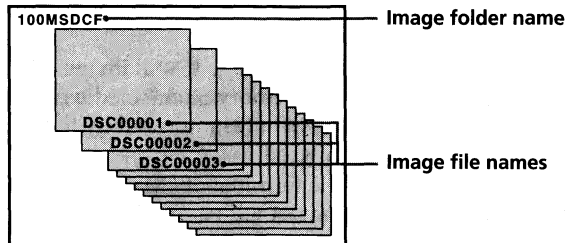

Example: Movie files recorded with a Sony digital still camera  
Folder name: /MSSONY/MOML0001  
File name: MOV00001.MPG

#### Note

- The TV's "Memory Stick" viewer cannot display still images and movies stored in TIFF or any other non-JPEG or non-MPEG1 compression format.
- \* JPEG stands for "Joint Photographic Experts Group," which is the organization that implemented this format. DCF stands for "Design Rules for Camera File Systems," which are specifications established by the Japan Electronic Industry Development Association (JEIDA).
- \*\* MPEG1 stands for "Motion Picture Experts Group" which is the organization that implemented this format and is the typical compression format for movie files.

## To prevent accidental erasure of still images and movies

Set the "Memory Stick" erasure prevention switch to "LOCK".

In this position, you cannot rotate the images. (See page 55.)

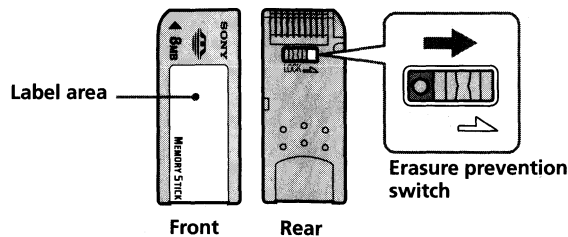

#### Tip

- When you set the erasure prevention switch on a "Memory Stick Duo", use a sharp object such as a ballpoint pen.

**continued**

## Using the "Memory Stick" viewer (continued)

### Notes on using "Memory Stick," "Memory Stick PRO" media

When using "Memory Stick," "Memory Stick PRO" media, follow these precautions:

- To avoid permanent damage to still image data, do not turn off the TV or remove "Memory Stick" media from the insertion slot while data is being read (as indicated by the "Memory Stick" indicator light being on).
- Avoid touching the terminal of "Memory Stick" media or bringing it into contact with a metal object.
- Do not drop, bend, or submit "Memory Stick" media to external shock.
- Do not disassemble or modify "Memory Stick" media.
- Avoid getting liquid on "Memory Stick" media.
- Apply labels only within the designated label area.

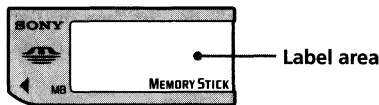

- To avoid permanent damage to still image data, do not use or store "Memory Stick" media in a location subject to:
  - High temperature (such as near a heater or inside a hot car)
  - High humidity
  - Direct sunlight
  - Corrosive substances
  - Magnetic fields
  - Excessive dust
  - Static electricity or electric noise
  - Electric surges
- Store and carry "Memory Stick" media in its original case to ensure protection of stored data.
- Save a backup of stored data.

---

## Notes on “Memory Stick Duo”

“Memory Stick Duo” is a new, compact version of the standardized “Memory Stick” recording medium. You can use a “Memory Stick Duo” on your TV by inserting a “Memory Stick Duo” into an adapter before inserting it into the TV.

- Be sure to attach a “Memory Stick Duo” to the adapter with the correct orientation.
- Be sure to insert the “Memory Stick Duo” adapter into the “Memory Stick” slot with the correct orientation. Otherwise, the TV may be damaged.
- Do not insert the “Memory Stick Duo” adapter without the “Memory Stick Duo” attached. Doing so may result in malfunction of the TV.

**continued**

## Using the "Memory Stick" viewer (continued)

### Inserting and removing a "Memory Stick"

#### To insert a "Memory Stick"

Locate the "Memory Stick" slot (see page 103) and insert the "Memory Stick" into the "Memory Stick" slot as illustrated.

Insert the "Memory Stick" media with the ▲ symbol upward.

When inserted properly, it should slide in with little resistance and click into place. The "Memory Stick" indicator flashes and goes off.

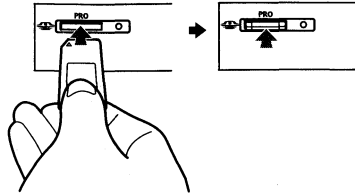

#### Notes

- Be sure to insert the "Memory Stick" in the correct direction. If the "Memory Stick" is forced in the wrong way, it may become damaged.
- Insert only "Memory Stick" media into the "Memory Stick" slot. Attempting to insert other objects into the slot may damage the TV.

#### To remove a "Memory Stick"

**1** Check that the "Memory Stick" indicator is off. (When the light is on, this indicates that the TV is reading data from the "Memory Stick".)

**2** Push the "Memory Stick" gently into the slot, and then release it. The "Memory Stick" media is ejected.

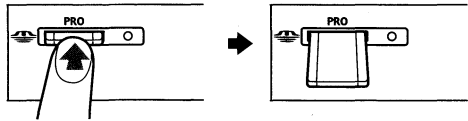

**3** Pull the "Memory Stick" completely out of the slot.

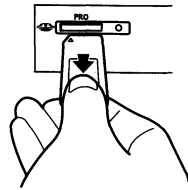

#### Tip

- When removing the "Memory Stick", do not attempt to just pull it from its slot.

#### Note

- To protect small children from injury from "Memory Stick" media, remove all "Memory Stick" media from the TV's "Memory Stick" slot and store it in a safe location when it is not in use.

## Displaying thumbnails of still images and movie files

You can view up to 20 still images and movies on the "Memory Stick" index.

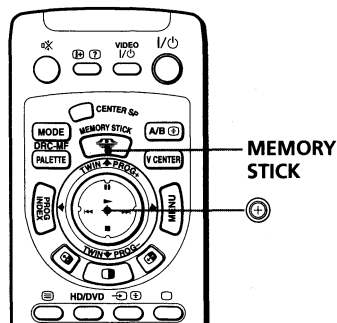

- 1 Insert a "Memory Stick" into the "Memory Stick" slot of the TV.  
For details on inserting a "Memory Stick", see page 46.

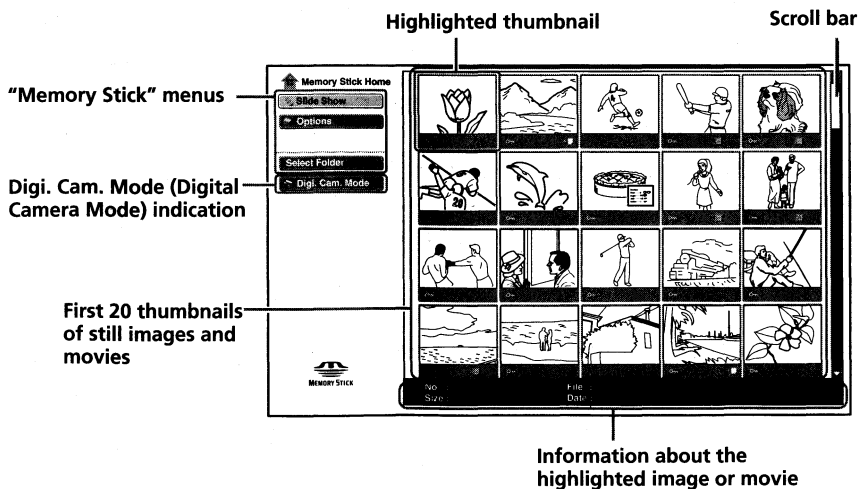

- 2 Press MEMORY STICK.  
The "Memory Stick Home" appears, which displays thumbnails of still image and movie files stored on the "Memory Stick".



continued

## Using the "Memory Stick" viewer (continued)

### When there are more than 20 still images and movies

Move  right to elect the scroll bar at the right end of the "Memory Stick Home", then move  down to display the next 20 thumbnails.

### About the "Digi. Cam. Mode" (Digital Camera Mode)

"Digi. Cam. Mode" displays all JPEG and MPEG1 files recorded with the DCF compliant digital cameras. When you set the "Digi. Cam. Mode" to "Off", only the selected files or all the files with the extension .jpg and .mpg can be displayed. The "Memory Stick" viewer of this TV sets "Digi. Cam. Mode" to "On" at the factory. To set "Digi. Cam. Mode" to "Off", see page 66.

Digi. Cam. Mode	Viewable images
"On"	Still images in DCF compliant JPEG files recorded on a Sony digital still camera or digital video camera recorder Movies in MPEG1 files recorded on a Sony digital still camera or digital video camera.
"Off"	JPEG still pictures and MPEG1 movies in the folder whose name has been changed by a computer



#### Notes

- When "Digi. Cam. Mode" is "On", you cannot set "Sort" and "Filter" in the "Options" menu (pages 68 and 69).
- When "Digi. Cam. Mode" is set to "On", the maximum 2000 pieces of still images and/or movies can be displayed. When you want to display more than 2000 pictures, set "Digi. Cam. Mode" to "Off".

### To view still images and movies that have been arranged and saved as in a computer

You need to select the folder. To select the folder, set "Digi. Cam. Mode" to "Off".

### About the icons on the thumbnail images





 (Movie)	Indicates the thumbnail is a movie (MPEG1) file.
 (Protect)	Indicates the thumbnail is protected. Protected files cannot be changed or deleted. For details, see "Protecting still images and movies" on page 61.
 (Relative file)	Indicates another file named the same in the last four digits exists in the "Memory Stick" but is not displayed. (appears only when the Digi. Cam. Mode is "On".)



### Notes

- The Relative file icon is added with the first file of those in the same file format (JPEG, MPEG1, and others) and having the file name with the same last 4-digits.
- If you delete the file with the Relative file icon, the other related files are all deleted at the same time.

## About caution displays

	This image data is the JPEG or MPEG1 format that is not compatible.
	There is the thumbnail but it is not DCF compliant.
	There is the image data but the thumbnail is broken.
	The image data is broken.

## To return to the normal screen

Press the number buttons or PROG +/-.

### Tip

- When you press PROG +/-, the last selected channel appears.

**continued**

## Using the "Memory Stick" viewer (continued)

### Viewing still images and movies in sequence — Slide Show

You can view the still images and movies stored on a "Memory Stick" with a specified interval.

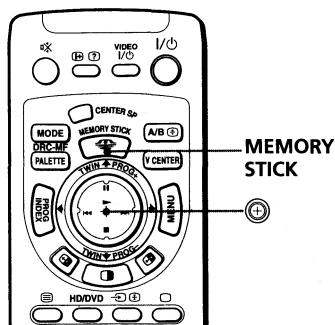



---

**1** Insert a "Memory Stick" into the "Memory Stick" slot of the TV.  
For details on inserting a "Memory Stick", see page 46.



---

**2** Press MEMORY STICK to display the "Memory Stick Home".

---

**3** Move  up or down to select "Slide Show", then press .  
The "Slide Show" menu appears.

---

**4** Move  up or down to select "Start", then press .  
Still images and movies are displayed according to the setting.  
A movie is played automatically. At the end of the movie, the next image appears.

---

#### Tip

- You can start the Slide Show even when a still image or movie is selected.

#### Note

- The still images and movies do not change automatically if "Advance" is in the "Slide Show" menu is set to "Manual".

## To exit the "Slide Show"

Press **⏏** on the remote.

## To change still images and movies in "Slide Show" manually

- 1 Press MEMORY STICK to display the "Memory Stick Home".
- 2 Move **⬆** up or down to select "Slide Show", then press **⏏**.  
The "Slide Show" menu appears.
- 3 Move **⬆** up or down to select "Advance", then press **⏏**.
- 4 Move **⬆** up or down to select "Manual", then press **⏏**.
- 5 Move **⬆** up or down to select "Start", then press **⏏**.

If you move **⬆** right, the next still image or movie appears; if you move **⬆** left, the previous still image or movie appears.

## To change the slide advance interval

You can select a time interval with which still images or movies change, from among "5 sec", "10 sec", "30 sec", "1 min", "5 min" and "10 min". The factory setting is "5 sec".

The interval can be changed when "Advance" in the "Slide Show" menu is set to "Auto".

- 1 Press MEMORY STICK to display the "Memory Stick Home".
- 2 Move **⬆** up or down to select "Slide Show", then press **⏏**.  
The "Slide Show" menu appears.
- 3 Move **⬆** up or down to select "Interval", then press **⏏**.
- 4 Move **⬆** up or down to select the interval you want to set, then press **⏏**.
- 5 Move **⬆** up or down to select "Start", then press **⏏**.  
The "Slide Show" starts.

## To start the "Slide Show" from the specified still image or movie

- 1 Press MEMORY STICK to display the "Memory Stick Home".
- 2 Move **⬆** up or down to select the still image or movie from which you want to start the "Slide Show", then press **⏏**.  
The "Memory Stick Home" (index menu) appears.
- 3 Move **⬆** up or down to select "Slide Show", then press **⏏**.

**continued**

---

## Using the “Memory Stick” viewer (continued)

### Notes

- The “Movie Player” (page 57) cannot be displayed when “Advance” is set to “Auto”.
- You cannot specify the interval when “Advance” is set to “Manual”.
- When “Advance” is set to “Auto”, a movie file is played to the end regardless of the specified interval. When playback is finished, the next image file is displayed.
- The “Interval” setting does not show the exact time, because the time required for displaying an image depends on its file size.

## Viewing a still image on the full screen

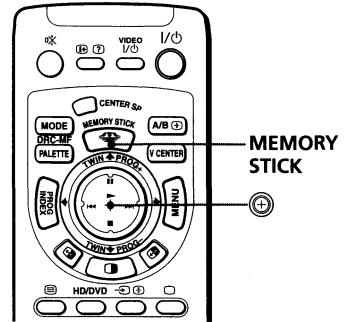

**1** Insert a "Memory Stick" into the "Memory Stick" slot of the TV.  
For details on inserting a "Memory Stick", see page 46.

**2** Press MEMORY STICK to display the "Memory Stick Home".

**3** Move up/down/right/left to select the still image you want to view, then press .

The still image index menu appears.

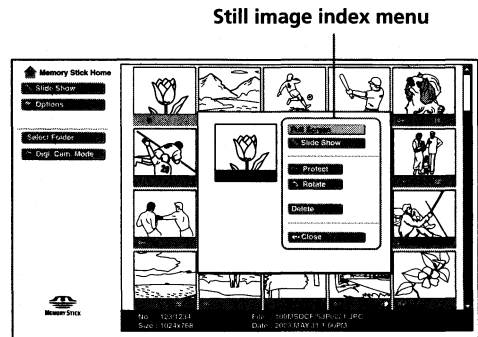

**4** Move up or down to select "Full Screen", then press .

The selected still image is displayed on the full screen.

To go to the previous or next still image, move left or right.

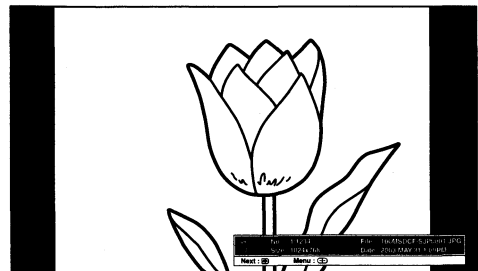

continued

## Using the "Memory Stick" viewer (continued)

### 5 Press $\odot$ .

The image setup menu appears.

To display another still image that is not the previous or next image, move  $\odot$  up to select "Return", then press  $\odot$ . The "Memory Stick Home" appears.

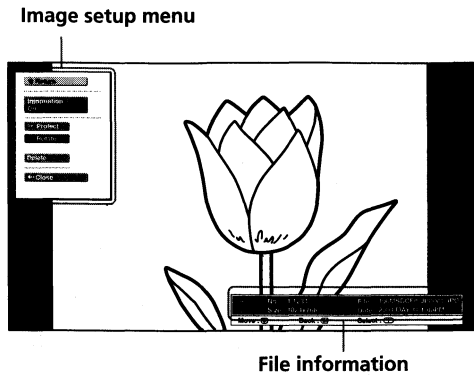

### Tip

- The file information automatically appears at the bottom right when a still image is displayed on the full screen. You can turn off the display of file information by setting "Information" in the image setup menu to "Off".

### Notes

- The full screen display may be rough depending on the still image quality.
- Small size images may not be enlarged on the full screen.
- Displaying a large file will take a longer time.

## Rotating a still image

You can rotate a thumbnail of the still image that you have selected from the "Memory Stick Home" or a still image displayed on the full screen, in 90 degree increments clockwise or counterclockwise.

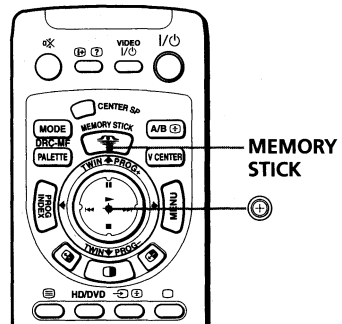

- 1 Insert a "Memory Stick" into the "Memory Stick" slot of the TV.  
For details on inserting a "Memory Stick", see page 46.

- 2 Press MEMORY STICK to display the "Memory Stick Home".

- 3 Move up/down/right/left to select the still image you want to rotate, then press .

The still image index menu appears.

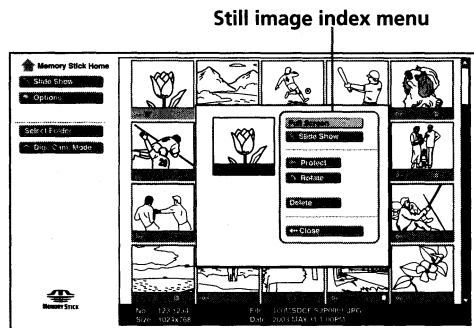

- 4 Move up or down to select "Rotate", then press .

- 5 Move up or down to select the rotating direction "↻" (clockwise) or "↺" (counterclockwise), then press .

Each time you press , the still image is rotated 90 degrees.

- 6 Move down to select "Close", then press .

The rotated image is stored.

continued



---



## Using the "Memory Stick" viewer (continued)

### To rotate a full screen image

1 After displaying an image on the full screen (see page 53), press .

The image setup menu appears.

2 Move  up or down to select "Rotate", then press .

3 Move  up or down to select the rotating direction, then press .

Each time you press , the still image is rotated 90 degrees in the selected direction.

4 Move  down to select "Close", then press .

#### Notes

- You cannot rotate movie files.
- You cannot rotate a still image that has been protected (see page 61). Confirm the protect icon in the file information and unlock the protect before rotating.
- You cannot rotate a still image if the "Memory Stick" is locked.



# Playing movies — Movie Player

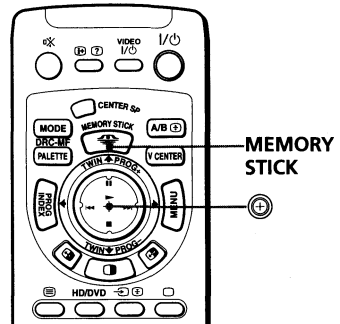

**1** Insert a "Memory Stick" into the "Memory Stick" slot of the TV.  
For details on inserting a "Memory Stick", see page 46.

**2** Press MEMORY STICK to display the "Memory Stick Home".

**3** Move  $\odot$  up/down/right/left to select the movie you want to play, then press  $\oplus$ .  
The movie index menu appears.

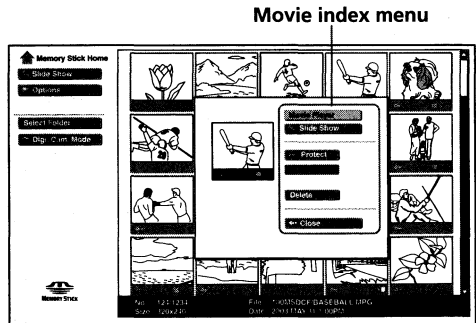

continued

## Using the "Memory Stick" viewer (continued)

- 4 Move  $\odot$  up or down to select "Movie Player", then press  $\odot$ .

The Movie Player appears.

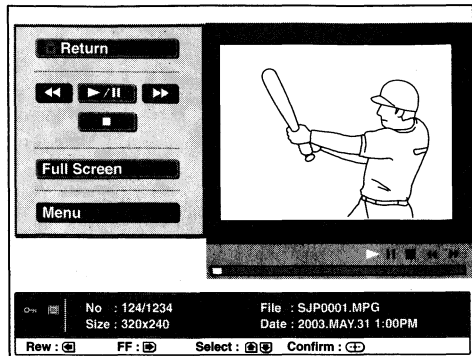

### Movie Player Operation menu

Item	To
"Return"	return to the "Memory Stick Home".
"▶ /   "	play the movie. Select this item during playback to pause playing.
"■"	stop playback.
"◀◀"	Move $\odot$ left during movie stop mode to display the previous file on the "Memory Stick". During playback, the control changes to "◀◀" (Fast-reverse) and the movie is rewound rapidly.
"▶▶"	Move $\odot$ right during movie stop mode to display the next file on the "Memory Stick". During playback, the control changes to "▶▶" (Fast-forward) and the movie is forwarded rapidly.
"Full Screen"	display the movie full screen.
"Menu"	display the movie setup menu to access additional options.

### Notes

- If you select ◀◀ or ▶▶ during the movie stop mode, it may take a longer time to load the previous or next file. During loading the file, "Return" lights up. If you press  $\odot$  when "Return" is lit, the TV returns to the "Memory Stick Home".
- "◀◀" (Fast-reverse) and "▶▶" (Fast-forward) may not work due to the movie file.

## 5 Move $\odot$ up or down to select “▶/||”, then press $\odot$ .

The movie playback starts. At the end of the movie, it returns to the beginning and stops.

To stop playback manually, move  $\odot$  up or down to select “■” and press  $\odot$ .

### To select the sound

- 1 On the Movie Player screen, move  $\odot$  up or down to select “Menu”, then press  $\odot$ .

The Movie setup menu appears.

#### Movie setup menu

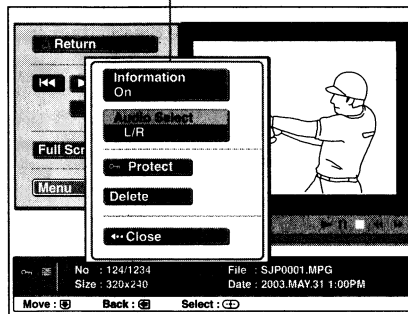

- 2 Move  $\odot$  up or down to select “Audio Select”, then press  $\odot$ .
- 3 Move  $\odot$  up or down to select the sound to be heard, then press  $\odot$ .

### Audio Select menu and selectable sounds

Item	Stereo program	Bilingual program
L/R	left and right sounds	main and sub sounds
L	left sound	main sound
R	right sound	sub sound

#### Note

- The “Audio Select” menu is disabled when the movie does not contain sound.

continued

---

## Using the "Memory Stick" viewer (continued)

### To display the movie on the full screen

- 1 Display the Movie Player, following steps 1 to 4 on page 57.
- 2 Move **⬆** up or down to select "Full Screen", then press **Ⓜ**.  
The movie is displayed on the full screen, and playback starts automatically.

### To return to the Movie Player

During movie playback, move **⬆** up/down/right/left or press **Ⓜ**.

#### Notes

- Small size movies may not be enlarged on the full screen.
- The full screen display may be rough depending on the movie quality.
- Enlarging a file may take a time and a short file may not be played.
- "◀◀" and "▶▶" are disabled when a movie is displayed on the full screen.

## Protecting still images or movies

You can protect a still image or movie from accidental erasure. The protect can be unlocked.

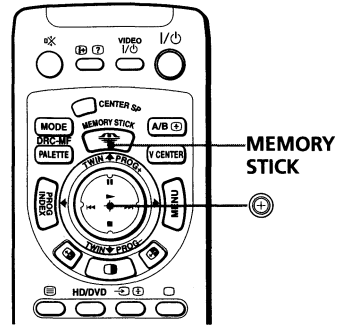

- 1** Insert a "Memory Stick" into the "Memory Stick" slot of the TV.  
For details on inserting a "Memory Stick", see page 46.
- 2** Press MEMORY STICK to display the "Memory Stick Home".

- 3** Move up/down/right/left to select the movie you want to protect, then press .

The still image or movie index menu appears.

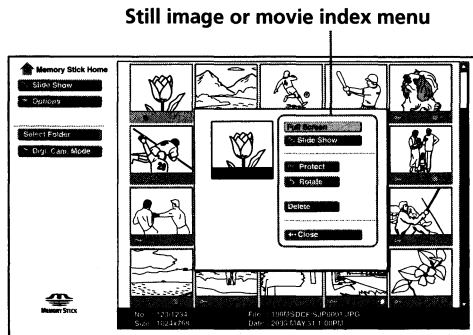

- 4** Move up or down to select "Protect", then press .
  - 5** Move up or down to select "On", then press .
- The (protect) icon is displayed.  
To unlock the protect, select "Off", then press .

**continued**

---

## Using the "Memory Stick" viewer (continued)

### To protect a full screen image

- 1 After displaying a still image on the full screen (see page 53), press **⊕**.  
The image setup menu appears.
- 2 Move **⊕** up or down to select "Protect", then press **⊕**.
- 3 Move **⊕** up or down to select "On", then press **⊕**.

### To protect a movie on the Movie Player

- 1 After displaying the Movie Player (see page 57), move **⊕** up or down to select "Menu", then press **⊕**.  
The movie setup menu appears.
- 2 Move **⊕** up or down to select "Protect", then press **⊕**.
- 3 Move **⊕** up or down to select "On", then press **⊕**.

#### Tip

- The property of the protected image is shown as "Read-only" on a computer.

## Deleting a still image or movie

You can delete unnecessary still image and movie files from the "Memory Stick". Before deleting, make sure they are really unnecessary because the deleted images cannot be restored.

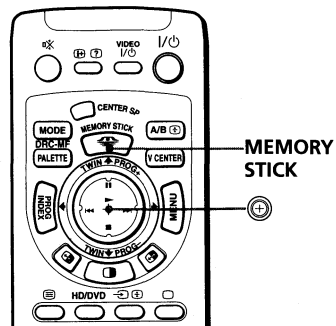

- 1 Insert a "Memory Stick" into the "Memory Stick" slot of the TV.  
For details on inserting a "Memory Stick", see page 46.
- 2 Press MEMORY STICK to display the "Memory Stick Home".

- 3 Move up/down/right/left to select the movie you want to delete, then press .

The still image or movie index menu appears.

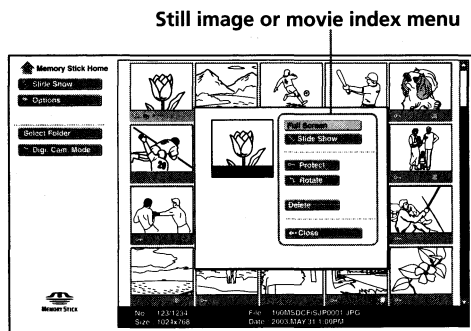

- 4 Move up or down to select "Delete", then press .
- 5 Move up to select "Selected", then press .  
A confirmation message appears.
- 6 Move left to select "Yes", then press .  
To cancel deleting, select "No", then press .







continued

## Using the "Memory Stick" viewer (continued)









### Notes

- When "Digi. Cam. Mode" is set to "On", deleting a file with the Relative file icon deletes the other related files at the same time. (See page 48).
- Before performing deleting, confirm the file information.
- You cannot delete protected image (see page 61). First unlock the protect.
- If the erasure prevention switch on the "Memory Stick" is in the LOCK position, you cannot delete the still images and movies in that "Memory Stick".

### To erase a full screen image

- 1 After displaying a still image on the full screen (see page 53), press .  
The image setup menu appears.
- 2 Move  up or down to select "Delete", then press .
- 3 Move  up to select "Selected", then press .  
A confirmation message appears.
- 4 Move  left to select "Yes", then press .

### To erase a movie on the Movie Player

- 1 After displaying the Movie Player (see page 57), move  up or down to select "Menu", then press .  
The movie setup menu appears.
- 2 Move  up or down to select "Delete", then press .
- 3 Move  up to select "Selected", then press .
- 4 Move  left to select "Yes", then press .



## Displaying the current status of "Memory Stick"

You can display the "Memory Stick" type, total capacity, used capacity and free capacity of the "Memory Stick".

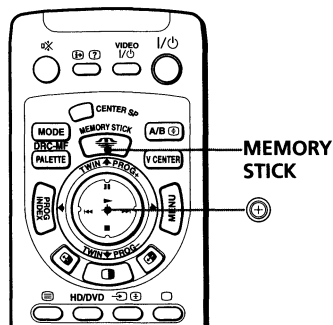

- 1** Insert a "Memory Stick" into the "Memory Stick" slot of the TV.  
For details on inserting a "Memory Stick", see page 46.
- 2** Press MEMORY STICK to display the "Memory Stick Home".
- 3** Move up or down to select "Options", then press .  
The "Options" menu appears.
- 4** Move up or down to select "Memory Stick".  
The current status of the "Memory Stick" appears.

**continued**

## Using the "Memory Stick" viewer (continued)

### Selecting folders

To view the still images and movies stored in different folders using a computer, you need to select the folder.

Before operating this function, make sure that "Digi. Cam. Mode" is set to "Off".

#### Tip

- If you set "Digi. Cam. Mode" to "Off", you can display more than 2,000 images and movies on the screen.

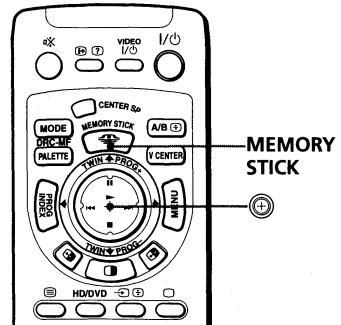

- 1** Insert a "Memory Stick" into the "Memory Stick" slot of the TV.  
For details on inserting a "Memory Stick", see page 46.
- 2** Press MEMORY STICK to display the "Memory Stick Home".
- 3** Move up or down to select "Select Folder", then press . The "Select Folder" menu appears.
- 4** Move up or down to select "Digi. Cam. Mode", then press .
- 5** Move up or down to select "Off", then press .

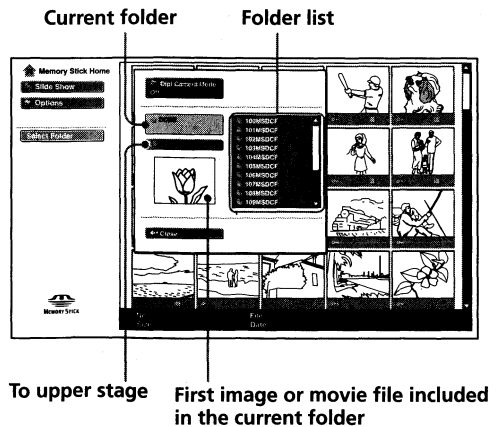

---

**6** Move **⊕** right to select the folder list.

---

**7** Move **⊕** up or down to select the folder which includes the file you want to view, then press **⊕**.

---

**8** Move **⊕** up or down to select "Close", then press **⊕** or move **⊕** left.

The still images and movies included in the selected folder are displayed on "Memory Stick Home".

---

**continued**

## Using the "Memory Stick" viewer (continued)

### Sorting images — Options

You can change the displaying order of the images in a "Memory Stick", in alphabetical order by filename, in chronological order by recording date.

Before operating this function, make sure that "Digi. Cam. Mode" is set to "Off".

#### Tip

- If you set "Digi. Cam. Mode" to "Off", you can display more than 2,000 images and movies on the screen.

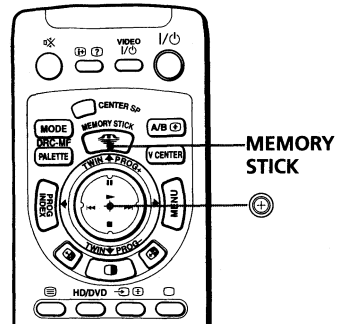

- 1** Insert a "Memory Stick" into the "Memory Stick" slot of the TV.  
For details on inserting a "Memory Stick", see page 46.
- 2** Press MEMORY STICK to display the "Memory Stick Home".
- 3** Move  $\oplus$  up or down to select "Options", then press  $\oplus$ .  
The "Options" menu appears.
- 4** Move  $\oplus$  up or down to select "File", then press  $\oplus$ .
- 5** Move  $\oplus$  up or down to select "Sort", then press  $\oplus$ .
- 6** Move  $\oplus$  up or down to select the desired item, then press  $\oplus$ .

#### Sort menu

Item	To
Name Order $\downarrow^A_2$	sort in alphabetical order (A to Z) by filename
Name Order $\downarrow^Z_A$	sort in reverse alphabetical order (Z to A) by filename
Date Order $\downarrow^1_9$	sort in chronological order by recording (1 to 9)
Date Order $\downarrow^9_1$	sort in reverse chronological order by recording (9 to 1)

#### Note

- If an image file has been processed by a computer, the modified date may be displayed for that file.

## Displaying either still images or movies — Options

You can display either the still images or the movies that are stored in a "Memory Stick".

Before operating this function, make sure that "Digi. Cam. Mode" is set to "Off".

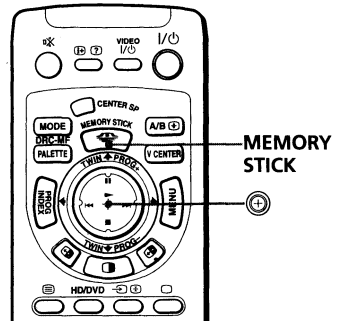

- 1 Insert a "Memory Stick" into the "Memory Stick" slot of the TV.

For details on inserting a "Memory Stick", see page 46.

- 2 Press MEMORY STICK to display the "Memory Stick Home".

- 3 Move (+) up or down to select "Options", then press (+).

The "Options" menu appears.

- 4 Move (+) up or down to select "File", then press (+).

- 5 Move (+) up or down to select "Filter", then press (+).

- 6 Move (+) up or down to select the desired item, then press (+).

### Filter menu

Item	Images to be displayed
"Show Stills"	Still images only
"Show Movies"	Movies only
"Off"	Still images and movies

### Tip

- If "Show Stills" or "Show Movies" is selected on "Filter", the selected image type (still image or movie) is displayed on "Memory Stick home".

## Introducing the menu system

The MENU button lets you open a menu and change the settings of your TV. The following is an overview of the menu system.

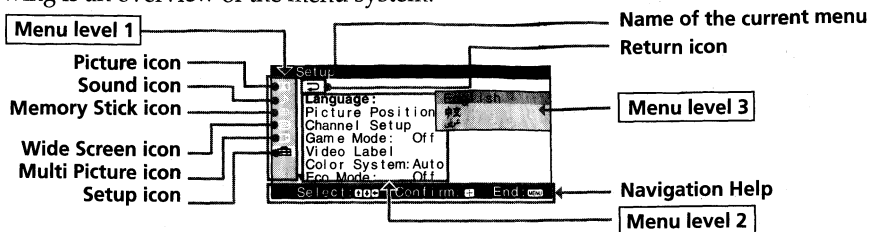



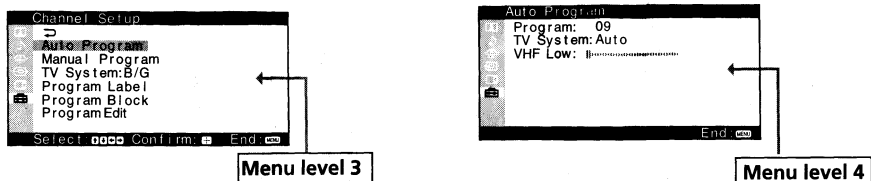

Selecting some items in Menu level 2 of Setup menu displays another menu (Menu level 3), and selecting some options in this menu also displays the adjustment menu (Menu level 4).



Level 1	Level 2/Level 3	Level 3/Level 4/Function
"Picture" 👤	"DRC-MF"	Selects the "DRC-MF" mode: "DRC1250" → "DRC100" → "Progressive"
	"DRC Palette"	Selects one of the three custom DRC palettes. "Custom 1" → "Custom 2" → "Custom 3"
	"Picture Mode"	Selects the picture mode: "Dynamic" → "Standard" → "Hi-Fine" → "Personal"
	"Picture Adjustment"	Adjusts the "Personal" option: "Picture" → "Brightness" → "Color" → "Hue" → "Sharpness" → "Color Temperature" → "Reset"
"Sound" 🎵	"3D-NR"	Activates or deactivates picture noise reduction mode.
	"Sound Mode"	Selects the sound mode: "Dynamic" → "Drama" → "Soft" → "Personal"
	"Sound Adjustment"	Adjusts the "Personal" option: "Treble" → "Bass" → "BBE"* → "Reset"
	"Balance"	Adjusts the balance between the left and right speaker volume.
	"Intelligent Volume"	Activates or deactivates the Intelligent Volume feature.
	"Surround"	Selects the "Surround" mode: "TruSurround" → "Simulated" → "Off"
"Speaker"	Selects the speaker mode: "MAIN" or "CENTER IN".	

\* Licensed by BBE Sound, Inc. under USP4638258, 4482866.  
"BBE" and BBE symbol are trademarks of BBE Sound, Inc.

Level 1	Level 2/Level 3	Level 3/Level 4/Function	
"Memory Stick" 	"Memory Stick Menu"	Displays still pictures and movies stored in a "Memory Stick". You can also display this menu by pressing MEMORY STICK on the remote.	
"Wide Screen" 	"Wide Mode"	Selects the wide screen mode: "Wide Zoom" → "Normal" → "Full" → "Zoom"	
	"Auto Wide"	Selects an optimum wide screen mode automatically.	
	"4:3 Default"	Changes the picture to "Wide Zoom" or "Normal" when the normal 4:3 picture with ID-1 or 480i/480p format signal without ID-1 is received.	
	"V Center"	Adjusts the vertical position of the picture in "Wide Zoom" or "Zoom" mode.	
	"V Size"	Adjusts the vertical size of the picture in "Wide Zoom" or "Zoom" mode.	
"Multi Picture" 	"Twin"	Displays a TV program beside the main screen.	
	"Swap"	Swaps the pictures between the left and right screens.	
	"Program Index"	Scrolls all tuned programs one by one for direct selection.	
"Setup" 	"Language"	Changes the menu language: "English" → "中文" (Chinese) → "عربي" (Arabic)	
	"Picture Position"		Adjusts the picture position if it is not aligned with the TV screen.
		"Picture Rotation"	Adjusts the declination of the picture.
		"Picture V-Position"	Adjusts the vertical position of the picture.
	"Channel Setup"	Presets channels, or select the TV system.	
	"Auto Program"	The "Auto Program" menu is displayed. Presets channels automatically.	
	"Manual Program"	The "Manual Program" menu is displayed. Presets channels manually.	
	"TV System"	Selects the TV system: "B/G" → "I" → "D/K" → "M"	
	"Program Label"	Assigns labels (such as station names) to the preset channels.	
	"Program Block"	Locks out specific channels.	
	"Program Edit"	Changes the order of the preset channels.	
	"Game Mode"	Activates or deactivates GAME MODE feature.	
	"Video Label"		Assigns labels to the audio/video equipment connected to the TV.
"Video Input"		Selects the input to which the audio/video equipment is connected. "Video 1" → "Video 2" → "Video 3" → "Video 4" → "HD/DVD 1" → "HD/DVD 2"	

continued

## Introducing the menu system (continued)

Level 1	Level 2/Level 3	Level 3/Level 4/Function
"Setup" 	"Label"	Selects one of the prefixed labels or assign your own label in "Edit" position. "Video 1" → "VCR" → "SAT" → "Game" → "Edit"
	"Color System"	Selects the color system: "Auto" → "PAL" → "SECAM" → "NTSC3.58" → "NTSC4.43"
	"Eco Mode"	Activates or deactivates ECO MODE feature.
	"S Input"	Selects the S video input mode: "Auto" or "Off".

### To restore the factory settings

Press the RESET button on the remote.

The settings other than the following items in the menu can be reset by using the RESET button:

- "Language"
- "Program" and "Skip" in "Manual Program"
- "Fine" in "Manual Program"
- "TV System"
- "Memory Stick Menu" items
- "Picture Position"
- "Personal" in "Picture Mode" and "Sound Mode"
- "Program Label"
- "Video Label"
- "DRC Palette" Custom settings



## How to use the menu

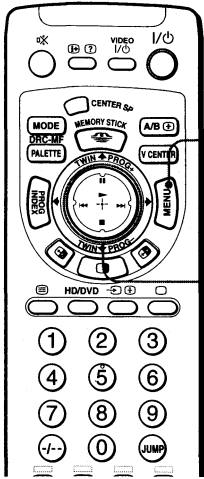

Press MENU to display the menu.

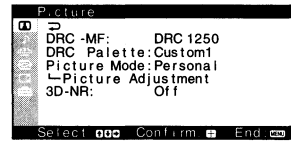

Move the button joystick (⊕) up, down, left or right to select the desired item.

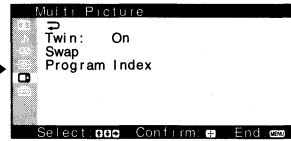
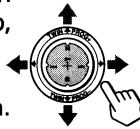

Press the button joystick (⊕) to confirm the selection and/or go to the next level.

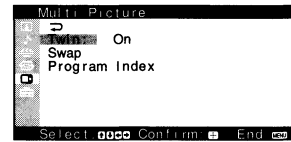

### Other menu operations

To	Press/Move
Adjust the setting value	Move ⊕ up, down, left or right.
Move to the next/previous menu level	Move ⊕ left or right.
Cancel the menu	Press MENU.

### Tips

- If you want to exit from Menu level 2 to Menu level 1, move ⊕ up or down until the return icon (↶) is highlighted, then press ⊕.
- The MENU, -+ (Enter), and ↕/↔/↔/↔ (up/down/left/right) buttons on the TV can also be used for the operations above.

### Note

- If more than 90 seconds elapse between entries, the menu screen other than that for "Memory Stick" menu automatically disappears.

# Changing the "Picture" setting

The "Picture" menu allows you to: adjust the picture setting, view higher quality pictures and reduce picture noise.

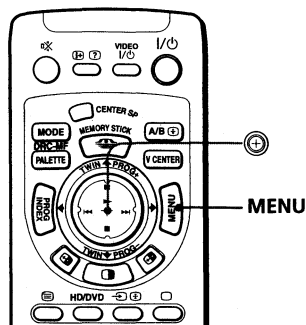

**1** Press MENU.

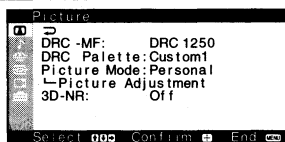

**2** Move  $\oplus$  up or down to select  $\blacktriangle$ , then press  $\oplus$ .

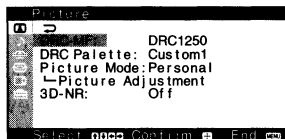
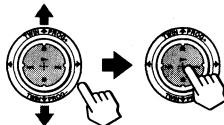

**3** Move  $\oplus$  up or down to select the desired option (see the table below), then press  $\oplus$ .

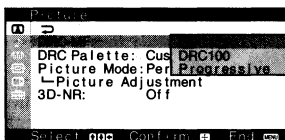
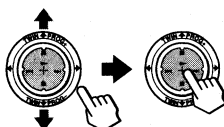

Select	To
"DRC-MF"	activate the Digital Reality Creation-Multi function feature to display higher quality pictures. Move $\oplus$ up or down to select "DRC1250", "DRC100" or "Progressive", then press $\oplus$ .
"DRC Palette"	select one of the customized settings of the picture Reality and Clarity levels. Move $\oplus$ up or down to select "Custom 1", "Custom 2" or "Custom 3", then press $\oplus$ .
"Picture Mode"	receive suitable picture mode. Move $\oplus$ up or down to select "Dynamic", "Standard", "Hi-Fine", "Personal"* , then press $\oplus$ .

\* When the "Personal" mode is selected, the last adjusted picture setting in the "Picture Adjustment" menu is received (see page 76).

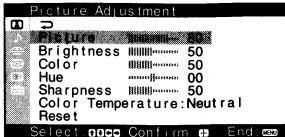
Select	To
"Picture Adjustment"	adjust the picture quality when "Picture Mode" is set to "Personal".
	
"3D-NR"	<p>improve the picture quality of TV or video if a signal received is weak.</p> <p>Move <b>⬆</b> up or down to select "On", then press <b>⬆</b>.</p> <p>To cancel, select "Off", then press <b>⬆</b>.</p>

### Tips

- For details on the options under the "DRC-MF" and "DRC Palette" modes, see pages 21 and 22, respectively.
- When high-definition (HD) or progressive signals are input, "DRC-MF" and "DRC Palette" do not function.
- When using the "Memory Stick" viewer, "DRC-MF", "DRC Palette" and "3D-NR" do not function.
- Some items of the "Picture Adjustment" menu are not available for the pictures stored in a "Memory Stick".

### To return to the normal screen

Press MENU.



**continued**

## Changing the "Picture" setting (continued)



### Adjusting the "Picture Adjustment" options

You can access the "Picture Adjustment" menu only when you have selected "Personal" for "Picture Mode".

**1** Display the "Picture" menu and select "Personal" for "Picture Mode".

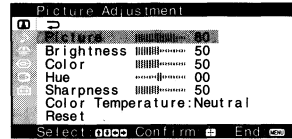
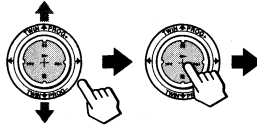



**2** Move  or down to select "Picture Adjustment", then press .

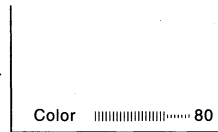
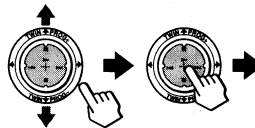

**3** Move  or down to select the desired item (e.g., "Color"), then press .



**4** Adjust the value or select the desired option according to the following table, then press .

For	Move  or left to	Move  or right to
"Picture"	decrease picture contrast	increase picture contrast
"Brightness"	darken the picture	brighten the picture
"Color"	decrease color intensity	increase color intensity
"Hue"*	increase red picture tones	increase green picture tones
"Sharpness"	soften the picture	sharpen the picture
"Color Temperature"	Move  or down to select "Cool", "Neutral" or "Warm".	
"Reset"	Select "Reset" and press  to reset the picture to the factory preset settings.	

\* You can adjust "Hue" for the NTSC color system only.

**5** Repeat steps 3 and 4 to adjust other items.

The adjusted settings will be received when you select "Personal".

# Changing the "Sound" setting

The "Sound" menu allows you to adjust the sound setting and adjust the volume automatically. You can also listen to the sound with surround effect.

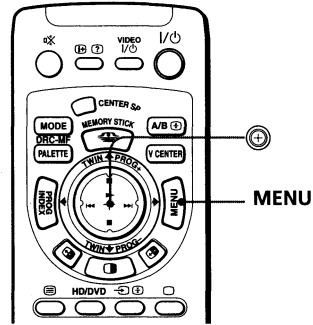

**1** Press MENU.



**2** Move  $\uparrow$  up or down to select  $\text{M}$ , then press  $\uparrow$ .

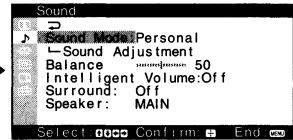
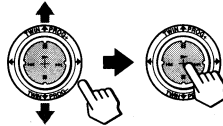

**3** Move  $\uparrow$  up or down to select the desired option (see the table below), then press  $\uparrow$ .

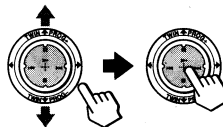

Select	To
"Sound Mode"	<p>select the suitable sound mode. Move <math>\uparrow</math> up or down to select "Dynamic", "Drama", "Soft" or "Personal"*, then press <math>\uparrow</math>.</p> <p>* When the "Personal" mode is selected, the last adjusted sound setting in the "Sound Adjustment" menu is received (see page 79).</p>
"Sound Adjustment"	adjust the sound quality when "Sound Mode" is set to "Personal".

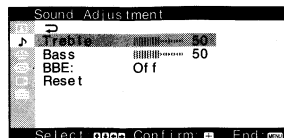

continued

---

## Changing the "Sound" setting (continued)

Select	To
"Balance"	adjust the balance between the left and right speaker volume. Move <b>⬅</b> down or left to increase the left speaker's volume, up or right to increase the right speaker's volume, then press <b>⏏</b> .
"Intelligent Volume"	adjust the volume of all TV programs and video inputs automatically. Move <b>⬆</b> up or down to select "On" to activate the Intelligent Volume feature, then press <b>⏏</b> . To cancel, select "Off", then press <b>⏏</b> .
"Surround"	select the Surround mode. Move <b>⬆</b> up or down to select "TruSurround", "Simulated" or "Off", then press <b>⏏</b> .
"Speaker"	select if you use the TV's speakers as the center speaker of your audio system. Normally select "MAIN". When you want to use the TV's speakers as the center speaker, move <b>⬆</b> up or down to select "CENTER IN", then press <b>⏏</b> .

### Tip

- For details on the options under the "Sound Mode" and "Surround" modes, see pages 20 and 33, respectively.



### To return to the normal screen

Press MENU.



## Adjusting the "Sound Adjustment" options

You can access the "Sound Adjustment" menu only when you have selected "Personal" for "Sound Mode".

- 1 Display the "Sound" menu and select "Personal" for "Sound Mode".

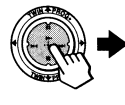
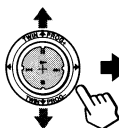

- 2 Move  up or down to select "Sound Adjustment", then press .

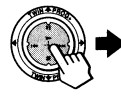
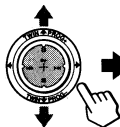

- 3 Move  up or down to select the desired item (e.g., "Treble"), then press .



- 4 Adjust the value or select the desired option according to the following table, then press .

For	Move 
"Treble"	down or left to decrease the treble, up or right to increase the treble.
"Bass"	down or left to decrease the bass, up or right to increase the bass.
"BBE"	up or down to select "High", "Low" or "Off". "BBE" can produce clear sound.
"Reset"	Select "Reset" and press  to reset the sound to the factory preset settings.

- 5 Repeat steps 3 and 4 to adjust other items.

The adjusted settings will be received when you select "Personal".

### Note

- You cannot change the "BBE" mode when the TV is in the center speaker mode (page 41).

# Entering the “Memory Stick” menu

The “Memory Stick” menu allows you to view still pictures and movies stored in a “Memory Stick”.

Insert a “Memory Stick” into the “Memory Stick” slot. For details on using a “Memory Stick”, see pages 42 to 69.

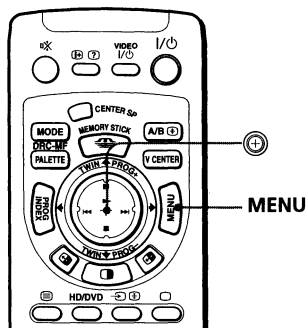

- 1** Press MENU.

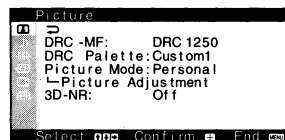

- 2** Move up or down to select , then press .

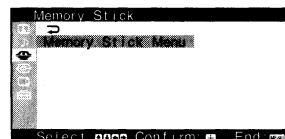
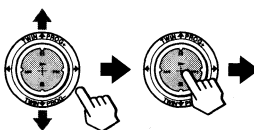

- 3** Make sure that “Memory Stick Menu” is selected, then press .

For details on the options under the “Memory Stick Menu”, see pages 47 to 69.

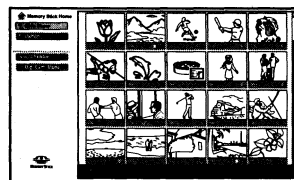

## Tip

- If you select the “Memory Stick” menu in the TWIN or PROGRAM INDEX mode, the TWIN or PROGRAM INDEX mode is cancelled.



# Changing the "Wide Screen" setting

The "Wide Screen" menu allows you to watch the picture filling the 16:9 screen of the TV.

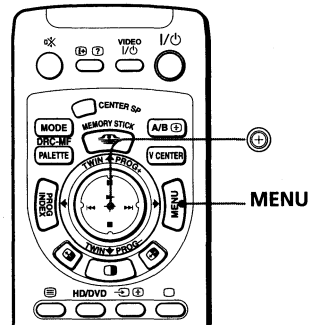

**1** Press MENU.

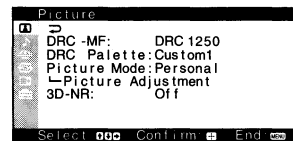

**2** Move  $\uparrow$  or  $\downarrow$  to select  $\text{Wide Zoom}$ , then press  $\text{Enter}$ .

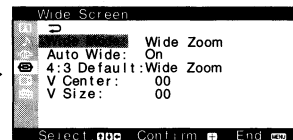
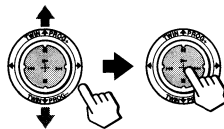

**3** Move  $\uparrow$  or  $\downarrow$  to select the desired option (see the table below), then press  $\text{Enter}$ .

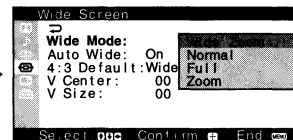
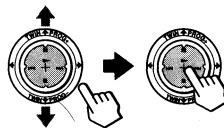





Select	To
"Wide Mode"	select the desired wide screen mode to fit the 16:9 screen. Move $\uparrow$ or $\downarrow$ to select "Wide Zoom", "Normal", "Full" or "Zoom", then press $\text{Enter}$ . For details on each mode, see "Using wide screen mode" on page 24.
"Auto Wide"	automatically display the picture in optimum wide screen mode. Move $\uparrow$ or $\downarrow$ to select "On" (factory setting), then press $\text{Enter}$ . Select "Off" if you want to display any picture in currently selected wide screen mode.
"4:3 Default"	display a 4:3 picture in "Wide Zoom" (factory setting) or in "Normal" mode. Move $\uparrow$ or $\downarrow$ to select "Wide Zoom" or "Normal", then press $\text{Enter}$ .

**continued**

---

## Changing the "Wide Screen" setting (continued)

Select	To
"V Center"	adjust the vertical position of the picture within the screen in "Wide Zoom" or "Zoom" mode. Move  up or down to move the picture, then press  .
"V Size"	adjust the vertical size of the picture within the screen in "Wide Zoom" or "Zoom" mode. Move  up to increase the vertical size, or down to reduce it, then press  .

### Notes

- "4:3 Default" does not function when "Auto Wide" is set to "Off".
- When a 720p or 1080i format signal is received, the picture is always displayed in Full mode.

### To return to the normal screen

Press MENU.

# Operating the "Multi Picture" using the menu

The "Multi Picture" menu allows you to use the TWIN pictures, or PROGRAM INDEX feature.

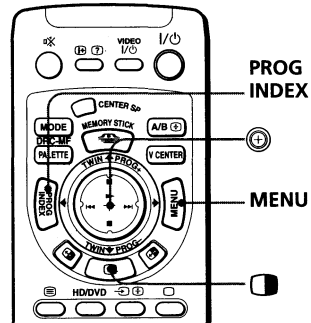

**1** Press MENU.

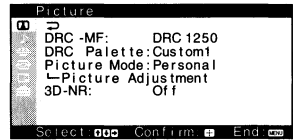

**2** Move  $\uparrow$  up or down to select  $\square$ , then press  $\uparrow$ .

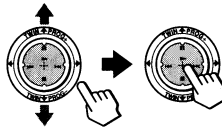

**3** Move  $\uparrow$  up or down to select the desired option (see the table below), then press  $\uparrow$ .

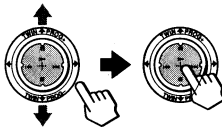

Select	To
"Twin"	display a different TV program beside the main picture. Move $\uparrow$ up or down to select "On", then press $\uparrow$ . To cancel, press $\square$ or select "Off", then press $\uparrow$ .
"Swap"	swap the left and right pictures of the TWIN screen.
"Program Index"	view multiple programs on the sub-screens. To cancel, press PROG INDEX.

## To return to the normal screen

Press MENU.

# Changing the "Setup" setting

The "Setup" menu allows you to adjust the setup of your TV. For example, you can change the menu language, preset channels, etc.

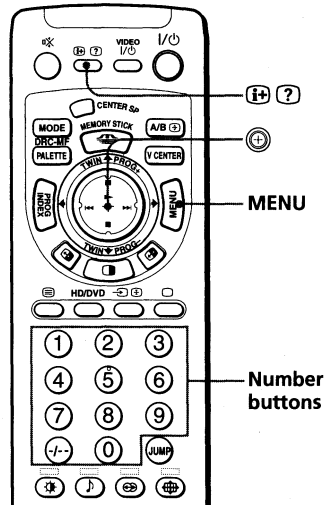

**1** Press MENU.

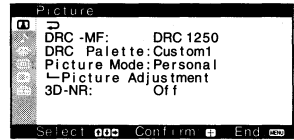

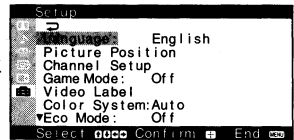
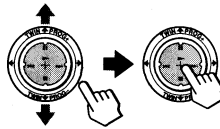

**2** Move  $\oplus$  up or down to select  $\text{Picture}$ , then press  $\oplus$ .

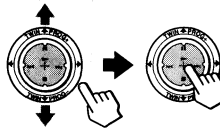

**3** Move  $\oplus$  up or down to select the desired option (see the table below), then press  $\oplus$ .

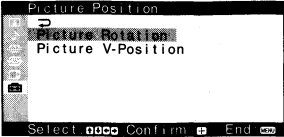
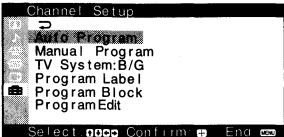

Select	To
"Language"	change the menu language. Move $\oplus$ up or down to select "English", "中文" (Chinese), or "عربي" (Arabic), then press $\oplus$ .





Select	To
"Picture Position"	<p>adjust the position of the picture if it is not aligned with the TV screen.</p>  <p>See "Adjusting the alignment of the picture" on page 87.</p>
"Channel Setup"	<p>preset channels.</p>  <p>You can select automatic or manual channel presetting. See "Presetting channels manually" on page 88. You can change the TV system by selecting "TV System". For "Program Label" and "Program Block", see "Assigning labels to the preset channels" on page 92 and "Blocking channels" on page 93, respectively. You can also change the order of the preset channels to preference. See "Changing the order of the preset channels" on page 90.</p>
"Game Mode"	<p>adjust the picture setting that is suitable to view video games. Move <math>\uparrow</math> up or down to select "On", then press <math>\rightarrow</math>. To cancel, select "Off", then press <math>\rightarrow</math>.</p>
"Video Label"	<p>assign labels to the connected audio/video equipment.</p>  <p>See "Assigning labels to the connected audio/video equipment" on page 94.</p>
"Color System"	<p>select the color system. Normally, set this to "Auto". You can select the color system for each channel or each video input.</p>
"Eco Mode"	<p>reduce power consumption of your TV to save energy. Move <math>\uparrow</math> up or down to select "On", then press <math>\rightarrow</math>. To cancel, select "Off", then press <math>\rightarrow</math>.</p>

continued

---





## Changing the "Setup" setting (continued)

---

Select	To
"S Input"	select the S video input mode. Move  up or down to select "Auto" to receive the S video signal automatically when the signals are input through both the  (S video input) and  (video input) jacks of the same video input channel, then press  . To deactivate the S video input, select "Off", then press  .

---

### Notes

- If "Eco Mode" is on, the ECO MODE () icon will appear at the bottom right corner of the screen when you turn on the TV or when you press  on the remote.
- "Game Mode" is available only when receiving signals through the  (video input),  (S video input), or  (component video input) jacks.
- When high-definition (HD) signals or progressive signals are input, "Game Mode" does not function.
- "Language" selection is disabled when the "Memory Stick" viewer is displayed.

### To return to the normal screen

Press MENU.

## Adjusting the alignment of the picture

The picture may be out of alignment with the TV screen due to the influence of the earth's magnetic field. You can adjust the position of the picture if it is not aligned.

- 1 After selecting "Picture Position", move **⬆** up or down to select "Picture Rotation", then press **⏏**.

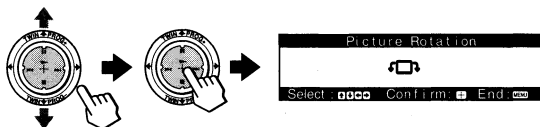

- 2 Move **⬅** left or right to adjust the picture declination.

Adjust so that the upper and lower bars become horizontal, then press **⏏**.

- 3 Move **⬆** up or down to select "Picture V-Position", then press **⏏**.

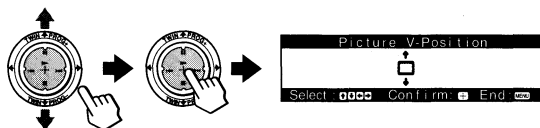

- 4 Move **⬆** up or down to adjust the picture position.

Adjust so that the distance between the upper bar and the top of the screen and that between the lower bar and the bottom of the screen become equal, then press **⏏**.

### Notes

- If you install the TV to another location, make sure to adjust the alignment of the picture again.
- Before adjusting "Picture Rotation" and "Picture V-Position", keep external speakers or other electrical equipment away from the TV. The magnetic disturbance from these equipment or the direction of the earth's magnetic field may affect the TV.
- When adjusting "Picture Rotation", adjust the value step by step. If you rotate the bars largely at a time, color distortion may occur.
- If you do not succeed in adjusting "Picture Rotation" and "Picture V-Position", turn off the TV and change its location or direction, then try to adjust using the menu. Do not move the TV while the TV is turned on. If you do, abnormal color patches may appear on the picture. Press **⏏** on the TV to turn off the TV for about 15 minutes, then turn it on again to demagnetize the TV.
- You cannot adjust "Picture Rotation" and "Picture V-Position" when HD signals are input or "Memory Stick" mode is selected.

continued

## Changing the "Setup" setting (continued)

### Presetting channels manually

- 1** After selecting "Channel Setup", move or to select "Manual Program", then press .

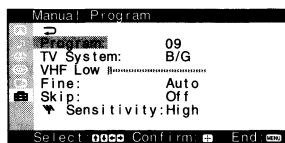
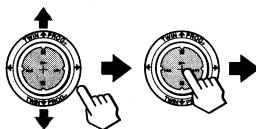

- 2** Select the program number to which you want to preset a channel.

- (1) Make sure "Program" is selected, then press .

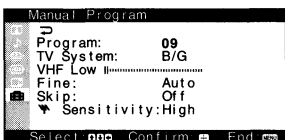
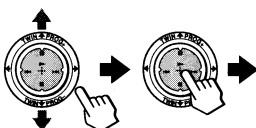

- (2) Move or until the program number you want to preset (e.g., program number "10") appears on the menu, then press .

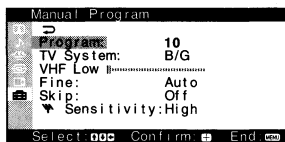
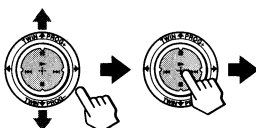

#### Tip

- You can also select the program number with the PROG +/- or number buttons.

- 3** Select the desired channel.

- (1) Move or to select either "VHF Low", "VHF High", or "UHF", then press .

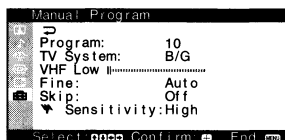
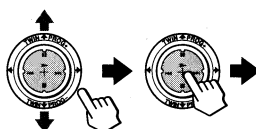

- (2) Move or until the desired channel's broadcast appears on the TV screen, then press .

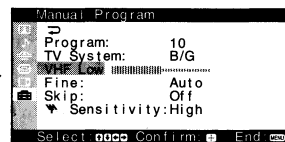
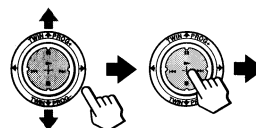

- 4** If the sound of the desired channel is abnormal, select the appropriate TV system.

- (1) Move or to select "TV System", then press .

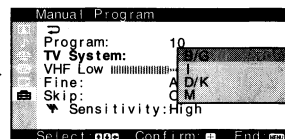
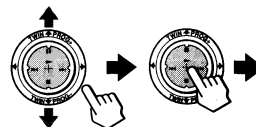

- (2) Move or until the sound becomes normal, then press .

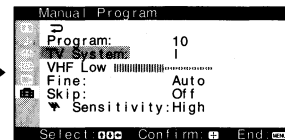
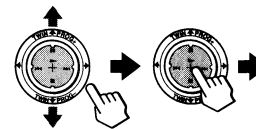



**5** If you are not satisfied with the picture and sound quality, you may be able to improve them by using the "Fine" tuning feature.

(1) Move up or down to select "Fine", then press .

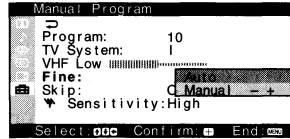
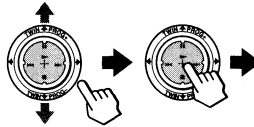

(2) Move up or down to select "Manual", then press .

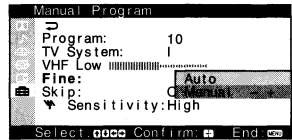
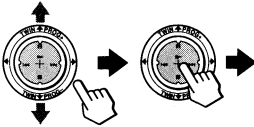

(3) Move either up, down, left or right until the picture and sound quality are optimal, then press . The + or - icon on the menu flashes while tuning.

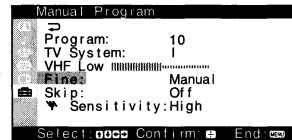
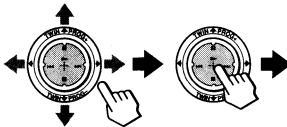

**6** If the TV signal is too strong and the picture is distorted, you can adjust the TV reception sensitivity.

(1) Move up or down to select "Sensitivity", then press .

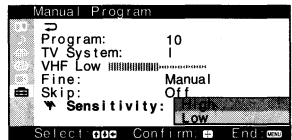
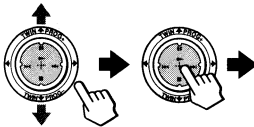

(2) Move up or down to select "Low", then press .

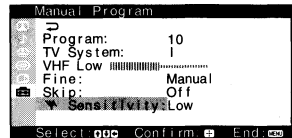
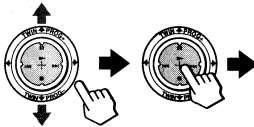

**Notes**

- The TV system ("TV System") and the TV reception sensitivity (" Sensitivity") settings are memorized for each program number.
- If there is a locked channel (see page 93) while you are presetting in "VHF-Low" and "Fine" mode, that channel will be unlocked automatically.

**continued**



## Changing the "Setup" setting (continued)

### Changing the order of the preset channels ("Program Edit")

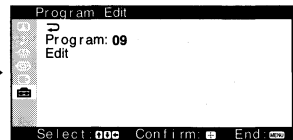
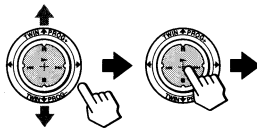

After performing "Auto Program" or "Manual Program", you can change the preset channel assigned to each program number to preference.

- 1 After selecting "Program Edit" under "Channel Setup", make sure "Program" is selected, then press .



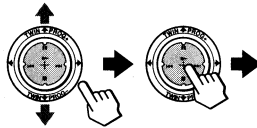

- 2 Move  up or down to select the program number to which you want to assign another channel, then press .

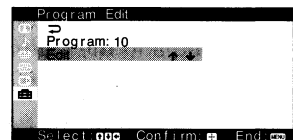
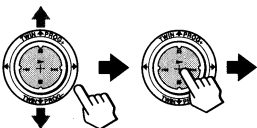

- 3 Move  up or down to select "Edit", then press .



- 4 Move  up or down until your preferred program appears on the screen, then press  to confirm that channel.

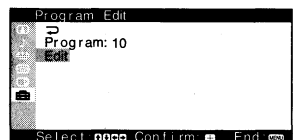
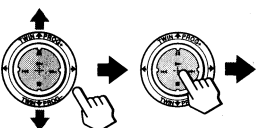

- 5 To change the channels assigned to other program numbers, select "Program", then repeat steps 1 to 4.

### To return to the normal screen



Press MENU.

## Skipping unwanted or unused channels ("Skip")

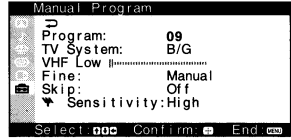
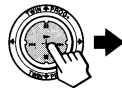
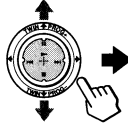

After performing automatic channel presetting, you can erase unwanted or unused channels.

- 1** After selecting "Manual Program" under "Channel Setup", make sure "Program" is selected, then press .



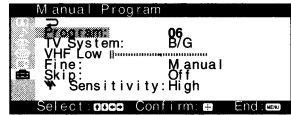
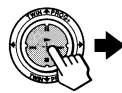
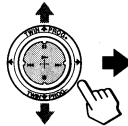

- 2** Move  up or down until the unused or unwanted channel number appears, then press .

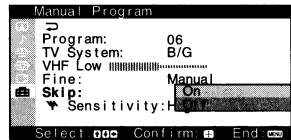
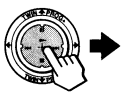
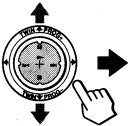

- 3** Move  up or down to select "Skip", then press .



- 4** Move  up or down to select "On", then press .

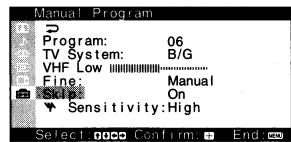
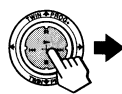
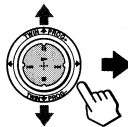

- 5** To disable other channels, select "Program", then repeat steps 2 to 4.

### To restore the skipped channel

Select "Off" in step 4.

### To return to the normal screen

Press MENU.

continued



## Changing the "Setup" setting (continued)

### Assigning labels to the preset channels ("Program Label")

You can assign a label (such as station name) of up to 5 characters to each preset channel.

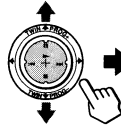
- 1 After selecting "Program Label" under "Channel Setup", make sure "Program" is selected, then press .



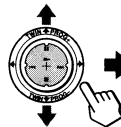

- 2 Move  up or down to select the channel you want to assign a label, then press .



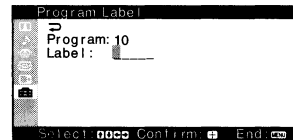
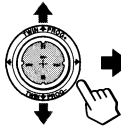

- 3 Move  up or down to select "Label", then press .



- 4 Move  up or down to scroll through the label characters (A to Z, 0 to 9, etc.), then press .

To insert a blank, leave "\_" and move .

To change the confirmed character, move  left to highlight it, then move  up or down to select the correct character.

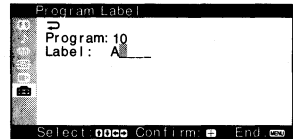
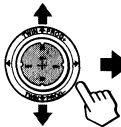

- 5 Repeat step 4 to add up to 5 characters to the label.

- 6 To assign labels to other channels, select "Program", then repeat steps 1 to 5.



### To return to the normal screen

Press MENU.

## Blocking channels ("Program Block")

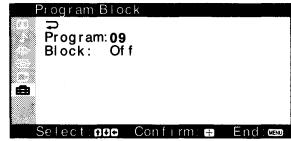
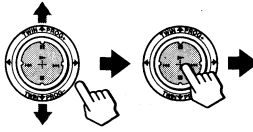
- 1** After selecting "Program Block" under "Channel Setup", make sure "Program" is selected, then press .



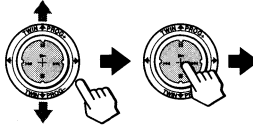

- 2** Move  up or down to select the desired channel (e.g. 06), then press .

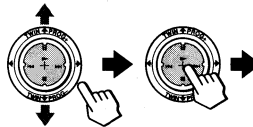

- 3** Move  up or down to select "Block", then press .



- 4** Move  up or down to select "On", then press . To unlock the channel, select "Off".

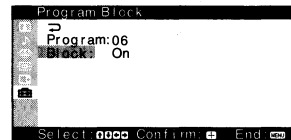
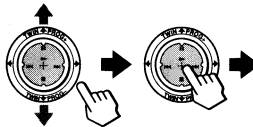

The lock symbol (  ) appears on the screen when "On" is selected.

If a locked channel is selected, the lock symbol appears on the screen.

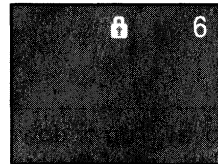

- 5** To lock other channels, select "Program", then repeat steps 2 to 4.

### To return to the normal screen

Press MENU.

#### Note

- If you preset a locked channel manually (see page 88), that channel will be unlocked automatically.

continued



## Changing the "Setup" setting (continued)



### Assigning labels to the connected audio/video equipment ("Video Label")

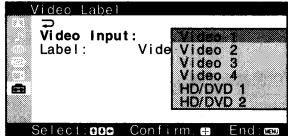
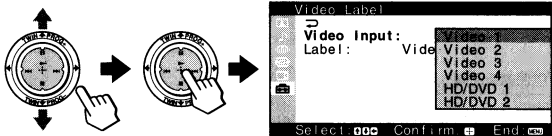

You can assign one of the prefixed labels (such as VCR, SAT, etc.) or your favorite label to the audio/video equipment connected to the video inputs of the TV.

#### To assign a prefixed label

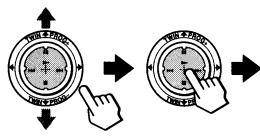
- 1 After selecting "Video Label", make sure "Video Input" is selected, then press .

- 2 Move  up or down to select the video input you have connected the equipment you want to assign a label, then press .

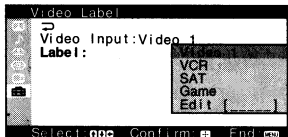
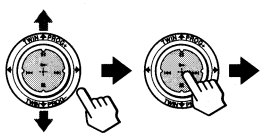
- 3 Move  up or down to select "Label", then press .

- 4 Move  up or down to select one of the prefixed labels, then press .

To assign your favorite label, see page 95.

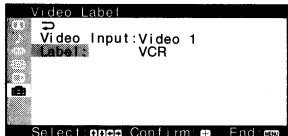
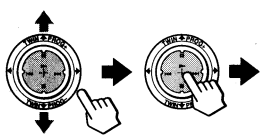

- 5 To assign labels to other equipment, select "Video Input", then repeat steps 2 to 4.

#### To return to the normal screen

Press MENU.

## To assign your favorite label

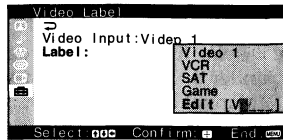
- 1 Follow steps 1 to 3 on page 94 and select "Edit" in step 4, then press **⊕**.
- 2 Move **⊕** up or down to scroll through the label characters (A to Z, 0 to 9, etc.), then press **⊕** to confirm the highlighted character.













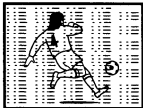

To insert a blank, leave " \_ " and move **⊕** right.

To change the confirmed character, move **⊕** left to highlight it, then move **⊕** up or down to select the correct character.







- 3 Repeat step 2 to add up to 5 characters to the label.

## Troubleshooting

If you have any problem while viewing your TV, please check the following troubleshooting guide. If the problem persists, contact your Sony dealer.

Symptom	Possible cause	Solutions	Page
<b>Snowy picture</b> 	<ul style="list-style-type: none"> <li>The connection is loose or the cable is damaged.</li> <li>Channel presetting is inappropriate or incomplete.</li> </ul>	<ul style="list-style-type: none"> <li>Check the antenna cable and connection on the TV, VCR and on the wall.</li> <li>Display the "Channel Setup" menu under the "Setup" menu and select "Manual Program" to preset the channel again.</li> </ul>	<p>7</p> <p>88</p>
<b>Noisy sound</b> 	<ul style="list-style-type: none"> <li>The antenna type is inappropriate.</li> <li>The antenna direction needs adjustment.</li> <li>Signal transmission is low.</li> </ul>	<ul style="list-style-type: none"> <li>Check the antenna type (VHF/UHF). Contact a Sony dealer for advice.</li> <li>Adjust the antenna direction. Contact a Sony dealer for advice.</li> <li>Try using a booster.</li> </ul>	<p>-</p> <p>-</p> <p>-</p>
<b>Distorted picture</b> 	<ul style="list-style-type: none"> <li>Broadcast signals are too strong.</li> </ul>	<ul style="list-style-type: none"> <li>Display the "Channel Setup" menu under the "Setup" menu and select "Manual Program". Then, select "Sensitivity: Low".</li> <li>Turn off or disconnect the booster if it is in use.</li> </ul>	<p>89</p> <p>-</p>
<b>Noisy sound</b> 			
<b>Good picture</b> 	<ul style="list-style-type: none"> <li>The TV system setting is inappropriate.</li> </ul>	<ul style="list-style-type: none"> <li>If the sound of all the channels are noisy, display the "Channel Setup" menu under the "Setup" menu and select "Auto Program" to preset the channels again.</li> <li>If the sound of some channels is noisy, select the channel, then display the "Channel Setup" menu under the "Setup" menu and select the appropriate TV system ("TV System").</li> </ul>	<p>85</p> <p>88</p>
<b>Noisy sound</b> 	<ul style="list-style-type: none"> <li>The sound of the right picture is selected when TWIN pictures are displayed.</li> </ul>	<ul style="list-style-type: none"> <li>Press  or .</li> </ul>	<p>29</p>
<b>No picture</b> 	<ul style="list-style-type: none"> <li>The power cord, antenna or VCR is not connected.</li> <li>The TV is not turned on.</li> </ul>	<ul style="list-style-type: none"> <li>Check the power cord, antenna and the VCR connections.</li> <li>Press  on the remote.</li> <li>Press  on the TV to turn off the TV for about five seconds, then turn it on again.</li> </ul>	<p>7</p> <p>17</p> <p>18</p>
<b>No sound</b> 			



Symptom	Possible cause	Solutions	Page
<b>Good picture</b> 	<ul style="list-style-type: none"> <li>The volume level is too low.</li> <li>The sound is muted.</li> <li>The broadcast signal has a transmission problem.</li> </ul>	<ul style="list-style-type: none"> <li>Press <math>\triangle</math> + to increase the volume level.</li> <li>Press <math>\times</math> to cancel the muting.</li> <li>Press A/B until a better sound is heard.</li> </ul>	<p>18</p> <p>18</p> <p>34</p>
<b>No sound</b> 	<ul style="list-style-type: none"> <li>The sound of the right picture is selected when TWIN pictures are displayed.</li> </ul>	<ul style="list-style-type: none"> <li>Press  or .</li> </ul>	29
<b>Dotted lines or stripes</b> 	<ul style="list-style-type: none"> <li>There is local interference from cars, neon signs, hair dryers, power generators, etc.</li> </ul>	<ul style="list-style-type: none"> <li>Do not use a hair dryer or other equipment near the TV.</li> <li>Adjust the antenna direction for minimum interference. Contact a Sony dealer for advice.</li> </ul>	<p>-</p> <p>-</p>
<b>Double images or "ghosts"</b> 	<ul style="list-style-type: none"> <li>Broadcast signals are reflected by nearby mountains or buildings.</li> <li>The antenna direction needs adjustment.</li> <li>Use of a booster is inappropriate.</li> </ul>	<ul style="list-style-type: none"> <li>Use a highly directional antenna.</li> <li>Use the fine tuning ("Fine") function.</li> <li>Adjust the antenna direction. Contact a Sony dealer for advice.</li> <li>Turn off or disconnect the booster if it is in use.</li> </ul>	<p>-</p> <p>89</p> <p>-</p> <p>-</p>
<b>No color</b> 	<ul style="list-style-type: none"> <li>The color level setting is too low.</li> <li>The color system setting is inappropriate.</li> <li>The antenna direction needs adjustment.</li> </ul>	<ul style="list-style-type: none"> <li>Display the "Picture" menu and select "Personal" of "Picture Mode", then adjust the "Color" level under "Picture Adjustment".</li> <li>Display the "Setup" menu and check the color system ("Color System") setting (usually set this to "Auto").</li> <li>Adjust the antenna direction. Contact a Sony dealer for advice.</li> </ul>	<p>76</p> <p>85</p> <p>-</p>
<b>Picture is not aligned to the TV screen.</b>	<ul style="list-style-type: none"> <li>The magnetic disturbance from external speakers or other equipment, or the direction of the earth's magnetic field may affect the TV.</li> </ul>	<ul style="list-style-type: none"> <li>Keep external speakers or other electrical equipment away from the TV.</li> <li>Display the "Picture Position" menu under the "Setup" menu and adjust "Picture Rotation" and "Picture V-Position" so that the picture is aligned to the TV screen.</li> </ul>	<p>-</p> <p>87</p>

continued

## Troubleshooting (continued)

Symptom	Possible cause	Solutions	Page
<b>Abnormal color patches</b> 	<ul style="list-style-type: none"> <li>The magnetic disturbance from external speakers or other equipment, or the direction of the earth's magnetic field may affect the TV.</li> </ul>	<ul style="list-style-type: none"> <li>Locate external speakers or other equipment away from the TV. Do not move the TV while the TV is turned on. Press <math>\odot</math> (main power) on the TV to turn off the TV for about 15 minutes, then turn it on again.</li> <li>Display the "Picture Position" menu under the "Setup" menu and adjust "Picture Rotation" and "Picture V-Position" so that the picture is aligned to the TV screen.</li> </ul>	<p>9</p> <p>87</p>
<b>TV cannot receive stereo broadcast signal.</b>	<ul style="list-style-type: none"> <li>The stereo reception setting is inappropriate.</li> </ul>	<ul style="list-style-type: none"> <li>Press A/B until "Auto" appears on the screen.</li> </ul>	35
	<ul style="list-style-type: none"> <li>The sound of the right picture is selected when TWIN pictures are displayed.</li> </ul>	<ul style="list-style-type: none"> <li>Press <math>\leftarrow</math> or <math>\rightarrow</math>.</li> </ul>	29
<b>Stereo broadcast sound switches on and off or is distorted.</b> or <b>The sound switches between stereo and monaural frequently.</b>	<ul style="list-style-type: none"> <li>The connection is loose or the cable is damaged.</li> </ul>	<ul style="list-style-type: none"> <li>Check the antenna cable and connection on the TV, VCR and on the wall.</li> </ul>	7
	<ul style="list-style-type: none"> <li>The antenna direction needs adjustment.</li> </ul>	<ul style="list-style-type: none"> <li>Adjust the antenna direction. Contact a Sony dealer for advice.</li> </ul>	—
	<ul style="list-style-type: none"> <li>The broadcast signal has a transmission problem.</li> </ul>	<ul style="list-style-type: none"> <li>Press A/B until a better sound is heard.</li> </ul>	34
<b>"100" appears at the top of the screen after approximately 10 seconds and there is no Teletext display.</b>	<ul style="list-style-type: none"> <li>The channel carries no Teletext broadcast.</li> </ul>	—	36
<b>Teletext display is incomplete (snowy picture or double images).</b>	<ul style="list-style-type: none"> <li>Connection is loose or the cable is damaged.</li> </ul>	<ul style="list-style-type: none"> <li>Check the antenna cable and connection on the TV, VCR, and at the wall.</li> </ul>	7
	<ul style="list-style-type: none"> <li>The antenna direction is inappropriate.</li> </ul>	<ul style="list-style-type: none"> <li>Adjust the antenna direction. Contact a Sony dealer for advice.</li> </ul>	—
	<ul style="list-style-type: none"> <li>Signal transmission is too low.</li> </ul>	<ul style="list-style-type: none"> <li>Try using a booster.</li> <li>Use the fine tuning ("Fine") function.</li> </ul>	— 89
<b>Lines moving across the TV screen.</b>	<ul style="list-style-type: none"> <li>There is interference from external sources, e.g., heavy machineries, nearby broadcast station.</li> </ul>	<ul style="list-style-type: none"> <li>Use the fine tuning ("Fine") function.</li> </ul>	89

Symptom	Possible cause	Solutions	Page
The wide screen mode changes spontaneously when "Auto Wide" is "On".	<ul style="list-style-type: none"> <li>During a transition between two programs, the TV detects the optimum wide screen mode. During this period, an irregular wide screen mode may appear.</li> </ul>	—	24
	<ul style="list-style-type: none"> <li>The wide screen mode is switched automatically according to the received signal with an ID-1 or S1 signal.</li> </ul>	—	25
	<ul style="list-style-type: none"> <li>The AUTO WIDE feature stops working temporarily when you have pressed , and functions again after a while.</li> </ul>	<ul style="list-style-type: none"> <li>To fix in the manually selected wide screen mode, set "Auto Wide" to "Off" in the "Wide Screen" menu.</li> </ul>	81
The images in the "Memory Stick" are not displayed.	<ul style="list-style-type: none"> <li>The "Memory Stick" is inserted inappropriately.</li> </ul>	<ul style="list-style-type: none"> <li>Insert the "Memory Stick" correctly.</li> </ul>	46
	<ul style="list-style-type: none"> <li>The "Memory Stick" menu is not displayed.</li> </ul>	<ul style="list-style-type: none"> <li>Press the MEMORY STICK button.</li> </ul>	47
	<ul style="list-style-type: none"> <li>No photo or movie files are contained in the "Memory Stick".</li> </ul>	<ul style="list-style-type: none"> <li>Insert a "Memory Stick" with photo or movie files.</li> </ul>	46
	<ul style="list-style-type: none"> <li>The photo or movie image is processed by a computer.</li> </ul>	<ul style="list-style-type: none"> <li>Set "Digi. Cam. Mode" to "Off" and select the folder.</li> </ul>	48
"No Memory Stick" is displayed.	<ul style="list-style-type: none"> <li>The "Memory Stick" is inserted inappropriately.</li> </ul>	<ul style="list-style-type: none"> <li>Insert the "Memory Stick" correctly.</li> </ul>	46
"Memory Stick error" is displayed.	<ul style="list-style-type: none"> <li>The "Memory Stick" is irregular.</li> </ul>	<ul style="list-style-type: none"> <li>Remove the "Memory Stick" and insert it again.</li> </ul>	46
	<ul style="list-style-type: none"> <li>The "Memory Stick" may be broken.</li> </ul>	<ul style="list-style-type: none"> <li>Insert another "Memory Stick".</li> </ul>	46
"File error" is displayed.	<ul style="list-style-type: none"> <li>The name of the selected file is not correct.</li> </ul>	—	43
"Format error" is displayed.	<ul style="list-style-type: none"> <li>The "Memory Stick" is not formatted correctly.</li> </ul>	<ul style="list-style-type: none"> <li>Format it correctly using a digital camera or other equipment, or insert another "Memory Stick" formatted correctly.</li> </ul>	42

continued

## Troubleshooting (continued)

Symptom	Possible cause	Solutions	Page
"Too many files. Cannot enter Digital Camera Mode." is displayed.	<ul style="list-style-type: none"> <li>When "Digi. Cam. Mode" is set to "On", 2,000 files or less can be displayed.</li> </ul>	<ul style="list-style-type: none"> <li>Set "Digi. Cam. Mode" to "Off" and select the folder.</li> </ul>	48
"Memory Stick type error" is displayed.	<ul style="list-style-type: none"> <li>The inserted "Memory Stick" is not available for use with this TV.</li> </ul>	<ul style="list-style-type: none"> <li>Insert a "Memory Stick" available for use with this TV.</li> </ul>	46
"No file" is displayed.	<ul style="list-style-type: none"> <li>No photo or movie files available for playback are contained in the selected folder of the "Memory Stick" when "Digi. Cam. Mode" is set to "On".</li> </ul>	<ul style="list-style-type: none"> <li>Set "Digi. Cam. Mode" to "Off" and select the folder.</li> </ul>	48
	<ul style="list-style-type: none"> <li>No photo or movie files available for playback are contained in the selected folder of the "Memory Stick" when "Digi. Cam. Mode" is set to "Off".</li> </ul>	<ul style="list-style-type: none"> <li>Select another folder that contains photo or movie files.</li> </ul>	48
The file name is not displayed correctly.	<ul style="list-style-type: none"> <li>The file name has been processed by a computer.</li> </ul>	—	43
"Memory Stick locked" is displayed.	<ul style="list-style-type: none"> <li>The erasure prevention switch of the "Memory Stick" is in the LOCK position.</li> </ul>	<ul style="list-style-type: none"> <li>Unlock the switch.</li> </ul>	43
"No movie file" is displayed.	<ul style="list-style-type: none"> <li>"Show Movies" is selected from "Filter" of the "Option" menu and no movie files are contained in the selected folder.</li> </ul>	<ul style="list-style-type: none"> <li>Select the folder with movie files.</li> </ul>	69
"No still file" is displayed.	<ul style="list-style-type: none"> <li>"Show Stills" is selected from "Filter" of the "Option" menu and no still image files are contained in the selected folder.</li> </ul>	<ul style="list-style-type: none"> <li>Select the folder with still image files.</li> </ul>	69
"Playback has been stopped. The file is damaged." is displayed.	<ul style="list-style-type: none"> <li>The data in the movie file is broken.</li> </ul>	—	—

Symptom	Possible cause	Solutions	Page
Cannot play shooting games.	<ul style="list-style-type: none"> <li>Some shooting games which involve pointing a light beam at the TV screen with an electronic gun or rifle cannot be used with your TV. For detail, see the instruction manual supplied with the video game software.</li> </ul>	—	—
TV cabinet creaks.	<ul style="list-style-type: none"> <li>Changes in room temperature sometimes make the TV cabinet expand or contract, causing a noise. This does not indicate a malfunction.</li> </ul>	—	—
Static discharge is felt when touching the TV cabinet.	<ul style="list-style-type: none"> <li>This is the same static discharge that is felt when touching metal door handles or car doors especially when the air is dry, for example in winter. This does not indicate a malfunction.</li> </ul>	—	—

# Self-diagnosis function

Your TV is equipped with a self-diagnosis function. If there is a problem with your TV, the ⏻ (standby) indicator flashes red. The number of times the ⏻ indicator flashes indicates the possible causes.

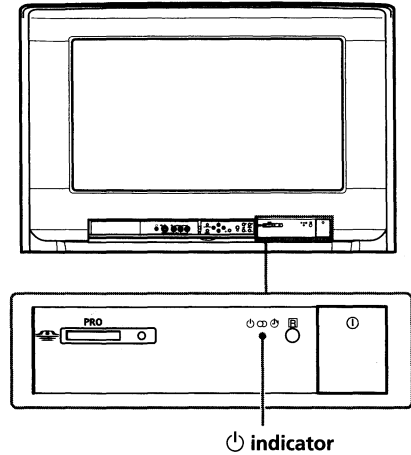

- 1** Check that the ⏻ indicator flashes red a number of times between 3-second intervals.
- 2** Count the number of times the ⏻ indicator flashes.
- 3** Press Ⓚ (main power) to turn off your TV.
- 4** Inform your nearest Sony service center about the number of times the ⏻ indicator flashed.

Be sure to note the model name and serial number located on the rear of your TV.

# Identifying parts and controls

## Front and inside the drop-down panel

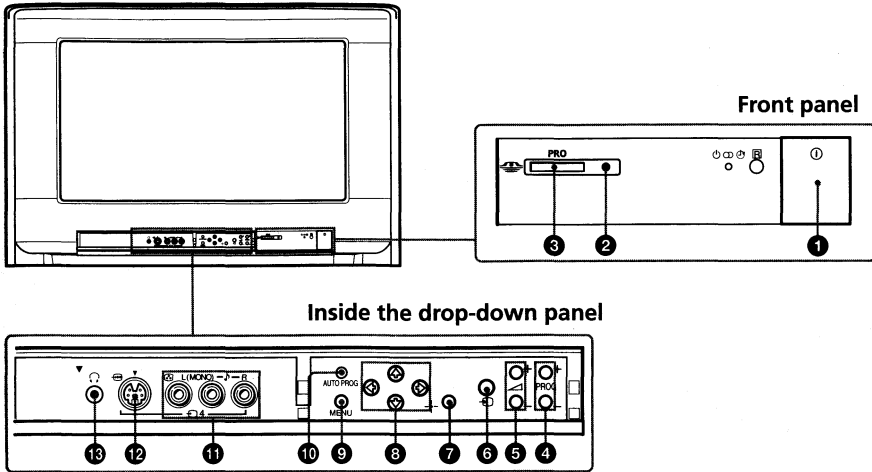







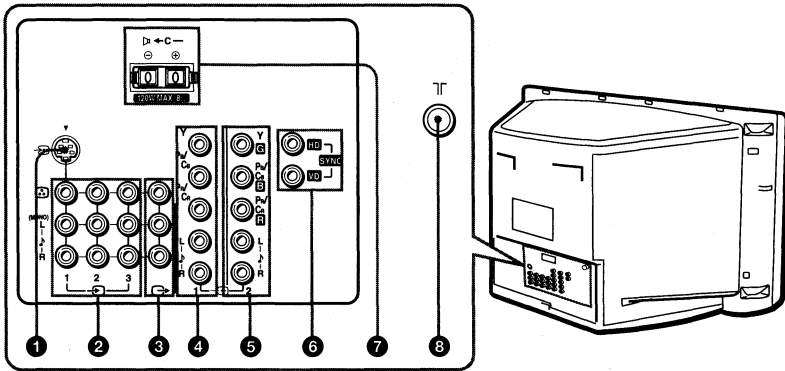

Button/connector	Function	Page
① ①	Turn off completely or turn on the TV.	18
② "Memory Stick" indicator	Flashes when the data is being read from a "Memory Stick".	46
③ "Memory Stick" slot	Insert a "Memory Stick" into this slot.	45
④ PROG +/-	Select program number.	17
⑤ $\triangle$ +/-	Adjust volume.	18
⑥ $\rightarrow$	Select TV or video input.	18
⑦ $\uparrow$	Confirm selected items.	73
⑧ $\uparrow/\downarrow/\leftarrow/\rightarrow$	Select items in the menu.	73
⑨ MENU	Display the menu.	73
⑩ AUTO PROG	Preset channels automatically.	71
⑪ $\rightarrow$ 4 (③, $\uparrow$ L(MONO) /R)	Connect to video/audio outputs of equipment.	11
⑫ $\rightarrow$ 4 ( $\rightarrow$ )	Connect to S video output of video equipment.	11
⑬ $\odot$	Headphone jack	-

continued

## Identifying parts and controls (continued)

### Rear



Connector	Function	Page
① 	Connect to S video output of video equipment.	8
② 	Connect to video/audio outputs of video equipment.	8
③ 	Connect to video/audio inputs of audio/video equipment.	12
④  1	Connect to component video outputs on a DVD player.	13
⑤  2	Connect to component video outputs on a DVD player. Connect to a digital TV receiver equipped with the G/B/R/HD/VD outputs.	13 15
⑥ SYNC HD/VD	Connect to HD/VD outputs on a digital TV receiver.	15
⑦ 	Connect to speaker terminals on an amplifier.	16
⑧ 	Connect the antenna cable.	7



## Remote control

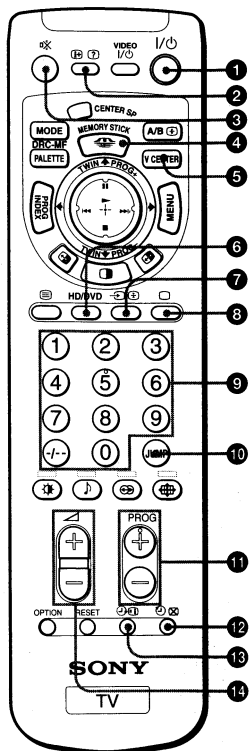

The names/symbols of buttons on the remote are indicated in different colors to represent the available functions.









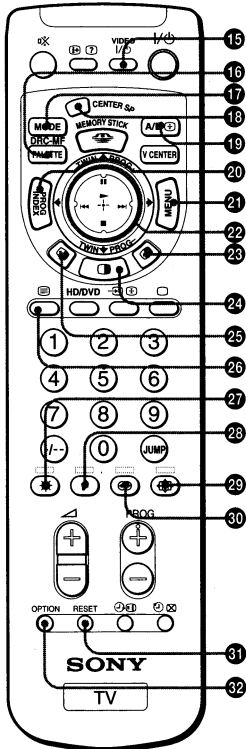

Label color	Button function
White	For general TV operations
Green	For Teletext operations
Yellow	For TWIN picture operations
Pink	For optional components operations

Button	Function	Page
1 I/⏻	Turn off temporarily or turn on the TV.	17
2 i (?)	<ul style="list-style-type: none"> <li>• Display on-screen information.</li> <li>• Reveal Teletext concealed information.</li> </ul>	18 37
3 Mute	Mute the sound.	18
4 MEMORY STICK	Display "Memory Stick Menu" when a "Memory Stick" is inserted into the "Memory Stick" slot.	46
5 V CENTER	Adjust the vertical position of the picture.	27
6 HD/DVD	Select component input.	18
7 TV/VIDEO	<ul style="list-style-type: none"> <li>• Select TV or video input.</li> <li>• Stop Teletext page from scrolling.</li> </ul>	18 37
8 TV	<ul style="list-style-type: none"> <li>• Display the TV program.</li> <li>• Turn off Teletext.</li> </ul>	18 36
9 0 - 9, -/--	Input numbers.	17
10 JUMP	Jump to previous channel.	18
11 PROG +/-	Select program number.	17
12 ⏻	<ul style="list-style-type: none"> <li>• Set the TV to turn off automatically.</li> <li>• Show TV screen while waiting for Teletext page.</li> </ul>	19 37
13 ⏻	<ul style="list-style-type: none"> <li>• Set the TV to turn on automatically.</li> <li>• Display Teletext service contents.</li> </ul>	19 37
14 +/-	Adjust volume.	18

continued

## Identifying parts and controls (continued)



Button	Function	Page
15 VIDEO I/O	<ul style="list-style-type: none"> <li>Power.</li> <li>Use with the number buttons to set up the remote.</li> </ul>	39 38
16 DRC-MF PALETTE	Customize the picture Reality and Clarity levels.	22
17 DRC-MF MODE	Select DRC-MF mode.	21
18 CENTER SP	Select TV's center speaker mode.	41
19 A/B	<ul style="list-style-type: none"> <li>Select stereo/bilingual mode.</li> <li>Enlarge the Teletext display.</li> </ul>	34 37
20 PROG INDEX	Display all preset TV programs.	31
21 MENU	Display the menu.	73
22	 <ul style="list-style-type: none"> <li>Select, adjust and confirm selected items in the menu.</li> <li>Select a program of the right picture.</li> <li>Select desired program in PROGRAM INDEX.</li> <li>Operate optional components.</li> </ul>	73 30 31 39
23	 Swap the left and right pictures.	29
24	 Display TWIN pictures.	28
25	 Swap sound between the left and right pictures.	29
26	 Display Teletext page on the TV picture.	36
27	 (red) <ul style="list-style-type: none"> <li>Select picture mode.</li> <li>Access a FASTEXT menu.</li> </ul>	20 37
28	 (green) <ul style="list-style-type: none"> <li>Select sound mode.</li> <li>Access a FASTEXT menu.</li> </ul>	20 37
29	 (blue) <ul style="list-style-type: none"> <li>Select wide mode.</li> <li>Access a FASTEXT menu.</li> </ul>	26 37
30	 (yellow) <ul style="list-style-type: none"> <li>Select surround mode.</li> <li>Access a FASTEXT menu.</li> </ul>	33 37
31 RESET	Reset items in the menu to the factory preset values.	72
32 OPTION	Use with  to operate optional components.	39

# Specifications

	KV-HR36 M31	KV-HR32 M31
<b>Power requirements</b>	220–240 V AC, 50/60 Hz	
<b>Power consumption (W)</b>	Indicated on the rear of the TV.	
<b>Television system</b>	B/G, I, D/K, M	
<b>Color system</b>	PAL, PAL 60, SECAM, NTSC4.43, NTSC3.58	
<b>Available language for Teletext</b>	English, Farsi, French	
<b>Stereo/Bilingual system</b>	NICAM Stereo/Bilingual D/K, I, B/G; A2 Stereo/Bilingual (German) B/G	
<b>Channel coverage</b>	VHF : E2 to E12 / UHF : E21 to E69 / CATV : S01 to S03, S1 to S41 VHF : 0 to 12, 5A, 19A / UHF : 28 to 69 / CATV : S01 to S03, S1 to S41 (Australia only) VHF : 1 to 11 / UHF : 21 to 69 / CATV : S01 to S03, S1 to S41 (New Zealand only)	
<b>B/G</b>		
<b>I</b>	UHF : B21 to B68 / CATV : S01 to S03, S1 to S41	
<b>D/K</b>	VHF : C1 to C12, R1 to R12 / UHF : C13 to C57, R21 to R60 / CATV : S01 to S03, S1 to S41, Z1 to Z39	
<b>M</b>	VHF : A2 to A13 / UHF : A14 to A79 / CATV : A-8 to A-2, A to W+4, W+6 to W+84	
<b>⌋ (Antenna)</b>	75-ohm external terminal	
<b>Audio output (Speaker)</b>	7.5W + 7.5W	
<b>3D Woofer</b>	15W	
<b>Number of terminal</b>		
<b>Ⓜ (Video)</b>	Input: 4	Output: 1 Phono jacks; 1 Vp-p, 75 ohms
<b>♪ (Audio)</b>	Input: 6	Output: 1 Phono jacks; 500 mVrms
<b>Ⓜ (S Video)</b>	Input: 2	Y: 1 Vp-p, 75 ohms, unbalanced, sync negative C: 0.286 Vp-p, 75 ohms
<b>Ⓜ (Component Video)</b>	Input: 2	Phono jacks Y: 1 Vp-p, 75 ohms, sync negative P <sub>B</sub> /C <sub>B</sub> : 0.7 Vp-p, 75 ohms P <sub>R</sub> /C <sub>R</sub> : 0.7 Vp-p, 75 ohms Audio: 500 mVrms
<b>Ⓜ (G/B/R/HD/VD Video)</b>	Input: 1	Phono jacks G: 0.7 Vp-p, 75 ohms, B: 0.7 Vp-p, 75 ohms, R: 0.7 Vp-p, 75 ohms HD: 0.7 Vp-p, 75 ohms, VD: 0.7 Vp-p, 75 ohms
<b>⌋ ← c- (Center Speaker)</b>	Input: 1	120 W max., 8 ohms
<b>🎧 (Headphones)</b>	Output: 1	Stereo minijack
<b>Picture tube</b>	36in.	32in.
<b>Tube size (cm) (measured diagonally)</b>	93	81
<b>Screen size (cm) (measured diagonally)</b>	86	76
<b>Dimensions (w/h/d, mm)</b>	994 × 652 × 605	898 × 607 × 563
<b>Mass (kg)</b>	88	69

Design and specifications are subject to change without notice.

<http://www.sony.net/>

Printed in Japan. Download from [www.Somanuals.com](http://www.Somanuals.com). All Manuals Search And Download.

## Free Manuals Download Website

<http://myh66.com>

<http://usermanuals.us>

<http://www.somanuals.com>

<http://www.4manuals.cc>

<http://www.manual-lib.com>

<http://www.404manual.com>

<http://www.luxmanual.com>

<http://aubethermostatmanual.com>

Golf course search by state

<http://golfingnear.com>

Email search by domain

<http://emailbydomain.com>

Auto manuals search

<http://auto.somanuals.com>

TV manuals search

<http://tv.somanuals.com>