

SERVICE MANUAL

BG-3S CHASSIS

<u>MODEL</u>	<u>COMMANDER</u>	<u>DEST.</u>	<u>CHASSIS NO.</u>	<u>MODEL</u>	<u>COMMANDER</u>	<u>DEST.</u>	<u>CHASSIS NO.</u>
<i>KV-PF21M70</i>	<i>RM-952</i>	<i>Hong Kong</i>	<i>SCC-U17H-A</i>				
<i>KV-TF21M61</i>	<i>RM-952</i>	<i>Singapore</i>	<i>SCC-U29A-A</i>				
<i>KV-TF21M90</i>	<i>RM-952</i>	<i>Hong Kong</i>	<i>SCC-U17G-A</i>				
<i>KV-TF21P11</i>	<i>RM-952</i>	<i>OCE</i>	<i>SCC-U24C-A</i>				

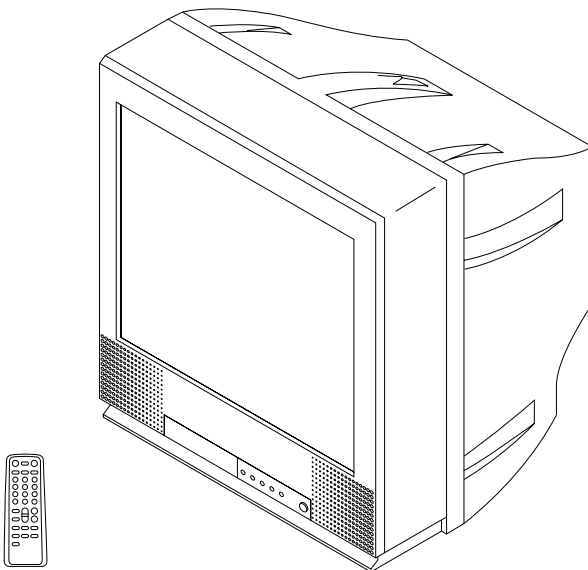

(KV-TF21M61)
(KV-TF21M90)
(KV-TF21P11)

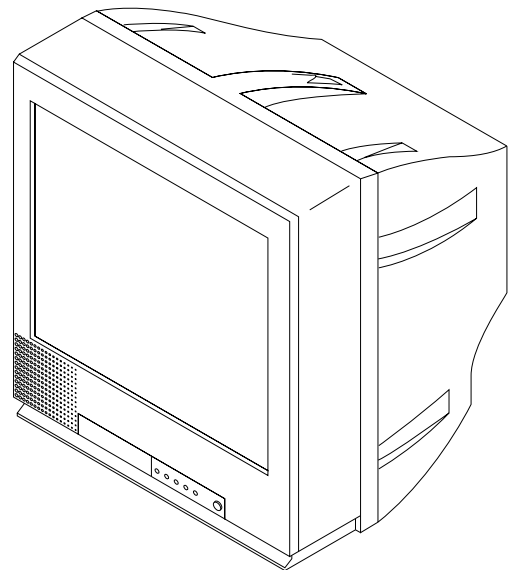

(KV-PF21M70)



TRINITRON® COLOR TV
SONY®

SPECIFICATIONS

		Note
Power requirements	110-240 V AC, 50/60 Hz	KV-TF21M61
	110-220V AC, 50/60Hz	KV-PF21M70
	220-240V AC, 50/60Hz	KV-TF21M90/TF21P11
Power consumption (W)	Indicated on the rear of the TV	
Television system	B/G, I, D/K, M	Except KV-TF21P11
	B/G	KV-TF21P11
Color system	PAL, PAL60, SECAM, NTSC4.43, NTSC3.58	Except KV-TF21P11
	PAL, PAL60, NTSC4.43, NTSC3.58 (AV IN)	KV-TF21P11
Stereo/Bilingual system	NICAM Stereo/Bilingual B/G, I; A2 Stereo/Bilingual (German) B/G	KV-TF21M61/TF21M90 only
Teletext language	English, Arabic, French	KV-TF21M61/TF21P11 only
Channel coverage B/G	VHF : E2 to E12/ UHF : E21 to E69/ CATV : S01 to S03, S1 to S41	
	VHF : 0 to 12, 5A, 9A UHF : 28 to 69 CATV : S01 to S03, S1 to S41	Australia only
	VHF : 1 to 11 UHF : 21 to 69 CATV : S01 to S03, S1 to S41	New Zealand only
	I	UHF : B21 to B68/ CATV : S01 to S03, S1 to S41
D/K	VHF : C1 to C12, R1 to R12/ UHF : C13 to C57, R21 to R60 CATV: Z1 to Z39, S01 to S03, S1 to S41	
M	VHF : A2 to A13/ UHF : A14 to A79/ CATV : A-8 to A-2, A to W+4, W+6 to W+84	
⌚ (Antenna)	75-ohm external terinal	
Audio output	3W + 3W	KV-TF21M61/TF21M90
	3W	KV-PF21M70/TF21P11
Number of terminal 📺 (Video)	Input : 3 Output : 1 Phono jacks; 1 Vp-p, 75 ohms	Except KV-TF21P11
	Input : 2 Output : 1 Phono jacks; 1 Vp-p, 75 ohms	KV-TF21P11
🎵 (Audio)	Input : 3 Output : 1 Phono jacks; 500 mVrms	Except KV-TF21P11
	Input : 2 Output : 1 Phono jacks; 500 mVrms	KV-TF21P11
🎧 (Earphone)	Output : 1 Minijack	KV-PF21M70/TF21P11
🎧 (Headphone)	Output : 1 Minijack	KV-TF21M61/TF21M90
Picture tube	21 inch	
Tube size (cm)	54	Measured diagonally
Screen size (cm)	51	Measured diagonally
Dimension (w/h/d, mm)	490 x 458 x 487	
Mass (kg)	28	

Design and specifications are subject to change without notice.

CAUTION

SHORT CIRCUIT THE ANODE OF THE PICTURE TUBE AND THE ANODE CAP TO THE METAL CHASSIS, CRT SHIELD, OR CARBON PAINTED ON THE CRT, AFTER REMOVING THE ANODE.

SAFETY-RELATED COMPONENT WARNING!!

COMPONENTS IDENTIFIED BY SHADING AND MARK \triangle ON THE SCHEMATIC DIAGRAMS, EXPLODED VIEWS AND IN THE PARTS LIST ARE CRITICAL TO SAFE OPERATION. REPLACE THESE COMPONENTS WITH SONY PARTS WHOSE PART NUMBERS APPEAR AS SHOWN IN THIS MANUAL OR IN SUPPLEMENTS PUBLISHED BY SONY. CIRCUIT ADJUSTMENTS THAT ARE CRITICAL TO SAFE OPERATION ARE IDENTIFIED IN THIS MANUAL. FOLLOW THESE PROCEDURES WHENEVER CRITICAL COMPONENTS ARE REPLACED OR IMPROPER OPERATION IS SUSPECTED.

TABLE OF CONTENTS

<u>Section</u>	<u>Title</u>	<u>Page</u>	<u>Section</u>	<u>Title</u>	<u>Page</u>
	SELF DIAGNOSIS FUNCTION	3	5. DIAGRAMS		
1. GENERAL		8	5-1	Block Diagram	59
2. DISASSEMBLY			5-2	Frame Schematic Diagram	62
2-1.	Rear Cover Removal	32	5-3	Circuit Boards Location	64
2-2.	Chassis Assy Removal	32	5-4	Schematic Diagrams and Printed Wiring Boards ...	65
2-3.	F Bracket Removal	32	(1)	Schematic Diagram of A(1/2) Board	67
2-4.	Service Position	33	(2)	Schematic Diagram of A(2/2) Board	71
2-5.	Replacement of Parts	33	(3)	Schematic Diagrams of C3 and C5 Boards	79
2-5-1.	Replacement of Control Button	33	(4)	Schematic Diagram of V1 Board	85
2-5-2.	Replacement of Bar Control	33	(5)	Schematic Diagram of F Board	87
2-6.	Terminal Bracket Removal	33	5-5	Semiconductors	90
2-7.	Degauss Coil Removal	34	6. EXPLODED VIEWS		
2-8.	Picture Tube Removal	34	6-1.	Chassis (KV-PF21M70)	93
3. SET-UP ADJUSTMENTS			6-2.	Chassis (KV-TF21M61/TF21M90/TF21P11)	95
3-1.	Beam Landing	36	7. ELECTRICAL PARTS LIST		97
3-2.	Convergence	37			
3-3.	Focus Adjustment	39			
3-4.	G2 (Screen) and White Balance Adjustments	39			
4. CIRCUIT ADJUSTMENTS					
4-1.	Adjustments with Commander	40			
4-2.	Adjustment Method	41			
4-3.	Picture Quality Adjustments	46			
4-4.	A Board Adjustment After IC003 (Memory) Replacement	46			
4-5.	Picture Distortion Adjustment	47			

SELF DIAGNOSTIC FUNCTION

The units in this manual contain a self-diagnostic function. If an error occurs, the STANDBY/TIMER lamp will automatically begin to flash.

The number of times the lamp flashes translates to a probable source of the problem. A definition of the STANDBY/TIMER lamp flash indicators is listed in the instruction manual for the user's knowledge and reference. If an error symptom cannot be reproduced, the remote commander can be used to review the failure occurrence data stored in memory to reveal past problems and how often these problems occur.

1. DIAGNOSTIC TEST INDICATORS

When an errors occurs, the STANDBY/TIMER lamp will flash a set number of times to indicate the possible cause of the problem. If there is more than one error, the lamp will identify the first of the problem areas.

Result for all of the following diagnostic items are displayed on screen. No error has occurred if the screen displays a "0".

Diagnostic Item Description	No. of times STANDBY/TIMER lamp flashes	Self-diagnostic display/Diagnostic result	Probable Cause Location	Detected Symptoms
• Power does not turn on	Does not light	—	<ul style="list-style-type: none"> • Power cord is not plugged in. • Fuse is burned out F4601 (F Board) 	<ul style="list-style-type: none"> • Power does not come on. • No power is supplied to the TV. • AC power supply is faulty.
<ul style="list-style-type: none"> • +B overcurrent (OCP) or overvoltage (OVP) • Vertical deflection stopped • Horizontal deflection overdrive 	2 times	002:000 or 002:001~255 003:001~255 004:001~255 at the same time	<ul style="list-style-type: none"> • H.OUT Q511 is shorted. (A board) • IC1800 is shorted. (C5 board (except PF21M70)/ (C3 Board (KV-PF21M70))). • -13V is not supplied. (A board) • IC 503 faulty (A board) • IC 301 faulty (A board) 	<ul style="list-style-type: none"> • Power does not come on. • Load on power line is shorted. • Has entered standby state after horizontal raster. • Vertical deflection pulse is stopped. • Power line is shorted or power supply is stopped.
• White balance failure (no PICTURE)	5 times	005:000 or 005:001~225	<ul style="list-style-type: none"> • G2 is improperly adjusted. (Note 2) • CRT problem. • Video OUT IC701 is faulty. (C5 board) • IC301 is faulty. (A board) • No connection A board to C5/C3 boards. 	<ul style="list-style-type: none"> • No raster is generated. • CRT cathode current detection reference pulse output is small.
• Micro reset	—	101:00 or 101:001~225	<ul style="list-style-type: none"> • Discharge CRT (C5/C3 Boards) • Static discharge • External noise 	<ul style="list-style-type: none"> • Power is shut down shortly, after this return back to normal. • Detect Micro latch up.

Note 1: If a + B overcurrent is detected, stoppage of the vertical deflection is detected simultaneously.

The symptom that is diagnosed first by the microcontroller is displayed on the screen.

Note 2: Refer to screen (G2) Adjustment in section 3-4 of this manual.

2. DISPLAY OF STANDBY/TIMER LIGHT FLASH COUNT

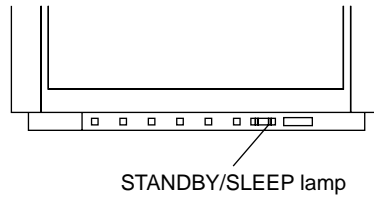
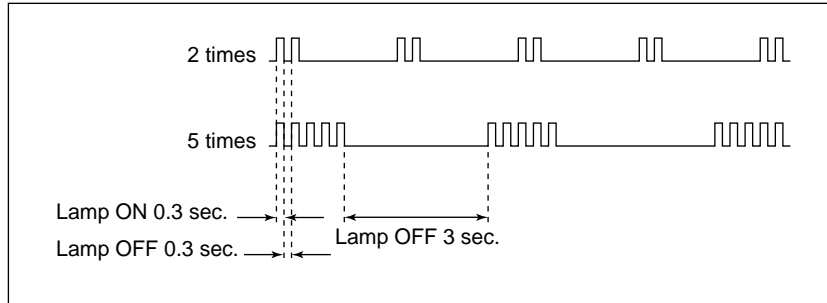

<u>Diagnostic Item</u>	<u>Flash Count*</u>
+B overcurrent/overvoltage Vertical deflection stopped	2 times
White balance failure	5 times

* One flash count is not used for self-diagnostic.

3. STOPPING THE STANDBY/TIMER FLASH

Turn off the power switch on the TV main unit or unplug the power cord from the outlet to stop the STANDBY/TIMER lamp from flashing.

4. SELF-DIAGNOSTIC SCREEN DISPLAY

For errors with symptoms such as “power sometimes shuts off” or “screen sometimes goes out” that cannot be confirmed, it is possible to bring up past occurrences of failure for confirmation on the screen:

[To Bring Up Screen Test]

In standby mode, press buttons on the remote commander sequentially in rapid succession as shown below:

Screen display → channel [5] → Sound volume [−] → Power ON



Note that this differs from entering the service mode (mode volume [+]).

Self-Diagnosis screen display

SELF DIAGNOSTIC	
002 : 000 ←	
003 : 000	
004 : 000	
005 : 001 ←	
101 : 000	

Numeral "0" means that no fault has been detected.

Numeral "1" means a fault has been detected.

5. HANDLING OF SELF-DIAGNOSTIC SCREEN DISPLAY

Since the diagnostic results displayed on the screen are not automatically cleared, always check the self-diagnostic screen during repairs. When you have completed the repairs, clear the result display to “0”.

Unless the result display is cleared to “0”, the self-diagnostic function will not be able to detect subsequent faults after completion of the repairs.

[Clearing the result display]

To clear the result display to “0”, press buttons on the remote commander sequentially as shown below when the diagnostic screen is being displayed.

Channel [8] → 0

[Quitting Self-diagnostic screen]

To quit the entire self-diagnostic screen, turn off the power switch on the remote commander or the main unit.

6. SELF-DIAGNOSTIC CIRCUIT

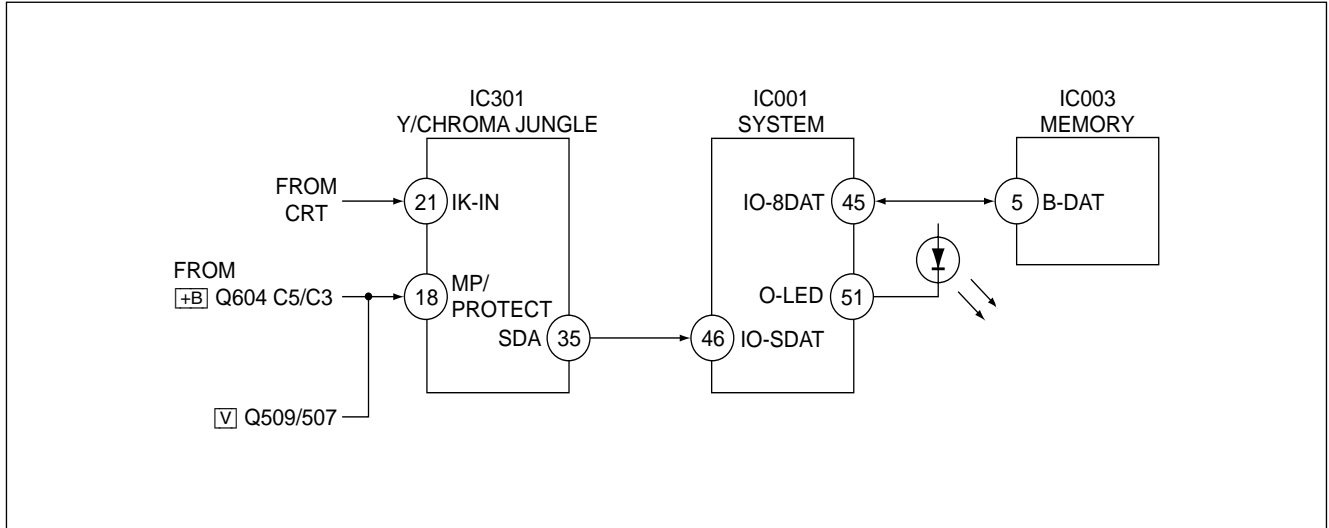

+B overcurrent (OCP)

Occurs when an overcurrent on the +B(135) line is detected by Q604. If Q604 go to ON and the voltage to pin 18 of IC301 should go down when V.SYNC is more than seven verticals in a period, the unit will automatically turn off.

Vertical deflection stopped

Occurs when an absence of the vertical deflection pulse is detected by Q509 and IC001 shut down the power supply.

Vertical deflection overcurrent

Occurs when an overcurrent on V drive line is detected by Q507. Power supply will be shut down when detect this by IC001.

White balance failure

If the RGB levels* do not balance or become low level within 5 seconds, this error will be detected by IC301. TV will stay on, but there will be no picture.

* (Refers to the RGB levels of the AKB detection Ref pulse that detects IK.)

The operating instructions mentioned here are partial abstracts from the Operating Instruction Manual. The page numbers of the Operating Instruction Manual remain as in the manual.

SECTION 1 GENERAL (KV-PF21M70)

WARNING

- Dangerously high voltages are present inside the TV.
- TV operating voltage: 110 – 240 V AC. (For Hong Kong only: 220 – 240 V AC.)

Using Your New TV

Getting Started

Step 1

Connect the antenna

If you wish to connect a VCR, see the "Connecting a VCR" diagram below.

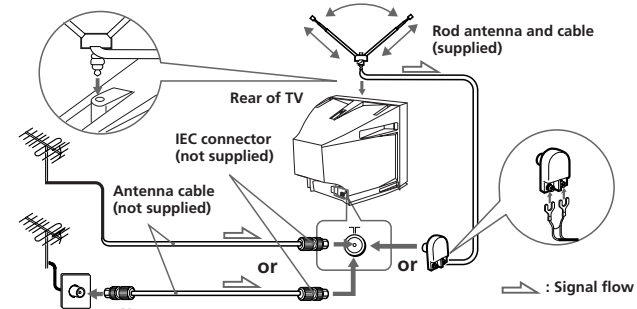

Note
• You are advised to use an outdoor antenna for better reception.

Connecting a VCR

To watch the video, press (see page 12).

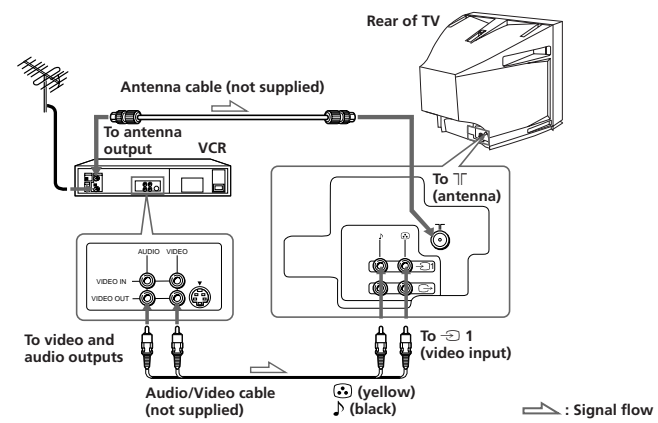

Notes

- If you connect a stereo VCR, connect the yellow plug to (the yellow jack) and the white plug to (the black jack).
- If you connect a VCR to the (antenna) terminal, preset the signal output from the VCR to the program number 0 on the TV.
- When no signal is input to the connected video equipment, the TV screen becomes blue.

CAUTION

Do not connect the power cord until you have completed making all other connections; otherwise a minimum leakage current might flow through the antenna and other terminals to ground.

Step 2

Insert the batteries into the remote

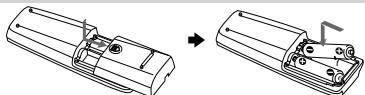

Note

- Do not use old batteries nor use different types of batteries together.

Step 3

Preset the channels automatically

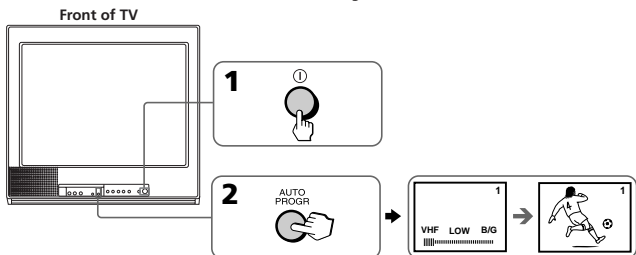

Tips

- If you want to stop automatic channel presetting, press SELECT twice.
- If your TV has preset an unwanted channel or cannot preset a particular channel, then preset your TV manually (see page 9).

Note

- During automatic channel presetting, your TV screen will indicate "B/G", "I", "D/K" or "M" for the TV system.

Now You Are Ready. . .

To watch your TV, see page 11.



Connecting optional components

You can connect optional video components, such as a VCR, multi disc player, camcorder or video game.

To watch the picture of the connected equipment, press (see page 12).

Connecting a camcorder/video game equipment using the (video input) jacks

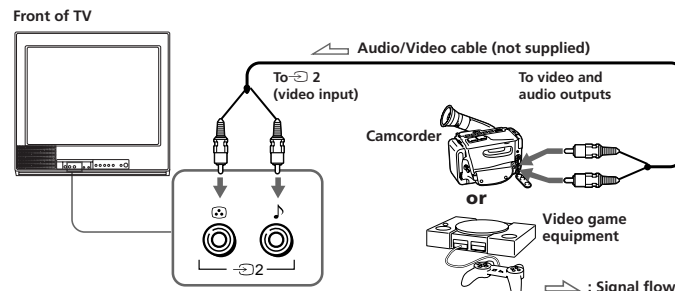

Note

- You can also connect video equipment to the (video input) jacks at the rear of your TV.

Connecting video equipment using the (monitor output) jacks

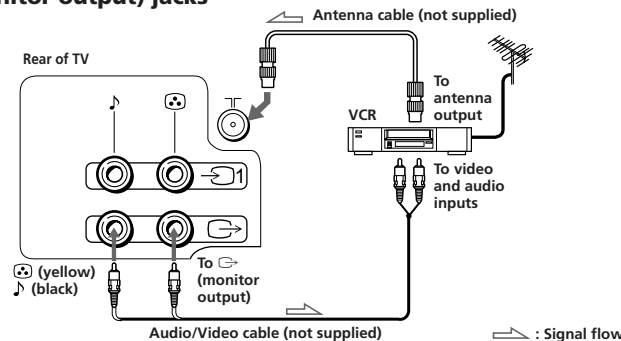

Note

- When connecting a stereo VCR, connect the yellow plug to (the yellow jack) and the white plug to (the black jack).

Securing the TV

To prevent the TV from falling, secure the TV using one of the following methods:

A With the supplied screws, attach the band to the TV stand and to the rear of the TV using the provided hole.

or

B Put the cord or chain through the clamps to secure the TV against a wall or pillar.

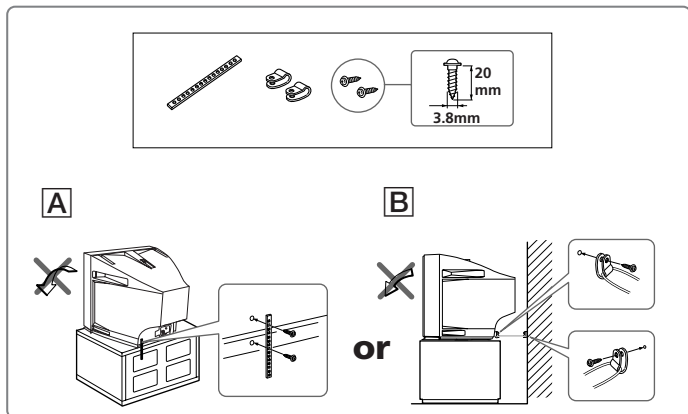

Note

- Use only the supplied screws. Use of other screws may damage the TV.

Using Your New TV

Presetting channels

You can preset up to 100 TV channels in numerical sequence from program number 1 using the remote and the buttons on your TV as well.

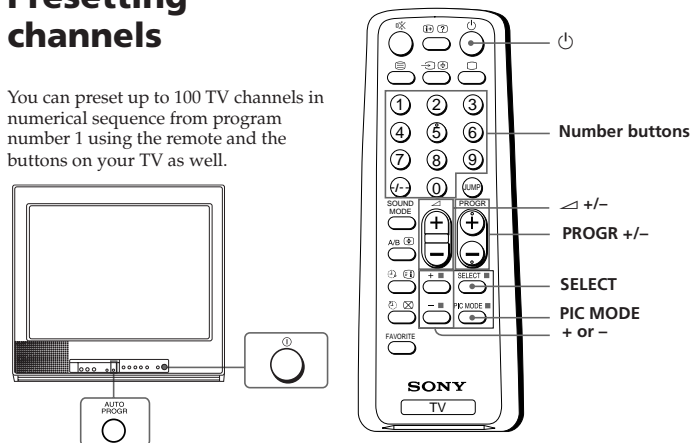

Presetting channels automatically

1 Press ① to turn on the TV.



2 Press AUTO PROGRAM.



VHF LOW B/G





Note

- During automatic channel presetting, your TV screen will indicate "B/G", "I", "D/K" or "M" for the TV system.

To preset channels automatically from a specified program number

- (1) Press SELECT until "AUTO PROGRAM" appears.
- (2) Press + or -.
The on-screen display will start flashing.
- (3) Press PROGR +/- or the number buttons until the desired program number appears.
- (4) Press + or -.

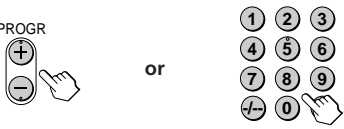

Presetting channels manually

- 1 Press SELECT until "MANUAL PROGRAM" appears.
 
- 2 Press + or -.
 
- 3 Press PROGR +/- or the number buttons until the desired program number appears.
 
- 4 Press + or - until the desired channel picture appears.
 
- 5 Press SELECT.
 

Using Your New TV

To change the color system setting

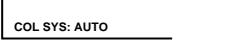
If the color is abnormal when receiving programs through the ㄒ (antenna) terminal or the ㊄ (video input) jack

- (1) Press SELECT until "COL SYS" appears.
 
- (2) Press + or - to select the appropriate color system until the color is optimal.
 

Tip

- Normally set "COL SYS" to "AUTO".

Note

- The color system "SECAM" is not available.
The color system "NTSC3.58" is available.

continued

Using Your New TV | 9

Presetting channels (continued)

To change the TV system setting

If the picture or sound is abnormal when receiving programs through the ㄒ (antenna) terminal

- (1) Press SELECT until "TV SYS" appears.
 

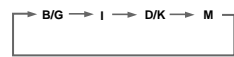
- (2) Press + or - to select the appropriate TV system until the picture or sound quality is optimal.
 

Skipping program numbers

- 1 Press PROGR +/- or the number buttons until the unused or unwanted program number appears.
- 2 Press SELECT until "MANUAL PROGRAM" appears.
- 3 Press + or -.
- 4 Press PIC MODE.
- 5 Press SELECT.

To preset the skipped program number again

Preset the channel automatically or manually.

Tip

- You can also use SELECT and ㄱ +/- on the TV to preset channels and skip program numbers.

To use the fine tuning (FINE) function

The fine tuning (FINE) function may help to reduce the following problems: double images and lines moving across the TV screen.

You can use the fine tuning function as below:

- (1) Select the program number you want to adjust.
- (2) Press SELECT until "MANUAL PROGRAM" appears on the screen.
- (3) Press + or - on the remote control once.
- (4) Press ㊄ ㊄ to display "FINE" on the screen.
- (5) Press + or - continuously until the above problems are minimized.
The + or - icon on the screen flashes while tuning.
- (6) Press SELECT to return to normal screen.

10 | Using Your New TV

Watching the TV

This section explains functions used while watching the TV. Most operations can be done using the remote.

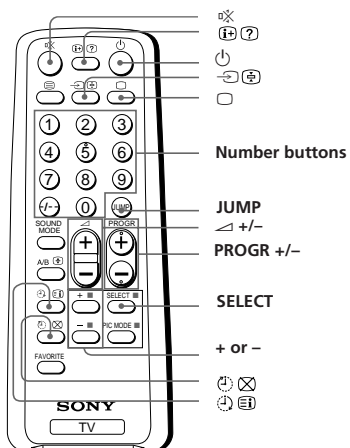
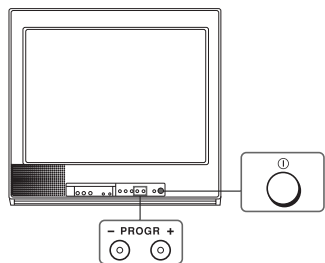

Using Your New TV

1 Press to turn on the TV.

When the TV is in the standby mode (the indicator on the TV is lit red), press on the remote or PROGR +/- on the TV.



2 Press PROGR +/- or the number buttons to select the TV program.

For double digit numbers, press +/-, then the number (e.g., for 25, press +/-, then 2 and 5).

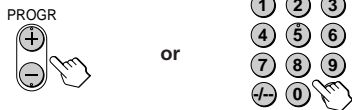

3 Press to adjust the volume.



Watching the TV (continued)

Additional tasks

To	Do this
Turn off temporarily	Press . The indicator on the TV lights up red.
Turn off completely	Press on the TV.
Mute the sound	Press .
Watch the video input (VCR, camcorder, etc.)	Press to select "VIDEO 1" or "VIDEO 2". To return to the TV program, press .
Jump back to the previous channel	Press JUMP.
Display the on-screen information*	Press .
Adjust the volume of each TV program automatically	Press SELECT repeatedly until "INTELLIGENT VOL" appears, then press + or - to select "ON". To cancel, select "OFF".

* The picture, sound, and either the program number or video mode are displayed. The on-screen display for the picture and sound information disappears after about 3 seconds.

Changing the on-screen display language

1 Press SELECT until "LANGUAGE / 语言:" ENGLISH" appears on the screen.



2 Press + or - to select "中文".



Tip

- You can also use SELECT and +/- on the TV to select the on-screen display language.

continued

Setting the Wake Up timer

1 Press until the desired period of time appears.

2 Select the TV program or video mode you want to display when you wake up.

3 Press or set the Sleep timer if you want the TV to turn off automatically.

The indicator on the TV lights up orange.

To cancel the Wake Up timer

Press until "WAKE UP TIMER: OFF" appears or turn off the TV's main power.

Notes

- The Wake Up timer starts immediately after the on-screen display disappears.
- If no buttons or controls are pressed for more than two hours after the TV is turned on using the Wake Up timer, the TV automatically goes into the standby mode. To continue watching the TV, press any button or control on the TV or the remote.

Setting the Sleep timer

Press until the desired period of time appears.

To cancel the Sleep timer

Press until "SLEEP TIMER: OFF" appears or turn the TV off.

Advanced Operations

Customizing the picture and sound

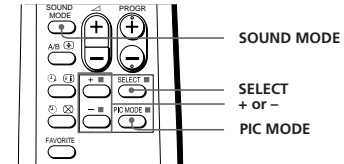

You can customize the picture and sound by selecting the picture and sound modes or by adjusting its settings.

You can change the sound effect by selecting the surround mode.

Selecting the picture and sound modes

To select the picture mode

Press PIC MODE repeatedly until you get the desired picture mode.

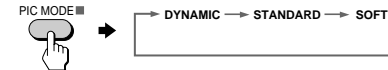

Select	To
DYNAMIC	receive high contrast pictures.
STANDARD	receive normal contrast pictures.
SOFT	receive mild pictures.

To select the sound mode

Press SOUND MODE repeatedly until you get the desired sound mode.



Select	To
DYNAMIC	listen to dynamic and clear sound that emphasizes the low and high sound.
DRAMA	listen to sound that emphasizes vocals and background music.
SOFT	receive soft sound.

Adjusting the picture and sound settings

- 1 Press SELECT until the desired setting appears.



Each time you press SELECT, the setting item will change as follows:

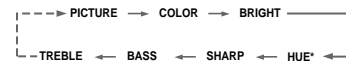

- 2 Press + or - to adjust the item.



- 3 To adjust other items, repeat steps 1 to 2.

* "HUE" can be adjusted for the NTSC system only.

Notes

- When you select a picture or sound mode, the adjusted settings will be reset according to the selected mode.
- You can also use SELECT and Δ +/- on the TV to adjust the picture and sound settings.

Advanced Operations

Blocking the channels (CHILD LOCK)

You can prevent a child from watching certain programs by using the buttons on the remote control.

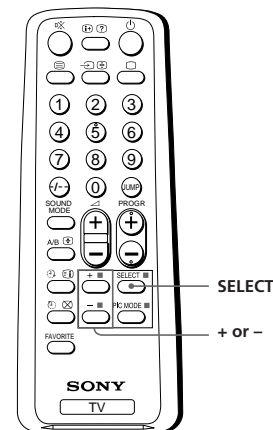

- 1 Select the TV program you want to lock.

- 2 Press SELECT until "CHILD LOCK" appears on the screen.

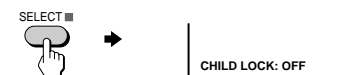

- 3 Press + or - to select "ON".

The symbol appears on the screen.

To unlock the channel, press + or - to select "OFF". The symbol disappears from the screen.

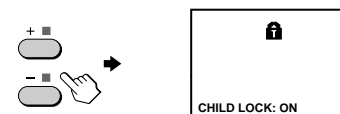



Note

- If you preset a locked channel, that particular channel will be unlocked automatically.





Additional Information

Self-diagnosis function

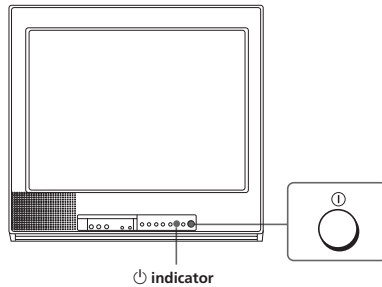
Your TV is equipped with a self-diagnosis function. If there is a problem with your TV, the  indicator flashes red. The number of times the  indicator flashes indicates the possible causes.

Front of TV











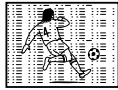

- 1 Check that the  indicator flashes red a number of times between 3-second intervals.
- 2 Count the number of times the  indicator flashes.
- 3 Press  (main power) to turn off your TV.
- 4 Inform your nearest Sony service center about the number of times the  indicator flashes. Be sure to note the model name and serial number located on the rear of your TV.

Additional Information



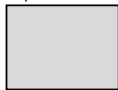



Additional Information | 17

Troubleshooting

If you find any problem while viewing your TV, please check the following guide. If any problem persists, contact your Sony dealer .

Symptom	Solutions	Possible cause
Snowy picture 	<ul style="list-style-type: none"> Check the antenna cable and connection on the TV, VCR and on the wall. (page 4) Press SELECT until "MANUAL PROGRAM" appears on the screen then preset the channel again. (page 9) 	<ul style="list-style-type: none"> Connection is loose or the cable is damaged. Channel presetting is inappropriate or incomplete.
Noisy sound 	<ul style="list-style-type: none"> Check the antenna type (VHF/UHF). Contact a Sony dealer for advice. Adjust the antenna direction. Contact a Sony dealer for advice. Try using a booster. 	<ul style="list-style-type: none"> The antenna type is inappropriate. The antenna direction is inappropriate. Signal transmission is low.
Distorted picture 	<ul style="list-style-type: none"> Turn off or disconnect the booster if it is in use. 	<ul style="list-style-type: none"> Broadcast signals are too strong.
Noisy sound 		
Good picture 	<ul style="list-style-type: none"> If the sound of all the channels are noisy, check the TV system (TV SYS) setting (page 10), then press AUTO PROGR to preset the channels again (page 8). If the sound of some channels are noisy, select the channel, then select the appropriate TV system (TV SYS). (page 10) 	<ul style="list-style-type: none"> The TV system setting or channel presetting is inappropriate or incomplete.
Noisy sound 		
No picture 	<ul style="list-style-type: none"> Check the power cord, antenna and the VCR connections. Press  (power). Press  (main power) on the TV to turn off the TV for about five seconds, then turn it on again. 	<ul style="list-style-type: none"> The power cord, antenna or VCR is not connected. The TV is not turned on.
No sound 		

Additional Information | 18

Symptom	Solutions	Possible cause
Good picture 	<ul style="list-style-type: none"> Press \triangleleft + to increase the volume level. Press \otimes to cancel the muting. 	<ul style="list-style-type: none"> The volume level is too low. The sound is muted.
No sound 		
Dotted lines or stripes 	<ul style="list-style-type: none"> Do not use a hair dryer or other equipment near the TV. Adjust the antenna direction for minimum interference. Contact a Sony dealer for advice. 	<ul style="list-style-type: none"> There is local interference from cars, neon signs, hair dryers, power generators, etc.
Double images or "ghosts" 	<ul style="list-style-type: none"> Use a highly directional antenna. Use the fine tuning (FINE) function. (page 10) Adjust the antenna direction. Contact a Sony dealer for advice. Turn off or disconnect the booster if it is in use. 	<ul style="list-style-type: none"> Broadcast signals are reflected by nearby mountains or buildings. The antenna direction is inappropriate. Use of a booster is inappropriate.
No color 	<ul style="list-style-type: none"> Press SELECT until "COLOR" appears on the screen, then press + or - to adjust the color level. (page 15) Press SELECT until "COL SYS" appears on the screen, then check the color system setting (usually set this to "AUTO"). (page 9). Adjust the antenna direction. Contact a Sony dealer for advice. 	<ul style="list-style-type: none"> The color level setting is too low. The color system setting is inappropriate. The antenna direction is inappropriate.
Abnormal color patches 	<ul style="list-style-type: none"> Keep external speakers or other electrical equipment away from the TV. Do not move the TV while the TV is turned on. Press O (main power) on the TV to turn off the TV for about five minutes, then turn it on again. 	<ul style="list-style-type: none"> The magnetic disturbance from external speakers or other equipment, or the direction of the earth's magnetic field may affect the TV.

Troubleshooting (continued)

Symptom	Solutions	Possible cause
Lines moving across the TV screen.	<ul style="list-style-type: none"> Use the fine tuning (FINE) function. (page 10) 	<ul style="list-style-type: none"> There is interference from external sources, e.g., heavy machineries, nearby broadcast station.
The O indicator on your TV flashes red a number of times between 3-second intervals.	<ul style="list-style-type: none"> Contact your nearest Sony service center. (page 17) 	<ul style="list-style-type: none"> Your TV may need service.
TV cabinet creaks.	—	<ul style="list-style-type: none"> Changes in room temperature sometimes make the TV cabinet expand or contract, making a noise. This does not indicate a malfunction.
A "boom" sound is heard when the TV is turned on.	—	<ul style="list-style-type: none"> The TV's demagnetizing function is working. This does not indicate a malfunction.

continued

Identifying parts and controls

Refer to the pages indicated in parentheses () for details.

Front panel

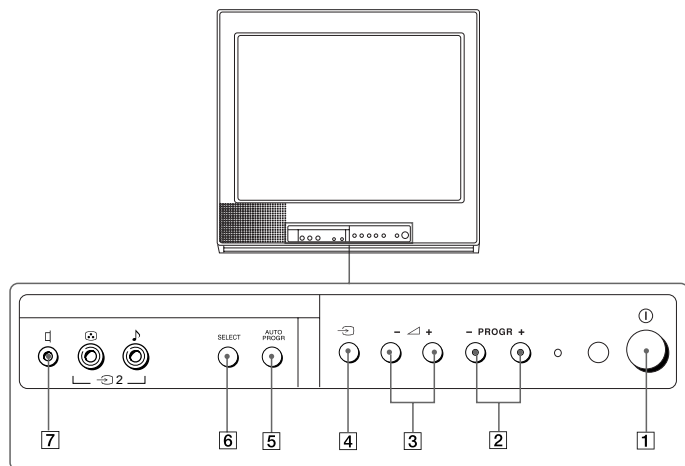

- 1 ① (main power) button (5)
- 2 PROGR +/- (program) buttons (11)
- 3 \triangle +/- (volume) buttons (11)
- 4 \rightarrow (TV/video) button (12)
- 5 AUTO PROGR (program) button (5)
- 6 SELECT button (9)
- 7 \square (earphone) jack

Identifying parts and controls (continued)

Remote Control

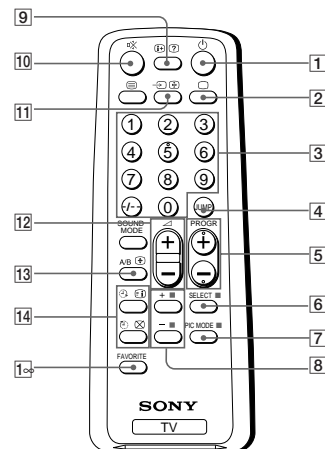

- 1 ⏻ (power) button (11)
- 2 \square (TV) button (12)
- 3 Number buttons (11)
- 4 JUMP button (12)
- 5 PROGR +/- buttons (11)
- 6 SELECT button (9)
- 7 PIC MODE button (14)
- 8 + or - buttons (9)
- 9 Ⓜ (display) button (12)
- 10 ⓧ (muting) button (12)
- 11 Ⓜ (video) button (12)
- 12 \triangle +/- (volume) buttons (11)
- 13 A/B button
(not used for this model)
- 14 Timer setting buttons (13)
 - Ⓜ (wake up timer)
 - Ⓜ (sleep timer)
- 14 FAVORITE button
(not used for this model)

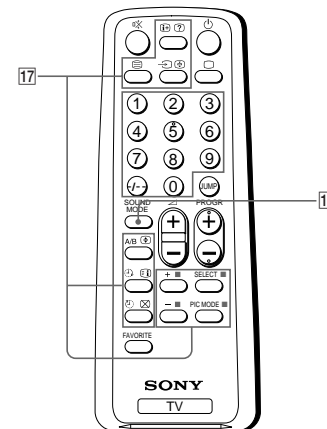

- 16 SOUND MODE button (14)
- 17 Teletext operation buttons
(not used for this model)
 - Ⓜ (text) Ⓜ (enlarge)
 - Ⓜ (reveal) Ⓜ (hold)
 - Ⓜ (index) Ⓜ (text clear)
 - (FASTEXT: red, green, yellow, blue)

Names/symbols of buttons on the remote are indicated in different colors to represent the available functions.

Label color	Button function
White	For general TV operations
Green	For Teletext operations

continued

Additional Information | 21

22 | Additional Information

The operating instructions mentioned here are partial abstracts from the Operating Instruction Manual. The page numbers of the Operating Instruction Manual remain as in the manual.

SECTION 1-2 GENERAL

(KV-TF21M61/TF21M90)

WARNING

- Dangerously high voltages are present inside the TV.
- Operate the TV only between 110 – 240 V AC.

Using Your New TV

Getting Started

Step 1

Connect the antenna

If you wish to connect a VCR, see the "Connecting a VCR" diagram below.

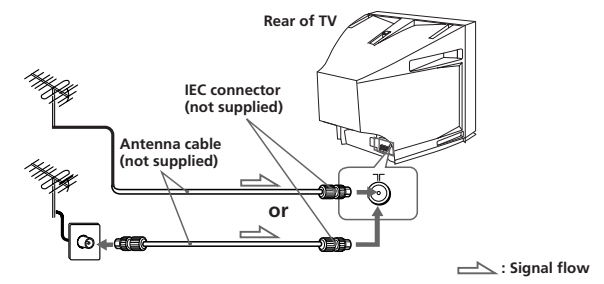

Connecting a VCR

To watch the video, press (see page 12).

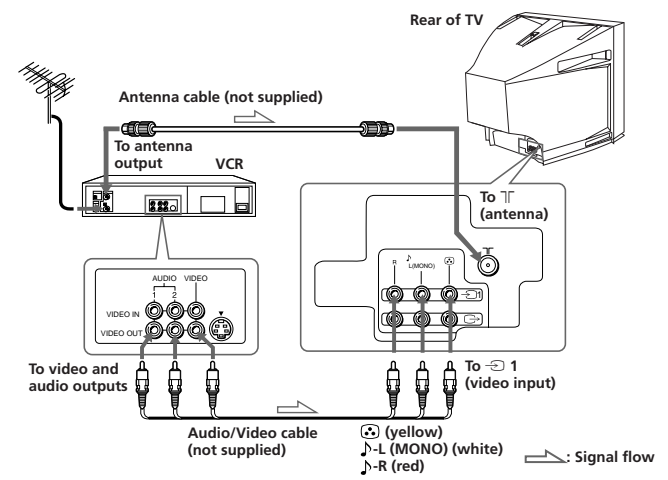

Notes

- If you connect a monaural VCR, connect the yellow plug to (yellow jack) and the black plug to L (MONO) (the white jack).
- If you connect a VCR to the antenna terminal, preset the signal output from the VCR to the program number 0 on the TV.
- When no signal is input to the connected video equipment, the TV screen becomes blue.

CAUTION

Do not connect the power cord until you have completed making all other connections; otherwise a minimum leakage current might flow through the antenna and other terminals to ground.

Step 2

Insert the batteries into the remote

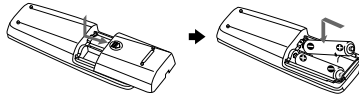

Note

- Do not use old batteries nor use different types of batteries together.

Step 3

Preset the channels automatically

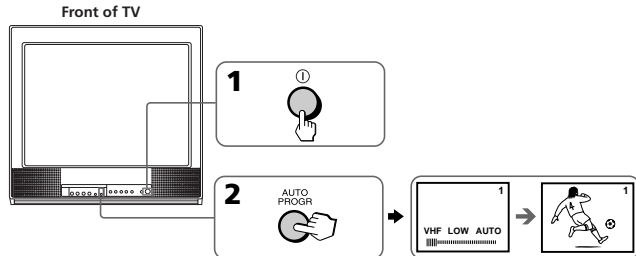

Tips

- If you want to stop automatic channel presetting, press SELECT twice.
- If your TV has preset an unwanted channel or cannot preset a particular channel, then preset your TV manually (see page 9).

Now You Are Ready . . .

To watch your TV, see page 11.



Connecting optional components

You can connect optional audio/video components, such as a VCR, multi disc player, camcorder, video game or stereo system.

To watch the picture of the connected equipment, press (see page 12).

Connecting a camcorder/video game equipment using the (video input) jacks

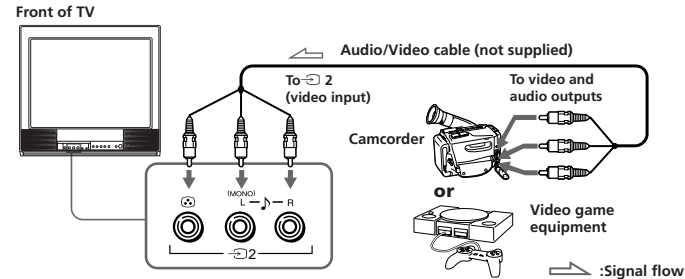

Note

- You can also connect video equipment to the (video input) jacks at the rear of your TV.

Connecting audio/video equipment using the (monitor output) jacks

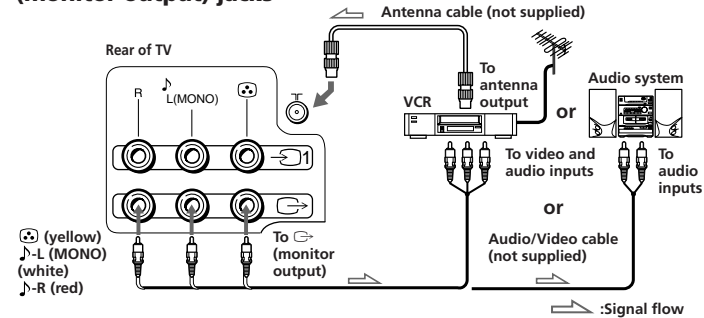

Note

- When connecting a monaural VCR, connect the yellow plug to (the yellow jack) and the black plug to L (MONO) (the white jack).

Securing the TV

To prevent the TV from falling, secure the TV using one of the following methods:

A With the supplied screws, attach the band to the TV stand and to the rear of the TV using the provided hole.

or

B Put the cord or chain through the clamps to secure the TV against a wall or pillar.

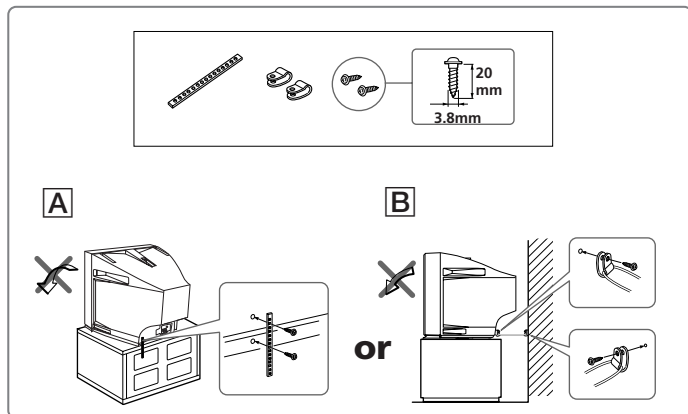

Note

- Use only the supplied screws. Use of other screws may damage the TV.

Using Your New TV

Presetting channels

You can preset up to 100 TV channels in numerical sequence from program number 1 using the remote and the buttons on your TV as well.

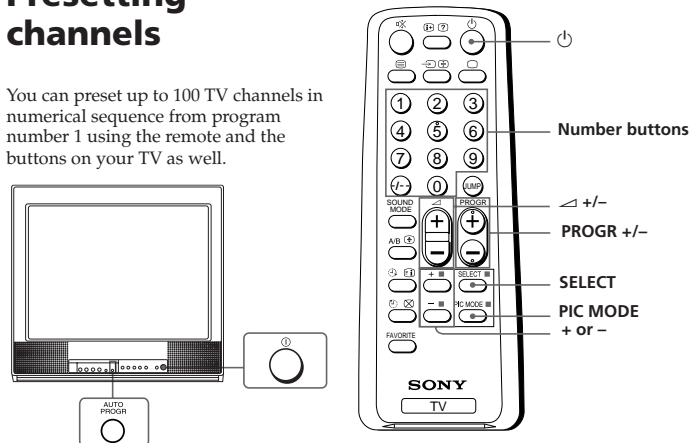

Presetting channels automatically

1 Press $\text{\textcircled{1}}$ to turn on the TV.











2 Press AUTO PROGR.

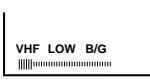

To preset channels automatically from a specified program number

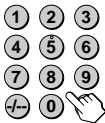
- (1) Press SELECT until "AUTO PROGRAM" appears.
- (2) Press + or -.
The on-screen display will start flashing.
- (3) Press PROGR +/- or the number buttons until the desired program number appears.
- (4) Press + or -.

Presetting channels manually

- 1 Press SELECT until "MANUAL PROGRAM" appears.
  → 
- 2 Press + or -.
  → 
- 3 Press PROGR +/- or the number buttons until the desired program number appears.
  or 
- 4 Press + or - until the desired channel picture appears.
  → 
- 5 Press SELECT.
 

Using Your New TV

To change the TV system setting

If the picture or sound is abnormal when receiving programs through the ㄗ (antenna) terminal

- (1) Press SELECT until "TV SYS" appears.



- (2) Press + or - to select the appropriate TV system until the picture or sound quality is optimal.

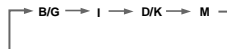

continued

Using Your New TV | 9

Presetting channels (continued)

To change the color system setting

If the color is abnormal when receiving programs through the ㄗ (antenna) terminal or the ㄗ (video input) jack

- (1) Press SELECT until "COL SYS" appears.

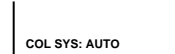

- (2) Press + or - to select the appropriate color system until the color is optimal.

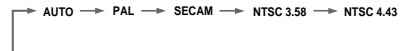

Tip

- Normally set "COL SYS" to "AUTO".

Skipping program numbers

- 1 Press PROGR +/- or the number buttons until the unused or unwanted program number appears.
- 2 Press SELECT until "MANUAL PROGRAM" appears.
- 3 Press + or -.
- 4 Press PIC MODE.
- 5 Press SELECT.

To preset the skipped program number again

Preset the channel automatically or manually.

Tip

- You can also use SELECT and ㄗ +/- on the TV to preset channels and skip program numbers.

To use the fine tuning (FINE) function

The fine tuning (FINE) function may help to reduce the following problems: incomplete Teletext display, double images and lines moving across the TV screen.

You can use the fine tuning function as below:

- (1) Select the program number you want to adjust.
- (2) Press SELECT until "MANUAL PROGRAM" appears on the screen.
- (3) Press + or - on the remote control once.
- (4) Press ㄗ ㄗ to display "FINE" on the screen.
- (5) Press + or - continuously until the above problems are minimized.
 - The + or - icon on the screen flashes while tuning.
- (6) Press SELECT to return to normal screen.

10 | Using Your New TV

Watching the TV

This section explains functions used while watching the TV. Most operations can be done using the remote.

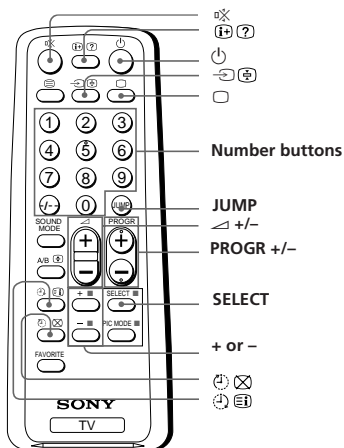
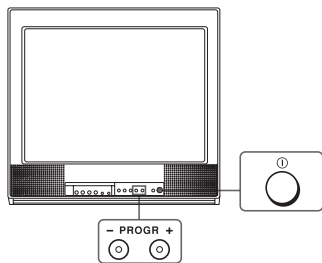

Using Your New TV

1 Press to turn on the TV.

When the TV is in the standby mode (the indicator on the TV is lit red), press on the remote or **PROGR +/-** on the TV.



2 Press **PROGR +/-** or the number buttons to select the TV program.

For double digit numbers, press **-/-**, then the number (e.g., for 25, press **-/-**, then 2 and 5).

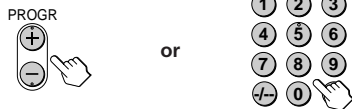

3 Press to adjust the volume.



Watching the TV (continued)

Additional tasks

To	Do this
Turn off temporarily	Press . The indicator on the TV lights up red.
Turn off completely	Press on the TV.
Mute the sound	Press .
Watch the video input (VCR, camcorder, etc.)	Press to select "VIDEO 1" or "VIDEO 2". To return to the TV program, press .
Jump back to the previous channel	Press JUMP .
Display the on-screen information*	Press .
Adjust the volume of each TV program automatically	Press SELECT repeatedly until "INTELLIGENT VOL" appears, then press + or - to select "ON". To cancel, select "OFF".
Adjust the picture position when it is not aligned to the TV screen	Press SELECT repeatedly until "PIC ROTATION" appears, then press + or - to adjust the alignment of the picture position.

PIC ROTATION

The icon on the screen flashes while adjusting.

* The picture, sound, and either the program number or video mode are displayed. The on-screen display for the picture and sound information disappears after about 3 seconds.

Changing the on-screen display language

1 Press **SELECT** until "LANGUAGE / 语言: ENGLISH" appears on the screen.



2 Press **+ or -** to select "中文".



Tip

- You can also use **SELECT** and **+/-** on the TV to select the on-screen display language.

continued

Setting the Wake Up timer

- 1 Press until the desired period of time appears.

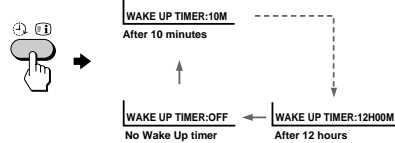

- 2 Select the TV program or video mode you want to display when you wake up.
- 3 Press or set the Sleep timer if you want the TV to turn off automatically.

The indicator on the TV lights up orange.

To cancel the Wake Up timer

Press until "WAKE UP TIMER: OFF" appears or turn off the TV's main power.

Notes

- The Wake Up timer starts immediately after the on-screen display disappears.
- If no buttons or controls are pressed for more than two hours after the TV is turned on using the Wake Up timer, the TV automatically goes into the standby mode. To continue watching the TV, press any button or control on the TV or the remote.

Setting the Sleep timer

Press until the desired period of time appears.

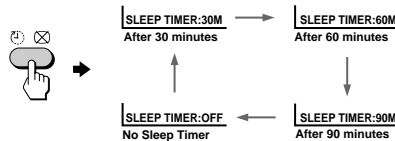

To cancel the Sleep timer

Press until "SLEEP TIMER: OFF" appears or turn the TV off.

Using Your New TV

Advanced Operations

Customizing the picture and sound

You can customize the picture and sound by selecting the picture and sound modes or by adjusting its settings.

You can change the sound effect by selecting the surround mode.

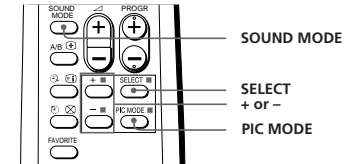

Selecting the picture and sound modes

To select the picture mode

Press PIC MODE repeatedly until you get the desired picture mode.

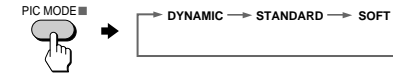

Select	To
DYNAMIC	receive high contrast pictures.
STANDARD	receive normal contrast pictures.
SOFT	receive mild pictures.

To select the sound mode

Press SOUND MODE repeatedly until you get the desired sound mode.

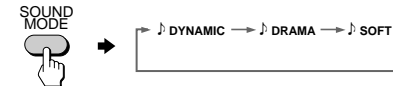

Select	To
DYNAMIC	listen to dynamic and clear sound that emphasizes the low and high sound.
DRAMA	listen to sound that emphasizes vocals and background music.
SOFT	receive soft sound.

Adjusting the picture and sound settings

- 1 Press SELECT until the desired setting appears.



Each time you press SELECT, the setting item will change as follows:

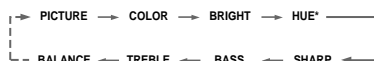

- 2 Press + or - to adjust the item.



- 3 To adjust other items, repeat steps 1 to 2.

* "HUE" can be adjusted for the NTSC system only.

Notes

- When you select a picture or sound mode, the adjusted settings will be reset according to the selected mode.
- You can also use SELECT and \triangle +/- on the TV to adjust the picture and sound settings.

Selecting the surround mode

- 1 Press SELECT repeatedly until "SURROUND" appears.



- 2 Press + or - to select the desired surround sound.

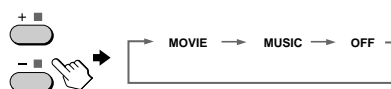

Select	To
MOVIE	listen to sound that spreads out over a large area, giving the feeling of being at a movie theatre.
MUSIC	listen to the sound that gives the feeling of being at a live concert.
OFF	turn off the surround sound.

Blocking the channels (CHILD LOCK)

You can prevent a child from watching certain programs by using the buttons on the remote control.

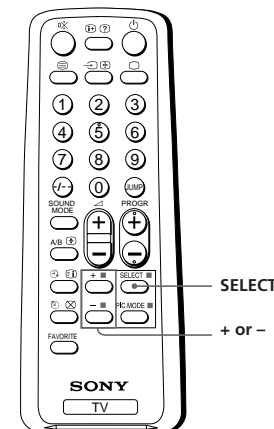

- 1 Select the TV program you want to lock.

- 2 Press SELECT until "CHILD LOCK" appears on the screen.

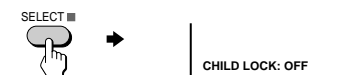

- 3 Press + or - to select "ON".

The  symbol appears on the screen.

To unlock the channel, press + or - to select "OFF". The  symbol disappears from the screen.

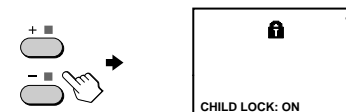

Note

- If you preset a locked channel, that particular channel will be unlocked automatically.

Selecting a stereo or bilingual program

You can enjoy stereo sound or bilingual programs of NICAM and A2 (German) stereo systems.

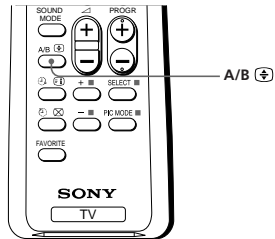

Press A/B repeatedly until you receive the sound you want.

The on-screen display changes to show the selected sound and the indicator on the TV lights up red.

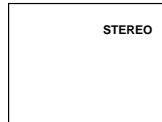

When receiving a NICAM program

Broadcasting	On-screen display (Selected sound)
NICAM stereo	
NICAM bilingual	
NICAM monaural	

continued

Selecting a stereo or bilingual program (continued)

When receiving an A2 (German) program

Broadcasting	On-screen display (Selected sound)
A2 (German) stereo	
A2 (German) bilingual	

Receiving area for NICAM and A2 (German) programs

System	Receiving area
NICAM	Hong Kong, Singapore, New Zealand, Malaysia, Thailand, etc.
A2 (German)	Australia, Malaysia, Thailand, etc.

Notes

- If the signal is very weak, the sound becomes monaural automatically.
- If the stereo sound is noisy when receiving a NICAM program, select "MONO". The sound becomes monaural, but the noise is reduced. (KV-TF21M90 only)

If the sound is distorted or noisy when receiving a monaural program through the (antenna) terminal

Press A/B repeatedly until "MONO" appears on the screen.

To cancel the monaural sound setting, press A/B again until "AUTO" appears on the screen.

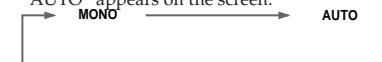

Notes

- The "MONO" or "AUTO" setting is memorized for each program position.
- You cannot receive stereo broadcast signal when the TV is in the "MONO" setting. Normally set the TV to "AUTO."

Viewing Teletext

(KV-TF21M61 only)

TV stations broadcast an information service called Teletext via some TV channels. Teletext allows you to receive various information, such as shares market or news.

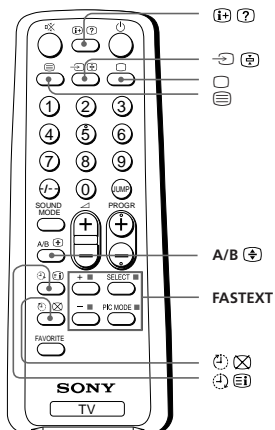

Displaying Teletext

1 Select a TV channel that carries the Teletext broadcast you want to watch.

2 Press to display the text.

A Teletext page (normally the index page) is displayed. If there is no Teletext broadcast, "100" is displayed at the top left corner of the screen.

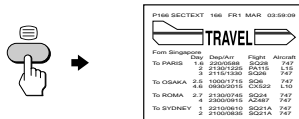

To turn off Teletext

Press .

continued

Viewing Teletext (continued)

Additional Teletext tasks

To	Do this
display a Teletext page on the TV picture	Press . Each time you press , the screen changes as follows: Teletext → Teletext and TV → TV.
check the contents of a Teletext service	Press . An overview of the Teletext contents and page numbers appear on the screen.
select a Teletext page	Press the number buttons to enter the three-digit page number of the desired Teletext page.* If you make a mistake, reenter the correct page number. To access the next or previous page, press PROGR +/-.
hold a Teletext page (stop the page from scrolling)	Press to display the symbol "Ⓢ" at the top left corner of the screen. To resume normal Teletext operation, press or .
reveal concealed information (e.g., an answer to a quiz)	Press . To conceal the information, press the button again.
enlarge the Teletext display	Press A/B . Each time you press A/B , the Teletext display changes as follows: Enlarge upper half → Enlarge lower half → Normal size.
wait for a Teletext page while watching a TV program	1 Enter the Teletext page number that you want to refer to, then press . 2 When the page number is displayed, press to show the text.

* You can also select a Teletext page of any page number that appears in the colored column at the bottom of the screen using the corresponding color-coded button on the remote.

Using FASTEXT



This feature allows you to quickly access a Teletext page that uses FASTEXT. When a FASTEXT program is broadcasted, the colored menus appear at the bottom of the screen. The colors of the menus correspond to the red, green, yellow, and blue color-coded buttons on the remote.

To access a FASTEXT menu

Press the color-coded button on the remote corresponding to the menu you want. The menu page appears on the screen after several seconds.





Additional Information

Self-diagnosis function

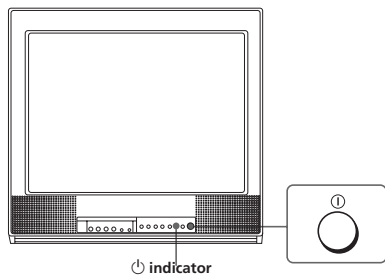
Your TV is equipped with a self-diagnosis function. If there is a problem with your TV, the  indicator flashes red. The number of times the  indicator flashes indicates the possible causes.

Front of TV



- 1 Check that the  indicator flashes red a number of times between 3-second intervals.
- 2 Count the number of times the  indicator flashes.
- 3 Press  (main power) to turn off your TV.
- 4 Inform your nearest Sony service center about the number of times the  indicator flashes.
Be sure to note the model name and serial number located on the rear of your TV.

Additional Information





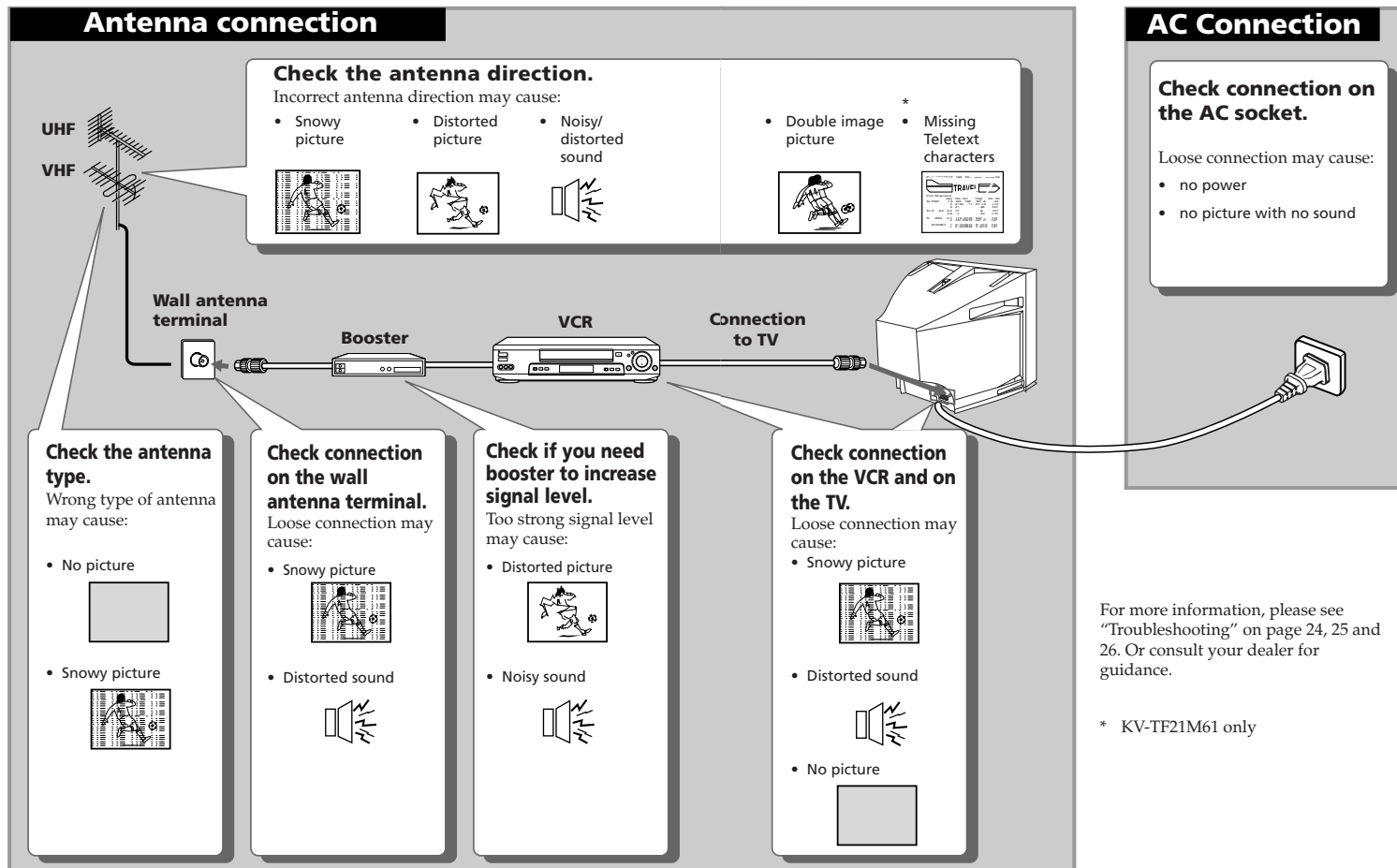



Troubleshooting Shortcuts







For better viewing, please check the following connections.



Troubleshooting

If you find any problem while viewing your TV, please check the following guide. If any problem persists, contact your Sony dealer .

Symptom	Solutions	Possible cause
Snowy picture 	<ul style="list-style-type: none"> Check the antenna cable and connection on the TV, VCR and on the wall. (page 4) Press SELECT until "MANUAL PROGRAM" appears on the screen then preset the channel again. (page 9) 	<ul style="list-style-type: none"> Connection is loose or the cable is damaged. Channel presetting is inappropriate or incomplete.
Noisy sound 	<ul style="list-style-type: none"> Check the antenna type (VHF/UHF). Contact a Sony dealer for advice. Adjust the antenna direction. Contact a Sony dealer for advice. Try using a booster. 	<ul style="list-style-type: none"> The antenna type is inappropriate. The antenna direction is inappropriate. Signal transmission is low.
Distorted picture 	<ul style="list-style-type: none"> Turn off or disconnect the booster if it is in use. 	<ul style="list-style-type: none"> Broadcast signals are too strong.
Noisy sound 		
Good picture 	<ul style="list-style-type: none"> If the sound of all the channels are noisy, check the TV system (TV SYS) setting (page 9), then press AUTO PROGR to preset the channels again (page 8). If the sound of some channels are noisy, select the channel, then select the appropriate TV system (TV SYS). (page 9) 	<ul style="list-style-type: none"> The TV system setting or channel presetting is inappropriate or incomplete.
Noisy sound 		
No picture 	<ul style="list-style-type: none"> Check the power cord, antenna and the VCR connections. Press ⏻ (power). Press ⏻ (main power) on the TV to turn off the TV for about five seconds, then turn it on again. 	<ul style="list-style-type: none"> The power cord, antenna or VCR is not connected. The TV is not turned on.
No sound 		

Symptom	Solutions	Possible cause
Good picture 	<ul style="list-style-type: none"> Press ◀ + to increase the volume level. Press ⏸ to cancel the muting. Press A/B ⊕ until a better sound is heard. 	<ul style="list-style-type: none"> The volume level is too low. The sound is muted. Broadcast signal has a transmission problem.
No sound 		
Dotted lines or stripes 	<ul style="list-style-type: none"> Do not use a hair dryer or other equipment near the TV. Adjust the antenna direction for minimum interference. Contact a Sony dealer for advice. 	<ul style="list-style-type: none"> There is local interference from cars, neon signs, hair dryers, power generators, etc.
Double images or "ghosts" 	<ul style="list-style-type: none"> Use a highly directional antenna. Use the fine tuning (FINE) function. (page 10) Adjust the antenna direction. Contact a Sony dealer for advice. Turn off or disconnect the booster if it is in use. 	<ul style="list-style-type: none"> Broadcast signals are reflected by nearby mountains or buildings. The antenna direction is inappropriate. Use of a booster is inappropriate.
No color 	<ul style="list-style-type: none"> Press SELECT until "COLOR" appears on the screen, then press + or - to adjust the color level. (page 15) Press SELECT until "COL SYS " appears on the screen, then check the color system setting (usually set this to "AUTO"). (page 10). Adjust the antenna direction. Contact a Sony dealer for advice. 	<ul style="list-style-type: none"> The color level setting is too low. The color system setting is inappropriate. The antenna direction is inappropriate.
Abnormal color patches 	<ul style="list-style-type: none"> Keep external speakers or other electrical equipment away from the TV. Do not move the TV while the TV is turned on. Press ⏻ (main power) on the TV to turn off the TV for about five minutes, then turn it on again. 	<ul style="list-style-type: none"> The magnetic disturbance from external speakers or other equipment, or the direction of the earth's magnetic field may affect the TV.
TV cannot receive stereo broadcast signal	<ul style="list-style-type: none"> Press A/B ⊕ until "AUTO" appears on the screen. 	<ul style="list-style-type: none"> The stereo reception setting is inappropriate.

continued

Troubleshooting (continued)

Symptom	Solutions	Possible cause
Stereo broadcast sound switches on and off or is distorted. OR The sound switches between monaural and stereo frequently.	<ul style="list-style-type: none"> Check the antenna cable and connection on the TV, VCR and on the wall. (page 4) Adjust the antenna direction. Contact a Sony dealer for advice. Press A/B (⊕) until a better sound is heard. 	<ul style="list-style-type: none"> Connection is loose or the cable is damaged. The antenna direction is inappropriate. Broadcast signal has a transmission problem.
"100" appears on the top of the screen and there is no Teletext display. (KV-TF21M61 only)	—	<ul style="list-style-type: none"> The channel carries no Teletext broadcast.
Teletext display is incomplete (snowy picture or double images). (KV-TF21M61 only)	<ul style="list-style-type: none"> Check the antenna cable and connection on the TV, VCR, and at the wall. (page 4) Adjust the antenna direction. Contact a Sony dealer for advice. Try using a booster. Use the fine tuning (FINE) function. (page 10) 	<ul style="list-style-type: none"> Connection is loose or the cable is damaged. The antenna direction is inappropriate. Signal transmission is too low.
Picture slant 	<ul style="list-style-type: none"> Press SELECT until "PIC ROTATION" appears on the screen, then press + or - to align the picture to the TV screen. (page 12) 	<ul style="list-style-type: none"> The terrestrial magnetism affects your TV set.
Lines moving across the TV screen. (page 10)	<ul style="list-style-type: none"> Use the fine tuning (FINE) function. (page 10) 	<ul style="list-style-type: none"> There is interference from external sources, e.g., heavy machineries, nearby broadcast station.
The indicator on your TV flashes red a number of times between 3-second intervals.	<ul style="list-style-type: none"> Contact your nearest Sony service center. (page 21) 	<ul style="list-style-type: none"> Your TV may need service.
TV cabinet creaks.	—	<ul style="list-style-type: none"> Changes in room temperature sometimes make the TV cabinet expand or contract, making a noise. This does not indicate a malfunction.
A "boom" sound is heard when the TV is turned on.	—	<ul style="list-style-type: none"> The TV's demagnetizing function is working. This does not indicate a malfunction.

Identifying parts and controls

Refer to the pages indicated in parentheses () for details.

Front panel

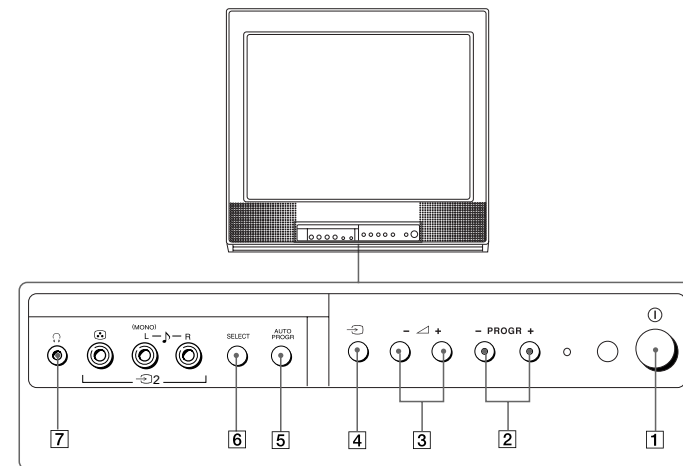

- 1 ① (main power) button (5)
- 2 PROGR +/- (program) buttons (11)
- 3 +/- (volume) buttons (11)
- 4 TV/video button (12)
- 5 AUTO PROGR (program) button (5)
- 6 SELECT button (9)
- 7 ② (headphone) jack

continued

Identifying parts and controls (continued)

Remote Control

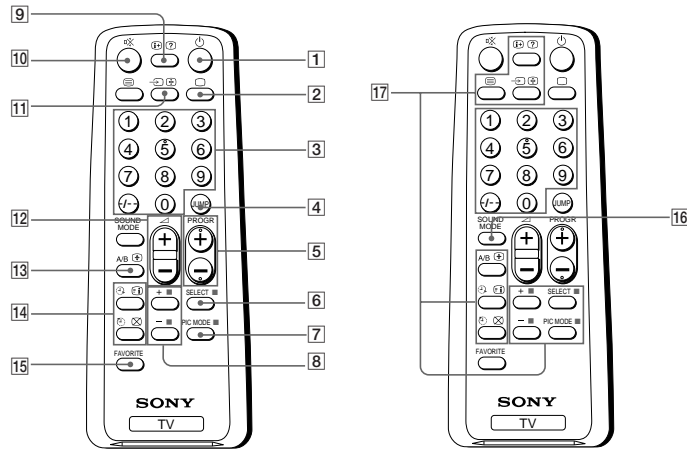

- 1 (power) button (11)
- 2 (TV) button (12)
- 3 Number buttons (11)
- 4 (JUMP) button (12)
- 5 (PROGR +/-) buttons (11)
- 6 (SELECT) button (9)
- 7 (PIC MODE) button (14)
- 8 (+ or -) buttons (9)
- 9 (display) button (12)
- 10 (mute) button (12)
- 11 (video) button (12)
- 12 (+/-) (volume) buttons (11)
- 13 (A/B) button (17)
- 14 (timer setting) buttons (13)
- 15 (FAVORITE) button (not used for these models)

- 16 (SOUND MODE) button (14)
- 17 (Teletext operation) buttons (19,20) (KV-TF21M61 only)
 - (text) (enlarge)
 - (reveal) (hold)
 - (index) (text clear)
 - (FASTEXT: red, green, yellow, blue)

Names/symbols of buttons on the remote are indicated in different colors to represent the available functions.

Label color	Button function
White	For general TV operations
Green	For Teletext operations

The operating instructions mentioned here are partial abstracts from the Operating Instruction Manual. The page numbers of the Operating Instruction Manual remain as in the manual.

SECTION 1-3 GENERAL- (KV-TF21P11)

WARNING

- Dangerously high voltages are present inside the TV.
- Operate the TV only between 220 – 240 V AC.

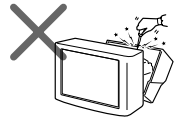
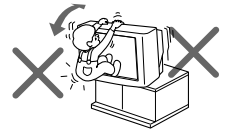
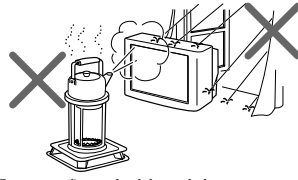
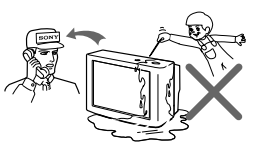
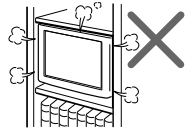
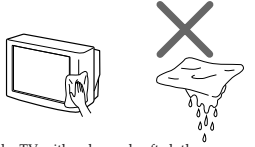
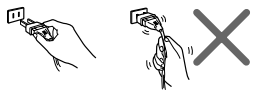
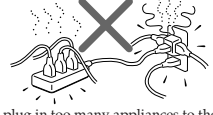
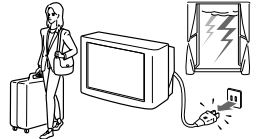
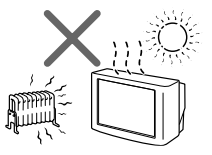
 <p>Do not open the cabinet and the rear cover of the TV. Refer servicing to qualified personnel.</p>	 <p>Install the TV in a stable position. Do not allow children to climb onto it.</p>
 <p>To prevent fire or shock hazard, do not expose the TV to rain or moisture.</p>	 <p>Do not operate the TV if any liquid or solid object falls into it. Have it checked immediately by qualified personnel only.</p>
 <p>Do not install the TV in a confined space, such as a bookcase or built-in cabinet. Do not block the ventilation openings of the TV.</p>	 <p>Clean the TV with a dry and soft cloth. Do not use benzine, thinner, or any other chemicals to clean the TV. Do not scratch the picture tube.</p>
 <p>Do not pull the power cord to disconnect the TV. Pull it out by the plug.</p>	 <p>Do not plug in too many appliances to the same power socket. Do not damage the power cord.</p>
 <p>Disconnect the power cord during lightning storms or if you are not going to use the TV for several days.</p>	 <p>Do not install the TV in hot, humid or excessively dusty places.</p>

Using Your New TV

Getting Started

Step 1

Connect the antenna

If you wish to connect a VCR, see the "Connecting a VCR" diagram below.

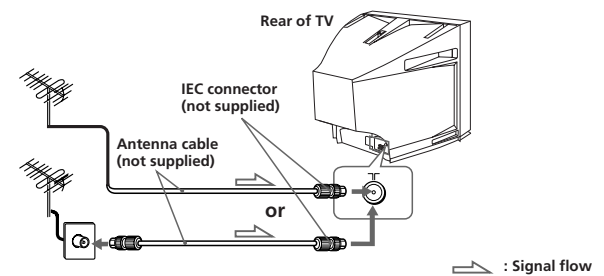

Connecting a VCR

To watch the video, press  (see page 12).

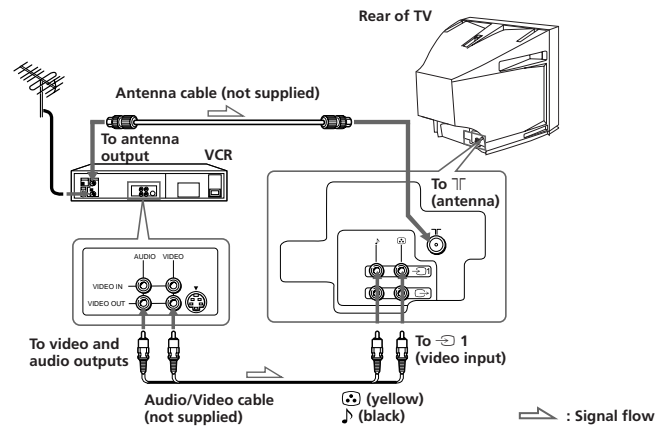

Notes

- If you connect a stereo VCR, connect the yellow plug to ☉ (the yellow jack) and the white plug to ♪ (the black jack).
- If you connect a VCR to the 1 (antenna) terminal, preset the signal output from the VCR to the program number 0 on the TV.
- When no signal is input to the connected video equipment, the TV screen becomes blue.

CAUTION

Do not connect the power cord until you have completed making all other connections; otherwise a minimum leakage current might flow through the antenna and other terminals to ground.

Step 2

Insert the batteries into the remote

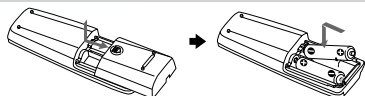

Note

- Do not use old batteries nor use different types of batteries together.

Step 3

Preset the channels automatically

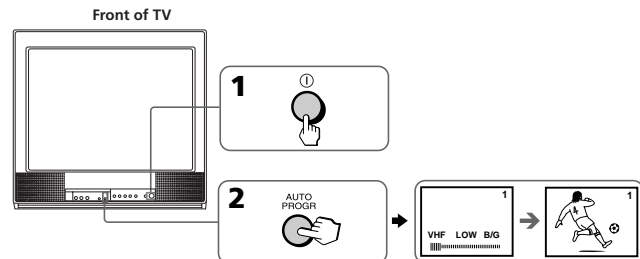

Tips

- If you want to stop automatic channel presetting, press SELECT twice.
- If your TV has preset an unwanted channel or cannot preset a particular channel, then preset your TV manually (see page 9).

Now You Are Ready. . .

To watch your TV, see page 11.



Connecting optional components

You can connect optional video components, such as a VCR, multi disc player, camcorder or video game.

To watch the picture of the connected equipment, press \rightarrow (see page 12).

Connecting a camcorder/video game equipment using the \rightarrow 2 (video input) jacks

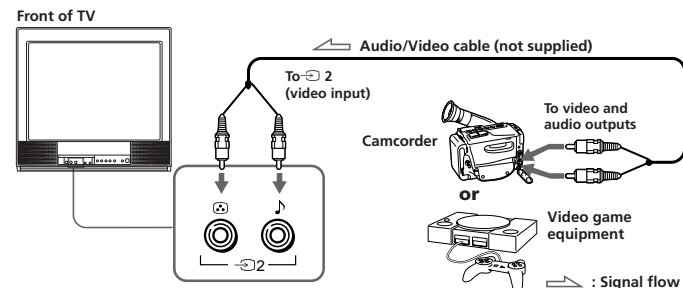

Note

- You can also connect video equipment to the \rightarrow 1 (video input) jacks at the rear of your TV.

Connecting video equipment using the \rightarrow (monitor output) jacks

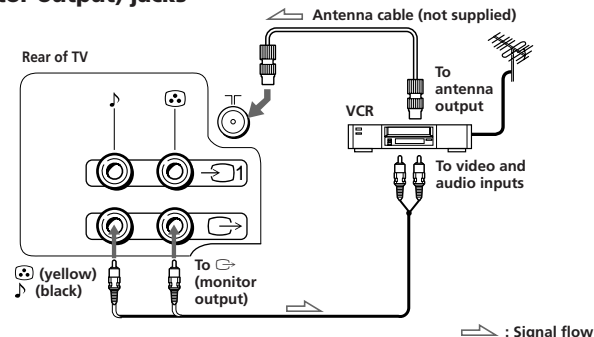

Note

- When connecting a stereo VCR, connect the yellow plug to ☉ (the yellow jack) and the white plug to ♪ (the black jack).

Securing the TV

To prevent the TV from falling, secure the TV using one of the following methods:

A With the supplied screws, attach the band to the TV stand and to the rear of the TV using the provided hole.

or

B Put the cord or chain through the clamps to secure the TV against a wall or pillar.

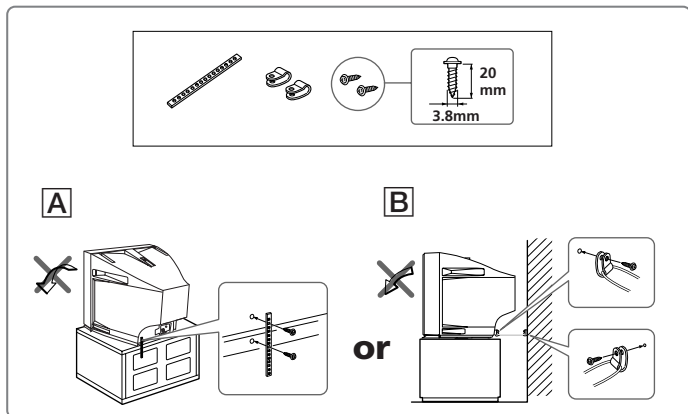

Note

- Use only the supplied screws. Use of other screws may damage the TV.

Using Your New TV

Presetting channels

You can preset up to 100 TV channels in numerical sequence from program number 1 using the remote and the buttons on your TV as well.

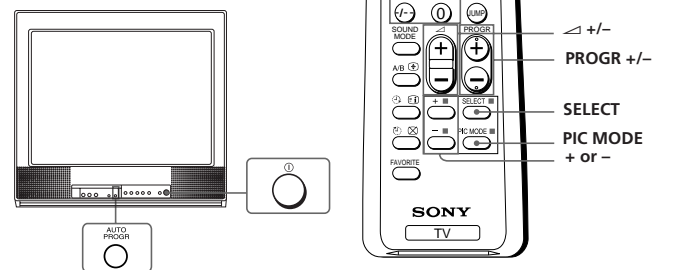

Presetting channels automatically

1 Press ① to turn on the TV.



2 Press AUTO PROGR.



VHF LOW B/G

To preset channels automatically from a specified program number

- (1) Press SELECT until "AUTO PROGRAM" appears.
- (2) Press + or -.
The on-screen display will start flashing.
- (3) Press PROGR +/- or the number buttons until the desired program number appears.
- (4) Press + or -.

Presetting channels manually

- 1** Press SELECT until "MANUAL PROGRAM" appears.

- 2** Press + or -.

- 3** Press PROGR +/- or the number buttons until the desired program number appears.

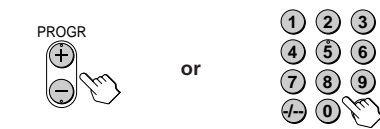
- 4** Press + or - until the desired channel picture appears.

- 5** Press SELECT.



Using Your New TV

To change the color system setting

If the color is abnormal when receiving programs through the ㄗ (antenna) terminal or the ㄎ (video input) jack

- (1) Press SELECT until "COL SYS" appears.

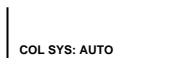

- (2) Press + or - to select the appropriate color system until the color is optimal.

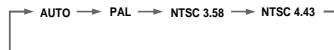

Tip

- Normally set "COL SYS" to "AUTO".

continued

Presetting channels (continued)

Skipping program numbers

- 1** Press PROGR +/- or the number buttons until the unused or unwanted program number appears.
- 2** Press SELECT until "MANUAL PROGRAM" appears.
- 3** Press + or -.
- 4** Press PIC MODE.
- 5** Press SELECT.

To preset the skipped program number again

Preset the channel automatically or manually.

Tip

- You can also use SELECT and ㄎ +/- on the TV to preset channels and skip program numbers.

To use the fine tuning (FINE) function

The fine tuning (FINE) function may help to reduce the following problems: incomplete Teletext display, double images and lines moving across the TV screen.

You can use the fine tuning function as below:

- (1) Select the program number you want to adjust.
- (2) Press SELECT until "MANUAL PROGRAM" appears on the screen.
- (3) Press + or - on the remote control once.
- (4) Press ㄎ ㄎ to display "FINE" on the screen.
- (5) Press + or - continuously until the above problems are minimized.
The + or - icon on the screen flashes while tuning.
- (6) Press SELECT to return to normal screen.

Watching the TV

This section explains functions used while watching the TV. Most operations can be done using the remote.

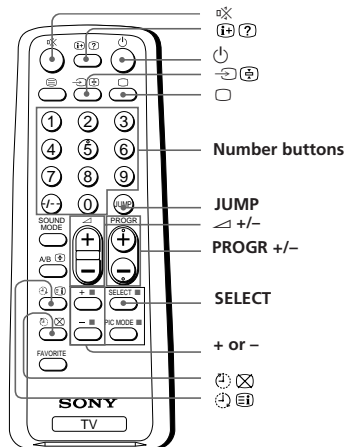
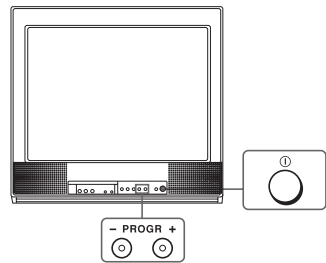

Using Your New TV

1 Press to turn on the TV.

When the TV is in the standby mode (the indicator on the TV is lit red), press on the remote or PROGR +/- on the TV.



2 Press PROGR +/- or the number buttons to select the TV program.

For double digit numbers, press +/-, then the number (e.g., for 25, press +/-, then 2 and 5).

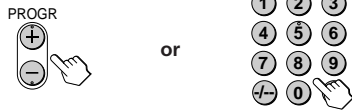

3 Press to adjust the volume.



Watching the TV (continued)

Additional tasks

To	Do this
Turn off temporarily	Press . The indicator on the TV lights up red.
Turn off completely	Press on the TV.
Mute the sound	Press .
Watch the video input (VCR, camcorder, etc.)	Press to select "VIDEO 1" or "VIDEO 2". To return to the TV program, press .
Jump back to the previous channel	Press JUMP.
Display the on-screen information*	Press .
Adjust the volume of each TV program automatically	Press SELECT repeatedly until "INTELLIGENT VOL" appears, then press + or - to select "ON". To cancel, select "OFF".
Adjust the picture position when it is not aligned to the TV screen	Press SELECT repeatedly until "PIC ROTATION" appears, then press + or - to adjust the alignment of the picture position.

PIC ROTATION

The or icon on the screen flashes while adjusting.

* The picture, sound, and either the program number or video mode are displayed. The on-screen display for the picture and sound information disappears after about 3 seconds.

Changing the on-screen display language

1 Press SELECT until "LANGUAGE / 语言: ENGLISH" appears on the screen.



2 Press + or - to select "中文".



Tip

- You can also use SELECT and +/- on the TV to select the on-screen display language.

continued

Setting the Wake Up timer

1 Press until the desired period of time appears.

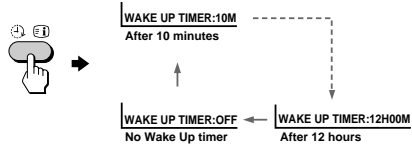

2 Select the TV program or video mode you want to display when you wake up.

3 Press or set the Sleep timer if you want the TV to turn off automatically.

The indicator on the TV lights up orange.

To cancel the Wake Up timer

Press until "WAKE UP TIMER: OFF" appears or turn off the TV's main power.

Notes

- The Wake Up timer starts immediately after the on-screen display disappears.
- If no buttons or controls are pressed for more than two hours after the TV is turned on using the Wake Up timer, the TV automatically goes into the standby mode. To continue watching the TV, press any button or control on the TV or the remote.

Setting the Sleep timer

Press until the desired period of time appears.

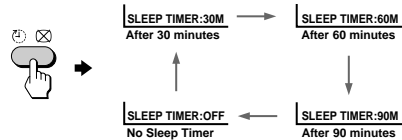

To cancel the Sleep timer

Press until "SLEEP TIMER: OFF" appears or turn the TV off.

Advanced Operations

Customizing the picture and sound

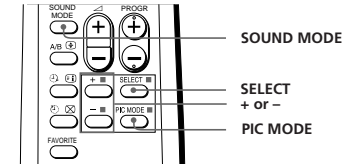

You can customize the picture and sound by selecting the picture and sound modes or by adjusting its settings.

You can change the sound effect by selecting the surround mode.

Selecting the picture and sound modes

To select the picture mode

Press PIC MODE repeatedly until you get the desired picture mode.

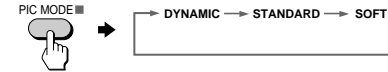

Select	To
DYNAMIC	receive high contrast pictures.
STANDARD	receive normal contrast pictures.
SOFT	receive mild pictures.

To select the sound mode

Press SOUND MODE repeatedly until you get the desired sound mode.

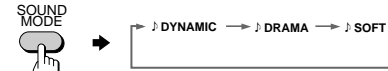

Select	To
DYNAMIC	listen to dynamic and clear sound that emphasizes the low and high sound.
DRAMA	listen to sound that emphasizes vocals and background music.
SOFT	receive soft sound.

Adjusting the picture and sound settings

- 1 Press SELECT until the desired setting appears.



Each time you press SELECT, the setting item will change as follows:

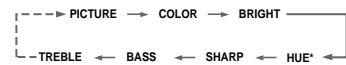

- 2 Press + or - to adjust the item.



- 3 To adjust other items, repeat steps 1 to 2.

* "HUE" can be adjusted for the NTSC system only.

Notes

- When you select a picture or sound mode, the adjusted settings will be reset according to the selected mode.
- You can also use SELECT and Δ +/- on the TV to adjust the picture and sound settings.

Advanced Operations

Blocking the channels (CHILD LOCK)

You can prevent a child from watching certain programs by using the buttons on the remote control.

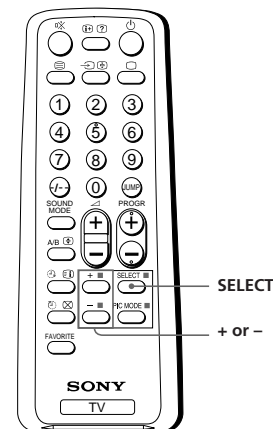

- 1 Select the TV program you want to lock.

- 2 Press SELECT until "CHILD LOCK" appears on the screen.

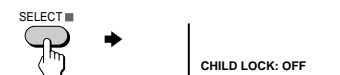

- 3 Press + or - to select "ON".

The symbol appears on the screen.

To unlock the channel, press + or - to select "OFF". The symbol disappears from the screen.

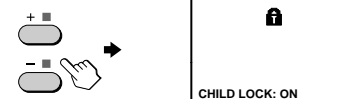

Note

- If you preset a locked channel, that particular channel will be unlocked automatically.

Viewing Teletext

TV stations broadcast an information service called Teletext via some TV channels. Teletext allows you to receive various information, such as shares market or news.

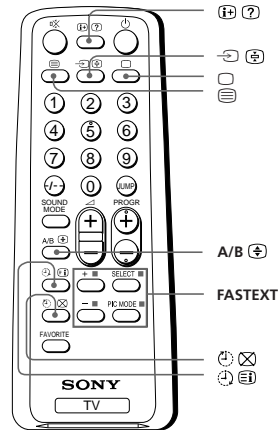

Displaying Teletext

- 1 Select a TV channel that carries the Teletext broadcast you want to watch.
- 2 Press to display the text.

A Teletext page (normally the index page) is displayed. If there is no Teletext broadcast, "100" is displayed at the top left corner of the screen.

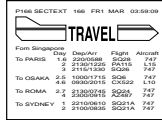

To turn off Teletext

Press .

Viewing Teletext (continued)

Additional Teletext tasks

To	Do this
display a Teletext page on the TV picture	Press . Each time you press , the screen changes as follows: Teletext → Teletext and TV → TV.
check the contents of a Teletext service	Press . An overview of the Teletext contents and page numbers appear on the screen.
select a Teletext page	Press the number buttons to enter the three-digit page number of the desired Teletext page.* If you make a mistake, reenter the correct page number. To access the next or previous page, press PROG + / -.
hold a Teletext page (stop the page from scrolling)	Press to display the symbol "" at the top left corner of the screen. To resume normal Teletext operation, press or .
reveal concealed information (e.g., an answer to a quiz)	Press . To conceal the information, press the button again.
enlarge the Teletext display	Press A/B . Each time you press A/B , the Teletext display changes as follows: Enlarge upper half → Enlarge lower half → Normal size.
wait for a Teletext page while watching a TV program	1 Enter the Teletext page number that you want to refer to, then press . 2 When the page number is displayed, press to show the text.

* You can also select a Teletext page of any page number that appears in the colored column at the bottom of the screen using the corresponding color-coded button on the remote.

Using FASTEXT

This feature allows you to quickly access a Teletext page that uses FASTEXT. When a FASTEXT program is broadcasted, the colored menus appear at the bottom of the screen. The colors of the menus correspond to the red, green, yellow, and blue color-coded buttons on the remote.

To access a FASTEXT menu

Press the color-coded button on the remote corresponding to the menu you want. The menu page appears on the screen after several seconds.



continued

Advanced Operations | 17

18 | Advanced Operations





Additional Information

Self-diagnosis function

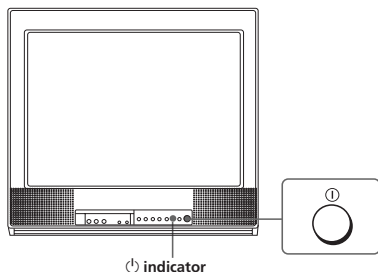
Your TV is equipped with a self-diagnosis function. If there is a problem with your TV, the  indicator flashes red. The number of times the  indicator flashes indicates the possible causes.

Front of TV











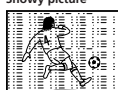





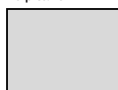

- 1** Check that the  indicator flashes red a number of times between 3-second intervals.
- 2** Count the number of times the  indicator flashes.
- 3** Press  (main power) to turn off your TV.
- 4** Inform your nearest Sony service center about the number of times the  indicator flashes. Be sure to note the model name and serial number located on the rear of your TV.

Additional Information

Troubleshooting

If you find any problem while viewing your TV, please check the following guide. If any problem persists, contact your Sony dealer.

Symptom	Solutions	Possible cause
Snowy picture 	<ul style="list-style-type: none"> Check the antenna cable and connection on the TV, VCR and on the wall. (page 4) Press SELECT until "MANUAL PROGRAM" appears on the screen then preset the channel again. (page 9) 	<ul style="list-style-type: none"> Connection is loose or the cable is damaged. Channel presetting is inappropriate or incomplete.
Noisy sound 	<ul style="list-style-type: none"> Check the antenna type (VHF/UHF). Contact a Sony dealer for advice. Adjust the antenna direction. Contact a Sony dealer for advice. Try using a booster. 	<ul style="list-style-type: none"> The antenna type is inappropriate. The antenna direction is inappropriate. Signal transmission is low.
Distorted picture 	<ul style="list-style-type: none"> Turn off or disconnect the booster if it is in use. 	<ul style="list-style-type: none"> Broadcast signals are too strong.
Noisy sound 		
Good picture 	<ul style="list-style-type: none"> If the sound of all the channels are noisy, press AUTO PROGR to preset the channels again (page 8). 	<ul style="list-style-type: none"> The channel presetting is inappropriate or incomplete.
Noisy sound 		
No picture 	<ul style="list-style-type: none"> Check the power cord, antenna and the VCR connections. Press  (power). Press  (main power) on the TV to turn off the TV for about five seconds, then turn it on again. 	<ul style="list-style-type: none"> The power cord, antenna or VCR is not connected. The TV is not turned on.
No sound 		

Symptom	Solutions	Possible cause
Good picture 	<ul style="list-style-type: none"> Press \triangleleft + to increase the volume level. Press \times to cancel the muting. 	<ul style="list-style-type: none"> The volume level is too low. The sound is muted.
No sound 		
Dotted lines or stripes 	<ul style="list-style-type: none"> Do not use a hair dryer or other equipment near the TV. Adjust the antenna direction for minimum interference. Contact a Sony dealer for advice. 	<ul style="list-style-type: none"> There is local interference from cars, neon signs, hair dryers, power generators, etc.
Double images or "ghosts" 	<ul style="list-style-type: none"> Use a highly directional antenna. Use the fine tuning (FINE) function. (page 10) Adjust the antenna direction. Contact a Sony dealer for advice. Turn off or disconnect the booster if it is in use. 	<ul style="list-style-type: none"> Broadcast signals are reflected by nearby mountains or buildings. The antenna direction is inappropriate. Use of a booster is inappropriate.
No color 	<ul style="list-style-type: none"> Press SELECT until "COLOR" appears on the screen, then press + or - to adjust the color level. (page 15) Press SELECT until "COL.SYS" appears on the screen, then check the color system setting (usually set this to "AUTO"). (page 10). Adjust the antenna direction. Contact a Sony dealer for advice. 	<ul style="list-style-type: none"> The color level setting is too low. The color system setting is inappropriate. The antenna direction is inappropriate.
Abnormal color patches 	<ul style="list-style-type: none"> Keep external speakers or other electrical equipment away from the TV. Do not move the TV while the TV is turned on. Press \odot (main power) on the TV to turn off the TV for about five minutes, then turn it on again. 	<ul style="list-style-type: none"> The magnetic disturbance from external speakers or other equipment, or the direction of the earth's magnetic field may affect the TV.

Troubleshooting (continued)

Symptom	Solutions	Possible cause
"100" appears on the top of the screen and there is no Teletext display.	—	<ul style="list-style-type: none"> The channel carries no Teletext broadcast.
Teletext display is incomplete (snowy picture or double images).	<ul style="list-style-type: none"> Check the antenna cable and connection on the TV, VCR, and at the wall. (page 4) Adjust the antenna direction. Contact a Sony dealer for advice. Try using a booster. Use the fine tuning (FINE) function. (page 10) 	<ul style="list-style-type: none"> Connection is loose or the cable is damaged. The antenna direction is inappropriate. Signal transmission is too low.
Picture slant 	<ul style="list-style-type: none"> Press SELECT until "PIC ROTATION" appears on the screen, then press + or - to align the picture to the TV screen. (page 12) 	<ul style="list-style-type: none"> The terrestrial magnetism affects your TV set.
Lines moving across the TV screen.	<ul style="list-style-type: none"> Use the fine tuning (FINE) function. (page 10) 	<ul style="list-style-type: none"> There is interference from external sources, e.g., heavy machineries, nearby broadcast station.
The \odot indicator on your TV flashes red a number of times between 3-second intervals.	<ul style="list-style-type: none"> Contact your nearest Sony service center. (page 19) 	<ul style="list-style-type: none"> Your TV may need service.
TV cabinet creaks.	—	<ul style="list-style-type: none"> Changes in room temperature sometimes make the TV cabinet expand or contract, making a noise. This does not indicate a malfunction.
A "boom" sound is heard when the TV is turned on.	—	<ul style="list-style-type: none"> The TV's demagnetizing function is working. This does not indicate a malfunction.

continued

Additional Information | 21

22 | Additional Information

Identifying parts and controls

Refer to the pages indicated in parentheses () for details.

Front panel

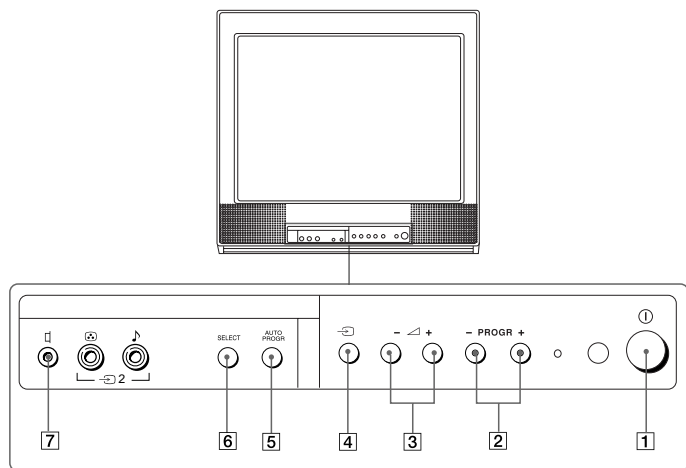

- 1 ① (main power) button (5)
- 2 PROGR +/- (program) buttons (11)
- 3 +/- (volume) buttons (11)
- 4 TV/video button (12)
- 5 AUTO PROGR (program) button (5)
- 6 SELECT button (9)
- 7 [] (earphone) jack

Identifying parts and controls (continued)

Remote Control

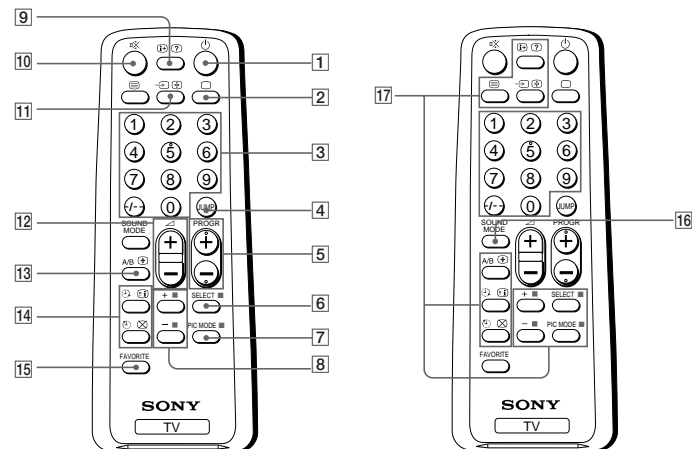

- 1 ① (power) button (11)
- 2 □ (TV) button (12)
- 3 Number buttons (11)
- 4 JUMP button (12)
- 5 PROGR +/- buttons (11)
- 6 SELECT button (9)
- 7 PIC MODE button (14)
- 8 + or - buttons (9)
- 9 [] (display) button (12)
- 10 [] (muting) button (12)
- 11 [] (video) button (12)
- 12 +/- (volume) buttons (11)
- 13 A/B button (not used for this model)
- 14 Timer setting buttons (13)
 - [] (wake up timer)
 - [] (sleep timer)

- 15 FAVORITE button (not used for this model)
- 16 SOUND MODE button (14)
- 17 Teletext operation buttons (19, 20)
 - [] (text) [] (enlarge)
 - [] (reveal) [] (hold)
 - [] (index) [] (text clear)
 - (FASTEXT: red, green, yellow, blue)

Names/symbols of buttons on the remote are indicated in different colors to represent the available functions.

Label color	Button function
White	For general TV operations
Green	For Teletext operations

continued

SECTION 2 DISASSEMBLY

2-1. REAR COVER REMOVAL

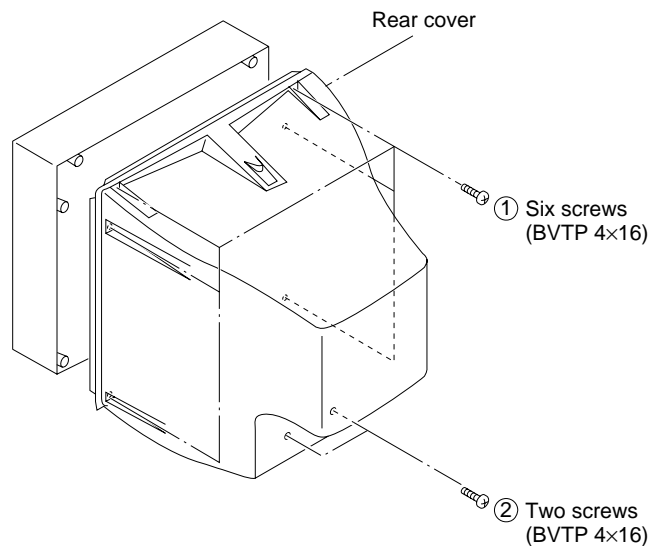

2-2. CHASSIS ASSY REMOVAL

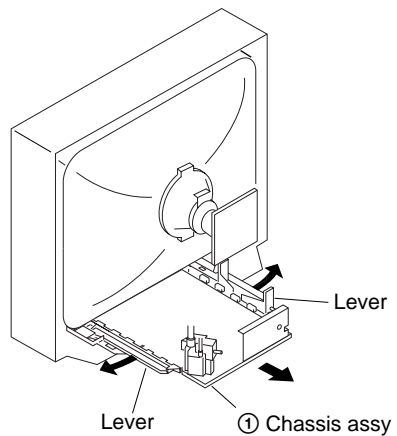

2-3. F BRACKET REMOVAL (KV-TF21M61/TF21M90)

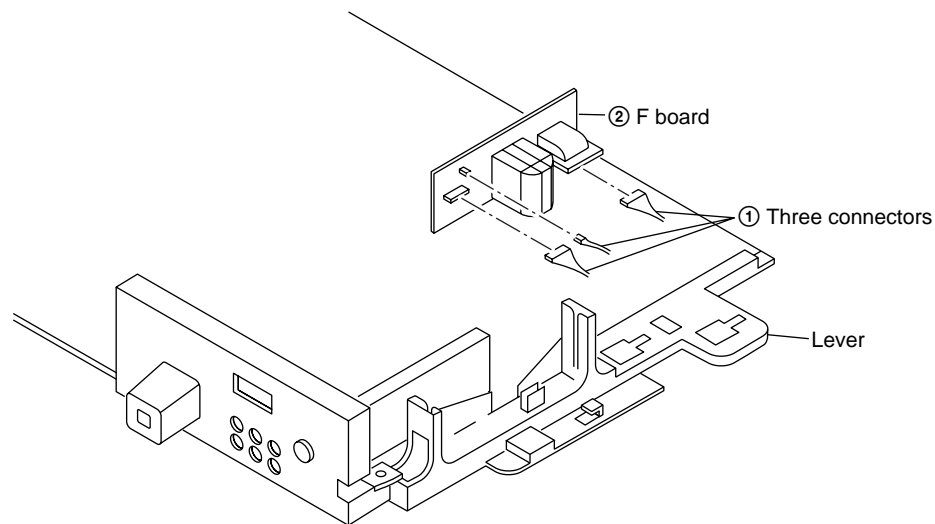

(KV-PF21M70/TF21P11)

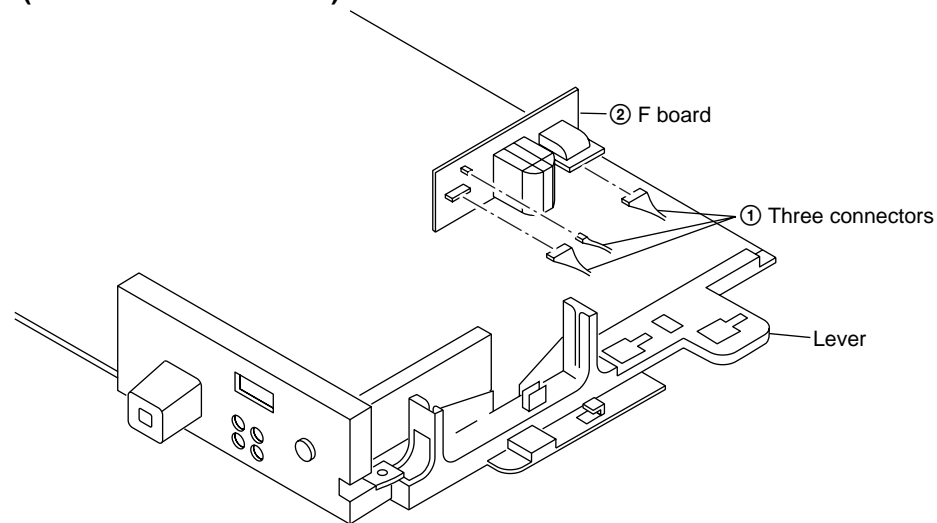

2-4. SERVICE POSITION

(Note: Remove F Bracket first.)

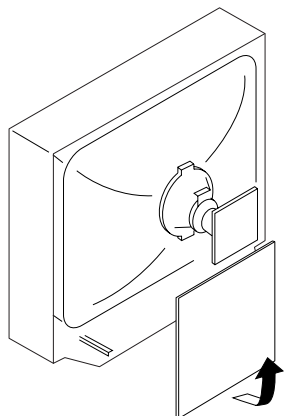

2-5-2. REPLACEMENT OF BAR OPTICAL

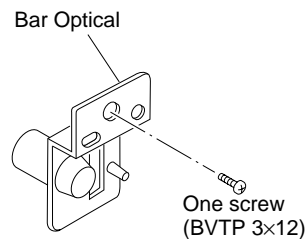

2-5. REPLACEMENT OF PARTS

For replacement of the Multi Button and Bar Optical, unscrew to exchange with the new parts, and fix them with screws (+BVTP) respectively.

2-5-1. REPLACEMENT OF MULTI BUTTON

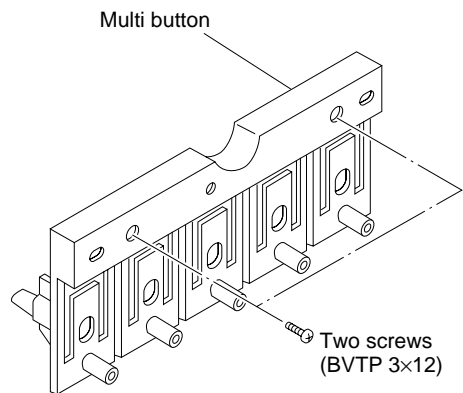

2-6. TERMINAL BRACKET REMOVAL

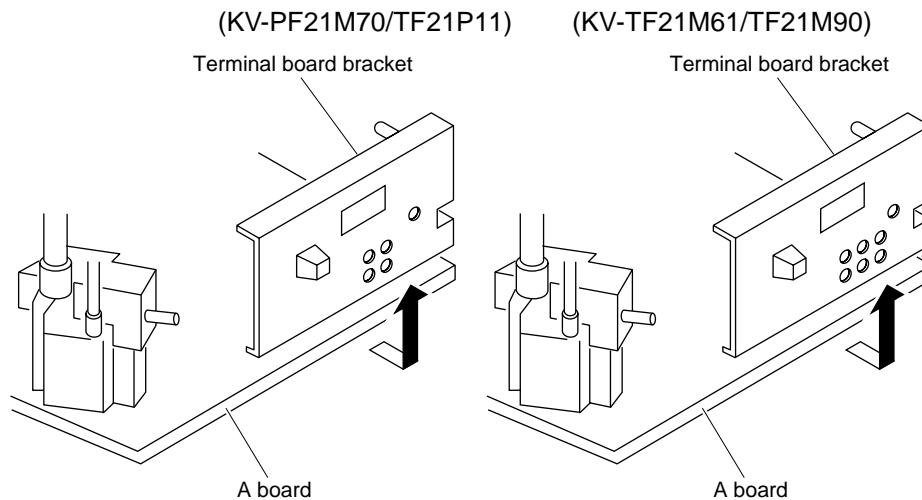

2-7. DEGAUSS COIL REMOVAL

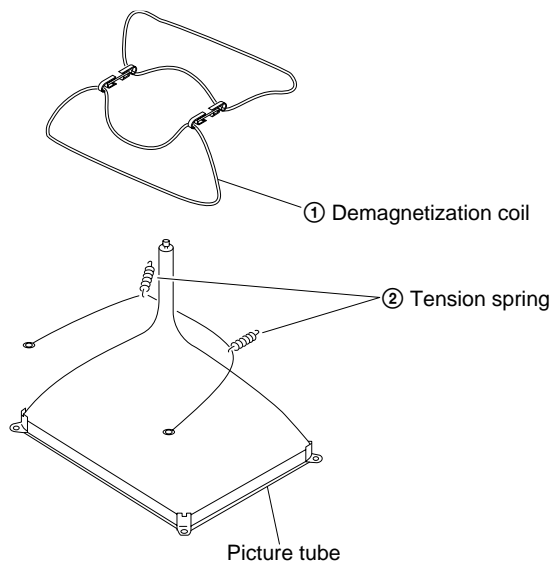

2-8. PICTURE TUBE REMOVAL

NOTE : The picture tube for OCE model is upside down, and the position for the anode cap and tension springs are changed accordingly.

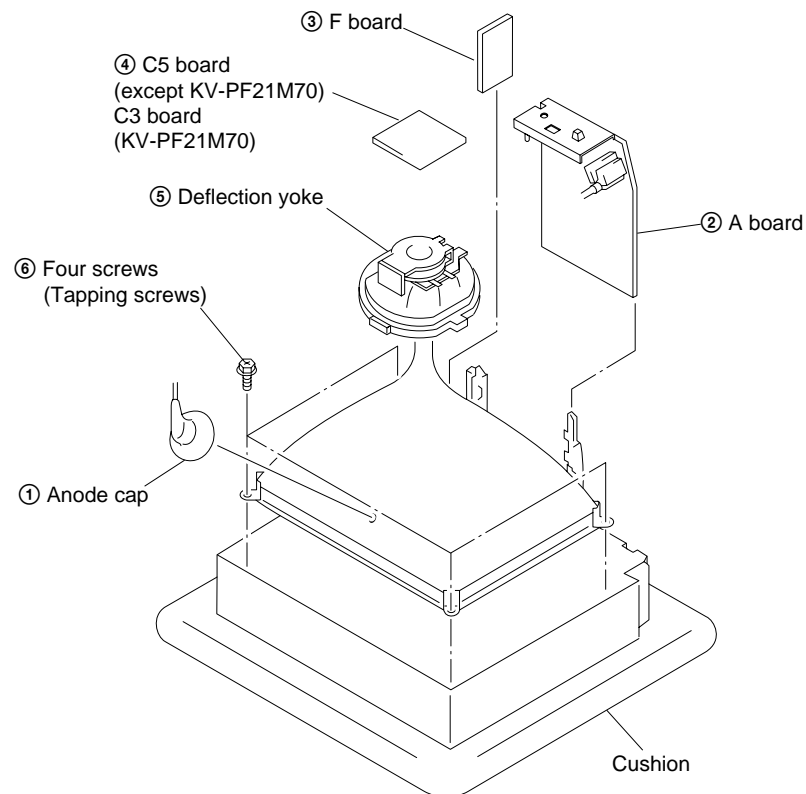

• **REMOVAL OF ANODE-CAP**

NOTE : After removing the anode, short circuit the anode of the picture tube and the anode cap to the metal chassis, CRT shield or carbon paint on the CRT.

• **REMOVING PROCEDURES**

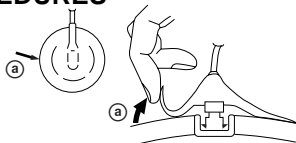

① Turn up one side of the rubber cap in the direction indicated by the arrow ①.

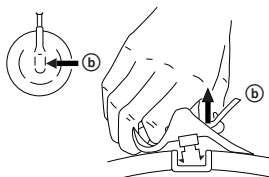

② Using a thumb pull up the rubber cap firmly in the direction indicated by the arrow ②.

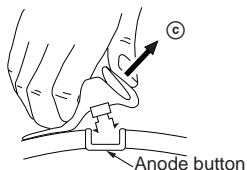

③ When one side of the rubber cap is separated from the anode button, the anode-cap can be removed by turning up the rubber cap and pulling it up in the direction of the arrow ③.

• **HOW TO HANDLE AN ANODE-CAP**

- ① Do not damage the surface of anode-caps with sharp shaped objects.
- ② Do not press the rubber too hard so as not to damage the inside of anode-cap. A metal fitting called the shatter-hook terminal is built into the rubber.
- ③ Do not turn the foot of rubber over too hard. The shatter-hook terminal will stick out or damage the rubber.

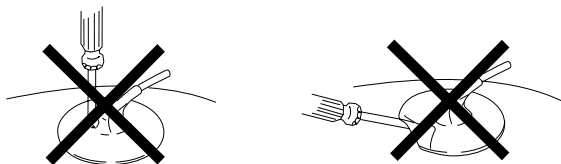

SECTION 3 SET-UP ADJUSTMENTS

- The following adjustments should be made when a complete realignment is required or a new picture tube is installed.
- These adjustments should be performed with rated power supply voltage unless otherwise noted.

Controls and switches should be set as follows unless otherwise noted:
 PICTURE control normal
 BRIGHTNESS control normal

Perform the adjustments in the following order :

1. Beam Landing
2. Convergence
3. Focus
4. White Balance

Note : Test Equipment Required.

1. Color-bar/Pattern Generator
2. Degausser
3. Oscilloscope

Preparation :

- In order to reduce the influence of geomagnetism on the set's picture tube, face it east or west.
- Switch on the set's power and degauss with the degausser.

3-1. BEAM LANDING

1. Input a white signal with the pattern generator.
 Contrast } normal
 Brightness }
2. Set the pattern generator raster signal to a green raster.
3. Move the deflection yoke to the rear and adjust with the purity control so that the green is at the center and the blue and the red take up equally sized areas on each side.
 (See Figures 3-1 through 3-3.)
4. Move the deflection yoke forward and adjust so that the entire screen is green. (See Figure 3-1.)
5. Switch the raster signal to blue, then to red and verify the condition.
6. When the position of the deflection yoke has been decided, fasten the deflection yoke with the screws and DY spacers.
7. If the beam does not land correctly in all the corners, use a magnet to adjust it.
 (See Figure 3-4.)

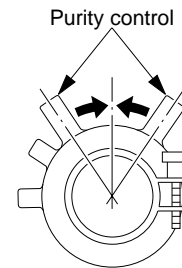

Fig. 3-2

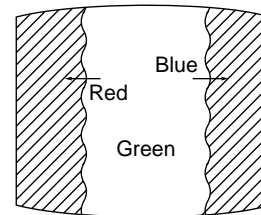

Fig. 3-3

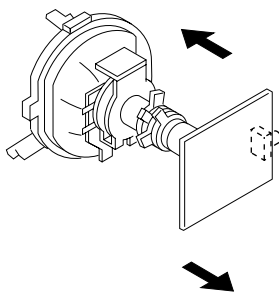

Fig. 3-1

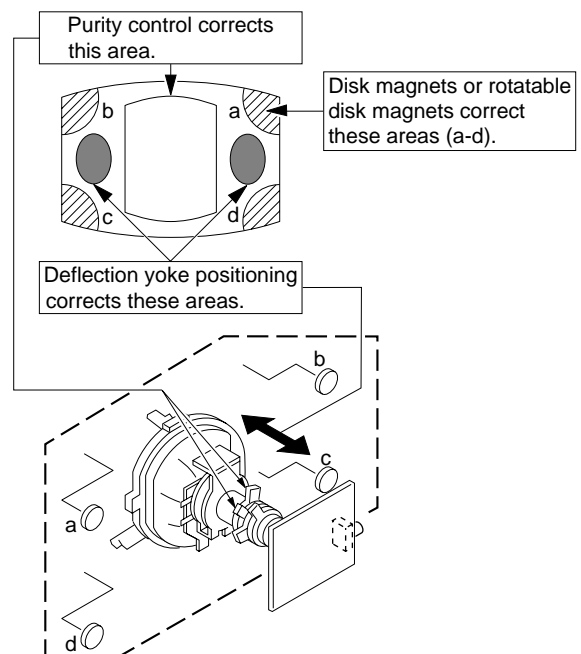

Fig. 3-4

3-2. CONVERGENCE

Preparation :

- Before starting this adjustment, adjust the focus, horizontal size and vertical size.
- Minimize the brightness setting.
- Provide dot pattern.

(1) Horizontal and Vertical Static Convergence

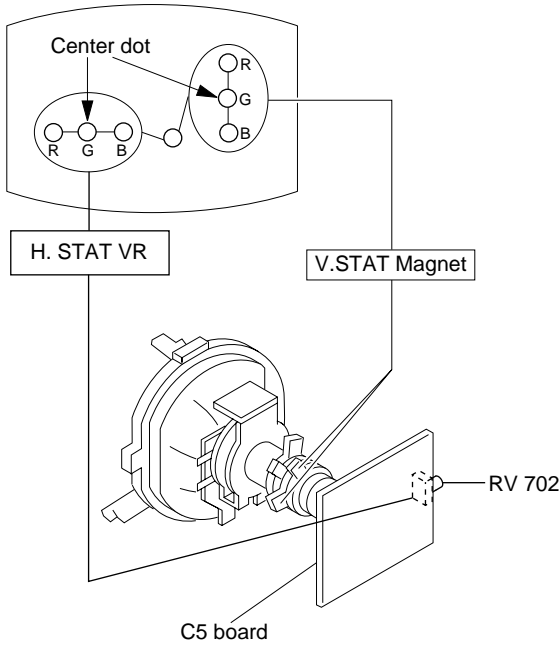

(Moving vertically), adjust the V. STAT magnet so that the red, green and blue dots are on top of each other at the center of the screen.

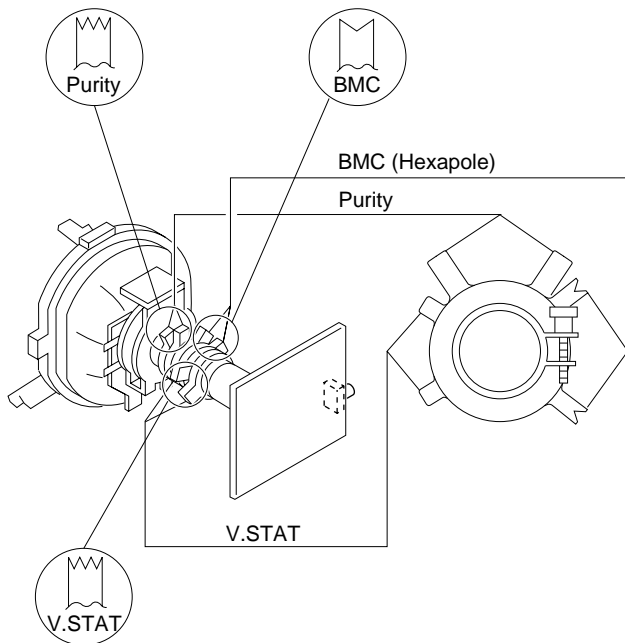

① V. STAT

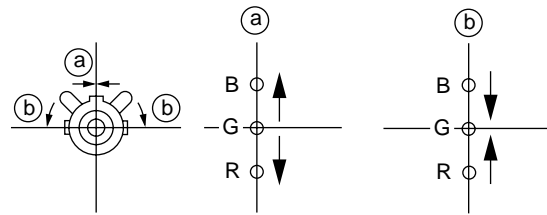

② H. STAT VR

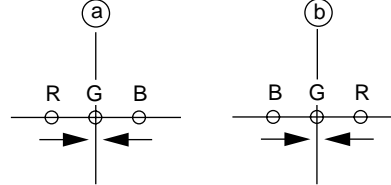

③

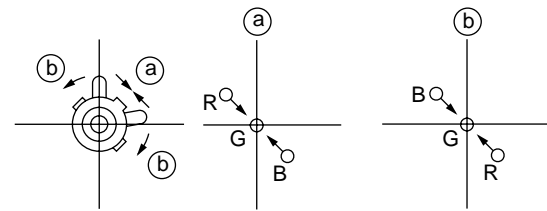

④ BMC (Hexapole) Magnet.

If the red, green and blue dots are not balanced or aligned, then use the BMC magnet to adjust in the manner described below.

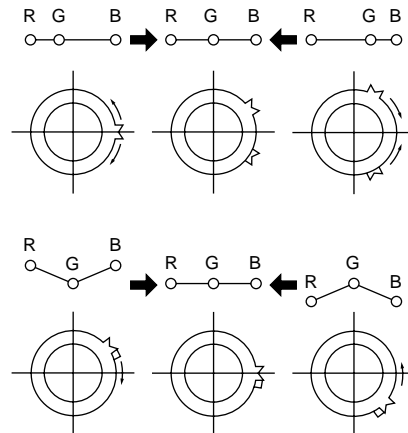

(2) Dynamic Convergence Adjustment

Preparation:

- Before starting this adjustment, adjust the horizontal static convergence and the vertical static convergence

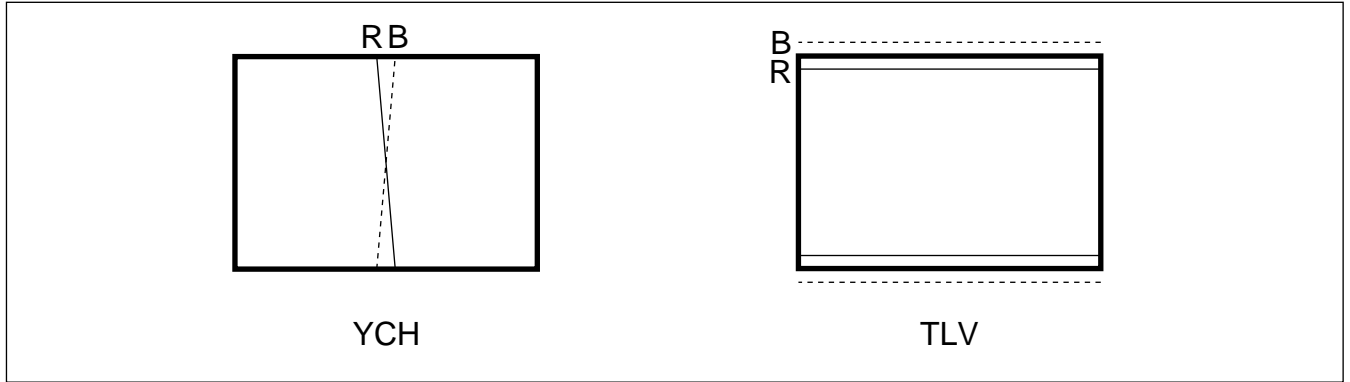

on DY

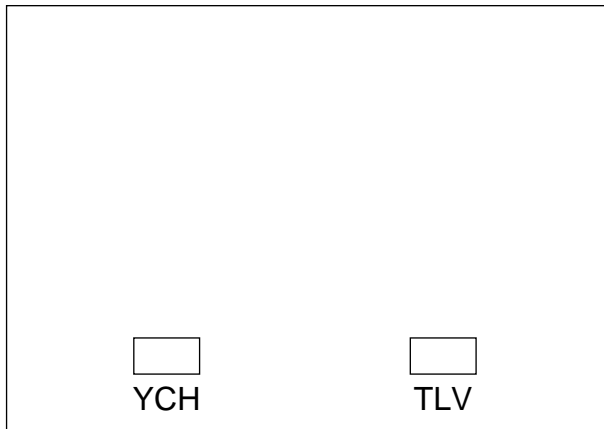

(3) Screen-corner Convergence

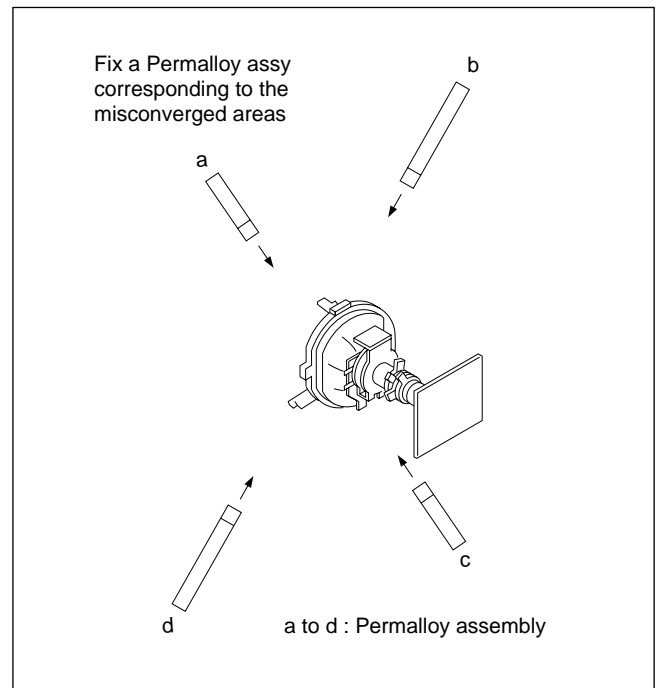
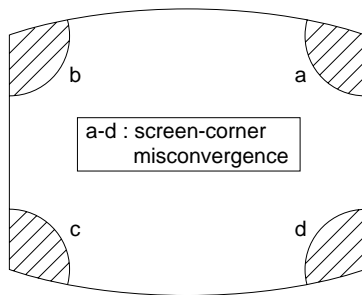

3-3. FOCUS ADJUSTMENT

Adjust FOCUS control on the flyback transformer for the best focus.

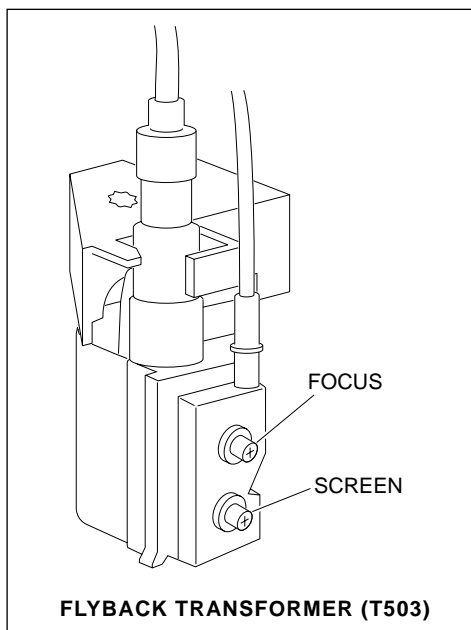

3-4. G2 (SCREEN) AND WHITE BALANCE ADJUSTMENTS

1. G2 (SCREEN) ADJUSTMENT

- 1) Set the PICTURE to normal.
- 2) Put to VIDEO input mode without signals.
- 3) Connect R, G and B of the C5 board cathode to the oscilloscope.
- 4) Adjust BRIGHTNESS to obtain the cathode voltage to the value below.
- 5) Adjust G2 (Screen) on FBT until picture shows the point before cut-off.

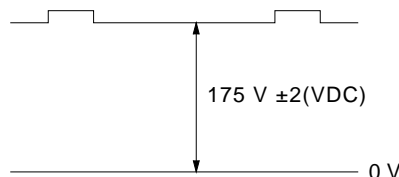

2. WHITE BALANCE ADJUSTMENT

- 1) Set to Service Mode (Refer Section 4-1: ADJUSTMENTS WITH COMMANDER).
- 2) Input white raster signal.
- 3) Set the PICTURE to minimum.
- 4) Select GCT (WHB 4) and BCT (WHB 5) with [1] and [4], and adjust the level with [3] and [6] for the best white balance.
- 5) Set the PICTURE to maximum.
- 6) Select GDR (WHB 1) and BDR (WHB 2) with [1] and [4], and adjust the level with [3] and [6] for the best white balance.
- 7) Write into the memory by pressing [MUTING] then [0].

3. SUB BRIGHT ADJUSTMENT

- 1) Set to service mode.
- 2) Input a staircase signal of black to white from the pattern generator.
- 3) BRIGHTNESS 50%.
PICTURE MINIMUM
- 4) Select SBR (WHB7) with [1] and [4], and adjust SBR (WHB7) level with [3] and [6] so that the second stripe from the right is dimly lit.

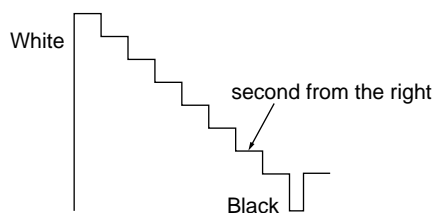

SECTION 4 CIRCUIT ADJUSTMENTS

4-1. ADJUSTMENTS WITH COMMANDER

Service adjustments are made with the RM-952 that comes with this unit.

a. ENTERING SERVICE MODE

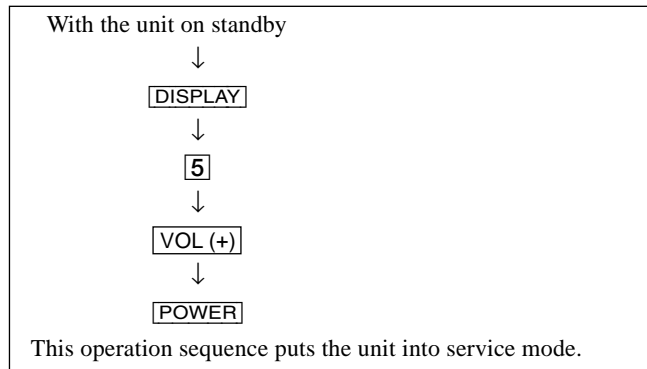

b. METHOD OF CANCELLATION FROM SERVICE MODE

Set the standby condition (Press [POWER] button on the commander), then press [POWER] button again, hereupon it becomes TV mode.

c. METHOD OF WRITE INTO MEMORY

- 1) Set to Service Mode.
- 2) Press [1] (UP) and [4] (DOWN), select an item of adjustment.
- 3) Press [MUTING] button and it will indicate WRITE on the screen.
- 4) Press [0] button to write into memory.

d. MEMORY WRITE CONFIRMATION METHOD

- 1) After adjustment, pull out the plug from AC outlet, and then plug into AC outlet again.
- 2) Turn the power switch ON and set to Service Mode.
- 3) Call the adjusted items again to confirm adjustments were made.

The screen display is :

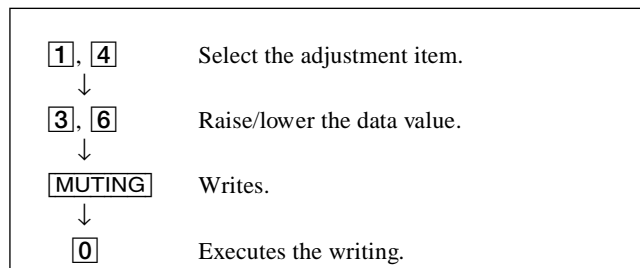
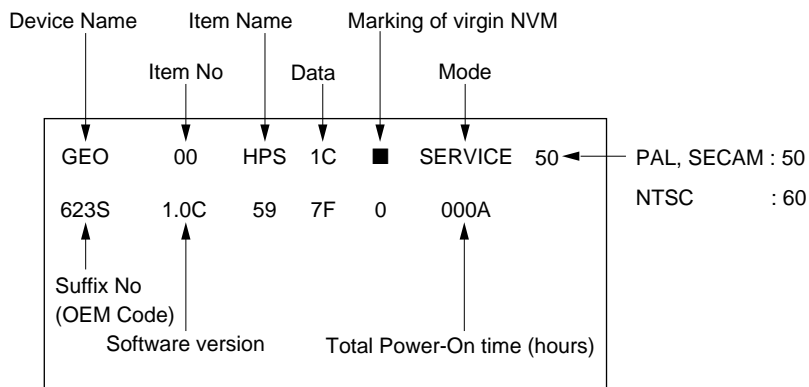

- [7], [0] All the data becomes the values in memory.
- [8], [0] All user control goes to the standard state.
- [5], [0] Service data initialization (Be sure not to use usually.)
- [2], [0] Write 50Hz adjustment data to 60Hz, or vice versa.

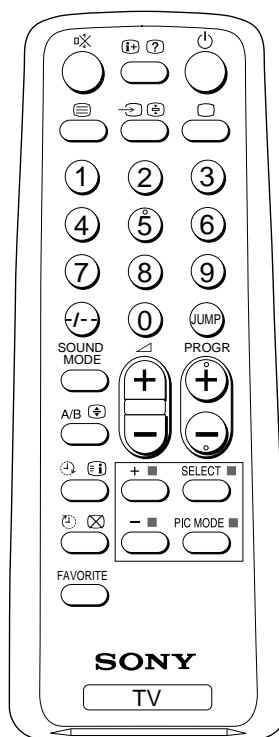

RM-952

4-2. ADJUSTMENT METHOD

Item Number 00 of device GEO

This explanation uses H-Position as an example.

1. Select "GEO 00 HPS" with the **[1]** and **[4]** buttons.
2. Raise/lower the data with the **[3]** and **[6]** buttons.
3. Select the optimum state. (The standard is 1F for PAL reception.)
4. Write with the **[MUTING]** button. (The display changes to WRITE.)
5. Execute the writing with the **[0]** button. (The WRITE display will be changed to red color while excuting, and back to SERVICE.)

Use the same method for all Items. Use **[1]** and **[4]** to select the adjustment item, use **[3]** and **[6]** to adjust, write with **[MUTING]**, then execute the write with **[0]**.

- Note :**
1. In **[WRITE]**, the data for all items are written into memory together.
 2. For adjustment items that have different standard data between 50Hz or 60Hz, be sure to use the respective input signal after adjustment.

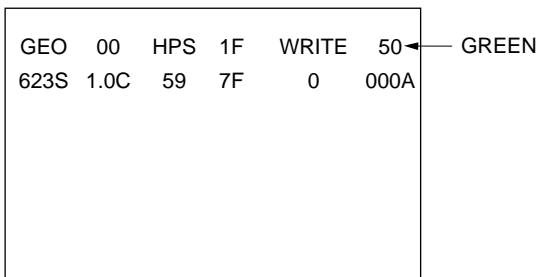
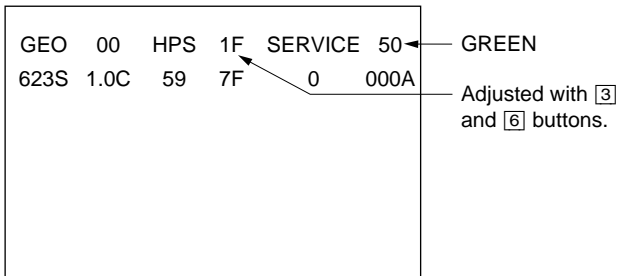

Written with **[MUTING]**

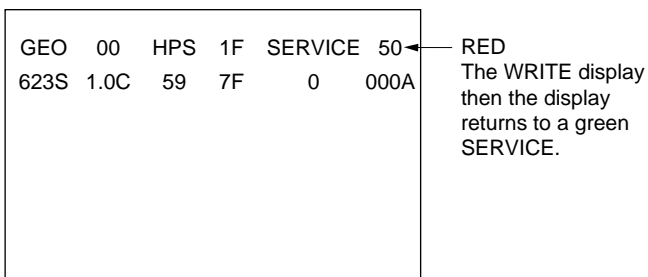

Write executed with **[0]**

Adjustment Item Table

Device Name	Functionality		Note	Data Range	Function	Note for Different Data	Register No. (bit)	Slava Address	RAM Address (bit)
	No	Name							
GEO	0	HPS	7	3F	H Position	50/60HZ	12 (7-2)	CXA2130S(88H)	82 (7-2)
	1	HSZ	1F	3F	H Size	50/60HZ	11 (7-2)		81 (7-2)
	2	PAP	1F	3F	Pin Amp	50/60HZ	13 (7-2)		83 (7-2)
	3	TLT	7	0F	Trapezium	50/60HZ	15 (7-4)		85 (7-4)
	4	VPS	1F	3F	V Position	50/60HZ	0F (7-2)		7F (7-2)
	5	VSZ	1F	3F	V Size	50/60HZ	0E (7-2)		7E (7-2)
	6	SCO	7	0F	S Correction	50/60HZ	10 (7-4)		80 (7-4)
	7	VLN	7	0F	V Linearity	50/60HZ	10 (3-0)		80 (3-0)
	8	BOW	7	0F	AFC Bow	50/60HZ	16 (7-4)		86 (7-4)
	9	AGL	7	0F	AFC-Angle	50/60HZ	16 (3-0)		86 (3-0)
	10	UPN	1F	3F	Upper Pin	50/60HZ	14 (7-2)		84 (7-2)
	11	LPN	1F	3F	Lower Pin	50/60HZ	18 (7-2)		88 (7-2)
	12	HBL	0	1	H Blanking on/off		18 (1)		67 (1)
	13	LBL	7	0F	Left H Blanking	50/60HZ	17 (7-4)		87 (7-4)
14	RBL	7	0F	Right H Blanking	50/60HZ	17 (3-0)	87 (3-0)		
WHB	0	RDR	2A	3F	R Drive	DYNAMIC/others	09 (7-2)	CXA2130S(88H)	8F (7-2)
	1	GDR	2A	3F	G Drive	DYNAMIC/others	0A (7-2)		90 (7-2)
	2	BDR	2A	3F	B Drive	DYNAMIC/others	0B (7-2)		91 (7-2)
	3	RCT	7	0F	R Cutoff	SECAM/others	07 (3-0)		93 (3-0)
	4	GCT	7	0F	G Cutoff	SECAM/others	08 (7-4)		94 (7-4)
	5	BCT	7	0F	B Cutoff	SECAM/others	08 (3-0)		94 (3-0)
	6	BMN	15	1F	Brightness Minimum Data				97
7	SBR	28	3F	Sub Brightness Control			98		
SAJ	0	PMX	33	3F	Picture Maximum Data			CXA2130S(88H)	96
	1	SHU	8	0F	Sub Hue Control	TV/Video			99
	2	SSH	3	0F	Sub Sharpness Control 03/08	TV/Video			9A
	3	SCL	1F	3F	Sub Color Control	NTSC/others			9B
VP	0	EHT	4	0F	EHT Comp	50/60HZ	15 (3-0)	CXA2130S(88H)	85 (3-0)
	1	GMA	2	03	Gamma Correction	Refer NVM Map A4	0B (1-0)		1A3 (1-0)
	2	YDL	6	0F	Y Delay	PAL/SECAM/NTSC	0C (3-0)		8C (3-0)
	3	SST	1	03	SECAM ID Start Position		1B (1-0)		6A (1-0)
	4	SSP	1	03	SECAM ID Stop Position		1B (3-2)		6A (3-2)
	5	SLV	2	03	SECAM ID Level		1C (1-0)		6B (1-0)
	6	SBF	22	3F	SECAM BELL f0		1C (7-2)		6B (7-2)
	7	DYC	0	1	Dynamic Color on/off		0A (1)		59 (1)
	8	ABL	1	1	ABL Mode Switching	STANDARD Always 0	09 (1)		58 (1)
	9	VTH	1	1	ABL Detection Vth Switching		09 (0)		58 (0)
	10	SFO	1	1	FO Switching for Sharpness	NTSC/others	05 (1)		198 (1)
	11	DCX	1	1	DC Trans. Ratio Switching		06 (1)		55 (1)
12	SHT	1	1	Pre-/Overshoot ratio Switch	NTSC/others	06 (0)	199 (0)		

Adjustment Item Table

Device Name	Functionality		Note	Data Range	Function	Note for Different Data	Register No. (bit)	Slava Address	RAM Address (bit)
	No	Name							
VP	13	HDW	0	1	H Drive Pulse Width Switch	TV/Video/Text	00 (6)		4F (6)
	14	AFC	1	03	AFC Gain Control		0F (1-0)		8D (1-0)
	15	HOS	7	0F	H Oscillation		0C (7-4)		5B (7-4)
	16	HSS	0	1	Slice Level of H Sync Sep.		0D (1)		5C (1)
	17	VSS	0	1	Slice Level of V Sync Sep.	0D (0)	5C (0)		
	18	HMS	0	1	Macro Vision C/m off/on	50/60Hz 0E (0)	7E (0)		
	19	YUV	0	1	YUV Switch Control	01 (0)	50 (0)		
	20	CDV	2	3	CD mode for Video	Video only 0D (5-4)	1A1 (5-4)		
	21	RON	1	1	R ON	not memorized 01 (3)	50 (3)		
	22	GON	1	1	G ON	not memorized 01 (2)	50 (2)		
	23	BON	1	1	B ON	not memorized 01 (1)	50 (1)		
	24	PON	1	1	P ON	not memorized 00 (7)	4F (7)		
	25	BLK	0	1	BLK Off	12 (0)	61 (0)		
	26	VMC	0	1	VM Off	13 (0)	62 (0)		
AP	0	INF	0	3F	Input Attenuation When surround off		00 (5-0)	TDA7429	19F (5-0)
	1	INS	0	3F	Input Attenuation When surround on		02		1A0 (5-0)
	2	PH1	0	3	Phase 1 Register Selection				76 (1-0)
	3	PH2	0	3	Phase 2 Register Selection				76 (3-2)
	4	PH3	0	3	Phase 3 Register Selection				76 (5-4)
	5	PH4	0	3	Phase 4 Register Selection		76 (7-6)		
	6	BCS	2	3	Bass Center Shift		#4 (3-0)	1A8 (1-0)	
	7	TCS	2	3	Treble Center Shift		#5 (3-0)	1A9 (1-0)	
8	TRF	2	3	RF Treble Offset	#5 (3-0)	1A9 (5-4)			
MSP	0	WST	15	FF	W/G Stereo Threshold			MSP3415D (84H)	157 (7-0)
	1	WBT	EC	FF	W/G Bilingual Threshold			158 (7-0)	
	2	WLL	5	FF	W/G Monaural Threshold			159 (7-0)	
	3	WAC	0	0F	W/G Agreement Count			15A (3-0)	
	4	WDL	30	FF	W/G Search Delay			15B (7-0)	
	5	NDL	20	FF	NICAM Search Delay			15C (7-0)	
	6	SDL	10	FF	Stereo status Read Delay			15D (7-0)	
	7	AGC	0	1	AGC Switch Auto/Constant			BB (7)	108 (7)
	8	REL	0D	3F	AGC Gain at Constant Mode			BB (6-1)	108 (6-1)
	9	CRM	0	1	Carrier muting on/off			BB (9)	107 (1)
	10	ACO	1	1	Audio Clock out on/off			83 (5)	10C (5)
	11	FP	1B	7F	FM Prescale for non-M system			0E (7-0)	16C (6-0)
	12	FPM	32	7F	FM Prescale for M system			0E (7-0)	16D (6-0)
	13	FH	36	7F	FM Prescale for HDEV			0E (7-0)	16E (6-0)
	14	FHM	65	7F	FM Prescale for HDEV and M			0E (7-0)	16F (6-0)
	15	WGP	2A	7F	W/G Prescale			0E (7-0)	170 (6-0)
	16	NIP	6D	7F	NICAM Prescale			10 (7-0)	138 (6-0)
	17	ERR	50	FF	Auto FM switch Threshold			21 (10-3)	166 (7-0)
18	VOL	6D	FF	Loud Speaker gain 7000h to 7f0h	0000 (15-4)	1A7 (7-0)			

Adjustment Item Table

Device Name	Functionality		Note	Data Range	Function	Note for Different Data	Register No. (bit)	Slava Address	RAM Address (bit)
	No	Name							
TXT	0	TXH	1	3	Teletext Horizontal Position			(58H)	18D (1-0)
	1	TXV	0	3	Teletext Vertical Position				18D (6-4)
OPM	0	OSH	0A	3F	OSD H Position	Option-Misc			AC (7-2)
	1	COM	0	03	Comb Selection				A5 (7-6)
	2	APC	1	1	APC Switch				A4 (5)
	3	TSY	0	03	TV Sys at Auto TV Sys				A4 (4-3)
	4	MUT	0	1	No Signal Mute				A4 (0)
	5	AFM	1	1	Auto FM switch				A4 (1)
	6	RFB	0	3	C-BPF Control				A5 (5-4)
	7	TV0	0	7	Tilt to V-Angle offset				A5 (2-0)
8	DBL	0	1	Disable Blueback Function			A4 (2)		
OPB	0	OP1	0	FF	Optional Bits 1 (see below)	Option-Bits			45
	1	OP2	0	FF	Optional Bits 2 (see below)				46
	2	OP3	0	FF	Optional Bits 3 (see below)				47

NOTE

- ■ shaded items are fixed data.
- Standard data listed on the Adjustment Item Table are reference values, therefore it may be different for each model and for each mode.
- Note for Different Data Those are the standard data values written on the microprocessor. Therefore, the data values of the modes and stored respectively in the memory.
In case of a device replacement, adjustment by rewriting the data value is necessary for some items.

ITEM INFORMATION.

No. OPB0 OP1

Item	XTAL 4.43	XTAL 3.58	SECAM	2nd. Lang	B/G	I	D/K	M
KV-PF21M70	1	1	1	1	1	1	1	1
KV-TF21M61	1	1	1	1	1	1	1	1
KV-PF21M90	1	1	1	1	1	1	1	1
KV-PF21P11	1	1	0	1	1	0	0	0

No. OPB1 OP2

Item	TOP	NICAM	HDEV	Thai Bil	Dis Fav.	DVD Input	AV Input
KV-PF21M70	0	0	0	0	0	0	1
KV-TF21M61	0	1	1	0	0	0	1
KV-PF21M90	0	1	1	0	0	0	1
KV-PF21P11	0	0	0	0	0	0	1

No. OPB2 OP3

Item	Pic Rot	2199 Curve	Auto PIC	Auto TV sys	US ST	AV Mono	11 KEY	Color SW
KV-PF21M70	0	0	0	0	0	0	0	0
KV-TF21M61	1	0	0	0	0	0	0	0
KV-PF21M90	1	0	0	0	0	0	0	0
KV-PF21P11	0	0	0	0	0	0	0	0

4-3. PICTURE QUALITY ADJUSTMENTS

SUB COLOR ADJUSTMENT

1. Input a PAL color-bar.
2. Set to the following condition:
PICTURE 100%, BRIGHTNESS 50%, COLOR 50%
3. Connect an oscilloscope to pin ① (B OUT) of CN305, A board.
4. Set to Service Mode and select SAJ 3 'SCL' with **[1]** and **[4]** of the commander then adjust to VB2=VB3=VB4 with **[3]** and **[6]**.
5. Press **[MUTING]** → **[0]** of the commander to write the data.
6. Adjust SAJ 3 'SCL' as step 2 to 5 when receiving NTSC color-bar.

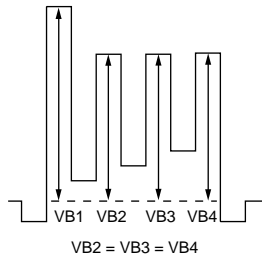

SUB HUE ADJUSTMENT

1. Select Video 1.
2. Input a NTSC color-bar, video into Video 1.
3. Set the following condition:
PICTURE 100%, BRIGHTNESS 50%, COLOR 50%
4. Connect an oscilloscope to pin ① (B OUT) of CN305, A board.
5. Select SAJ 1 'SHU' with **[1]** and **[4]** of the commander by setting to Service Mode and adjust to VB1=VB2=VB3=VB4 with **[3]** and **[6]**.

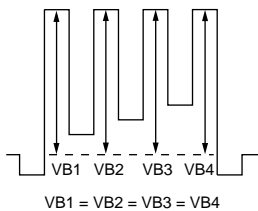

6. Press **[MUTING]** → **[0]** of the commander to write the data.

BELL FILTER ADJUSTMENT

1. Input SECAM color-bar signal.
2. Connect the dual-trace oscilloscope to the pin ⑨ (R-Y) of CN303 (not mounted).
3. Adjust SERVICE MODE, ITEMS 'SBF' as shown below.

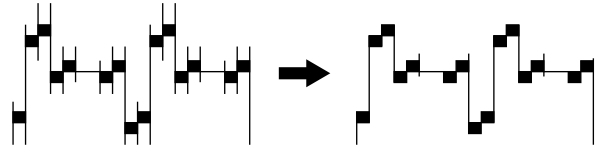

4-4. A BOARD ADJUSTMENT AFTER IC003 (MEMORY) REPLACEMENT

When replacing IC003 (MEMORY), be sure to change IC001 (μ-COM) to the following new IC at the same time.

IC001 (μ-CON) : CXP86449-623S

1. Enter to Service Mode.
2. Press commander buttons **[5]** and **[0]** (Data Initialize), and **[2]** and **[0]** (Data Copy) to initialize the data.
3. Call each item number and check if the respective screen shows the normal picture.
In cases where items are not well adjusted, rectify the items with fine adjustment.
Write the data per each item number (**[MUTING]** + **[0]**).
4. Select item numbers "OPB0" (OP1), "OPB1" (OP2) and "OPB2" (OP3) and respectively set the bit per model with command buttons **[3]** and **[6]**.
5. Press commander buttons **[8]** and **[0]** (Test Normal) to return to the data that was set on the shipment from the factory. (This will also cancel Service Mode.)

4-5. PICTURE DISTORTION ADJUSTMENT

Item Number 00 – 0B

GEO 0 HSH (H POSITION)

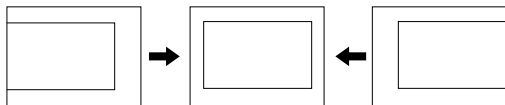

GEO 1 HSZ (H SIZE)



GEO 2 PAP (PIN AMP)

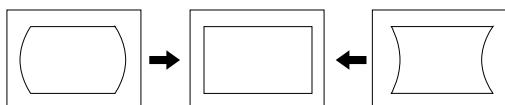

GEO 3 TILT (TRAPEZIUM)

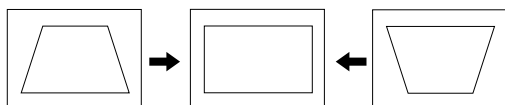

GEO 4 VSH (V POSITION)

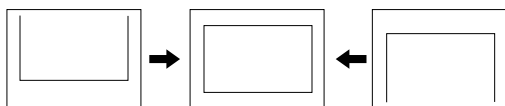

GEO 5 VSZ (V SIZE)

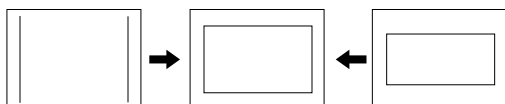

GEO 6 SCR (VERTICAL S-Correction)

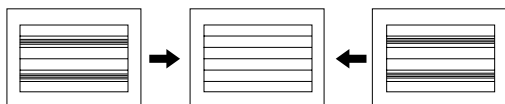

GEO 7 VLN (V LINEARITY)

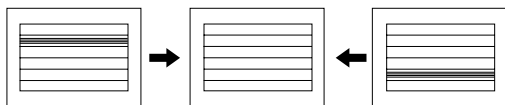

GEO 8 VBOW (AFC.BOW)

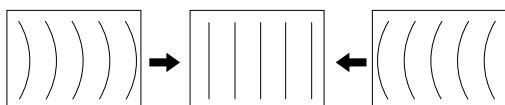

GEO 9 AGL (AFC.ANGLE)

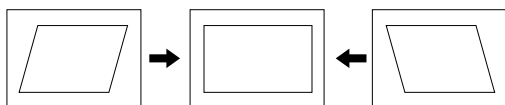

GEO 0A UCP (UPPER CORNER PIN)

GEO 0B LCP (LOWER CORNER PIN)

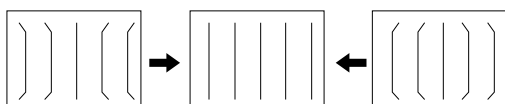

**SECTION 5
DIAGRAM**

KV-PF21M70/TF21M61/TF21M90/TF21P11
RM-952

KV-PF21M70/TF21M61/TF21M90/TF21P11
RM-952

KV-PF21M70/TF21M61/TF21M90/TF21P11
RM-952

5-1. BLOCK DIAGRAM

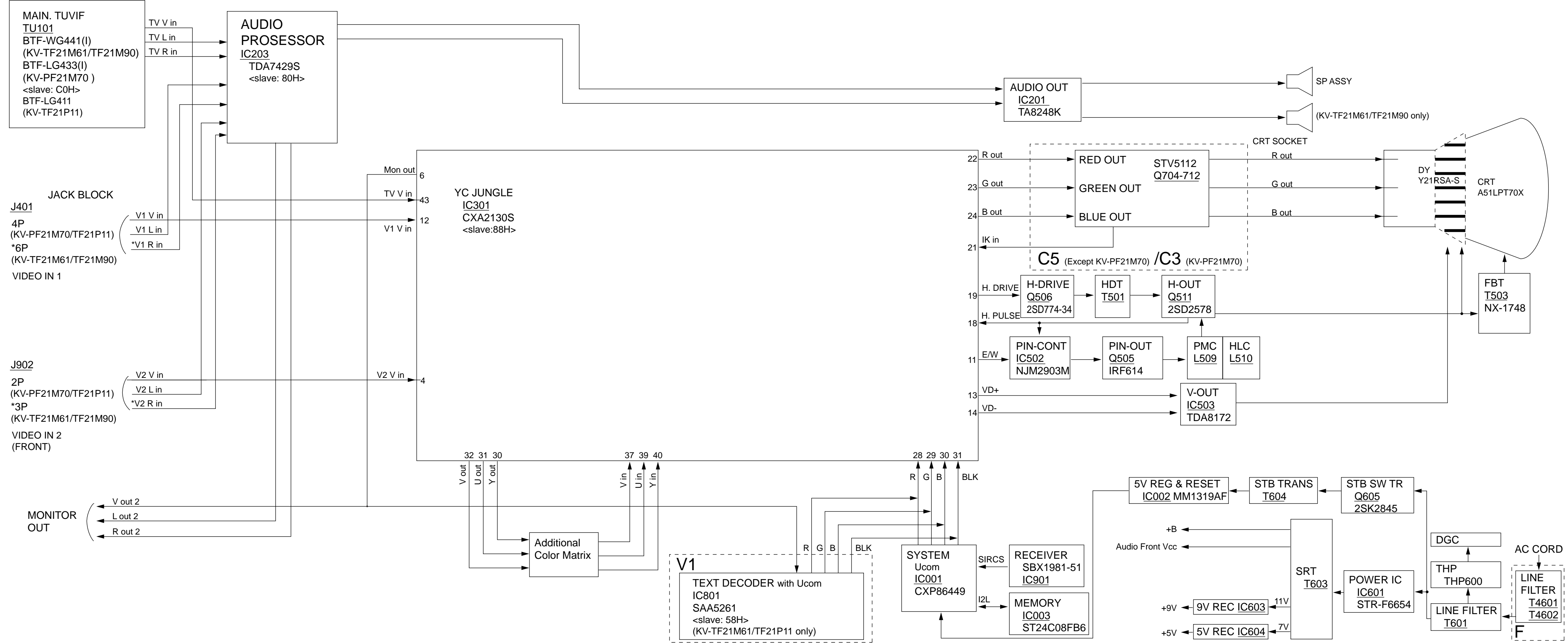







5-4. SCHEMATIC DIAGRAMS AND PRINTED WIRING BOARDS

Note:

- All capacitors are in μF unless otherwise noted.
- All electrolytic capacitors are rated at 50V unless otherwise noted.
- All resistors are in ohms.
 $\text{k}\Omega = 1000\Omega$, $\text{M}\Omega = 1000\text{k}\Omega$
- Indication of resistance which does not have rating electrical power is as follows.

Pitch: 5 mm
 Rating electrical power 1/4W (CHIP: 1/10W)

-  : nonflammable resistor.
-  : internal component.
-  : panel designation or adjustment for repair.
- All variable and adjustable resistors have characteristic curve B unless otherwise noted.
- **Readings are taken with a color-bar signal input.**
 no mark : PAL
 () : SECAM
 [] : NTSC 3.58
 « » : NTSC 4.43
- **Readings are taken with a 10 M Ω digital multimeter.**
- **Voltage are dc with respect to ground unless otherwise noted.**
- **Voltage variations may be noted due to normal production tolerances.**
- **All voltages are in V.**
- * : Cannot be measured.
- **Circled numbers are waveform references.**
-  : B + bus.
-  : B - bus.
-  : signal path.

Reference information

RESISTOR	: RN	METAL FILM
	: RC	SOLID
	: FPRD	NONFLAMMABLE CARBON
	: FUSE	NONFLAMMABLE FUSIBLE
	: RS	NONFLAMMABLE METAL OXIDE
	: RB	NONFLAMMABLE CEMENT
	: RW	NONFLAMMABLE WIREWOUND
	: ✕	ADJUSTMENT RESISTOR
COIL	: LF-8L	MICRO INDUCTOR
CAPACITOR	: TA	TANTALUM
	: PS	STYROL
	: PP	POLYPROPYLENE
	: PT	MYLAR
	: MPS	METALIZED POLYESTER
	: MPP	METALIZED POLYPROPYLENE
	: ALB	BIPOLAR
	: ALT	HIGH TEMPERATURE
	: ALR	HIGH RIPPLE

Note: The component identified by shading and mark Δ are critical for safety. Replace only with part number specified.

A BOARD IC001 CXP86449-623S

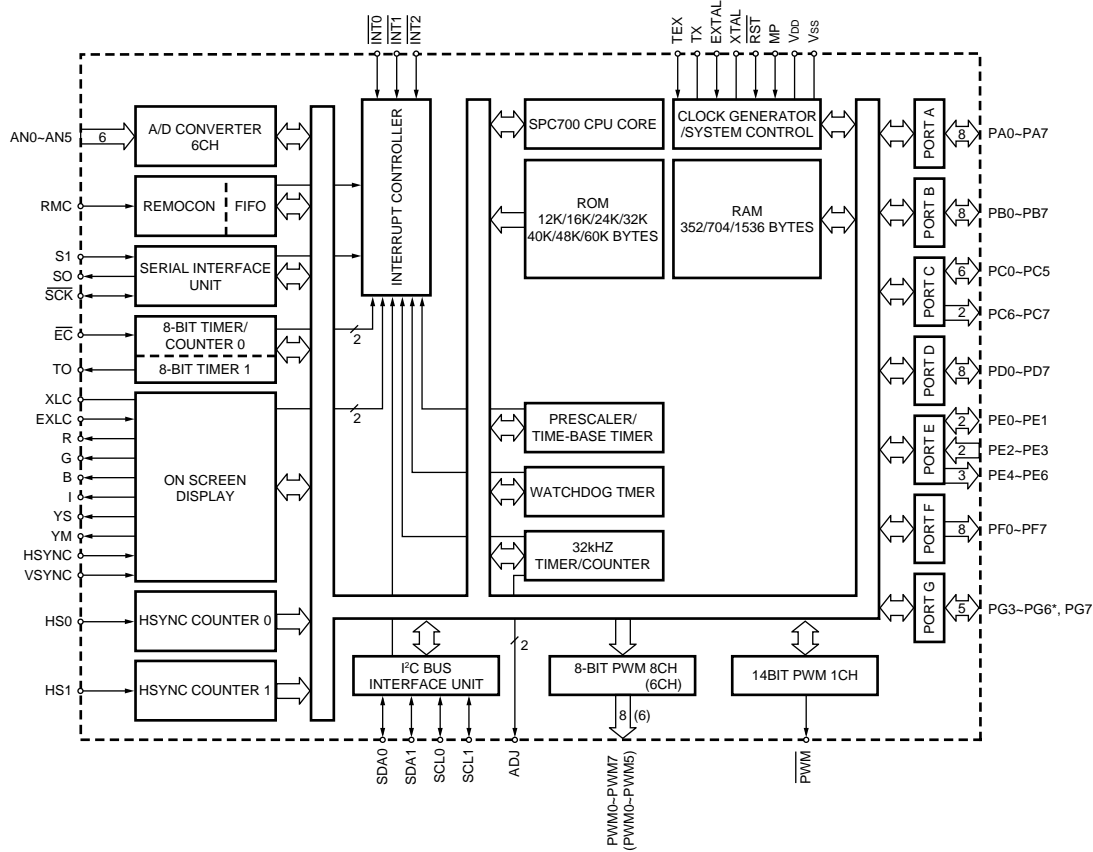

5-5. SEMICONDUCTORS

DIODE

AK04V0
AU-01Z-V1
EL1Z
GP08D
RD33EB3T
RGP02-17EL-6433

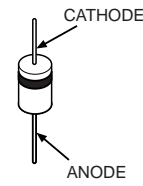

D4SB60L

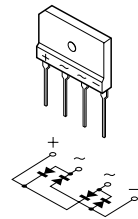

ERC04-06SE
ERC06-15S
RN4Z
31DQ06-FC5

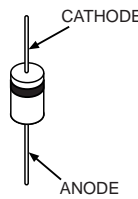

ERA22-08
ERD29-08J

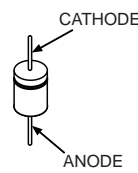

MA111-TX
1SS355TE-17
DTZ-TT11-15B
RD10S-B
RD5.1SB-T2
RD9.1S-B
UDZS-TE17-6.8B

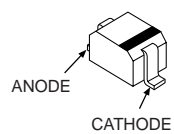

ON3171-R

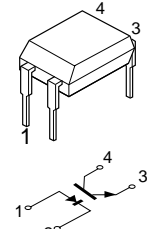

D1NS4
D1N20R
RD20ES-B2
RD30ESB2
RD6.8ES-B1
RD9.1ES-L2
1SS119-25

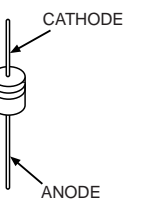

5P6M

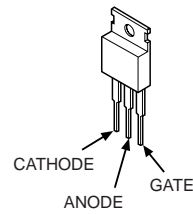

DA204K

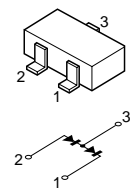

FMU-G26S

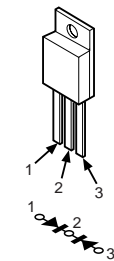

TRANSISTOR

UN2111
UN2211
UN2213
DTC114EK
UN2216
2SA1162-G
2SC1623-L5L6
2SC2712-YG
2SD2114K

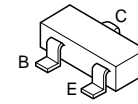

2SC2785-HFE

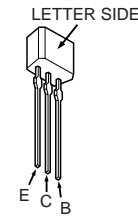

2SA1091-O

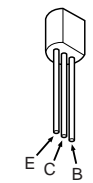

2SD2394-EF

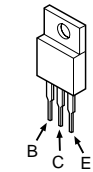

2SD2144S-UVW

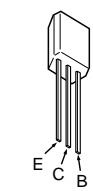

2SC2611

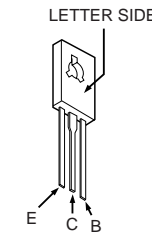

2SC4927-01

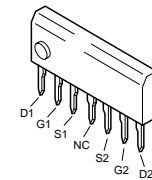

2SD774-34

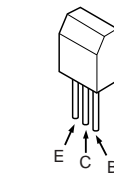

RF614

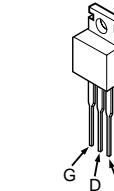

2SK2845-LB102

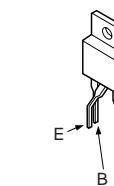

IC

CXA2130S (64PIN)
CXP86469-615S (64PIN)
SAA5261 (52PIN)
ST24C08FB6 (8PIN)
TDA7429S (42PIN)



Dual In-line Package
Pin 6-98

MM1319AFBE (7PIN)
NJM2903M (8PIN)

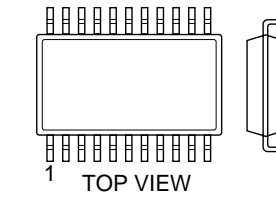

Single In-line Package
Pin 6-98

NJM78M09FA
TA7805S

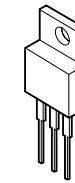

SBX1981-51

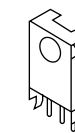

SE-135N

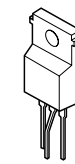

TDA8172

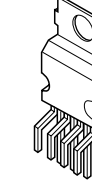

STR-F6654

MARKING SIDE VIEW

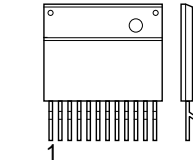

Zig-zag In-line Package
Pin 6-99

RU-1P

MARKING SIDE VIEW

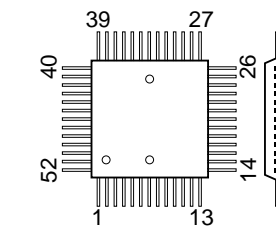

S-80743AL-A7-S

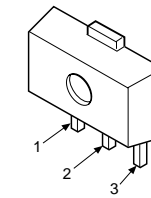

TA8248K

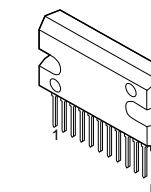

SECTION 6
EXPLODED VIEWS

NOTE:

- Items with no part number and no description are not stocked because they are seldom required for routine service.
- The construction parts of an assembled part are indicated with a collation number in the remark column.
- Items marked " * " are not stocked since they are seldom required for routine service. Some delay should be anticipated when ordering these items.

The components identified by shading and mark Δ are critical for safety. Replace only with part number specified.

6-1. CHASSIS (KV-PF21M70)

- : BVTP 3 x 12 7-685-648-79
- : BVTP 4 x 16 7-685-663-71

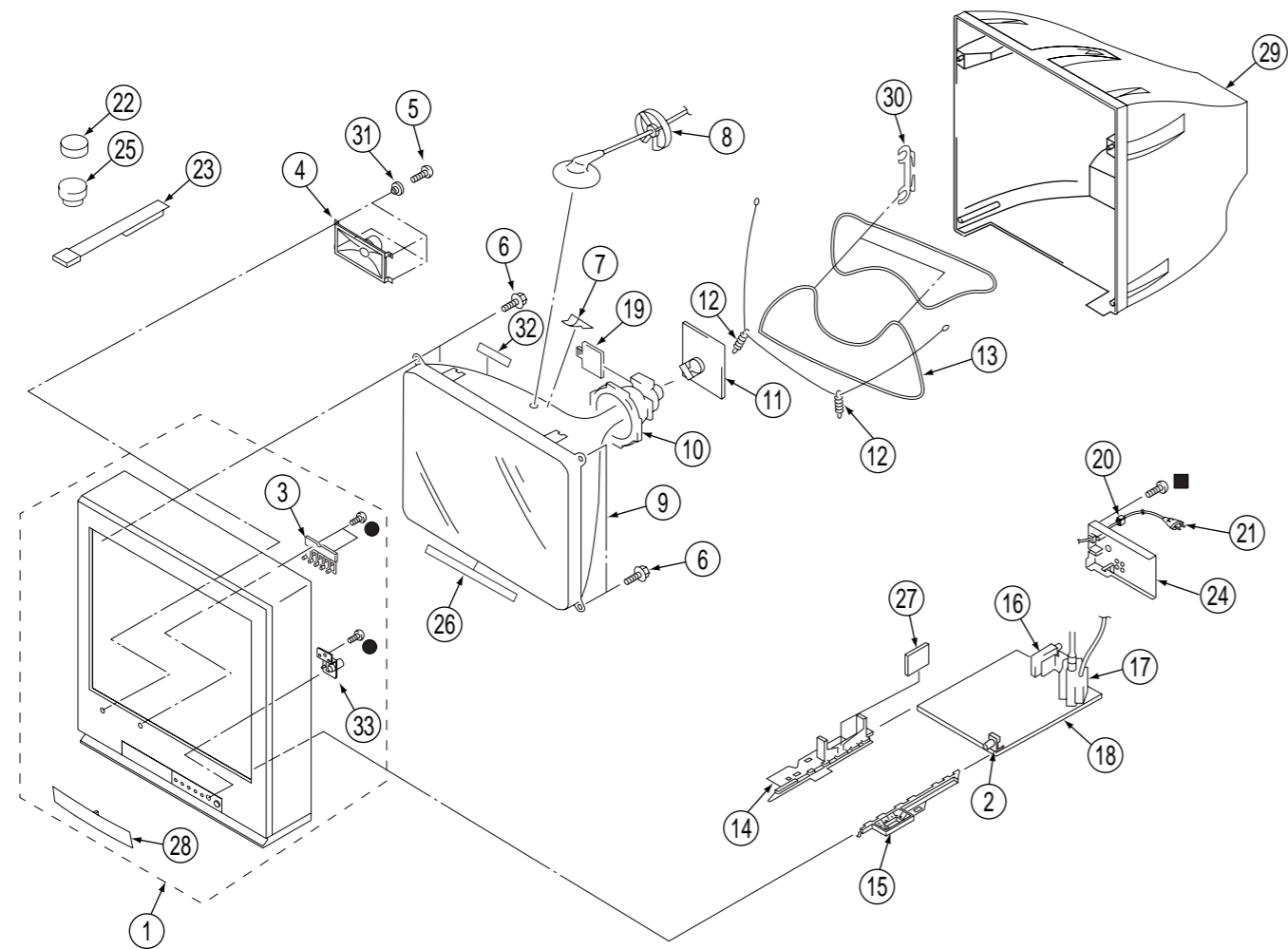

REF. NO.	PART NO.	DESCRIPTION	REMARK
(KV-PF21M70)			
1	X-4036-748-1	BEZNET ASSY	3, 28, 33
2	4-070-291-01	BUTTON, POWER	
3	4-070-290-01	BUTTON, MULTI	
4	1-505-740-11	SPEAKER (5X9CM)	
5	4-054-981-01	SCREW, STEP TAPPING	
6	4-365-808-01	SCREW (5), TAPPING	
7	4-046-600-11	SPACER, DY	
8	* 3-704-372-11	HOLDER, HV CABLE	
9	Δ 8-738-809-05	PICTURE TUBE (A51LPT70X)	
10	8-451-505-11	DEFLECTION YOKE (Y21RSA-S)	
11	* A-1331-884-A	C3 BOARD, MOUNTED	
12	4-369-318-61	SPRING, TENSION	
13	Δ 1-416-946-11	COIL, DEMAGNETIC	
14	* 4-067-189-01	PWB(L), GUIDE	
15	* 4-067-187-01	PWB(R), GUIDE	
16	8-598-449-01	TUNER, FSS BTF-LG433	
17	Δ 1-453-293-11	TRANSFORMER ASSY, FLYBACK (NX-1748/M3A4)	
18	* A-1298-955-A	A BOARD, COMPLETE	
19	4-057-714-01	PIECE ASSY, TLH CORRECTION	
20	4-022-115-00	HOLDER, AC CORD	
21	Δ 1-769-609-21	CORD, POWER (WITH CONNECTOR)	
22	1-452-032-00	MAGNET, DISC	
23	4-051-736-21	PIECE A(90), CONV. CORRECT	
24	4-067-167-21	BRACKET, TERMINAL	
25	1-452-094-00	CIRCULAR DISC MAGNET B	
26	4-069-651-01	BLOTTING SHEET	
27	* A-1241-355-A	F BOARD, MOUNTED	
28	X-4036-750-1	DOOR ASSY, CONTROL	
29	Δ 4-070-300-01	COVER, REAR	
30	4-064-883-11	HOLDER, DGC	
31	* 4-379-189-12	CUSHION, SPEAKER	
32	4-069-652-01	CUSHION (HS BAND)	
33	* 4-070-292-01	BAR, OPTICAL	

6-2. CHASSIS (KV-TF21M61/TF21M90/TF21P11)

- : BVTP 3 × 12 7-685-648-79
- : BVTP 4 × 16 7-685-663-71

NOTE: The picture tube for OCE model is upside down, and the position anode cap and tension springs are changed accordingly.

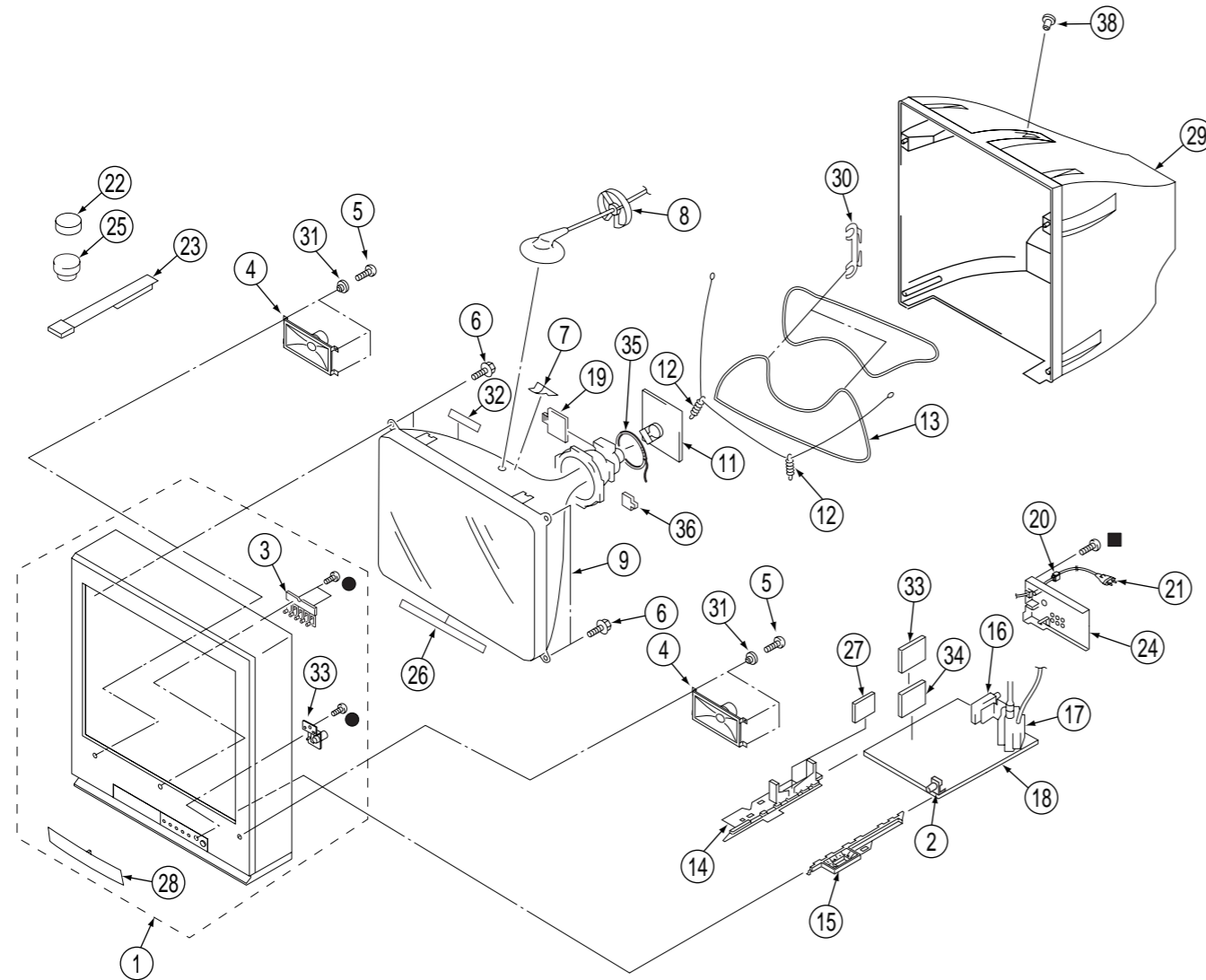

REF. NO.	PART NO.	DESCRIPTION	REMARK
(KV-TF21M61/TF21M90/TF21P11)			
1	X-4036-744-1	BEZNET ASSY (KV-TF21M61)	3, 28, 37
	X-4036-745-1	BEZNET ASSY (KV-TF21M90)	3, 28, 37
	X-4036-744-2	BEZNET ASSY (KV-TF21P11)	3, 28, 37
2	4-070-291-01	BUTTON, POWER	
3	4-070-290-01	BUTTON, MULTI	
4	1-505-740-11	SPEAKER (5X9CM)	
5	4-054-981-01	SCREW, STEP TAPPING	
6	4-365-808-01	SCREW (5), TAPPING	
7	4-046-600-11	SPACER, DY	
8	* 3-704-372-11	HOLDER, HV CABLE	
9	△ 8-738-809-05	PICTURE TUBE (A51LPT70X) (KV-TF21M90)	
	△ 8-738-812-05	PICTURE TUBE (A51LPT70X) (EXCEPT KV-TF21M90)	
10	8-451-505-11	DEFLECTION YOKE (Y21RSA-S)	
11	* A-1331-941-A	C5 BOARD, MOUNTED	
12	4-369-318-61	SPRING, TENSION	
13	1-416-946-11	COIL, DEMAGNETIC	
14	* 4-067-189-01	PWB(L), GUIDE	
15	* 4-067-187-01	PWB(R), GUIDE	
16	8-598-451-00	TUNER, FSS-BTF-WG441 (EXCEPT KV-TF21P11)	
	8-598-447-00	TUNER, FSS-BTF-LG411 (KV-TF21P11)	
17	△ 1-453-293-11	TRANSFORMER ASSY, FLYBACK (NX-1748/M3A4)	
18	* A-1298-942-A	A BOARD, COMPLETE (KV-TF21M61)	
	* A-1298-951-A	A BOARD, COMPLETE (KV-TF21M90)	
	* A-1298-968-A	A BOARD, COMPLETE (KV-TF21P11)	
19	4-057-714-01	PIECE ASSY, TLH CORRECTION	
20	4-022-115-00	HOLDER, AC CORD	
21	△ 1-574-062-11	CORD, POWER (WITH CONNECTOR) 2.5A/250V (KV-TF21M61)	
	△ 1-769-609-21	CORD, POWER (WITH CONNECTOR) (KV-TF21M90)	
	△ 1-574-358-11	CORD, POWER (WITH CONNECTOR) (KV-TF21P11)	
22	1-452-032-00	MAGNET, DISC	
23	4-051-736-21	PIECE A(90), CONV. CORRECT	
24	4-067-167-01	BRACKET, TERMINAL	
25	1-452-094-00	CIRCULAR DISC MAGNET B (EXCEPT KV-TF21P11)	
	1-452-014-11	CIRCULAR DISC MAGNET B (KV-TF21P11)	
26	4-069-651-01	BLOTTING SHEET	
27	* A-1241-355-A	F BOARD, MOUNTED	
28	X-4036-760-1	DOOR ASSY, CONTROL (KV-TF21M61)	
	X-4036-761-1	DOOR ASSY, CONTROL (KV-TF21M90)	
	X-4036-760-2	DOOR ASSY, CONTROL (KV-TF21P11)	
29	△ 4-070-300-01	COVER, REAR	
30	4-064-883-11	HOLDER, DGC	
31	* 4-379-189-12	CUSHION, SPEAKER	
32	4-069-652-01	CUSHION (HS BAND)	
33	* A-1347-155-A	V1 BOARD, COMPLETE (KV-TF21M61/TF21P11 ONLY)	
34	* 4-068-953-01	BRACKET, V1 (KV-TF21M61/TF21P11 ONLY)	
35	1-452-728-61	COIL, NA ROTATION (RT-154)	
36	4-034-272-11	PLATE, CORRECTION, TLV (KV-TF21P11 ONLY)	
37	* 4-070-292-01	BAR, OPTICAL	
38	4-038-462-01	CAP, ANTENNA	

SECTION 7

ELECTRICAL PARTS LIST

A (KV-PF21M70)

NOTE:

The components identified by shading and mark \triangle are critical for safety. Replace only with part number specified.

When indicating parts by reference number, please include the board name.

• Items marked " * " are not stocked since they are seldom required for routine service. Some delay should be anticipated when ordering these items.

• All variable and adjustable resistors have characteristic curve B, unless otherwise noted.

• All resistors are in ohms
• F : nonflammable

CAPACITORS

• MF : μ F, PF : μ MF

COILS

• MMH : mH, UH : μ H

REF.NO.	PART NO.	DESCRIPTION	REMARK	REF.NO.	PART NO.	DESCRIPTION	REMARK
* A-1298-955-A	A BOARD,COMPLETE (KV-PF21M70)	*****		C107	1-163-005-11	CERAMIC CHIP 470PF	10% 50V
* 4-055-304-01	HOLDER, LED			C108	1-126-933-11	ELECT 100MF	20% 16V
* 4-067-182-02	HOLDER, FBT			C109	1-163-005-11	CERAMIC CHIP 470PF	10% 50V
4-382-854-11	SCREW (M3X10), P, SW (+)			C110	1-163-005-11	CERAMIC CHIP 470PF	10% 50V
4-382-854-21	SCREW (M3X14), P, SW (+)			C111	1-163-005-11	CERAMIC CHIP 470PF	10% 50V
7-685-648-79	SCREW +BVTP 3X12 TYPE2 IT-3			C112	1-126-933-11	ELECT 100MF	20% 16V
	<CAPACITOR>			C113	1-126-967-11	ELECT 47MF	20% 50V
C003	1-163-251-11	CERAMIC CHIP 100PF	5% 50V	C114	1-126-967-11	ELECT 47MF	20% 50V
C004	1-163-001-11	CERAMIC CHIP 220PF	10% 50V	C202	1-163-021-91	CERAMIC CHIP 0.01MF	10% 50V
C005	1-163-001-11	CERAMIC CHIP 220PF	10% 50V	C204	1-136-153-00	FILM 0.01MF	5% 50V
C006	1-164-004-11	CERAMIC CHIP 0.1MF	10% 25V	C209	1-104-664-11	ELECT 47MF	20% 16V
C007	1-126-933-11	ELECT 100MF	20% 16V	C210	1-126-933-11	ELECT 100MF	20% 16V
C008	1-163-251-11	CERAMIC CHIP 100PF	5% 50V	C211	1-126-941-11	ELECT 470MF	20% 25V
C010	1-163-251-11	CERAMIC CHIP 100PF	5% 50V	C212	1-126-933-11	ELECT 100MF	20% 16V
C012	1-163-251-11	CERAMIC CHIP 100PF	5% 50V	C215	1-126-942-61	ELECT 1000MF	20% 25V
C013	1-163-021-91	CERAMIC CHIP 0.01MF	10% 50V	C216	1-163-021-91	CERAMIC CHIP 0.01MF	10% 50V
C014	1-126-967-11	ELECT 47MF	20% 50V	C218	1-136-167-00	FILM 0.15MF	5% 50V
C015	1-163-009-11	CERAMIC CHIP 0.001MF	10% 50V	C220	1-126-942-61	ELECT 1000MF	20% 25V
C016	1-163-113-00	CERAMIC CHIP 68PF	5% 50V	C221	1-126-964-11	ELECT 10MF	20% 50V
C017	1-163-113-00	CERAMIC CHIP 68PF	5% 50V	C223	1-126-965-11	ELECT 22MF	20% 50V
C019	1-104-665-11	ELECT 100MF	20% 25V	C224	1-163-133-00	CERAMIC CHIP 470PF	5% 50V
C022	1-163-227-11	CERAMIC CHIP 10PF	0.5PF 50V	C226	1-109-982-11	CERAMIC CHIP 1MF	10% 10V
C023	1-163-227-11	CERAMIC CHIP 10PF	0.5PF 50V	C227	1-163-037-11	CERAMIC CHIP 0.022MF	10% 50V
C024	1-163-227-11	CERAMIC CHIP 10PF	0.5PF 50V	C228	1-163-024-00	CERAMIC CHIP 0.018MF	10% 50V
C026	1-164-004-11	CERAMIC CHIP 0.1MF	10% 25V	C229	1-163-018-00	CERAMIC CHIP 0.0056MF	10% 50V
C027	1-164-004-11	CERAMIC CHIP 0.1MF	10% 25V	C230	1-163-024-00	CERAMIC CHIP 0.018MF	10% 50V
C028	1-163-037-11	CERAMIC CHIP 0.022MF	10% 50V	C231	1-163-018-00	CERAMIC CHIP 0.0056MF	10% 50V
C030	1-126-965-11	ELECT 22MF	20% 50V	C232	1-163-037-11	CERAMIC CHIP 0.022MF	10% 50V
C031	1-164-004-11	CERAMIC CHIP 0.1MF	10% 25V	C233	1-164-004-11	CERAMIC CHIP 0.1MF	10% 25V
C032	1-107-823-11	CERAMIC CHIP 0.47MF	10% 16V	C234	1-164-004-11	CERAMIC CHIP 0.1MF	10% 25V
C034	1-163-031-11	CERAMIC CHIP 0.01MF	50V	C235	1-164-004-11	CERAMIC CHIP 0.1MF	10% 25V
C041	1-163-251-11	CERAMIC CHIP 100PF	5% 50V	C236	1-164-004-11	CERAMIC CHIP 0.1MF	10% 25V
C042	1-163-251-11	CERAMIC CHIP 100PF	5% 50V	C238	1-164-505-11	CERAMIC CHIP 2.2MF	16V
C043	1-163-251-11	CERAMIC CHIP 100PF	5% 50V	C240	1-164-505-11	CERAMIC CHIP 2.2MF	16V
C044	1-163-251-11	CERAMIC CHIP 100PF	5% 50V	C241	1-164-346-11	CERAMIC CHIP 1MF	16V
C047	1-163-251-11	CERAMIC CHIP 100PF	5% 50V	C242	1-164-505-11	CERAMIC CHIP 2.2MF	16V
C048	1-163-251-11	CERAMIC CHIP 100PF	5% 50V	C243	1-216-295-91	SHORT 0	
C050	1-163-251-11	CERAMIC CHIP 100PF	5% 50V	C244	1-164-700-11	CERAMIC CHIP 0.68MF	16V
C051	1-163-251-11	CERAMIC CHIP 100PF	5% 50V	C245	1-164-346-11	CERAMIC CHIP 1MF	16V
C053	1-163-251-11	CERAMIC CHIP 100PF	5% 50V	C246	1-163-018-00	CERAMIC CHIP 0.0056MF	10% 50V
C054	1-163-251-11	CERAMIC CHIP 100PF	5% 50V	C248	1-163-010-11	CERAMIC CHIP 0.0012MF	10% 50V
C055	1-163-251-11	CERAMIC CHIP 100PF	5% 50V	C249	1-164-004-11	CERAMIC CHIP 0.1MF	10% 25V
C103	1-164-004-11	CERAMIC CHIP 0.1MF	10% 25V	C251	1-163-017-00	CERAMIC CHIP 0.0047MF	10% 50V
C104	1-126-933-11	ELECT 100MF	20% 16V	C252	1-164-346-11	CERAMIC CHIP 1MF	16V
				C253	1-163-037-11	CERAMIC CHIP 0.022MF	10% 50V
				C254	1-126-965-11	ELECT 22MF	20% 50V
				C255	1-163-037-11	CERAMIC CHIP 0.022MF	10% 50V
				C256	1-164-004-11	CERAMIC CHIP 0.1MF	10% 25V

The components identified by shading and mark Δ are critical for safety. Replace only with part number specified.

A (KV-PF21M70)

REF. NO.	PART NO.	DESCRIPTION	REMARK
C259	1-126-933-11	ELECT 100MF	20% 16V
C265	1-164-505-11	CERAMIC CHIP 2.2MF	16V
C301	1-126-935-11	ELECT 470MF	20% 16V
C302	1-163-005-11	CERAMIC CHIP 470PF	10% 50V
C303	1-126-964-11	ELECT 10MF	20% 50V
C304	1-126-967-11	ELECT 47MF	20% 50V
C305	1-164-004-11	CERAMIC CHIP 0.1MF	10% 25V
C306	1-163-233-11	CERAMIC CHIP 18PF	5% 50V
C307	1-163-233-11	CERAMIC CHIP 18PF	5% 50V
C308	1-163-259-91	CERAMIC CHIP 220PF	5% 50V
C309	1-126-957-11	ELECT 0.22MF	20% 50V
C310	1-126-963-11	ELECT 4.7MF	20% 50V
C311	1-126-964-11	ELECT 10MF	20% 50V
C312	1-164-346-11	CERAMIC CHIP 1MF	16V
C313	1-164-346-11	CERAMIC CHIP 1MF	16V
C315	1-164-004-11	CERAMIC CHIP 0.1MF	10% 25V
C316	1-126-967-11	ELECT 47MF	20% 50V
C317	1-164-004-11	CERAMIC CHIP 0.1MF	10% 25V
C318	1-163-031-11	CERAMIC CHIP 0.01MF	50V
C319	1-163-031-11	CERAMIC CHIP 0.01MF	50V
C320	1-163-031-11	CERAMIC CHIP 0.01MF	50V
C322	1-163-005-11	CERAMIC CHIP 470PF	10% 50V
C324	1-163-017-00	CERAMIC CHIP 0.0047MF	10% 50V
C325	1-126-960-11	ELECT 1MF	20% 50V
C327	1-126-965-11	ELECT 22MF	20% 50V
C328	1-164-004-11	CERAMIC CHIP 0.1MF	10% 25V
C330	1-164-004-11	CERAMIC CHIP 0.1MF	10% 25V
C331	1-247-807-31	CARBON 100	5% 1/4W
C332	1-126-963-11	ELECT 4.7MF	20% 50V
C335	1-164-004-11	CERAMIC CHIP 0.1MF	10% 25V
C336	1-164-004-11	CERAMIC CHIP 0.1MF	10% 25V
C337	1-126-961-11	ELECT 2.2MF	20% 50V
C338	1-163-017-00	CERAMIC CHIP 0.0047MF	10% 50V
C341	1-115-340-11	CERAMIC CHIP 0.22MF	10% 25V
C342	1-163-259-91	CERAMIC CHIP 220PF	5% 50V
C402	1-164-346-11	CERAMIC CHIP 1MF	16V
C404	1-163-005-11	CERAMIC CHIP 470PF	10% 50V
C405	1-126-935-11	ELECT 470MF	20% 16V
C407	1-164-346-11	CERAMIC CHIP 1MF	16V
C408	1-163-133-00	CERAMIC CHIP 470PF	5% 50V
C409	1-126-963-11	ELECT 4.7MF	20% 50V
C502	1-163-145-00	CERAMIC CHIP 0.0015MF	5% 50V
C506	1-107-638-11	ELECT 33MF	20% 160V
C507	1-161-830-00	CERAMIC 0.0047MF	500V
C510	1-102-112-00	CERAMIC 330PF	10% 50V
C512	1-163-989-11	CERAMIC CHIP 0.033MF	10% 25V
C513	1-163-263-11	CERAMIC CHIP 330PF	5% 50V
C514	1-106-383-00	MYLAR 0.047MF	10% 200V
C517	1-164-182-11	CERAMIC CHIP 0.0033MF	10% 50V
C518	1-104-665-11	ELECT 100MF	20% 10V
C519	1-102-212-00	CERAMIC 820PF	10% 500V
C521	1-126-934-11	ELECT 220MF	20% 16V
C522	1-126-933-11	ELECT 100MF	20% 16V
C523	1-102-002-00	CERAMIC 680PF	10% 500V
C524	1-126-967-11	ELECT 47MF	20% 50V
C526	1-130-495-00	MYLAR 0.1MF	5% 50V
C527	1-102-820-00	CERAMIC 330PF	5% 50V

REF. NO.	PART NO.	DESCRIPTION	REMARK
C528	1-162-134-11	CERAMIC 470PF	10% 2KV
C530	1-137-372-11	FILM 0.022MF	5% 50V
C531	1-126-961-11	ELECT 2.2MF	20% 50V
C532	1-126-941-11	ELECT 470MF	20% 25V
C533	1-126-941-11	ELECT 470MF	20% 25V
C536	1-136-165-00	FILM 0.1MF	5% 50V
C537	1-126-969-11	ELECT 220MF	20% 50V
C538	1-136-076-00	FILM 0.0085MF	3% 2KV
C539	1-129-746-91	FILM 0.039MF	5% 400V
C540	1-136-171-00	FILM 0.33MF	5% 50V
C546	1-165-319-11	CERAMIC CHIP 0.1MF	50V
C549	1-163-017-00	CERAMIC CHIP 0.0047MF	10% 50V
C550	1-106-220-00	MYLAR 0.1MF	10% 100V
C551	1-126-960-11	ELECT 1MF	20% 50V
C552	1-162-116-00	CERAMIC 680PF	10% 2KV
C553	1-162-116-00	CERAMIC 680PF	10% 2KV
C554	1-137-417-11	MYLAR 0.0047MF	10% 200V
C556	1-126-941-11	ELECT 470MF	20% 25V
C557	1-126-941-11	ELECT 470MF	20% 25V
C558	1-123-024-21	ELECT 33MF	160V
C560	1-102-228-00	CERAMIC 470PF	10% 500V
C561	1-136-557-11	FILM 0.0033MF	5% 630V
C562	1-102-228-00	CERAMIC 470PF	10% 500V
C564	1-163-038-91	CERAMIC CHIP 0.1MF	25V
C565	1-107-655-11	ELECT 47MF	20% 250V
C566	1-102-244-00	CERAMIC 220PF	10% 500V
C567	1-115-521-11	FILM 0.82MF	5% 250V
C568	1-102-228-00	CERAMIC 470PF	10% 500V
C570	1-115-520-11	FILM 0.68MF	5% 250V
C573	1-106-379-12	MYLAR 0.033MF	10% 200V
C574	1-107-636-11	ELECT 10MF	20% 160V
C576	1-130-495-00	MYLAR 0.1MF	5% 50V
C577	1-106-395-00	MYLAR 0.15MF	10% 200V
C582	1-164-004-11	CERAMIC CHIP 0.1MF	10% 25V
C600 Δ	1-104-705-51	FILM 0.1MF	20% 250V
C604	1-163-009-11	CERAMIC CHIP 0.001MF	10% 50V
C605 Δ	1-127-942-51	CERAMIC 330PF	10% 250V
C606 Δ	1-127-942-51	CERAMIC 330PF	10% 250V
C607	1-161-830-00	CERAMIC 0.0047MF	99% 500V
C608	1-161-830-00	CERAMIC 0.0047MF	99% 500V
C609	1-126-968-11	ELECT 100MF	20% 50V
C610	1-126-964-11	ELECT 10MF	20% 50V
C611	1-161-830-00	CERAMIC 0.0047MF	99% 500V
C612	1-161-830-00	CERAMIC 0.0047MF	99% 500V
C613	1-117-752-11	ELECT(BLOCK) 330MF	20% 450V
C614	1-126-964-11	ELECT 10MF	20% 50V
C616	1-130-202-00	FILM 0.022MF	10% 400V
C617	1-107-792-11	CERAMIC 100PF	5% 1KV
C618	1-125-893-11	FILM 680PF	3% 1.5KV
C619 Δ	1-119-886-51	CERAMIC 470PF	10% 250V
C620	1-163-133-00	CERAMIC CHIP 470PF	5% 50V
C621	1-102-114-00	CERAMIC 470PF	10% 50V
C622	1-102-074-00	CERAMIC 0.001MF	10% 50V
C623	1-104-665-11	ELECT 100MF	20% 25V
C624	1-104-331-11	CERAMIC 0.0022MF	10% 1KV
C627	1-102-002-00	CERAMIC 680PF	10% 500V
C628	1-126-942-61	ELECT 1000MF	20% 25V
C629	1-126-964-11	ELECT 10MF	20% 50V

A (KV-PF21M70)

REF. NO.	PART NO.	DESCRIPTION	REMARK	REF. NO.	PART NO.	DESCRIPTION	REMARK	
C630	1-123-024-21	ELECT	33MF	160V	D311	8-719-988-61	DIODE 1SS355TE-17	
C633	1-104-999-11	MYLAR	0.1MF	10%	200V	D312	8-719-988-61	DIODE 1SS355TE-17
C634	1-126-933-11	ELECT	100MF	20%	16V	D313	8-719-988-61	DIODE 1SS355TE-17
C635	1-104-665-11	ELECT	100MF	20%	10V	D314	8-719-988-61	DIODE 1SS355TE-17
C636	1-104-760-11	CERAMIC CHIP	0.047MF	10%	50V	D315	8-719-988-61	DIODE 1SS355TE-17
C639	1-164-004-11	CERAMIC CHIP	0.1MF	10%	25V	D316	8-719-069-57	DIODE UDZS-TE17-6.8B
C640	1-164-004-11	CERAMIC CHIP	0.1MF	10%	25V	D402	8-719-069-60	DIODE UDZS-TE17-9.1B
C641	1-102-002-00	CERAMIC	680PF	10%	500V	D403	8-719-069-60	DIODE UDZS-TE17-9.1B
C642	1-126-943-11	ELECT	2200MF	20%	25V	D405	8-719-069-60	DIODE UDZS-TE17-9.1B
C643	1-104-665-11	ELECT	100MF	20%	10V	D406	8-719-069-60	DIODE UDZS-TE17-9.1B
C644	1-104-331-11	CERAMIC	0.0022MF	10%	1KV	D504	8-719-302-43	DIODE EL1Z
C645	1-137-605-11	FILM	0.01MF	10%	250V	D505	8-719-988-61	DIODE 1SS355TE-17
C646	1-107-679-91	ELECT	10MF	20%	450V	D506	8-719-911-19	DIODE 1SS119-25
C647	1-163-275-11	CERAMIC CHIP	0.001MF	5%	50V	D507	8-719-988-61	DIODE 1SS355TE-17
C649	1-126-940-11	ELECT	330MF	20%	25V	D508	8-719-988-61	DIODE 1SS355TE-17
C650	1-163-275-11	CERAMIC CHIP	0.001MF	5%	50V	D509	1-216-073-00	RES.CHIP 10K 5% 1/10W
C651	1-163-133-00	CERAMIC CHIP	470PF	5%	50V	D510	8-719-988-61	DIODE 1SS355TE-17
C652	1-126-965-11	ELECT	22MF	20%	50V	D511	8-719-988-61	DIODE 1SS355TE-17
C653	1-104-664-11	ELECT	47MF	20%	25V	D512	8-719-988-61	DIODE 1SS355TE-17
C657	1-101-821-00	CERAMIC	0.0022MF	500V		D513	8-719-908-03	DIODE GP08D
C658	1-164-004-11	CERAMIC CHIP	0.1MF	10%	25V	D517	8-719-945-80	DIODE ERC06-15S
C901	1-136-153-00	FILM	0.01MF	5%	50V	D518	8-719-900-26	DIODE ERD29-08J
C905	1-126-963-11	ELECT	4.7MF	20%	50V	D521	8-719-302-43	DIODE EL1Z
C906	1-164-346-11	CERAMIC CHIP	1MF	16V		D522	8-719-302-43	DIODE EL1Z
C907	1-163-133-00	CERAMIC CHIP	470PF	5%	50V	D523	8-719-302-43	DIODE EL1Z
C910	1-126-967-11	ELECT	47MF	20%	50V	D527	8-719-908-03	DIODE GP08D
C911	1-126-967-11	ELECT	47MF	20%	50V	D528	8-719-908-03	DIODE GP08D
C912	1-164-004-11	CERAMIC CHIP	0.1MF	10%	25V	D531	8-719-988-61	DIODE 1SS355TE-17
C913	1-126-933-11	ELECT	100MF	20%	16V	D532	8-719-988-61	DIODE 1SS355TE-17
C914	1-163-133-00	CERAMIC CHIP	470PF	5%	50V	D602	8-719-911-19	DIODE 1SS119-25
<CONNECTOR>								
CN104	1-695-915-11	TAB (CONTACT)				D603	8-719-150-92	DIODE RD33EB3T
CN202	* 1-785-608-11	PIN, CONNECTOR 4P				D604	8-719-028-72	DIODE RGP02-17EL-6433
CN203	* 1-564-506-11	PLUG, CONNECTOR 3P				D605	8-719-510-53	DIODE D4SB60L
CN204	* 1-564-506-11	PLUG, CONNECTOR 3P				D606	8-719-108-18	THYRISTOR 5P6M
CN305	* 1-564-509-11	PLUG, CONNECTOR 6P				D607	8-719-404-50	DIODE MA111-TX
CN505	1-508-765-00	PIN, CONNECTOR (5MM PITCH) 3P				D608	8-719-110-53	DIODE RD20ESB2
CN506	4-352-844-01	PIN, LEAD, COATING				D609	8-719-311-31	DIODE RU-1P
CN601	* 1-580-843-11	PIN, CONNECTOR (POWER)				D610	8-719-043-76	DIODE AK04V0
CN602	* 1-508-786-00	PIN, CONNECTOR (5MM PITCH) 2P				D611	8-719-046-74	DIODE AU-01Z-V1
CN604	* 1-573-963-11	PIN, CONNECTOR (PC BOARD) 3P				D613	8-719-046-74	DIODE AU-01Z-V1
CN609	* 1-508-784-21	PIN, CONNECTOR (5MM PITCH) 1P				D614	8-719-046-74	DIODE AU-01Z-V1
CN901	* 1-564-506-11	PLUG, CONNECTOR 3P				D618	8-719-067-18	DIODE RN4Z
<DIODE>								
D001	8-719-988-61	DIODE 1SS355TE-17				D620	8-719-110-72	DIODE RD30ESB2
D005	8-719-988-61	DIODE 1SS355TE-17				D622	8-719-071-39	DIODE FMU-G26S
D006	8-719-988-61	DIODE 1SS355TE-17				D623	8-719-978-65	DIODE DTZ-TT11-15B
D203	8-719-914-42	DIODE DA204K				D624	8-719-404-50	DIODE MA111-TX
D300	1-216-295-91	SHORT	0			D625	8-719-977-28	DIODE DTZ10B
D301	8-719-988-61	DIODE 1SS355TE-17				D627	8-719-073-84	DIODE 31DQ06-FC5
D306	8-719-988-61	DIODE 1SS355TE-17				D628	8-719-911-19	DIODE 1SS119-25
D307	8-719-988-61	DIODE 1SS355TE-17				D631	8-719-068-00	DIODE ERC04-06SE
D308	8-719-988-61	DIODE 1SS355TE-17				D632	8-719-068-00	DIODE ERC04-06SE
D309	8-719-069-54	DIODE UDZS-TE17-5.1B				D633	8-719-948-45	DIODE ERA22-08
						D634	8-719-404-50	DIODE MA111-TX
						D635	8-719-404-50	DIODE MA111-TX
						D636	8-719-510-02	DIODE D1NS4
						D637	8-719-109-96	DIODE RD6.8ESB1
						D638	8-719-510-48	DIODE D1N20R

The components identified by shading and mark \triangle are critical for safety. Replace only with part number specified.

A (KV-PF21M70)

REF. NO.	PART NO.	DESCRIPTION	REMARK	REF. NO.	PART NO.	DESCRIPTION	REMARK
D901	8-719-069-60	DIODE UDZS-TE17-9.1B		JR009	1-216-295-91	SHORT	0
D902	8-719-069-60	DIODE UDZS-TE17-9.1B		JR010	1-216-295-91	SHORT	0
D904	8-719-069-60	DIODE UDZS-TE17-9.1B		JR011	1-216-295-91	SHORT	0
D905	8-719-069-60	DIODE UDZS-TE17-9.1B		JR012	1-216-295-91	SHORT	0
D906	8-719-045-19	DIODE SPB-26MVWF		JR013	1-216-295-91	SHORT	0
		<CONNECTOR>		JR014	1-216-295-91	SHORT	0
DY1	* 1-580-798-11	CONNECTOR PIN (DY) 6P		JR015	1-216-295-91	SHORT	0
		<FERRITE BEAD>		JR016	1-216-295-91	SHORT	0
FB103	1-410-397-21	FERRITE	1.1UH	JR018	1-216-295-91	SHORT	0
FB501	1-410-397-21	FERRITE	1.1UH	JR019	1-216-295-91	SHORT	0
FB502	1-410-397-21	FERRITE	1.1UH	JR102	1-216-295-91	SHORT	0
FB600	1-410-397-21	FERRITE	1.1UH	JR109	1-216-295-91	SHORT	0
FB601	1-410-397-21	FERRITE	1.1UH	JR202	1-216-295-91	SHORT	0
FB602	1-410-397-21	FERRITE	1.1UH	JR301	1-216-295-91	SHORT	0
FB603	1-410-397-21	FERRITE	1.1UH	JR303	1-216-295-91	SHORT	0
FB604	1-410-397-21	FERRITE	1.1UH	JR404	1-216-295-91	SHORT	0
FB607	1-410-397-21	FERRITE	1.1UH	JR405	1-216-295-91	SHORT	0
FB608	1-412-911-31	FERRITE	0UH	JR500	1-216-295-91	SHORT	0
FB611	1-410-397-21	FERRITE	1.1UH	JR501	1-216-295-91	SHORT	0
FB613	1-410-397-21	FERRITE	1.1UH	JR600	1-216-295-91	SHORT	0
FB615	1-410-397-21	FERRITE	1.1UH			<COIL>	
		<IC>		L002	1-414-856-11	INDUCTOR	10UH
IC001	8-752-906-21	IC CXP86449-623S		L003	1-414-180-11	INDUCTOR	3.3UH
IC002	8-759-371-21	IC MM1319AFBE		L005	1-414-233-22	INDUCTOR CHIP	0UH
IC003	8-759-370-34	IC ST24C08FB6		L101	1-414-856-11	INDUCTOR	10UH
IC201	8-759-339-60	IC TA8248K		L102	1-414-856-11	INDUCTOR	10UH
IC203	8-759-553-40	IC TDA7429S		L103	1-414-856-11	INDUCTOR	10UH
IC301	8-752-088-39	IC CXA2130S		L104	1-414-856-11	INDUCTOR	10UH
IC502	8-759-700-07	IC NJM2903M		L105	1-414-856-11	INDUCTOR	10UH
IC503	8-759-980-58	IC TDA8172		L204	1-414-856-11	INDUCTOR	10UH
IC601	8-749-013-75	IC STR-F6654		L301	1-414-189-31	INDUCTOR	100UH
IC602	8-749-920-61	IC SE-135N		L302	1-414-185-41	INDUCTOR	22UH
IC603	8-759-701-59	IC NJM78M09FA		L501	1-412-525-31	INDUCTOR	10UH
IC604	8-759-231-53	IC TA7805S		L502	1-422-613-11	COIL, AIR CORE	
IC901	8-742-014-11	HYB IC SBX1981-51		L503	1-412-525-31	INDUCTOR	10UH
		<JACK>		L504	1-412-525-31	INDUCTOR	10UH
J401	1-779-849-11	JACK BLOCK, PIN 4P		L505	1-412-525-31	INDUCTOR	10UH
J901	1-770-785-11	JACK		L506	1-412-525-31	INDUCTOR	10UH
J902	1-779-205-11	JACK, PIN 2P		L507	1-459-111-00	INDUCTOR	10MMH
		<CHIP CONDUCTOR>		L508	1-412-525-31	INDUCTOR	10UH
JR002	1-216-295-91	SHORT	0	L509	1-459-390-00	INDUCTOR	390UH
JR003	1-216-295-91	SHORT	0	L510	1-416-972-11	COIL, HORIZONTAL LINEARITY	
JR004	1-216-295-91	SHORT	0	L512	1-412-549-31	INDUCTOR	1MMH
JR005	1-216-295-91	SHORT	0	L513	1-412-549-31	INDUCTOR	1MMH
JR006	1-216-295-91	SHORT	0	L515	1-459-104-00	COIL, WITH CORE	
JR007	1-216-295-91	SHORT	0	L518	1-408-611-31	INDUCTOR	47UH
JR008	1-216-295-91	SHORT	0	L601	1-412-527-11	INDUCTOR	15UH
		<PHOTO COUPLER>		L901	1-408-603-31	INDUCTOR	10UH
				L905	1-414-856-11	INDUCTOR	10UH
				PH600 \triangle 8-749-924-35	PHOTO COUPLER ON3171-R		

A (KV-PF21M70)

REF. NO.	PART NO.	DESCRIPTION	REMARK	REF. NO.	PART NO.	DESCRIPTION	REMARK
		<IC LINK>					
PS200	1-532-675-21	LINK, IC 1.5A/150V		R013	1-216-065-91	RES,CHIP 4.7K	5% 1/10W
		<TRANSISTOR>		R014	1-216-025-91	RES,CHIP 100	5% 1/10W
Q002	8-729-230-49	TRANSISTOR 2SC2712-YG		R015	1-216-025-91	RES,CHIP 100	5% 1/10W
Q003	8-729-424-08	TRANSISTOR UN2111		R016	1-216-025-91	RES,CHIP 100	5% 1/10W
Q004	8-729-421-22	TRANSISTOR UN2211		R017	1-216-049-91	RES,CHIP 1K	5% 1/10W
Q101	8-729-230-49	TRANSISTOR 2SC2712-YG		R018	1-216-033-00	RES,CHIP 220	5% 1/10W
Q201	8-729-424-67	TRANSISTOR UN2216		R019	1-216-073-00	RES,CHIP 10K	5% 1/10W
Q203	8-729-421-19	TRANSISTOR UN2213		R021	1-216-073-00	RES,CHIP 10K	5% 1/10W
Q204	8-729-216-22	TRANSISTOR 2SA1162-G		R022	1-216-033-00	RES,CHIP 220	5% 1/10W
Q205	8-729-421-19	TRANSISTOR UN2213		R024	1-216-057-00	RES,CHIP 2.2K	5% 1/10W
Q206	8-729-421-19	TRANSISTOR UN2213		R025	1-216-057-00	RES,CHIP 2.2K	5% 1/10W
Q207	8-729-421-19	TRANSISTOR UN2213		R026	1-216-057-00	RES,CHIP 2.2K	5% 1/10W
Q301	8-729-216-22	TRANSISTOR 2SA1162-G		R027	1-216-073-00	RES,CHIP 10K	5% 1/10W
Q302	8-729-230-49	TRANSISTOR 2SC2712-YG		R029	1-216-049-91	RES,CHIP 1K	5% 1/10W
Q303	8-729-216-22	TRANSISTOR 2SA1162-G		R031	1-216-049-91	RES,CHIP 1K	5% 1/10W
Q305	8-729-216-22	TRANSISTOR 2SA1162-G		R035	1-216-025-91	RES,CHIP 100	5% 1/10W
Q306	8-729-216-22	TRANSISTOR 2SA1162-G		R036	1-216-025-91	RES,CHIP 100	5% 1/10W
Q307	8-729-230-49	TRANSISTOR 2SC2712-YG		R037	1-216-025-91	RES,CHIP 100	5% 1/10W
Q308	8-729-216-22	TRANSISTOR 2SA1162-G		R040	1-216-025-91	RES,CHIP 100	5% 1/10W
Q312	8-729-216-22	TRANSISTOR 2SA1162-G		R041	1-216-025-91	RES,CHIP 100	5% 1/10W
Q313	8-729-230-49	TRANSISTOR 2SC2712-YG		R042	1-216-295-91	SHORT 0	
Q315	8-729-421-19	TRANSISTOR UN2213		R043	1-216-049-91	RES,CHIP 1K	5% 1/10W
Q401	8-729-424-67	TRANSISTOR UN2216		R044	1-216-025-91	RES,CHIP 100	5% 1/10W
Q404	8-729-216-22	TRANSISTOR 2SA1162-G		R045	1-414-233-22	INDUCTOR CHIP 0UH	
Q503	8-729-230-49	TRANSISTOR 2SC2712-YG		R046	1-216-049-91	RES,CHIP 1K	5% 1/10W
Q505	8-729-931-45	TRANSISTOR IRF614		R047	1-414-233-22	INDUCTOR CHIP 0UH	
Q506	8-729-140-96	TRANSISTOR 2SD774-34		R048	1-216-073-00	RES,CHIP 10K	5% 1/10W
Q507	8-729-216-22	TRANSISTOR 2SA1162-G		R050	1-216-073-00	RES,CHIP 10K	5% 1/10W
Q509	8-729-230-49	TRANSISTOR 2SC2712-YG		R053	1-216-049-91	RES,CHIP 1K	5% 1/10W
Q511	8-729-048-07	TRANSISTOR 2SD2578-CA		R055	1-216-073-00	RES,CHIP 10K	5% 1/10W
Q601	8-729-023-22	TRANSISTOR 2SD2114K		R056	1-216-073-00	RES,CHIP 10K	5% 1/10W
Q602	8-729-230-49	TRANSISTOR 2SC2712-YG		R061	1-216-033-00	RES,CHIP 220	5% 1/10W
Q603	8-729-424-08	TRANSISTOR UN2111		R062	1-216-041-00	RES,CHIP 470	5% 1/10W
Q604	8-729-200-17	TRANSISTOR 2SA1091-O		R063	1-216-037-00	RES,CHIP 330	5% 1/10W
Q605	8-729-044-30	TRANSISTOR 2SK2845-LB102		R064	1-216-037-00	RES,CHIP 330	5% 1/10W
Q606	8-729-230-49	TRANSISTOR 2SC2712-YG		R065	1-216-037-00	RES,CHIP 330	5% 1/10W
Q607	8-729-922-37	TRANSISTOR 2SD2144S-UVW		R066	1-216-049-91	RES,CHIP 1K	5% 1/10W
Q608	8-729-230-49	TRANSISTOR 2SC2712-YG		R105	1-216-295-91	SHORT 0	
Q901	8-729-421-19	TRANSISTOR UN2213		R109	1-216-041-00	RES,CHIP 470	5% 1/10W
Q902	8-729-421-19	TRANSISTOR UN2213		R111	1-216-025-91	RES,CHIP 100	5% 1/10W
		<RESISTOR>		R112	1-216-025-91	RES,CHIP 100	5% 1/10W
R001	1-414-233-22	INDUCTOR CHIP 0UH		R113	1-216-047-91	RES,CHIP 820	5% 1/10W
R002	1-216-025-91	RES,CHIP 100	5% 1/10W	R202	1-216-071-00	RES,CHIP 8.2K	5% 1/10W
R003	1-216-295-91	SHORT 0		R203	1-216-077-00	RES,CHIP 15K	5% 1/10W
R004	1-216-025-91	RES,CHIP 100	5% 1/10W	R204	1-216-071-00	RES,CHIP 8.2K	5% 1/10W
R005	1-216-025-91	RES,CHIP 100	5% 1/10W	R208	1-216-061-00	RES,CHIP 3.3K	5% 1/10W
R007	1-216-295-91	SHORT 0		R210	1-164-004-11	CERAMIC CHIP 0.1MF	10% 25V
R008	1-216-065-91	RES,CHIP 4.7K	5% 1/10W	R211	1-216-043-91	RES,CHIP 560	5% 1/10W
R010	1-216-065-91	RES,CHIP 4.7K	5% 1/10W	R212	1-216-033-00	RES,CHIP 220	5% 1/10W
R011	1-216-065-91	RES,CHIP 4.7K	5% 1/10W	R213	1-216-073-00	RES,CHIP 10K	5% 1/10W
R012	1-216-065-91	RES,CHIP 4.7K	5% 1/10W	R214	1-216-073-00	RES,CHIP 10K	5% 1/10W
				R215	1-216-059-00	RES,CHIP 2.7K	5% 1/10W
				R216	1-216-059-00	RES,CHIP 2.7K	5% 1/10W
				R217	1-216-067-00	RES,CHIP 5.6K	5% 1/10W
				R218	1-216-067-00	RES,CHIP 5.6K	5% 1/10W
				R219	1-216-025-91	RES,CHIP 100	5% 1/10W
				R220	1-216-025-91	RES,CHIP 100	5% 1/10W

A (KV-PF21M70)

REF. NO.	PART NO.	DESCRIPTION	REMARK	REF. NO.	PART NO.	DESCRIPTION	REMARK
R221	1-216-295-91	SHORT	0	R367	1-216-073-00	RES,CHIP	10K 5% 1/10W
R225	1-216-033-00	RES,CHIP	220 5% 1/10W	R370	1-216-033-00	RES,CHIP	220 5% 1/10W
R226	1-216-033-00	RES,CHIP	220 5% 1/10W	R376	1-216-081-00	RES,CHIP	22K 5% 1/10W
R227	1-216-033-00	RES,CHIP	220 5% 1/10W	R377	1-216-121-91	RES,CHIP	1M 5% 1/10W
R229	1-216-073-00	RES,CHIP	10K 5% 1/10W	R378	1-216-031-00	RES,CHIP	180 5% 1/10W
R230	1-216-069-00	RES,CHIP	6.8K 5% 1/10W	R404	1-216-073-00	RES,CHIP	10K 5% 1/10W
R231	1-216-295-91	SHORT	0	R405	1-216-049-91	RES,CHIP	1K 5% 1/10W
R234	1-249-389-11	CARBON	4.7 5% 1/4W	R406	1-216-073-00	RES,CHIP	10K 5% 1/10W
R235	1-216-069-00	RES,CHIP	6.8K 5% 1/10W	R408	1-216-049-91	RES,CHIP	1K 5% 1/10W
R236	1-216-069-00	RES,CHIP	6.8K 5% 1/10W	R411	1-216-113-00	RES,CHIP	470K 5% 1/10W
R237	1-216-308-00	RES,CHIP	4.7 5% 1/10W	R412	1-216-041-00	RES,CHIP	470 5% 1/10W
R301	1-216-073-00	RES,CHIP	10K 5% 1/10W	R413	1-216-021-00	RES,CHIP	68 5% 1/10W
R302	1-216-295-91	SHORT	0	R414	1-216-113-00	RES,CHIP	470K 5% 1/10W
R303	1-216-049-91	RES,CHIP	1K 5% 1/10W	R417	1-216-077-00	RES,CHIP	15K 5% 1/10W
R304	1-216-073-00	RES,CHIP	10K 5% 1/10W	R418	1-216-113-00	RES,CHIP	470K 5% 1/10W
R305	1-216-051-00	RES,CHIP	1.2K 5% 1/10W	R419	1-216-022-00	RES,CHIP	75 5% 1/10W
R306	1-216-073-00	RES,CHIP	10K 5% 1/10W	R426	1-216-033-00	RES,CHIP	220 5% 1/10W
R307	1-216-295-91	SHORT	0	R505	1-216-099-00	RES,CHIP	120K 5% 1/10W
R308	1-216-025-91	RES,CHIP	100 5% 1/10W	R506	1-216-085-00	RES,CHIP	33K 5% 1/10W
R309	1-216-025-91	RES,CHIP	100 5% 1/10W	R507	1-249-389-11	CARBON	4.7 5% 1/4W F
R310	1-216-025-91	RES,CHIP	100 5% 1/10W	R508	1-215-910-00	METAL OXIDE	68 5% 3W F
R311	1-216-017-91	RES,CHIP	47 5% 1/10W	R509	1-215-911-11	METAL OXIDE	100 5% 3W F
R312	1-216-041-00	RES,CHIP	470 5% 1/10W	R510	1-215-885-00	METAL OXIDE	68 5% 2W F
R313	1-216-053-00	RES,CHIP	1.5K 5% 1/10W	R511	1-215-911-11	METAL OXIDE	100 5% 3W F
R314	1-216-045-00	RES,CHIP	680 5% 1/10W	R516	1-216-081-00	RES,CHIP	22K 5% 1/10W
R316	1-216-053-00	RES,CHIP	1.5K 5% 1/10W	R518	1-247-807-31	CARBON	100 5% 1/4W
R317	1-216-077-00	RES,CHIP	15K 5% 1/10W	R520	1-215-445-00	METAL	10K 1% 1/4W
R318	1-216-051-00	RES,CHIP	1.2K 5% 1/10W	R522	1-216-675-11	METAL CHIP	10K 0.50% 1/10W
R319	1-216-025-91	RES,CHIP	100 5% 1/10W	R523	1-249-411-11	CARBON	330 5% 1/4W
R320	1-216-065-91	RES,CHIP	4.7K 5% 1/10W	R525	1-216-699-11	METAL CHIP	100K 0.50% 1/10W
R321	1-216-073-00	RES,CHIP	10K 5% 1/10W	R526	1-208-798-11	RES,CHIP	4.7K 0.50% 1/10W
R322	1-216-033-00	RES,CHIP	220 5% 1/10W	R527	1-216-001-00	RES,CHIP	10 5% 1/10W
R326	1-216-295-91	SHORT	0	R528	1-216-683-11	METAL CHIP	22K 0.50% 1/10W
R331	1-216-295-91	SHORT	0	R529	1-216-635-11	METAL CHIP	220 0.50% 1/10W
R332	1-216-033-00	RES,CHIP	220 5% 1/10W	R531	1-247-843-11	CARBON	3.3K 5% 1/4W
R333	1-216-073-00	RES,CHIP	10K 5% 1/10W	R533	1-249-417-11	CARBON	1K 5% 1/4W
R334	1-216-129-00	RES,CHIP	2.2M 5% 1/10W	R534	1-216-361-00	METAL OXIDE	0.22 5% 2W F
R335	1-216-045-00	RES,CHIP	680 5% 1/10W	R535	1-216-067-00	RES,CHIP	5.6K 5% 1/10W
R338	1-216-033-00	RES,CHIP	220 5% 1/10W	R536	1-216-067-00	RES,CHIP	5.6K 5% 1/10W
R340	1-216-025-91	RES,CHIP	100 5% 1/10W	R537	1-216-683-11	METAL CHIP	22K 0.50% 1/10W
R345	1-216-081-00	RES,CHIP	22K 5% 1/10W	R540	1-216-065-91	RES,CHIP	4.7K 5% 1/10W
R348	1-216-675-11	METAL CHIP	10K 0.50% 1/10W	R541	1-216-065-91	RES,CHIP	4.7K 5% 1/10W
R349	1-216-073-00	RES,CHIP	10K 5% 1/10W	R542	1-216-295-91	SHORT	0
R350	1-216-061-00	RES,CHIP	3.3K 5% 1/10W	R543	1-249-426-11	CARBON	5.6K 5% 1/4W F
R351	1-216-053-00	RES,CHIP	1.5K 5% 1/10W	R545	1-216-077-00	RES,CHIP	15K 5% 1/10W
R354	1-216-057-00	RES,CHIP	2.2K 5% 1/10W	R546	1-216-077-00	RES,CHIP	15K 5% 1/10W
R355	1-216-057-00	RES,CHIP	2.2K 5% 1/10W	R547	1-216-085-00	RES,CHIP	33K 5% 1/10W
R356	1-216-057-00	RES,CHIP	2.2K 5% 1/10W	R549	1-215-451-00	METAL	18K 1% 1/4W
R357	1-216-079-00	RES,CHIP	18K 5% 1/10W	R550	1-216-097-91	RES,CHIP	100K 5% 1/10W
R358	1-216-049-91	RES,CHIP	1K 5% 1/10W	R551	1-249-421-11	CARBON	2.2K 5% 1/4W
R359	1-216-033-00	RES,CHIP	220 5% 1/10W	R552	1-216-057-00	RES,CHIP	2.2K 5% 1/10W
R360	1-216-033-00	RES,CHIP	220 5% 1/10W	R553	1-215-457-00	METAL	33K 1% 1/4W
R361	1-216-073-00	RES,CHIP	10K 5% 1/10W	R554	1-215-457-00	METAL	33K 1% 1/4W
R362	1-216-075-00	RES,CHIP	12K 5% 1/10W	R556	1-215-437-00	METAL	4.7K 1% 1/4W
R363	1-216-079-00	RES,CHIP	18K 5% 1/10W	R558	1-249-421-11	CARBON	2.2K 5% 1/4W
R364	1-216-295-91	SHORT	0	R559	1-249-429-11	CARBON	10K 5% 1/4W
R365	1-216-033-00	RES,CHIP	220 5% 1/10W	R560	1-216-073-00	RES,CHIP	10K 5% 1/10W
R366	1-216-073-00	RES,CHIP	10K 5% 1/10W				

The components identified by shading and mark Δ are critical for safety.
Replace only with part number specified.

A (KV-PF21M70)

REF. NO.	PART NO.	DESCRIPTION	REMARK	REF. NO.	PART NO.	DESCRIPTION	REMARK
R562	1-249-401-11	CARBON	47 5% 1/4W	R644	1-249-419-11	CARBON	1.5K 5% 1/4W
R565	1-216-073-00	RES,CHIP	10K 5% 1/10W	R646	1-215-924-00	METAL OXIDE	15K 5% 3W F
R567	1-216-105-91	RES,CHIP	220K 5% 1/10W	R647	1-249-401-11	CARBON	47 5% 1/4W
R568	1-249-383-11	CARBON	1.5 5% 1/4W F	R648	1-216-057-00	RES,CHIP	2.2K 5% 1/10W
R570	1-216-069-00	RES,CHIP	6.8K 5% 1/10W	R649	1-249-417-11	CARBON	1K 5% 1/4W
R571	1-215-437-00	METAL	4.7K 1% 1/4W	R650	1-215-882-00	METAL OXIDE	22 5% 2W F
R573	1-216-089-91	RES,CHIP	47K 5% 1/10W	R652	1-215-900-11	METAL OXIDE	22K 5% 2W F
R577	1-215-913-11	METAL OXIDE	220 5% 3W F	R653	1-215-873-00	METAL OXIDE	4.7K 5% 1W F
R578	1-216-369-00	METAL OXIDE	1 5% 2W F	R657	1-260-127-11	CARBON	220K 5% 1/2W
R579	1-216-097-91	RES,CHIP	100K 5% 1/10W	R659	1-216-049-91	RES,CHIP	1K 5% 1/10W
R580	1-216-699-11	METAL CHIP	100K 0.50% 1/10W	R660	1-216-073-00	RES,CHIP	10K 5% 1/10W
R581	1-208-798-11	RES,CHIP	4.7K 0.50% 1/10W	R661	1-215-873-00	METAL OXIDE	4.7K 5% 1W F
R585	1-249-391-11	CARBON	6.8 5% 1/4W F	R680	1-216-308-00	RES,CHIP	4.7 5% 1/10W
R588	1-215-888-00	METAL OXIDE	220 5% 2W F	R901	1-249-411-11	CARBON	330 5% 1/4W
R589	1-215-888-00	METAL OXIDE	220 5% 2W F	R903	1-216-022-00	RES,CHIP	75 5% 1/10W
R590	1-215-465-00	METAL	68K 1% 1/4W	R904	1-216-033-00	RES,CHIP	220 5% 1/10W
R591	1-260-288-11	CARBON	0.47 5% 1/2W F	R905	1-216-113-00	RES,CHIP	470K 5% 1/10W
R593	1-260-288-11	CARBON	0.47 5% 1/2W F	R906	1-216-077-00	RES,CHIP	15K 5% 1/10W
R594	1-260-288-11	CARBON	0.47 5% 1/2W F	R909	1-216-065-91	RES,CHIP	4.7K 5% 1/10W
R596	1-215-922-11	METAL OXIDE	6.8K 5% 3W F	R910	1-216-065-91	RES,CHIP	4.7K 5% 1/10W
R597	1-247-750-11	CARBON	680 5% 1/2W F	R911	1-216-067-00	RES,CHIP	5.6K 5% 1/10W
R598	1-249-438-11	CARBON	56K 5% 1/4W	R912	1-216-041-00	RES,CHIP	470 5% 1/10W
R599	1-249-389-11	CARBON	4.7 5% 1/4W	R913	1-216-049-91	RES,CHIP	1K 5% 1/10W
R600	1-249-438-11	CARBON	56K 5% 1/4W	R914	1-216-055-00	RES,CHIP	1.8K 5% 1/10W
R601	1-249-418-11	CARBON	1.2K 5% 1/4W F	R915	1-216-061-00	RES,CHIP	3.3K 5% 1/10W
R602	1-249-389-11	CARBON	4.7 5% 1/4W F	R916	1-216-017-91	RES,CHIP	47 5% 1/10W
R603	1-215-485-00	METAL	470K 1% 1/4W	R917	1-216-041-00	RES,CHIP	470 5% 1/10W
R604	1-216-097-91	RES,CHIP	100K 5% 1/10W	R918	1-216-041-00	RES,CHIP	470 5% 1/10W
R607	1-249-425-11	CARBON	4.7K 5% 1/4W			<RELAY>	
R608	1-240-205-91	CARBON	22M 5% 1/2W				
R609	1-216-057-00	RES,CHIP	2.2K 5% 1/10W	RY601 Δ	1-755-266-11	RELAY, AC POWER	
R610	1-216-073-00	RES,CHIP	10K 5% 1/10W			<SWITCH>	
R611	1-216-089-91	RES,CHIP	47K 5% 1/10W				
R612	1-216-045-00	RES,CHIP	680 5% 1/10W	S502	1-572-707-11	SWITCH, LEVER	
R614	1-216-041-00	RES,CHIP	470 5% 1/10W	S600 Δ	1-571-433-21	SWITCH, PUSH (AC POWER)	
R615	1-216-350-11	METAL OXIDE	1.2 5% 1W F	S901	1-692-431-21	SWITCH, TACTILE	
R616	1-260-302-51	CARBON	6.8 5% 1/2W F	S902	1-692-431-21	SWITCH, TACTILE	
R617	1-247-791-91	CARBON	22 5% 1/4W	S903	1-692-431-21	SWITCH, TACTILE	
R619	1-260-128-11	CARBON	270K 5% 1/2W	S904	1-692-431-21	SWITCH, TACTILE	
R620	1-215-915-11	METAL OXIDE	470 5% 3W F	S905	1-692-431-21	SWITCH, TACTILE	
R622	1-215-908-00	METAL OXIDE	33 5% 3W F	S906	1-692-431-21	SWITCH, TACTILE	
R623	1-216-095-00	RES,CHIP	82K 5% 1/10W	S907	1-692-431-21	SWITCH, TACTILE	
R624	1-216-089-91	RES,CHIP	47K 5% 1/10W			<TRANSFORMER>	
R626	1-216-049-91	RES,CHIP	1K 5% 1/10W	T501	1-437-195-11	TRANSFORMER, HORIZONTAL DRIVE	
R627	1-240-251-11	CMT,MELF	6.8 5% 10W	T503 Δ	1-453-293-11	TRANSFORMER ASSY, FLYBACK (NX-1748//M3A4)	
R629	1-247-747-11	CARBON	470 5% 1/2W F	T601	1-424-682-11	TRANSFORMER, LINE FILTER	
R630	1-249-429-11	CARBON	10K 5% 1/4W F	T603 Δ	1-433-512-31	TRANSFORMER, CONVERTER (SRT)	
R631	1-216-089-91	RES,CHIP	47K 5% 1/10W	T604 Δ	1-431-852-11	TRANSFORMER, CONVERTER (SRT)	
R632	1-202-933-61	FUSIBLE	0.1 10% 1/2W F			<THERMISTOR>	
R634 Δ	1-218-265-91	METAL	8.2M 5% 1W	THP600	1-810-961-11	THERMISTOR, POSITIVE	
R635	1-216-492-11	METAL OXIDE	82K 5% 3W F				
R636	1-215-924-00	METAL OXIDE	15K 5% 3W F				
R637	1-216-492-11	METAL OXIDE	82K 5% 3W F				
R639	1-216-363-00	METAL OXIDE	0.33 5% 2W F				
R640	1-249-415-11	CARBON	680 5% 1/4W				
R641	1-216-362-11	METAL OXIDE	0.27 5% 2W F				
R642	1-249-419-11	CARBON	1.5K 5% 1/4W				
R643	1-247-843-11	CARBON	3.3K 5% 1/4W				

A (KV-PF21M70)

A (Except KV-PF21M70)

REF. NO.	PART NO.	DESCRIPTION	REMARK
		<TUNER>	
TU101	8-598-449-01	TUNER, FSS BTF-LG433	
		<CRYSTAL>	
X001	1-579-125-11	VIBRATOR, CERAMIC	
X301	1-781-134-21	VIBRATOR, CRYSTAL	
X302	1-781-132-21	VIBRATOR, CRYSTAL	

* A-1298-968-A	A BOARD, COMPLETE (KV-TF21P11) *****		
* A-1298-942-A	A BOARD, COMPLETE (KV-TF21M61) *****		
* A-1298-951-A	A BOARD, COMPLETE (KV-TF21M90) *****		
* 4-055-304-01	HOLDER, LED		
* 4-067-182-02	HOLDER, FBT		
4-382-854-11	SCREW (M3X10), P, SW (+)		
4-382-854-21	SCREW (M3X14), P, SW (+)		
7-685-648-79	SCREW +BVTP 3X12 TYPE2 IT-3		
		<CAPACITOR>	
C004	1-163-001-11	CERAMIC CHIP 220PF	10% 50V
C005	1-163-001-11	CERAMIC CHIP 220PF	10% 50V
C006	1-164-004-11	CERAMIC CHIP 0.1MF	10% 25V
C007	1-126-933-11	ELECT 100MF	20% 16V
C008	1-163-251-11	CERAMIC CHIP 100PF	5% 50V
C010	1-163-251-11	CERAMIC CHIP 100PF	5% 50V
C012	1-163-251-11	CERAMIC CHIP 100PF	5% 50V
C013	1-163-021-91	CERAMIC CHIP 0.01MF	10% 50V
C014	1-126-967-11	ELECT 47MF	20% 50V
C015	1-163-009-11	CERAMIC CHIP 0.001MF	10% 50V
C016	1-163-113-00	CERAMIC CHIP 68PF	5% 50V
C017	1-163-113-00	CERAMIC CHIP 68PF	5% 50V
C019	1-104-665-11	ELECT 100MF	20% 25V
C022	1-163-227-11	CERAMIC CHIP 10PF	0.5PF 50V
C023	1-163-227-11	CERAMIC CHIP 10PF	0.5PF 50V
C024	1-163-227-11	CERAMIC CHIP 10PF	0.5PF 50V
C026	1-164-004-11	CERAMIC CHIP 0.1MF	10% 25V
C027	1-164-004-11	CERAMIC CHIP 0.1MF	10% 25V
C028	1-163-037-11	CERAMIC CHIP 0.022MF	10% 50V
C030	1-126-965-11	ELECT 22MF	20% 50V
C031	1-164-004-11	CERAMIC CHIP 0.1MF	10% 25V
C032	1-107-823-11	CERAMIC CHIP 0.47MF	10% 16V
C034	1-163-031-11	CERAMIC CHIP 0.01MF	50V
C041	1-163-251-11	CERAMIC CHIP 100PF	5% 50V
C042	1-163-251-11	CERAMIC CHIP 100PF	5% 50V
C043	1-163-251-11	CERAMIC CHIP 100PF	5% 50V
C044	1-163-251-11	CERAMIC CHIP 100PF	5% 50V
C047	1-163-251-11	CERAMIC CHIP 100PF	5% 50V
C048	1-163-251-11	CERAMIC CHIP 100PF	5% 50V
C050	1-163-251-11	CERAMIC CHIP 100PF	5% 50V

REF. NO.	PART NO.	DESCRIPTION	REMARK
C051	1-163-251-11	CERAMIC CHIP 100PF	5% 50V
C053	1-163-251-11	CERAMIC CHIP 100PF	5% 50V
C054	1-163-251-11	CERAMIC CHIP 100PF	5% 50V
C055	1-163-251-11	CERAMIC CHIP 100PF	5% 50V
C103	1-164-004-11	CERAMIC CHIP 0.1MF	10% 25V
C104	1-126-933-11	ELECT 100MF	20% 16V
C107	1-163-005-11	CERAMIC CHIP 470PF	10% 50V
C108	1-126-933-11	ELECT 100MF	20% 16V
C109	1-163-005-11	CERAMIC CHIP 470PF	10% 50V
C110	1-163-005-11	CERAMIC CHIP 470PF	10% 50V
C111	1-163-005-11	CERAMIC CHIP 470PF	10% 50V
C112	1-126-933-11	ELECT 100MF	20% 16V
C113	1-126-967-11	ELECT 47MF	20% 50V
C114	1-126-967-11	ELECT 47MF	20% 50V
C202	1-163-016-00	CERAMIC CHIP 0.0039MF	10% 50V
C203	1-163-016-00	CERAMIC CHIP 0.0039MF	10% 50V
C204	1-136-155-00	FILM 0.015MF	5% 50V
C207	1-136-155-00	FILM 0.015MF	5% 50V
C208	1-104-664-11	ELECT 47MF	20% 16V
C209	1-104-664-11	ELECT 47MF	20% 16V
C210	1-126-933-11	ELECT 100MF	20% 16V
C211	1-126-941-11	ELECT 470MF	20% 25V
C212	1-126-933-11	ELECT 100MF	20% 16V
C213	1-126-933-11	ELECT 100MF	20% 16V
C214	1-126-942-61	ELECT 1000MF	20% 25V
C215	1-126-942-61	ELECT 1000MF	20% 25V
C216	1-163-021-91	CERAMIC CHIP 0.01MF	10% 50V
C217	1-126-964-11	ELECT 10MF	20% 50V
C218	1-136-167-00	FILM 0.15MF	5% 50V
C219	1-136-167-00	FILM 0.15MF	5% 50V
C220	1-126-942-61	ELECT 1000MF	20% 25V
C221	1-126-964-11	ELECT 10MF	20% 50V
C223	1-126-965-11	ELECT 22MF	20% 50V
C224	1-163-133-00	CERAMIC CHIP 470PF	5% 50V
C225	1-109-982-11	CERAMIC CHIP 1MF	10% 10V (KV-TF21M61/TF21M90 ONLY)
C226	1-109-982-11	CERAMIC CHIP 1MF	10% 10V
C227	1-163-037-11	CERAMIC CHIP 0.022MF	10% 50V
C228	1-163-024-00	CERAMIC CHIP 0.018MF	10% 50V
C229	1-163-018-00	CERAMIC CHIP 0.0056MF	10% 50V
C230	1-163-024-00	CERAMIC CHIP 0.018MF	10% 50V
C231	1-163-018-00	CERAMIC CHIP 0.0056MF	10% 50V
C232	1-163-037-11	CERAMIC CHIP 0.022MF	10% 50V
C233	1-164-004-11	CERAMIC CHIP 0.1MF	10% 25V
C234	1-164-004-11	CERAMIC CHIP 0.1MF	10% 25V
C235	1-164-004-11	CERAMIC CHIP 0.1MF	10% 25V
C236	1-164-004-11	CERAMIC CHIP 0.1MF	10% 25V
C238	1-164-505-11	CERAMIC CHIP 2.2MF	16V
C240	1-164-505-11	CERAMIC CHIP 2.2MF	16V
C241	1-164-346-11	CERAMIC CHIP 1MF	16V
C242	1-164-505-11	CERAMIC CHIP 2.2MF	16V
C243	1-216-295-91	SHORT 0	
C244	1-164-700-11	CERAMIC CHIP 0.68MF	16V
C245	1-164-346-11	CERAMIC CHIP 1MF	16V
C246	1-163-018-00	CERAMIC CHIP 0.0056MF	10% 50V
C247	1-164-346-11	CERAMIC CHIP 1MF	16V (KV-TF21M61/TF21M90 ONLY)

The components identified by shading and mark \triangle are critical for safety. Replace only with part number specified.

A (Except KV-PF21M70)

REF. NO.	PART NO.	DESCRIPTION	REMARK	REF. NO.	PART NO.	DESCRIPTION	REMARK
C248	1-163-010-11	CERAMIC CHIP	0.0012MF 10% 50V	C409	1-126-963-11	ELECT	4.7MF 20% 50V
C249	1-164-004-11	CERAMIC CHIP	0.1MF 10% 25V	C415	1-163-133-00	CERAMIC CHIP	470PF 5% 50V (KV-TF21M61/TF21M90 ONLY)
C250	1-216-295-91	SHORT ONLY)	0 (KV-TF21M61/TF21M90 ONLY)	C502	1-163-145-00	CERAMIC CHIP	0.0015MF 5% 50V
C251	1-163-017-00	CERAMIC CHIP	0.0047MF 10% 50V	C506	1-107-638-11	ELECT	33MF 20% 160V
C252	1-164-346-11	CERAMIC CHIP	1MF 16V	C507	1-161-830-00	CERAMIC	0.0047MF 500V
C253	1-163-037-11	CERAMIC CHIP	0.022MF 10% 50V	C510	1-102-112-00	CERAMIC	330PF 10% 50V
C254	1-126-965-11	ELECT	22MF 20% 50V	C512	1-163-989-11	CERAMIC CHIP	0.033MF 10% 25V
C255	1-163-037-11	CERAMIC CHIP	0.022MF 10% 50V	C513	1-163-263-11	CERAMIC CHIP	330PF 5% 50V
C256	1-164-004-11	CERAMIC CHIP	0.1MF 10% 25V	C514	1-106-383-00	MYLAR	0.047MF 10% 200V
C259	1-126-933-11	ELECT	100MF 20% 16V	C517	1-164-182-11	CERAMIC CHIP	0.0033MF 10% 50V
C264	1-164-505-11	CERAMIC CHIP	2.2MF 16V	C518	1-104-665-11	ELECT	100MF 20% 10V
C265	1-164-505-11	CERAMIC CHIP	2.2MF 16V	C519	1-102-212-00	CERAMIC	820PF 10% 500V
C301	1-126-935-11	ELECT	470MF 20% 16V	C521	1-126-934-11	ELECT	220MF 20% 16V
C302	1-163-005-11	CERAMIC CHIP	470PF 10% 50V	C522	1-126-933-11	ELECT	100MF 20% 16V
C303	1-126-964-11	ELECT	10MF 20% 50V	C523	1-102-002-00	CERAMIC	680PF 10% 500V
C304	1-126-967-11	ELECT	47MF 20% 50V	C524	1-126-967-11	ELECT	47MF 20% 50V
C305	1-164-004-11	CERAMIC CHIP	0.1MF 10% 25V	C526	1-130-495-00	MYLAR	0.1MF 5% 50V
C306	1-163-233-11	CERAMIC CHIP	18PF 5% 50V	C527	1-102-820-00	CERAMIC	330PF 5% 50V
C307	1-163-233-11	CERAMIC CHIP	18PF 5% 50V	C528	1-162-134-11	CERAMIC	470PF 10% 2KV
C308	1-163-259-91	CERAMIC CHIP	220PF 5% 50V	C530	1-137-372-11	FILM	0.022MF 5% 50V
C309	1-126-957-11	ELECT	0.22MF 20% 50V	C531	1-126-961-11	ELECT	2.2MF 20% 50V
C310	1-126-963-11	ELECT	4.7MF 20% 50V	C532	1-126-941-11	ELECT	470MF 20% 25V
C311	1-126-964-11	ELECT	10MF 20% 50V	C533	1-126-941-11	ELECT	470MF 20% 25V
C312	1-164-346-11	CERAMIC CHIP	1MF 16V	C536	1-136-165-00	FILM	0.1MF 5% 50V
C313	1-164-346-11	CERAMIC CHIP	1MF 16V	C537	1-126-969-11	ELECT	220MF 20% 50V
C315	1-164-004-11	CERAMIC CHIP	0.1MF 10% 25V	C538	1-136-076-00	FILM	0.0085MF 3% 2KV
C316	1-126-967-11	ELECT	47MF 20% 50V	C539	1-129-746-91	FILM	0.039MF 5% 400V
C317	1-164-004-11	CERAMIC CHIP	0.1MF 10% 25V	C540	1-136-171-00	FILM	0.33MF 5% 50V
C318	1-163-031-11	CERAMIC CHIP	0.01MF 50V	C546	1-165-319-11	CERAMIC CHIP	0.1MF 50V
C319	1-163-031-11	CERAMIC CHIP	0.01MF 50V	C549	1-163-017-00	CERAMIC CHIP	0.0047MF 10% 50V
C320	1-163-031-11	CERAMIC CHIP	0.01MF 50V	C550	1-106-220-00	MYLAR	0.1MF 10% 100V
C322	1-163-005-11	CERAMIC CHIP	470PF 10% 50V	C551	1-126-960-11	ELECT	1MF 20% 50V
C324	1-163-017-00	CERAMIC CHIP	0.0047MF 10% 50V	C552	1-162-116-00	CERAMIC	680PF 10% 2KV
C325	1-126-960-11	ELECT	1MF 20% 50V	C553	1-162-116-00	CERAMIC	680PF 10% 2KV
C327	1-126-965-11	ELECT	22MF 20% 50V	C554	1-137-417-11	MYLAR	0.0047MF 10% 200V
C328	1-164-004-11	CERAMIC CHIP	0.1MF 10% 25V	C556	1-126-941-11	ELECT	470MF 20% 25V
C330	1-164-004-11	CERAMIC CHIP	0.1MF 10% 25V	C557	1-126-941-11	ELECT	470MF 20% 25V
C331	1-247-807-31	CARBON	100 5% 1/4W	C558	1-123-024-21	ELECT	33MF 160V
C332	1-126-963-11	ELECT	4.7MF 20% 50V	C560	1-102-228-00	CERAMIC	470PF 10% 500V
C335	1-164-004-11	CERAMIC CHIP	0.1MF 10% 25V	C561	1-136-557-11	FILM	0.0033MF 5% 630V
C336	1-164-004-11	CERAMIC CHIP	0.1MF 10% 25V	C562	1-102-228-00	CERAMIC	470PF 10% 500V
C337	1-126-961-11	ELECT	2.2MF 20% 50V	C564	1-163-038-91	CERAMIC CHIP	0.1MF 25V
C338	1-163-017-00	CERAMIC CHIP	0.0047MF 10% 50V	C565	1-107-655-11	ELECT	47MF 20% 250V
C341	1-115-340-11	CERAMIC CHIP	0.22MF 10% 25V	C566	1-102-244-00	CERAMIC	220PF 10% 500V
C342	1-163-259-91	CERAMIC CHIP	220PF 5% 50V	C567	1-115-521-11	FILM	0.82MF 5% 250V
C401	1-164-346-11	CERAMIC CHIP	1MF 16V (KV-TF21M61/TF21M90 ONLY)	C568	1-102-228-00	CERAMIC	470PF 10% 500V
C402	1-164-346-11	CERAMIC CHIP	1MF 16V	C570	1-115-520-11	FILM	0.68MF 5% 250V
C403	1-163-005-11	CERAMIC CHIP	470PF 10% 50V (KV-TF21M61/TF21M90 ONLY)	C573	1-106-379-12	MYLAR	0.033MF 10% 200V
C404	1-163-005-11	CERAMIC CHIP	470PF 10% 50V	C574	1-107-636-11	ELECT	10MF 20% 160V
C405	1-126-935-11	ELECT	470MF 20% 16V	C576	1-130-495-00	MYLAR	0.1MF 5% 50V
C406	1-164-346-11	CERAMIC CHIP	1MF 16V (KV-TF21M61/TF21M90 ONLY)	C577	1-106-395-00	MYLAR	0.15MF 10% 200V
C407	1-164-346-11	CERAMIC CHIP	1MF 16V	C582	1-164-004-11	CERAMIC CHIP	0.1MF 10% 25V
C408	1-163-133-00	CERAMIC CHIP	470PF 5% 50V	C600 \triangle	1-104-705-51	FILM	0.1MF 20% 250V
				C602 \triangle	1-104-705-51	FILM	0.1MF 20% 250V (KV-TF21P11 ONLY)
				C604	1-163-009-11	CERAMIC CHIP	0.001MF 10% 50V

The components identified by shading and mark Δ are critical for safety. Replace only with part number specified.

A (Except KV-PF21M70)

REF. NO.	PART NO.	DESCRIPTION	REMARK
C605	Δ 1-127-942-51	CERAMIC 330PF	10% 250V
C606	Δ 1-127-942-51	CERAMIC 330PF	10% 250V
C607	1-161-830-00	CERAMIC 0.0047MF	99% 500V
C608	1-161-830-00	CERAMIC 0.0047MF	99% 500V
C609	1-126-968-11	ELECT 100MF	20% 50V
C610	1-126-964-11	ELECT 10MF	20% 50V
C611	1-161-830-00	CERAMIC 0.0047MF	99% 500V
C612	1-161-830-00	CERAMIC 0.0047MF	99% 500V
C613	1-117-752-11	ELECT(BLOCK) 330MF	20% 450V
C614	1-126-964-11	ELECT 10MF	20% 50V
C616	1-130-202-00	FILM 0.022MF	10% 400V
C617	1-107-792-11	CERAMIC 100PF	5% 1KV
C618	1-125-893-11	FILM 680PF	3% 1.5KV
C619	Δ 1-119-886-51	CERAMIC 470PF	10% 250V
C620	1-163-133-00	CERAMIC CHIP 470PF	5% 50V
C621	1-102-114-00	CERAMIC 470PF	10% 50V
C622	1-102-074-00	CERAMIC 0.001MF	10% 50V
C623	1-104-665-11	ELECT 100MF	20% 25V
C624	1-104-331-11	CERAMIC 0.0022MF	10% 1KV
C627	1-102-002-00	CERAMIC 680PF	10% 500V
C628	1-126-942-61	ELECT 1000MF	20% 25V
C629	1-126-964-11	ELECT 10MF	20% 50V
C630	1-123-024-21	ELECT 33MF	160V
C633	1-104-999-11	MYLAR 0.1MF	10% 200V
C634	1-126-933-11	ELECT 100MF	20% 16V
C635	1-104-665-11	ELECT 100MF	20% 10V
C636	1-104-760-11	CERAMIC CHIP 0.047MF	10% 50V
C639	1-164-004-11	CERAMIC CHIP 0.1MF	10% 25V
C640	1-164-004-11	CERAMIC CHIP 0.1MF	10% 25V
C641	1-102-002-00	CERAMIC 680PF	10% 500V
C642	1-126-943-11	ELECT 2200MF	20% 25V
C643	1-104-665-11	ELECT 100MF	20% 10V
C644	1-104-331-11	CERAMIC 0.0022MF	10% 1KV
C645	1-137-605-11	FILM 0.01MF	10% 250V
C646	1-107-679-91	ELECT 10MF	20% 450V
C647	1-163-275-11	CERAMIC CHIP 0.001MF	5% 50V
C649	1-126-940-11	ELECT 330MF	20% 25V
C650	1-163-275-11	CERAMIC CHIP 0.001MF	5% 50V
C651	1-163-133-00	CERAMIC CHIP 470PF	5% 50V
C652	1-126-965-11	ELECT 22MF	20% 50V
C653	1-104-664-11	ELECT 47MF	20% 25V
C657	1-101-821-00	CERAMIC 0.0022MF	500V
C658	1-164-004-11	CERAMIC CHIP 0.1MF	10% 25V
C901	1-136-153-00	FILM 0.01MF	5% 50V
C902	1-136-153-00	FILM 0.01MF	5% 50V
C905	1-126-963-11	ELECT 4.7MF	20% 50V
C906	1-164-346-11	CERAMIC CHIP 1MF	16V
C907	1-163-133-00	CERAMIC CHIP 470PF	5% 50V
C908	1-163-133-00	CERAMIC CHIP 470PF (KV-TF21M61/TF21M90 ONLY)	5% 50V
C909	1-164-346-11	CERAMIC CHIP 1MF (KV-TF21M61/TF21M90 ONLY)	16V
C910	1-126-967-11	ELECT 47MF	20% 50V
C911	1-126-967-11	ELECT 47MF	20% 50V
C912	1-164-004-11	CERAMIC CHIP 0.1MF	10% 25V
C913	1-126-933-11	ELECT 100MF	20% 16V
C914	1-163-133-00	CERAMIC CHIP 470PF	5% 50V

REF. NO.	PART NO.	DESCRIPTION	REMARK
		<CONNECTOR>	
CN104	1-695-915-11	TAB (CONTACT)	
CN202	* 1-785-608-11	PIN, CONNECTOR 4P	
CN203	* 1-564-506-11	PLUG, CONNECTOR 3P	
CN204	* 1-564-506-11	PLUG, CONNECTOR 3P	
CN301	* 1-774-813-11	CONNECTOR, BOARD TO BOARD 7P (KV-TF21M61/TF21P11 ONLY)	
CN305	* 1-564-509-11	PLUG, CONNECTOR 6P	
CN307	* 1-774-813-11	CONNECTOR, BOARD TO BOARD 7P (KV-TF21M61/TF21P11 ONLY)	
CN505	1-508-765-00	PIN, CONNECTOR (5MM PITCH) 3P	
CN506	4-352-844-01	PIN, LEAD, COATING	
CN507	* 1-564-507-11	PLUG, CONNECTOR 4P	
CN601	* 1-580-843-11	PIN, CONNECTOR (POWER)	
CN602	* 1-508-786-00	PIN, CONNECTOR (5MM PITCH) 2P	
CN604	* 1-573-963-11	PIN, CONNECTOR (PC BOARD) 3P	
CN609	* 1-508-784-21	PIN, CONNECTOR (5MM PITCH) 1P	
CN901	* 1-564-507-11	PLUG, CONNECTOR 4P	
		<DIODE>	
D001	8-719-988-61	DIODE 1SS355TE-17	
D005	8-719-988-61	DIODE 1SS355TE-17	
D006	8-719-988-61	DIODE 1SS355TE-17	
D100	8-719-404-50	DIODE MA111-TX (KV-TF21M61/TF21M90 ONLY)	
D203	8-719-914-42	DIODE DA204K	
D300	1-216-295-91	SHORT	0
D301	8-719-988-61	DIODE 1SS355TE-17	
D306	8-719-988-61	DIODE 1SS355TE-17	
D307	8-719-988-61	DIODE 1SS355TE-17	
D308	8-719-988-61	DIODE 1SS355TE-17	
D309	8-719-159-10	DIODE RD5.1SB-T2	
D311	8-719-988-61	DIODE 1SS355TE-17	
D312	8-719-988-61	DIODE 1SS355TE-17	
D313	8-719-988-61	DIODE 1SS355TE-17	
D314	8-719-988-61	DIODE 1SS355TE-17	
D315	8-719-988-61	DIODE 1SS355TE-17	
D316	8-719-069-57	DIODE UDZS-TE17-6.8B	
D401	8-719-158-35	DIODE RD9.1SB (KV-TF21M61/TF21M90 ONLY)	
D402	8-719-158-35	DIODE RD9.1SB	
D403	8-719-158-35	DIODE RD9.1SB	
D404	8-719-158-35	DIODE RD9.1SB (KV-TF21M61/TF21M90 ONLY)	
D405	8-719-158-35	DIODE RD9.1SB	
D406	8-719-158-35	DIODE RD9.1SB	
D504	8-719-302-43	DIODE EL1Z	
D505	8-719-988-61	DIODE 1SS355TE-17	
D506	8-719-911-19	DIODE 1SS119-25	
D507	8-719-988-61	DIODE 1SS355TE-17	
D508	8-719-988-61	DIODE 1SS355TE-17	
D509	1-216-073-00	RES,CHIP 10K	5% 1/10W
D510	8-719-988-61	DIODE 1SS355TE-17	
D511	8-719-988-61	DIODE 1SS355TE-17	
D512	8-719-988-61	DIODE 1SS355TE-17	
D513	8-719-908-03	DIODE GP08D	
D517	8-719-945-80	DIODE ERC06-15S	
D518	8-719-900-26	DIODE ERD29-08J	

A (Except KV-PF21M70)

REF. NO.	PART NO.	DESCRIPTION	REMARK	REF. NO.	PART NO.	DESCRIPTION	REMARK
D521	8-719-302-43	DIODE EL1Z		FB611	1-410-397-21	FERRITE	1.1UH
D522	8-719-302-43	DIODE EL1Z		FB613	1-410-397-21	FERRITE	1.1UH
D523	8-719-302-43	DIODE EL1Z		FB615	1-410-397-21	FERRITE	1.1UH
D527	8-719-908-03	DIODE GP08D					
D528	8-719-908-03	DIODE GP08D					
						<IC>	
D531	8-719-988-61	DIODE 1SS355TE-17		IC001	8-752-906-21	IC CXP86449-623S	
D532	8-719-988-61	DIODE 1SS355TE-17		IC002	8-759-371-21	IC MM1319AFBE	
D602	8-719-911-19	DIODE 1SS119-25		IC003	8-759-370-34	IC ST24C08FB6	
D603	8-719-150-92	DIODE RD33EB3T		IC100	8-759-042-02	IC S-80743AL-A7-S (KV-TF21M61/TF21M90 ONLY)	
D604	8-719-028-72	DIODE RGP02-17EL-6433		IC201	8-759-339-60	IC TA8248K	
D605	8-719-510-53	DIODE D4SB60L		IC203	8-759-553-40	IC TDA7429S	
D606	8-719-108-18	THYRISTOR 5P6M		IC301	8-752-088-39	IC CXA2130S	
D607	8-719-404-50	DIODE MA111-TX		IC502	8-759-700-07	IC NJM2903M	
D608	8-719-110-53	DIODE RD20ESB2		IC503	8-759-980-58	IC TDA8172	
D609	8-719-311-31	DIODE RU-1P		IC601	8-749-013-75	IC STR-F6654	
D610	8-719-043-76	DIODE AK04V0		IC602	8-749-920-61	IC SE-135N	
D611	8-719-046-74	DIODE AU-01Z-V1		IC603	8-759-701-59	IC NJM78M09FA	
D613	8-719-046-74	DIODE AU-01Z-V1		IC604	8-759-231-53	IC TA7805S	
D614	8-719-046-74	DIODE AU-01Z-V1		IC901	8-742-014-11	HYB IC SBX1981-51	
D618	8-719-067-18	DIODE RN4Z					
D620	8-719-110-72	DIODE RD30ESB2				<JACK>	
D622	8-719-071-39	DIODE FMU-G26S		J401	1-779-850-11	JACK BLOCK, PIN 6P (KV-TF21M61/TF21M90)	
D623	8-719-978-65	DIODE DTZ-TT11-15B		J401	1-779-849-11	JACK BLOCK, PIN 4P (KV-TF21P11)	
D624	8-719-404-50	DIODE MA111-TX		J901	1-770-786-11	JACK	
D625	8-719-158-39	DIODE RD10SB		J902	1-770-329-11	JACK, PIN 3P (KV-TF21M61/TF21M90)	
D627	8-719-073-84	DIODE 31DQ06-FC5		J902	1-779-205-11	JACK, PIN 2P (KV-PF21P11)	
D628	8-719-911-19	DIODE 1SS119-25				<CHIP CONDUCTOR>	
D631	8-719-068-00	DIODE ERC04-06SE		JR002	1-216-295-91	SHORT	0
D632	8-719-068-00	DIODE ERC04-06SE		JR003	1-216-295-91	SHORT	0
D633	8-719-948-45	DIODE ERA22-08		JR004	1-216-295-91	SHORT	0
D634	8-719-404-50	DIODE MA111-TX		JR005	1-216-295-91	SHORT	0
D635	8-719-404-50	DIODE MA111-TX		JR006	1-216-295-91	SHORT	0
D636	8-719-510-02	DIODE D1NS4		JR007	1-216-295-91	SHORT	0
D637	8-719-109-96	DIODE RD6.8ESB1		JR008	1-216-295-91	SHORT	0
D638	8-719-510-48	DIODE D1N20R		JR009	1-216-295-91	SHORT	0
D901	8-719-158-35	DIODE RD9.1SB		JR010	1-216-295-91	SHORT	0
D902	8-719-158-35	DIODE RD9.1SB		JR011	1-216-295-91	SHORT	0
D903	8-719-158-35	DIODE RD9.1SB (KV-TF21M61/TF21M90 ONLY)		JR012	1-216-295-91	SHORT	0
D904	8-719-158-35	DIODE RD9.1SB		JR013	1-216-295-91	SHORT	0
D905	8-719-158-35	DIODE RD9.1SB		JR014	1-216-295-91	SHORT	0
D906	8-719-045-19	DIODE SPB-26MVWF		JR015	1-216-295-91	SHORT	0
		<CONNECTOR>		JR016	1-216-295-91	SHORT	0
DY1	* 1-580-798-11	CONNECTOR PIN (DY) 6P		JR018	1-216-295-91	SHORT	0
		<FERRITE BEAD>		JR019	1-216-295-91	SHORT	0
FB103	1-410-397-21	FERRITE	1.1UH	JR102	1-216-295-91	SHORT	0
FB501	1-410-397-21	FERRITE	1.1UH	JR107	1-216-295-91	SHORT	0
FB502	1-410-397-21	FERRITE	1.1UH			(KV-TF21M61/TF21M90 ONLY)	
FB600	1-410-397-21	FERRITE	1.1UH	JR109	1-216-295-91	SHORT	0 (KV-TF21P11 ONLY)
FB601	1-410-397-21	FERRITE	1.1UH	JR202	1-216-295-91	SHORT	0
FB602	1-410-397-21	FERRITE	1.1UH	JR301	1-216-295-91	SHORT	0
FB603	1-410-397-21	FERRITE	1.1UH	JR303	1-216-295-91	SHORT	0
FB604	1-410-397-21	FERRITE	1.1UH	JR401	1-216-295-91	SHORT	0
FB607	1-410-397-21	FERRITE	1.1UH			(KV-TF21M61/TF21M90 ONLY)	
FB608	1-412-911-31	FERRITE	0UH	JR403	1-216-295-91	SHORT	0
						(KV-TF21M61/TF21M90 ONLY)	

The components identified by shading and mark \triangle are critical for safety. Replace only with part number specified.

A (Except KV-PF21M70)

REF. NO.	PART NO.	DESCRIPTION	REMARK
JR404	1-216-295-91	SHORT	0
JR405	1-216-295-91	SHORT	0
JR500	1-216-295-91	SHORT	0
JR501	1-216-295-91	SHORT	0
JR600	1-216-295-91	SHORT	0
<COIL>			
L002	1-414-856-11	INDUCTOR	10UH
L003	1-414-180-11	INDUCTOR	3.3UH
L005	1-414-233-22	INDUCTOR CHIP	0UH
L101	1-414-856-11	INDUCTOR	10UH
L102	1-414-856-11	INDUCTOR	10UH
L103	1-414-856-11	INDUCTOR	10UH
L104	1-414-856-11	INDUCTOR	10UH
L105	1-414-856-11	INDUCTOR	10UH
L204	1-414-856-11	INDUCTOR	10UH
L301	1-414-189-31	INDUCTOR	100UH
L302	1-414-185-41	INDUCTOR	22UH
L501	1-412-525-31	INDUCTOR	10UH
L502	1-422-613-11	COIL, AIR CORE	
L503	1-412-525-31	INDUCTOR	10UH
L504	1-412-525-31	INDUCTOR	10UH
L505	1-412-525-31	INDUCTOR	10UH
L506	1-412-525-31	INDUCTOR	10UH
L507	1-459-111-00	INDUCTOR	10MMH
L508	1-412-525-31	INDUCTOR	10UH
L509	1-459-390-00	INDUCTOR	390UH
L510	1-416-972-11	COIL, HORIZONTAL LINEARITY	
L512	1-412-549-31	INDUCTOR	1MMH
L513	1-412-549-31	INDUCTOR	1MMH
L515	1-459-104-00	COIL, WITH CORE	
L518	1-408-611-31	INDUCTOR	47UH
L601	1-412-527-11	INDUCTOR	15UH
L901	1-408-603-31	INDUCTOR	10UH
L902	1-408-603-31	INDUCTOR	10UH
L905	1-414-856-11	INDUCTOR	10UH
<PHOTO COUPLER>			
PH600 \triangle	8-749-924-35	PHOTO COUPLER ON3171-R	
<IC LINK>			
PS200	1-532-675-21	LINK, IC 1.5A/150V	
<TRANSISTOR>			
Q002	8-729-230-49	TRANSISTOR 2SC2712-YG	
Q003	8-729-424-08	TRANSISTOR UN2111	
Q004	8-729-421-22	TRANSISTOR UN2211	
Q101	8-729-230-49	TRANSISTOR 2SC2712-YG	
Q201	8-729-424-67	TRANSISTOR UN2216	
Q202	8-729-424-67	TRANSISTOR UN2216	
Q203	8-729-421-19	TRANSISTOR UN2213	
Q204	8-729-216-22	TRANSISTOR 2SA1162-G	
Q205	8-729-421-19	TRANSISTOR UN2213	
Q206	8-729-421-19	TRANSISTOR UN2213	

REF. NO.	PART NO.	DESCRIPTION	REMARK
Q207	8-729-421-19	TRANSISTOR UN2213	
Q301	8-729-216-22	TRANSISTOR 2SA1162-G	
Q302	8-729-230-49	TRANSISTOR 2SC2712-YG	
Q303	8-729-216-22	TRANSISTOR 2SA1162-G	
Q305	8-729-216-22	TRANSISTOR 2SA1162-G	
Q306	8-729-216-22	TRANSISTOR 2SA1162-G	
Q307	8-729-230-49	TRANSISTOR 2SC2712-YG	
Q308	8-729-216-22	TRANSISTOR 2SA1162-G	
Q312	8-729-216-22	TRANSISTOR 2SA1162-G	
Q313	8-729-230-49	TRANSISTOR 2SC2712-YG	
Q315	8-729-421-19	TRANSISTOR UN2213	
Q401	8-729-424-67	TRANSISTOR UN2216	
Q402	8-729-424-67	TRANSISTOR UN2216 (KV-TF21M61/TF21M90 ONLY)	
Q403	8-729-216-22	TRANSISTOR 2SA1162-G (KV-TF21M61/TF21M90 ONLY)	
Q404	8-729-216-22	TRANSISTOR 2SA1162-G	
Q503	8-729-230-49	TRANSISTOR 2SC2712-YG	
Q505	8-729-931-45	TRANSISTOR IRF614	
Q506	8-729-140-96	TRANSISTOR 2SD774-34	
Q507	8-729-216-22	TRANSISTOR 2SA1162-G	
Q509	8-729-230-49	TRANSISTOR 2SC2712-YG	
Q511	8-729-048-07	TRANSISTOR 2SD2578-CA	
Q601	8-729-023-22	TRANSISTOR 2SD2114K	
Q602	8-729-230-49	TRANSISTOR 2SC2712-YG	
Q603	8-729-424-08	TRANSISTOR UN2111	
Q604	8-729-200-17	TRANSISTOR 2SA1091-O	
Q605	8-729-044-30	TRANSISTOR 2SK2845-LB102	
Q606	8-729-230-49	TRANSISTOR 2SC2712-YG	
Q607	8-729-922-37	TRANSISTOR 2SD2144S-UVW	
Q608	8-729-230-49	TRANSISTOR 2SC2712-YG	
Q901	8-729-421-19	TRANSISTOR UN2213	
Q902	8-729-421-19	TRANSISTOR UN2213	
<RESISTOR>			
R001	1-414-233-22	INDUCTOR CHIP	0UH
R002	1-216-025-91	RES,CHIP	100 5% 1/10W
R003	1-216-073-00	RES,CHIP	10K 5% 1/10W
R004	1-216-025-91	RES,CHIP	100 5% 1/10W
R005	1-216-025-91	RES,CHIP	100 5% 1/10W
R007	1-216-295-91	SHORT	0
R008	1-216-065-91	RES,CHIP	4.7K 5% 1/10W
R010	1-216-065-91	RES,CHIP	4.7K 5% 1/10W
R011	1-216-065-91	RES,CHIP	4.7K 5% 1/10W
R012	1-216-065-91	RES,CHIP	4.7K 5% 1/10W
R013	1-216-065-91	RES,CHIP	4.7K 5% 1/10W
R014	1-216-025-91	RES,CHIP	100 5% 1/10W
R015	1-216-025-91	RES,CHIP	100 5% 1/10W
R016	1-216-025-91	RES,CHIP	100 5% 1/10W
R017	1-216-049-91	RES,CHIP	1K 5% 1/10W
R018	1-216-033-00	RES,CHIP	220 5% 1/10W
R019	1-216-073-00	RES,CHIP	10K 5% 1/10W
R021	1-216-073-00	RES,CHIP	10K 5% 1/10W
R022	1-216-033-00	RES,CHIP	220 5% 1/10W
R024	1-216-057-00	RES,CHIP	2.2K 5% 1/10W
R025	1-216-057-00	RES,CHIP	2.2K 5% 1/10W
R026	1-216-057-00	RES,CHIP	2.2K 5% 1/10W

A (Except KV-PF21M70)

REF. NO.	PART NO.	DESCRIPTION	REMARK	REF. NO.	PART NO.	DESCRIPTION	REMARK
R027	1-216-073-00	RES,CHIP 10K	5% 1/10W	R225	1-216-033-00	RES,CHIP 220	5% 1/10W
R028	1-216-073-00	RES,CHIP 10K	5% 1/10W	R226	1-216-033-00	RES,CHIP 220	5% 1/10W
		(KV-TF21M61/TF21M90 ONLY)		R227	1-216-033-00	RES,CHIP 220	5% 1/10W
R029	1-216-049-91	RES,CHIP 1K	5% 1/10W	R228	1-249-389-11	CARBON 4.7	5% 1/4W
						(KV-TF21M61/TF21M90 ONLY)	
R031	1-216-049-91	RES,CHIP 1K	5% 1/10W	R229	1-216-073-00	RES,CHIP 10K	5% 1/10W
R035	1-216-025-91	RES,CHIP 100	5% 1/10W	R230	1-216-073-00	RES,CHIP 10K	5% 1/10W
R036	1-216-025-91	RES,CHIP 100	5% 1/10W	R231	1-216-295-91	SHORT 0	
R037	1-216-025-91	RES,CHIP 100	5% 1/10W	R234	1-249-389-11	CARBON 4.7	5% 1/4W
R040	1-216-025-91	RES,CHIP 100	5% 1/10W	R235	1-216-069-00	RES,CHIP 6.8K	5% 1/10W
				R236	1-216-069-00	RES,CHIP 6.8K	5% 1/10W
R041	1-216-025-91	RES,CHIP 100	5% 1/10W	R237	1-216-308-00	RES,CHIP 4.7	5% 1/10W
R042	1-216-295-91	SHORT 0		R301	1-216-073-00	RES,CHIP 10K	5% 1/10W
R043	1-216-049-91	RES,CHIP 1K	5% 1/10W	R302	1-216-295-91	SHORT 0	
R044	1-216-025-91	RES,CHIP 100	5% 1/10W	R303	1-216-049-91	RES,CHIP 1K	5% 1/10W
R045	1-414-233-22	INDUCTOR CHIP 0UH		R304	1-216-073-00	RES,CHIP 10K	5% 1/10W
				R305	1-216-051-00	RES,CHIP 1.2K	5% 1/10W
R046	1-216-049-91	RES,CHIP 1K	5% 1/10W	R306	1-216-073-00	RES,CHIP 10K	5% 1/10W
R047	1-414-233-22	INDUCTOR CHIP 0UH		R307	1-216-295-91	SHORT 0	
R048	1-216-073-00	RES,CHIP 10K	5% 1/10W	R308	1-216-025-91	RES,CHIP 100	5% 1/10W
R050	1-216-073-00	RES,CHIP 10K	5% 1/10W	R309	1-216-025-91	RES,CHIP 100	5% 1/10W
R053	1-216-049-91	RES,CHIP 1K	5% 1/10W	R310	1-216-025-91	RES,CHIP 100	5% 1/10W
				R311	1-216-017-91	RES,CHIP 47	5% 1/10W
R055	1-216-073-00	RES,CHIP 10K	5% 1/10W	R312	1-216-041-00	RES,CHIP 470	5% 1/10W
R056	1-216-073-00	RES,CHIP 10K	5% 1/10W	R313	1-216-053-00	RES,CHIP 1.5K	5% 1/10W
R061	1-216-033-00	RES,CHIP 220	5% 1/10W	R314	1-216-045-00	RES,CHIP 680	5% 1/10W
R062	1-216-041-00	RES,CHIP 470	5% 1/10W				
R063	1-216-037-00	RES,CHIP 330	5% 1/10W	R316	1-216-053-00	RES,CHIP 1.5K	5% 1/10W
				R317	1-216-077-00	RES,CHIP 15K	5% 1/10W
R064	1-216-037-00	RES,CHIP 330	5% 1/10W	R318	1-216-051-00	RES,CHIP 1.2K	5% 1/10W
R065	1-216-037-00	RES,CHIP 330	5% 1/10W	R319	1-216-025-91	RES,CHIP 100	5% 1/10W
R066	1-216-049-91	RES,CHIP 1K	5% 1/10W	R320	1-216-065-91	RES,CHIP 4.7K	5% 1/10W
R101	1-216-025-91	RES,CHIP 100	5% 1/10W				
		(KV-TF21M61/TF21M90 ONLY)		R321	1-216-073-00	RES,CHIP 10K	5% 1/10W
R102	1-216-025-91	RES,CHIP 100	5% 1/10W	R322	1-216-033-00	RES,CHIP 220	5% 1/10W
		(KV-TF21M61/TF21M90 ONLY)		R326	1-216-295-91	SHORT 0	
R105	1-216-295-91	SHORT 0		R331	1-216-295-91	SHORT 0	
R109	1-216-041-00	RES,CHIP 470	5% 1/10W	R332	1-216-033-00	RES,CHIP 220	5% 1/10W
R111	1-216-025-91	RES,CHIP 100	5% 1/10W				
R112	1-216-025-91	RES,CHIP 100	5% 1/10W	R333	1-216-073-00	RES,CHIP 10K	5% 1/10W
R113	1-216-047-91	RES,CHIP 820	5% 1/10W	R334	1-216-129-00	RES,CHIP 2.2M	5% 1/10W
				R335	1-216-045-00	RES,CHIP 680	5% 1/10W
R202	1-216-077-00	RES,CHIP 15K	5% 1/10W	R338	1-216-033-00	RES,CHIP 220	5% 1/10W
R203	1-216-073-00	RES,CHIP 10K	5% 1/10W	R340	1-216-025-91	RES,CHIP 100	5% 1/10W
R204	1-216-077-00	RES,CHIP 15K	5% 1/10W				
R205	1-216-077-00	RES,CHIP 15K	5% 1/10W	R345	1-216-081-00	RES,CHIP 22K	5% 1/10W
R206	1-216-073-00	RES,CHIP 10K	5% 1/10W	R348	1-216-675-11	METAL CHIP 10K	0.50% 1/10W
				R349	1-216-073-00	RES,CHIP 10K	5% 1/10W
R207	1-216-077-00	RES,CHIP 15K	5% 1/10W	R350	1-216-061-00	RES,CHIP 3.3K	5% 1/10W
R208	1-216-071-00	RES,CHIP 8.2K	5% 1/10W	R351	1-216-053-00	RES,CHIP 1.5K	5% 1/10W
R209	1-216-071-00	RES,CHIP 8.2K	5% 1/10W				
R211	1-216-033-00	RES,CHIP 220	5% 1/10W	R354	1-216-057-00	RES,CHIP 2.2K	5% 1/10W
R212	1-216-033-00	RES,CHIP 220	5% 1/10W	R355	1-216-057-00	RES,CHIP 2.2K	5% 1/10W
				R356	1-216-057-00	RES,CHIP 2.2K	5% 1/10W
R213	1-216-073-00	RES,CHIP 10K	5% 1/10W	R357	1-216-079-00	RES,CHIP 18K	5% 1/10W
R214	1-216-073-00	RES,CHIP 10K	5% 1/10W	R358	1-216-049-91	RES,CHIP 1K	5% 1/10W
R215	1-216-059-00	RES,CHIP 2.7K	5% 1/10W				
R216	1-216-059-00	RES,CHIP 2.7K	5% 1/10W	R359	1-216-033-00	RES,CHIP 220	5% 1/10W
R217	1-216-067-00	RES,CHIP 5.6K	5% 1/10W	R360	1-216-033-00	RES,CHIP 220	5% 1/10W
				R361	1-216-073-00	RES,CHIP 10K	5% 1/10W
R218	1-216-067-00	RES,CHIP 5.6K	5% 1/10W	R362	1-216-075-00	RES,CHIP 12K	5% 1/10W
R219	1-216-025-91	RES,CHIP 100	5% 1/10W	R363	1-216-079-00	RES,CHIP 18K	5% 1/10W
R220	1-216-025-91	RES,CHIP 100	5% 1/10W				
R221	1-216-295-91	SHORT 0					
R222	1-216-295-91	SHORT 0					
		(KV-TF21M61/TF21M90 ONLY)					

A (Except KV-PF21M70)

REF. NO.	PART NO.	DESCRIPTION	REMARK	REF. NO.	PART NO.	DESCRIPTION	REMARK
R364	1-216-295-91	SHORT	0	R536	1-216-067-00	RES,CHIP	5.6K 5% 1/10W
R365	1-216-033-00	RES,CHIP	220 5%	R537	1-216-683-11	METAL CHIP	22K 0.50% 1/10W
R366	1-216-073-00	RES,CHIP	10K 5%	R540	1-216-065-91	RES,CHIP	4.7K 5% 1/10W
R367	1-216-073-00	RES,CHIP	10K 5%	R541	1-216-065-91	RES,CHIP	4.7K 5% 1/10W
R370	1-216-033-00	RES,CHIP	220 5%	R542	1-216-295-91	SHORT	0
R375	1-216-025-91	RES,CHIP (KV-TF21M61/TF21P11 ONLY)	100 5%	R543	1-249-426-11	CARBON	5.6K 5% 1/4W F
R376	1-216-081-00	RES,CHIP	22K 5%	R545	1-216-077-00	RES,CHIP	15K 5% 1/10W
R377	1-216-121-91	RES,CHIP	1M 5%	R546	1-216-077-00	RES,CHIP	15K 5% 1/10W
R378	1-216-031-00	RES,CHIP	180 5%	R547	1-216-085-00	RES,CHIP	33K 5% 1/10W
R401	1-216-049-91	RES,CHIP (KV-TF21M61/TF21M90 ONLY)	1K 5%	R549	1-215-451-00	METAL	18K 1% 1/4W
R402	1-216-073-00	RES,CHIP (KV-TF21M61/TF21M90 ONLY)	10K 5%	R550	1-216-097-91	RES,CHIP	100K 5% 1/10W
R403	1-216-073-00	RES,CHIP (KV-TF21M61/TF21M90 ONLY)	10K 5%	R551	1-249-421-11	CARBON	2.2K 5% 1/4W
R404	1-216-073-00	RES,CHIP	10K 5%	R552	1-216-057-00	RES,CHIP	2.2K 5% 1/10W
R405	1-216-049-91	RES,CHIP	1K 5%	R553	1-215-457-00	METAL	33K 1% 1/4W
R406	1-216-073-00	RES,CHIP	10K 5%	R554	1-215-457-00	METAL	33K 1% 1/4W
R407	1-216-049-91	RES,CHIP (KV-TF21M61/TF21M90 ONLY)	1K 5%	R556	1-215-437-00	METAL	4.7K 1% 1/4W
R408	1-216-049-91	RES,CHIP	1K 5%	R558	1-249-421-11	CARBON	2.2K 5% 1/4W
R409	1-216-041-00	RES,CHIP (KV-TF21M61/TF21M90 ONLY)	470 5%	R559	1-249-429-11	CARBON	10K 5% 1/4W
R410	1-216-113-00	RES,CHIP (KV-TF21M61/TF21M90 ONLY)	470K 5%	R560	1-216-073-00	RES,CHIP	10K 5% 1/10W
R411	1-216-113-00	RES,CHIP	470K 5%	R562	1-249-401-11	CARBON	47 5% 1/4W
R412	1-216-041-00	RES,CHIP	470 5%	R565	1-216-073-00	RES,CHIP	10K 5% 1/10W
R413	1-216-021-00	RES,CHIP	68 5%	R567	1-216-105-91	RES,CHIP	220K 5% 1/10W
R414	1-216-113-00	RES,CHIP	470K 5%	R568	1-249-383-11	CARBON	1.5 5% 1/4W F
R415	1-216-113-00	RES,CHIP (KV-TF21M61/TF21M90 ONLY)	470K 5%	R570	1-216-069-00	RES,CHIP	6.8K 5% 1/10W
R416	1-216-077-00	RES,CHIP (KV-TF21M61/TF21M90 ONLY)	15K 5%	R571	1-215-437-00	METAL	4.7K 1% 1/4W
R417	1-216-077-00	RES,CHIP	15K 5%	R573	1-216-089-91	RES,CHIP	47K 5% 1/10W
R418	1-216-113-00	RES,CHIP	470K 5%	R577	1-215-913-11	METAL OXIDE	220 5% 3W F
R419	1-216-022-00	RES,CHIP	75 5%	R578	1-216-369-00	METAL OXIDE	1 5% 2W F
R426	1-216-033-00	RES,CHIP	220 5%	R579	1-216-097-91	RES,CHIP	100K 5% 1/10W
R505	1-216-099-00	RES,CHIP	120K 5%	R580	1-216-699-11	METAL CHIP	100K 0.50% 1/10W
R506	1-216-085-00	RES,CHIP	33K 5%	R581	1-208-798-11	RES,CHIP	4.7K 0.50% 1/10W
R507	1-249-389-11	CARBON	4.7 5%	R585	1-249-391-11	CARBON	6.8 5% 1/4W F
R508	1-215-910-00	METAL OXIDE	68 5%	R588	1-215-888-00	METAL OXIDE	220 5% 2W F
R509	1-215-911-11	METAL OXIDE	100 5%	R589	1-215-888-00	METAL OXIDE	220 5% 2W F
R510	1-215-885-00	METAL OXIDE	68 5%	R590	1-215-465-00	METAL	68K 1% 1/4W
R511	1-215-911-11	METAL OXIDE	100 5%	R591	1-260-288-11	CARBON	0.47 5% 1/2W F
R516	1-216-081-00	RES,CHIP	22K 5%	R593	1-260-288-11	CARBON	0.47 5% 1/2W F
R518	1-247-807-31	CARBON	100 5%	R594	1-260-288-11	CARBON	0.47 5% 1/2W F
R520	1-215-445-00	METAL	10K 1%	R596	1-215-922-11	METAL OXIDE	6.8K 5% 3W F
R522	1-216-675-11	METAL CHIP	10K 0.50%	R597	1-247-750-11	CARBON	680 5% 1/2W F
R523	1-249-411-11	CARBON	330 5%	R598	1-249-438-11	CARBON	56K 5% 1/4W
R525	1-216-699-11	METAL CHIP	100K 0.50%	R599	1-249-389-11	CARBON	4.7 5% 1/4W
R526	1-208-798-11	RES,CHIP	4.7K 0.50%	R600	1-249-438-11	CARBON	56K 5% 1/4W
R527	1-216-001-00	RES,CHIP	10 5%	R601	1-249-418-11	CARBON	1.2K 5% 1/4W F
R528	1-216-683-11	METAL CHIP	22K 0.50%	R602	1-249-389-11	CARBON	4.7 5% 1/4W F
R529	1-216-635-11	METAL CHIP	220 0.50%	R603	1-215-485-00	METAL	470K 1% 1/4W
R531	1-247-843-11	CARBON	3.3K 5%	R604	1-216-097-91	RES,CHIP	100K 5% 1/10W
R533	1-249-417-11	CARBON	1K 5%	R607	1-249-425-11	CARBON	4.7K 5% 1/4W
R534	1-216-361-00	METAL OXIDE	0.22 5%	R608	1-240-205-91	CARBON	22M 5% 1/2W
R535	1-216-067-00	RES,CHIP	5.6K 5%	R609	1-216-057-00	RES,CHIP	2.2K 5% 1/10W
R610	1-216-073-00	RES,CHIP	10K 5%	R611	1-216-089-91	RES,CHIP	47K 5% 1/10W
R612	1-216-045-00	RES,CHIP	680 5%	R612	1-216-045-00	RES,CHIP	680 5% 1/10W
R614	1-216-041-00	RES,CHIP	470 5%	R614	1-216-041-00	RES,CHIP	470 5% 1/10W
R615	1-216-350-11	METAL OXIDE	1.2 5%	R615	1-216-350-11	METAL OXIDE	1.2 5% 1W F
R616	1-260-302-51	CARBON	6.8 5%	R616	1-260-302-51	CARBON	6.8 5% 1/2W F
R617	1-247-791-91	CARBON	22 5%	R617	1-247-791-91	CARBON	22 5% 1/4W

The components identified by shading and mark Δ are critical for safety. Replace only with part number specified.

A (Except KV-PF21M70)

REF. NO.	PART NO.	DESCRIPTION	REMARK
R619	1-260-128-11	CARBON 270K	5% 1/2W
R620	1-215-915-11	METAL OXIDE 470	5% 3W F
R622	1-216-400-11	METAL OXIDE 8.2	5% 3W F
R623	1-216-095-00	RES,CHIP 82K	5% 1/10W
R624	1-216-089-91	RES,CHIP 47K	5% 1/10W
R626	1-216-049-91	RES,CHIP 1K	5% 1/10W
R627	1-240-251-11	CMT,MELF 6.8	5% 10W
R629	1-247-747-11	CARBON 470	5% 1/2W F
R630	1-249-429-11	CARBON 10K	5% 1/4W F
R631	1-216-089-91	RES,CHIP 47K	5% 1/10W
R632	1-202-933-61	FUSIBLE 0.1	10% 1/2W F
R634 Δ	1-218-265-91	METAL 8.2M	5% 1W
R635	1-216-492-11	METAL OXIDE 82K	5% 3W F
R636	1-215-924-00	METAL OXIDE 15K	5% 3W F
R637	1-216-492-11	METAL OXIDE 82K	5% 3W F
R639	1-216-363-00	METAL OXIDE 0.33	5% 2W F
R640	1-249-415-11	CARBON 680	5% 1/4W
R641	1-216-362-11	METAL OXIDE 0.27	5% 2W F
R642	1-249-419-11	CARBON 1.5K	5% 1/4W
R643	1-247-843-11	CARBON 3.3K	5% 1/4W
R644	1-249-419-11	CARBON 1.5K	5% 1/4W
R646	1-215-924-00	METAL OXIDE 15K	5% 3W F
R647	1-249-401-11	CARBON 47	5% 1/4W
R648	1-216-057-00	RES,CHIP 2.2K	5% 1/10W
R649	1-249-417-11	CARBON 1K	5% 1/4W
R650	1-215-882-00	METAL OXIDE 22	5% 2W F
R652	1-215-900-11	METAL OXIDE 22K	5% 2W F
R653	1-215-873-00	METAL OXIDE 4.7K	5% 1W F
R657	1-260-127-11	CARBON 220K	5% 1/2W
R659	1-216-049-91	RES,CHIP 1K	5% 1/10W
R660	1-216-073-00	RES,CHIP 10K	5% 1/10W
R661	1-215-873-00	METAL OXIDE 4.7K	5% 1W F
R680	1-216-308-00	RES,CHIP 4.7	5% 1/10W
R901	1-249-411-11	CARBON 330	5% 1/4W
R902	1-249-411-11	CARBON 330 (KV-TF21M61/TF21M90 ONLY)	5% 1/4W
R903	1-216-022-00	RES,CHIP 75	5% 1/10W
R904	1-216-033-00	RES,CHIP 220	5% 1/10W
R905	1-216-113-00	RES,CHIP 470K	5% 1/10W
R906	1-216-077-00	RES,CHIP 15K	5% 1/10W
R907	1-216-113-00	RES,CHIP 470K (KV-TF21M61/TF21M90 ONLY)	5% 1/10W
R908	1-216-077-00	RES,CHIP 15K (KV-TF21M61/TF21M90 ONLY)	5% 1/10W
R909	1-216-065-91	RES,CHIP 4.7K	5% 1/10W
R910	1-216-065-91	RES,CHIP 4.7K	5% 1/10W
R911	1-216-067-00	RES,CHIP 5.6K	5% 1/10W
R912	1-216-041-00	RES,CHIP 470	5% 1/10W
R913	1-216-049-91	RES,CHIP 1K	5% 1/10W
R914	1-216-055-00	RES,CHIP 1.8K	5% 1/10W
R915	1-216-061-00	RES,CHIP 3.3K	5% 1/10W
R916	1-216-017-91	RES,CHIP 47	5% 1/10W
R917	1-216-041-00	RES,CHIP 470	5% 1/10W
R918	1-216-041-00	RES,CHIP 470	5% 1/10W

REF. NO.	PART NO.	DESCRIPTION	REMARK
		<RELAY>	
R601 Δ	1-755-266-11	RELAY, AC POWER	
		<SWITCH>	
S502	1-572-707-11	SWITCH, LEVER	
S600 Δ	1-571-433-21	SWITCH, PUSH (AC POWER)	
S901	1-692-431-21	SWITCH, TACTILE	
S902	1-692-431-21	SWITCH, TACTILE	
S903	1-692-431-21	SWITCH, TACTILE	
S904	1-692-431-21	SWITCH, TACTILE	
S905	1-692-431-21	SWITCH, TACTILE	
S906	1-692-431-21	SWITCH, TACTILE	
S907	1-692-431-21	SWITCH, TACTILE	
		<TRANSFORMER>	
T501	1-437-195-11	TRANSFORMER, HORIZONTAL DRIVE	
T503 Δ	1-453-293-11	TRANSFORMER ASSY, FLYBACK (NX-1748/M3A4)	
T601	1-424-682-11	TRANSFORMER, LINE FILTER	
T603 Δ	1-433-512-31	TRANSFORMER, CONVERTER (SRT)	
T604 Δ	1-431-852-11	TRANSFORMER, CONVERTER (SRT)	
		<THERMISTOR>	
THP600	1-810-961-11	THERMISTOR, POSITIVE	
		<TUNER>	
TU101	8-598-451-00	TUNER, FSS BTF-WG441 (KV-TF21M61/TF21M90)	
TU101	8-598-447-00	TUNER, FSS BTF-LG411 (KV-TF21P110)	
		<CRYSTAL>	
X001	1-579-125-11	VIBRATOR, CERAMIC	
X301	1-781-134-21	VIBRATOR, CRYSTAL	
X302	1-781-132-21	VIBRATOR, CRYSTAL	

The components identified by shading and mark Δ are critical for safety. Replace only with part number specified.

C3 (KV-PF21M70)

REF. NO.	PART NO.	DESCRIPTION	REMARK
	* A-1331-884-A	C3 BOARD, MOUNTED (KV-PF21M70) *****	
	7-682-948-01	SCREW +PSW 3X8	
		<CAPACITOR>	
C701	1-115-350-51	CERAMIC	0.0047MF 2KV
C702	1-102-074-00	CERAMIC	0.001MF 10% 50V
C703	1-107-651-11	ELECT	4.7MF 20% 250V
C704	1-130-202-00	FILM	0.022MF 5% 400V
C706	1-104-664-11	ELECT	47MF 20% 16V
C708	1-102-114-00	CERAMIC	470PF 10% 50V
C709	1-102-114-00	CERAMIC	470PF 10% 50V
C710	1-102-114-00	CERAMIC	470PF 10% 50V
C712	1-102-116-00	CERAMIC	680PF 10% 50V
C713	1-102-116-00	CERAMIC	680PF 10% 50V
C714	1-102-116-00	CERAMIC	680PF 10% 50V
C716	1-126-933-11	ELECT	100MF 20% 16V
C717	1-101-880-00	CERAMIC	47PF 5% 50V
C736	1-102-114-00	CERAMIC	470PF 10% 50V
C737	1-102-114-00	CERAMIC	470PF 10% 50V
C746	1-102-114-00	CERAMIC	470PF 10% 50V
		<CONNECTOR>	
CN701	1-508-765-00	PIN, CONNECTOR (5MM PITCH) 3P	
CN702	1-695-915-11	TAB (CONTACT)	
CN703	* 1-564-509-11	PLUG, CONNECTOR 6P	
CN704	1-695-915-11	TAB (CONTACT)	
		<DIODE>	
D701	8-719-911-19	DIODE 1SS119-25	
D702	8-719-911-19	DIODE 1SS119-25	
D703	8-719-911-19	DIODE 1SS119-25	
D707	8-719-911-19	DIODE 1SS119-25	
D708	8-719-911-19	DIODE 1SS119-25	
D709	8-719-911-19	DIODE 1SS119-25	
D710	8-719-911-19	DIODE 1SS119-25	
D711	8-719-911-19	DIODE 1SS119-25	
D712	8-719-911-19	DIODE 1SS119-25	
D713	8-719-911-19	DIODE 1SS119-25	
D714	8-719-911-19	DIODE 1SS119-25	
D715	8-719-911-19	DIODE 1SS119-25	
D716	8-719-911-19	DIODE 1SS119-25	
D717	8-719-121-26	DIODE RD9.1ESL2	
		<JACK>	
J701	Δ 1-540-071-22	SOCKET, CRT	
		<COIL>	
L701	1-410-667-31	INDUCTOR	22UH
L710	1-408-609-41	INDUCTOR	33UH
L711	1-408-609-41	INDUCTOR	33UH
L712	1-408-609-41	INDUCTOR	33UH

REF. NO.	PART NO.	DESCRIPTION	REMARK
		<TRANSISTOR>	
Q704	8-729-326-11	TRANSISTOR 2SC2611	
Q705	8-729-326-11	TRANSISTOR 2SC2611	
Q706	8-729-326-11	TRANSISTOR 2SC2611	
Q707	8-729-200-17	TRANSISTOR 2SA1091-O	
Q708	8-729-200-17	TRANSISTOR 2SA1091-O	
Q709	8-729-200-17	TRANSISTOR 2SA1091-O	
Q710	8-729-119-78	TRANSISTOR 2SC2785-HFE	
Q711	8-729-119-78	TRANSISTOR 2SC2785-HFE	
Q712	8-729-119-78	TRANSISTOR 2SC2785-HFE	
		<RESISTOR>	
R703	1-249-496-11	CARBON	100K 5% 1/2W
R705	1-216-380-11	METAL OXIDE	8.2 5% 2W F
R706	1-215-417-00	METAL	680 1% 1/4W
R707	1-215-413-00	METAL	470 1% 1/4W
R708	1-216-379-11	METAL OXIDE	6.8 5% 2W F
R710	1-215-922-11	METAL OXIDE	6.8K 5% 3W F
R711	1-247-752-11	CARBON	1K 5% 1/2W
R712	1-215-922-11	METAL OXIDE	6.8K 5% 3W F
R713	1-247-752-11	CARBON	1K 5% 1/2W
R714	1-215-922-11	METAL OXIDE	6.8K 5% 3W F
R715	1-247-752-11	CARBON	1K 5% 1/2W
R719	1-215-480-00	METAL	300K 1% 1/4W
R720	1-249-923-11	CARBON	1K 5% 1/4W F
R721	1-215-489-00	METAL	680K 1% 1/4W
R722	1-249-923-11	CARBON	1K 5% 1/4W F
R723	1-215-479-00	METAL	270K 1% 1/4W
R724	1-249-923-11	CARBON	1K 5% 1/4W F
R725	1-249-421-11	CARBON	2.2K 5% 1/4W
R726	1-249-421-11	CARBON	2.2K 5% 1/4W
R727	1-249-421-11	CARBON	2.2K 5% 1/4W
R728	1-249-407-11	CARBON	150 5% 1/4W
R729	1-249-407-11	CARBON	150 5% 1/4W
R730	1-249-407-11	CARBON	150 5% 1/4W
R731	1-249-399-11	CARBON	33 5% 1/4W
R732	1-249-399-11	CARBON	33 5% 1/4W
R733	1-249-399-11	CARBON	33 5% 1/4W
R734	1-247-739-11	CARBON	100 5% 1/2W
R738	1-247-807-31	CARBON	100 5% 1/4W
R739	1-247-807-31	CARBON	100 5% 1/4W
R740	1-247-807-31	CARBON	100 5% 1/4W
R755	1-249-418-11	CARBON	1.2K 5% 1/4W
R756	1-249-418-11	CARBON	1.2K 5% 1/4W
R757	1-249-418-11	CARBON	1.2K 5% 1/4W
		<VARIABLE RESISTOR>	
RV702	1-241-656-21	RES, ADJ, METAL FILM 110M	

The components identified by shading and mark Δ are critical for safety. Replace only with part number specified.

C5 (Except KV-PF21M70)

REF. NO.	PART NO.	DESCRIPTION	REMARK
	* A-1331-941-A	C5 BOARD, MOUNTED (EXCEPT KV-PF21M70) *****	
	7-682-948-01	SCREW +PSW 3X8	
		<CAPACITOR>	
C701	1-115-350-51	CERAMIC	0.0047MF 2KV
C702	1-102-074-00	CERAMIC	0.001MF 10% 50V
C703	1-107-651-11	ELECT	4.7MF 20% 250V
C704	1-130-202-00	FILM	0.022MF 5% 400V
C706	1-104-664-11	ELECT	47MF 20% 16V
C708	1-102-114-00	CERAMIC	470PF 10% 50V
C709	1-102-114-00	CERAMIC	470PF 10% 50V
C710	1-102-114-00	CERAMIC	470PF 10% 50V
C712	1-102-116-00	CERAMIC	680PF 10% 50V
C713	1-102-116-00	CERAMIC	680PF 10% 50V
C714	1-102-116-00	CERAMIC	680PF 10% 50V
C716	1-126-933-11	ELECT	100MF 20% 16V
C717	1-101-880-00	CERAMIC	47PF 5% 50V
C736	1-102-114-00	CERAMIC	470PF 10% 50V
C737	1-102-114-00	CERAMIC	470PF 10% 50V
C746	1-102-114-00	CERAMIC	470PF 10% 50V
C1803	1-126-964-11	ELECT	10MF 20% 50V
C1804	1-126-964-11	ELECT	10MF 20% 50V
C1809	1-126-942-61	ELECT	1000MF 20% 25V
		<CONNECTOR>	
CN701	1-508-765-00	PIN, CONNECTOR (5MM PITCH) 3P	
CN702	1-695-915-11	TAB (CONTACT)	
CN703	* 1-564-509-11	PLUG, CONNECTOR 6P	
CN704	1-695-915-11	TAB (CONTACT)	
CN1801	* 1-564-507-11	PLUG, CONNECTOR 4P	
CN1802	* 1-564-506-11	PLUG, CONNECTOR 3P	
		<DIODE>	
D701	8-719-911-19	DIODE 1SS119-25	
D702	8-719-911-19	DIODE 1SS119-25	
D703	8-719-911-19	DIODE 1SS119-25	
D707	8-719-911-19	DIODE 1SS119-25	
D708	8-719-911-19	DIODE 1SS119-25	
D709	8-719-911-19	DIODE 1SS119-25	
D710	8-719-911-19	DIODE 1SS119-25	
D711	8-719-911-19	DIODE 1SS119-25	
D712	8-719-911-19	DIODE 1SS119-25	
D713	8-719-911-19	DIODE 1SS119-25	
D714	8-719-911-19	DIODE 1SS119-25	
D715	8-719-911-19	DIODE 1SS119-25	
D716	8-719-911-19	DIODE 1SS119-25	
D717	8-719-121-26	DIODE RD9.1ESL2	
D1803	8-719-911-19	DIODE 1SS119-25	
D1804	8-719-911-19	DIODE 1SS119-25	
D1808	8-719-908-03	DIODE GP08D	

REF. NO.	PART NO.	DESCRIPTION	REMARK
		<IC>	
IC1800	8-759-822-38	IC LA6510	
		<JACK>	
J701	Δ 1-540-071-22	SOCKET, CRT	
		<COIL>	
L701	1-410-667-31	INDUCTOR	22UH
L710	1-408-609-41	INDUCTOR	33UH
L711	1-408-609-41	INDUCTOR	33UH
L712	1-408-609-41	INDUCTOR	33UH
		<TRANSISTOR>	
Q704	8-729-326-11	TRANSISTOR 2SC2611	
Q705	8-729-326-11	TRANSISTOR 2SC2611	
Q706	8-729-326-11	TRANSISTOR 2SC2611	
Q707	8-729-200-17	TRANSISTOR 2SA1091-O	
Q708	8-729-200-17	TRANSISTOR 2SA1091-O	
Q709	8-729-200-17	TRANSISTOR 2SA1091-O	
Q710	8-729-119-78	TRANSISTOR 2SC2785-HFE	
Q711	8-729-119-78	TRANSISTOR 2SC2785-HFE	
Q712	8-729-119-78	TRANSISTOR 2SC2785-HFE	
Q1802	8-729-119-78	TRANSISTOR 2SC2785-HFE	
		<RESISTOR>	
R703	1-249-496-11	CARBON	100K 5% 1/2W
R705	1-216-380-11	METAL OXIDE	8.2 5% 2W F
R706	1-215-417-00	METAL	680 1% 1/4W
R707	1-215-413-00	METAL	470 1% 1/4W
R708	1-216-379-11	METAL OXIDE	6.8 5% 2W F
R710	1-215-922-11	METAL OXIDE	6.8K 5% 3W F
R711	1-247-752-11	CARBON	1K 5% 1/2W
R712	1-215-922-11	METAL OXIDE	6.8K 5% 3W F
R713	1-247-752-11	CARBON	1K 5% 1/2W
R714	1-215-922-11	METAL OXIDE	6.8K 5% 3W F
R715	1-247-752-11	CARBON	1K 5% 1/2W
R719	1-215-480-00	METAL	300K 1% 1/4W
R720	1-249-923-11	CARBON	1K 5% 1/4W F
R721	1-215-489-00	METAL	680K 1% 1/4W
R722	1-249-923-11	CARBON	1K 5% 1/4W F
R723	1-215-479-00	METAL	270K 1% 1/4W
R724	1-249-923-11	CARBON	1K 5% 1/4W F
R725	1-249-421-11	CARBON	2.2K 5% 1/4W
R726	1-249-421-11	CARBON	2.2K 5% 1/4W
R727	1-249-421-11	CARBON	2.2K 5% 1/4W
R728	1-249-407-11	CARBON	150 5% 1/4W
R729	1-249-407-11	CARBON	150 5% 1/4W
R730	1-249-407-11	CARBON	150 5% 1/4W
R731	1-249-399-11	CARBON	33 5% 1/4W
R732	1-249-399-11	CARBON	33 5% 1/4W
R733	1-249-399-11	CARBON	33 5% 1/4W
R734	1-247-739-11	CARBON	100 5% 1/2W
R738	1-247-807-31	CARBON	100 5% 1/4W

The components identified by shading and mark Δ are critical for safety. Replace only with part number specified.

C5 (Except KV-PF21M70)

F

V1 (KV-TF21M61/TF21P11 only)

REF. NO.	PART NO.	DESCRIPTION	REMARK
R739	1-247-807-31	CARBON 100	5% 1/4W
R740	1-247-807-31	CARBON 100	5% 1/4W
R755	1-249-418-11	CARBON 1.2K	5% 1/4W
R756	1-249-418-11	CARBON 1.2K	5% 1/4W
R757	1-249-418-11	CARBON 1.2K	5% 1/4W
R1802	1-249-387-11	CARBON 3.3	5% 1/4W F
R1803	1-249-387-11	CARBON 3.3	5% 1/4W F
R1805	1-249-429-11	CARBON 10K	5% 1/4W
R1806	1-249-425-11	CARBON 4.7K	5% 1/4W
R1808	1-249-425-11	CARBON 4.7K	5% 1/4W
R1809	1-249-435-11	CARBON 33K	5% 1/4W
R1810	1-249-435-11	CARBON 33K	5% 1/4W
R1811	1-249-440-11	CARBON 82K	5% 1/4W
R1812	1-249-435-11	CARBON 33K	5% 1/4W
R1821	1-249-440-11	CARBON 82K	5% 1/4W
R1822	1-249-435-11	CARBON 33K	5% 1/4W
R1823	1-249-426-11	CARBON 5.6K	5% 1/4W
R1824	1-249-435-11	CARBON 33K	5% 1/4W
		<VARIABLE RESISTOR>	
RV702	1-241-656-21	RES, ADJ, METAL FILM 110M	

	* A-1241-355-A	F BOARD, MOUNTED	*****
	1-533-223-11	CLIP, FUSE	
	* 4-374-846-01	COVER, CAPACITOR, CAP TYPE	
		<CAPACITOR>	
C654	Δ 1-117-703-51	CERAMIC 0.0047MF	99% 250V
C4602	Δ 1-104-708-51	FILM 0.47MF	20% 250V
		<CONNECTOR>	
CN4601*	1-580-843-11	PIN, CONNECTOR (POWER)	
CN4602*	1-580-843-11	PIN, CONNECTOR (POWER)	
CN4603	1-695-915-11	TAB (CONTACT)	
		<FUSE>	
F4601	Δ 1-532-237-11	FUSE, TIME-LAG (BET) 3.15A/250V	
		<RESISTOR>	
R4601	Δ 1-202-719-91	SOLID 1M	10% 1/2W
		<TRANSFORMER>	
T4601	1-424-682-11	TRANSFORMER, LINE FILTER	
T4602	1-424-682-11	TRANSFORMER, LINE FILTER	

REF. NO.	PART NO.	DESCRIPTION	REMARK
		<VARISTOR>	
VDR461	1-801-073-31	VARISTOR TNR14V471K660	

	* A-1347-155-A	V1 BOARD, COMPLETE	***** (KV-TF21M61/TF21P11 ONLY)
		<CAPACITOR>	
C801	1-104-664-11	ELECT 47MF	20% 16V
C805	1-163-038-91	CERAMIC CHIP 0.1MF	25V
C806	1-163-038-91	CERAMIC CHIP 0.1MF	25V
C815	1-163-251-11	CERAMIC CHIP 100PF	5% 50V
C816	1-164-505-11	CERAMIC CHIP 2.2MF	16V
C817	1-164-004-11	CERAMIC CHIP 0.1MF	10% 25V
C818	1-163-239-11	CERAMIC CHIP 33PF	5% 50V
C820	1-163-239-11	CERAMIC CHIP 33PF	5% 50V
C821	1-163-038-91	CERAMIC CHIP 0.1MF	25V
C822	1-163-009-11	CERAMIC CHIP 0.001MF	10% 50V
C823	1-126-933-11	ELECT 100MF	20% 16V
C826	1-126-963-11	ELECT 4.7MF	20% 50V
C829	1-163-113-00	CERAMIC CHIP 68PF	5% 50V
C830	1-163-038-91	CERAMIC CHIP 0.1MF	25V
C831	1-126-933-11	ELECT 100MF	20% 16V
C832	1-126-964-11	ELECT 10MF	20% 50V
C835	1-163-038-91	CERAMIC CHIP 0.1MF	25V
C837	1-126-933-11	ELECT 100MF	20% 16V
		<CONNECTOR>	
CN801	* 1-774-812-11	CONNECTOR, BOARD TO BOARD 7P	
CN803	* 1-774-812-11	CONNECTOR, BOARD TO BOARD 7P	
		<DIODE>	
D802	8-719-914-44	DIODE DAP202K	
D803	8-719-105-46	DIODE RD3.3M-B2	
D804	8-719-105-91	DIODE RD5.6M-B2	
D806	8-719-988-61	DIODE 1SS355TE-17	
D807	8-719-988-61	DIODE 1SS355TE-17	
		<FERRITE BEAD>	
FB801	1-410-397-21	FERRITE 1.1UH	
FB802	1-410-397-21	FERRITE 1.1UH	
FB803	1-410-397-21	FERRITE 1.1UH	
FB804	1-410-682-31	INDUCTOR 470UH	
FB805	1-410-397-21	FERRITE 1.1UH	
		<IC>	
IC801	8-759-476-87	IC SAA5261	

<u>REF. NO.</u>	<u>PART NO.</u>	<u>DESCRIPTION</u>	<u>REMARK</u>
ACCESSORIES AND PACKING MATERIALS			

	1-417-151-21	MATCHING TRANSFORMER, ANTENNA (KV-PF21M70 ONLY)	
	1-501-372-81	ANTENNA, TELESCOPIC (KV-PF21M70 ONLY)	
	3-701-910-00	SCREW, SPECIAL (DIA. 3.8X20)	
	3-867-184-11	MANUAL, INSTRUCTION (KV-PF21M70)	
	3-866-883-11	MANUAL, INSTRUCTION (KV-TF21M61)	
	3-866-883-21	MANUAL, INSTRUCTION (KV-TF21M90)	
	3-866-883-31	MANUAL, INSTRUCTION (KV-TF21P11)	
*	4-070-297-01	CUSHION(UPPER)(ASSY)	
*	4-070-298-01	CUSHION(LOWER)(ASSY)	
*	4-070-299-01	INDIVIDUAL CARTON	
	4-392-003-11	BAND, HOLD	
	4-392-004-11	CLIP	
*	4-392-859-01	BAG, PROTECTION	

REMOTE COMMANDER			

	1-418-163-11	REMOTE COMMANDER (RM-952)	
	9-939-697-01	BATTERY COVER, REMOTE COMMANDER	

Free Manuals Download Website

<http://myh66.com>

<http://usermanuals.us>

<http://www.somanuals.com>

<http://www.4manuals.cc>

<http://www.manual-lib.com>

<http://www.404manual.com>

<http://www.luxmanual.com>

<http://aubethermostatmanual.com>

Golf course search by state

<http://golfingnear.com>

Email search by domain

<http://emailbydomain.com>

Auto manuals search

<http://auto.somanuals.com>

TV manuals search

<http://tv.somanuals.com>