

Trinitron Color TV

Operating Instructions

GB

- Before operating the unit, please read this manual thoroughly and retain it for future reference.

Mode D'emploi

FR

- Avant de faire fonctionner cet appareil, lisez attentivement le présent mode d'emploi et conservez-le pour toute référence ultérieure.

دفتريچہ راہنما

PR

- قبل از تنظیم دستگاه، لطفاً دفتريچہ راہنما را به دقت بخوانيد و به منظور مراجعه بعدی آن را نگه داريد.

تعليمات التشغيل

AR

- قبل تشغيل الجهاز، يرجى قراءة هذا الدليل بصورة كاملة والاحتفاظ به للمراجعة مستقبلاً.

KV-XG29**KV-XG25****KV-XA21**

© 2000 Sony Corporation

M85
M83
M81
M80

WARNING

- Dangerously high voltages are present inside the TV.
- Operate the TV only between 110 – 240 V AC.

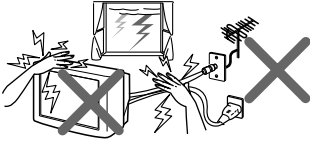

For your own safety, do not touch any part of the TV, the power cord and the antenna cable during lightning storms.



For children's safety, do not leave children alone with the TV. Do not allow children to climb onto it.

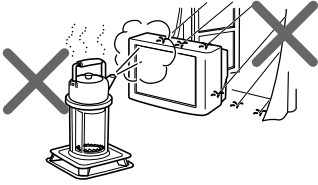

To prevent fire or shock hazard, do not expose the TV to rain or moisture.

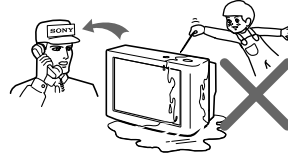

Do not operate the TV if any liquid or solid object falls into it. Have it checked immediately by qualified personnel only.

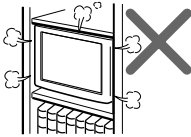

Do not block the ventilation openings of the TV. Do not install the TV in a confined space, such as a bookcase or built-in cabinet.

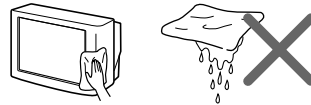

Clean the TV with a dry and soft cloth. Do not use benzene, thinner, or any other chemicals to clean the TV. Do not scratch the picture tube.

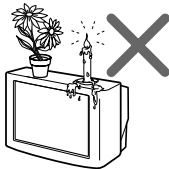

Do not place any objects on the TV.

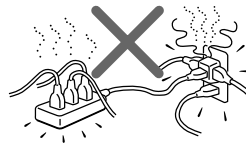

Do not plug in too many appliances to the same power socket. Do not damage the power cord.

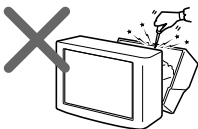

Do not open the cabinet and the rear cover of the TV as high voltages and other hazards are present inside the TV. Refer servicing and disposal of the TV to qualified personnel.

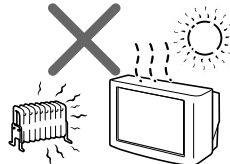

Your TV is recommended for home use only. Do not use the TV in any vehicle or where it may be subject to excessive dust, heat, moisture or vibrations.

Table of Contents

Using Your New TV

Getting Started	4
Step 1: Connect the antenna	4
Step 2: Insert the batteries into the remote	5
Step 3: Preset the channels automatically	5
Connecting the TWEETER (KV-XA21M85/XA21M83 only)	6
Connecting optional components	7
Securing the TV	9
Presetting channels	10
Watching the TV	13

Advanced Operations

Customizing the picture and sound	16
Viewing your favorite channels	19
Blocking the channels (CHILD LOCK)	20
Viewing Teletext (KV-XG29M81/XA21M85 only)	21

Additional Information

Self-diagnosis function	23
Troubleshooting	24
Overview of controls	27
Specifications	Back cover

WARNING (continued)

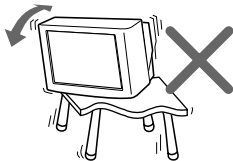

Install the TV on a stable TV stand and floor which can support the TV set weight. Ensure that the TV stand surface is flat and its area is larger than the bottom area of the TV.



Pull the power cord out by the plug. Do not pull the power cord itself. Even if your TV is turned off, it is still connected to the AC power source (mains) as long as the power cord is plugged in. Unplug the TV before moving it or if you are not going to use it for several days.

Getting Started

Step 1

Connect the antenna

If you wish to connect a VCR, see the **Connecting a VCR** diagram below.

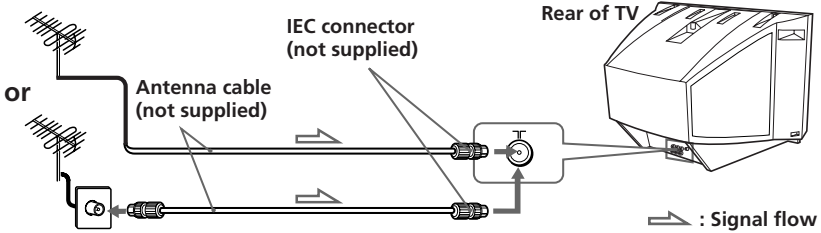

Connecting a VCR

To watch the video input, press (see page 14).

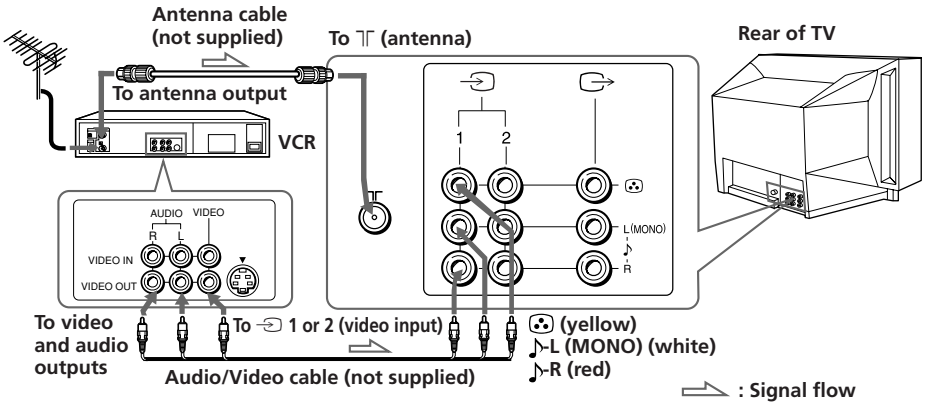

KV-XG29M81/XG29M80/XG25M80

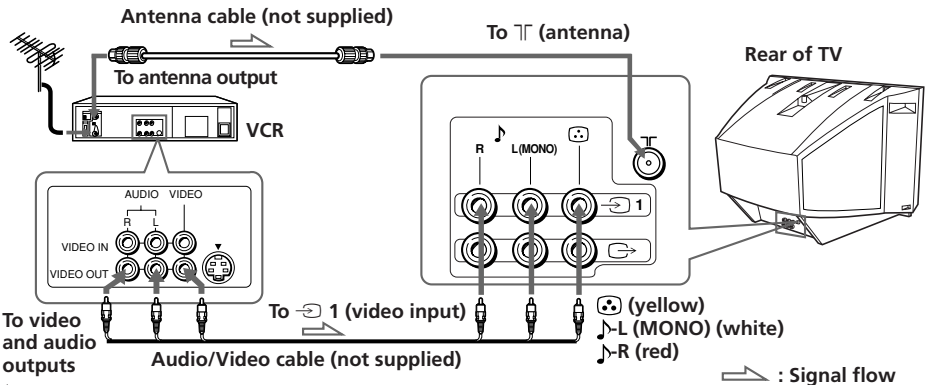

KV-XA21M85/XA21M83/XA21M80



Notes

- If you connect a monaural VCR, connect the yellow plug to  (the yellow jack) and the black plug to  (the white jack).
- If you connect a VCR to the  (antenna) terminal, preset the signal output from the VCR to the program number 0 on the TV.
- When no signal is input from the connected video equipment, the TV screen becomes blue.

KV-XG29M81/XG29M80/XG25M80 only

- Do not connect video equipment to the  2 (video input) jacks at the front and the rear of your TV at the same time; otherwise the picture will not be displayed properly on the screen.

CAUTION

- Do not connect the power cord until you have completed making all other connections; otherwise a minimum leakage current might flow through the antenna and other terminals to ground.
- To avoid battery leakage and damage to the remote, remove the batteries from the remote if you are not going to use it for several days. If any liquid that leaks from the batteries touches you, immediately wash it away with water.

Step 2

Insert the batteries into the remote

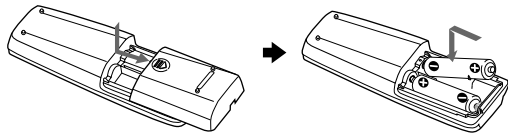
**Note**

- Do not use old batteries nor use different types of batteries together.

Step 3

Preset the channels automatically

Front of TV

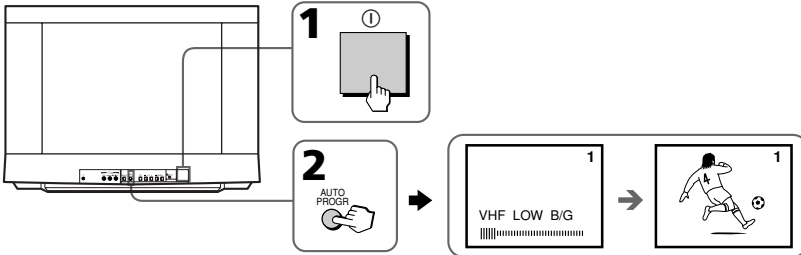
**Tips**

- If you want to stop automatic channel presetting, press SELECT twice.
- If your TV has preset an unwanted channel or cannot preset a particular channel, then preset your TV manually (see page 11).

Note

- During automatic channel presetting, your TV screen will indicate "B/G", "I", "D/K" or "M" for the TV system (TV SYS).

Connecting the TWEETER

(KV-XA21M85/XA21M83 only)

You can enjoy high quality sound by connecting the TWEETER.

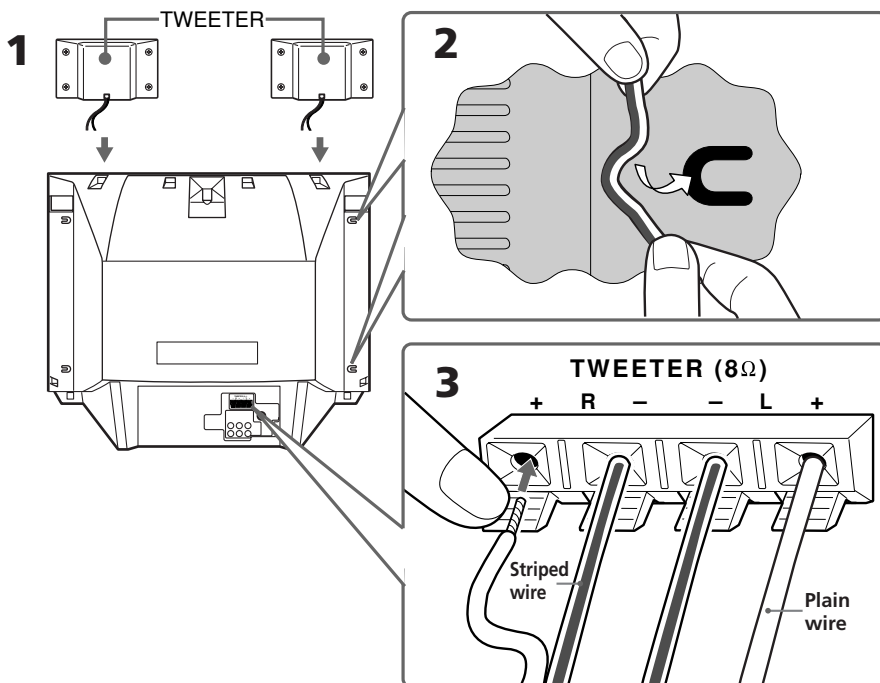

- 1** Place the TWEETER on top of your TV.
- 2** Bend the wire to hook it at the side of your TV.
- 3** Connect the wires to the TWEETER (8 Ω) terminals at the rear of your TV. The plain wire should be connected to the \oplus red terminal and the striped wire to the \ominus black terminal.

Notes

- Connect only the supplied TWEETER; otherwise your TV may malfunction.
- Unplug your TV from the wall outlet when connecting the TWEETER.
- To prevent a malfunction caused by a short circuit of the terminals, make sure that none of the TWEETER wire strands stick out, making contact with the neighbouring TWEETER terminal.

Connecting optional components

You can connect optional audio/video components, such as a VCR, multi disc player, camcorder, video game or stereo system.

To watch the video input of the connected equipment, press \rightarrow (see page 14).

Connecting a camcorder/video game equipment using the \rightarrow (video input) jacks

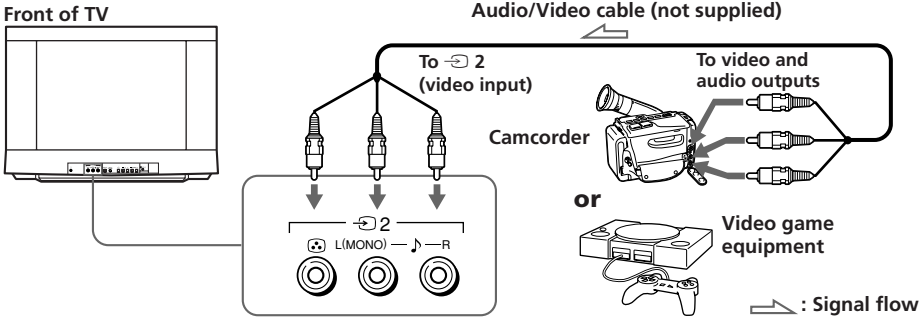

Notes

KV-XA21M85/XA21M83/XA21M80 only

- You can also connect video equipment to the \rightarrow 1 (video input) jack at the rear of your TV.

KV-XG29M81/XG29M80/ XG25M80 only

- You can also connect video equipment to the \rightarrow 1 or 2 (video input) jacks at the rear of your TV.
- Do not connect video equipment to the \rightarrow 2 (video input) jacks at the front and the rear of your TV at the same time; otherwise the picture will not be displayed properly on the screen.

Connecting audio/video equipment using the \rightarrow (monitor output) jacks

KV-XG29M81/XG29M80/XG25M80

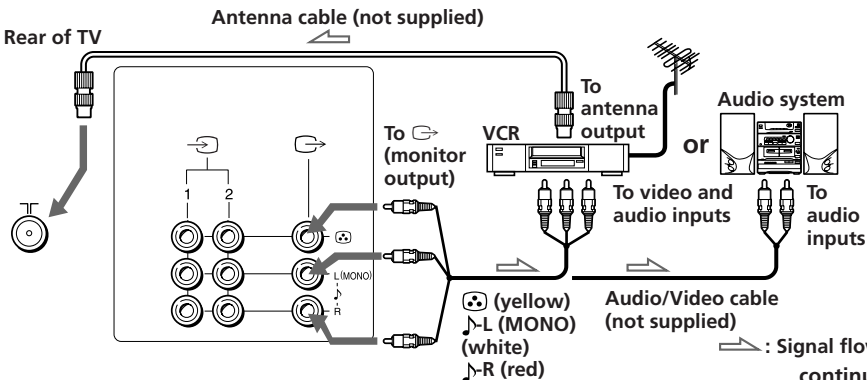

continued

Connecting optional components (continued)

KV-XA21M85/XA21M83/XA21M80

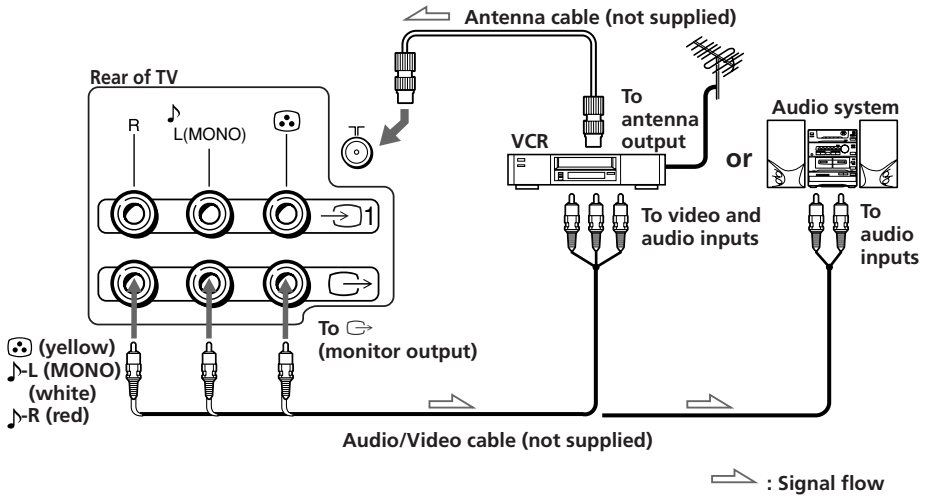

Note

- If you connect a monaural VCR, connect the yellow plug to Ⓜ (the yellow jack) and the black plug to ♪-L (MONO) (the white jack).

Securing the TV

To prevent the TV from falling, secure the TV using one of the following methods:

- A** With the supplied screws, attach the band to the TV stand and to the rear of the TV using the provided hole.

or

- B** Put the cord or chain through the clamps to secure the TV against a wall or pillar.

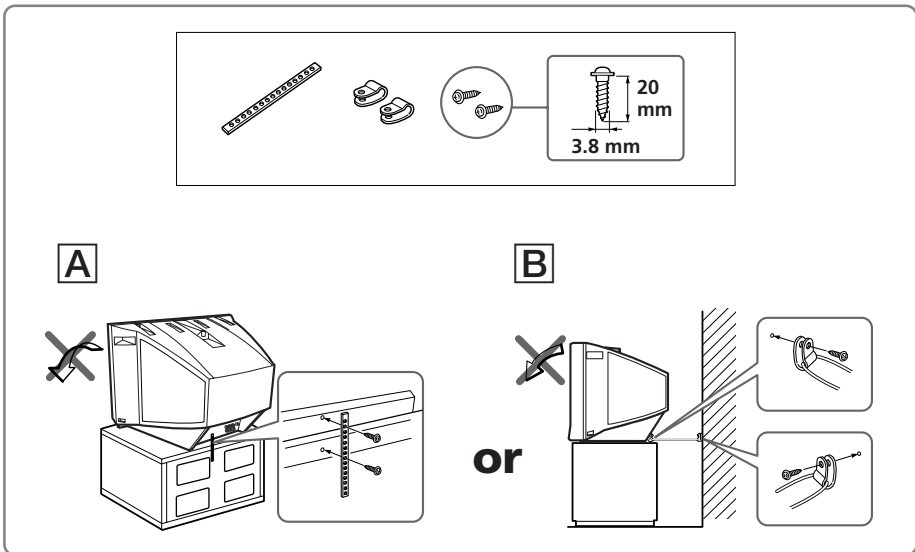

Note

- Use only the supplied screws. Use of other screws may damage the TV.

Presetting channels

You can preset up to 100 TV channels in numerical sequence from program number 1 using the remote and the buttons on your TV as well.

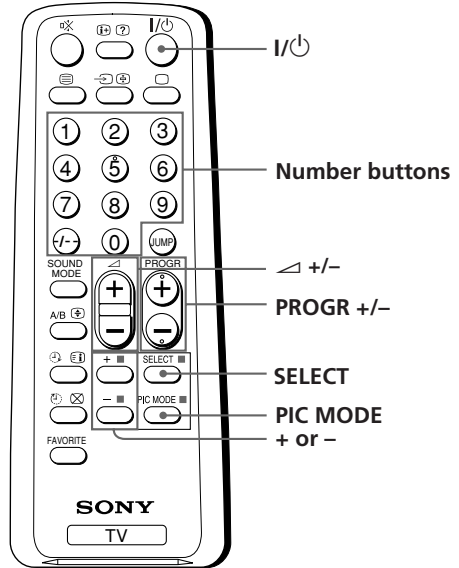
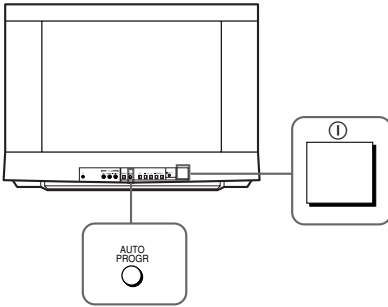

Presetting channels automatically

1 Press ① to turn on the TV.



2 Press AUTO PROGR.

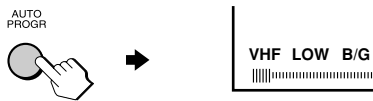

Note

- During automatic channel presetting, your TV screen will indicate "B/G", "I", "D/K" or "M" for the TV system (TV SYS).

To preset channels automatically from a specified program number

- (1) Press SELECT until "AUTO PROGRAM" appears.
- (2) Press + or -.
The on-screen display will start flashing.
- (3) Press PROGR +/- or the number buttons until the desired program number appears.
- (4) Press + or -.

Presetting channels manually

- 1** Press SELECT until "MANUAL PROGRAM" appears.



- 2** Press + or –.



- 3** Press PROGR +/- or the number buttons until the desired program number appears.

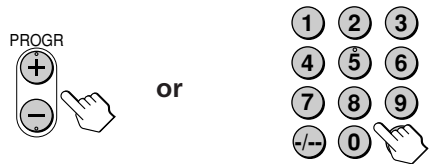

- 4** Press + or – until the desired channel picture appears.

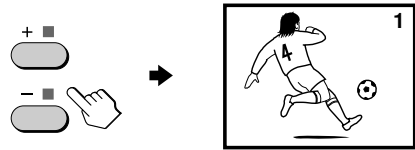

- 5** Press SELECT.



Note

- If you preset a locked program number, that particular program number will be unlocked automatically (page 20).

To change the TV system setting

If the picture or sound is abnormal when receiving programs through the ㄗ (antenna) terminal

- (1) Press SELECT until "TV SYS" appears.

TV SYS: B/G

- (2) Press + or – to select the appropriate TV system until the picture or sound quality is optimal.

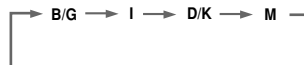

continued

Presetting channels (continued)

To change the color system setting

If the color is abnormal when receiving programs through the ㄗ (antenna) terminal or the ㊟ (video input) jack.

(1) Press SELECT until "COLOR SYS" appears.

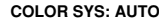

COLOR SYS: AUTO

(2) Press + or - to select the appropriate color system until the color is optimal.



Tip

- Normally set "COLOR SYS" to "AUTO".

Skipping program numbers

1 Press PROGR +/- or the number buttons until the unused or unwanted program number appears.

2 Press SELECT until "MANUAL PROGRAM" appears.

3 Press + or -.

4 Press PIC MODE.

5 Press SELECT.

To restore the skipped program number again

Preset the channel automatically or manually.

Tip

- You can also use SELECT and ㄏ +/- on the TV to preset channels and skip program numbers.

To use the fine tuning (FINE) function

The fine tuning (FINE) function may help to reduce the following problems: incomplete Teletext display (KV-XG29M81/XA21M85 only), double images and lines moving across the TV screen.

You can use the fine tuning function as below:



- (1) Select the program number you want to adjust.
- (2) Press SELECT until "MANUAL PROGRAM" appears on the screen.
- (3) Press + or - on the remote control once.
- (4) Press ㊟ to display "FINE" on the screen.
- (5) Press + or - continuously until the above problems are minimized.
The + or - icon on the screen flashes while tuning.
- (6) Press SELECT to return to normal screen.

Watching the TV

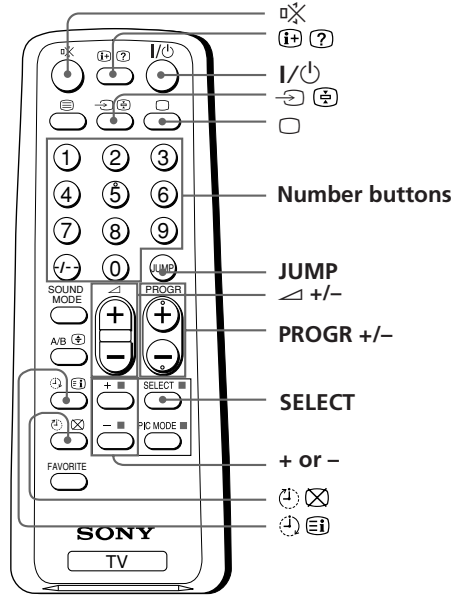
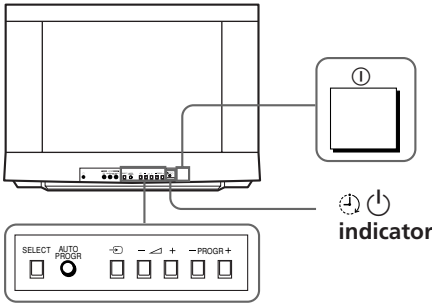
This section explains functions used while watching the TV. Most operations can be done using the remote.





1 Press ① to turn on the TV.

When the TV is in the standby mode (the  indicator on the TV is lit red), press  on the remote or  on the TV.



2 Press PROGR +/- or the number buttons to select the program number.

For double digit numbers, press , then the number (e.g., for 25, press , then 2 and 5).

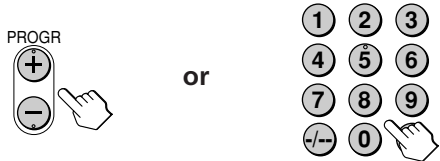

3 Press +/- to adjust the volume.



continued

Watching the TV (continued)

Additional tasks

To	Press
Turn off temporarily	I/⏻. The ⏻ indicator on the TV lights up red.
Turn off completely	Ⓛ on the TV.
Mute the sound	🔇.
Watch the video input (VCR, camcorder, etc.)	↶ to select "VIDEO 1" or "VIDEO 2". ↷ to return to the TV program, press Ⓛ.
Jump back to the previous program number	JUMP.
Display the on-screen information*	ⓘ.
Adjust the volume of all program numbers automatically	SELECT repeatedly until "INTELLIGENT VOL" appears, then press + or - to select "ON". To cancel, select "OFF".
Adjust the picture position when it is not aligned to the TV screen (KV-XG29M81/XG29M80/XG25M80/XA21M85 only)	SELECT repeatedly until "PIC ROTATION" appears, then press + or - to adjust the alignment of the picture position.

PIC ROTATION Ⓡ↕↶↷

The ↶ or ↷ icon on the screen flashes while adjusting.

- * The picture, sound, and either the program number or video input are displayed. The on-screen display for the picture and sound information disappears after about three seconds.

Changing the on-screen display language

- 1** Press SELECT until "LANGUAGE / اللغة : ENGLISH" appears on the screen.



- 2** Press + or - to select "عربي".





Tip

- You can also use SELECT and ⏻ +/- on the TV to select the on-screen display language.

Setting the Wake Up timer

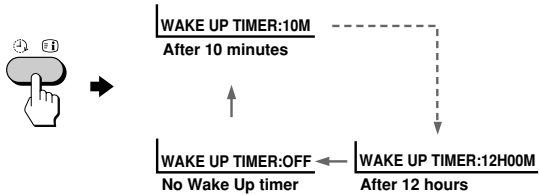
- 1** Press  until the desired period of time appears.
The Wake Up timer starts immediately after you have set it.



- 2** Select the program number or video input you want to display when you wake up.
- 3** Press I/⏻ or set the Sleep timer if you want the TV to turn off automatically.
The  indicator on the TV lights up orange.

To cancel the Wake Up timer

Press  until "WAKE UP TIMER: OFF" appears or turn off the TV's main power.

Note

- If no buttons or controls are pressed for more than two hours after the TV is turned on using the Wake Up timer, the TV automatically goes into the standby mode. To continue watching the TV, press any button or control on the TV or the remote.

Setting the Sleep timer

Press  until the desired period of time appears.

The Sleep timer starts immediately after you have set it.

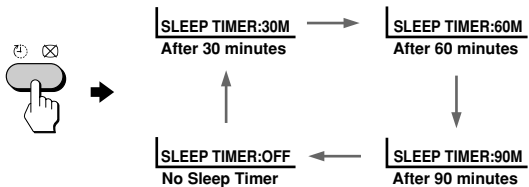

To cancel the Sleep timer

Press  until "SLEEP TIMER: OFF" appears or turn the TV off.

Customizing the picture and sound

You can customize the picture and sound by selecting the picture and sound modes or by adjusting its settings.

You can change the sound effect by selecting the surround mode.

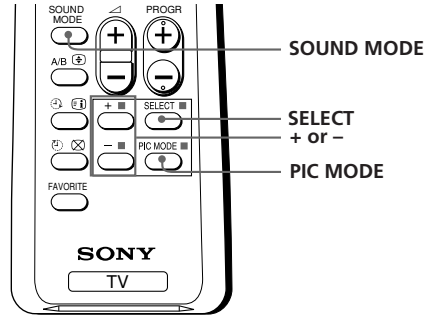

Selecting the picture and sound modes

To select the picture mode

Press PIC MODE repeatedly until you get the desired picture mode.

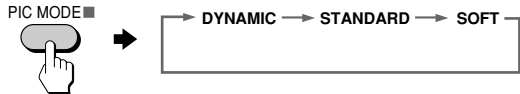

Select	To
"DYNAMIC"	view high contrast pictures.
"STANDARD"	view normal contrast pictures.
"SOFT"	view mild pictures.

To select the sound mode

Press SOUND MODE repeatedly until you get the desired sound mode.



Select	To
"DYNAMIC"	listen to dynamic and clear sound that emphasizes the low and high sound.
"DRAMA"	listen to sound that emphasizes vocals and background music.
"SOFT"	listen to soft sound.

Adjusting the picture and sound settings

- 1** Press SELECT until the desired setting appears.



Each time you press SELECT, the setting item will change as follows:

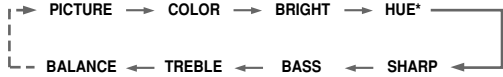

- 2** Press + or – to adjust the item.

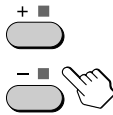

- 3** To adjust other items, repeat steps 1 to 2.

* "HUE" can be adjusted for the NTSC system only.

Notes

- When you select a picture or sound mode, the adjusted settings will be reset according to the selected mode.
- You can also use SELECT and  +/- on the TV to adjust the picture and sound settings.

continued

Customizing the picture and sound (continued)

Selecting the surround mode

KV-XG29M81/XG29M80/XG25M80

- 1** Press SELECT repeatedly until "SURROUND" appears.



SURROUND: MOVIE

- 2** Press + or - to select the desired surround sound.

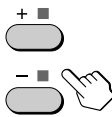

MOVIE → MUSIC → OFF

Select	To
"MOVIE"	listen to sound that spreads out over a large area, giving the feeling of being at a movie theatre.
"MUSIC"	listen to the sound that gives the feeling of being at a live concert.
"OFF"	turn off the surround sound.

KV-XA21M85/XA21M83/XA21M80

- 1** Press SELECT repeatedly until "SURROUND" appears.



SURROUND: ON

- 2** Press + or - to select "ON".

To turn off the surround mode, select "OFF".

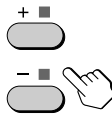

ON → OFF

Viewing your favorite channels

You can display six of your favorite channels for quick and easy selection. You can program the favorite channel as well.

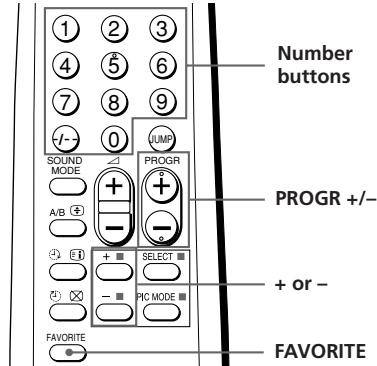

Selecting a favorite channel

1 Press FAVORITE.

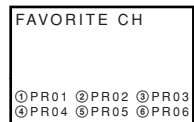

2 Press the number button from 1 to 6 to select the desired favorite channel.



When you use the “FAVORITE CH” feature for the first time, six preset channels will appear.

Programming the favorite channel

1 Press PROGR +/- or number buttons to select the program number you want to program (e.g., program number 8).

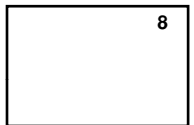
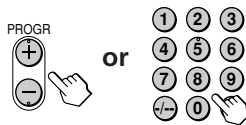

2 Press SELECT until “FAVORITE CH SETUP” appears.

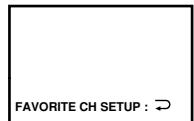

3 Press + or - to select the favorite channel you want to program (e.g., ③).

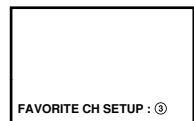

4 Press SELECT.

The selected favorite channel (e.g., ③) turns red for about one second.



5 To program other favorite channels, repeat steps 1 to 4.

Blocking the channels (CHILD LOCK)

You can lock some program numbers to prevent children from watching certain channels, by using the buttons on the remote control.

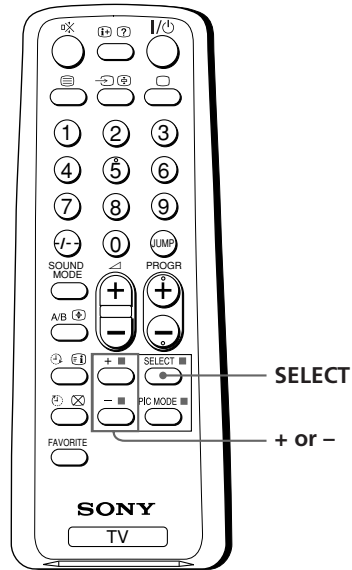



1 Select the program number you want to lock.

2 Press SELECT until "CHILD LOCK" appears on the screen.



3 Press + or - to select "ON".

The  symbol appears on the screen.

To cancel, press + or - to select "OFF". The  symbol disappears from the screen.



Note

- If you preset a locked program number, that particular program number will be unlocked automatically (page 10).

Viewing Teletext

(KV-XG29M81/XA21M85 only)

TV stations broadcast an information service called Teletext via some TV channels. Teletext allows you to receive various information, such as shares market or news.

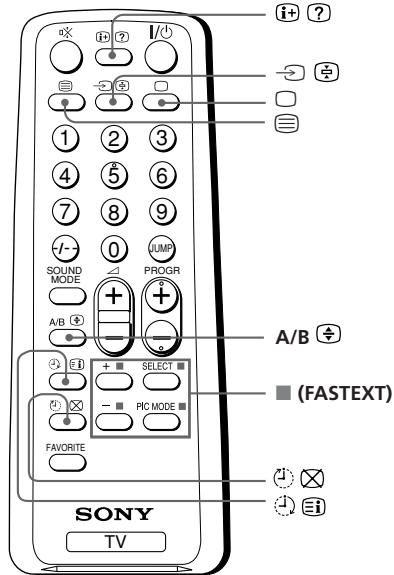

Displaying Teletext

1 Select a TV channel that carries the Teletext broadcast you want to watch.

2 Press to display the text.

A Teletext page (normally the index page) is displayed. If there is no Teletext broadcast, "100" is displayed at the top left corner of the screen.

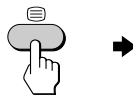

P166 SECTEXT 166 FR1 MAR 03:59:00

TRAVEL				
From Singapore	Day	Dep/Arr	Flight	Aircraft
To PARIS	1, 8	02:00/06:00	SC208	747
	2	21:30/12:25	PA115	L15
	3	21:15/13:50	SC208	747
To OSAKA	2, 8	10:00/17:15	SC1	747
	4, 6	09:00/09:15	CA822	L10
To ROMA	2, 7	21:30/07:45	RG24	747
	4	23:00/09:15	AZ607	747
To SYDNEY	1	25:10/06:10	SC21A	747
	2	21:00/08:05	SC21A	747













To turn off Teletext

Press .

continued

Viewing Teletext (continued)

Additional Teletext tasks

To	Do this
display a Teletext page on the TV picture	Press  . Each time you press  , the screen changes as follows: Teletext → Teletext and TV → TV.
check the contents of a Teletext service	Press  . An overview of the Teletext contents and page numbers appear on the screen.
select a Teletext page	Press the number buttons to enter the three-digit page number of the desired Teletext page. * If you make a mistake, reenter the correct page number. To access the next or previous page, press PROGR +/-.
hold (pause) a Teletext display	Press  to display the symbol "  " at the top left corner of the screen. To resume normal Teletext operation, press  or  .
reveal concealed information (e.g., an answer to a quiz)	Press  . To conceal the information, press the button again.
enlarge the Teletext display	Press  . Each time you press  , the Teletext display changes as follows: Enlarge upper half → Enlarge lower half → Normal size.
wait for a Teletext page while watching a TV program	1 Enter the Teletext page number that you want to refer to, then press  . 2 When the page number is displayed, press  to show the text.

* You can also select a Teletext page that appears in the colored column at the bottom of the screen using the corresponding color-coded button on the remote.



Using FASTEXT

This feature allows you to quickly access a Teletext page that uses FASTEXT. When a FASTEXT program is broadcasted, the colored menus appear at the bottom of the screen. The colors of the menus correspond to the red ■, green ■, yellow ■, and blue ■ color-coded buttons on the remote.

To access a FASTEXT menu





Press the color-coded button on the remote corresponding to the menu you want. The menu page appears on the screen after several seconds.

Self-diagnosis function

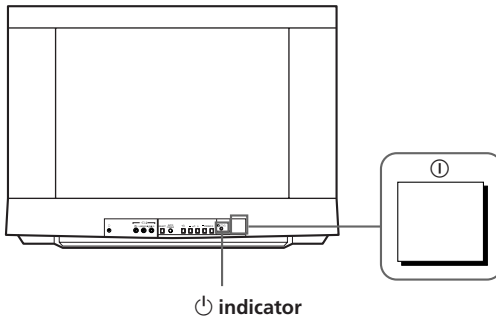
Your TV is equipped with a self-diagnosis function. If there is a problem with your TV, the  indicator flashes red. The number of times the  indicator flashes indicates the possible causes.







Front of TV



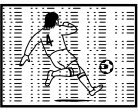



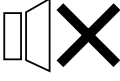

- 1** Check that the  indicator flashes red a number of times between 3-second intervals.
- 2** Count the number of times the  indicator flashes.
- 3** Press  (main power) to turn off your TV.
- 4** Inform your nearest Sony service center about the number of times the  indicator flashes.
Be sure to note the model name and serial number located on the rear of your TV.

Troubleshooting



If you find any problem while viewing your TV, please check the following guide. If any problem persists, contact your Sony dealer .

Symptom	Possible cause	Solutions	Page
Snowy picture 	<ul style="list-style-type: none"> • Connection is loose or the cable is damaged. • Channel presetting is inappropriate or incomplete. 	<ul style="list-style-type: none"> • Check the antenna cable and connection on the TV, VCR and on the wall. • Press SELECT until "MANUAL PROGRAM" appears on the screen, then preset the channel again. 	<p>4</p> <p>11</p>
Noisy sound 	<ul style="list-style-type: none"> • The antenna type is inappropriate. • The antenna direction is inappropriate. • Signal transmission is low. 	<ul style="list-style-type: none"> • Check the antenna type (VHF/UHF). Contact a Sony dealer for advice. • Adjust the antenna direction. Contact a Sony dealer for advice. • Try using a booster. 	<p>–</p> <p>–</p> <p>–</p>
Distorted picture 	<ul style="list-style-type: none"> • Broadcast signals are too strong. 	<ul style="list-style-type: none"> • Turn off or disconnect the booster if it is in use. 	<p>–</p>
Noisy sound 			
Good picture 	<ul style="list-style-type: none"> • The TV system setting or channel presetting is inappropriate or incomplete. 	<ul style="list-style-type: none"> • If the sound of some channels are noisy, select the channel, then select the appropriate TV system (TV SYS). 	<p>11</p>
Noisy sound 			
No picture 	<ul style="list-style-type: none"> • The power cord, antenna or VCR is not connected. • The TV is not turned on. 	<ul style="list-style-type: none"> • Check the power cord, antenna and the VCR connections. • Press I/⏻ (power). • Press ① (main power) on the TV to turn off the TV for about five seconds, then turn it on again. 	<p>4</p> <p>14</p> <p>13</p>
No sound 			

Symptom	Possible cause	Solutions	Page
Good picture 	<ul style="list-style-type: none"> The volume level is too low. 	<ul style="list-style-type: none"> Press \triangleleft + to increase the volume level. 	13
No sound 	<ul style="list-style-type: none"> The sound is muted. 	<ul style="list-style-type: none"> Press \otimes to cancel the muting. 	14
Dotted lines or stripes 	<ul style="list-style-type: none"> There is local interference from cars, neon signs, hair dryers, power generators, etc. 	<ul style="list-style-type: none"> Do not use a hair dryer or other equipment near the TV. Adjust the antenna direction for minimum interference. Contact a Sony dealer for advice. 	–
Double images or "ghosts" 	<ul style="list-style-type: none"> Broadcast signals are reflected by nearby mountains or buildings. 	<ul style="list-style-type: none"> Use a highly directional antenna. Use the fine tuning (FINE) function. 	–
	<ul style="list-style-type: none"> The antenna direction is inappropriate. 	<ul style="list-style-type: none"> Adjust the antenna direction. Contact a Sony dealer for advice. 	–
	<ul style="list-style-type: none"> Use of a booster is inappropriate. 	<ul style="list-style-type: none"> Turn off or disconnect the booster if it is in use. 	–
No color 	<ul style="list-style-type: none"> The color level setting is too low. 	<ul style="list-style-type: none"> Press SELECT until "COLOR" appears on the screen, then press + or – to adjust the color level. 	17
	<ul style="list-style-type: none"> The color system setting is inappropriate. 	<ul style="list-style-type: none"> Press SELECT until "COLOR SYS " appears on the screen, then check the color system setting (usually set this to "AUTO"). 	12
	<ul style="list-style-type: none"> The antenna direction is inappropriate. 	<ul style="list-style-type: none"> Adjust the antenna direction. Contact a Sony dealer for advice. 	–
Abnormal color patches 	<ul style="list-style-type: none"> The magnetic disturbance from external speakers or other equipment, or the direction of the earth's magnetic field may affect the TV. 	<ul style="list-style-type: none"> Keep external speakers or other electrical equipment away from the TV. Do not move the TV while the TV is turned on. Press $\text{\textcircled{D}}$ (main power) on the TV to turn off the TV for about 15 minutes, then turn it on again. 	–

continued

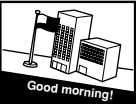
Troubleshooting (continued)

Symptom	Possible cause	Solutions	Page
"100" appears on the top of the screen and there is no Teletext display. (KV-XG29M81/XA21M85 only)	<ul style="list-style-type: none"> The channel carries no Teletext broadcast. 	—	21
Teletext display is incomplete (snowy picture or double images). (KV-XG29M81/XA21M85 only)	<ul style="list-style-type: none"> Connection is loose or the cable is damaged. 	<ul style="list-style-type: none"> Check the antenna cable and connection on the TV, VCR, and at the wall. 	4
	<ul style="list-style-type: none"> The antenna direction is inappropriate. 	<ul style="list-style-type: none"> Adjust the antenna direction. Contact a Sony dealer for advice. 	—
	<ul style="list-style-type: none"> Signal transmission is too low. 	<ul style="list-style-type: none"> Try using a booster. Use the fine tuning (FINE) function. 	— 12
Picture slant (KV-XG29M81/XG29M80/XG25M80/XA21M85 only) 	<ul style="list-style-type: none"> The magnetic disturbance from external speakers or other equipment, or the direction of the earth's magnetic field may affect the TV. 	<ul style="list-style-type: none"> Keep external speakers or other electrical equipment away from the TV. Press SELECT until "PIC ROTATION" appears on the screen, then press + or – to adjust the picture until it is optimal. 	— 14
Lines moving across the TV screen.	<ul style="list-style-type: none"> There is interference from external sources, e.g., heavy machineries, nearby broadcast station. 	<ul style="list-style-type: none"> Use the fine tuning (FINE) function. 	12
The  indicator on your TV flashes red a number of times between 3-second intervals.	<ul style="list-style-type: none"> Your TV may need service. 	<ul style="list-style-type: none"> Contact your nearest Sony service center. 	23
TV cabinet creaks.	<ul style="list-style-type: none"> Changes in room temperature sometimes make the TV cabinet expand or contract, making a noise. This does not indicate a malfunction. 	—	—
A "boom" sound is heard when the TV is turned on.	<ul style="list-style-type: none"> The TV's demagnetizing function is working. This does not indicate a malfunction. 	—	—

Overview of controls

TV front panel

KV-XG29M81/XG29M80/XG25M80

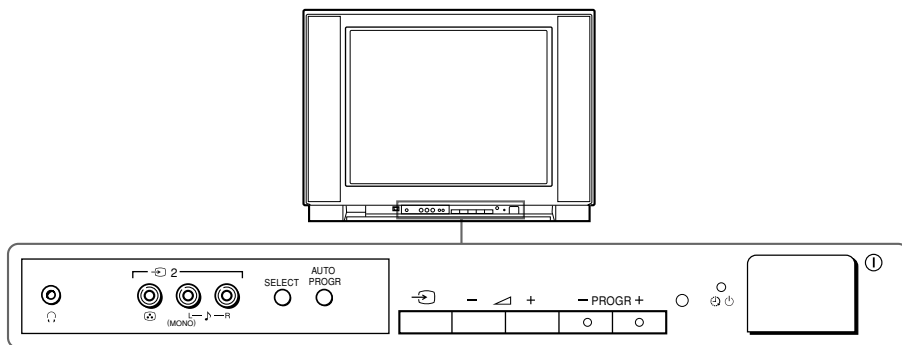

KV-XA21M85/XA21M83/XA21M80

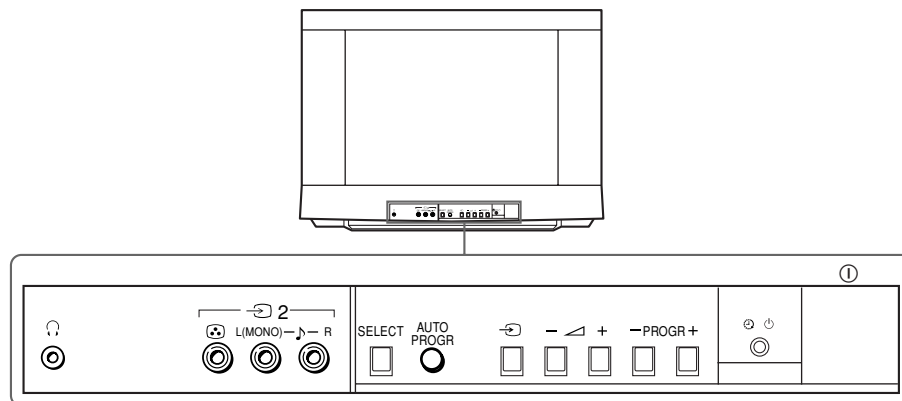

Button	Function	Page
AUTO PROGR	Preset channels automatically.	5
SELECT	Select the desired item.	12
PROGR +/-	Select program number.	13
①	Turn off completely or turn on the TV.	13
▲ +/-	Adjust volume.	13
⏻	Standby indicator.	13
↶	Select TV or video input.	14
⌚	Wake Up indicator.	15
🎧	Headphone jack.	-

continued

Overview of controls (continued)

Remote Control

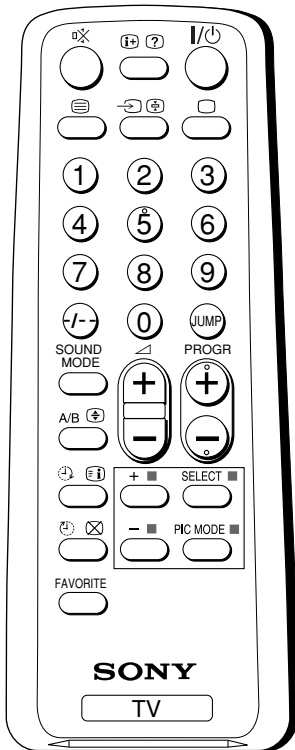

The names/symbols of buttons on the remote are indicated in different colors to represent the available functions.

Label color	Button function
White	For general TV operations
Green	For Teletext operations

Button	Function	Page
SELECT	Select the desired item.	11
+/-	Adjust value.	11
PROGR +/-	Select program number.	13
0 - 9, -/--	Input numbers.	13
△ +/-	Adjust volume.	13
I/⏻	Turn off temporarily or turn on the TV.	13
↶	Select TV or video input.	14
□	Display the TV program.	14
⏻	Mute the sound.	14
ⓘ	Display on-screen information.	14
JUMP	Jump to previous program number.	14
Timer operations		
⌚	Set TV to turn on automatically.	15
⌚	Set TV to turn off automatically.	15
PIC MODE	Select picture mode.	16
SOUND MODE	Select sound mode.	16
FAVORITE	Display favorite channels.	19
Stereo/bilingual operations (Not used for KV-XG29M81/XG29M80/XG25M80/XA21M85/XA21M83/XA21M80)		
A/B	Select stereo/bilingual mode.	-
Teletext operations (KV-XG29M81/XA21M85 only)		
⌘	Display Teletext broadcast.	21
ⓘ	Display Teletext service contents.	22
⊕	Stop Teletext display from scrolling.	22
?	Reveal concealed information.	22
⊕	Enlarge the Teletext display.	22
⊗	Show TV screen while waiting for Teletext page.	22
■ (red, green, yellow, blue)	Access a FASTEXT menu.	22

Specifications

	KV-XA21M85 KV-XA21M83 KV-XA21M80	KV-XG25M80	KV-XG29M81 KV-XG29M80	Note
Power requirements	110-240 V AC, 50/60 Hz			
Power consumption (W)	Indicated on the rear of the TV			
Television system	B/G, I, D/K, M			
Color system	PAL, PAL 60, SECAM, NTSC3.58, NTSC4.43			
Teletext language	English, Arabic, French			KV-XG29M81 / XA21M85 only
Channel coverage				
B/G	VHF : E2 to E12 UHF: E21 to E69 CATV : S01 to S03, S1 to S41			
I	UHF : B21 to B68 CATV : S01 to S03, S1 to S41			
D/K	VHF: C1 to C12, R1 to R12 UHF : C13 to C57, R21 to R60 CATV : S01 to S03, S1 to S41, Z1 to Z39			
M	VHF : A2 to A13 UHF: A14 to A79 CATV : A-8 to A-2, A to W+4, W+6 to W+84			
T (Antenna)	75-ohm external terminal			
Audio output (Speaker)	5W + 5W 5W + 5W (TWEETER supplied)			KV-XA21M85 / XA21M83 only
Number of terminal				
📺 (Video)	Input: 2 Output: 1	Input: 3* Output: 1	Input: 3* Output: 1	* Two input lines available Phono jacks; 1Vp-p, 75 ohms
🎵 (Audio)	Input: 2 Output: 1	Input: 3* Output: 1	Input: 3* Output: 1	* Two input lines available Phono jacks; 500 mVrms
🎧 (Headphone)	Output: 1	Output: 1	Output: 1	Stereo minijack
Picture tube	21 in.	25 in.	29 in.	
Tube size (cm)	54	64	72	Measured diagonally
Screen size (cm)	51	60	68	Measured diagonally
Dimensions (w/h/d, mm)	620 × 452 × 496	722 × 515 × 512	794 × 573 × 517	
Mass (kg)	26	38	48	

Design and specifications are subject to change without notice.

<http://www.world.sony.com/>

Sony Corporation

Free Manuals Download Website

<http://myh66.com>

<http://usermanuals.us>

<http://www.somanuals.com>

<http://www.4manuals.cc>

<http://www.manual-lib.com>

<http://www.404manual.com>

<http://www.luxmanual.com>

<http://aubethermostatmanual.com>

Golf course search by state

<http://golfingnear.com>

Email search by domain

<http://emailbydomain.com>

Auto manuals search

<http://auto.somanuals.com>

TV manuals search

<http://tv.somanuals.com>