

MiniDisc Deck

Operating Instructions



MDS-SP55

©2000 Sony Corporation

Do not install the appliance in a confined space, such as a bookcase or built-in cabinet.



This appliance is classified as a CLASS 1 LASER product. The CLASS 1 LASER PRODUCT MARKING is located on the rear exterior.

The following caution label is located inside of the unit.



US and foreign patents licensed from Dolby Laboratories.

The MDS-SP55 MD deck is designed only for the CMT-SP55TC Micro Hi-Fi component system

Here are some of the features you can use with this MD deck when connected with the CMT-SP55TC Micro Hi-Fi component system (see page 4).

Auto Power On/Off

The MD deck power is tied with the CMT-SP55TC Micro Hi-Fi component system.

Synchro Recording

You can easily record a CD onto an MD (see pages 12 and 15).

Automatic Source Selection

You can switch from another source to the MD deck and start playing an MD just by pressing  on the MD deck (see page 6).

Timer

You can wake up to music or record a radio programme at a preset time. For details, refer to “Falling asleep to music” and “Waking up to music” in the CMT-SP55TC Operating Instructions, and “Timer recording radio programmes” on page 20.

Remote Control

You can operate the MD deck using the remote supplied with CMT-SP55TC.

Table of Contents

Getting Started

Hooking up the system	4
-----------------------------	---

Playback

Playing an MD	6
Playing MD tracks in random order	
— Shuffle Play	7
Programming MD tracks	
— Programme Play	8
Playing MD tracks repeatedly	
— Repeat Play	9
Using the MD display	10

Recording

Before you start recording	11
Recording a CD on an MD	
— CD-MD Synchro Recording	12
Recording a tape on an MD	13
Recording your favourite CD tracks on an MD	
— CD-MD Synchro Recording	15
Recording your favourite portions on an MD	
— Manual Recording	16
Recording an MD on a tape	17
Recording from the radio	
— Manual Recording	19
Timer recording radio programmes	20
Making a space between tracks 3 seconds long — Smart Space	22
Starting recording with 6 seconds of prestored audio data	
— Time Machine Recording	23
Marking track numbers	24
Adjusting the recording level	26
Monaural recording	27

Editing

Before you start editing	28
Labelling an MD — Name Function	29
Erasing recordings — Erase Function	31
Moving recorded tracks	
— Move Function	34
Dividing recorded tracks	
— Divide Function	35
Combining recorded tracks	
— Combine Function	37
Undoing the last edit	
— Undo Function	38

Optional Components

Connecting a digital component	39
--------------------------------------	----

Additional Information

Precautions	41
System limitations of MDs	42
Troubleshooting	43
Self-diagnosis Display	44
Messages	45
Specifications	46
Index	Back cover

Hooking up the system

Perform the following procedure **1** to **3** to hook up MDS-SP55 using the supplied cords.

Note

Be sure to hook up the system with the mains lead unplugged from the mains. Hooking up the system with the mains lead plugged in may cause the system to malfunction.

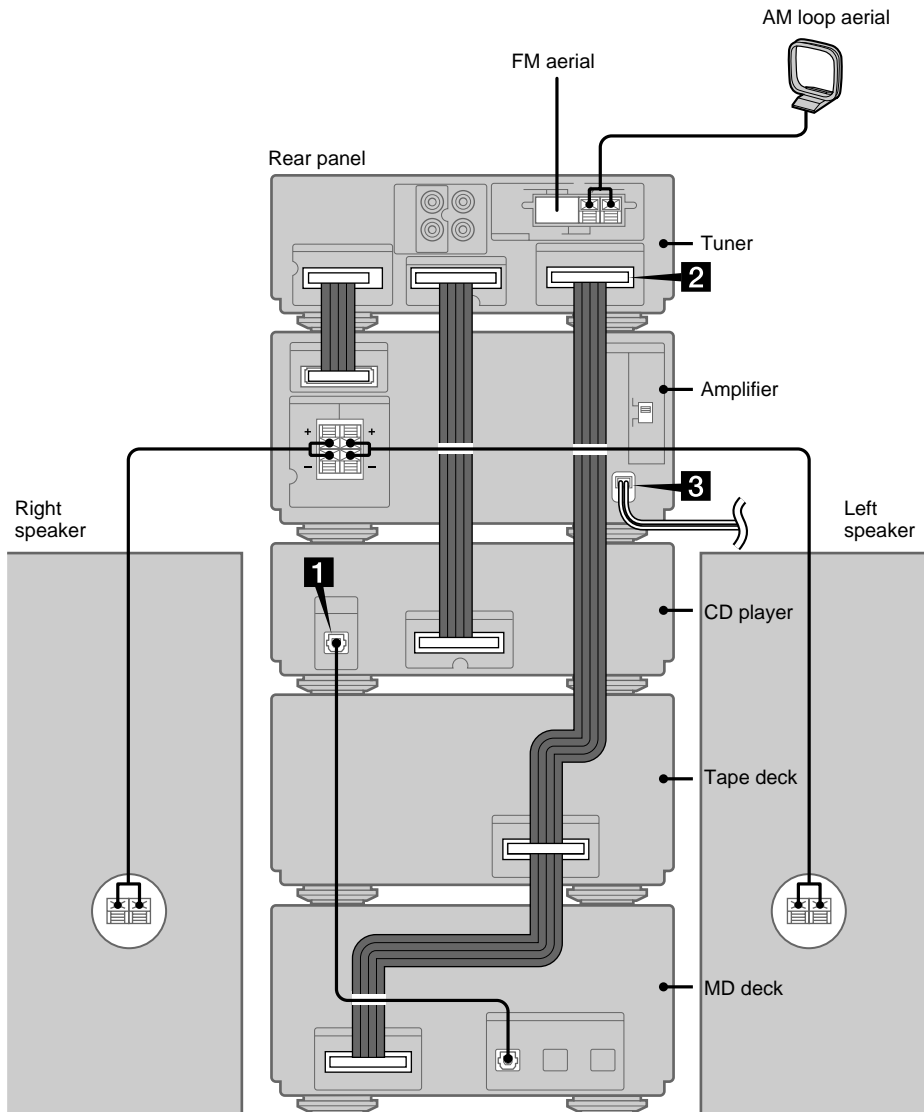

Preparations

- 1 Stack the components vertically in the order of tuner, amplifier, CD player, tape deck and MD deck.
- 2 Disconnect the system cable supplied with CMT-SP55TC from the SYSTEM CONTROL 3 connectors on the tuner and tape deck.

- 1 Connect the supplied digital cable to DIGITAL OPTICAL OUT on the CD player and DIGITAL OPTICAL CD IN 1 on the MD deck.

Take the caps off the connectors, then insert the plugs until they click into place.

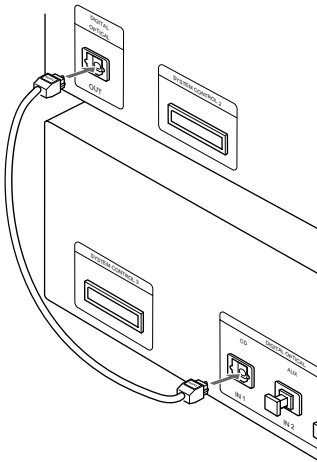

- 2 Connect the SYSTEM CONTROL 3 connectors in the order of the tuner, tape deck and MD deck using the system cable supplied with MDS-SP55.

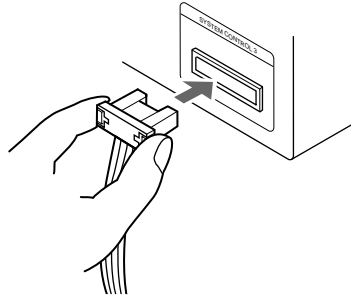

Notes

- The system cable is used to send signals and electricity between the components for interlinked operation. Be sure to insert the connector horizontally until it clicks into place. Otherwise the system will not operate correctly.
- Keep the system cable away from the aerials to prevent noise or malfunction.

- 3 Connect the mains lead to the mains after you complete all the connections.

Arranging the components side by side

Once you have finished the connections, you can rearrange the components as desired.

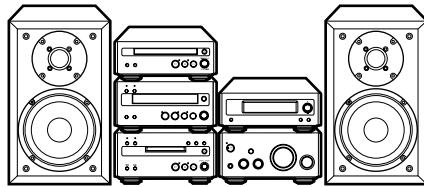

Tip

All information for the MDS-SP55 MD deck appears in the display on the tuner of CMT-SP55TC.

Playing an MD

You can play an MD just like a CD.
To turn on the system, press I/⏻ (power). The MD deck turns on automatically.

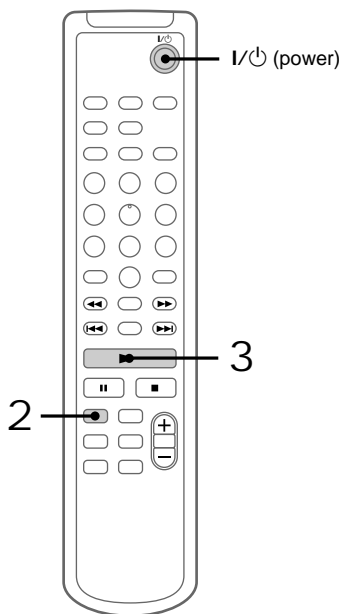

1 Insert an MD.

With the arrow pointing toward the deck.

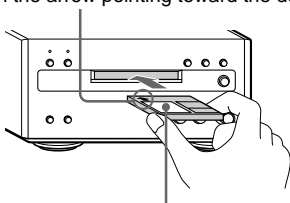

With the label side up, and the shutter on the righthand side.

2 Press MD to switch the function to MD.

3 Press ▶.

Play starts.

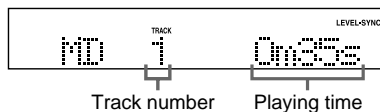

To	Do this
Stop play	Press ■.
Pause	Press . Press again or ▶ to resume play.
Select a track	Press ◀◀ or ▶▶.
Find a point in a track	Keep pressing ◀◀ or ▶▶ during play and release it at the desired point.
Remove the MD	Press ⏻ on the MD deck.
Adjust the volume	Press VOLUME + or -.

Tips

- You can start playing from the desired track in step 3.
 - Press the track number of the track you want to listen to.
 - To select track number 11 and higher**
Press >10 once and then the number buttons of the track number.
For example, to select track 32, press >10, 3, and 2.
 - To select track number 100 and higher**
Press >10 twice and then the number buttons of the track number.
 - Press ▶.
- You can switch from another source to the MD deck and start playing an MD just by pressing ▷ on the MD deck (**Automatic Source Selection**).

Note

Do not use an MD on which the label sticks out from the edge or on which the label is not positioned correctly. Such labels can cause the MD deck to malfunction.

Playing MD tracks in random order — Shuffle Play

You can play all the tracks on an MD in random order.

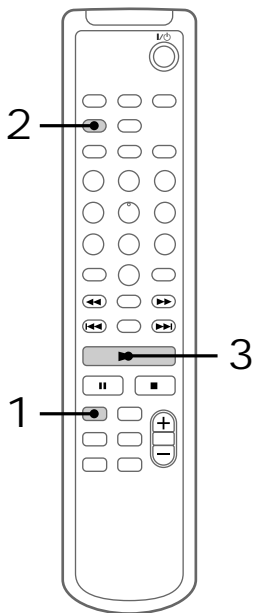

1 Press MD to switch the function to MD.

2 Press PLAY MODE repeatedly until “SHUFFLE” appears in stop mode.



3 Press ►.
Shuffle Play starts.

To cancel Shuffle Play

Press ■ to stop Shuffle Play, then press PLAY MODE repeatedly until “SHUFFLE” and “PROGRAM” disappear.

Tip

To skip a track, press ►►. Press ◀◀ to go back to the beginning of the current track. However, you cannot go back to the previous track.

Programming MD tracks

— Programme Play

You can make a programme of up to 25 tracks in the order you want them to be played.

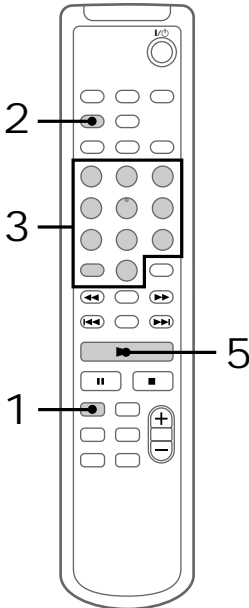

1 Press MD to switch the function to MD.

2 Press PLAY MODE repeatedly until "PROGRAM" appears in stop mode.

3 Press the track number of the track you want to listen to.

To select track number 11 and higher

Press >10 once and then the number buttons of the track number.

For example, to select track 32, press >10, 3, and 2.

To select track number 100 and higher

Press >10 twice and then the number buttons of the track number.

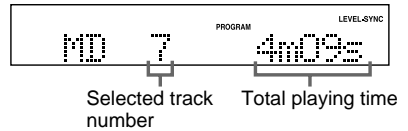

4 To programme additional tracks, repeat step 3.

Each time you programme, the total time of the programme is displayed. You can make a programme of up to 25 tracks.

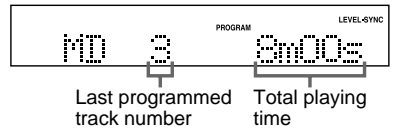

5 Press ►.

All the tracks play in the order you selected.

To	Do this
Cancel Programme Play	Press ■, then press PLAY MODE repeatedly until "PROGRAM" and "SHUFFLE" disappear.
Add a track to the programme (in stop mode)	Do step 3.
Erase the entire programme	Do steps 1 and 2, then press and hold CLEAR.

Tips

- You can select the desired track using ◀◀ or ▶▶ in step 3. Press ◀◀ or ▶▶ repeatedly until the desired track number appears, then press ENTER/YES.
- The programme you made remains after Programme Play finishes. To play the same programme again, press ▶.
- "Program Full!!" appears when you try to programme 26 or more tracks.
- "---m--s" appears when the total MD programme time exceeds 199 minutes.

Playing MD tracks repeatedly — Repeat Play

You can repeat an MD in normal play, Shuffle Play and Programme Play.

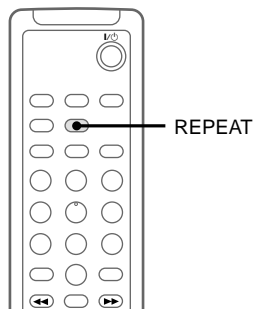

- ➔ Press REPEAT during play until "REPEAT" or "REPEAT 1" appears.

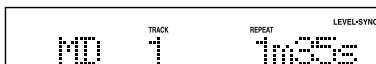

REPEAT: For all the tracks on the MD.

Play mode	Repeat
Normal	All the tracks in order
Shuffle Play (page 7)	All the tracks in random order
Programme Play (page 8)	All the programmed tracks in order

REPEAT 1*: For a single track only.

* You cannot repeat a single track during Shuffle Play or Programme Play.

To cancel Repeat Play

Press REPEAT until "REPEAT" or "REPEAT 1" disappears.

Using the MD display

You can check the total number of tracks, the total playing time and the remaining time on the MD.

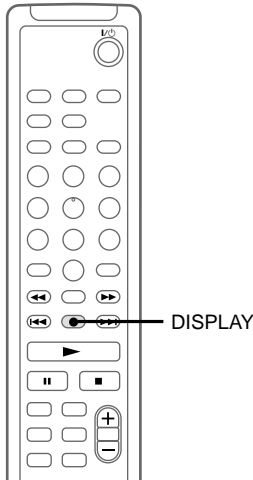

In stop mode

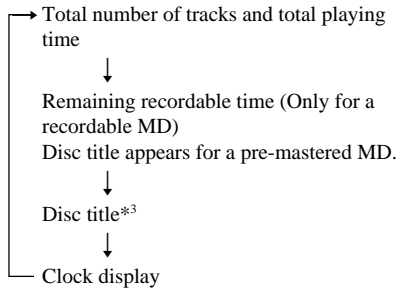

*3 "No Name" appears if no disc title is labelled.

Tips

- You can check a track title during play. If you press SCROLL, a track title appears scrolling in the display. Press SCROLL at any point during the scroll display to stop the scrolling. Press SCROLL again to restart the scrolling.
- To label a disc title or a track title, see "Labelling an MD" on page 29.
- "--m--s" appears when the total playing time exceeds 199 minutes.

➔ Press DISPLAY.

Each time you press the button during normal play or in stop mode, the display changes as follows:

During normal play

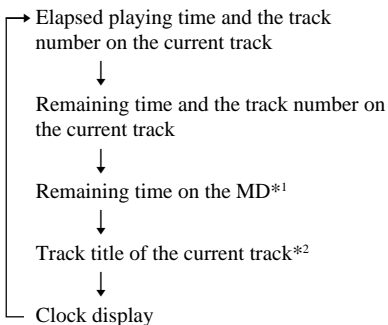

*1 The remaining time of the programme appears during Programme Play.

*2 "No Name" appears if no track title is labelled.

Before you start recording

MDs (MiniDisc) let you digitally record and play music with high quality sound. Another feature of MDs is track marking. The track marking feature lets you quickly locate a specific point or easily edit the recorded tracks. However, depending on the source you record, the recording method and the way the track numbers are recorded differ.

When the source you record from is:

- This system's CD player (CMT-SP55TC)
 - The MD deck performs digital recording.*¹
 - Track numbers are automatically marked as on the original CD.
- Other digital components connected to the DIGITAL OPTICAL AUX IN jack of MDS-SP55 (e.g., a DVD player)
 - The MD deck performs digital recording.*¹*²*³
 - Track numbers are marked differently depending on the source you record.
- This system's tuner or tape deck, or other analogue components connected to the AUX IN jacks of CMT-SP55TC (e.g., a VCR)
 - The MD deck performs analogue recording.
 - A track number is marked at the beginning of a recording, but when you turn on the Level Synchro Recording function (see page 24), track numbers are automatically marked in sync with the level of the input signal.

*¹ For details on the limitations of digital recording, see page 42.

*² The sound produced from the speakers during recording is the AUX IN jacks audio. When making a digital connection, be sure to also make an analogue connection.

*³ If a digital component is not connected to the DIGITAL OPTICAL AUX IN jack using an optical cable, the MD deck performs analogue recording.

Note on MD track numbers

On an MD, the track numbers (track sequence), track start and end point information, etc., are recorded in the TOC*⁴ area independent of the sound information. You can edit recorded tracks quickly by modifying the TOC information.

*⁴ TOC: Table Of Contents

After recording

- ➔ Press \triangle on the MD deck to remove the MD or press I/⏻ (power) to turn off the system.

“TOC” lights up or starts flashing. The TOC is updated and recording is completed.

Before pulling out the mains lead

MD recording is completed when the MD Table of Contents (TOC) is updated. The TOC is updated when you eject the MD or press I/⏻ to turn off the system. Do not pull out the mains lead before updating the TOC (while “TOC” is lit) or while updating the TOC (while “TOC” is flashing) to ensure a complete recording.

Protecting a recorded MD

- To protect a recorded MD, slide the tab on the side of the MD to open the slot. In this position, the MD cannot be recorded. To record on the MD, slide the tab to close the slot.

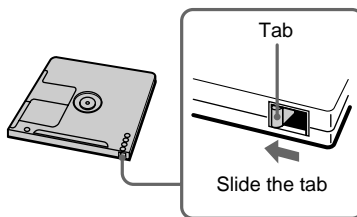

- If the MD is record protected, “C11” and “Protected” appear alternately and the MD cannot be recorded. Remove the MD, then slide the record protection tab to the closed position.

Recording a CD on an MD — CD-MD Synchro Recording

You can make a digital recording of a CD on an MD, marking track numbers in the same sequence as the original CD.

You can also record a programme of favourite tracks (see page 15).

To turn on the system, press I/⏻ (power). The MD deck turns on automatically.

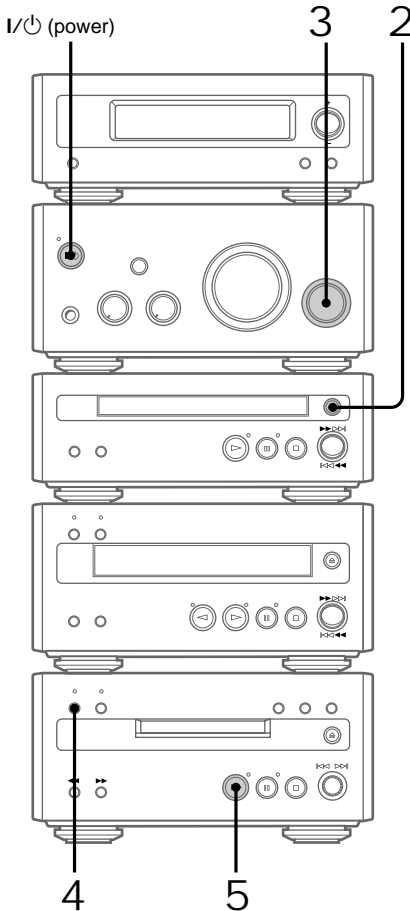

- 1 Insert a recordable MD.

With the arrow pointing toward the deck.

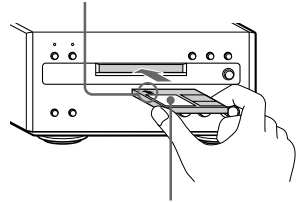

With the label side up, and the shutter on the righthand side.

- 2 Press on the CD player and place a CD on the disc tray.

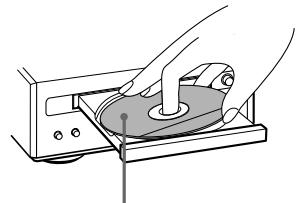

With the label side up. When you play a CD single (8 cm CD), place it on the inner circle of the tray.

Press again to close the disc tray.

- 3 Turn FUNCTION until “CD” appears.

- 4 Press CD SYNC REC on the MD deck. The CD SYNC REC indicator lights up. The MD deck stands by for recording and the CD player pauses for play.

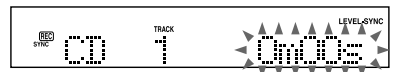

- 5 Press \triangleright on the MD deck.
Recording starts.
When the recording is completed, the CD player and the MD deck stop automatically.

To	Do this
Stop recording	Press \square on the MD deck or CD player.
Remove the MD and CD	Press \triangle on the MD deck and CD player in stop mode.

Tips

- If you use a partially recorded MD, recording starts after the recorded tracks. To erase the recorded contents, see “Erasing recordings” on page 31.
- Depending on the disc, CD TEXT information may also be recorded. If “CD-TEXT” flashes during recording, press NAME EDIT on the remote, and then press ENTER/YES to record the title of the current track. (If “CD-TEXT” is lit, it is automatically recorded.)

Note

If the MD is record protected, “C11” and “Protected” appear alternately and the MD cannot be recorded. Remove the MD, then slide the record protection tab to the closed position (see page 11).

Recording a tape on an MD

You can make an analogue recording of a tape on an MD. You can use TYPE I (normal), TYPE II (CrO₂) tape. The recording level is automatically adjusted.

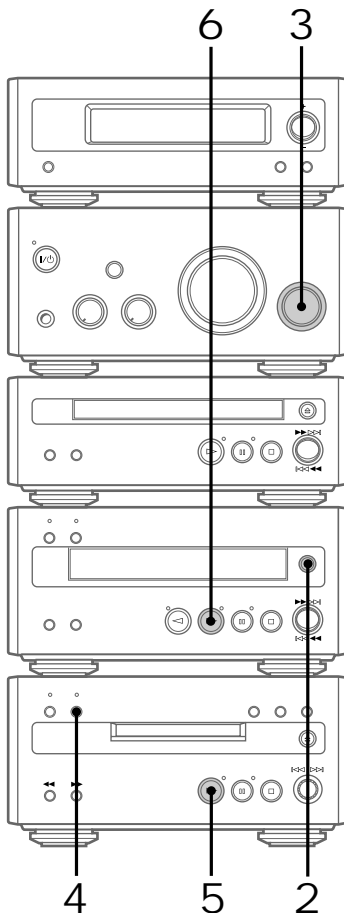

continued

Recording a tape on an MD (continued)

1 Insert a recordable MD.

With the arrow pointing toward the deck.

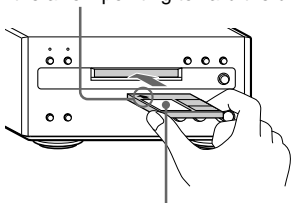

With the label side up, and the shutter on the righthand side.

2 Press on the tape deck to open the cassette tray and insert a tape.

With the side you want to play facing up

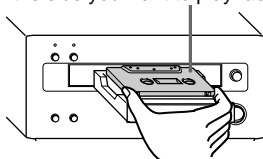

Press  again to close the cassette tray.

3 Turn FUNCTION until "TAPE" appears.

4 Press REC on the MD deck.

The MD deck stands by for recording.

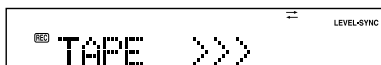

Tape playback side

>>> appears for the front side, and <<< for the reverse side. To play the side not indicated, press  on the tape deck and remove the tape to reverse the tape side, then do steps 3 and 4 again.

5 Press on the MD deck. Recording starts.

6 Press on the tape deck.

To stop recording

Press  on the MD deck.

Tips

- If you use a partially recorded MD, recording starts after the recorded tracks. To erase the recorded contents, see "Erasing recordings" on page 31.
- If the Smart Space function is on and there is no sound input for about 3 seconds or more (but less than 30 seconds) while recording, the MD deck replaces this silence with a blank of about 3 seconds and continues recording. However, this function may not activate if there is noise.

Note

If the MD is record protected, "C11" and "Protected" appear alternately and the MD cannot be recorded. Remove the MD, then slide the record protection tab to the closed position (see page 11).

Recording your favourite CD tracks on an MD

— CD-MD Synchro Recording

You can select your favourite CD tracks with the Programme Play feature, then record the programme on an MD using the Synchro Recording feature. If you use a partially recorded MD, recording starts after the recorded tracks.

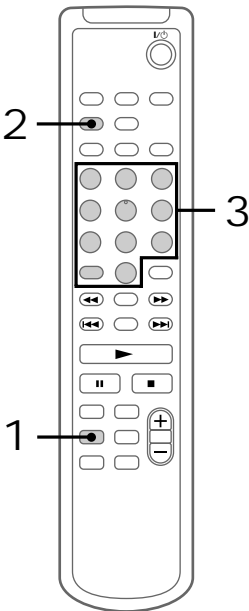
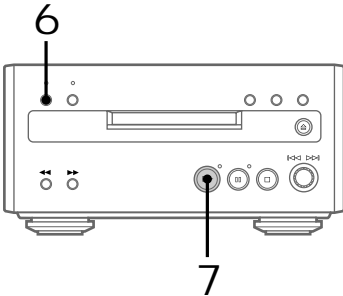

Selecting the tracks

- 1 Press CD on the remote to switch the function to CD.
Place a CD.
- 2 Press PLAY MODE on the remote repeatedly until "PROGRAM" appears.
- 3 Press the track number of the track you want to record.

To select track number 11 and higher

Press >10 once and then the number buttons of the track number.

For example, to select track 32, press >10, 3, and 2.

- 4 To programme additional tracks, repeat step 3.

Each time you programme, the total time of the programme is displayed. You can make a programme of up to 25 tracks.

Recording on an MD

- 5 Insert a recordable MD.
- 6 Press CD SYNC REC on the MD deck.
The MD deck stands by for recording and the CD player pauses for play.
- 7 Press ▷ on the MD deck.
CD play and MD recording start.
When the recording is completed, the CD player and the MD deck stop automatically.

continued

Recording your favourite CD tracks on an MD (continued)

To stop recording

Press \square on the MD deck.

If the MD becomes full during recording

The MD deck and the CD player automatically stop.

Note

If the MD is record protected, "C11" and "Protected" appear alternately and the MD cannot be recorded. Remove the MD, then slide the record protection tab to the closed position (see page 11).

Labelling titles during recording

If "CD-TEXT" lights up or flashes during recording, you can record the CD TEXT information onto the MD as follows:

- Automatically during recording
If you record on an unrecorded or completely erased (see page 32) MD when "CD-TEXT" is lit, the CD TEXT information is automatically recorded.
- Manually during recording
When "CD-TEXT" flashes, press NAME EDIT on the remote, and then press ENTER/YES to record the title of the current track.

Note

Depending on the disc, the CD TEXT information may not be recorded automatically.

Recording your favourite portions on an MD

— Manual Recording

With manual recording, you can record just the portions you like from a CD, or start recording from the middle of the tape. If you use a partially recorded MD, recording starts after the recorded tracks.

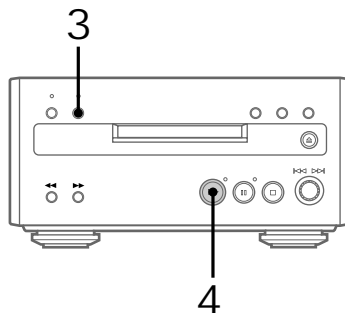

- 1 Insert a recordable MD.
- 2 Turn FUNCTION on the amplifier until "CD" or "TAPE" appear.
 - CD: Recording from the CD
 - TAPE: Recording from the tape
- 3 Press \bullet REC on the MD deck.
The MD deck stands by for recording.
- 4 Press \triangleright on the MD deck.
Recording starts.
- 5 Press \triangleright on the CD player or \triangleright or \triangleleft on the tape deck.

To stop recording

Press \square on the MD deck.

Tips

- If you turn FUNCTION during recording, the MD deck and the CD player automatically stop.
- You can check the remaining recordable time on the MD during recording by pressing DISPLAY.

Note

If the MD is record protected, "C11" and "Protected" appear alternately and the MD cannot be recorded. Remove the MD, then slide the record protection tab to the closed position (see page 11).

Recording an MD on a tape

You can make an analogue recording of an MD on a tape with the tracks in the same sequence as the original MD.

You can also record a programme of favourite tracks.

Recording tracks in the same sequence as the original MD

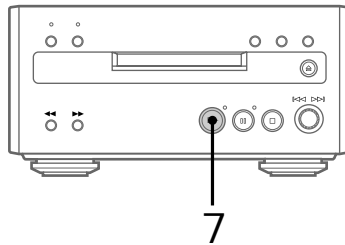

- 1 Insert a blank tape.
- 2 Insert an MD.
- 3 Turn FUNCTION on the amplifier until "MD" appears.
- 4 Press ● REC on the tape deck.
The tape deck stands by for recording.
- 5 Press ▷ on the tape deck to record starting from the front side.
To record from the reverse side, press < on the tape deck.

continued

Recording an MD on a tape (continued)

- 6 Press **DIRECTION** on the tape deck repeatedly until \rightleftarrows appears to record on one side or \rightarrow (or \leftarrow) to record on both sides.

If you select both sides recording and the tape reaches the end of the front side part-way through a track, the entire track is recorded again from the beginning of the reverse side. When you start recording from the reverse side, the recording stops at the end of the reverse side even though you select \rightarrow .

- 7 Press \square on the tape deck.
Recording starts.

- 8 Press \blacktriangleright on the MD deck.
MD play starts.
When the recording is completed, the MD deck stops.

To stop recording

Press \square on the tape deck.

Tip

When you want to reduce the hiss noise in high-frequency signals recorded at low level, press **DOLBY NR** after step 6 so "DOLBY NR" appears in the display. Turning **DOLBY NR** on reduces the noise when playing back these types of signals.

Recording your favourite MD tracks

You can select your favourite MD tracks with the Programme Play feature, then record the programme on a tape.

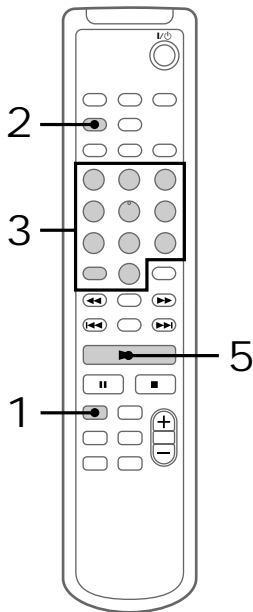

- 1 Press **MD** to switch the function to MD.
- 2 Press **PLAY MODE** repeatedly until "PROGRAM" appears in stop mode.

- 3 Press the track number of the track you want to record.

To select track number 11 and higher

Press >10 once and then the number buttons of the track number.

For example, to select track 32, press >10, 3, and 2.

To select track number 100 and higher

Press >10 twice and then the number buttons of the track number.

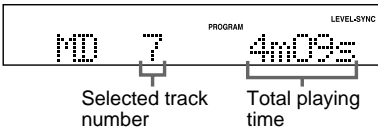

- 4 To programme additional tracks, repeat step 3.

Each time you programme, the total time of the programme is displayed. You can make a programme of up to 25 tracks.

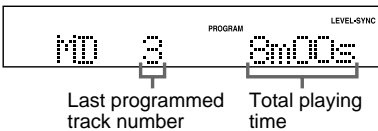

- 5 Insert a blank tape.

- 6 Do steps 3 to 7 of "Recording tracks in the same sequence as the original MD" (see page 17).

Recording from the radio — Manual Recording

You can make an analogue recording a radio programme on an MD.

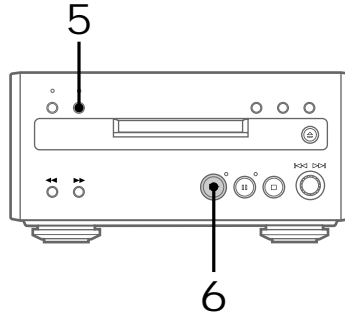

- 1 Insert a recordable MD.
- 2 Press TUNER/BAND on the tuner repeatedly to select "AM" or "FM".
- 3 Press TUNING MODE on the tuner repeatedly until "PRESET" appears.
- 4 Press TUNING + or - on the tuner to select the desired preset station.



Preset number and frequency (or station name* or RDS station name)

* The station name appears only if you have labelled the station (refer to the CMT-SP55TC Operating Instructions).

continued

Recording from the radio (continued)

- 5 Press ● REC on the MD deck.
The ● REC indicator lights up.
The MD deck stands by for recording.

- 6 Press ▷ on the MD deck.
Recording starts.

To	Do this
Stop recording	Press □ on the MD deck.
Pause	Press ⏸ on the MD deck. Press ⏸ again or ▷ on the MD deck to restart recording.
Remove the MD	Press ⏏ on the MD deck in stop mode.

Tips

- If you use a partially recorded MD, recording starts after the recorded tracks. To erase the recorded contents, see “Erasing recordings” on page 31.
- If noise is heard while recording an AM radio programme, move the AM loop aerial to reduce the noise or connect a ground wire to the ⚡ terminal (refer to the CMT-SP55TC Operating Instructions).

Note

If the MD is record protected, “C11” and “Protected” appear alternately and the MD cannot be recorded. Remove the MD, then slide the record protection tab to the closed position (see page 11).

Timer recording radio programmes

To timer record, you must first preset the radio station and set the clock (refer to the CMT-SP55TC Operating Instructions). You can make a timer recording of a radio programme or the audio signal from a digital component connected to AUX IN (see page 39).

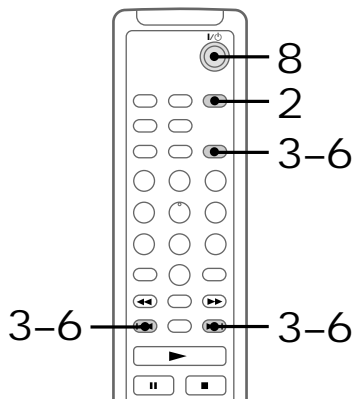

- 1 Prepare the sound source you want to play.
 - Radio: Tune in the preset radio station (refer to the CMT-SP55TC Operating Instructions).
 - AUX: Set the timer of the component connected to DIGITAL OPTICAL AUX IN. For details, refer to the operating instructions of the connected component.
- 2 Press CLOCK/TIMER SET.
- 3 Press ◀◀ or ▶▶ repeatedly until “SET MD REC” appears, then press ENTER/YES.
The hour indication flashes.

- 4 Set the time to start recording.
Press **◀◀** or **▶▶** repeatedly to set the hour, then press **ENTER/YES**.
The minute indication flashes.



Press **◀◀** or **▶▶** repeatedly to set the minute, then press **ENTER/YES**.
The hour indication flashes again.

- 5 Set the time to stop recording following the procedure in step 4.
“OFF TIME NG” appears if the start time and the stop time settings are the same.
Change the stop time.

- 6 Press **◀◀** or **▶▶** repeatedly to select the recording source, then press **ENTER/YES**.

The indication changes as follows:

When recording on an MD

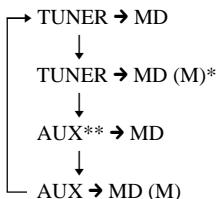

* When you record onto an MD in monaural format.

** You can select the connected component for recording source. Set the timer on both systems to the same time.

When you press **ENTER/YES**, the start time, stop time and other setting contents appear in turn, then the original display returns.

“REC” lights up.

- 7 Insert a recordable MD.
If you use a partially recorded MD, recording starts after the recorded tracks.

- 8 Press **I/⏻** to turn off the system.

To cancel the procedure

Press **CLOCK/TIMER SET**.

To change the setting

Start over from step 1.

To check the setting/activate the timer

Press **CLOCK/TIMER SELECT** and press **◀◀** or **▶▶** repeatedly until “SEL MD REC” appears. Then press **ENTER/YES**.

It is not necessary to set the start and stop times every time.

To cancel the timer

Press **CLOCK/TIMER SELECT** and press **◀◀** or **▶▶** repeatedly until “TIMER OFF” appears. Then press **ENTER/YES**.

Tips

- The system automatically turns on about 30 seconds before the start time and prepares for timer-recording. Recording starts as soon as the system is ready, so recording may start earlier than the preset time.
- When you record from the radio, the station name (or frequency when the station is not labelled), the start time and the stop time are automatically recorded on the MD.

Notes

- You cannot activate Daily Timer and the recording timer at the same time.
- Do not operate the system from the time the system turns on until the recording starts (about 30 seconds before the preset time).
- If the system is on about 30 seconds before the preset time, the timer-recording will not be activated.
- The Smart Space and Level Synchro Recording functions do not operate.
- The volume is reduced to minimum during recording.

Making a space between tracks 3 seconds long — Smart Space

The Smart Space function lets you make the blank spaces between tracks 3 seconds long automatically while making a digital recording from a CD. For other types of recording, if the Smart Space function is on and there is no sound input for about 3 seconds or more (but less than 30 seconds) while recording, the MD deck replaces this silence with a blank of about 3 seconds and continues recording.

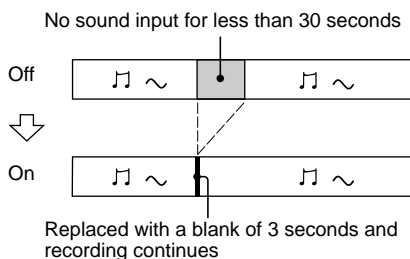

Auto Cut: When the Smart Space function is on, if there is no sound input for 30 seconds or more, the MD deck replaces this silence with a blank of about 3 seconds and enters recording pause.

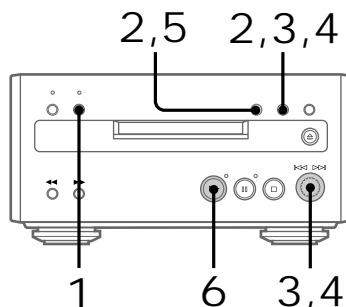
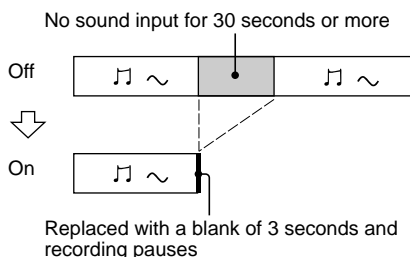

- 1 Press ● REC on the MD deck to stand by for recording.
- 2 Press MENU/NO to display “MD Setup ?”, then press ENTER/YES.
- 3 Turn ◀◀/▶▶ until “MD S.Space OFF” (or “MD S.Space ON”) appears, then press ENTER/YES.
- 4 Turn ◀◀/▶▶ until “MD S.Space ON” appears, then press ENTER/YES.
- 5 Press MENU/NO.
- 6 Press ▷ on the MD deck.
Recording starts.
If there is an extended silence of less than 30 seconds, “Smart Space” appears, and the MD deck replaces the silence with a blank of about 3 seconds and continues recording.
If there is no sound input for 30 seconds or more, “Auto Cut” appears, and the MD deck replaces the silence with a blank of about 3 seconds and switches to recording pause. Press ▷ to restart the recording.

To stop recording

Press \square on the MD deck.

To turn off Smart Space and Auto Cut functions

- 1 Press MENU/NO during recording pause. "MD Setup ?" appears, then press ENTER/YES.
- 2 Turn \lll/\ggg until "MD S.Space ON" appears, then press ENTER/YES.
- 3 Turn \lll/\ggg until "MD S.Space OFF" appears, then press ENTER/YES.
- 4 Press MENU/NO.

Tips

- The Smart Space and Auto Cut functions are factory set to on.
- If you turn off the system or disconnect the mains lead, the MD deck will retain the last setting (MD S.Space ON or OFF).

Starting recording with 6 seconds of prestored audio data

— Time Machine Recording

When recording from an FM or satellite broadcast, the first few seconds of material are often lost due to the time it takes you to ascertain the contents and press the record button. To prevent the loss of this material, the Time Machine Recording feature constantly stores the most recent audio data in a buffer memory. This lets you record the sound from 6 seconds (12 seconds for monaural recording) before starting recording, as shown in the illustration below:

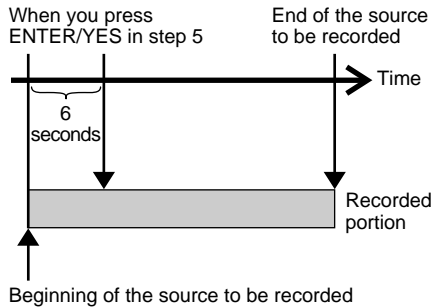

continued

Starting recording with 6 seconds of prestored audio data (continued)

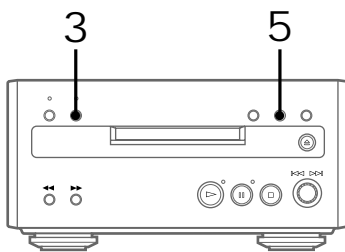

- 1 Insert a recordable MD.
- 2 Turn FUNCTION on the amplifier until the desired sound source (i.e., TUNER) to record appears.
- 3 Press ● REC on the MD deck.
The MD deck stands by for recording.
- 4 Start playing the desired sound source to record.
- 5 Press ENTER/YES at the desired point to start recording.
Recording of the sound source starts with the 6 seconds of audio data stored in the buffer memory.
If you use a partially recorded MD, recording starts after the recorded tracks.

To stop Time Machine Recording

Press □ on the MD deck.

Note

The MD deck starts storing audio data when the deck stands by for recording in step 3 and you start playing the source. If less than 6 seconds have passed when you press ENTER/YES, Time Machine Recording starts with less than 6 seconds of audio data.

Marking track numbers

You can mark track numbers as follows:

• Automatically during recording

Track numbers are automatically marked as on the original source during recording from this system's CD player (CMT-SP55TC) or components connected to the DIGITAL OPTICAL AUX IN jack. Use the Level Synchro Recording function to automatically mark track numbers during recording from this system's tuner, tape deck or components connected to the AUX IN jacks.

• At any point during recording

You can mark track numbers while recording any sources.

• After recording

Use the Divide function (see page 35).

Marking track numbers automatically during recording — Level-Synchro Recording

The Level Synchro Recording function is factory set to on, so the track numbers are automatically marked. If "LEVEL-SYNC" does not appear during recording, turn on the Level Synchro Recording as follows. Track numbers are automatically marked when the input signal is continuously below a certain level for more than two seconds and then exceeds that level.

Note

You can not mark track numbers automatically if the sound source to be recorded is noisy.

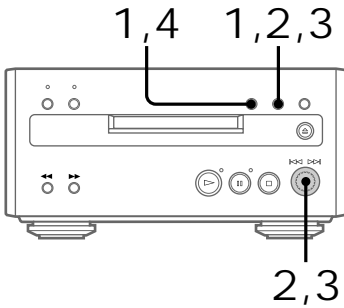

- 1 Press MENU/NO during recording pause to display “MD Setup ?”, then press ENTER/YES.
- 2 Turn \lll / \ggg until “MD T.Mark Off” (or “MD T.Mark LSync”) appears, then press ENTER/YES.
- 3 Turn \lll / \ggg until “MD T.Mark LSync” appears, then press ENTER/YES.
“LEVEL-SYNC” lights up.
- 4 Press MENU/NO.

Cancelling automatic track marking

- 1 Press MENU/NO during recording pause. “MD Setup ?” appears, then press ENTER/YES.
 - 2 Turn \lll / \ggg until “MD T.Mark LSync” appears, then press ENTER/YES.
 - 3 Turn \lll / \ggg until “MD T.Mark Off” appears, then press ENTER/YES.
“LEVEL-SYNC” disappears.
 - 4 Press MENU/NO.
- When “LEVEL-SYNC” is off, a track number is marked only at the beginning of each recording.

Marking track numbers at a specific point during recording — Track Mark

You can mark track numbers at any time during recording, regardless of the type of sound source.

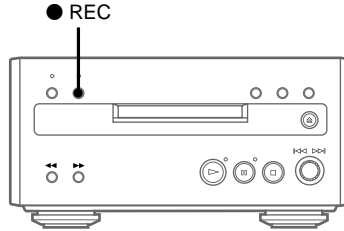

- ➔ Press ● REC on the MD deck during recording at the point you want to add a track mark.
The tracks following the added one are renumbered.

Adjusting the recording level

When recording on an MD, you can adjust the recording level to the desired volume. You can adjust the recording level not only when making an analogue recording, but also when making a digital recording from a CD, etc. Once adjusted, the recording level is maintained until you adjust it again.

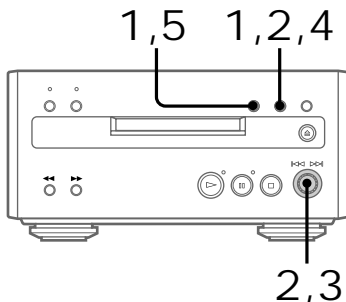

- 1 Press MENU/NO during recording pause to display “MD Setup ?”, then press ENTER/YES.
- 2 Turn \lll/\ggg until “Level Adjust” appears, then press ENTER/YES.
- 3 Turn \lll/\ggg to adjust the recording level.

The sound source and recording level are displayed. The recording level can be adjusted from -12 to +12. While monitoring the sound, adjust to the optimum level while making sure that “OVER” does not appear in the display at the loudest portion.



Adjust the level so that “OVER” does not appear

4 Press ENTER/YES.

5 Press MENU/NO.

Notes

- If you adjust the recording level during recording such as part-way through a track, the recorded volume changes at the point where the adjustment was performed.
- If “OVER” appears in the display when the recording level is between -12 and 0, change the audio input level and reduce the input sound.

Monaural recording

Stereo signals such as an FM stereo broadcast can be converted to monaural format and recorded. When recording in monaural format, the MD recording time is approximately twice the normal recording (stereo recording) time (i.e., 120 minutes of monaural audio can be recorded on a 60-minute MD).

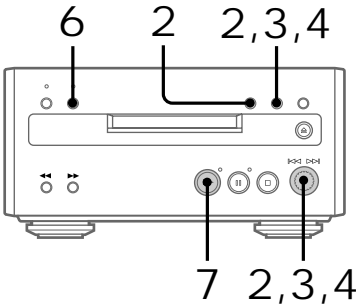

- 1 Turn **FUNCTION** on the amplifier until “MD” appears.
- 2 Press **MENU/NO** in stop mode to display “MD Edit Menu”, and turn **⏪/⏩** until “MD Setup ?” appears. Then press **ENTER/YES**.
- 3 Turn **⏪/⏩** until “MD Stereo Rec” (or “MD Mono Rec”) appears, then press **ENTER/YES**.
- 4 Turn **⏪/⏩** until “MD Mono Rec” appears, then press **ENTER/YES**. “MONO” lights up.
- 5 Turn **FUNCTION** to select the desired sound source (e.g., **TUNER**) to record.

- 6 Press **● REC** on the MD deck.
The MD deck stands by for recording.

- 7 Press **▷** on the MD deck.
Recording starts.
The sound source is heard as is (e.g., stereo sound when recording a stereo broadcast) from the speakers.

To stop recording
Press **□** on the MD deck.

To return to stereo recording

- 1 Press **MENU/NO** in stop mode.
Turn **⏪/⏩** until “MD Setup ?” appears, then press **ENTER/YES**.
- 2 Turn **⏪/⏩** until “MD Mono Rec” appears, then press **ENTER/YES**.
- 3 Turn **⏪/⏩** until “MD Stereo Rec” appears, then press **ENTER/YES**.
The system switches back to stereo recording, and “MONO” lights off.
- 4 Press **MENU/NO**.

Tip

The meaning of “MONO” on the left in the display changes as follows according to the MD playback or recording mode.

While the MD is in stop mode, during recording or recording pause, or while ejecting the MD
→ Indicates that monaural recording is set.

During MD play or playing pause or while selecting a track

→ Indicates that the track being played back or the selected track is recorded in monaural format.

Before you start editing

You can edit the recorded tracks on an MD. By using the editing functions, you can create a new sequence to the recorded MD.

Editing functions

- **Name — Labelling MDs (page 29)**
Use this function to label discs and tracks. You can use upper case, lower case, numbers, and symbols for the titles.
- **Erase — Erasing recordings (page 31)**
Use this function to erase a single track one by one, all the tracks at once, or a portion of a track.
- **Move — Changing the order of tracks (page 34)**
Use this function to change the track numbering.
- **Divide — Adding track numbers (page 35)**
Use this function to add track numbers. This lets you locate your favourite phrases quickly.
- **Combine — Combining recorded tracks (page 37)**
By using this function, two tracks are combined to a single track. You can combine the tracks which are not numerically consecutive, i.e. the track 1 and track 4, etc.
- **Undo — Cancelling the last edit (page 38)**
Use this function to cancel the last edit and restore the contents of the MD to the condition before the edit.

Before editing



You can edit an MD only when:

- The MD is recordable.
- The MD play mode is normal play.

Check the following, before editing.

- 1 Check the tab of the MD to be edited.
If the MD is protected, “C11” and “Protected” appear alternately and the MD cannot be edited.
Slide the tab to close the slot.
- 2 Press PLAY MODE repeatedly in stop mode until both “PROGRAM” and “SHUFFLE” disappear.
You can edit the MD only in normal play mode. You cannot edit the MD in Shuffle or Programme Play mode.

After editing

- ➔ Press  on the MD deck to remove the MD or press  (power) to turn off the system.
“TOC” lights up or starts flashing. The TOC is updated and editing is completed.

Before pulling out the mains lead MD editing is completed when the MD Table of Contents (TOC) is updated. The TOC is updated when you eject the MD or press  to turn off the system. Do not pull out the mains lead before updating the TOC (while “TOC” is lit) or while updating the TOC (while “TOC” is flashing) to ensure a complete editing.

Labelling an MD

— Name Function

You can create titles for your recorded MDs and tracks as follows.

During recording

If "CD-TEXT" flashes in the display during recording a CD, you can record the CD disc title on the MD (see page 16).

After recording

Use the Name function on this page. You can input a total of approximately 1700 characters for the disc title and track titles on a single MD.

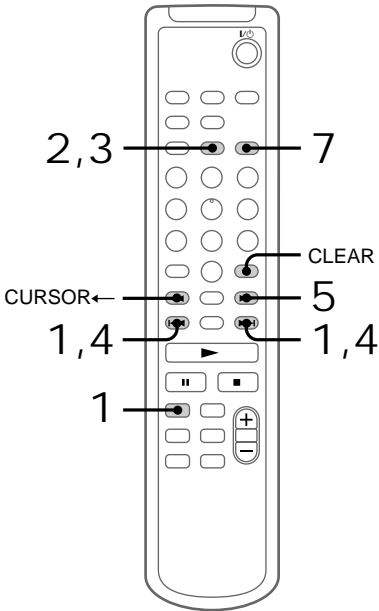

1 Press MD to switch the function to MD. To label a track, press ◀◀ or ▶▶ until the desired track number appears.

2 Press NAME EDIT. The text input screen appears, and the cursor flashes.

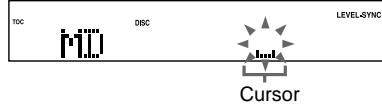

3 Press CHARACTER to select the desired type of character.

Each time you press the button, the display changes as follows:

A (Upper cases) → a (Lower cases) →
0 (Numbers) → ! (Symbols) → [(Blank space) → A (Upper cases) → ...

4 Press ◀◀ or ▶▶ repeatedly to select the desired character.

To enter a blank space

Go to step 5 without pressing ◀◀ or ▶▶. You cannot enter a space as the first character.

To enter a symbol

You can use the following 24 symbols.

!"#\$%&'()*+,-./:;<=>?@_`

5 Press CURSOR→.

The character you selected in step 4 stops flashing and the cursor shifts to the right.

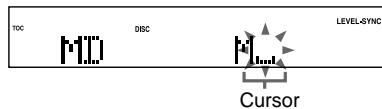

continued

-
- 6** Repeat steps 3 to 5 to complete the entire title.

If you made a mistake

Press CURSOR← or → until the character you want to change flashes, then repeat steps 3 to 5.

To erase a character

Press CURSOR← or → until the character you want to erase flashes, then press CLEAR.

-
- 7** Press ENTER/YES to complete the labelling procedure.

The titles you labelled appear sequentially.

To cancel labelling

Press MENU/NO before completing the procedure.

Tip

You can label a track title during play. The playing repeats until you finish labelling.

Note

If the MD is record protected, “C11” and “Protected” appear alternately and the MD cannot be edited. Remove the MD, then slide the record protection tab to the closed position (see page 11).

Checking the titles

To check the disc titles, press SCROLL in stop mode. To check the track title, press SCROLL during play.

The title appears scrolling in the display. To stop scrolling, press SCROLL. Press the button again to resume scrolling.

Erasing the titles

To erase the disc titles and all track titles at once

- 1 Press MENU/NO in stop mode.
- 2 Press ◀◀ or ▶▶ repeatedly until “MD Name ?” appears, then press ENTER/YES.
- 3 Press ◀◀ or ▶▶ repeatedly until “MD Nm Erase?” appears.
- 4 Press ◀◀ or ▶▶ repeatedly until “MD Nm All Ers?” appears, then press ENTER/YES. “MD Nm All Ers??” appears.
- 5 Press ENTER/YES. “MD Complete!!” appears, and the disc title and all track titles are erased.

To erase a disc title or a track title

Do steps 1 to 3 of “To erase the disc titles and all track titles at once”.

While “MD Nm Erase?” is displayed, press ENTER/YES so that “MD Nm Ers Disc” appears. Press ◀◀ or ▶▶ repeatedly until the disc title or the track number with the title you want to erase appears, then press ENTER/YES.

“MD Complete!!” appears, and the disc title or the track title is erased.

To cancel erasing

Press MENU/NO before completing the procedure.

To return to the condition before labelling or erasing

You can return to the original condition immediately after labelling or erasing a title by using the Undo function (see page 38).

Erasing recordings

— Erase Function

The MD deck lets you erase unwanted tracks quickly and easily. You can restore the contents to the condition before erasing (unerase) by using the Undo function. Note, however, you cannot undo an edit after performing any additional edits.

The three options for erasing recordings are:

- Erasing a single track (Track Erase function)
- Erasing all tracks (All Erase function)
- Erasing a portion of a track (A-B Erase function)

Erasing a single track

— Track Erase function

You can erase a track simply by selecting its track number. When you erase a track, the total number of tracks on the MD decreases by one and all the tracks following the erased one are renumbered.

Example: Erasing track 2.

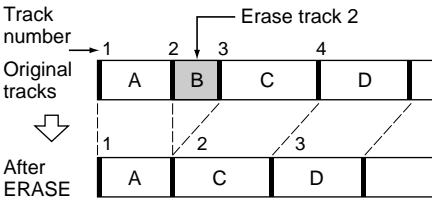

When erasing multiple tracks, you should proceed in order from high to low track number to prevent the renumbering of tracks that have not been erased yet.

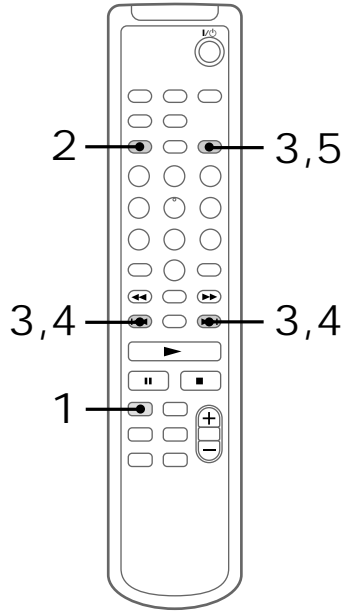

1 Press MD to switch the function to MD.

2 Press MENU/NO to display “MD Edit Menu”.

3 Press **◀◀** or **▶▶** repeatedly until “MD Tr Erase ?” appears, then press ENTER/YES.

4 Press **◀◀** or **▶▶** repeatedly until the desired track number appears.



5 Press ENTER/YES.

“MD Complete!!” appears for a few seconds and the selected track and title are erased.

continued

Erasing recordings (continued)

To cancel Track Erase

Press MENU/NO before completing the procedure.

To return to the condition before Track Erase

You can return to the original condition immediately after erasing the track by using the Undo function (see page 38).

Note

“Erase???” appears when the track was recorded or edited on another deck and is protected. To erase the track, press ENTER/YES while “Erase???” appears.

Erasing all tracks — All Erase function

You can erase the disc title, all recorded tracks and their titles at once.

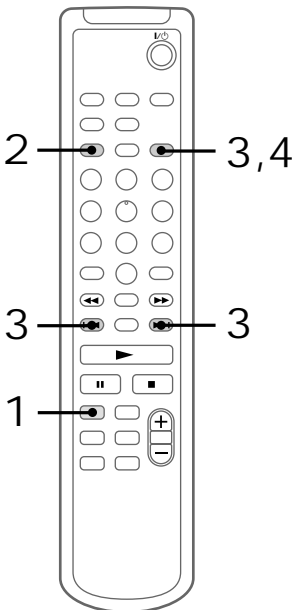

- 1 Press MD to switch the function to MD.
- 2 Press MENU/NO to display “MD Edit Menu”.
- 3 Press ◀◀ or ▶▶ repeatedly until “MD All Erase ?” appears, then press ENTER/YES.
“MD All Erase ?” appears.
- 4 Press ENTER/YES again.
“MD Complete!!” appears for a few seconds and the disc title, all recorded tracks and their titles are erased.

To cancel All Erase

Press MENU/NO before completing the procedure.

To return to the condition before All Erase

You can return to the original condition immediately after erasing the tracks by using the Undo function (see page 38).

Erasing a portion of a track

— A-B Erase function

You can specify a portion within a track and erase the portion with ease. You can shift the desired portion by frame*, minute or second intervals. This function is convenient when erasing unnecessary sections after recording a satellite broadcast or FM broadcast.

* 1 frame is 1/86 second.

Example: Erasing a portion of track 2.

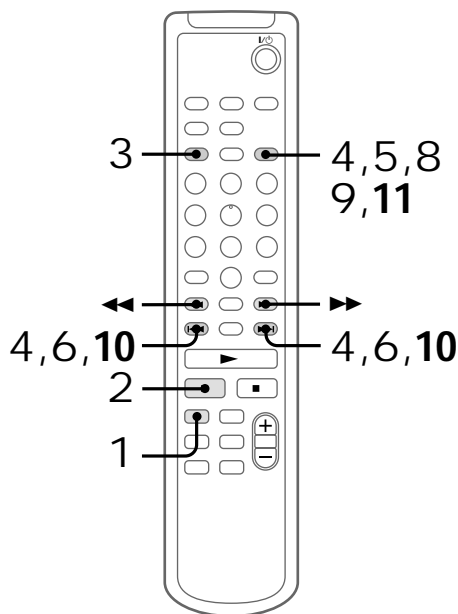
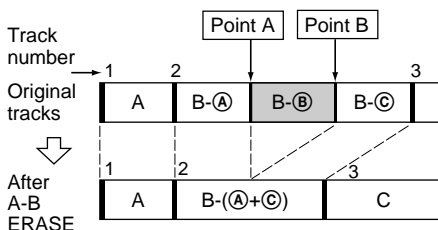

- 1 Press MD to switch the function to MD.

- 2 While playing an MD, press **II** at the starting point of the portion to be erased (point A).
The MD deck pauses for play.

- 3 Press MENU/NO to display “MD Edit Menu”.

- 4 Press **◀◀** or **▶▶** repeatedly until “MD A-B Erase ?” appears, then press ENTER/YES.

- 5 Press ENTER/YES again.
“MD - Rehearsal -” and “MD Point A ok?” appear alternately while the deck plays the selected track from the beginning to point A.

- 6 While monitoring the sound, press **◀◀** or **▶▶** repeatedly to find the starting point of the portion to be erased (point A).

You can shift the starting point by 1/86 second (1 frame) intervals.

To shift the point by second or minute intervals, press **◀◀** or **▶▶** so that “s” or “m” flashes, then press **◀◀** or **▶▶**.

- 7 Repeat step 6 until point A is played correctly.

- 8 Press ENTER/YES if point A is correct.
“MD Point B Set” appears and playback for setting the ending point of the portion to be erased (point B) starts.

- 9 Continue playback until the deck reaches point B, then press ENTER/YES.
“MD A-B Ers” and “MD Point B ok?” appear alternately and the deck repeats a portion of the few seconds before point A and after point B successively.

continued

10 Press ◀◀ or ▶▶ repeatedly to find point B.

The procedure is the same as step 6.

11 Press ENTER/YES if point B is correct. “MD Complete!!” appears for a few seconds and the portion between point A and B is erased.

To cancel A-B Erase

Press MENU/NO before completing the procedure.

To return to the condition before A-B Erase

You can return to the original condition immediately after erasing the track by using the Undo function (see page 38).

Note

If “Impossible” appears, the specified portion cannot be erased. This happens when you have edited the same track many times. This is due to a technical limitation of the MD system and is not a mechanical error.

Moving recorded tracks

— Move Function

You can use this function to change the order of any track on the disc. When you move tracks, the tracks are automatically renumbered.

Example: Moving track 3 to position 2.

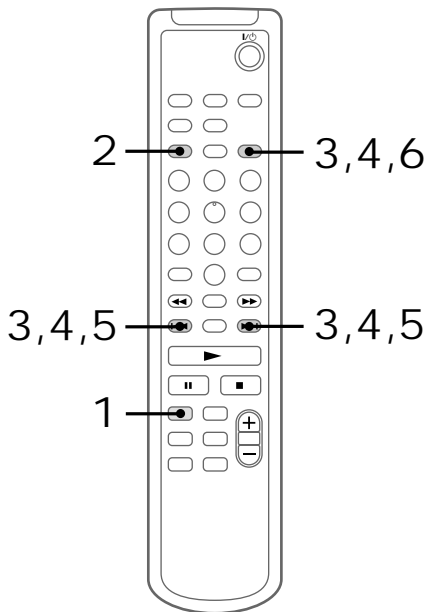
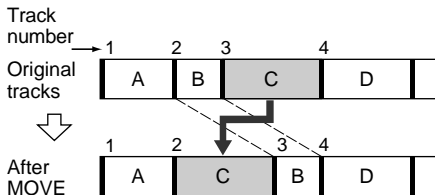

1 Press MD to switch the function to MD.

2 Press MENU/NO to display “MD Edit Menu”.

3 Press **◀◀** or **▶▶** repeatedly until “MD Move ?” appears, then press ENTER/YES.

4 Press **◀◀** or **▶▶** repeatedly until the desired track number to move appears, then press ENTER/YES.

5 Press **◀◀** or **▶▶** repeatedly until the new track position appears.

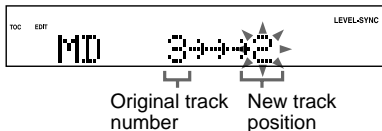

6 Press ENTER/YES. “MD Complete!!” appears for a few seconds and the selected track moves to the appointed position.

To cancel moving

Press MENU/NO before completing the procedure.

To return to the track order before Move

You can return to the original track order immediately after moving recorded tracks by using the Undo function (see page 38).

Dividing recorded tracks

— Divide Function

You can use this function to mark track numbers after recording. The total number of tracks increases by one and all the tracks following the divided ones are renumbered.

Example: Dividing track 2 into two tracks.

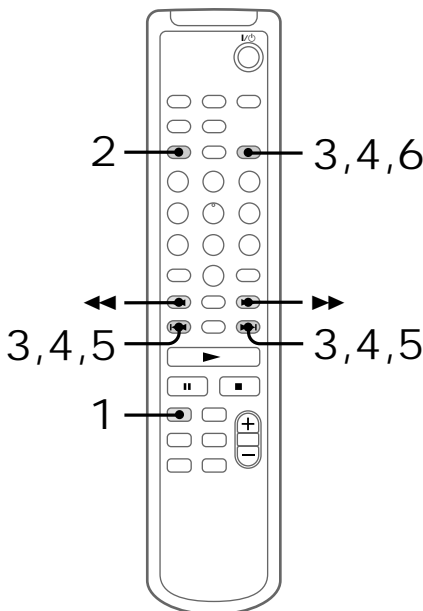
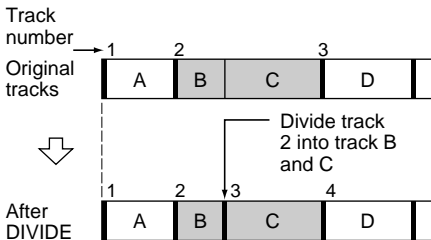

1 Press MD to switch the function to MD.

continued

Dividing recorded tracks (continued)

- 2 Press MENU/NO to display “MD Edit Menu”.
- 3 Press ◀◀ or ▶▶ repeatedly until “MD Divide ?” appears, then press ENTER/YES.
- 4 Press ◀◀ or ▶▶ repeatedly until the desired track number to divide appears, then press ENTER/YES.
“MD - Rehearsal -” appears and the portion to be divided is played repeatedly.
- 5 While monitoring the sound, press ◀◀ or ▶▶ repeatedly to adjust the point to be divided.
You can shift the point by 1/86 second (1 frame) intervals.
To shift the point by second or minute intervals, press ◀◀ or ▶▶ so that “s” or “m” flashes, then press ◀◀ or ▶▶.
- 6 Press ENTER/YES.
“MD Complete!!” appears for a few seconds and the newly created track starts playing.

To cancel dividing

Press MENU/NO before completing the procedure.

To return to the condition before Divide

You can return to the original condition immediately after dividing the tracks by using the Undo function (see page 38). You can also return to the original condition by using the Combine function (see page 37).

Notes

- If you divide a labelled track into two tracks, only the first track retains the track title.

Example:

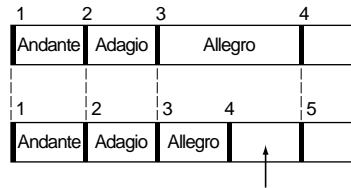

The new track is not labelled

- “Impossible” appears when you specify the division point at the beginning or end of a track. Press ◀◀ or ▶▶ to shift the position.

Combining recorded tracks — Combine Function

You can use this function to combine 2 tracks into a single track. The total number of tracks decreases by one and all tracks following the combined ones are renumbered.

Example: Combining track 3 to track 1.

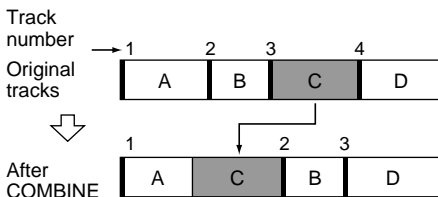

Example: Combining track 1 to track 4.

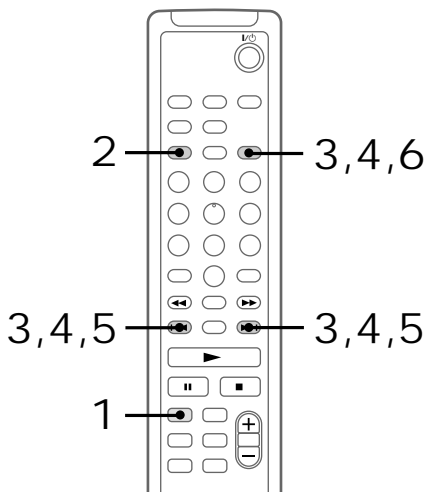
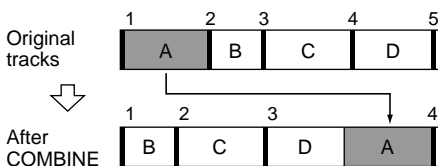

- 1 Press MD to switch the function to MD.
- 2 Press MENU/NO to display “MD Edit Menu”.
- 3 Press ◀◀ or ▶▶ repeatedly until “MD Combine ?” appears, then press ENTER/YES.

- 4 Press ◀◀ or ▶▶ repeatedly until the first track number of the two to be combined appears, then press ENTER/YES.

For example, to combine tracks 4 and 1, select 4.



First track number

- 5 Press ◀◀ or ▶▶ repeatedly until the second track number of the two to be combined appears.



Second track number to be combined

New track number

- 6 Press ENTER/YES. “MD Complete!!” appears for a few seconds and the tracks are combined. Play starts.

continued

Combining recorded tracks (continued)

To cancel combining

Press MENU/NO before completing the procedure.

To return to the condition before Combine

You can return to the original condition immediately after combining the tracks by using the Undo function (see this page). You can also return to the original condition by using the Divide function (see page 35).

Notes

- If both of the combined tracks have track titles, the title of the second track is erased.
- If “Impossible” appears, the tracks cannot be combined. This happens when you have edited the same track many times. This is due to a technical limitation of the MD system and is not a mechanical error.

Undoing the last edit

— Undo Function

You can use this function to cancel the last edit and restore the contents of the MD to the condition before the edit.

Note, however, that you cannot undo an edit if you do any of the following after the edit:

- Do another edit.
- Press the ● REC or CD SYNC REC button.
- Update the TOC by turning off the system or ejecting the MD.
- Disconnect the mains lead.

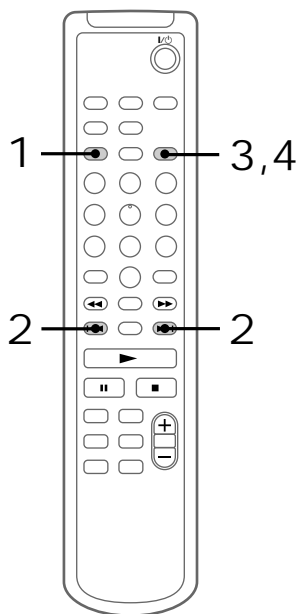

1 Press MENU/NO in stop mode to display “MD Edit Menu”.

2 Press ◀◀ or ▶▶ repeatedly until “MD Undo ?” appears.

“MD Undo ?” does not appear, when there is no editing function that can be cancelled.

Connecting a digital component

Connect the digital component using audio cords (not supplied) and an optical cable (square optical connector, not supplied). The digital audio signal from the connected component is digitally recorded to the MD.

The analogue connection is for monitoring the audio, and the digital connection is for recording. If there is no analogue connection, no sound will be produced from the speaker. The digital audio signal from the connected component is recorded to the MD. However, if the digital component is not connected to the DIGITAL OPTICAL AUX IN, the audio connected to the AUX IN (analogue) will be recorded as an analogue signal. Also refer to the operating instructions for each component.

continued

3 Press ENTER/YES.

One of the following messages appears, depending on the last edit.

Editing done	Message
Labelling a track or an MD	"MD Name Undo?"
Erasing labelled titles	
Erasing a single track	
Erasing all tracks	"MD Erase Undo?"
Erasing a portion of a track	
Moving a track	"MD Move Undo?"
Dividing a track	"MD Divide Undo?"
Combining tracks	"MD Combine Undo?"

4 Press ENTER/YES again.

"MD Complete!!" appears for a few seconds and the contents of the MD are restored to the condition before the edit.

To cancel Undo

Press MENU/NO before completing the procedure.

Connecting digital components (continued)

To the audio output of a digital component

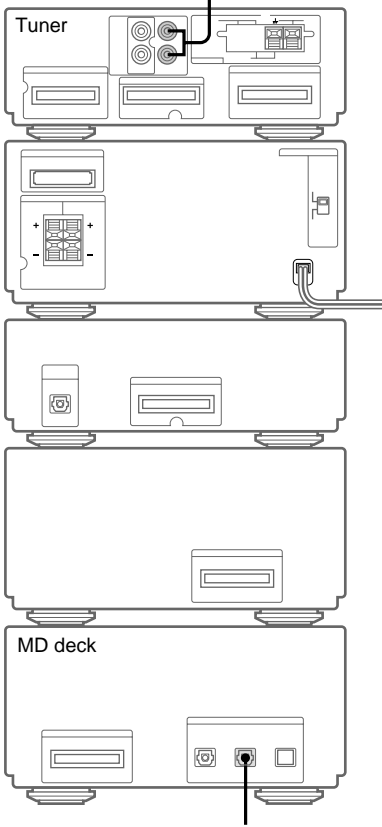

To the digital optical output of a digital component

- 1 Connect an optical cable (square optical connector, not supplied).

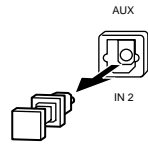

- 1 Take the cap off the DIGITAL OPTICAL AUX IN.

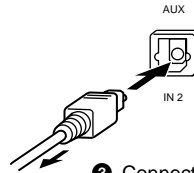

- 2 Connect an optical cable.

- 3 Connect the cable to the digital optical output of a digital component.

- 2 Connect audio cords (not supplied).

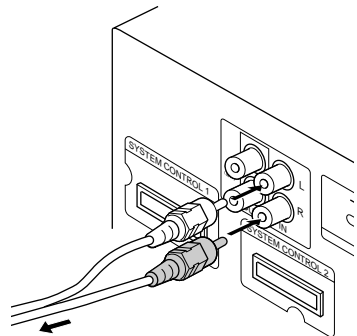

Connect the cords to the audio output of a digital component.

Tip

Switch the function to "AUX" when listening to or recording the sound of connected components.

Notes

- Digital recording is prohibited for most DVD software. To record DVD software for which digital recording is prohibited, disconnect the optical cable and make an analogue recording.
- A built-in sampling rate converter lets you make a digital recording of the sound from a digital component to the MD deck regardless of the source frequency (32 kHz, 44.1 kHz, 48.0 kHz).
- If the optical cable is not connected or incorrectly connected, or if the optical cable is connected but there is some problem with the input digital signal, the system automatically switches to analogue recording and the audio is recorded in analogue format.
- When connecting the DVD player's DIGITAL OUT jack to the MD deck's DIGITAL OPTICAL AUX IN jack, set the DVD player so that the signals output from the player's DIGITAL OUT jack are downmixed to 2 channels (2ch linear PCM). If the DVD player is set to 5.1ch output, you cannot record to the MD.

When "OVER" lights up during recording from the connected components

A signal in excess of the specified level was input during recording. Perform the following operations and then record the source again.

- 1 Press MENU/NO twice during recording or recording pause.
"Setup Menu" appears.
- 2 Turn \lll/\ggg until "Level Adjust ?" appears, then press ENTER/YES.
- 3 Turn \lll/\ggg to adjust the recording level.
The recording level can be adjusted from -12 to +12. Make sure that "OVER" does not appear in the display at the loudest portion.
- 4 Press ENTER/YES.
- 5 Press MENU/NO.

Note

If "OVER" appears in the display when the recording level is between -12 and 0, change the audio input level and reduce the input sound.

Precautions

On operating voltage (For the model with the voltage selector)

- Before operating the system, check that the operating voltage of your system is identical with the voltage of your local power supply.
- The voltage selector is located at the rear of the apparatus.

On safety

- The unit is not disconnected from the AC power source (mains) as long as it is connected to the wall outlet, even if the unit itself has been turned off.
- Unplug the system from the mains if it is not to be used for an extended period of time.
To disconnect the mains lead, pull it out by the plug. Never pull the cord itself.
- Should any solid object or liquid fall into the system, unplug the system and have it checked by qualified personnel before operating it any further.
- AC power cord (mains lead) must be changed only at the qualified service shop.
- When you connect the mains lead to the mains, even if the power is off, the system begins charging for remote and timer functions. Therefore the surface of this unit become warm, this is normal.

On placement

- Make sure the system fan is on during use.
Place the system in a location with adequate air circulation, and do not place anything on top of the system.
- Place the system in a location with adequate ventilation to prevent heat build up.
- Do not place the system in an inclined position.
- Do not place the system in locations where it is;
 - Extremely hot or cold
 - Dusty or dirty
 - Very humid
 - Subject to vibrations
 - Subject to direct sunlight.

continued

Precautions (continued)

On operation

If the system is brought directly from a cold to a warm location, or is placed in a very damp room, moisture may condense on the lens inside the CD player or the MD deck. Should this occur, the system will not operate properly. Remove the CD or MD and leave the system turned on for about an hour until the moisture evaporates.

On transportation

- Make sure you remove discs, and turn off the system. If you move the system with the discs inserted, you may be unable to remove the discs.
- Before you move the system, turn off the system and make sure all operations have finished.

If you have any questions or problems concerning your system, please consult your nearest Sony dealer.

Notes on MDs

- If you try to force the shutter open, the disc may be damaged. If the shutter opens, close it immediately without touching the disc inside.
- Affix the label supplied with the disc only to the specified label indentation. Do not affix the label around the shutter or in other locations. Note that the shape of the indentation depends on the disc.

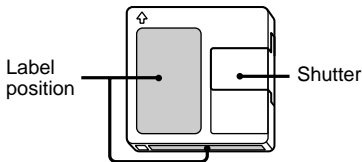

- Wipe the disc cartridge with a dry cloth to remove dirt.
- Do not expose the MD to direct sunlight or heat sources such as hot air ducts, nor leave it in a car parked in direct sunlight.

Cleaning the cabinet

Use a soft cloth slightly moistened with mild detergent solution.

System limitations of MDs

The recording system in your MD deck has the limitations described below.

Note, however, that these limitations are due to the inherent nature of the MD recording system itself, not to mechanical causes.

"MD Disc Full" appears before the MD has reached the maximum recording time

When 255 tracks have been recorded on the MD, "MD Disc Full" appears regardless of the total recorded time. More than 255 tracks cannot be recorded on the MD. To continue recording, erase unnecessary tracks or use another recordable MD.

"MD Disc Full" appears before the maximum number of tracks (255) is reached

Fluctuations in emphasis within tracks are sometimes interpreted as track intervals, increasing the track count and causing "MD Disc Full" to appear.

The remaining recording time does not increase even after erasing numerous short tracks

Tracks shorter than 12 seconds are not counted, so erasing them may not increase the recording time.

Some tracks cannot be combined with others

Track combination may become impossible when tracks are shorter than 8 seconds.

The total recorded time and the remaining time on the MD do not add up to the maximum recording time

Recording is done in minimum units of 2 seconds each, no matter how short the material. The recorded contents may be shorter than the maximum recording capacity. Disc space may also be reduced by scratches.

The sound may drop-out while searching the edited tracks

Tracks created through editing may exhibit sound dropout during searching because high-speed playback requires time to search for the position on the disc when the tracks are not in order.

Track numbers cannot be marked

When "LEVEL-SYNC" (see page 24) lights up in the display window during analogue recording, the track numbers may not be marked at the beginning of the track:

- if the input signal is below a certain fixed level for less than two seconds between tracks.
- if the input signal is below a certain fixed level for more than two seconds in the middle of the track.

Guide to the Serial Copy Management System

Digital audio components, such as CDs, MDs, and DATs let you copy music easily with high quality by processing music as a digital signal.

To protect the copyrighted music programmes, this system uses the Serial Copy Management System that allows you to make only a single copy of a digitally recorded source through digital-to-digital connections.

You can make only a first generation copy* through a digital-to-digital connection.

That is:

- 1 You can make a copy of a commercially available digital sound programme (for example, a CD or MD), but you cannot make a second copy from the first-generation copy.
 - 2 You can make a copy of a digital signal from a digitally recorded analogue sound programme (for example, an analogue record or a music cassette tape) or from a digital satellite broadcast programme, but you cannot make a second copy.
- * A first-generation copy means a digital recording of a digital signal made on digital audio equipment. For example, if you record from this system's CD player to the MD deck, you make a first-generation copy.

Note

This copy management system doesn't apply when you make a recording through analogue-to-analogue connections.

Troubleshooting

If you have any problem using this system, use the following checklist.

First, check that the mains lead is connected firmly and that the speakers are connected correctly and firmly.

Should any problem persist, consult your nearest Sony dealer. When bringing the system in for repairs, be sure to bring in the entire system. This product is a system product, and the entire system is needed to determine the location requiring repair.

An MD cannot be inserted.

- Insert the MD with the arrow side up and the arrow pointing toward the deck.

The controls do not work.

- Replace the MD with a new one.
- Retry the operations after "TOC" turns off.

Play does not start.

- Replace the MD.
- Insert the MD and leave the system turned on for a few hours until the moisture evaporates.
- Press \blacktriangleright on the MD deck to start play.

The sound skips.

- Replace the MD.
- Try moving the system to a place without vibration (e.g., on top of a stable stand).
- Try moving the speakers away from the system, or placing them on separate stands.

When you listen to a track with bass sounds at high volume, the speaker vibration may cause the sound to skip.

- Insert the disc and wait for a few hours with the system turned on.

continued

Play does not start from the first track.

- Press PLAY MODE repeatedly while the MD deck is in stop mode until “PROGRAM” or “SHUFFLE” disappears to return to normal play.

“- OVER -” appears.

- Keep pressing ◀ on the MD deck or turn |◀◀/▶▶| on the MD deck counter-clockwise to return to the desired playing position.

“OVER” lights up during recording.

- Adjust the recording level (see page 26).

Recording or editing was done, but the TOC is not updated.

- MD recording and editing contents are recorded to the MD when the MD is removed, so make sure you remove the MD after recording or editing (see pages 11 and 28).

Recording is not possible.

- Remove the MD and slide the tab to close the slot (see page 11).
- Connect the optional component properly (see page 39).
- Switch the function to desired sound source.
- Replace the MD with a recordable MD, or use the Erase function to erase unnecessary tracks (see pages 31 – 34).
- Start recording over from the beginning.

The sound from an MD you recorded is too low (or too high).

- Readjust the recording level (see page 26).
-

Self-diagnosis Display

This system has a Self-diagnosis display function to let you know if there is a system malfunction. The display shows a code made up of three letters and a message alternately to show you the problem. To solve the problem refer to the following list. If any problem persists, consult your nearest Sony dealer.

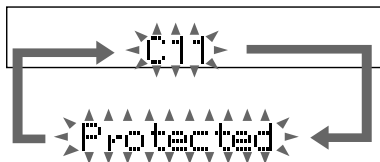

C11/Protected

The MD is protected against erasure.

- Remove the MD and slide the tab to close the slot (see page 11).

C12/Cannot Copy

You tried to record a CD or MD with a format that the system does not support, such as a CD-ROM.

- Remove the disc and turn off the system once, then turn it on again.

C13/REC Error

Recording could not be performed properly.

- Move the system to a stable place, and start recording over from the beginning.

The MD is dirty or scratched, or the MD does not meet the standards.

- Replace the MD and start recording over from the beginning.

C13/Read Error

The MD deck cannot read the disc information properly.

- Remove the MD once, then insert it again.

C14/Toc Error

The MD deck cannot read the disc information properly.

- Replace the MD.
 - Erase all the recorded contents of the MD using the All Erase function (see page 32).
-

C41/Cannot Copy

The sound source is a copy of a commercially available music software, or you tried to record a CD-R (Recordable CD).

- The Serial Copy Management System prevents making a digital copy (see page 43). You cannot record a CD-R.
-

C71/Check OPT-IN

This appears momentarily because of the signal of the digital broadcast during recording.

- There is no affect on the recorded contents.

No component is connected to the DIGITAL OPTICAL IN jack, or a digital component is not connected properly.

- Connect a digital component to the DIGITAL OPTICAL IN jack properly using a digital connecting cable (an optical cable) (not supplied, see page 39).

The connected digital component is not turned on.

- See the operating instructions supplied with the connected component and confirm whether the component is turned on.

The digital connecting cable (an optical cable) connected to the DIGITAL OPTICAL IN jack is pulled out, or the connected digital component is turned off during digital recording.

- Connect the cable, or turn on the digital component.
-

Messages

One of the following messages may appear or flash in the display during operation.

Auto Cut

The MD deck is pausing the recording because silence continued for 30 seconds or more during digital recording.

Blank Disc

The inserted recordable MD is new, or all tracks on the MD have been erased.

Cannot Edit

- A pre-mastered MD is in the deck.
 - You tried to edit in Programme or Shuffle Play mode.
-

Cannot REC

- A pre-mastered MD is in the deck.
 - The function is switched to MD.
-

Complete!!

The editing operation of MDs is completed.

Impossible

- You tried to make an impossible editing operation.
 - You cannot combine the tracks due to the system limitations of MDs.
-

Disc Full!!

There is no time remaining on the MD.

Eject

The MD deck is ejecting the MD.

No Disc

There is no disc in the MD deck.

continued

Name Full

There is no more space to store track or disc titles.

No Name

You tried to show the title of a non-labelled disc or track.

- OVER -

You have reached the end of the MD while keep pressing ►► on the MD deck during playing pause.

Position OK?

The position to be divided by the Divide function is being played.

Push STOP!

You pressed PLAY MODE during play.

- Rehearsal -

The MD is playing the specified dividing point for confirmation during the Divide function.

Smart Space

The signal was input again after silence continued for 3 or more but less than 30 seconds during digital recording.

Text Protect

There is CD TEXT information which cannot be recorded on the MD.

TOC Reading

The MD deck is reading the TOC information of the MD.

TOC Writing

The MD deck is writing the information of recorded or edited contents.

Track End

You have reached the end of the track while adjusting the dividing point during the Divide function.

Specifications

MD deck section (MDS-SP55)

System	MiniDisc digital audio system
Laser	Semiconductor laser ($\lambda=780$ nm) Emission duration: continuous
Laser output	Max. 44.6 μ W* *This output is the value measured at a distance of 200 mm from the objective lens surface on the Optical Pick-up Block with 7 mm aperture.
Sampling frequency	44.1 kHz
Frequency response	20 Hz – 20 kHz
Inputs	DIGITAL OPTICAL CD IN: Optical DIGITAL OPTICAL AUX IN: Optical
Output	DIGITAL OPTICAL OUT: Optical

General

Dimensions (w/h/d) incl. projecting parts and controls	Approx. 202 × 101 × 298 mm
Mass	Approx. 1.7 kg
Supplied accessories	System cable (1) Digital cable (1)

Design and specifications are subject to change without notice.

Index

A

- A-B Erase Function 33
- Adjusting
 - the recording level 26
 - the volume 6
- After
 - editing 28
 - recording 11
- All Erase Function 32
- Analogue recording 11, 13, 17, 19
- Auto Cut 22
- Automatic Source Selection 6

B

- Before
 - editing 28
 - recording 11

C

- CD-MD Synchro Recording 12, 15
- Combine Function 37
- Connecting. *See* Hooking up

D

- Digital recording 11, 12
- Display 10
- Divide Function 35

E, F, G

- Erase Function 31
- Erasing
 - a portion of a track 33
 - a single track 31
 - a track number 37
 - all tracks on an MD 32
 - titles on an MD 30

H, I, J, K

- Hooking up
 - optional components 39
 - the system 4

L

- Labelling an MD 29
- Level Synchro Recording 24

M

- Manual recording 16, 19
- Messages 45
- Monaural recording 27
- Move Function 34

N

- Name Function 29
- Normal Play 6

O

- Optional components 39

P, Q

- Playing
 - an MD 6
 - tracks in random order (Shuffle Play) 7
 - tracks in the desired order (Programme Play) 8
 - tracks repeatedly (Repeat Play) 9
- Programme Play 8
- Protecting recordings 11

R

- Recording
 - a CD 12, 15, 16
 - a radio programme 19
 - a tape 13, 16
 - an MD 17
 - manual recording 16, 19
 - monaural recording 27
 - timer-recording 20
- Repeat Play 9

S

- Saving recordings 11
- Self-diagnosis display 44
- Serial copy management system 43
- Shuffle Play 7
- Smart Space 22
- System limitations of MDs 42

T

- Time Machine Recording 23
- Timer-recording 20
- Track Erase Function 31
- Track marking 24, 35
- Troubleshooting 43

U, V, W, X, Y, Z

- Undo Function 38

Free Manuals Download Website

<http://myh66.com>

<http://usermanuals.us>

<http://www.somanuals.com>

<http://www.4manuals.cc>

<http://www.manual-lib.com>

<http://www.404manual.com>

<http://www.luxmanual.com>

<http://aubethermostatmanual.com>

Golf course search by state

<http://golfingnear.com>

Email search by domain

<http://emailbydomain.com>

Auto manuals search

<http://auto.somanuals.com>

TV manuals search

<http://tv.somanuals.com>