

FM Stereo/FM-AM Receiver



Operating Instructions

***STR-GX69ES
STR-GX59ES***

Warning

WARNING

To prevent fire or shock hazard, do not expose the unit to rain or moisture.

	CAUTION RISK OF ELECTRIC SHOCK DO NOT OPEN	
<p>CAUTION: TO REDUCE THE RISK OF ELECTRIC SHOCK, DO NOT REMOVE COVER (OR BACK). NO USER-SERVICEABLE PARTS INSIDE. REFER SERVICING TO QUALIFIED SERVICE PERSONNEL.</p>		



This symbol is intended to alert the user to the presence of uninsulated "dangerous voltage" within the product's enclosure that may be of sufficient magnitude to constitute a risk of electric shock to persons.



This symbol is intended to alert the user to the presence of important operating and maintenance (servicing) instructions in the literature accompanying the appliance.

Note to CATV system installer

This reminder is provided to call the CATV system installer's attention to Article 820-40 of the NEC that provides guidelines for proper grounding and, in particular, specifies that the cable ground shall be connected to the grounding system of the building, as close to the point of cable entry as practical.

Owner's Record

The model number is located on the rear exterior and serial number is on the rear. Record the serial number in the space provided below. Refer to these numbers whenever you call upon your Sony dealer regarding this product.

Model No. STR-GX69ES
Model No. STR-GX59ES

Serial No. _____
Serial No. _____

INFORMATION

This equipment generates and uses radio frequency energy and if not installed and used properly, that is, in strict accordance with the manufacturer's instructions, may cause interference to radio and television reception. It has been type tested and found to comply with the limits for a Class B computing device in accordance with the specifications in Subpart J of Part 15 of FCC Rules, which are designed to provide reasonable protection against such interference in a residential installation. However, there is no guarantee that interference will not occur in a particular installation. If this equipment does cause interference to radio or television reception, which can be determined by turning the equipment off and on, the user is encouraged to try to correct the interference by one or more of the following measures:

Reorient the receiving antenna

Relocate the equipment with respect to the receiver

Move the equipment away from the receiver

Plug the equipment into a different outlet so that equipment and receiver are on different branch circuits.

If necessary, the user should consult the dealer or an experienced radio/television technician for additional suggestions. The user may find the following booklet prepared by the Federal Communications Commission helpful:

"How to identify and Resolve Radio-TV Interference Problems". This booklet is available from the U.S. Government Printing Office, Washington, DC 20402, Stock No. 004-000-00345-4.

For the customers in Canada

CAUTION :
TO PREVENT ELECTRIC SHOCK, DO NOT USE THIS POLARIZED AC PLUG WITH AN EXTENSION CORD, RECEPTACLE OR OTHER OUTLET UNLESS THE BLADES CAN BE FULLY INSERTED TO PREVENT BLADE EXPOSURE.

This apparatus complies with the Class B limits for radio noise emissions set out in Radio Interference Regulations.

This instruction manual covers the STR-GX69ES and STR-GX59ES.

The following functions are equipped only with the STR-GX69ES.

- FRONT PRE OUT/POWER IN jacks
- CONTROL S AUDIO IN/OUT jacks

The illustrations used in the manual are mainly the STR-GX69ES.

Table of Contents

Introduction		
Features	4	
Precautions	4	
Chapter 1 Getting Started		
Installing	5	
Notes on installation	5	
Installing batteries	5	
Changing the AM tuning interval	5	
Connecting the system	6	
Notes on connection	6	
Audio connection diagram	6	
VCR and TV connection diagram	7	
Connecting the AM antenna	8	
Connecting the FM antenna	8	
Connecting the antenna ground	8	
Connecting speaker systems	9	
Connecting the remote control system (STR-GX69ES only)	10	
Using AC outlets	10	
Parts Identification	11	
Front panel	11	
Remote commander	12	
Chapter 2 Basic Operation		
Operating with the remote commander	13	
Changing the settings of the FUNCTION buttons	13	
Audio adjustment	14	
Volume adjustment	14	
Balance adjustment	14	
Sound quality adjustment	14	
Receiving FM/AM broadcasts	15	
Tuning in an FM station automatically — Automatic Tuning	15	
Tuning in an FM/AM station manually — Manual Tuning	16	
Memorizing a station	16	
Tuning in a preset station	17	
Listening to program source other than broadcasts	18	
Recording on an audio tape	19	
Recording	19	
Tape dubbing	19	
Recording on a VCR	20	
Recording TV programs	20	
Video tape editing	20	
Chapter 3 Advanced Operation		
Obtaining the surround effect	21	
Available types of effects	21	
Placement of speakers for DOLBY PRO LOGIC mode	21	
Adjusting the input level for Dolby surround system	22	
Listening with surround effect	23	
Storing other manufacture's operating codes onto the supplied remote commander	24	
Programming signals of other audio/video equipment (RM-P321 only)	24	
Programming a new signal onto a previously programmed button	25	
Controlling equipment	25	
Chapter 4 Other Information		
Troubleshooting	26	
Specifications	28	
Quick reference	30	

Features

The STR-GX69ES or STR-GX59ES is a receiver which controls audio and video sources. The unit allows you to switch easily among a variety of audio/video programs.

Amplifier

- Optical Legato Linear A System allows the receiver to operate automatically as a class A amplifier when the level is low and as a class B amplifier when the level is high without disturbing the sound signal. This minimizes total harmonic distortion at every sound stage.
- These receivers have a spontaneous twin drive power circuit. Condensers having large capacity are used independently for the voltage amplification drive stage of class A and power output stage of class B. Thus, a stable output and high quality sound are obtained, resulting in exclusion of power interferences. The class A stage realizes a stable operation free from interference of the power stage even when an instantaneous or strong output is received.
- A source direct switch is employed to reproduce high fidelity sound. Any source can be reproduced without passing through the circuits of tone control and surround decoder.

Tuner

- Precise tuning is obtained thanks to the quartz-locked digital synthesizer system.
- A total of 30 FM/AM stations can be preset in 3 memory pages (A, B and C) that allow you to classify stations.

Surround sound system

- This unit incorporates all of 3 types of surround effect.
 - : The Dolby® Pro Logic Surround Decoder has the same functions for playback as movie theaters and gives a theater-like experience in your listening room, naturally reproducing the audio sound field.
 - Hall Surround-provides reverberation effect that is produced in a large concert hall.
 - Simulated Surround-gives the feeling of width and thickness to monaural sound of old movie program, etc.
- The INPUT BALANCE control is employed to adjust the input balance of Dolby surround program sources.

Remote commander

- The remote commander allows you to control most of Sony's audio equipment from a distance.
- The programmable remote commander supplied with the STR-GX69ES is also equipped with an infrared ray transmitter/receiver which allows it to "read" and "store" control information from other remote commanders including non-Sony commanders.

* Manufactured under license from Dolby Laboratories Licensing Corporation. Additionally licensed under one or more of the following patents: U.S. numbers 3,632,886, 3,746,792, and 3,959,590. Canadian numbers 1,004,603 and 1,037,877. "DOLBY" and the double-D symbol  are trademarks of Dolby Laboratories Licensing Corporation.

Precautions

On safety

- Operate the unit only on 120 V AC, 60 Hz.
- Should any solid object or liquid fall into the cabinet, unplug the unit and have it checked by qualified personnel before operating it any further.
- Unplug the unit from the wall outlet if it is not to be used for an extended period of time. To disconnect the cord, pull it out by grasping the plug. Never pull the cord itself.
- One blade of the plug is wider than the other for the purpose of safety and will fit into the power outlet only one way. If you are unable to insert the plug fully into the outlet, contact your dealer.

On operation

- Before making program source connections, be sure to turn the power switch off and unplug the unit.
- When the unit is not used, turn the power off, to conserve energy and to extend the useful life of your unit.

On cleaning the cabinet

Clean the cabinet, panel and controls with a soft cloth lightly moistened with mild detergent solution. Do not use any type of abrasive pad, scouring powder, or solvent such as alcohol or benzine.

For the customers in the U.S.A.

For detailed safety precautions, see the "IMPORTANT SAFEGUARDS" leaflet.

If you have any question or problem concerning your unit, please consult your nearest Sony dealer.

Installing

Notes on Installation

To prevent internal heat buildup in the unit, place the unit in a location with adequate air circulation.

Do not install the unit:

- near heat sources such as radiators or air ducts.
- in a place subject to direct sunlight, excessive dust, mechanical vibration or shock.

Do not place anything on top of the cabinet.

The top ventilation holes must be unobstructed for the proper operation of the unit and to prolong the life of its components.

Installing Batteries

Before operating remote commander, install the batteries as shown.

1 Open the cover.

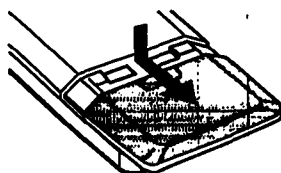

2 Insert two size AA (R6) batteries with correct polarity.

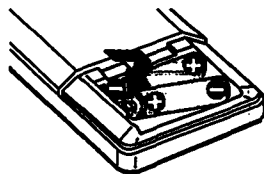

Do not throw away the carton and packing material!

It will be an ideal container when transporting the system for repair work, etc.

To avoid damage caused by battery leakage and corrosion

When the commander will not be used for a long time, remove the batteries.

Normal operation can be expected about a half year using Sony SUM-3 (NS), and a year using Sony AM-3 (NW) alkaline batteries.

When the batteries are run down, the remote commander will not operate the unit. In this case, replace batteries with new ones.

Changing the AM tuning interval

The AM tuning interval is preset to 10 kHz. To use the receiver where the frequency allocation system is based on a 9 kHz interval, make the following adjustments.

- 1 Turn on the power and tune in any AM station.
- 2 Turn off the power.
- 3 Press the POWER switch while pressing the "+" TUNING button.

To reset the AM tuning interval, repeat the above steps.

Caution

When the interval is changed, all preset stations which you have memorized will be erased. After changing the interval, be sure to preset the stations again.

Connecting the System

Notes on Connection

- The power cord should be connected last of all, after making sure that the POWER switch is turned off.
- The cable connectors should be fully inserted into the jacks. A loose connection may cause hum and noise.
- Cord plugs and jacks are color coded. The red plugs and jacks are to be connected to the right channel(R) and white ones to the left-channel(L).

Audio Connection Diagram

The numbers in the illustration correspond to those on the following pages.

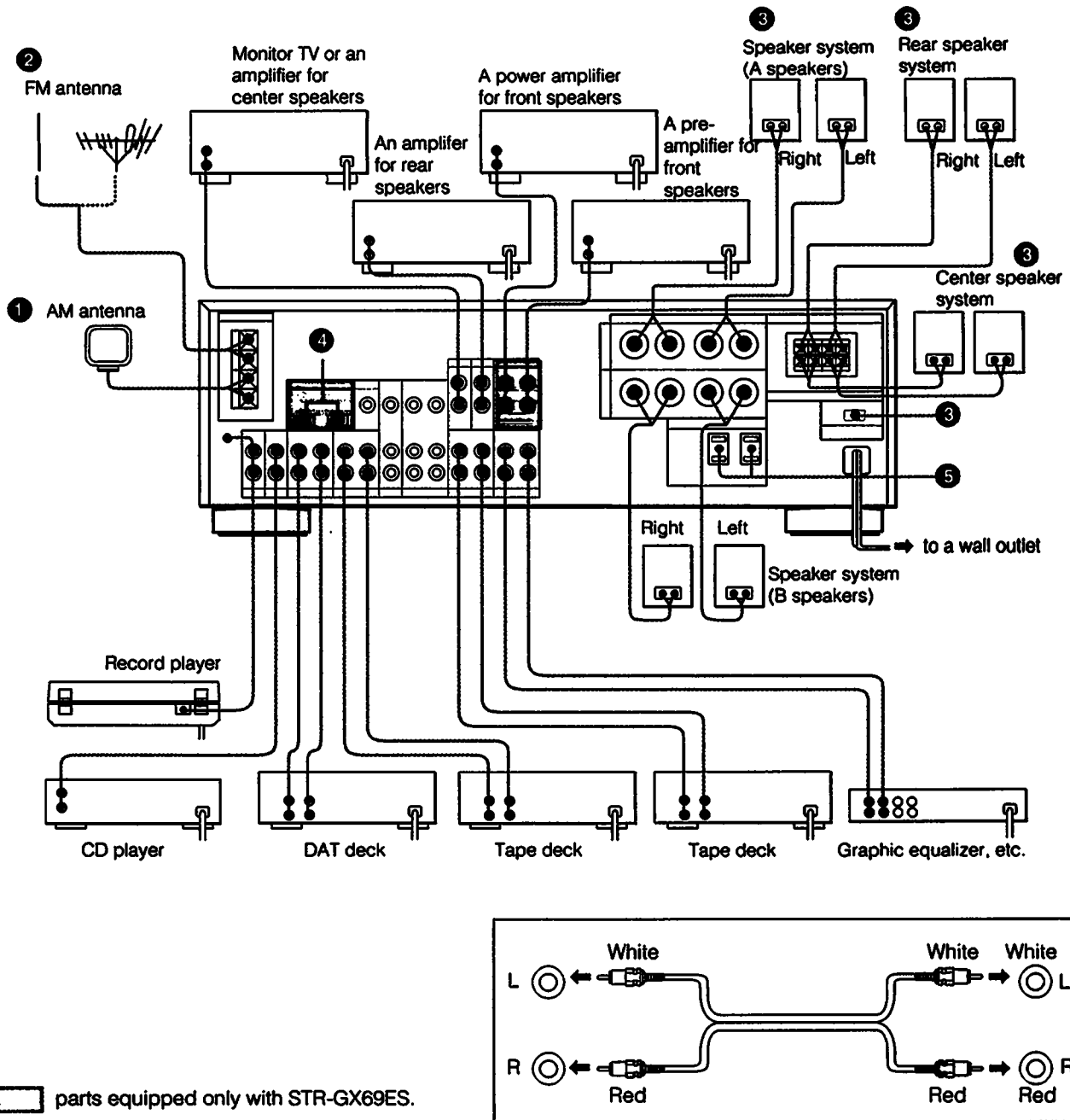

VCR and TV Connection Diagram

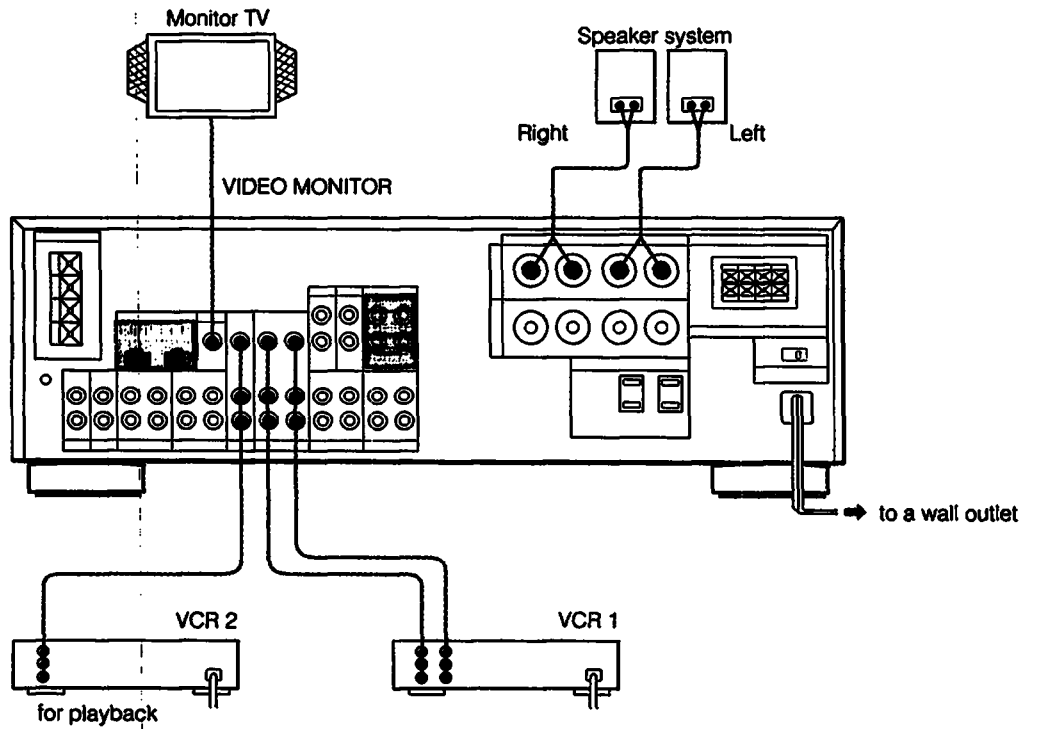

 parts equipped only with STR-GX69ES.

Connecting the System

1 Connecting the AM Antenna

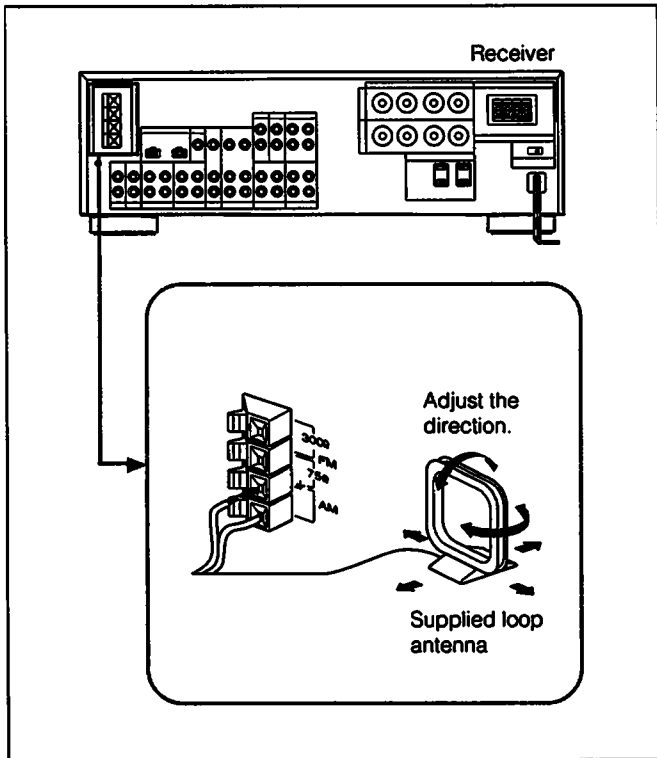

For areas with difficult AM reception

In areas with troubled reception, connect a 6 to 15-meter (20 to 50-foot) insulated wire to the AM antenna terminal. Extend this out of doors if possible, keeping the greater portion horizontal.

(There is no need to disconnect the supplied antenna.)

2 Connecting the FM Antenna

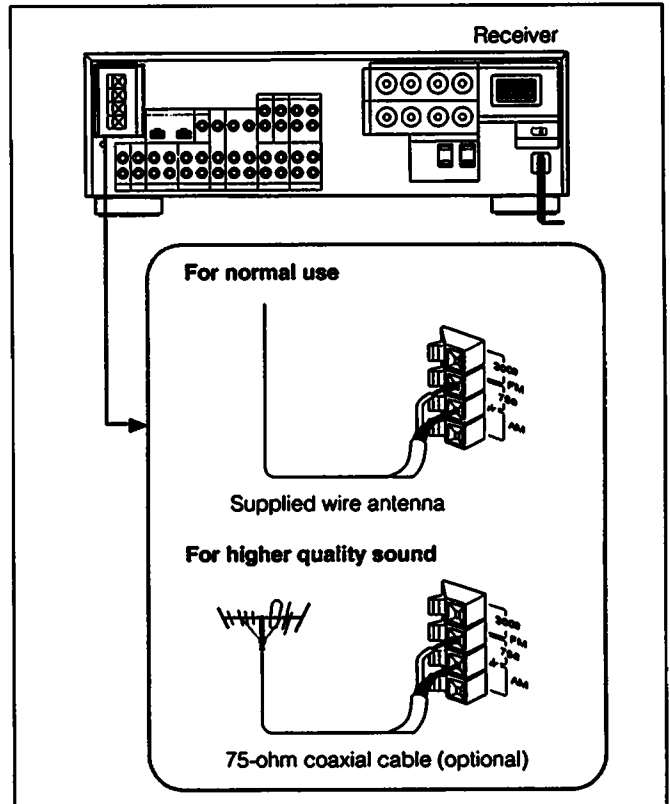

Connecting the Antenna Ground

To prevent hum, connect the ground wire to ANTENNA ground terminal (↕).

When an outdoor antenna is installed, be sure to connect the ground wire for lightning protection.

3 Connecting Speaker Systems

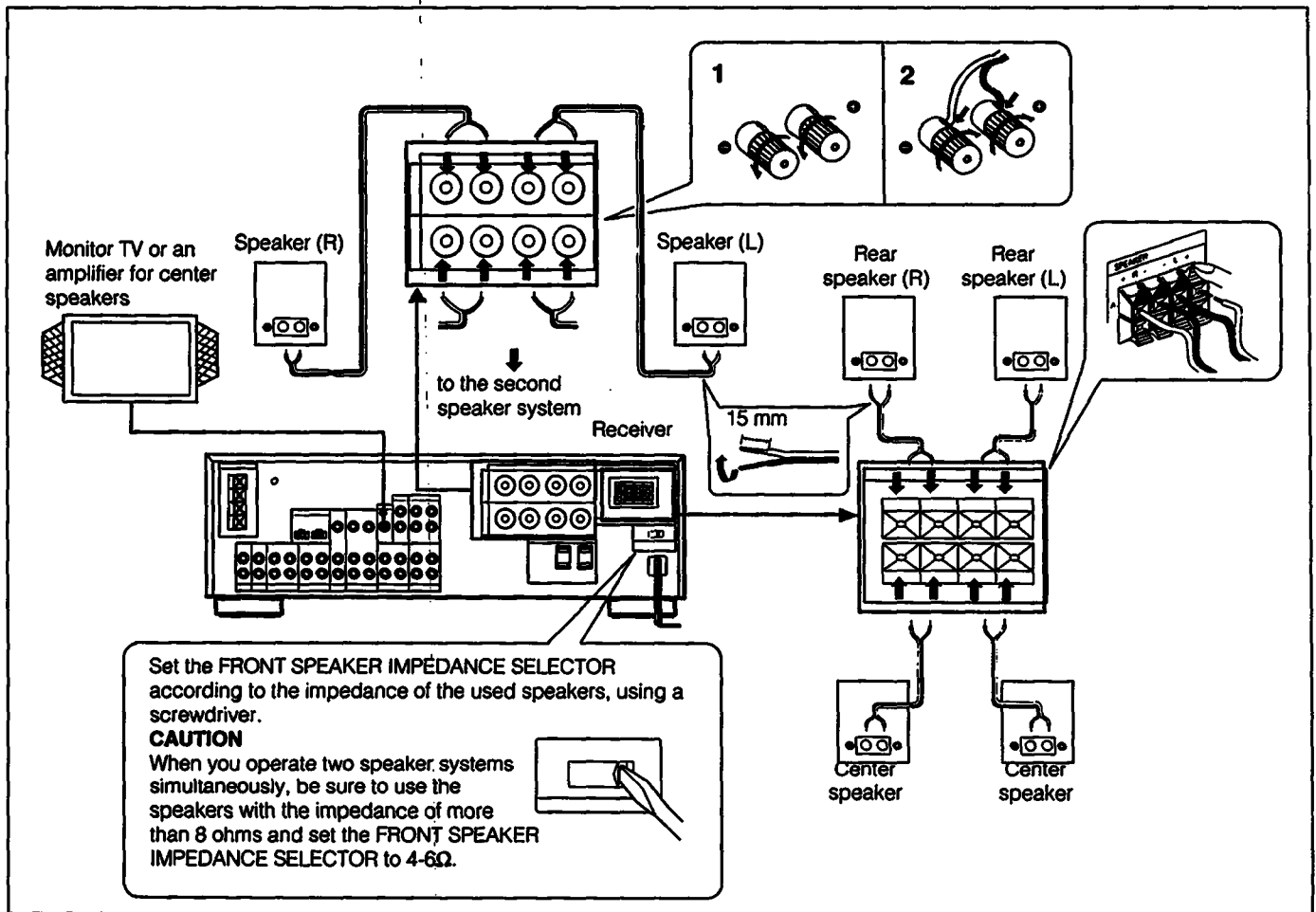

Note

Once the speakers have been connected, move SPEAKERS selector (on the front panel) to A, B or A + B setting. When using the headphones, set the SPEAKERS selector to OFF.

Speaker impedance and power capability (FRONT SPEAKER A or B)

This receiver is designed to work best with speakers having nominal impedance from 4 to 16 ohms at rated 80 watts (STR-GX59ES) or 100 watts (STR-GX69ES) RMS per channel with an 8 ohms load from 20 — 20,000 Hz.

Connecting the System

4 Connecting the Remote Control System (STR-GX69ES only)

To control the equipment connected to the receiver with the remote commander

Connect the CONTROL S OUT connector and the CONTROL S IN connector of each piece of equipment as illustrated.

Connection example

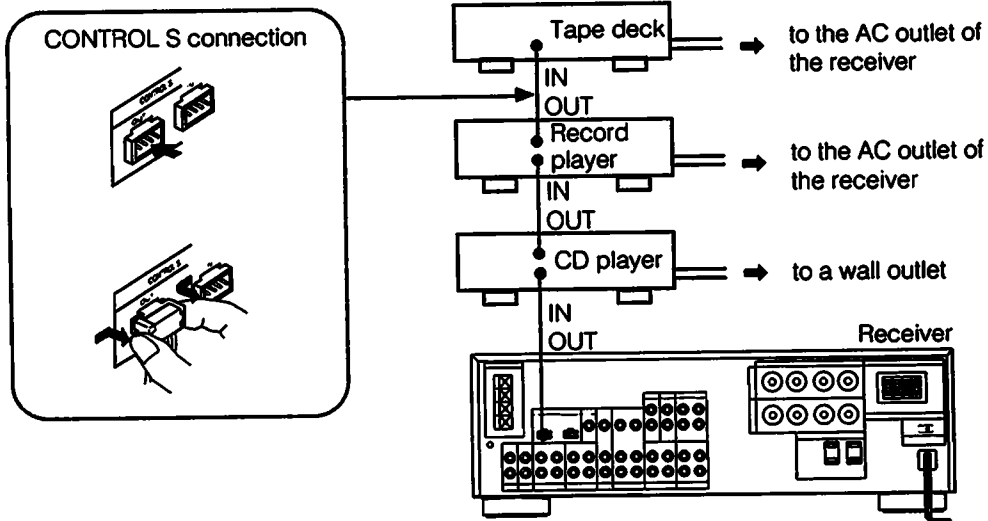

To control this receiver with the remote commander of the other equipment

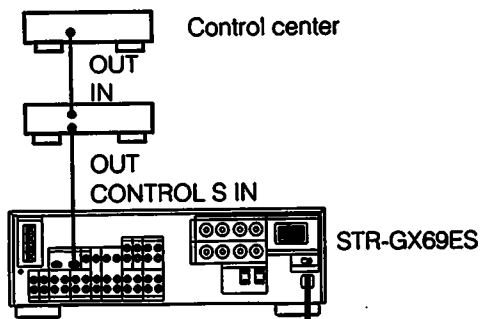

Note on the CONTROL-S IN connection

To remote control this unit (used as a tuner) through another component, connect the CONTROL-S IN on this unit to the CONTROL-S OUT on a Sony equipment, with a CONTROL-S cable. When this connection is made, only remote commands sent through the CONTROL-S IN connector will be executed. Note that the remote sensor on this unit will not function.

6 Using AC outlets

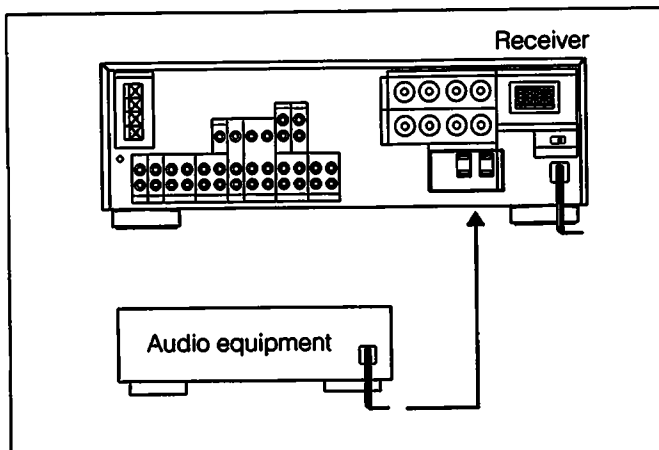

Connect the AC power cord of each piece of equipment to the AC outlet on the receiver so that you can turn the equipment on and off using the receiver's POWER switch.

Caution

Be careful that the total power consumption of each piece of equipment connected to the outlets on the receiver does not exceed 120 watts/1 A Max.

Do not connect electrical home appliances such as an electric iron, fan, TV, or other high-wattage equipment to these outlets.

Parts Identification

Front Panel

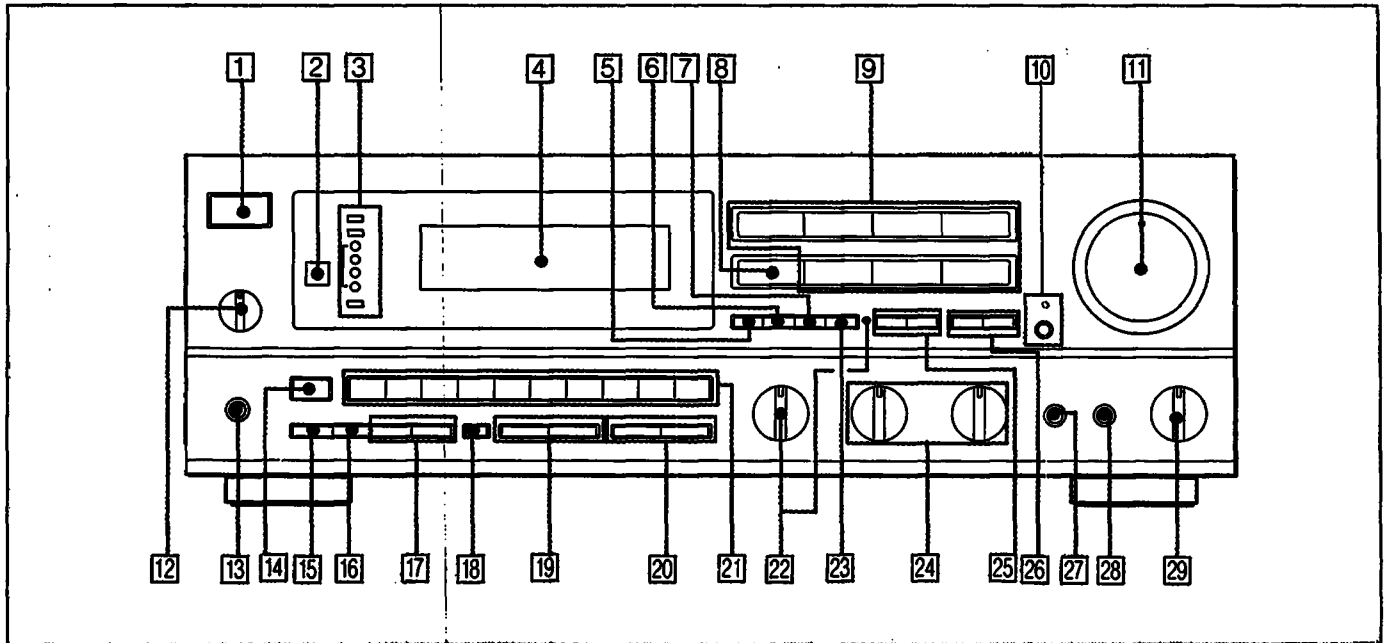

- | | |
|---|--|
| 1 POWER switch | 16 FM TUNE MODE switch (page 15 and 16) |
| 2 Remote control sensor | 17 BAND selectors (page 15 and 16) |
| 3 Surround, DOLBY PRO LOGIC MODE and TAPE MONITOR indicators | 18 MEMORY button (page 16) |
| 4 Display window | 19 TUNING $-/+$ buttons (page 15 and 16) |
| 5 SURROUND ON/OFF button (page 22 and 23) | 20 PRESET TUNING $-/+$ buttons (page 17) |
| 6 SURROUND MODE button (page 22 and 23) | 21 Numeric buttons (page 16 and 17) |
| 7 PRO LOGIC MODE button (page 21, 22 and 23) | 22 INPUT BALANCE control and AUTO INPUT BALANCE indicator (page 22) |
| 8 TAPE MONITOR switch (page 18) | 23 DELAY button (page 23) |
| 9 Function selectors | 24 TONE controls (page 14) |
| 10 MUTING button and indicator (page 14) | 25 SURROUND LEVEL CENTER $-/+$ buttons (page 22 and 23) |
| 11 ATTENUATOR and indicator (page 14) | 26 SURROUND LEVEL REAR $-/+$ buttons (page 22 and 23) |
| 12 SPEAKERS selector (page 9) | 27 SOURCE DIRECT button (page 14) |
| 13 HEADPHONES jack | 28 LOUDNESS switch (page 14) |
| 14 SHIFT button (page 16 and 17) | 29 BALANCE control (page 14) |
| 15 FM MODE button (page 15) | |

Parts Identification

Remote Commander

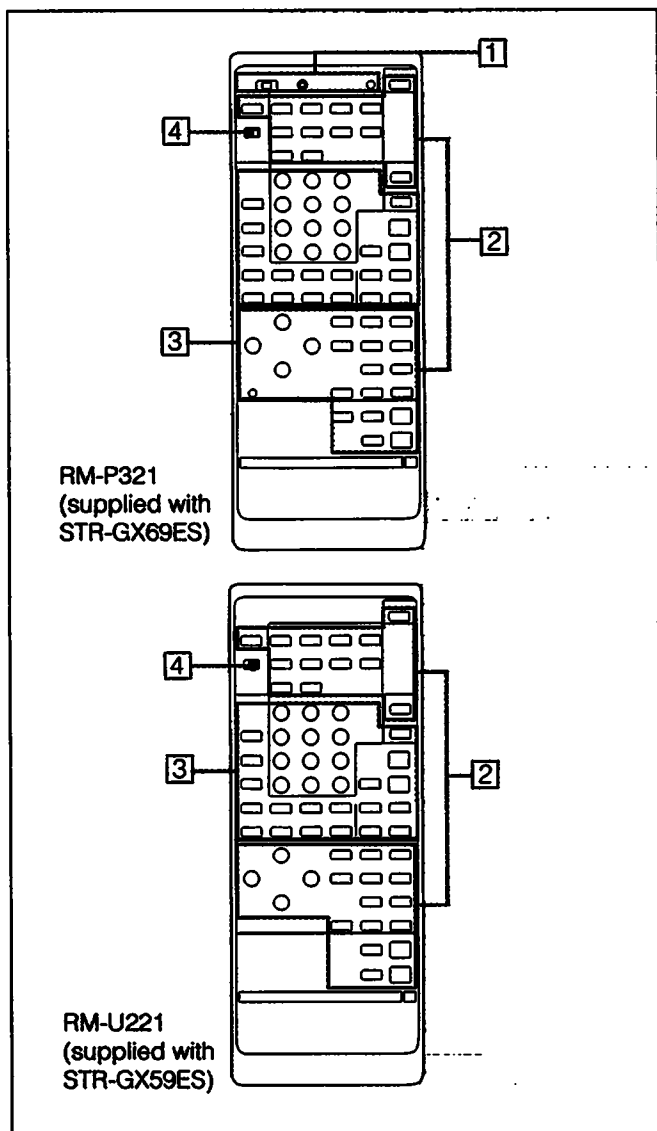

RM-P321
(supplied with
STR-GX69ES)

RM-U221
(supplied with
STR-GX59ES)

1 Program control section (RM-P321 only)

- Mode selector and indicator (page 24.)
- SONY STD: To control Sony equipment.
- USER STD: To control equipment whose remote control functions are stored.
- LEARN: To store functions of other remote commanders emitting infrared rays.
- PROGRAM CLEAR: Clears the stored functions.

2 Receiver control section

- FUNCTION:
- DAT, CD, TUNER, PHONO, VIDEO 1, VIDEO 2, VIDEO 3, TAPE, DIGITAL 1, 2: The each function is selected and the each unit enters its operating mode automatically. (VIDEO 3, DIGITAL 1, 2 cannot be used.)

- SYSTEM OFF: Turns off the power of the whole system.
- POWER: Turns on the power of the receiver.
- SOUND FIELD buttons
- U/P: This button does not function.
- MODE: Selects the surround mode.
- ON/OFF: Turns on/off the surround system.
- BAND: This button does not function.
- EQ: This button does not function.
- T. (test) TONE: Generates a pink noise signal that is sent in succession to each speaker.
- CURSOR MODE: This button does not function.
- CURSOR operating buttons: These buttons do not function.
- REAR LEVEL +/- buttons: Control the volume of rear speakers (surround level).
- CENTER LEVEL +/- buttons: Control the volume of center speaker (surround level).
- DBFB button: This button does not function.
- MUTING button: Mutes the sound.
- MASTER VOL +/- buttons: Control the receiver volume.
- SLEEP: This button does not function.
- RESET: Resets to the initial state.

3 Other equipment control section

- Numeric buttons (1 to 0): Designate the number.
- ENTER: Press after designating the TV/VCR channel.
- SHIFT: Select the memory page (A, B or C).
- TV/VIDEO selector: Selects the program to see: TV or VIDEO.
- ANT TV/MTR button: Selects the output signal from the antenna terminal on the VCR, either a TV signal or VCR programs.
- CH/PRESET +/- buttons: Select a preset channel.
- INDEX: Set to the index tuning mode.
- ◀◀/▶▶: fast winding/Manual search
- : Recording
- ◀/▶: Play
- : Stop
- ||: Pause
- ◀◀/▶▶: Locates a desired selection.
- REV/FWD: Press ● and REV or FWD at the same time.
- D (disc) SKIP: Disc skip (for a CD player equipped with a multi-disc changer)
- SELECT: Changes the settings of the FUNCTION buttons.
- Note**
- The button which has no name does not function.

4 SYSTEM/TV mode switch

- In TV mode (When setting the SYSTEM/TV selector to TV.)**
- Only MUTING, MASTER VOL +/- and the operative buttons in TV section on the list described on the next page can be used.

Operating with the Remote Commander

Before operating the equipments with the remote commander, be sure to set the receiver to the desired mode by pressing one of the FUNCTION buttons.

The FUNCTION buttons are factory set in the following list.

FUNCTION to be pressed	Operating equipment
DAT	DAT
CD	CD player
TUNER	Tuner
PHONO	(The receiver enters the PHONO mode.)
VIDEO 1	Betamax VCRs
VIDEO 2	LD player
VIDEO 3	8 mm VCRs
TAPE	Tape deck A

- When VIDEO 1, 2 or 3 is pressed, the power of the selected video equipment and TV is turned on.

Operating the equipment

- 1 Press the desired FUNCTION.
- 2 Press ◀ (only for tape deck) or ▶ to start playback.

Changing the settings of the FUNCTION Buttons

With the SELECT button, you can replace the functions stored in the FUNCTION buttons.

To change the settings of the FUNCTION buttons

- 1 Press one of the FUNCTION buttons to be stored.
- 2 Press SELECT.
- 3 Press the 1 to 9 button to select the desired function within 30 seconds.
- 4 Press ENTER.

To operate other unit temporarily without changing the settings of FUNCTION

- 1 Press SELECT.
- 2 Press the 1 to 9 button to select the function.
- 3 Press the desired button.

After operating the unit, the receiver enters the previous mode.

Operative buttons: POWER, ◀▶, ◀▶▶, ■, ◀▶, ■, ●REC, D.SKIP, TV/VIDEO, ANT TV/VTR, CH/PRESET +/-, SHIFT, INDEX.

Example:

To record the program source in DECK A in the CD mode

- 1 Press SELECT.
- 2 Press 3 (DECK A).
- 3 While pressing ●, press REV or FWD.

After operating DECK A, the receiver enters the CD mode automatically.

List of operative buttons in SYSTEM mode (When setting the SYSTEM/TV selector to SYSTEM)

Operating equipment	TUNER	CD	DAT	DECK A, B	TV	LDP	VTR 1, 2, 3
1	•	•	•	—	•	•	•
2	•	•	•	—	•	•	•
3	•	•	•	—	•	•	•
4	•	•	•	—	•	•	•
5	•	•	•	—	•	•	•
6	•	•	•	—	•	•	•
7	•	•	•	—	•	•	•
8	•	•	•	—	•	•	•
9	•	•	•	—	•	•	•
0	•	—	—	—	•	•	•
	—	—	—	—	—	—	—
ENTER	—	—	—	—	•	—	•
SHIFT	•	—	—	—	—	—	—
TV/VIDEO	—	—	—	—	•	*	*
ANT TV/VTR	—	—	—	—	—	—	•
CH PRESET +/-	•	—	—	—	•	—	•
INDEX	•	—	—	—	—	—	—
D.SKIP	—	•	—	—	—	—	—
▶▶	—	•	•	•	—	•	•
◀◀	—	•	•	•	—	•	•
▶◀	—	•	•	—	—	•	—
◀▶	—	•	•	—	—	•	—
REV or ◀+●	—	—	—	•	—	—	—
FWD or ▶+●	—	—	•	•	—	—	•
■	—	•	•	•	—	•	•
▶	—	•	•	•	—	•	•
◀	—	•	•	•	—	•	•
■	—	•	•	•	—	•	•

- : The button is operative.
- : The button is not operative.
- *: The button can operate TV and the VCR connected to TV.

Note

To operate the unit correctly, the function mode of the receiver should be same with that of the remote commander. So, be sure to press the desired FUNCTION button at first and then the operative button.

Audio Adjustment

For getting the optimum sound, you can adjust volume and sound quality using the functions below.

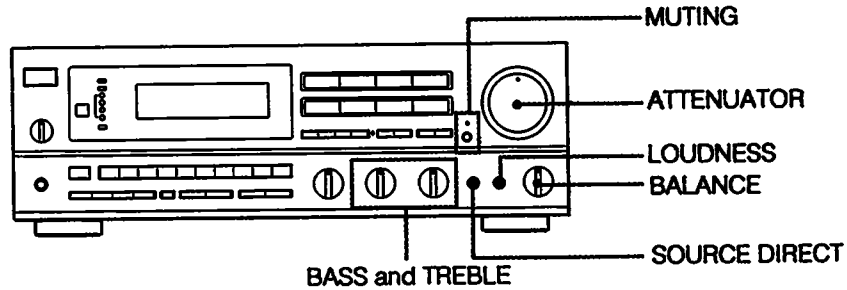

Volume Adjustment

To adjust volume
Turn ATTENUATOR.



To reduce the sound to a low level temporarily (-20 dB attenuation)
Press MUTING.
Press again to restore the same listening level as before.



Balance Adjustment

To change the relative strength of the right and left speaker output
Adjust BALANCE to correct stereo imaging, when the speaker position is not symmetrical.



Sound Quality Adjustment

To adjust the tone quality
Adjust BASS or TREBLE for the optimum sound.

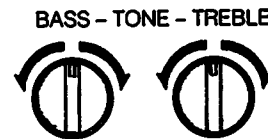

To reinforce the bass frequency response
Press LOUDNESS.
The lower the speaker output level is, the more bass frequency sound is emphasized.

LOUDNESS



To bypass the tone control and surround circuit
Press SOURCE DIRECT.
BASS and TREBLE tone controls and surround are bypassed.

SOURCE DIRECT



Receiving FM/AM Broadcasts

Tuning in an FM Station Automatically — Automatic Tuning

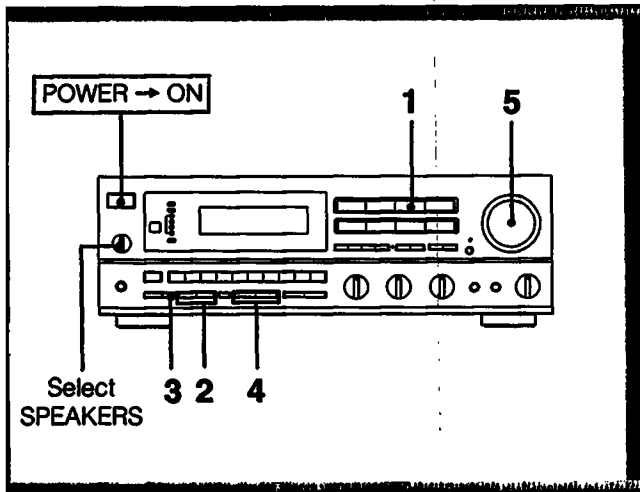

1 Press TUNER.

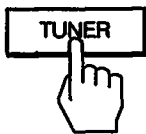

2 Select FM.

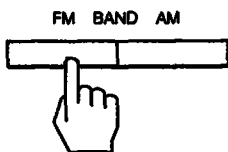

3 Press FM TUNE MODE (For FM only).

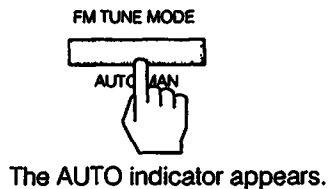

4 Press TUNING - or +.

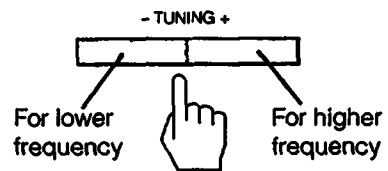

When a station is received, automatic tuning stops.

5 Adjust the volume.



When a station is received, automatic tuning stops.

The signal strength is weak.

To stop sweeping, press FM TUNE MODE again. AUTO indicator disappears and automatic tuning stops. Then tune in the station as described in "Manual Tuning".

When an FM stereo program is noisy or hard to receive

Press FM MODE. The MONO indicator appears (the sound is heard in monaural, but the reception will be improved).

To return to the stereo mode, press the button again.

Receiving FM/AM Broadcasts

Tuning in an FM/AM Station Manually — Manual Tuning

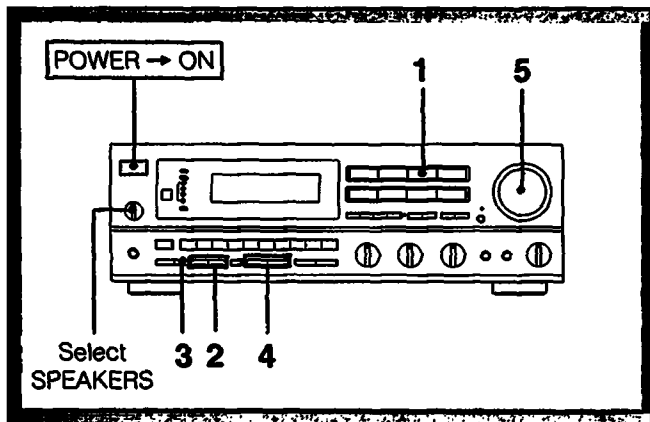

1 Press TUNER.

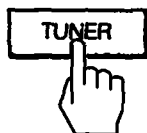

2 Select FM.

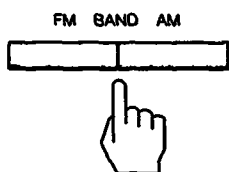

3 Press FM TUNE MODE (For FM only).

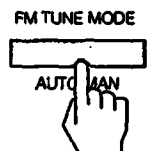

The AUTO indicator disappears.

4 Press TUNING - or +.

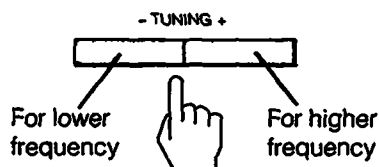

5 Adjust the volume.



Memorizing a Station

A total of 30 FM/AM stations can be memorized in any desired sequence.

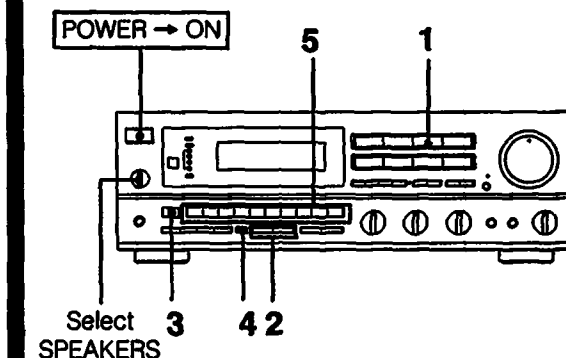

1 Press TUNER.

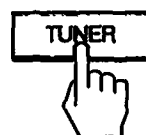

2 Tune in the desired station.

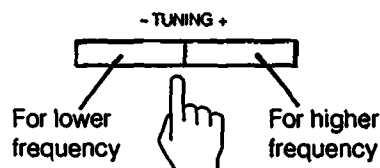

3 Select the memory page (A, B, and C).



4 Press MEMORY so that the MEMORY indicator lights up.



5 While the MEMORY indicator is on, press the desired number.

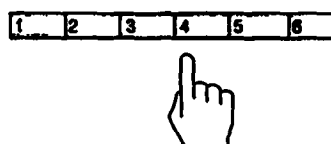

Tuning in a Preset Station

Method A: Direct tuning

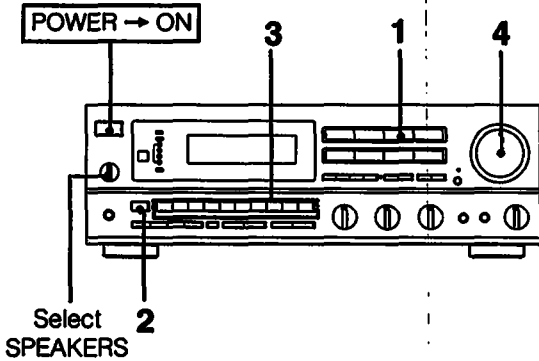

1 Press TUNER.

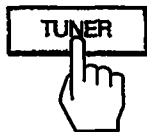

2 Select the page.



3 Select the number with the numeric button.

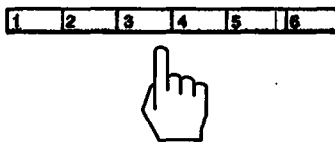

4 Adjust the volume.



Method B: Scan tuning

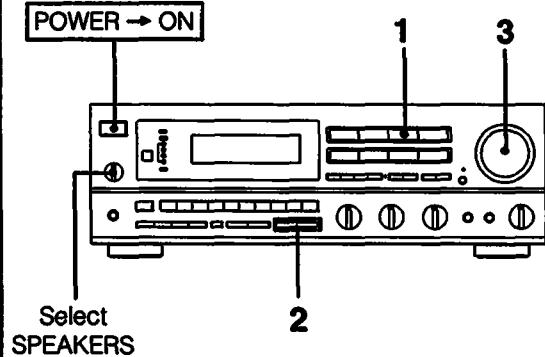

1 Press TUNER.

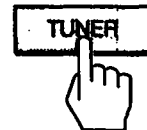

2 Press PRESET TUNING - or +.

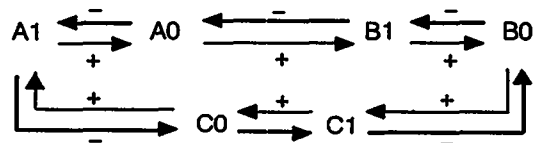
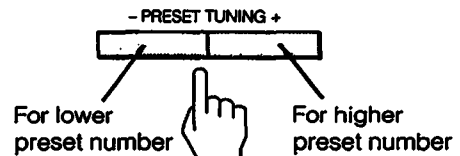

3 Adjust the volume.



Replacing a preset station

Preset another station on the number of the station to be replaced. The previously preset station will be erased.

IMPORTANT

The memorized station is maintained for approximately one month even if the power cord is disconnected from the AC power source. If they are erased, store the stations again.

Listening to Program Source other than Broadcasts

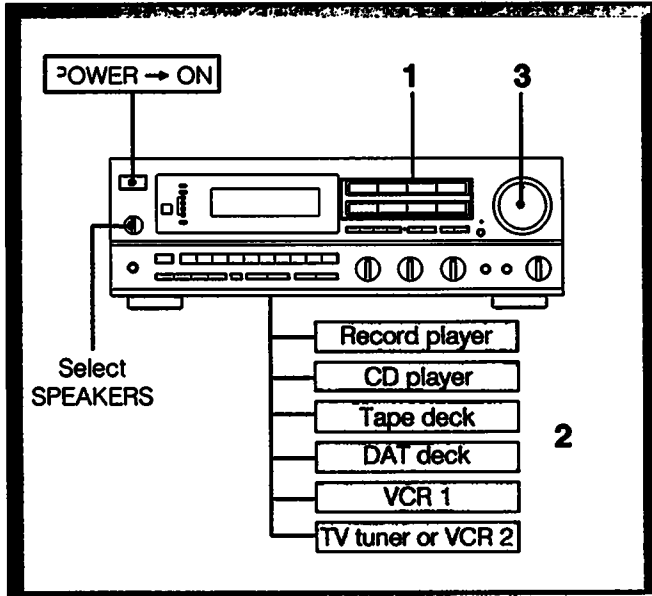

3 Adjust the volume.



Note on TAPE MONITOR button

The TAPE MONITOR button has priority over other function selectors. Be sure to release the TAPE MONITOR button except when listening to taped program. Otherwise, the program source selected with the function selector cannot be heard.

1 Select the program source.

	FUNCTION
Record player	PHONO
Compact disc	CD
Video programs	VIDEO 1 or VIDEO 2
Taped programs	TAPE or TAPE MONITOR
DAT programs	DAT

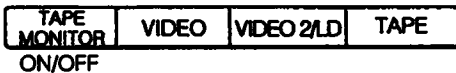
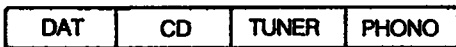

2 Start the program.

Recording on an Audio Tape

Recording

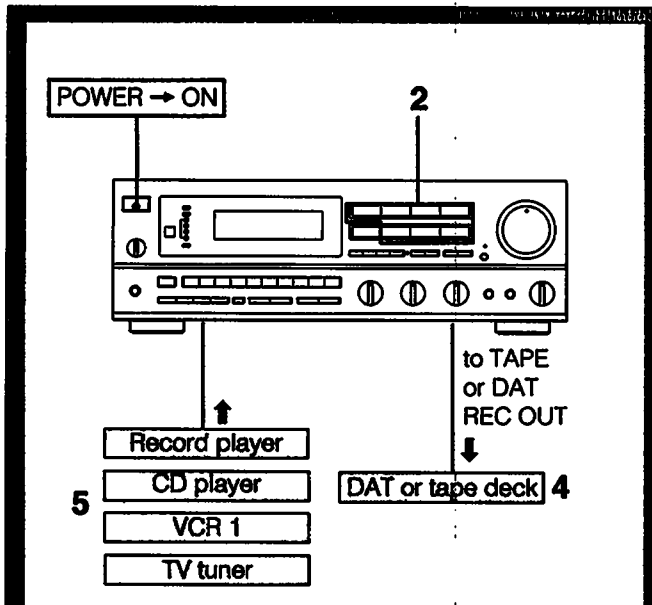

- 1** Turn on the receiver and the equipment to be used.
- 2** Select the desired program source.
- 3** For an FM/AM broadcast, tune in the desired station.
- 4** Set the DAT or tape deck in the recording mode.
- 5** Start the desired program source.

To monitor recorded sound while recording

If a tape recorder with three-head system is connected to TAPE MONITOR jacks, recorded sound can be monitored. Select recording tape recorder using the TAPE MONITOR button. The recorded sound is immediately fed back to the amplifier and output to the speakers.

Note on recording

The setting of the volume, BASS, TREBLE, BALANCE and surround effect controls do not have any effect on recording.

Tape Dubbing

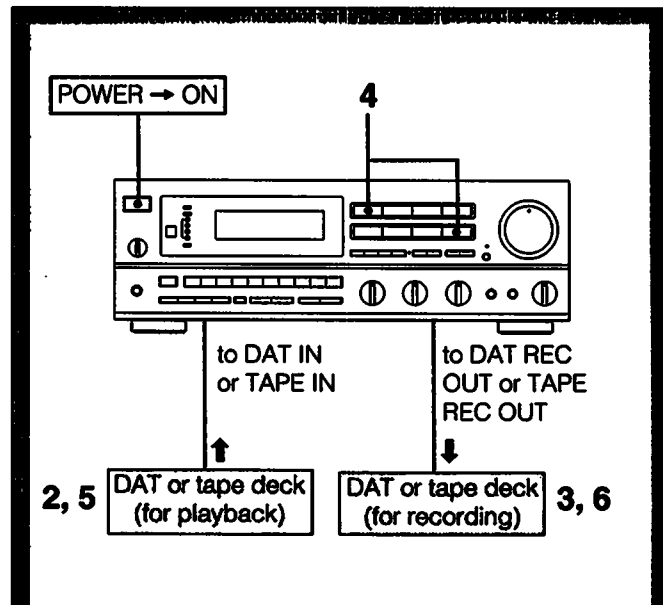

- 1** Turn on the receiver and the equipment to be used.
- 2** Insert the recorded tape into deck connected to the TAPE jacks or DAT jacks.
- 3** Insert a blank tape into the DAT deck or the tape deck for recording and adjust the recording level.
- 4** Press TAPE or DAT to be played.
- 5** Start the playback of the tape deck or the DAT deck.
- 6** Set the DAT deck or the tape deck for recording in the recording mode.

Recording on a VCR

Recording TV Programs

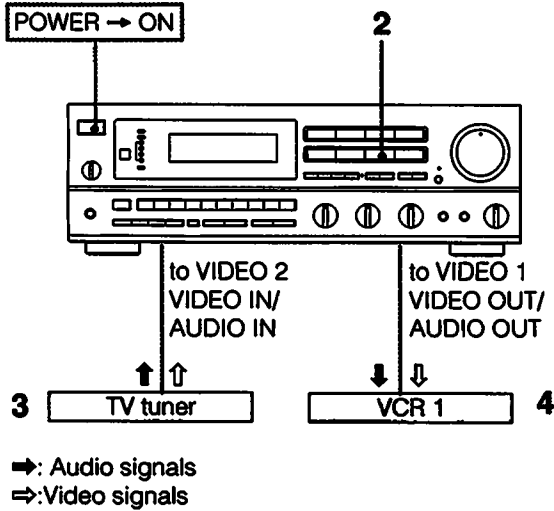

To record the picture and the sound of a TV program, proceed as follows:

- 1** Turn on the receiver and the equipment to be used.
- 2** Press VIDEO 2/LD.
- 3** Select the desired program on the TV tuner.
- 4** Set the VCR 1 to the recording mode.

Note
You cannot record on a VCR connected to VIDEO 2 inputs.

Video Tape Editing

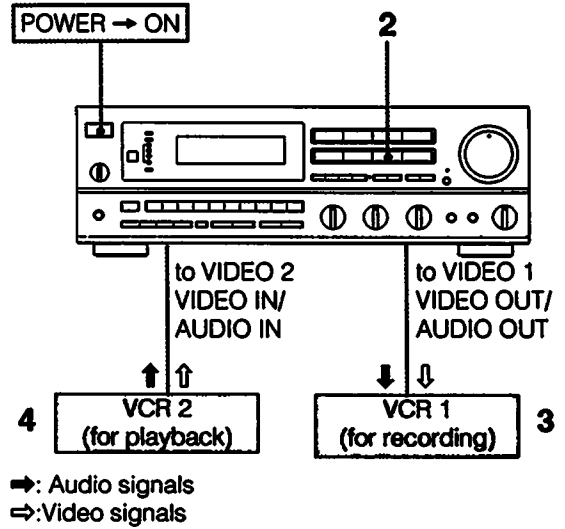

- 1** Turn on the receiver and the equipment to be used.
- 2** Press VIDEO 2/LD
- 3** Set the VCR 1 to the recording mode.
- 4** Set the VCR 2 to the playback mode.

Note
You cannot record on a VCR connected to VIDEO 2 inputs.

Obtaining the Surround Effect

Available Types of Effects

How to place speakers

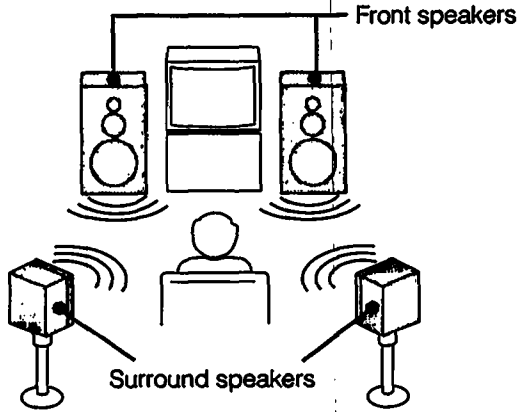

HALL: Provides reverberation effect that is produced in a concert hall.

SIMULATED: Gives a simulated stereo effect to monaural sound.

DOLBY PRO LOGIC: The STR-GX69ES and STR-GX59ES incorporate the Dolby Pro Logic Surround Decoder which has the same functions for playback, such as movie theaters and gives a theater-like experience in your listening room, naturally reproducing the audio sound field.

Placement of Speakers for DOLBY PRO LOGIC Mode

NORMAL mode

When connecting smaller speaker than front speakers, such as that of TV for a center speaker.

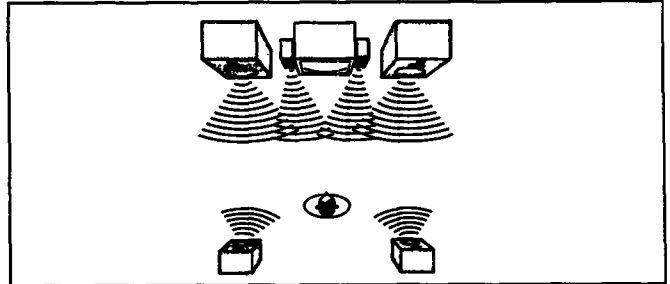

WIDE mode

When connecting the same size of speaker as front speakers for a center speaker.

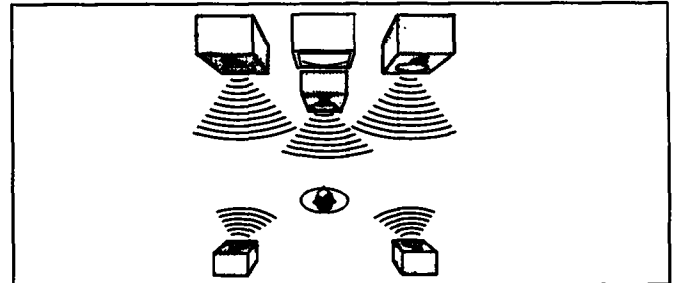

PHANTOM mode

When connecting only front and rear speakers.

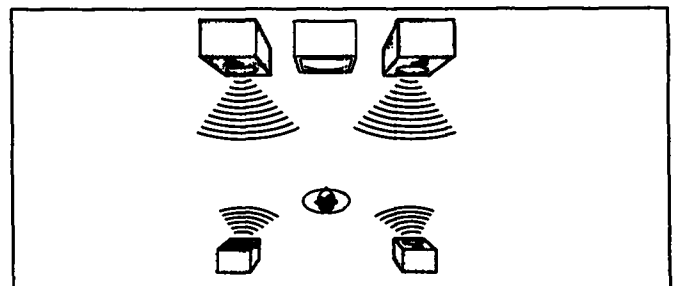

3CH mode

When connecting front speakers and a center speaker.

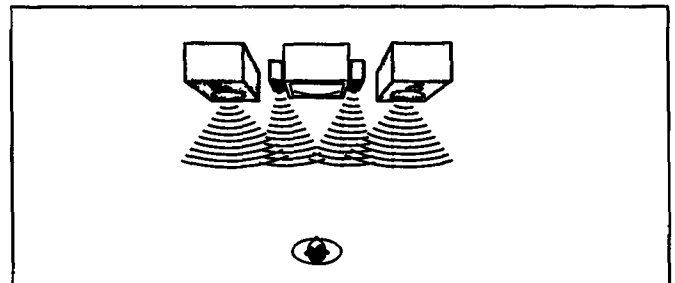

Center off mode (when no indicator of DOLBY PRO LOGIC mode lights up.)

Set the receiver to this mode when adjusting INPUT BALANCE to obtain the best Dolby surround effect with defeating the sound from a center speaker.

Obtaining the Surround Effect

Adjusting the Input Level for Dolby Surround System

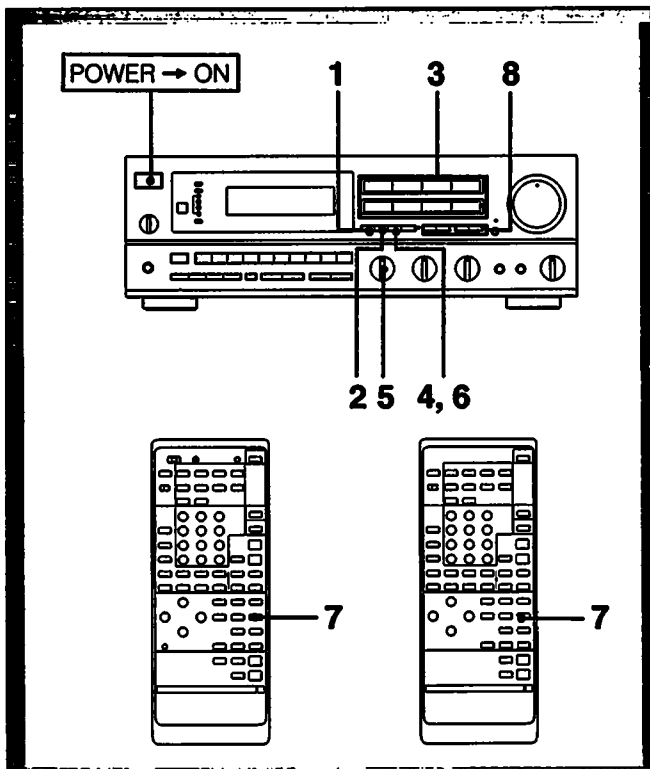

1 Press SURROUND ON/OFF to ON.

2 Press SURROUND MODE so that the HALL or SIMULATED indicator disappears from the display.

3 Select a program source with the FUNCTION selector and start playback.

4 Press the PRO LOGIC MODE button so that no indicator of DOLBY PRO LOGIC mode lights up.

5 When the INPUT BALANCE control is set to the center position and the AUTO INPUT BALANCE indicator lights, the input balance is adjusted automatically, but if you want to adjust it manually, turn the INPUT BALANCE control until the monaural sound, such as a dialogue, heard from the surround speakers is minimized.

6 Select the DOLBY PRO LOGIC MODE according to your speaker system with the PRO LOGIC MODE button.

7 Press the T (Test) TONE button on the remote commander. A test tone (pink noise) signal is sent in succession to each speaker.

8 Adjust the level of rear speakers with the SURROUND LEVEL REAR +/- buttons and the center speaker volume with the SURROUND LEVEL CENTER +/- buttons, so that sound from each speaker is heard in the same volume level at the listening position. (When adjusting the VOLUME control on the receiver, all speakers is adjusted simultaneously.)

Listening with Surround Effect

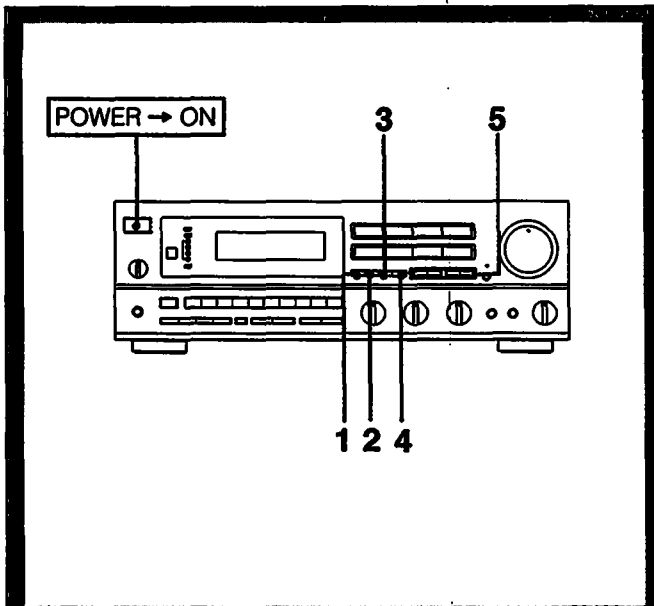

- 1** Press **SURROUND ON/OFF**, so that **SURROUND ON** appears in the display window.
- 2** Press **SURROUND MODE** and select the desired mode, **HALL**, **SIMULATED**, **DOLBY**.
- 3** If you select **DOLBY** on step 2, press **PRO LOGIC MODE** button, and select the desired mode.
- 4** Adjust delay time by pressing the **DELAY** button.
- 5** Adjust the surround speaker level by pressing the **SURROUND LEVEL CENTER** or **REAR +/-** buttons.

To turn off the surround effect

Press **SURROUND ON/OFF** again.

The normal sound without surround effect will resume.

Storing Other Manufacture's Operating Codes onto the Supplied Remote Commander

Programming Signals of Other Audio/Video Equipment (RM-P321 only)

The RM-P321 learns various functions of other remote commanders emitting infrared rays and allows you to control most of audio and video equipment from a distance.

When you manipulate a switch or button on the commander, be sure to point the head of the commander toward the remote control sensor on the front of the receiver. If there is an obstacle between the receiver and the head of the commander, the receiver may not be controlled remotely.

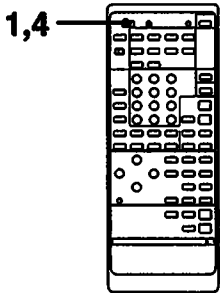

1 Set the mode selector to LEARN.

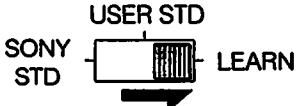

2 Program a signal.
The programmable buttons are changed according to the function mode. See the list of operative buttons on page 13.

① Press and hold the button which shall "learn" the remote-control signal until the LEARN indicator lights up.

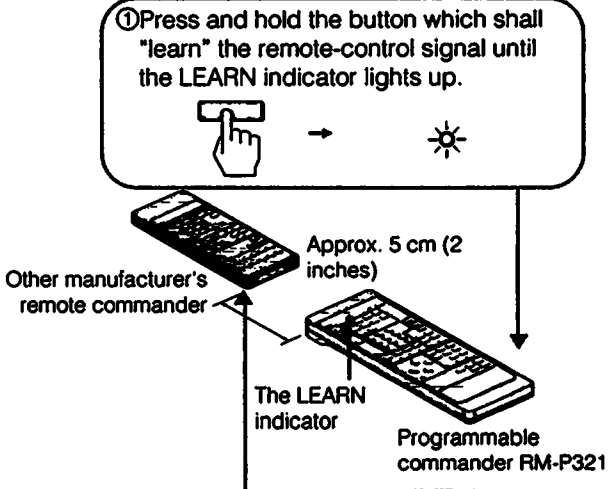

② Press and hold the button of other manufacturer's remote commander whose signal is to be learned.

③ Remove your finger(s) from the button(s) after the LEARN indicator goes off.



All buttons of enclosed as number 2 on the left illustration can be programmable.

3 Repeat operation for each button to be programmed.

4 Set the mode selector to USER STD or SONY STD.

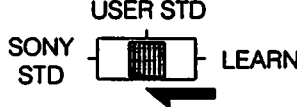

The two remote commanders must:

- face straight each other.
- be placed at a distance of approx. 5 cm (2 inches).
- not be moved during programming operation.

After programming

Be sure to test if the equipment really works with the programmed signals.

Number of signals that the commander can learn

It depends on the format of the signal. If you program signals of Sony equipment, approximately 50 - 60 signals can be programmed.

Memory capacity

If the LEARN indicator flashes or does not go out in step 2-②, ③, the memory capacity has become full. This occurs when other signals stronger than the remote-control signals have been stored because the signals were programmed in a noisy environment or the remote commanders were placed too far apart from each other.

In this case, clear all the signals following the procedure described below and program again from the beginning under the proper conditions.

Notes on programming

- Remote-control signals of equipment of manufacturers other than Sony can be programmed only when they are compatible with the infrared wireless remote control system. Since the programmable commander can "learn" only the signals output from another remote commander, it cannot control equipment that does not use a remote commander.
- Do not attempt to use the programmable commander with an air conditioner or other household appliances.
- Note that there are some special remote-control signals that cannot be programmed.

Programming a new signal onto a previously programmed button

Follow the programming procedure.

The previously programmed signal is cleared and replaced by the new signal.

To clear all programmed signals

- 1 Set the mode selector to LEARN.
- 2 Press and hold any button of the programmable area until the LEARN indicator lights up.
- 3 Press PROGRAM CLEAR until the LEARN indicator flashes and goes off.

Note

It is not possible to clear the programmed content of just one button.

To program a signal onto the ● REC button

It is not possible to operate any equipment with only the ● REC button. To program a signal under the ● REC button, press and hold the following buttons at the same time in step 2-①.

Controlling Equipment

By switching the mode selector as shown below, a single button alternately controls Sony equipment and another manufacturer equipment.

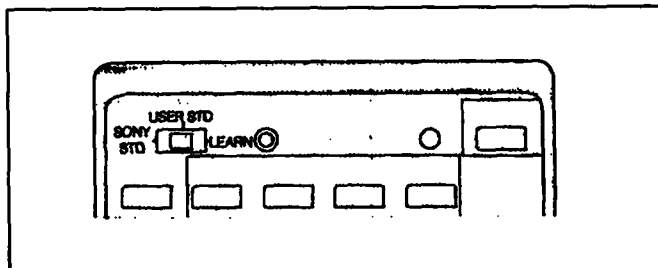

To control Sony equipment

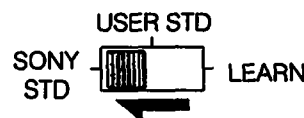

To control equipment with programmed signals



When Sony equipment cannot be remote-controlled

Program the signal in the same way as for equipment from other manufacturers. In this case, even with Sony equipment, set the mode selector to USER STD.

Notes on Battery

If the LEARN indicator does not light when a button is pressed, the batteries are almost exhausted. When the batteries are exhausted, the remote commander can no longer operate the unit or programming becomes impossible.

If this happens, replace both batteries with new ones. We recommend the use of alkaline batteries for prolonged use.

If no signal has been programmed

The programmable commander can control Sony equipment even when the mode selector is set to USER STD.

If the equipment works incorrectly

Press RESET.

The programmed contents of the buttons are not cleared by pressing RESET.

Troubleshooting

Before proceeding through the check list below, examine the connections and the procedures outlined the manual.
Should any problem persist after you have checked the following items, consult your nearest Sony dealer.

Problem	Cause	Remedy
Sound is not heard.	The TAPE MONITOR jacks are not in use and the TAPE MONITOR button is pressed to ON.	Press the TAPE MONITOR button to set to OFF.
	The ADAPTOR jacks or the FRONT jacks are not in use and the short plugs are not inserted.	Insert the short plugs to the ADAPTOR jacks or the FRONT jacks.
	The PRE OUT and POWER IN jacks are not in use and the short plugs are not inserted.	Insert the short plugs to the PRE OUT and POWER IN jacks.
	The speaker or program source equipment is not connected correctly.	Connect the equipment correctly. (See pages 6 and 7.)
	The correct speakers are not selected with SPEAKERS selector.	Set the SPEAKERS selector correctly.
	The correct function selector is not pressed.	Press the correct function selector.
	The volume is set to minimum.	Increase the volume.
Surround effect cannot be obtained. Surround effect cannot be adjusted.	The SURROUND ON/OFF button is set to OFF.	Press the SURROUND ON/OFF button to set to ON.
	The SOURCE DIRECT button is set on.	Set the SOURCE DIRECT button off.
One channel does not transmit audio, or the volume from the left and right speakers is unbalanced.	The BALANCE control is not set appropriately.	Adjust the BALANCE control.
	The speaker or program source is not connected correctly.	Connect the equipment correctly. (See pages 6 and 7.)
There is an abrupt loss of sound from one or both of the speakers, and the PROTECTOR indicator flickers in the display window.	A short-circuit problem activates the protective circuit.	Turn off the receiver, eliminate the short-circuit problem and turn on the power again. If there is no short-circuit, consult your nearest Sony dealer.
	The SPEAKER IMPEDANCE SELECTOR on the rear is not set correctly.	Set the SPEAKER IMPEDANCE SELECTOR correctly.
Sound transmitted from the speakers is reversed.	The speakers are not connected correctly.	Connect the right speaker to the R SPEAKER terminals and the left speaker to the L SPEAKER terminals.
There is lack of bass sound or the instrument position is obscure.	The +/- connection of the speaker is reversed.	Connect the speaker with the correct phase.

	Problem	Cause	Remedy
Amplifier	Severe hum or noise is heard.	The connecting cords are not of shielded type.	Use shielded type cords.
		A transformer, motor, TV or fluorescent light affects the connecting cord.	Place the connecting cords in a location away from a transformer or motor, and at least 3 meters (10 feet) from a TV set or a fluorescent light.
		The audio components are too close to a TV set.	If both are used at the same time, separate the TV from the audio components.
		The receiver is not grounded.	Connect the ground wire to the antenna ground terminal.
		The connections are loose.	Secure the connections.
		The plugs and jacks are dirty.	Wipe the plugs and jacks with a cloth lightly dampened with alcohol.
Broadcast program	STEREO indicator flickers or does not appear when receiving stereo programs.	A very weak FM station or a noisy FM program is received.	Adjust the antenna or connect an external FM antenna. Press the FM MODE button to disengage the stereo mode.
	The desired station cannot be found during Automatic Tuning.	The signal strength is too weak for Automatic Tuning.	Adjust the antenna.
			Tune in the station with the Manual Tuning system. (See page 16.)
Preset stations cannot be tuned in.	The stations have not been memorized.	Memorize the stations. (See page 16.)	
AM station cannot be tuned in.	The AM tuning interval is set incorrectly.	Change the tuning interval according to the AM frequency allocation system of your country. (See page 5.)	
Video program	Picture does not appear.	VCR, TV tuner or TV connection is not correct.	Connect the equipment correctly. (See page 7.)
		The TV is not turned on.	Turn the TV on.
Remote Commander	The remote commander does not operate.	The batteries are exhausted.	Replace the batteries with new ones.
		There is any object between the unit and the commander head.	Remove the object.

Specifications

Audio Power Specifications

POWER OUTPUT AND TOTAL HARMONIC DISTORTION

With 8-ohm load, both channels driven, from 20 - 20,000 Hz, rated 100 watts (STR-GX69ES) or 80 watts (STR-GX59ES) per channel minimum RMS power, with no more than 0.08% total harmonic distortion from 250 milliwatts to rated output.

With 4-ohm load, both channels driven, from 20 - 20,000 Hz, rated 100 watts (STR-GX69ES) or 80 watts (STR-GX59ES) per channel minimum RMS power, with no more than 0.08% total harmonic distortion from 250 milliwatts to rated output.

Other Specifications

Amplifier section

Dynamic power output STR-GX69ES:
 155 watts + 155 watts
 (8 ohms, at 1 kHz IHF)
 240 watts + 240 watts
 (4 ohms, at 1 kHz IHF)
 275 watts + 275 watts
 (2 ohms, at 1 kHz IHF)
 STR-GX59ES:
 115 watts + 115 watts
 (8 ohms, at 1 kHz IHF)
 170 watts + 170 watts
 (4 ohms, at 1 kHz IHF)
 220 watts + 220 watts
 (2 ohms, at 1 kHz IHF)

Power output of center amplifier

STR-GX69ES:
 50 watts: 25 watts + 25 watts
 (8 ohms at 1 kHz)
 STR-GX59ES:
 30 watts: 15 watts + 15 watts
 (8 ohms at 1 kHz)

Power output of rear amplifier

STR-GX69ES:
 25 watts + 25 watts
 (8 ohms at 1 kHz)
 STR-GX59ES:
 15 watts + 15 watts
 (8 ohms at 1 kHz)

Inputs

	Sensitivity	Impedance	S/N (weighting network, input level)
PHONO	2.5 mV	50 kilohms	87 dB 79 dB* (A, 2.5 mV)
CD, VIDEO (1), 2 TAPE, DAT TAPE MONITOR	250 mV	50 kilohms	105 dB 86 dB* (A, 150 mV)

* '78 IHF

Outputs

VIDEO (1) AUDIO OUT
 REC OUT
 Voltage 250 mV
 Impedance 10 kilohms
 SPEAKER A, B
 Accepts speakers of 4 - 16 ohms
 HEADPHONES
 Accepts low and high impedance headphones.
 CENTER OUT, REAR OUT
 2.5 V, 1 kilohm
 PRE OUT
 1 V, 1kilohm
 VIDEO 1, 2: 1 Vp-p, 75 ohms
 VIDEO 1, MONITOR: 1 Vp-p, 75 ohms
 BASS: ±8 dB at 100 Hz
 TREBLE: ±8 dB at 10 kHz
 -20 dB

Video inputs
 Video outputs

Tone controls

Muting

FM/AM tuner section

	FM tuner section	AM tuner section
Tuning	87.5 — 108 MHz	530 — 1,710 kHz (with the AM tuning interval set at 10 kHz) 531 — 1,710 kHz (with the AM tuning interval set at 9 kHz)
Antenna	300 ohms, balanced 75 ohms, unbalanced	External antenna terminal, loop antenna
Intermediate frequency	10.7 MHz	450 kHz
Sensitivity at 50 dB quieting	18.3 dBf, 4.5 μ V (mono) 38.3 dBf, 45 μ V (stereo)	—
Minimum detectable sensitivity	11.2 dBf, 2 μ V (IHF)	Loop antenna: 50 dB/m (at 1,000 kHz) External antenna: 100 μ V (at 1,000 kHz)
Signal-to-noise ratio	82 dB (mono) 76 dB (stereo)	54 dB (at 50 mV/m)
Harmonic distortion	0.1% (mono), 0.2% (stereo) at 1 kHz	0.3% (at 50 mV/m, 400 Hz)
Selectivity	60 dB at 400 kHz	40 dB at 10 kHz 35 dB at 9 kHz
Rejection	45 dB at 1 kHz	
Frequency response	30 Hz — 15 kHz +0.5 dB -1.5 dB	
THD distortion	0.1% (mono) 0.2% (stereo)	
Capture ratio	1.2 dB	
AM suppression ratio	54 dB	
Image response ratio	80 dB	
Intermodulation response ratio	90 dB	
Adjacent channel response ratio	100 dB	
AM modulation	65 dB (800 kHz)	
Auto tuning threshold	30 dBf	

General System

NF

Power requirements
Power consumption

AC outlets
Dimensions

Weight

Accessories supplied

Tuner section: PLL quartz-locked digital synthesizer system
 Preamp section: low-noise type equalizer amp
 Power amplifier section: pure-complementary SEPP
 120 V AC, 60 Hz
 STR-GX69ES:
 USA model: 250 watts
 Canadian model: 540 VA
 STR-GX59ES:
 USA model: 230 watts
 Canadian model: 310 VA
 Two switched (total 120 W/1 A)
 Approx. 430 x 150 x 375 mm (w/h/d)
 (17 x 5 ⁷/₈ x 14 ³/₄ inches) including projecting parts and controls
 STR-GX69ES:
 Approx. 13.5kg (29 lb 13 oz)
 STR-GX59ES:
 Approx. 12.5kg (27 lb 9 oz)
 FM wire antenna (1)
 AM loop antenna (1)
 Remote Commander (1)
 RM-P321(STR-GX69ES)
 RM-U221(STR-GX59ES)
 Sony batteries SUM-3(NS)
 (for the remote commander) (2)

Design and specifications are subject to change without notice.

Quick Reference

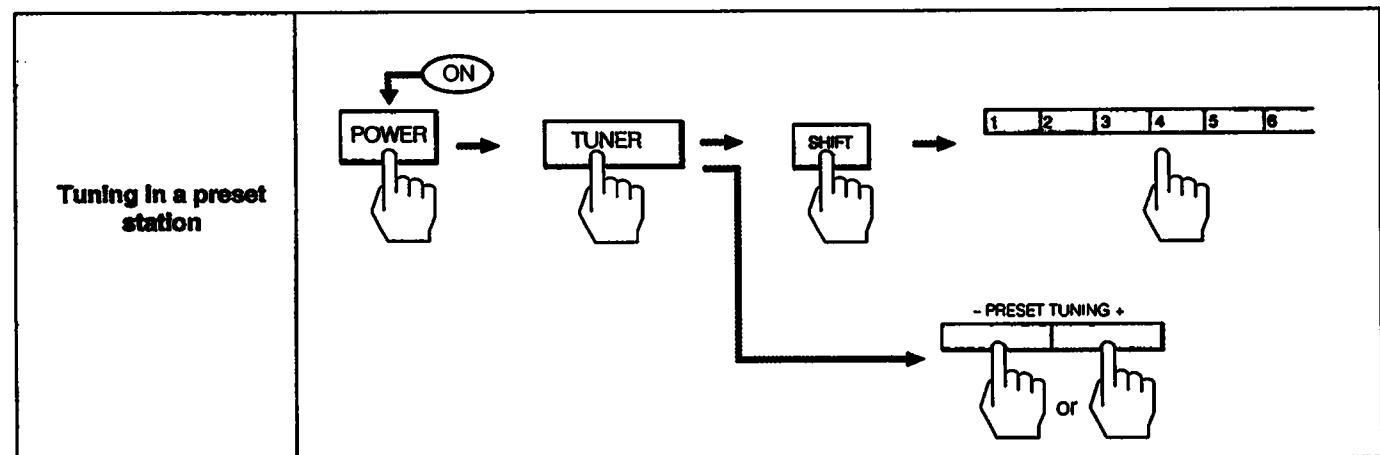
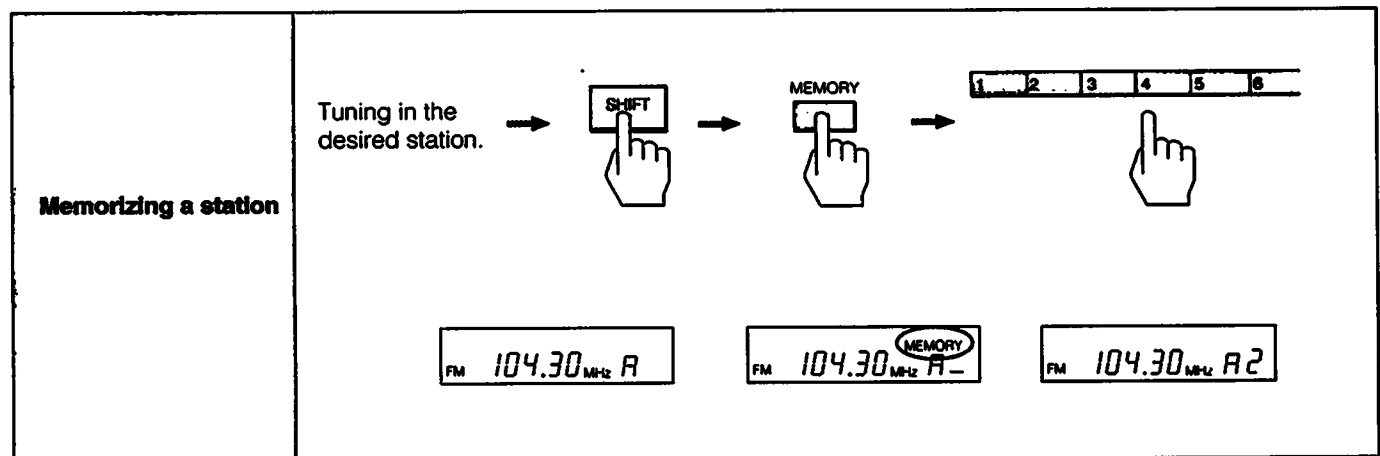
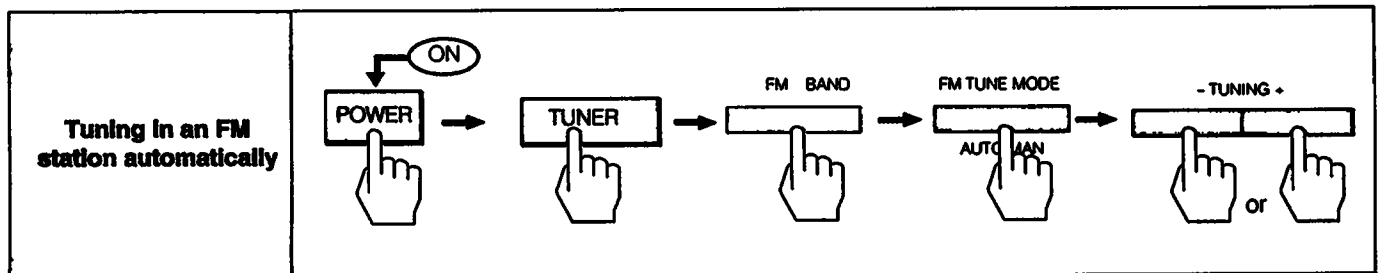
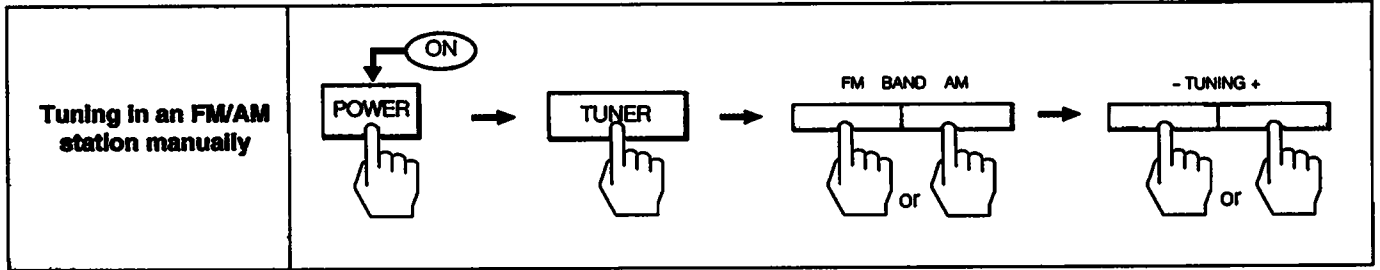

Remote Commander Operations

To change the settings of FUNCTION SYSTEM ON

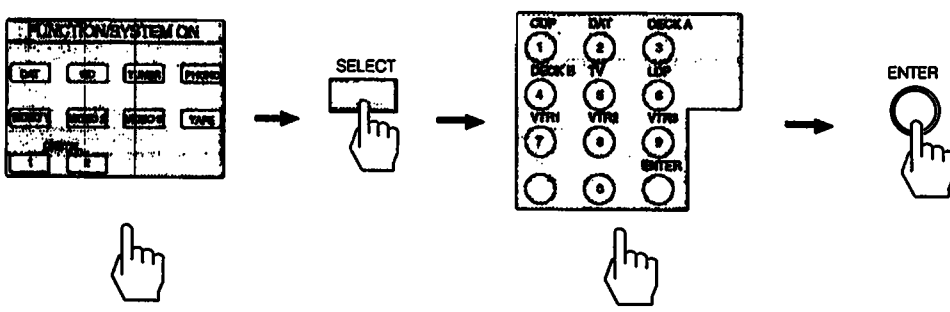

Press the number (1 to 9).

To operate other unit temporarily without changing the settings of FUNCTION SYSTEM ON

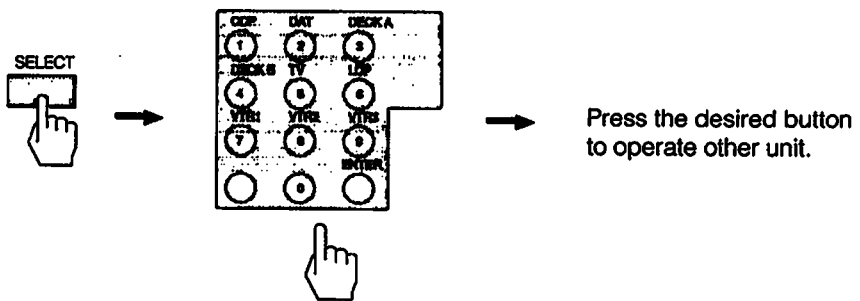

Press the desired button to operate other unit.

Press the number (1 to 9).

Free Manuals Download Website

<http://myh66.com>

<http://usermanuals.us>

<http://www.somanuals.com>

<http://www.4manuals.cc>

<http://www.manual-lib.com>

<http://www.404manual.com>

<http://www.luxmanual.com>

<http://aubethermostatmanual.com>

Golf course search by state

<http://golfingnear.com>

Email search by domain

<http://emailbydomain.com>

Auto manuals search

<http://auto.somanuals.com>

TV manuals search

<http://tv.somanuals.com>