

Stereo Cassette Deck

Operating Instructions

TC-K620

PROPERTY OF THE
NATIONAL TECHNICAL DEPT.

FILE COPY

Do not remove

WARNING

To prevent fire or shock hazard, do not expose the unit to rain or moisture.

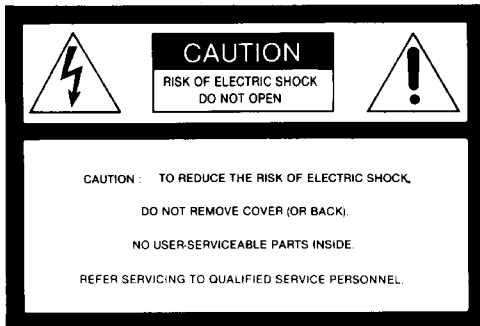

This symbol is intended to alert the user to the presence of uninsulated "dangerous voltage" within the product's enclosure that may be of sufficient magnitude to constitute a risk of electric shock to persons.



This symbol is intended to alert the user to the presence of important operating and maintenance (servicing) instructions in the literature accompanying the appliance.

*The graphical symbols are on the rear enclosure.

INFORMATION

This equipment generates and uses radio frequency energy and if not installed and used properly, that is, in strict accordance with the manufacturer's instructions, may cause interference to radio and television reception. It has been type tested and found to comply with the limits for a Class B computing device in accordance with the specifications in Subpart J of Part 15 of FCC Rules, which are designed to provide reasonable protection against such interference in a residential installation. However, there is no guarantee that interference will not occur in a particular installation. If this equipment does cause interference to radio or television reception, which can be determined by turning the equipment off and on, the user is encouraged to try to correct the interference by one or more of the following measures:

Reorient the receiving antenna

Relocate the equipment with respect to the receiver

Move the equipment away from the receiver

Plug the equipment into a different outlet so that equipment and receiver are on different branch circuits.

If necessary, the user should consult the dealer or an experienced radio/television technician for additional suggestions. The user may find the following booklet prepared by the Federal Communications Commission helpful:

"How to Identify and Resolve Radio-TV Interference Problems".

This booklet is available from the U.S. Government Printing Office, Washington, DC 20402, Stock No. 004-000-00345-4.

Owner's Record

The model and serial numbers are located at the rear. Record the serial number in the space provided below. Refer to these numbers whenever you call upon your Sony dealer regarding this product.

Model No. TC-K620 Serial No. _____

Table of Contents

Getting started

Features	3
Precautions	3
Installation	4
Connections	4
Identification of front panel parts	5

Playback

Playing back	6
Locating a selection	
— Automatic Music Sensor(AMS)	7
Playing back automatically after rewinding	
— Auto play	8
Notes on cassettes	8
Locating a desired position using the counter	
— Memory play	8
The Accuracy of the digital linear counter	8

Recording

Recording	9
Adjusting the Recording Level	10
Making an optimum recording according to the tape type — Bias Adjustment	10
Monitoring the recorded sound	10
What is the Dolby HX PRO system?	11
Inserting a blank space during recording	
— Record muting	11

Using with a Timer

Timer-activated playback and recording	12
--	----

Maintenance	12
Specifications	13
Troubleshooting guide	14

Features

- **Three-head system (separate recording, playback and erase heads)** which allows you to instantly check the recorded sound while recording is in progress.
- **Bias control** to achieve the optimum bias current setting for any tape.
- **The Dolby HX PRO* system** which improves the linearity of the tape's high-range response during recording.
- **Easy-to-read digital linear counter** which shows the elapsed recording or playing time.
- **The AMS function** which provides easy access to a desired selection.

*Dolby noise reduction and HX Pro headroom extension manufactured under license from Dolby Laboratories Licensing Corporation. HX Pro originated by Bang & Olufsen. "DOLBY", the double-D symbol  and "HX PRO" are trademarks of Dolby Laboratories Licensing Corporation.

Precautions

On safety

- Operate the unit only on 120 V AC, 60Hz.
- Should anything fall into the cabinet, unplug the unit and have it checked by qualified personnel before operating it any further.
- Unplug the unit from the wall outlet if it will not be used for a long time. To disconnect the cord, pull it out by grasping the plug. Never pull the cord itself.

On operation

- When the unit is not used, turn the power off to conserve energy and to extend the useful life of your unit.
- Because of a safety mechanism, the function buttons will not operate if the cassette holder is not completely closed, if there is no cassette in the cassette holder, or if the cassette has been incorrectly inserted into the cassette holder

On head cleaning

The head and tape path should be cleaned after every 10 hours of operation. Dirty heads and a dirty tape path may cause:

- loss of high-frequency response
- loss of sound volume
- sound drop-out

Note on cassettes longer than 90 minutes

The use of cassettes longer than 90 minutes is not recommended except for long continuous playback.

For detailed safety precautions, see the leaflet "IMPORTANT SAFEGUARDS".

If you have any questions or problems concerning your unit, please contact your nearest Sony dealer.

Installation

Notes on installation

- Place the unit with the front panel facing you in a location with adequate air circulation to prevent overheating of the unit.
- Do not place the unit:
 - near heat sources such as radiators or air ducts.
 - in places subject to direct sunlight, excessive dust, mechanical vibration or shock.
 - in an inclined position.
 - on a rug or other soft surfaces that would block the ventilation holes on the bottom of the unit.
- Do not throw away the carton and the packing material! They will come in handy when transporting the unit or shipping it for servicing.

Connections

Notes on Connections

- Turn off the power to all equipment to be connected before making any connection.
- Note that the red plug of the supplied connecting cord is for right-channel (R) connection and the white plug for left-channel (L) connection.
- The connecting cords should be fully inserted into the jacks. A loose connection may cause hum pickup.

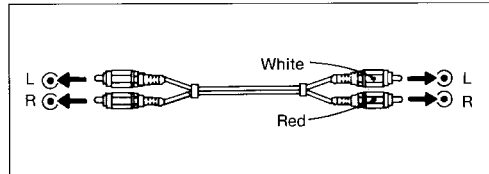

Basic Connection

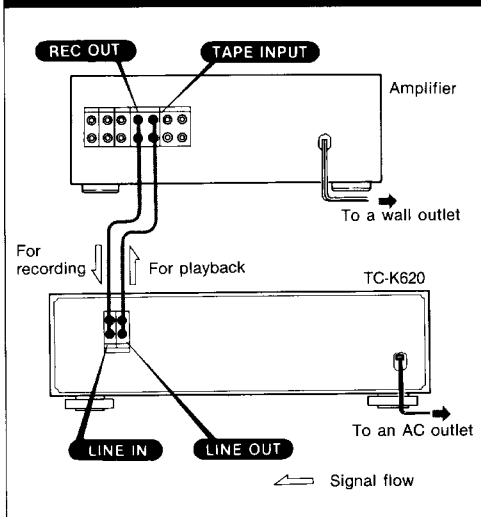

Connection for Tape Dubbing

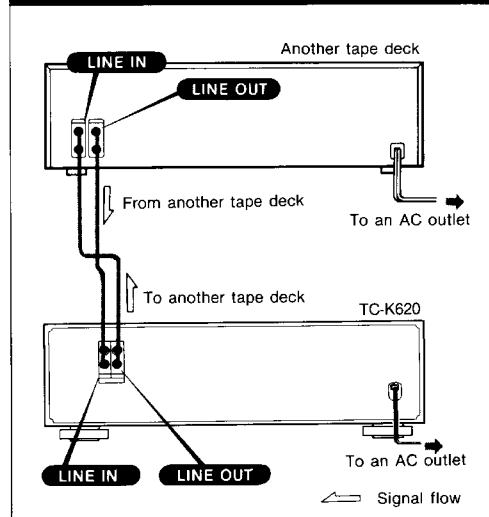

Identification of Front Panel Parts

For details, refer to the page number indicated in ●.

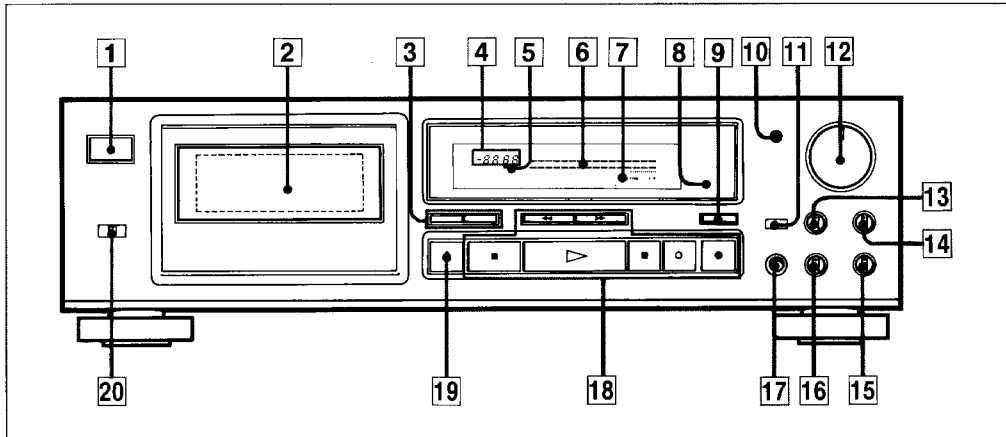

1 POWER switch

2 Cassette holder

3 COUNTER buttons ●
RESET button/MEMORY button



4 LINEAR COUNTER ●

5 MEMORY indicator ●

6 PEAK LEVEL METER ⑩

7 TAPE TYPE indicator ●

8 Remote sensor

- You can remotely control this cassette deck with:
- A remote commander that has an  mark and comes with a Sony amplifier or receiver and which can be used to control a cassette deck.
 - An optional Sony remote commander that has an  mark.

9 MONITOR button ⑩

10 DISPLAY MODE button ●

11 MPX FILTER switch ●

12 REC LEVEL (recording level) control ● ⑩

13 DOLBY NR switch ● ●

14 BALANCE control ●

15 BIAS (bias adjust) control ⑩

16 LEVEL (headphones level) control

17 HEADPHONES jack (stereo phone jack) ●

18 Tape operation buttons

- ◀◀ (rewind) button
- ▶▶ (fast forward) button
- (stop) button
- ▷ (play) button (AMS*)
- || PAUSE button
- REC MUTE (record muting) button ⑩
- REC (record) button

19  OPEN/CLOSE button

20 TIMER switch ●

* AMS is an abbreviation for Automatic Music Sensor.

Playing Back

Follow the procedure below to play back a cassette.

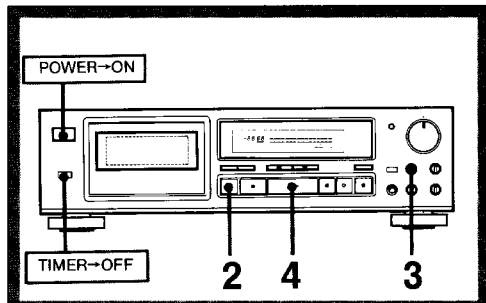

1 Turn on the amplifier and select the tape function.

2 Insert the cassette with the side to be played facing outward.

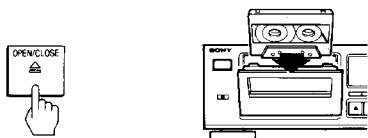

3 Select the Dolby NR system.

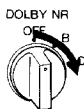

4 Start playback

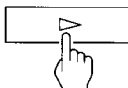

To stop playback	Press ■.
To stop playback momentarily	Press ■ To restart playback, press ■ or ▷.
To advance the tape	Press ▷▷.
To rewind the tape	Press ◀◀.

How to use the DOLBY NR switch

Set the DOLBY NR switch to the same position (B, C, or OFF) that was used when the cassette was recorded.

Use the DISPLAY MODE button to select the display mode

You may choose among three display modes by pressing the DISPLAY MODE button: (1) all indications are displayed; (2) only the linear counter is displayed; or (3) no display.

The TIMER switch must be set to OFF

Otherwise, recording or playback will start automatically when the power is turned on.

What is the Dolby NR system?

The Dolby NR (noise reduction) system reduces tape hiss noise in low-level, high-frequency signals by boosting the signals during recording and lowering them during playback.

Is it necessary to set the tape type being used?

No. The deck has an automatic tape type detection system. Of the four major types of tapes, your unit can use Type I (normal), Type II (CrO₂) and Type IV (metal). The tape detection system automatically adjusts the equalization and bias current to the optimum level for the type of cassette detected.

To change to recording mode during playback

Keeping ▷ pressed, press ●. The unit immediately switches from playback to recording without stopping the tape. This is useful when editing previously recorded material.

For headphone listening

Connect the headphone plug to the PHONES jack. The listening level can be controlled with the LEVEL control.

Is it necessary to set the MONITOR button for playback?

No. The TAPE mode is automatically selected and TAPE is displayed.

Note

The Dolby HX PRO System is effective only during recording, not during playback.

Locating a Selection — Automatic Music Sensor (AMS)

The AMS function detects the blank space between selections, allowing you to quickly locate the beginning of desired selections.

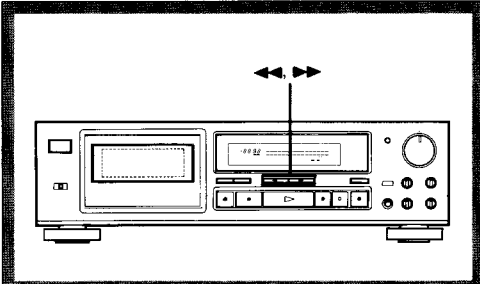

During playback, press **▶▶** or **◀◀** referring to the following table.

Desired selection	
Next selection	Selection being played
▶▶	◀◀

The PLAY indicator blinks while the AMS searches for the beginning of the selection.

After locating the beginning of the selection, playback will start automatically.

To ensure proper operation of the AMS?

There must be a blank of four seconds or longer between selections. Use the record muting function to insert a blank space when recording.

The AMS may skip a selection

If there is noise in the space between selections.

If the space is less than four seconds long.

If the **◀◀** or **▶▶** is pressed immediately before the following selection.

The AMS will treat the following as blanks:

- a long pause in the music
- a passage of low frequencies or very low volume
- a gradual increase or decrease in volume

To start operations while the cassette holder is open

Operations may be started while the cassette holder is open. For example, when **▷** is pressed while the cassette holder is open, the cassette holder will close and playback will start. Similarly, pressing **◀◀▶▶**, or **||** while the cassette holder is open will close the cassette holder and start the respective operation.

Playing Back Automatically After Rewinding—Auto Play

The Auto Play function automatically starts playing back a cassette after rewinding to the beginning.

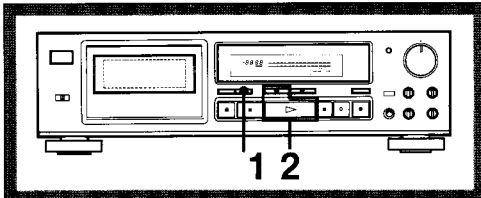

1 If MEMORY is displayed, press the MEMORY button to turn it off.

2 While holding down \blacktriangleleft , press \blacktriangleright . After the tape is completely rewound, the unit will automatically start playback.

Locating a Desired Position Using the Counter—Memory Play

The Memory Play function allows you to use the counter to record a desired position on a cassette for fast relocation and automatic playback later.

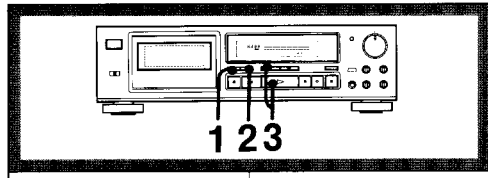

1 At the desired position, press the MEMORY button.

2 The desired position is memorized.

3 To return to the desired position: While holding down \blacktriangleleft , press \blacktriangleright .

The tape is rewound to 0.00 and playback starts.

Notes on Cassettes

To protect a recording on side A or B

Break out the respective tab.

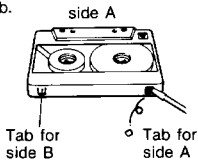

To recover a cassette for recording

Cover the respective slot with tape.



When using Type II (CrO₂) or Type IV (metal) cassettes

Be careful not to cover the detector slots which are necessary for automatic tape type detection.

Type II (CrO₂)



Detector slots

Type IV (metal)



Detector slots

Cassette care

- Avoid touching the tape surface of a cassette to prevent contamination of the heads by dirt, dust, or oil on the skin.
- Keep cassettes away from equipment with magnets, such as speakers and amplifiers, as erasure or distortion on the recorded tape could occur.
- Do not expose cassettes to direct sunlight, extremely cold temperatures or moisture.

If you press only the \blacktriangleleft button, the tape will be rewound and the unit will stop when the counter reaches 0.00 (Memory Stop).

The Accuracy of the Digital Linear Counter

This counter is not a digital clock, and thus the indicated number will not exactly equal the actual elapsed time. The difference between the number and the elapsed time will vary depending on the type of tape being used. This counter has been designed using Sony cassette tapes as a standard.

You may want to check the accuracy of the counter when using cassette tapes other than Sony's or tapes of a special length.

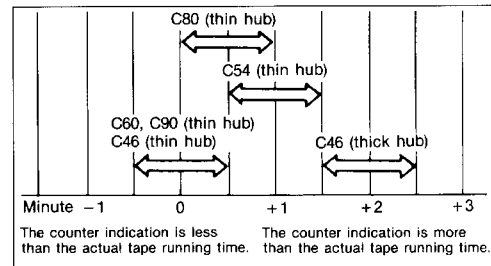

Do not turn off the power while using the counter

Turning the power off and then on again resets the counter to 0.00.

Recording

Follow the procedure below to record a program source on a cassette.

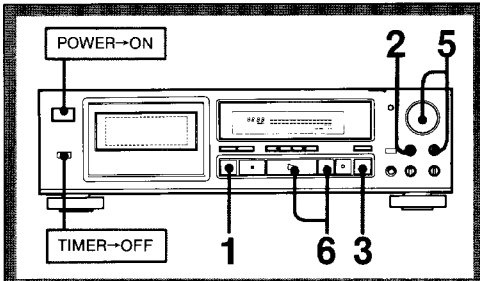

- 1** Insert the cassette with the side to be recorded facing outward.

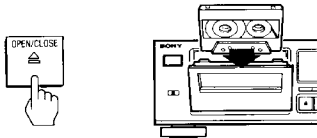

- 2** Select the Dolby NR system.

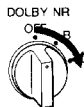

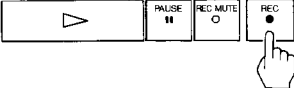
- 3** 

The unit will enter recording pause mode.

- 4** Play the program source to be recorded.

- 5** Adjust the recording level and balance (see page 10).



- 6** To start recording,

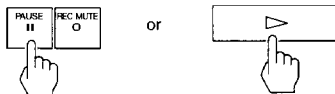

To stop recording, press ■.

If playback starts instead of recording

The cassette tab has been removed. To record on this cassette, cover the slot with tape. (See page 8).

The TIMER switch must be set to OFF

Otherwise, recording or playback will start automatically in a few seconds when the power is turned on.

Is it necessary to set the MONITOR button for recording?

No. The source mode is automatically selected and SOURCE is displayed. If you wish to monitor the recorded sound, press the MONITOR button to select the TAPE mode.

To start recording while the cassette holder is open

If you press the REC button while the cassette holder is open, the holder will close automatically and the unit will switch to recording pause mode. This function allows you to start recording at a moment's notice.

How to check the total recording time of a tape

- 1 Press the RESET button at the beginning of a tape to reset the counter to 0.00.
- 2 Press ►► to fast forward the tape to the end. The number on the counter shows the approximate recording time.

To check the approximate remaining recording time on the tape

- 1 Press the RESET button to reset the counter to 0.00.
 - 2 Advance the tape to its end using ►►.
- The number on the counter shows the approximate time remaining on the tape.

Using the MPX filter to record FM broadcasts

When recording FM broadcasts with the DOLBY NR system, set the MPX FILTER switch to ON (the "FILTER" indicator will be displayed). This turns on the MPX filter which eliminates remnants of the 19 kHz stereo carrier and 38 kHz subcarrier signals which may impair the operation of the DOLBY NR system. Be sure that Dolby NR switch is turned on since the MPX filter will not function otherwise. Note that the MPX FILTER switch must be turned on only when the tuner is not equipped with its own MPX filter or the equipped filter still results in sound degradation during recording with the Dolby NR system.

Recording

Adjusting the Recording Level

The optimum recording level, which differs according to the tape type, is indicated on the Peak Level Meter for each tape type.

Adjust the REC LEVEL control as high as possible without exceeding the recommended range for the tape type being used.

Recommended maximum PEAK LEVEL METER reading

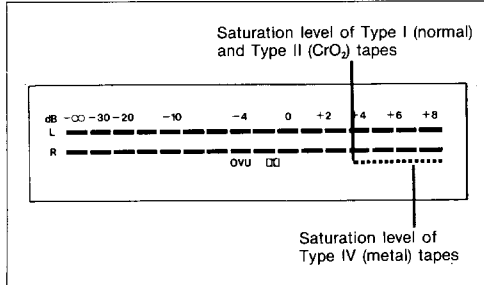

Tips on recording level adjustment

- If the recording level setting is too high, the recording will be distorted; if it is too low, the tape will produce a hissing sound. Therefore, the recording level should be set as high as possible without causing distortion.
- If the program source to be recorded has many high-frequency signals, set the level to a relatively low position.

Making an Optimum Recording According to the Tape Type — Bias Adjustment

To obtain the optimum frequency response, use the BIAS control to adjust the bias current according to the tape type being used. Reducing the bias boosts high frequencies but increases distortion. Increasing the bias decreases distortion but suppresses high frequencies. Balance the bias according to your listening preferences.

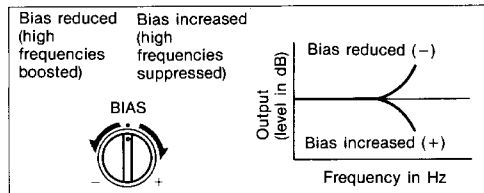

Note

In the case of Type IV cassette tapes, the frequency change for any given bias setting will be minimal.

Monitoring the Recorded Sound

As this unit has three separate heads for recording, playback and erasure, you can check the quality of a recorded sound by comparing it with the input signal before recording. (See the "MONITOR indication and signal flow".)

While recording, use the MONITOR button to check that there is no distortion due to excessive level settings or sound degradation due to head contamination.

How to use the MONITOR button

To listen to the input signal before recording, press the MONITOR button to select SOURCE.

To listen to the recorded sound from the tape, press the MONITOR button to select TAPE.

MONITOR indication and signal flow

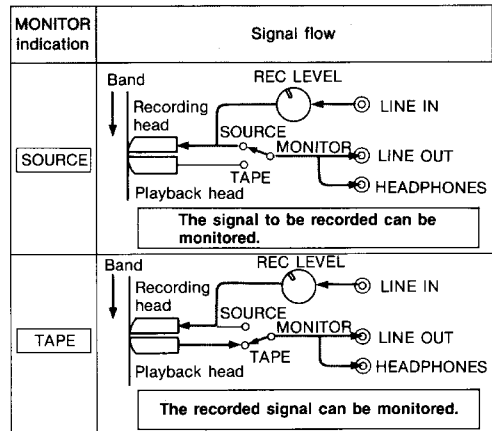

Inserting a Blank Space during Recording

— Record Muting

What is the Dolby HX PRO System?

The Dolby HX PRO system provides improved linearity in high-range frequency response during recording. Tapes recorded with this system retain the same high quality even when played back on other tape decks.

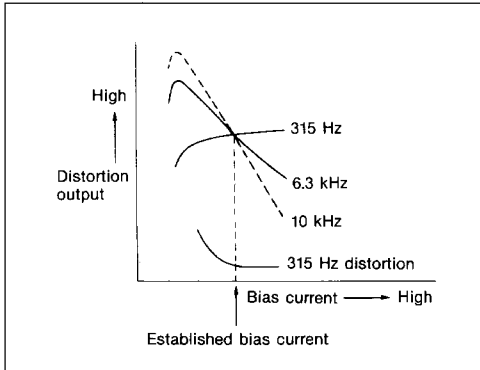

As shown above, characteristics such as output level and distortion differ widely according to the bias (high-frequency) current. In conventional systems, the bias current is susceptible to variations in certain recording signals (see diagram below) which can cause fluctuations in frequency response, distortion, or other unwanted characteristics.

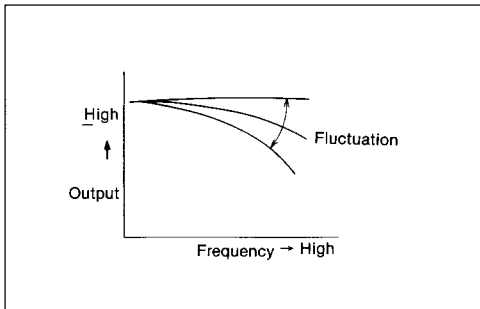

With the Dolby HX PRO system, the effective bias amount added to the bias current is controlled in millisecond units to greatly reduced distortion, improving linearity in high-range response and ensuring high-intensity recording with minimal distortion and noise.

The Record Muting function allows you to insert a four-second blank space on the tape to enable you to locate the selection later with the AMS function (see page 7). You can also use the button to replace unwanted input with a blank space.

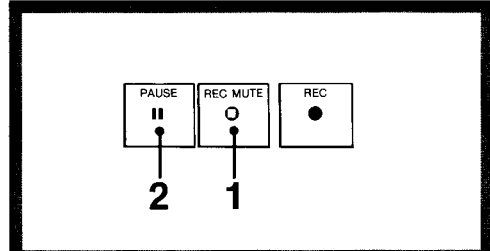

- 1 While recording, press **O** and release it immediately.

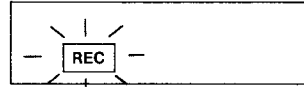

The [REC] indicator will start to blink. During this time, no incoming signals are recorded on the tape. After four seconds, the **||** indicator lights up and the unit enters the recording pause mode.

- 2 Resume recording.



To create a blank longer than four seconds

Press **O** for the desired length of time. The [REC] indicator will blink with greater rapidity after four seconds. When you release the button, the unit goes into the recording pause mode.

Press **||** to resume recording.

Timer-Activated Playback and Recording

By connecting an optional timer, recording or playback can be performed automatically at a preset time.

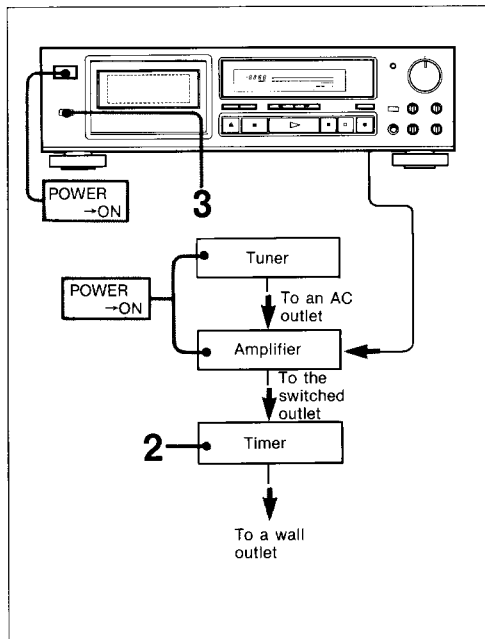

1 Insert a cassette and prepare the unit for playback or recording.

For playback	Follow steps 1 through 3 on page 6. Close the holder completely.
For recording	Follow steps 1 through 5 on page 9.

2 Set the timer to the desired time.

Power to the unit will be cut off.

3 Set the unit's TIMER switch to PLAY or REC.

Playback or recording will start at the preset time.

When the timer-activated operation is completed

Set the TIMER switch on the unit to OFF. If the TIMER switch is left at REC, the unit will automatically enter the recording mode the next time the power is turned on, and the previously recorded material may be erased.

Keep the POWER switch on the unit ON

When the timer is set, the power to the unit will be cut off. However, the POWER switch must be on to start timer-activated operation.

Maintenance

Cleaning the Heads and Tape Path

Clean all surfaces over which the tape travels after every ten hours of operation to guard against:

- low-quality sound
- a decrease in sound level
- excessive wow, flutter or dropout
- incomplete erasure
- impairment of recording function

To obtain high-quality recorded sound, cleaning before every recording is recommended.

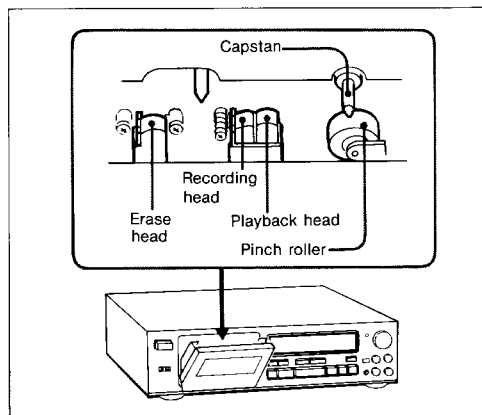

The cassette holder does not open unless the power is on.

1 Keeping the power on, turn the volume control on the amplifier to minimum.

2 Press  to open the cassette holder.

3 Wipe the heads, the pinch rollers and the capstans with a cotton swab slightly moistened with alcohol or commercially available cleaning fluid for tape decks.

Specifications

Demagnetizing the Heads

After every 20 or 30 hours of use, or when you notice hiss and/or loss of high frequencies, the residual magnetism built up on the heads should be removed.

- 1 Keeping the power on, turn the volume control on the amplifier to minimum.
- 2 Demagnetize the heads with any commercially available demagnetizer.
Refer to the instruction manual of the demagnetizer for detailed instructions.

Cleaning the Cabinet

Clean the cabinet, panel and controls with a soft cloth slightly moistened with a mild detergent solution.

Important

Do not use any type of abrasive pad, scouring powder or solvents such as alcohol or benzene.

Recording system	4-track 2-channel stereo
Bias	AC bias
Heads	Erase head × 1 (S & F head) Recording head × 1 (Permalloy head) Playback head × 1 (Permalloy head)
Motors	Capstan motor × 1 (DC servo motor) Reel motor × 1 (DC motor)
Wow and flutter	0.05% WRMS (NAB)
Fast-forward and rewind time	Approx. 90 sec. (with C-60 cassette)
Frequency response (DOLBY NR, off)	

Type IV cassette (Sony METAL-ES)	20–20,000 Hz (±3 dB) 20–16,000 Hz (OVU recording)
Type II cassette (Sony UX-S)	20–18,000 Hz (±3 dB)
Type I cassette (Sony HF-S)	20–17,000 Hz (±3 dB)

Signal-to-noise ratio (NAB, at peak level)

Cassette	Dolby NR switch	B-TYPE ON	C-TYPE ON
	OFF		
Type IV (Sony METAL-ES)	60 dB	67 dB	73 dB
Type II (Sony UX-S)	59 dB	66 dB	72 dB
Type I (Sony HF-S)	57 dB	64 dB	70 dB

Total harmonic distortion

1.0% (with Sony METAL-ES cassette)

Inputs

Line inputs (phono jacks)	Sensitivity	77.5 mV (–20 dB)
	Input impedance	50k ohms

Outputs

Line outputs (phono jacks)	Rated output level	0.44 V (–5 dB) at a load impedance 47k ohms
	Load impedance	Over 10k ohms
Headphones (stereo phone jack)	Output level	0–2.5 mW at a load impedance of 32 ohms

General

Power requirements	120 V AC, 60 Hz
Power consumption	17 W
Dimensions	Approx. 430 × 123 × 285 mm (w/h/d) (17 × 4 ⁷ / ₈ × 11 ¹ / ₄ inches) including projecting parts and controls
Weight	Approx. 4.9 kg (10 lbs 13 oz)
Supplied accessory	Audio connecting cord (2)
Optional accessory	Wireless remote control unit RM-J701

Design and specifications subject to change without notice.

Troubleshooting Guide





The following trouble checks will help you correct the most common problems encountered with your tape deck. Should any problems persist after you have made these checks, consult your nearest Sony dealer. Before proceeding with these trouble checks, verify that:

- The power cord is firmly connected.
- Amplifier connections are firmly made.
- Heads, capstans and pinch rollers are clean.
- The amplifier controls and switches are set correctly.

Function buttons and tape transport problems

Symptom	Cause	Remedy
The function buttons do not activate.	Cassette holder is not fully closed.	Close the holder completely.
	Cassette is not properly inserted.	Insert cassette correctly.
	The button pressed immediately after the power was turned on.	Wait until the II indicator stops blinking.
Playback or recording begins when the power is turned on.	The TIMER switch is not set to OFF .	Set the TIMER switch to OFF .
● button does not activate. (REC indicator does not light up.)	No cassette in the holder.	Insert a cassette.
	Tab has been removed from the cassette.	Cover the hole with plastic tape (page 8).
Automatic shut-off mechanism activates before the tape comes to its end.	Tape is slack.	Take up the tape slack.
	Cassette shell is deformed.	Use another cassette.
	The Memory Play function is activated.	Press the MEMORY button to deactivate the function.
Excessively loud tape transport noise during fast winding.	This noise is caused by the cassette and does not signify a mechanical problem.	—
The cassette holder will not close.	The power has been turned off while the cassette holder is open.	Turn the power on. The cassette holder will close automatically.

Recording and playback problems

Symptom	Cause	Remedy
Recording or playback cannot be made or there is a decrease in sound level.	Heads are either dirty or magnetized.	Clean or demagnetize the heads.
	Improper connection.	Make connections properly (page 4).
	Improper setting of the amplifier controls.	Set the amplifier controls to the appropriate positions.
Excessive wow, flutter or dropout.	Head, capstan or pinch roller is dirty.	Clean in accordance with instructions shown on page 12.
Incomplete erasure.	Erase head is dirty.	Clean the erase head.
Increased noise or poor reproduction in high frequencies.	Head is magnetized.	Demagnetize the head.
Unbalanced tone in high frequencies.	Improper setting of the DOLBY NR switch.	During playing back, set the switch to the same position used in recording.
	The unit is placed near a television set.	Move the unit away from the television set.
The desired selection cannot be located even though you activate the AMS.	There is noise in the space between selections. The space is less than 4 seconds long.	Rerecord the tape if you can, and insert a blank space of four seconds using the  button.
	The  or  button was pressed immediately before or after the beginning of the following selection.	—
Playback may begin in the middle of the selection when the AMS is activated.	The selection contains one of the following: — a long pause in the music — a passage of low frequencies or very low volume — a gradual increase or decrease in volume	While the tape is playing, press the  or  button again.

Noise

Symptom	Cause	Remedy
Hum noise.	The unit is stacked on or under the amplifier.	Separate the unit.
Noise is recorded.	Recording was made near equipment such as a television set or a color monitor, and interference has affected the recording on the tape and the Dolby NR system.	Move the unit away from the television set or color monitor.

Free Manuals Download Website

<http://myh66.com>

<http://usermanuals.us>

<http://www.somanuals.com>

<http://www.4manuals.cc>

<http://www.manual-lib.com>

<http://www.404manual.com>

<http://www.luxmanual.com>

<http://aubethermostatmanual.com>

Golf course search by state

<http://golfingnear.com>

Email search by domain

<http://emailbydomain.com>

Auto manuals search

<http://auto.somanuals.com>

TV manuals search

<http://tv.somanuals.com>