

LCD Monitor

Instructions for Use

Before operating the unit, please read this manual thoroughly and retain it for future reference.



LMD-3250MD

Owner's Record

The model and serial numbers are located at the rear. Record these numbers in the spaces provided below. Refer to these numbers whenever you call upon your Sony dealer regarding this product.

Model No. _____
Serial No. _____

WARNING

To reduce the risk of fire or electric shock, do not expose this apparatus to rain or moisture.

To avoid electrical shock, do not open the cabinet. Refer servicing to qualified personnel only.

WARNING

THIS APPARATUS MUST BE EARTHED.

To disconnect the main power, unplug the AC plug.

For the customers in Canada

This unit has been certified according to Standard CSA C22.2 No.601.1

For the customers in the U.S.A.

This equipment has been tested and found to comply with the limits for a Class A digital device, pursuant to Part 15 of the FCC Rules. These limits are designed to provide reasonable protection against harmful interference when the equipment is operated in a commercial environment. This equipment generates, uses, and can radiate radio frequency energy and, if not installed and used in accordance with the instruction manual, may cause harmful interference to radio communications. Operation of this equipment in a residential area is likely to cause harmful interference in which case the user will be required to correct the interference at his own expense.

You are cautioned that any changes or modifications not expressly approved in this manual could void your authority to operate this equipment.

All interface cables used to connect peripherals must be shielded in order to comply with the limits for a digital device pursuant to Subpart B of Part 15 of FCC Rules.

WARNING:

Using this unit at a voltage other than 120 V may require the use of a different line cord or attachment plug, or both. To reduce the risk of fire or electric shock, refer servicing to qualified service personnel.

For the customers in the U.S.A and Canada

When you use this product connected to 240 V single phase, be sure to connect this product to a center tapped circuit.

Important safeguards/notices for use in the medical environments

1. All the equipments connected to this unit shall be certified according to Standard IEC60601-1, IEC60950-1, IEC60065 or other IEC/ISO Standards applicable to the equipments.
2. Furthermore all configurations shall comply with the system standard IEC60601-1-1. Everybody who connects additional equipment to the signal input part or signal output part configures a medical system, and is therefore, responsible that the system complies with the requirements of the system standard IEC60601-1-1. If in doubt, consult the qualified service personnel.
3. The leakage current could increase when connected to other equipment.
4. For this particular equipment, all accessory equipment connected as noted above, must be connected to mains via an additional isolation transformer conforming with the construction requirements of IEC60601-1 and providing at least Basic Insulation.
5. This equipment generates, uses, and can radiate radio frequency energy. If it is not installed and used in accordance with the instruction manual, it may cause interference to other equipment. If this unit causes interference (which can be determined by unplugging the power cord from the unit), try these measures: Relocate the unit with respect to the susceptible equipment. Plug this unit and the susceptible equipment into different branch circuit.

Consult your dealer. (According to standard EN60601-1-2 and CISPR11, Class B, Group 1)

6. Model LMD-3250MD is a monitor intended for use in a medical environment to display pictures from cameras or other systems, other than diagnostic X-ray equipment.

WARNING

When installing the unit, incorporate a readily accessible disconnect device in the fixed wiring, or connect the power plug to an easily accessible socket-outlet near the unit. If a fault should occur during operation of the unit, operate the disconnect device to switch the power supply off, or disconnect the power plug.

Caution

When you dispose of the unit or accessories, you must obey the law in the relative area or country and the regulation in the relative hospital.

For the customers in the USA

Lamp in this product contains mercury. Disposal of these materials may be regulated due to environmental considerations. For disposal or recycling information, please contact your local authorities or the Electronic Industries Alliance (www.eiae.org).

WARNING on power connection

Use a proper power cord for your local power supply.

1. Use the approved Power Cord (3-core mains lead) / Appliance Connector / Plug with earthing-contacts that conforms to the safety regulations of each country if applicable.
2. Use the Power Cord (3-core mains lead) / Appliance Connector / Plug conforming to the proper ratings (Voltage, Ampere).

If you have questions on the use of the above Power Cord / Appliance Connector / Plug, please consult a qualified service personnel.





WARNING on power connection for medical use

Please use the following power supply cord. With connectors (plug or female) and cord types other than those indicated in this table, use the power supply cord that is approved for use in your area.

	United States and Canada
Plug Type	HOSPITAL GRADE*
Cord type	Min. Type SJT Min. 18 AWG
Minimum Rating for Plug and Appliance Couplers	10A/125V
Safety Approval	UL Listed and CSA

*Note: Grounding reliability can only be achieved when the equipment is connected to an equivalent receptacle marked 'Hospital Only' or 'Hospital Grade'.

Symbols on the unit

Symbol	Location	This symbol indicates
	Bottom	Power switch. Press to turn the monitor on.
	Bottom	Power switch. Press to turn the monitor off.
	Side	The equipotential terminal which brings the various parts of a system to the same potential.
	Side	Functional earth terminal
	Front	Key inhibit The settings are locked so that they cannot be changed.



CAUTION
Please provide with the protection cover for the connector when you do not use the specified connectors.

This label is located on the rear panel of the unit. See page 18 of these instructions for details about how to attach the connector covers.

Important EMC notices for use in the medical environments

- The LMD-3250MD needs special precautions regarding EMC and needs to be installed and put into service according to the EMC information provided in this instructions for use.
- The portable and mobile RF communications equipment such as cellular phones can affect the LMD-3250MD.

Warning

The use of accessories and cables other than those specified, with the exception of replacement parts sold by Sony Corporation, may result in increased emissions or decreased immunity of the LMD-3250MD.

Guidance and manufacturer's declaration-electromagnetic emissions		
The LMD-3250MD is intended for use in the electromagnetic environment specified below. The customer or the user of the LMD-3250MD should assure that it is used in such an environment.		
Emission test	Compliance	Electromagnetic environment-guidance
RF emissions CISPR 11	Group 1	The LMD-3250MD uses RF energy only for its internal function. Therefore, its RF emissions are very low and are not likely to cause any interference in nearby electronic equipment.
RF emissions CISPR 11	Class B	The LMD-3250MD is suitable for use in all establishments, including domestic establishments and those directly connected to the public low-voltage power supply network that supplies buildings used for domestic purposes.
Harmonic emissions IEC 61000-3-2	Class D	
Voltage fluctuations/ flicker emissions IEC 61000-3-3	Complies	

Warning

If the LMD-3250MD should be used adjacent to or stacked with other equipment, it should be observed to verify normal operation in the configuration in which it will be used.

Guidance and manufacturer's declaration - electromagnetic immunity

The LMD-3250MD is intended for use in the electromagnetic environment specified below. The customer or the user of the LMD-3250MD should assure that it is used in such an environment.

Immunity test	IEC 60601 test level	Compliance level	Electromagnetic environment - guidance
Electrostatic discharge (ESD) IEC 61000-4-2	±6 kV contact ±8 kV air	±6 kV contact ±8 kV air	Floors should be wood, concrete or ceramic tile. If floors are covered with synthetic material, the relative humidity should be at least 30%.
Electrical fast transient/burst IEC 61000-4-4	±2 kV for power supply lines ±1 kV for input/output lines	±2 kV for power supply lines ±1 kV for input/output lines	Mains power quality should be that of a typical commercial or hospital environment.
Surge IEC 61000-4-5	±1 kV differential mode ±2 kV common mode	±1 kV differential mode ±2 kV common mode	Mains power quality should be that of a typical commercial or hospital environment.
Voltage dips, short interruptions and voltage variations on power supply input lines IEC 61000-4-11	< 5% U_T (> 95% dip in U_T) for 0.5 cycle 40% U_T (60% dip in U_T) for 5 cycles 70% U_T (30% dip in U_T) for 25 cycles < 5% U_T (> 95% dip in U_T) for 5 sec	< 5% U_T (> 95% dip in U_T) for 0.5 cycle 40% U_T (60% dip in U_T) for 5 cycles 70% U_T (30% dip in U_T) for 25 cycles < 5% U_T (> 95% dip in U_T) for 5 sec	Mains power quality should be that of a typical commercial or hospital environment. If the user of the LMD-3250MD requires continued operation during power mains interruptions, it is recommended that the LMD-3250MD be powered from an uninterruptible power supply or a battery.
Power frequency (50/60Hz) magnetic field IEC 61000-4-8	3 A/m	3 A/m	Power frequency magnetic fields should be at least characteristic of a typical location in a typical commercial or hospital environment.

NOTE: U_T is the a.c. mains voltage prior to application of the test level.

Guidance and manufacturer's declaration - electromagnetic immunity

The LMD-3250MD is intended for use in the electromagnetic environment specified below. The customer or the user of the LMD-3250MD should assure that it is used in such as environment.

Immunity test	IEC 60601 test level	Compliance level	Electromagnetic environment - guidance
<p>Conducted RF IEC 61000-4-6</p>	<p>3 Vrms 150 kHz to 80 MHz</p>	<p>3 Vrms</p>	<p>Portable and mobile RF communications equipment should be used no closer to any part of the LMD-3250MD, including cables, than the recommended separation distance calculated from the equation appliance to the frequency of the transmitter.</p> <p>Recommended separation distance</p> <p>$d = 1.2 \sqrt{P}$</p> <p>$d = 1.2 \sqrt{P}$ 80 MHz to 800 MHz</p> <p>$d = 2.3 \sqrt{P}$ 800 MHz to 2.5 GHz</p> <p>Where P is the maximum output power rating of the transmitter in watts (W) according to the transmitter manufacturer and d is the recommended separation distance in meters (m).</p> <p>Field strengths from fixed RF transmitters, as determined by an electromagnetic site survey, ^a should be less than the compliance level in each frequency range. ^b</p> <p>Interference may occur in the vicinity of equipment marked with following symbol:</p> 
<p>NOTE 1: At 80 MHz and 800 MHz, the higher frequency range applies.</p>	<p>NOTE 2: These guidelines may not apply in all situations. Electromagnetic propagation is affected by absorption and reflection from structures, objects and people.</p>		
<p>a Field strengths from fixed transmitters, such as base stations for radio (cellular/cordless) telephones and land mobile radios, amateur radio, AM and FM radio broadcast and TV broadcast cannot be predicted theoretically with accuracy. To assess the electromagnetic environment due to fixed RF transmitters, an electromagnetic site survey should be considered. If the measured field strength in the location in which the LMD-3250MD is used exceeds the applicable RF compliance level above, the LMD-3250MD should be observed to verify normal operation. If abnormal performance is observed, additional measures may be necessary, such as reorienting or relocating the LMD-3250MD.</p> <p>b Over the frequency range 150 kHz to 80 MHz, field strengths should be less than 3 V/m.</p>			

Recommended separation distances between portable and mobile RF communications equipment and the LMD-3250MD

The LMD-3250MD is intended for use in an electromagnetic environment in which radiated RF disturbances are controlled. The customer or the user of the LMD-3250MD can help prevent electromagnetic interference by maintaining a minimum distance between portable and mobile RF communications equipment (Transmitters) and the LMD-3250MD as recommended below, according to the maximum output power of the communications equipment.

Rated maximum output power of transmitter W	Separation distance according to frequency of transmitter m		
	150 kHz to 80 MHz $d = 1.2 \sqrt{P}$	80 MHz to 800 MHz $d = 1.2 \sqrt{P}$	800 MHz to 2.5 GHz $d = 2.3 \sqrt{P}$
0.01	0.12	0.12	0.23
0.1	0.38	0.38	0.73
1	1.2	1.2	2.3
10	3.8	3.8	7.3
100	12	12	23

For transmitters rated a maximum output power not listed above, the recommended separation distance d in meters (m) can be estimated using the equation applicable to the frequency of the transmitter, where P is the maximum output power rating of the transmitter in watts (W) according to the transmitter manufacturer.

NOTE 1: At 80 MHz and 800 MHz, the separation distance for the higher frequency range applies.

NOTE 2: These guidelines may not apply in all situations. Electromagnetic propagation is affected by absorption and reflection from structures, objects and people.

Table of Contents

Precaution	9
On Safety	9
On Installation	9
About the LCD Display Panel	9
About the Fluorescent Tube	9
On Cleaning	9
Disposal of the Unit	10
Recommendation to Use more than One Unit ..	10
On Repacking	10
On Fan Error	10
On Moisture Condensation	10
Features	10
Location and Function of Parts and Controls ..	12
Front Panel	12
Input signals and adjustable/setting items	14
Side/Rear Panel	15
Connecting the AC Power Cord	17
Installing the Input Adaptor	18
Removing the Connector Cover	18
Selecting the Default Settings	19
Selecting the Menu Language	20
Using the Menu	21
Loading USER MEMORY	23
Adjustment Using the Menus	23
Items	23
Adjusting and Changing the Settings	24
STATUS menu.....	24
COLOR TEMP/SPACE menu.....	25
USER CONTROL menu.....	25
USER CONFIG menu.....	27
REMOTE menu	30
KEY INHIBIT menu.....	31
USER MEMORY menu	31
Saving the user memory.....	31
Troubleshooting	32
Specifications	33
Dimensions	39

Precaution

On Safety

- Operate the unit on 100-240 V AC only.
- The nameplate indicating operating voltage, etc. is located on the AC adaptor.
- Should any solid object or liquid fall into the cabinet, unplug the unit and have it checked by qualified personnel before operating it any further.
- Unplug the unit from the wall outlet if it is not to be used for several days or more.
- To disconnect the AC power cord, pull it out by grasping the plug. Never pull the cord itself.
- The socket-outlet shall be installed near the equipment and shall be easily accessible.

On Installation

- Prevent internal heat build-up allowing adequate air circulation.
Do not place the unit on surfaces (rugs, blankets, etc.) or near materials (curtains, draperies) that may block the ventilation holes.
- Do not install the unit near heat sources such as radiators or air ducts, or in a place subject to direct sunlight, excessive dust, mechanical vibration or shock.
- Do not place the monitor near equipment which generates magnetism, such as a transformer or high voltage power lines.

About the LCD Display Panel

- The LCD panel fitted to this unit is manufactured with high precision technology, giving a functioning pixel ratio of at least 99.99%. Thus a very small proportion of pixels may be “stuck”, either always off (black), always on (red, green, or blue), or flashing. In addition, over a long period of use, because of the physical characteristics of the liquid crystal display, such “stuck” pixels may appear spontaneously. These problems are not a malfunction.
- Do not leave the LCD screen facing the sun as it can damage the LCD screen. Take care when you place the unit by a window.
- Do not push or scratch the LCD monitor’s screen. Do not place a heavy object on the LCD monitor’s screen. This may cause the screen to lose uniformity.
- If the unit is used in a cold place, a residual image may appear on the screen. This is not a malfunction. When

the monitor becomes warm, the screen returns to normal.

- If a fixed picture such as a frame of a divided picture or time code, or a still picture is displayed for a long time, an image may remain on the screen and be superimposed as a ghosting image.
- The screen and the cabinet become warm during operation. This is not a malfunction.

About the Fluorescent Tube

A specially designed fluorescent tube is installed as the lighting apparatus for this unit. If the LCD screen becomes dark, unstable or does not turn on, consult your Sony dealer.

On Cleaning

Before cleaning

Be sure to disconnect the AC power cord from the AC outlet.

On cleaning the monitor

A material that withstands disinfection is used for the front protection plate of the medical use LCD monitor. The protection plate surface is especially treated to reduce reflection of light. When solvents such as benzene or thinner, or acid, alkaline or abrasive detergent, or chemical cleaning cloth are used for the protection plate surface/monitor surface, the performance of the monitor may be impaired or the finish of the surface may be damaged. Take care with respect to the following:

- Clean the protection plate surface/monitor surface with a 50 to 70 v/v% concentration of isopropyl alcohol or a 76.9 to 81.4 v/v% concentration of ethanol using a swab method. Wipe the protection plate surface gently (wipe using less than 1 N force).
- Stubborn stains may be removed with a soft cloth such as a cleaning cloth lightly dampened with mild detergent solution using a swab method and then clean using the above chemical solution.
Never use solvents such as benzene or thinner, or acid, alkaline or abrasive detergent, or chemical cleaning cloth for cleaning or disinfection, as they will damage the protection plate surface/monitor surface.
- Do not use unnecessary force to rub the protection plate surface/monitor surface with a stained cloth. The protection plate surface/monitor surface may be scratched.
- Do not keep the protection plate surface/monitor surface in contact with a rubber or vinyl resin product for a long period of time. The finish of the surface may deteriorate or the coating may come off.

Disposal of the Unit

- Do not dispose of the unit with general waste. Do not include the monitor with household waste.
- The fluorescent tube includes mercury. Dispose of the monitor in accordance with the regulations of your local sanitation authority.

Recommendation to Use more than One Unit

As problems can occasionally occur for the monitor, when the monitor is used for safety control of personnel, assets or stable picture, or for emergencies, we strongly recommend you use more than one unit or prepare a spare unit.

On Repacking

Do not throw away the carton and packing materials. They make an ideal container which to transport the unit.

If you have any questions about this unit, contact your authorized Sony dealer.

On Fan Error

The fan for cooling the unit is built in. When the fan stops and the RETURN button on the front panel blinks for fan error indication, turn off the power and contact an authorized Sony dealer.

On Moisture Condensation

If the unit is brought directly from a cold place to a warm place, or the unit is warm and the ambient temperature cools suddenly (by air-conditioning, for example), moisture may condense on the surface or inside of the unit, or create a mist residue inside the protection plate. This is called moisture condensation, and is not a malfunction of the product itself, although it may cause damage to the unit.

Leave the unit in a condensation free area.

If moisture condensation has occurred, turn off the unit and do not use it until moisture condensation has evaporated.

Features

Compliance with medical safety standards in America, Canada and Europe

UL60601-1 for America, CSA C22.2 No.601.1 for Canada and EN 60601-1 for Europe have been obtained for this monitor.

The monitor is designed for use in the medical treatment field, with the sheet switch, screen protect panel, etc.

Picture

Fully digital 10-bit signal processing circuit

As well as digital signals, all signals including analog signals are converted into digital signals. All signals are processed using a fully digital 10-bit processing circuit so that an image is produced in smooth gradation without any deterioration of quality.

Two color system available

The monitor can display NTSC and PAL signals by connecting this unit.

Auto chroma/phase function

The chroma and phase of the decoder are automatically adjusted with the auto chroma phase function.

High image-quality/high-resolution Full HD LCD panel with 10-bit driver

A Full HD high-resolution/high-gradient (1920 × 1080 dots) panel and high brightness/ultra-wide field of view technology enables you to use the monitor under various lighting conditions and in numerous ways (installing on wall, using several monitors to view an image, and so on.).

Because a color filter with wide-color reproduction and LCD materials with high response speed are used, the motion picture of the video signal is displayed clearer. This monitor also performs sampling of signals at high frequencies and provides a high resolution of 700 TV scanning lines or more during the RGB or component signal (480/60I, 575/50I) input.

Input

Accepts analog RGB input signals *1

Adopting the scan converter allows this monitor to detect VGA, SVGA, XGA and SXGA analog RGB signals input to the HD15 input connector.

Accepts DVI-D (digital) input signals ^{*1}

Adopting the scan converter allows this monitor to detect VGA, SVGA, XGA and SXGA digital computer signals input to the DVI input connector.

To view SXGA signals when the DVI input is selected, use the cable within 3 m (118 1/8 inches) in length.

^{*1} For acceptable formats, see “About the preset signal” on page 35.

Optional slot for the video signal

One optional input adaptor can be attached. The composite, Y/C, component, analog RGB or SDI signal can be input depending on the input connectors of the board to be used.

Multi-format ^{*2}

NTSC or PAL color system or DTV format, such as 720P, 1080i, etc. can be selected automatically.

^{*2} For acceptable formats, see “Available signal formats” on page 34.

External sync input

The unit can be operated on the sync signal supplied from an external sync generator.

Functions

APA (Auto Pixel Alignment) function

You can display pictures from the HD15 input connector in the appropriate picture by simply pressing the APA key.

Automatic termination (connector with mark only)

The input connector is terminated internally at 75 ohms when nothing has been connected to the output connector. If a cable is connected to the output connector, the internal terminal is automatically released and the signals input to the input connector are output to the output connector (loop-through).

Select color temperature and gamma mode

You can select the color temperature from among three (HIGH, LOW, LOW2) settings and gamma mode from between two settings (2.2, DICOM). You can also adjust the color temperature to the appropriate setting in “USER”.

Two-display

Two kinds of input signals are put on the monitor.

For more information, see MULTI DISPLAY of “MULTI DISPLAY SETTING” on page 28.

Color space feature

You can select ITU-R BT.709 for the color space settings.

Aspect setting

You can set the monitor to 4:3 or 16:9 display mode according to the input signal.

Scan function

You can select the display from among “NORMAL”, “OVER” and “NATIVE” (720P only) except the HD15 and DVI input signals.

Select language display

You can select your language for the display from seven languages - English, French, German, Spanish, Italian, Japanese and Chinese.

Power saving function

The monitor enters into power saving mode to reduce the power consumption when no signal is input.

Key inhibit function

You can inhibit the key to prevent missing an operation.

User memory function

You can save the 20 picture settings with the name. The user memory data can be saved or loaded between the monitor and the equipment (PC, etc.) connected in serial remote mode.

Two kinds of ground terminals

Two kinds of ground terminals are built into the monitor to equal the electric potential.

External remote function

The input signal is selected or various items are adjusted by use of the serial (Ethernet) remote function. You can connect this unit to the monitor by the Ethernet (10BASE-T/100BASE-TX) connection and controlled remotely on the network.

For more information, see SERIAL REMOTE of REMOTE menu on page 30.

Other

Optional stand

It is more convenient to install the monitor on a desk by using the optional stand (SU-32FW).

Location and Function of Parts and Controls

Front Panel

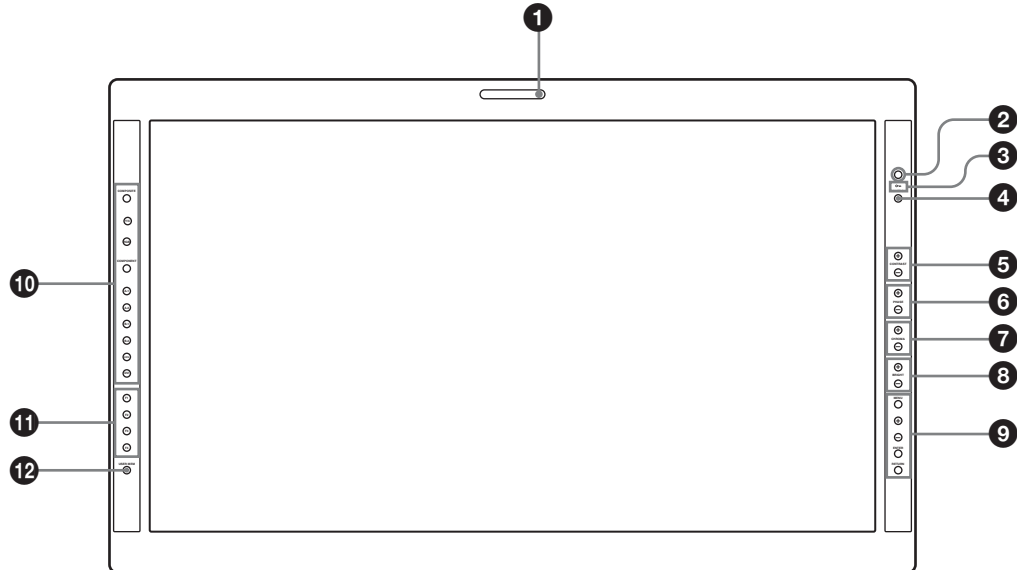

1 Tally lamp

You can check the status of the monitor by the color of the tally lamp.
The tally lamp lights in green according to the setting of PARALLEL REMOTE in the REMOTE menu.

2 Power indicator

When the power is turned on, the power indicator light in green.

3 (key inhibit) indicator

Lights in white when KEY INHIBIT in the KEY INHIBIT menu is set to ON.

4 CONTROL button

Press to display the buttons on the front panel. Press again to clear the display.

5 CONTRAST buttons

Adjusts the picture contrast.
Press the + button to make the contrast higher or the – button to make it lower.

6 PHASE buttons

Adjusts color tones.
Press the + button to make the skin tones greenish or the – button to make them purplish.

7 CHROMA buttons

Adjusts the color intensity.

Press the + button to increase the color intensity or the – button to decrease it.

8 BRIGHT (brightness) buttons

Adjusts the picture brightness.
Press the + button to increase the brightness or the – button to decrease it.

9 Menu operation buttons

Displays or sets the on-screen menu.

MENU button

Press to display the on-screen menu.
Press again to clear the menu.

+/- buttons

Press to select the items and setting values.

ENTER button

Press to confirm a selected item on the menu.
When the menu is not displayed and the button is pressed, the distinguished signal format is displayed.

RETURN button

When the menu is displayed and the button is pressed, the value of an item is reset to the previous value.
When the menu is not displayed and the button is pressed, the function selected in FUNCTION BUTTON SETTING of the USER CONFIG menu is displayed on the side of the F1 to F4 button. Also, when the fan stops, this button blinks.

10 Input select buttons

Press the button to monitor the signal input to each connector.

A-1, A-2, B-1 and B-2 buttons are used when an optional input adaptor has been installed in the option slot.

COMPOSITE button: to monitor the signal through the COMPOSITE IN connector

Y/C button: to monitor the signal through the Y/C IN connector

RGB button: to monitor the RGB signal through the connectors for the R/G/B signal input

COMPONENT button: to monitor the component signal through the connectors for Y/PB/PR signal input

A-1 button: to monitor the signal from connector **1** (the connectors for the R/G/B signal input in BKM-229X) of the input adaptor installed to the option slot A

A-2 button: to monitor the signal from connector **2** (the connectors for Y/PB/PR signal input in BKM-229X) of the input adaptor installed to the option slot A

B-1 button: to monitor the signal from connector **1** (the connectors for the R/G/B signal input in BKM-229X) of the input adaptor installed to the option slot B

B-2 button: to monitor the signal from connector **2** (the connectors for Y/PB/PR signal input in BKM-229X) of the input adaptor installed to the option slot B

HD15 button: to monitor the signal through the HD15 input connector

DVI button: to monitor the signal through the DVI-D input connector

11 Function buttons

You can turn the assigned function on or off.

The factory setting is as follows;

F1 button: EXT SYNC

F2 button: SCAN

F3 button: ASPECT

F4 button: MULTI DISPLAY

You can assign the function from among SCAN, ASPECT, EXT SYNC, BLUE ONLY, MONO, MULTI DISPLAY, APA and MIRROR IMAGE in FUNCTION BUTTON SETTING of the USER CONFIG menu (see page 29).

For details of the function assigned to the function button, see page 29.

12 USER MEM (user memory) button

Press to load the picture settings saved in the USER MEMORY menu (on page 31).

Input signals and adjustable/setting items

Item	Input signal									
	Video* ³ , Y/C* ³	B & W* ³	Component* ⁴		RGB* ⁴		SDI		Computer	
			SD	HD	SD	HD	D1* ⁵	HD* ⁶	DVI	HD15
CONTRAST* ¹	○	○	○	○	○	○	○	○	○	○
BRIGHT* ¹	○	○	○	○	○	○	○	○	○	○
CHROMA* ¹	○	×	○	○	○	○	○	○	○	○
PHASE* ¹	○ (NTSC)	×	○	○	○	○	○	○	○	○
APERTURE	○	○	○	○	○	○	○	○	○	○
COLOR TEMP	○	○	○	○	○	○	○	○	○	○
COLOR SPACE	○	○	○	○	○	○	○	○	○	○
AUTO CHROMA/ PHASE	○	×	○	○	×	×	×	×	×	×
ACC	○	×	×	×	×	×	×	×	×	×
CTI	○	×	○	×	×	×	×	×	×	×
V SHARPNESS	○	○	○	×	○	×	○	×	×	×
MATRIX* ²	×	×	○	×	×	×	×	×	×	×
COMPONENT LEVEL	×	×	○ (480/60I)	×	×	×	×	×	×	×
NTSC SETUP	○ (NTSC)	○ (480/60I)	×	×	×	×	×	×	×	×
SCAN	○	○	○	○	○	○	○	○	×	×
GAMMA	○	○	○	○	○	○	○	○	○	○
ASPECT* ¹⁰	○	○	○	×	○	×	○	×	×	×
BLUE ONLY	○	×	○	○	○	○	○	○	×	×
MONO	○	×	○	○	×	×	○	○	×	×
APA	×	×	×	×	×	×	×	×	×	○
SIZE	×	×	×	×	×	×	×	×	×	○
SHIFT	○	○	○	○	○	○	○	○	×	○
PITCH	×	×	×	×	×	×	×	×	×	○
DOT PHASE	×	×	×	×	×	×	×	×	×	○
POWER SAVING	○	○	○	○	○	○	○	○	○	○
PICTURE DELAY MIN* ⁷	○	○	○	○	○	○	○	○	×	×
MULTI DISPLAY	○	○	○	○	○	○	○	○	○	○

○ : Adjustable/can be set

×

*1 Adjustment of SUB CONTROL is the same.

*2 When a component signal (480/60I or 480/60P) is input and the COMPONENT LEVEL is set to SMPTE, this can be switchable.

*3 When a BKM-227W is installed, the number of the input connector is increased.

*4 When a BKM-229X is installed, the number of the input connector is increased.

*5 When a BKM-220D or BKM-243HS is installed, the signal can be input.

*6 When a BKM-243HS is installed, the signal can be input.

*7 Only the interlace signal is input.

*8 The signal can operate with PRESET 2 to 6. (See page 37.)

*9 The signal can only be selected in the main display. (See "SUB INPUT SELECT" on page 28.)

*10 The signal cannot operate with PRESET 7 and 8.

*11 The signal can only operate with PRESET 1.

*12 The signal can only operate with PRESET 6.

Side/Rear Panel

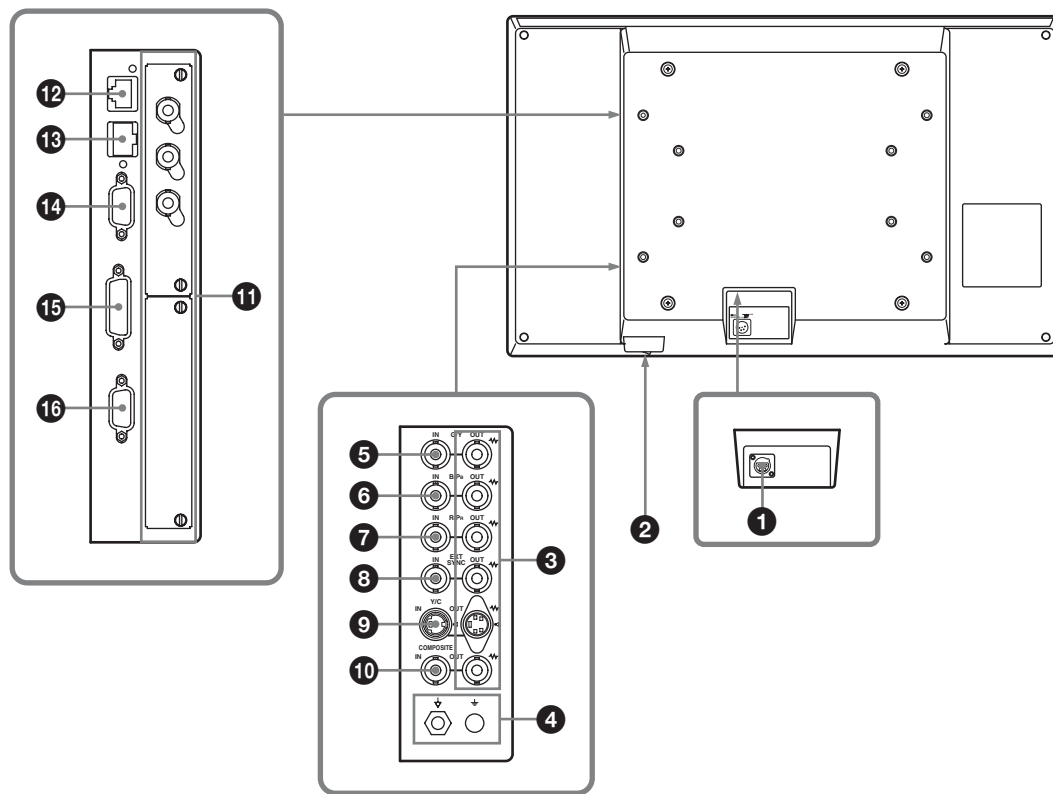

1 DC 5V/24V IN connector

Connect the DC connector of the supplied AC adaptor.

2 \odot / \circ (power) switch

The power is turned on or off.

The monitor is turned on by pressing side \odot .

3 Loop-through output connectors

Outputs the signals input to the input connectors (5 to 10). Connect to the analog input (composite, Y/C, analog component, analog RGB or external sync) of equipment, according to the input signal.

When a cable is connected to one of these connectors, the 75-ohm termination of the corresponding input is automatically released, and the signal input to the input connector is output.

4 ∇ / \perp (Equipotential/Function Earth) terminal

∇ (equipotential) terminal

Connects the equipotential plug.

\perp (function earth) terminal

Connects the earth cable.

5 G/Y IN connector (BNC)

Input connector for G of RGB signals and component Y (luminance) signals.

6 B/PB IN connector (BNC)

Input connector for B of RGB signals and PB (blue color difference) of component signals.

7 R/PR IN connector (BNC)

Input connector for R of RGB signals and PR (red color difference) of component signals.

8 EXT SYNC IN (external sync input) connector (BNC)

When this unit operates on an external sync signal, connect the reference signal from a sync generator to this connector.

To use the external sync signal, press the function button that EXT SYNC is assigned (F1 button at the factory setting).

Note

When inputting a video signal with the jitters, etc. the picture may be disturbed. We recommend using the TBC (time base corrector).

9 Y/C IN connector (4-pin mini-DIN)

Input connector for Y/C signals.

10 COMPOSITE IN connector (BNC)

Input connector for composite signals.

11 Optional input slot

An optional input adaptor can be installed according to your system configuration (see page 18).

The upper slot is A and the lower slot is B.

Press the A-1, A-2, B-1 or B-2 button to select the signal.

The BKM-243HS (HD/D1-SDI input adaptor) is preattached in slot A in this unit.

12 PARALLEL REMOTE connector (modular connector, 8-pin)

Forms a parallel switch and controls the monitor externally.

When the unit is shipped from the factory, a connector cover is attached to this connector. Remove it before using the connector.

For removing the connector cover, see page 18.

For details on the pin assignment and factory setting function assigned to each pin, see page 34.

CAUTION

For safety, do not connect the connector for peripheral device wiring that might have excessive voltage to this port. Follow the instructions for this port.

13 SERIAL REMOTE connector (RJ-45)

Connect to the network by using a 10BASE-T/100BASE-TX LAN cable (shielded type, optional).

When the unit is shipped from the factory, a connector cover is attached to this connector. Remove it before using the connector.

For removing the connector cover, see page 18.

For details on this connector, refer to the Interface Manual for Programmers (saved in the supplied CD-ROM, Japanese and English only.)

CAUTION

- When an optional LAN cable is connected, use a shield type cable to prevent miss-operation due to noises.
- For safety, do not connect the connector for peripheral device wiring that might have excessive voltage to this port. Follow the instructions for this port.
- The connection speed may be affected by the network system. This unit does not guarantee the communication speed or quality of 10BASE-T/100BASE-TX.

14 SERIAL REMOTE RS-232C connector (D-sub 9-pin, female)

Connect to the RS-232C control connector on external equipment connected to the monitor. The monitor can be operated according to control commands sent from external equipment connected to it.

For details on the pin assignment and factory setting function assigned to each pin, see page 34.

For details, refer to the Interface Manual for Programmers (saved in the supplied CD-ROM, Japanese and English only.)

15 DVI-D input connector (DVI-D)

Inputs DVI Rev.1.0 applicable digital RGB signal.

To view the signals of the SXGA and higher resolution when the DVI input is selected, use the cable within 3 m (118 1/8 inches) in length.

16 HD15 input connector (D-sub 15-pin, female)

Inputs an analog RGB video signal (0.7 Vp-p, positive polarity) and sync signal.

The Plug & Play function corresponds to DDC2B.

Connecting the AC Power Cord

Connect the supplied AC power cord as illustrated. Two kinds of AC plug holders are supplied with this unit. Use the AC plug holder that fits the AC power cord most securely.

- 1 Plug the AC power cord into the AC IN socket on the AC adaptor. Then, attach the AC plug holder to the AC power cord.

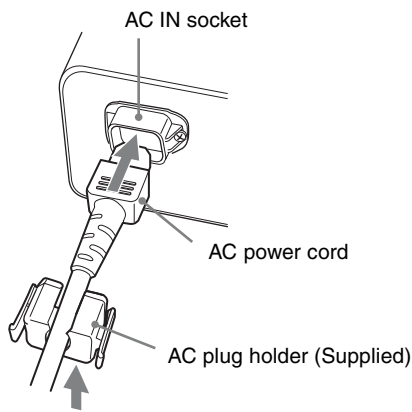

- 2 Slide the AC plug holder over the cord until it locks.

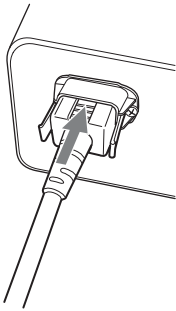

- 3 Insert the DC IN connector into the DC 5V/24V IN connector on the bottom of this unit until it locks.

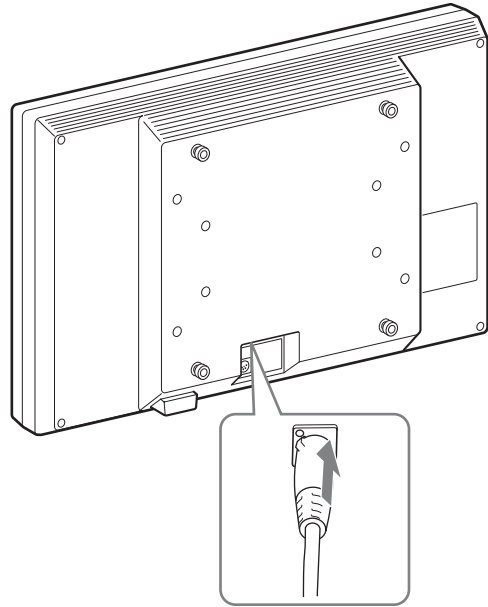

To remove the AC power cord

First, pull out the AC plug holder while pressing the lock levers.

Next, pull out the DC IN connector from the DC 5V/24V IN connector while pressing the lock lever.

Installing the Input Adaptor

Before installing the input adaptor, disconnect the power cord.

- 1 Remove the panel of the optional input slot.

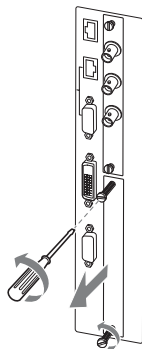

- 2 Insert the input adaptor into the slot.



- 3 Tighten the screws.

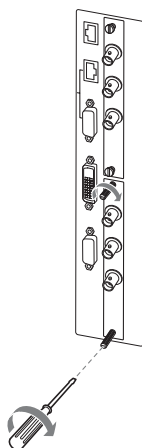

Removing the Connector Cover

When the unit is shipped from the factory, a connector cover is attached to the PARALLEL REMOTE connector and the SERIAL REMOTE connector (RJ-45).

To use the connector, remove the connector cover as follows.

Before removing the connector cover, disconnect the power cord.

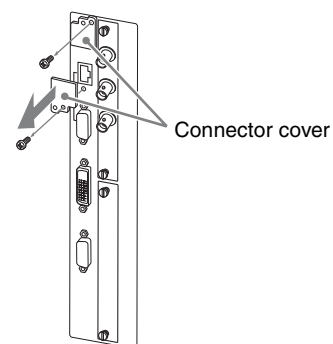

- 1 Remove the screw of the connector cover.

- 2 Remove the connector cover.

Save the screw and cover, so that you can reattach the cover if necessary.

Caution

This connector is designed to allow direct contact with conductive circuits. Weak voltage may be present because of a failure in this unit. To prevent patients from touching this connector accidentally, attach the connector cover when the connector is not being used to connect to other devices.

Selecting the Default Settings

When you turn on the unit for the first time after purchasing it, select the area where you intend to use this unit from among the options.

The default setting values for each area

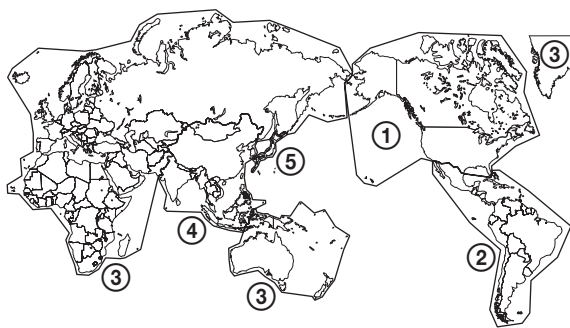

	COLOR TEMP	COMPONENT LEVEL	NTSC SETUP
① NORTH AMERICA	LOW	BETA7.5	7.5
② LATIN AMERICA	ARGENTINA	LOW	SMPTE
	PAL&PAL-N AREA	PARAGUAY	LOW
	URUGUAY	LOW	SMPTE
NTSC&PAL-M AREA	OTHER AREA	LOW	BETA7.5
③ AFRICA AUSTRALASIA EUROPE MIDDLE-EAST	LOW	SMPTE	0
④ ASIA EXCEPT JAPAN	NTSC AREA	LOW	BETA7.5
	PAL AREA	LOW	SMPTE
⑤ JAPAN	HIGH	SMPTE	0

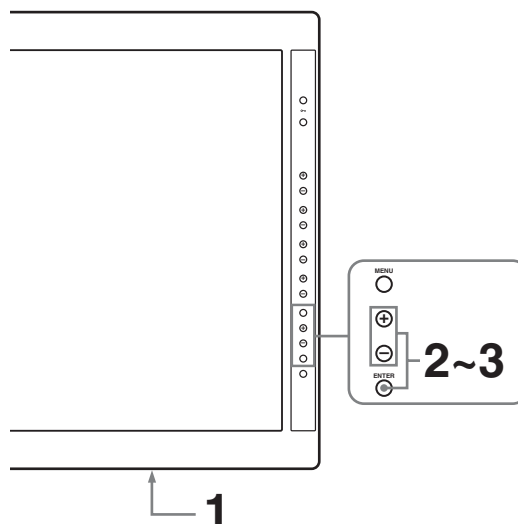

- 1 Turn on the unit with the \odot / \circ (power) switch on the bottom panel.

The SELECT SETTING screen appears.

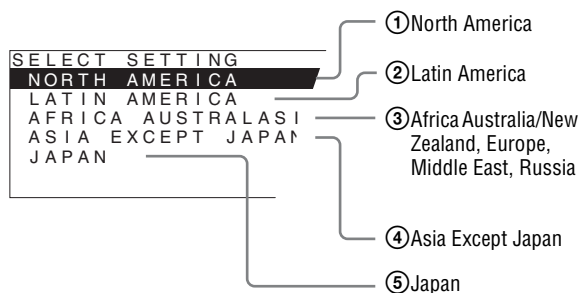

- 2 Press the + or – button to select the area where you intend to use the unit and press the ENTER button.

If you select either ①, ③ or ⑤

The confirmation screen is displayed. Confirm the selected area. When the setting is wrong, press the RETURN button to return to the previous screen.

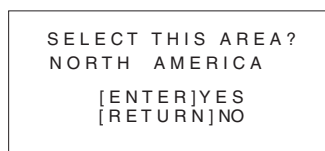

If you select either ② or ④

One of the following screens appears. Press the + or – button to narrow the area further and then press the ENTER button.

The confirmation screen is displayed. Confirm the selected area. When the setting is wrong, press the RETURN button to return to the previous screen.

② If LATIN AMERICA is selected:

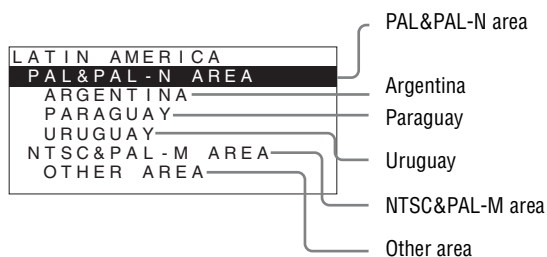

④ If ASIA EXCEPT JAPAN is selected:

Customers who will use this unit in the shaded areas shown in the map below should select NTSC AREA.

Other customers should select PAL AREA.



3 Press the ENTER button.

The SELECT SETTING screen disappears and the menu item settings suitable for the selected area are applied.

Note

When you have selected the wrong area, set the following items using the menu.

- COLOR TEMP (on page 25)
- COMPONENT LEVEL (on page 27)
- NTSC SETUP (on page 27)

See “The default setting values for each area” (page 19) on the setting value.

Selecting the Menu Language

You can select one of seven languages (English, French, German, Spanish, Italian, Japanese, Chinese) for displaying the menu and other on-screen displays. “ENGLISH (English)” is selected in the default setting. The current settings are displayed in place of the ■ marks on the illustrations of the menu screen.

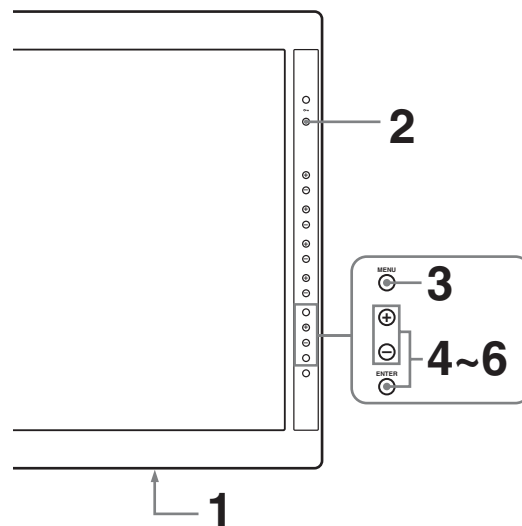

1 Turn on the unit.

2 Press the CONTROL button.

The operation buttons are displayed.

3 Press the MENU button.

The menu appears.

The menu presently selected is shown in yellow.

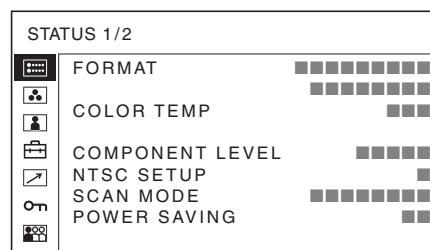

4 Press the + or - button to select SYSTEM SETTING of the USER CONFIG (User Configuration) menu, then press the ENTER button.

The setting items (icons) in the selected menu are displayed in yellow.

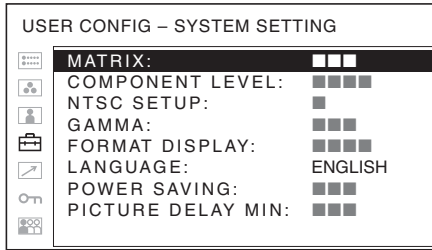

- Press the + or – button to select “LANGUAGE,” then press the ENTER button.

The selected item is displayed in yellow.

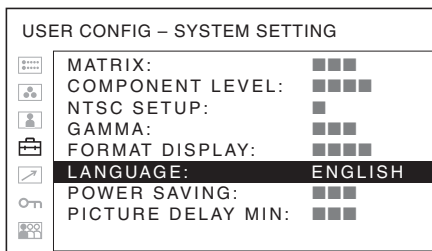

- Press the + or – button to select a language, then press the ENTER button.

The menu changes to the selected language.

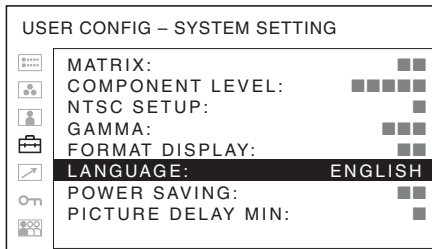

To clear the menu

Press the MENU button.

The menu disappears automatically if a button is not pressed for one minute.

Using the Menu

The unit is equipped with an on-screen menu for making various adjustments and settings such as picture control, input setting, set setting change, etc. You can also change the menu language displayed in the on-screen menu.

To change the menu language, see “Selecting the Menu Language” on page 20.

The current settings are displayed in place of the ■ marks on the illustrations of the menu screen.

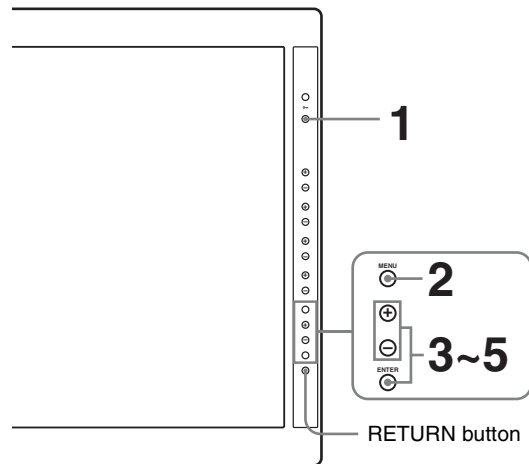

- Press the CONTROL button.

The operation buttons are displayed.

- Press the MENU button.

The menu appears.

The menu presently selected is shown as a yellow button.

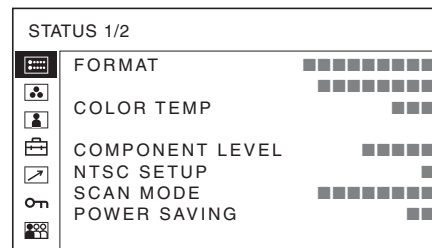

- Use the + or – button to select a menu, then press the ENTER button.

The menu icon presently selected is shown in yellow and setting items are displayed.

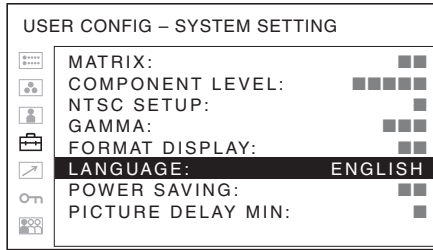

About the memory of the settings

The settings are automatically stored in the monitor memory.

4 Select an item.

Use the + or – button to select the item, then press the ENTER button.

The item to be changed is displayed in yellow.

If the menu consists of multiple pages, press + or – button to go to the desired menu page.

5 Make the setting or adjustment on an item.

When changing the adjustment level:

To increase the number, press the + button.

To decrease the number, press the – button.

Press the ENTER button to confirm the number, then restore the original screen.

When changing the setting:

Press the + or – button to change the setting.

Press the ENTER button to confirm the setting.

When returning the adjustment or setting to the previous value:

Press the RETURN button before pressing the ENTER button.

Notes

- An item displayed in black cannot be accessed. You can access the item if it is displayed in white.
- If the key inhibit has been turned on, all items are displayed in black. To change any of the items, turn the key inhibit to OFF first.

For details on the key inhibit, see page 31.

To return the display to the previous screen

Press the RETURN button.

To clear the menu

Press the MENU button.

The menu disappears automatically if a button is not pressed for one minute.

Loading USER MEMORY

You can load the picture settings saved in the USER MEMORY menu (on page 31).

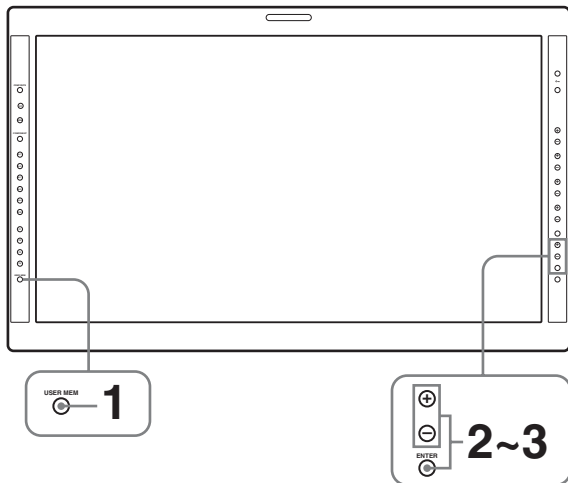

- 1 Press the USER MEM button.

The USER MEMORY menu appears.

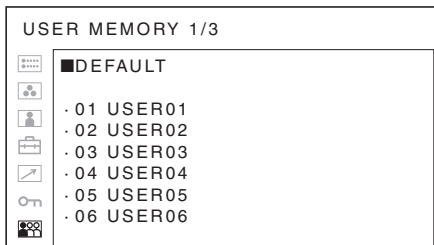

- 2 Select the memory number.

+ or - button: to select the memory number

- 3 Press the ENTER button.

After loading the picture settings from the selected memory, the menu disappears.

To stop selecting the memory

Press the USER MEM button.
The USER MEMORY menu disappears.

To reset the settings

Select "DEFAULT", then press the ENTER button.

Adjustment Using the Menus

Items

The screen menu of this monitor consists of the following items.

 **STATUS** (the items indicate the current settings.)

For the video input

FORMAT
COLOR TEMP
COMPONENT LEVEL
NTSC SETUP
SCAN MODE
POWER SAVING
Model name and serial number
OPTION A and serial number
OPTION B and serial number

For the DVI/HD15 input

FORMAT
fH
fV
COLOR TEMP
POWER SAVING
Model name and serial number
OPTION A and serial number
OPTION B and serial number

COLOR TEMP/SPACE

COLOR TEMP
MANUAL ADJUSTMENT
COLOR SPACE

USER CONTROL

For the video input

AUTO CHROMA/PHASE
SUB CONTROL
PICTURE CONTROL
INPUT SETTING

For the DVI/HD15 input

SUB CONTROL
PICTURE CONTROL

USER CONFIG

SYSTEM SETTING

MATRIX
 COMPONENT LEVEL
 NTSC SETUP
 GAMMA
 FORMAT DISPLAY
 LANGUAGE
 POWER SAVING
 PICTURE DELAY MIN
 MULTI DISPLAY SETTING
 MULTI DISPLAY ENABLE
 MULTI DISPLAY
 SUB INPUT SELECT
 POSITION
 FRAME
 FUNCTION BUTTON SETTING
 F1 BUTTON
 F2 BUTTON
 F3 BUTTON
 F4 BUTTON
 COMPUTER DETECT
 DVI
 HD15

REMOTE

PARALLEL REMOTE
 SERIAL REMOTE

KEY INHIBIT

KEY INHIBIT

USER MEMORY

01 to 20

Adjusting and Changing the Settings

STATUS menu

The STATUS menu is used to display the current status of the unit. The following items are displayed:

For the video input

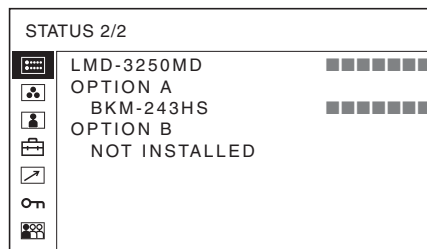
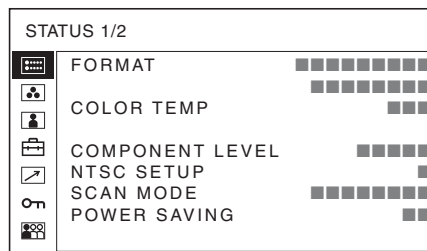

- Signal format
- Color temperature
- Component level
- NTSC setup
- Scan mode
- Power saving
- Model name and serial number
- OPTION A and serial number
- OPTION B and serial number

For the DVI/HD15 input

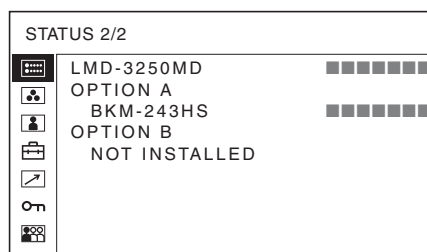
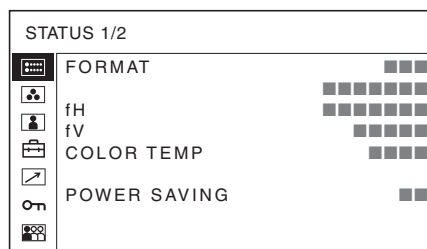

- Signal format
- fH
- fV
- Color temperature
- Power saving
- Model name and serial number
- OPTION A and serial number
- OPTION B and serial number

COLOR TEMP/SPACE menu

The COLOR TEMP/SPACE menu is used for adjusting the picture white balance or color space.

You need to use the measurement instrument to adjust the white balance.

Recommended: Konica Minolta color analyzer CA-210

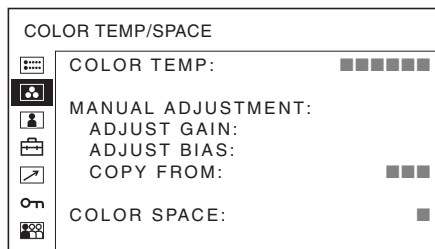

Submenu	Setting
COLOR TEMP	Selects the color temperature from among "HIGH", "LOW" or "USER" and "LOW2" setting.
MANUAL ADJUSTMENT	<p>If you set the COLOR TEMP to USER setting, the item displayed is changed from black to white, which means you can adjust the color temperature.</p> <p>The set values are memorized.</p> <ul style="list-style-type: none"> • ADJUST GAIN: Adjusts the color balance (GAIN). • ADJUST BIAS: Adjusts the color balance (BIAS). • COPY FROM: If you select "HIGH", "LOW" or "LOW2", the white balance data for the selected color temperature will be copied in the "USER" setting.
COLOR SPACE	Selects the color space either ITU-709 or OFF. OFF sets the color space to the original color reproduction of the LCD panel.

USER CONTROL menu

The USER CONTROL menu is used for adjusting the picture.

Items that cannot be adjusted depending on the input signal are displayed in black.

For details of input signals and adjustable/setting items, see page 14.

For the video input

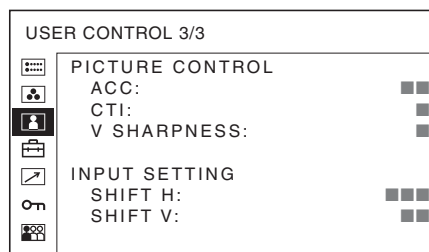
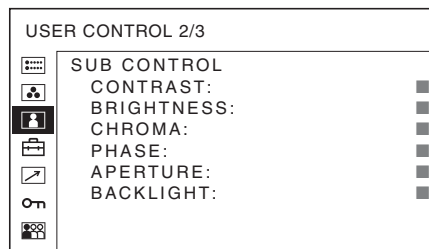
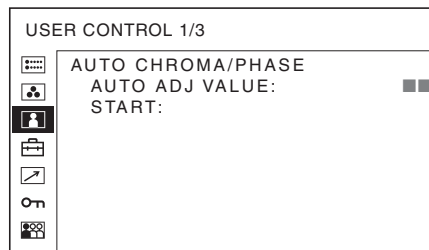

Submenu	Setting
AUTO CHROMA/ PHASE	<p>Adjusts color intensity (CHROMA) and tones (PHASE).</p> <ul style="list-style-type: none"> • AUTO ADJ VALUE: Selects ON or OFF of the auto adjustment. When you set to OFF, this parameter is reset to the factory setting. When you set to ON, the automatically adjusted value is enabled. • START: The auto adjustment starts when you display the color bar signals (Full/SMPTE/EIA) on the screen and press the ENTER button. After adjusting the color intensity, press the MENU button to clear the adjustment screen. After the adjustment is done correctly, the AUTO ADJ VALUE is automatically set to ON.

Submenu	Setting
SUB CONTROL	<p>Adjusts finely the adjustment range of the button on the front panel for CONTRAST, BRIGHTNESS, CHROMA and PHASE.</p> <ul style="list-style-type: none"> • CONTRAST: Adjusts the picture contrast. • BRIGHTNESS: Adjusts the picture brightness. • CHROMA: Adjusts color intensity. The higher the setting, the greater the intensity. The lower the setting, the lower the intensity. • PHASE: Adjusts color tones. The higher the setting, the more greenish the picture. The lower the setting, the more purplish the picture. • APERTURE: Adjusts the picture sharpness. The higher the setting, the sharper the picture. The lower the setting, the softer the picture. • BACKLIGHT: Adjusts the backlight. When the setting is changed, the brightness of the backlight is changed.
PICTURE CONTROL	<p>Adjusts the picture.</p> <ul style="list-style-type: none"> • ACC (Auto Color Control): Sets ACC circuit on or off. To check the fine adjustment, select OFF. Normally select ON. • CTI (Chroma Transient Improvement): When a low color resolution signal is input, a crisp image can be displayed. When the setting is higher, the picture becomes even more crisp. • V SHARPNESS: A crisp image can be displayed. When the setting is higher, the picture becomes even more crisp.
INPUT SETTING	<ul style="list-style-type: none"> • SHIFT H: Adjusts the position of the picture. As the setting increases, the picture moves to the right, and as the setting decreases, the picture moves to the left. • SHIFT V: Adjusts the position of the picture. As the setting increases, the picture moves up, and as the setting decreases, the picture moves down.

For the DVI/HD15 input

* The 1/3 menu cannot be adjusted.

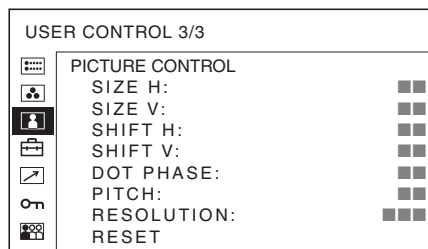
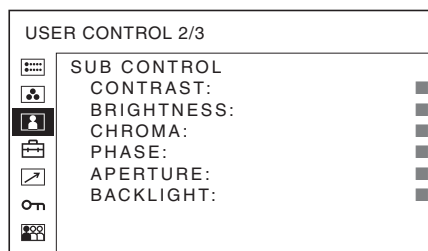

Submenu	Setting
SUB CONTROL	<p>Adjusts finely the adjustment range of the button on the front panel for CONTRAST, BRIGHTNESS, CHROMA and PHASE.</p> <ul style="list-style-type: none"> • CONTRAST: Adjusts the picture contrast. • BRIGHTNESS: Adjusts the picture brightness. • CHROMA: Adjusts color intensity. The higher the setting, the greater the intensity. The lower the setting, the lower the intensity. • PHASE: Adjusts color tones. The higher the setting, the more greenish the picture. The lower the setting, the more purplish the picture. • APERTURE: Adjusts the picture sharpness. The higher the setting, the sharper the picture. The lower the setting, the softer the picture. • BACKLIGHT: Adjusts the backlight. When the setting is changed, the brightness of the backlight is changed.

Submenu	Setting
PICTURE CONTROL	<p>Adjusts to monitor the picture more clearly.</p> <ul style="list-style-type: none"> • SIZE H: Adjusts the horizontal size of the picture. The higher the setting, the larger the horizontal size of the picture. The lower the setting, the smaller the horizontal size of the picture. • SIZE V: Adjusts the vertical size of the picture. The higher the setting, the larger the vertical size of the picture. The lower the setting, the smaller the vertical size of the picture. • SHIFT H: Adjusts the position of the picture. As the setting increases, the picture moves to the right, and as the setting decreases, the picture moves to the left. • SHIFT V: Adjusts the position of the picture. As the setting increases, the picture moves up, and as the setting decreases, the picture moves down. • DOT PHASE: Adjusts the dot phase. Adjust the picture further for a finer picture after APA (page 29) is adjusted. • PITCH: Adjusts the horizontal size of the picture with the left side of the picture fixed. The higher the setting, the larger the width of the picture. The lower the setting, the narrower the width of the picture. • RESOLUTION: Sets when the computer signal is input and it is difficult to understand the signal type such as XGA/60 or WXGA/60 <ul style="list-style-type: none"> • XGA: Displayed as XGA signal. • WXGA: Displayed as WXGA signal. • RESET: Resets the value of SIZE H, SIZE V, SHIFT H, SHIFT V, DOT PHASE and PITCH to the factory preset value.

USER CONFIG menu

The USER CONFIG menu is used for setting the system, multi display, function button and computer detect.

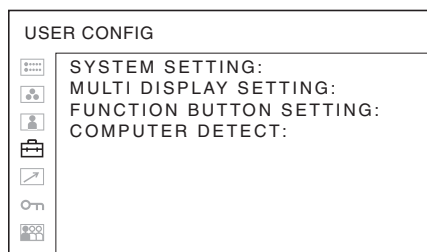

SYSTEM SETTING

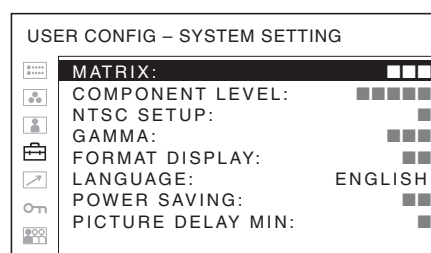

Submenu	Setting
MATRIX	Applied to 480/60I or 480/60P signal. Select 601 or 709.
COMPONENT LEVEL	<p>Selects the component level from among three modes.</p> <ul style="list-style-type: none"> • SMPTE: for 100/0/100/0 signal • BETA0: for 100/0/75/0 signal • BETA7.5: for 100/7.5/75/7.5 signal
NTSC SETUP	<p>Selects the NTSC setup level from two modes.</p> <p>The 7.5 setup level is used mainly in North America. The 0 setup level is used mainly in Japan.</p>
GAMMA	<p>Selects the appropriate gamma mode from between two settings ("2.2", "DICOM").</p> <p>When "2.2" is selected, the setting is roughly same as the gamma mode of the CRT.</p>
FORMAT DISPLAY	<p>Selects the display mode of the signal format and scan mode.</p> <ul style="list-style-type: none"> • ON: The format is always displayed. • OFF: The display is hidden. • AUTO: The format is displayed for about 10 seconds when the input of the signal starts.

Submenu	Setting
LANGUAGE	<p>Selects the menu or message language from among seven languages.</p> <ul style="list-style-type: none"> • ENGLISH: English • FRANÇAIS: French • DEUTSCH: German • ESPAÑOL: Spanish • ITALIANO: Italian • 日本語: Japanese • 中文: Chinese
POWER SAVING	<p>Sets the power saving mode on or off. When you set to ON, the monitor goes into power saving mode if no signal is input for about one minute.</p>
PICTURE DELAY MIN	<p>Selects to set the delay by the picture processing to the minimum level when the interlace signal is input.</p> <ul style="list-style-type: none"> • 0: Mode for giving precedence to the picture quality. It takes longer than “1” or “2” for processing the picture. “0” is the factory setting. • 1: The processing time is short and this is a mode suitable for an animation. Even when the picture is constructed by one field such as the proxy picture of XDCAM, a smooth picture is displayed. • 2: The processing time is shorter. As the line flicker is displayed in this mode, it is available for checking the line flicker of the telop work and so on.

MULTI DISPLAY SETTING

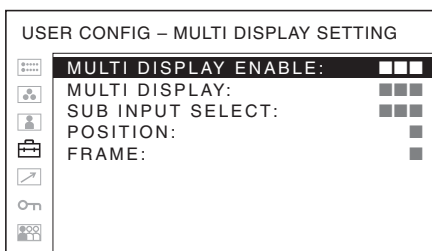

Submenu	Setting
MULTI DISPLAY ENABLE	<p>Selects ON to display the multi display and OFF not to display.</p> <p>Note</p> <p>When the frame frequency of the main display is different from that of the sub display, the picture may be disturbed. When no signal is input to the main display, the picture may not be displayed correctly.</p>
MULTI DISPLAY	<ul style="list-style-type: none"> • POP: The sub display is put by the side of the main display. • SIDE BY SIDE: The main display is put in the left side of the display and the sub display is put in the right side of the display. <p>Notes</p> <ul style="list-style-type: none"> • When the HD15 or DVI signal is input to the main display, SIDE BY SIDE cannot be selected on the menu. • When MULTI DISPLAY is set to SIDE BY SIDE, CTI (page 26) is not available.
SUB INPUT SELECT	<p>Sets the input signal of the sub display. You can select from among COMPOSITE, Y/C, RGB, COMPONENT, OPTION A-1, OPTION A-2, OPTION B-1, OPTION B-2, VIDEO WAVE and OFF.</p> <p>Note</p> <p>The multi display with COMPOSITE and Y/C, RGB and COMPONENT, OPTION A-1 and OPTION A-2, and OPTION B-1 and OPTION B-2 is not displayed. When SUB INPUT SELECT is set to OFF, the sub display is not displayed even if you set MULTI DISPLAY ENABLE to ON.</p>
POSITION	<p>Sets the position of the sub display.</p> <ul style="list-style-type: none"> • 1: Top • 2: Bottom
FRAME	<p>Sets the position of the main display when POP is selected in MULTI DISPLAY.</p> <ul style="list-style-type: none"> • RIGHT: The main display is put by the right side of the sub display. • LEFT: The main display is put by the left side of the sub display.

FUNCTION BUTTON SETTING

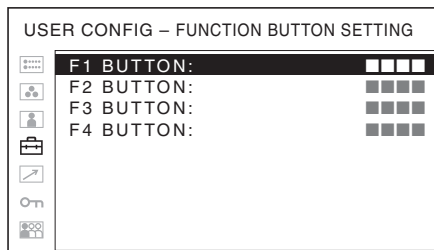

Submenu	Setting
F1 BUTTON to F4 BUTTON	<p>Assigns the function to the function buttons of the front panel and turns the function on or off.</p> <p>You can assign the function from among SCAN, ASPECT, EXT SYNC, BLUE ONLY, MONO, MULTI DISPLAY, APA and MIRROR IMAGE.</p> <p>Factory setting</p> <ul style="list-style-type: none"> • F1 button: EXT SYNC • F2 button: SCAN • F3 button: ASPECT • F4 button: MULTI DISPLAY

About the function assigned to the function button

SCAN

Press to change the scan size of the picture. Press to switch between NORMAL scan (0% scan), OVER scan (20% over scan) and NATIVE (720P only) (see “Scan mode image” on page 29).

ASPECT

Press to set the aspect ratio of the picture, 4:3 or 16:9.

EXT SYNC (external sync)

Press to operate the unit on an external sync signal through the EXT SYNC IN connector. EXT SYNC works when the component/RGB signals are input.

BLUE ONLY

Press the assigned button to eliminate the red and green signals. Only blue signal is displayed as an apparent monochrome picture on the screen. This facilitates “chroma” and “phase” adjustments and observation of VCR noise.

MONO

Press the assigned button to display a monochrome picture. When the buttons is pressed again, the monitor switches automatically to color mode.

MULTI DISPLAY

Press the assigned button to display the multi display. Set the multi display setting in the MULTI DISPLAY SETTING menu (see page 28).

APA (Auto Pixel Alignment)

Press to adjust the picture automatically to maximum clarity for the signal input to the HD15 input connector. For finer according to the input signal, see “DOT PHASE” on page 27.

When the menu screen is displayed, the APA does not function.

Note

If the APA operation does not finish correctly depending on the input signal, adjust DOT PHASE (page 27).

MIRROR IMAGE

Press the assigned button to flip and display the video signal horizontally. This function is not available for the PRESET 1 signal and the multi display.

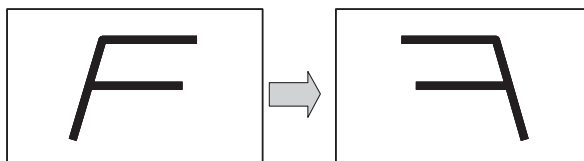

Scan mode image

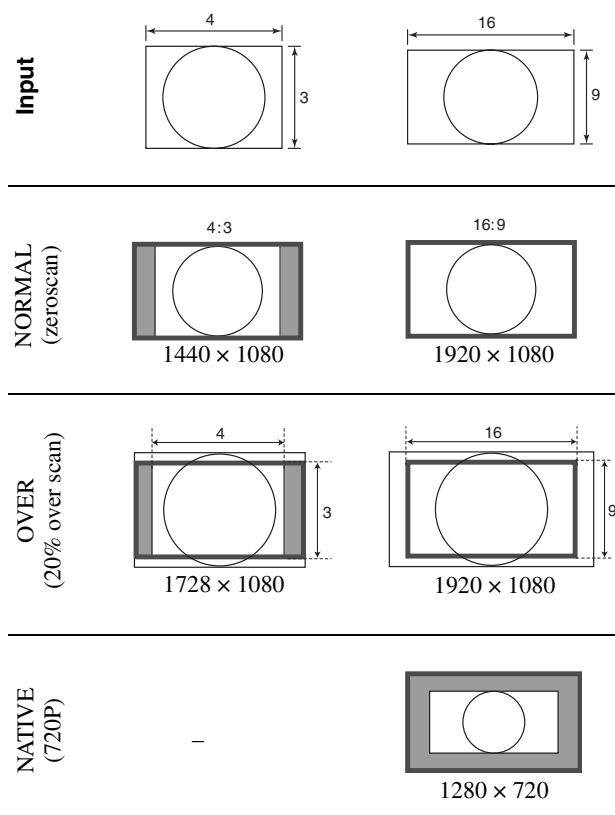

COMPUTER DETECT

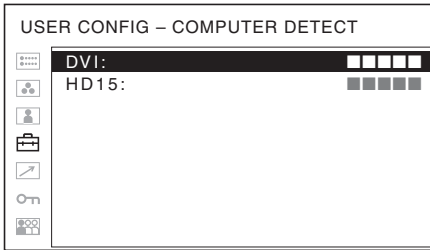

Submenu	Setting
COMPUTER DETECT	<p>The appropriate preset memory is set for the signal from DVI and HD15 input connector. Select "PRESET1" for the standard PC signal. Select "PRESET2" to "PRESET8" when the PC signal is not standard (on page 35).</p> <p>The preset memory is set for each input connector of DVI and HD15.</p> <p>Note</p> <p>"PRESET7" and "PRESET8" will only be displayed when "DVI" is selected.</p>

REMOTE menu

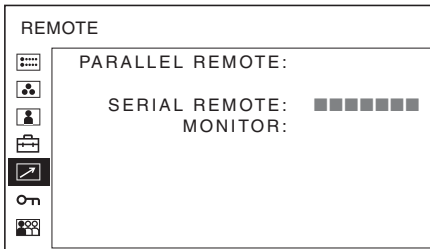

Submenu	Setting
PARALLEL REMOTE	<p>Selects the PARALLEL REMOTE connector pins for which you want to change the function. You can assign various functions to pins 1 to 4 and pins 6 to 8. The following lists the functions you can assign to the pins.</p> <ul style="list-style-type: none"> • ---- ("----": No function is assigned.) • COMPOSITE • Y/C • RGB • COMPONENT • DVI • HD15 • OPTION A-1 • OPTION A-2 • OPTION B-1 • OPTION B-2 • OVERSCAN • NORMAL • NATIVE • 4:3 • 16:9 • TALLY G • EXT SYNC • BLUE ONLY • MONO • MIRROR IMAGE <p>Note</p> <p>If you use the PARALLEL REMOTE function, you need to connect cables. For more details, see page 34.</p>
SERIAL REMOTE	<p>Selects the mode to be used.</p> <ul style="list-style-type: none"> • OFF: SERIAL REMOTE does not function. • RS-232C: The monitor is controlled by the command of RS-232C. • ETHERNET: The monitor is controlled by the command of Ethernet.
MONITOR	<p>Set the monitor setting.</p> <p>IP ADDRESS: Sets the IP address.</p> <p>SUBNET MASK: Sets the subnet mask. (255.255.255.000)</p> <p>DEFAULT GATEWAY: Sets the default gateway on or off.</p> <p>ADDRESS: Sets the default gateway.</p> <p>CANCEL: Selects to cancel the setting.</p> <p>CONFIRM: Selects to save the setting.</p>

KEY INHIBIT menu

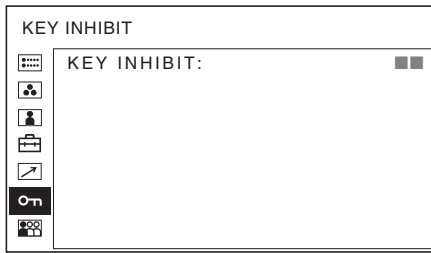

You can lock the setting so that they cannot be changed by an unauthorized user.

Select OFF or ON.

If you set to ON, all items are displayed in black, indicating the items are locked.

USER MEMORY menu

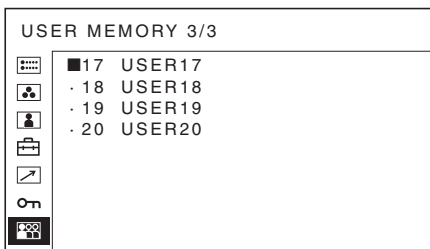
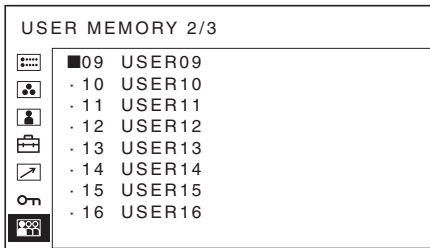
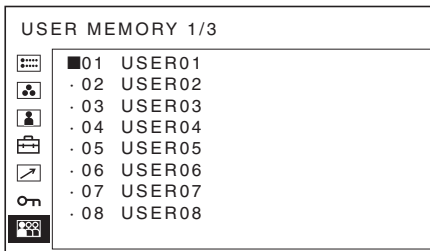

Submenu	Setting
01 to 20	<p>You can save the setting of the following functions.</p> <ul style="list-style-type: none"> • CONTRAST • BRIGHTNESS • CHROMA • PHASE <p>COLOR TEMP/SPACE menu</p> <ul style="list-style-type: none"> • COLOR TEMP • ADJUST GAIN • ADJUST BIAS • COLOR SPACE <p>USER CONTROL menu</p> <ul style="list-style-type: none"> • APERTURE <p>SYSTEM SETTING menu</p> <ul style="list-style-type: none"> • GAMMA • PIC DELAY MIN

Saving the user memory

You can save the 20 picture settings with the name. To load the picture in the saved setting, see “Loading USER MEMORY” on page 23.

To save the picture setting

- 1 Press the + or – button to select the memory number in the USER MEMORY menu, then press the ENTER button.

The USER MEMORY setting menu appears.

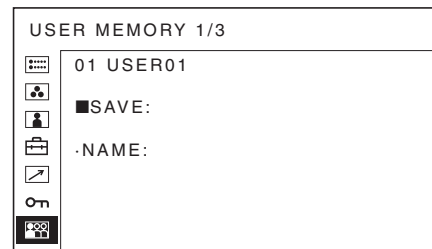

- 2 Select “SAVE”, then press the ENTER button.

The menu for confirming the memory appears.

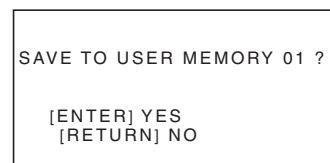

- 3 Press the ENTER button.

The current picture settings are saved and the USER MEMORY setting menu appears.

To close the menu without saving the setting

Press the RETURN button.

The USER MEMORY setting menu appears.

To change the name

- 1 Press the + or – button to select the memory number in the USER MEMORY menu, then press the ENTER button.

The USER MEMORY setting menu appears.

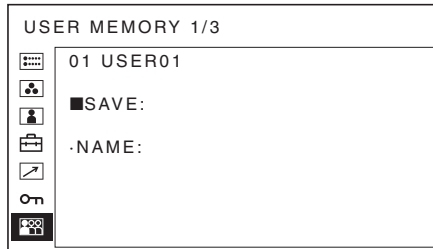

- 2 Press the – button to select “NAME”, then press the ENTER button.

The menu for setting the user name appears.

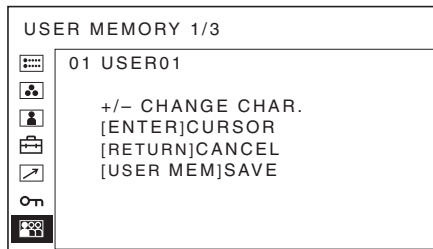

- 3 Change the user name.

- Press the ENTER button to move the cursor to the character position to be changed.
- Press the + or – button to change the character.
Usable characters: “A to Z”, “0 to 9”, “:”, “/”, “,”, “_”, “-”, “(space)”
Usable number of characters: Maximum 18 characters.
- Enter a space to clear the character.
- When the ENTER button is pressed after changing the character, the character is confirmed and the cursor moves to the following character.

- 4 Press the USER MEM button.

The settings are saved and the USER MEMORY setting menu appears.

To close the menu without saving the setting

Press the RETURN button.

The USER MEMORY setting menu appears.

Troubleshooting

This section may help you isolate the cause of a problem and as a result, eliminate the need to contact technical support.

- **The display is colored in green or purple** → Select the correct input by pressing RGB or COMPONENT button.
- **The unit cannot be operated** → The key protection function works. Set the KEY INHIBIT setting to OFF in the KEY INHIBIT menu.

Specifications

Picture performance

LCD panel	a-Si TFT Active Matrix
Pixel efficiency	99.99%
Viewing angle (up/down/left/right, contrast > 10:1)	89°/89°/89°/89° (typical)
Scan	Normal 0% Over scan 20%
Efficient picture size	698.4 × 392.9, 801.3 mm (w/h, dia) (27 ¹ / ₂ × 15 ¹ / ₂ , 31 ⁵ / ₈ inches)
Resolution	H 1920 dots, V 1080 lines
Aspect ratio	16:9

Input

Composite input (NTSC/PAL) connector	BNC type (1) 1 V _{p-p} ± 3 dB sync negative
Y/C input connector	4-pin mini-DIN (1) Y: 1 V _{p-p} ± 3 dB sync negative C: 0.286 V _{p-p} ± 3 dB (NTSC burst signal level) 0.3 V _{p-p} ± 3 dB (PAL burst signal level)
RGB/component input connectors	BNC type (3) RGB input: 0.7 V _{p-p} ± 3 dB (Sync On Green, 0.3 V _{p-p} sync negative) Component input: 0.7 V _{p-p} ± 3 dB (75% chrominance standard color bar signal)
External synchronized input connector	BNC type (1) 0.3 to 4.0 V _{p-p} ± bipolarity ternary or negative polarity binary
HD15 input connector	D-sub 15-pin (1) R/G/B: 0.7 V _{p-p} , sync positive (Sync On Green, 0.3 V _{p-p} sync negative) Sync: TTL level (polarity free, H/V separate sync) Plug & Play function: corresponds to DDC2B
DVI input connector	DVI-D (1) TMDS single link
Remote input connector	Parallel remote Modular connector 8-pin (1) Serial remote D-sub 9-pin (RS-232C) (1) RJ-45 modular connector (ETHERNET) (1)

Optional input slot	2 slots Signal format: H: 15 to 45 kHz V: 48 to 60 Hz
---------------------	----------------------------------------------------------------

DC IN connector	DC5V/24V (output impedance 0.05 ohms or less)
-----------------	-----------------------------------------------

Output

Composite output connector	BNC type (1) Loop-through, with 75 ohms automatic terminal function
Y/C output connector	4-pin mini-DIN (1) Loop-through, with 75 ohms automatic terminal function
RGB/component connectors	BNC type (3) Loop-through, with 75 ohms automatic terminal function
External synchronized output connector	BNC type (1) Loop-through, with 75 ohms automatic terminal function

General

Power	LCD monitor (LMD-3250MD) DC IN: 24 V 5.0 A 5 V 0.060 A (Supplied from AC adaptor) AC adaptor (Sony, AC-110MD) AC IN: 100-240 V, 50/60Hz, 1.53 A to 0.58 A DC OUT: 24 V 5.0 A 5 V 0.060 A
Power consumption	Maximum: approx. 136 W (when two BKM-229X are installed)
Dimensions	Approx. 783 × 479.2 × 124.3 mm (including the projection parts) (30 ⁷ / ₈ × 18 ⁷ / ₈ × 5 inches) (w/h/d)
Mass	LCD monitor (LMD-3250MD) Approx. 13.3 kg (29 lb 5 oz) (when one BKM-243HS is installed, pre-installed) Approx. 13.5 kg (29 lb 12 oz) (when two BKM-229X are installed) AC adaptor (AC-110MD) Approx. 1.2 kg (2 lb 10 oz)
Operating conditions	Temperature 0 °C to 35 °C (32 °F to 95 °F) Recommended temperature 20 °C to 30 °C (68 °F to 86 °F) Humidity 30% to 85% (no condensation) Pressure 700 hPa to 1060 hPa

- Storage and transport temperature
 -20 °C to +60 °C (-4 °F to 140 °F)
- Storage and transport humidity
 0% to 90% (no condensation allowed)
- Storage and transport pressure
 700 hPa to 1060 hPa
- Accessories supplied
- AC adaptor (AC-110MD) (1)
 - AC power cord (1)
 - AC plug holder (2)
 - Instructions for Use (1)
 - CD-ROM (1)
 - Using the CD-ROM Manual (1)
 - Quick Reference (1)
 - When you First Use the Monitor (1)
 - Sales Companies Guide (1)
 - Warranty book (1)
- Optional accessories
- SDI 4:2:2 input adaptor
 BKM-220D
 - HD/D1-SDI input adaptor
 BKM-243HS
 - NTSC/PAL input adaptor
 BKM-227W
 - Analog component input adaptor
 BKM-229X
 - Monitor stand SU-32FW

Medical Specifications

Protection against electric shock:

Class I (No applied parts)

Protection against harmful ingress of water:

Ordinary

Degree of safety in the presence of a flammable anesthetic mixture with air or with oxygen or nitrous oxide:

Not suitable for use in the presence of a flammable anesthetic mixture with air or with oxygen or nitrous oxide

Mode of operation:

Continuous

Design and specifications are subject to change without notice.

Note

Always verify that the unit is operating properly before use. SONY WILL NOT BE LIABLE FOR DAMAGES OF ANY KIND INCLUDING, BUT NOT LIMITED TO, COMPENSATION OR REIMBURSEMENT ON ACCOUNT OF THE LOSS OF PRESENT OR PROSPECTIVE PROFITS DUE TO FAILURE OF THIS UNIT, EITHER DURING THE WARRANTY PERIOD OR AFTER EXPIRATION OF THE WARRANTY, OR FOR ANY OTHER REASON WHATSOEVER.

Pin assignment

PARALLEL REMOTE connector

Modular connector (8-pin)

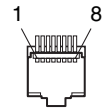

Pin number	Functions
1	Designating Y/C input signal
2	Designating RGB input signal
3	Designating OPTION A-1 input signal
4	Designating OPTION A-2 input signal
5	GND
6	Tally lamp ON/OFF
7	Full screen
8	Over scan

You can allocate functions using the REMOTE menu (see page 30).

Wiring required to use the Remote Control

Connect the function you want to use with a Remote Control to the Ground (Pin 5).

SERIAL REMOTE (RS-232C) connector

D-sub 9-pin, female

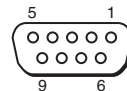

Pin number	Signal
1	NC
2	RX
3	TX
4	NC
5	GND
6	NC
7	RTS
8	CTS
9	NC

Available signal formats

The unit is applicable to the following signal formats.

System	Composite Y/C BKM-227W	RGB Component BKM-229X	BKM-220D	BKM-243HS
575/50I (PAL)	○	○	○	○
480/60I (NTSC)*1	○	○	○	○
576/50P		○		
480/60P		○		
1080/24PsF *1		○*2		○

System	Composite Y/C BKM-227W	RGB Component BKM-229X	BKM- 220D	BKM- 243HS
1080/25PsF		○ ^{*2}		○
1080/24P ^{*1}		○ ^{*2}		○
1080/25P		○ ^{*2}		○
1080/30P ^{*1}		○ ^{*2}		○
1080/50I		○		○
1080/60I ^{*1}		○		○
720/50P		○ ^{*2}		○
720/60P ^{*1}		○		○

*1 The frame rate is also compatible with 1/1.001.

*2 Component only

About the preset signal

This unit has a preset memory for signals connected to the DVI and HD15 input terminals (the preset memory). When a preset signal is input, the unit automatically detects the signal type and recalls the data for the signal from the preset memory to adjust it to an optimum picture.

This unit is applicable to the following preset signals.

PRESET 1

Available HD15 input signal formats

VESA DMT

Resolution	Dot clock [MHz]	fH [kHz]	fV [Hz]	Sync. polarity	
				Horizontal	Vertical
640 × 480 60 Hz	25.175	31.469	59.940	Negative	Negative
800 × 600 56 Hz	36.000	35.156	56.250	Positive	Positive
800 × 600 60 Hz	40.000	37.879	60.317	Positive	Positive
800 × 600 72 Hz	50.000	48.077	72.188	Positive	Positive
800 × 600 75 Hz	49.500	46.875	75.000	Positive	Positive
800 × 600 85 Hz	56.250	53.674	85.061	Positive	Positive
1024 × 768 60 Hz	65.000	48.363	60.004	Negative	Negative
1024 × 768 70 Hz	75.000	56.476	70.069	Negative	Negative
1024 × 768 75 Hz	78.750	60.023	75.029	Positive	Positive
1024 × 768 85 Hz	94.500	68.677	84.997	Positive	Positive
1152 × 864 75 Hz	108.000	67.500	75.000	Positive	Positive
1280 × 960 60 Hz	108.000	60.000	60.000	Positive	Positive
1280 × 1024 60 Hz	108.000	63.981	60.020	Positive	Positive

VESA CVT

Resolution	Dot clock [MHz]	fH [kHz]	fV [Hz]	Sync. polarity	
				Horizontal	Vertical
640 × 480 60 Hz	23.625	29.531	59.780	Positive	Negative
800 × 600 60 Hz	35.500	36.979	59.837	Positive	Negative
1024 × 768 60 Hz	56.000	47.297	59.870	Positive	Negative
1280 × 960 60 Hz	85.250	59.201	59.920	Positive	Negative
1360 × 768 50 Hz	69.500	39.489	49.922	Negative	Positive
1360 × 768 60 Hz	84.625	47.649	59.936	Negative	Positive
1360 × 768 60 Hz	72.000	47.368	59.960	Positive	Negative
1920 × 1080 50 Hz	141.375	55.572	49.975	Negative	Positive
1920 × 1080 60 Hz	138.625	66.647	59.988	Positive	Negative
1280 × 1024 60 Hz	91.000	63.194	59.957	Positive	Negative
1280 × 768 50 Hz	65.125	39.518	49.959	Negative	Positive
1280 × 768 60 Hz	80.125	47.693	59.992	Negative	Positive
1280 × 768 75 Hz	102.875	60.091	74.926	Negative	Positive
1280 × 768 60 Hz	68.250	47.396	59.995	Positive	Negative

Others

Resolution	Dot clock [MHz]	fH [kHz]	fV [Hz]	Sync. polarity	
				Horizontal	Vertical
720 × 400 70 Hz	28.322	31.469	70.087	Negative	Positive
1280 × 800 60 Hz	68.900	48.935	59.969	Negative	Negative

Available DVI input signal formats

Range of DVI input signal (available to 1920 × 1080 / 60Hz) Vertical frequency: 50.0 to 85.1 Hz
 Horizontal frequency: 31.5 to 77.0 kHz
 Dot clock: 25.175 to 148.000 MHz
 Picture size, phase: automatic discrimination by the DE (Data Enable) signal

PRESET 2

	Preset signal	fH [kHz]	fV [Hz]
HD15	1514 × 483	31.5	60
	1476 × 576	31.3	50
	1920 × 1080	33.75	60
	1920 × 1080	28	50
DVI	1280 × 483	31.5	60
	1280 × 576	31.3	50
	1920 × 1080	33.75	60
	1920 × 1080	28	50
	1280 × 720	45.0	60
	1280 × 1024	64.0	60

PRESET 3

	Preset signal	fH [kHz]	fV [Hz]
HD15	720 × 483	31.5	60
	720 × 576	31.3	50
	1280 × 720	45.0	60
	1280 × 720	37.5	50
DVI	720 × 483	31.5	60
	720 × 576	31.3	50
	1280 × 720	45.0	60
	1280 × 720	37.5	50

PRESET 4

	Preset signal	fH [kHz]	fV [Hz]
HD15	640 × 480	31.5	60
	1024 × 768	48.4	60
	1280 × 960	60.0	60
DVI	1024 × 768	48.4	60
	1280 × 960	60.0	60

PRESET 5

	Preset signal	fH [kHz]	fV [Hz]
HD15	640 × 480	31.5	60
	800 × 600	31.3	50
DVI	800 × 600	46.9	75

PRESET 6

	Preset signal	Signal standards
HD15	576/50P	ITU-R BT.1358
	480/60P	SMPTE-293M
	1080/50I	SMPTE-274M
	1080/60I	SMPTE-274M/BTA S-001B
	720/60P	SMPTE-296M
	720/50P	SMPTE-296M
DVI	576/50P	ITU-R BT.1358
	480/60P	SMPTE-293M
	1080/50I	SMPTE-274M
	1080/60I	SMPTE-274M/BTA S-001B
	720/60P	SMPTE-296M
	720/50P	SMPTE-296M

PRESET 7 (Selected using DVI in the menu)

Preset signal	fH [kHz]	fV [Hz]
1422 × 1064	33.75	60
712 × 480	15.734	60
704 × 572	15.625	50

PRESET 8 (Selected using DVI in the menu)

Preset signal	fH [kHz]	fV [Hz]
1280 × 1008	33.75	60
712 × 480	15.734	60
704 × 572	15.625	50

Dimensions

Front

When an optional stand SU-32FW is attached

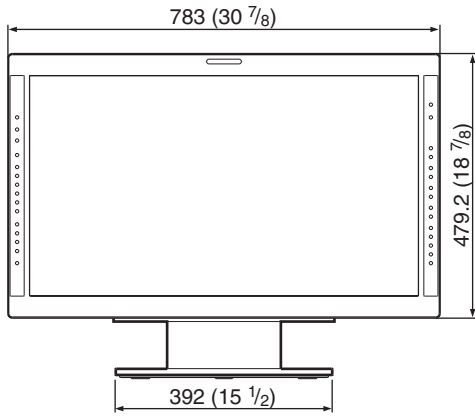

Rear (VESA Mount Instruction)

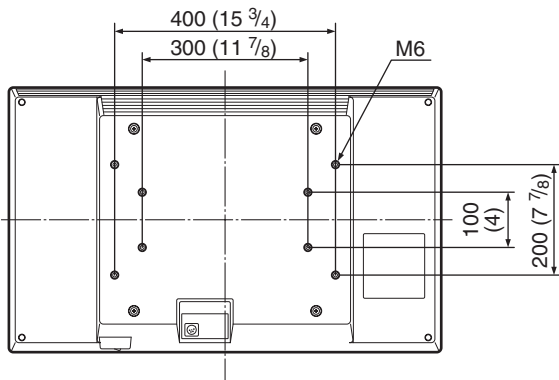

* Length of M6 screws (4)

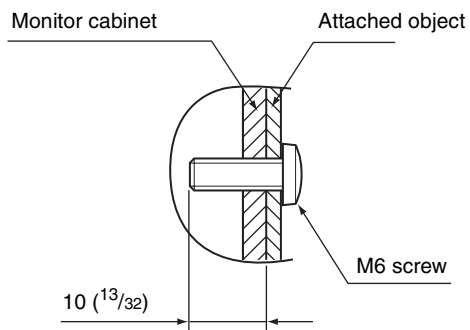

Side

When an optional stand SU-32FW is attached

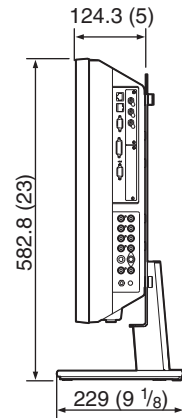

AC adaptor

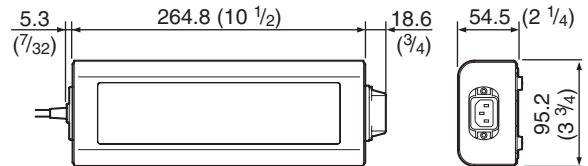

Unit: mm (inches)

Free Manuals Download Website

<http://myh66.com>

<http://usermanuals.us>

<http://www.somanuals.com>

<http://www.4manuals.cc>

<http://www.manual-lib.com>

<http://www.404manual.com>

<http://www.luxmanual.com>

<http://aubethermostatmanual.com>

Golf course search by state

<http://golfingnear.com>

Email search by domain

<http://emailbydomain.com>

Auto manuals search

<http://auto.somanuals.com>

TV manuals search

<http://tv.somanuals.com>