

TASCAM

TEAC Professional Division

3D0050600A

CC-222

CD Recorder/Cassette Deck

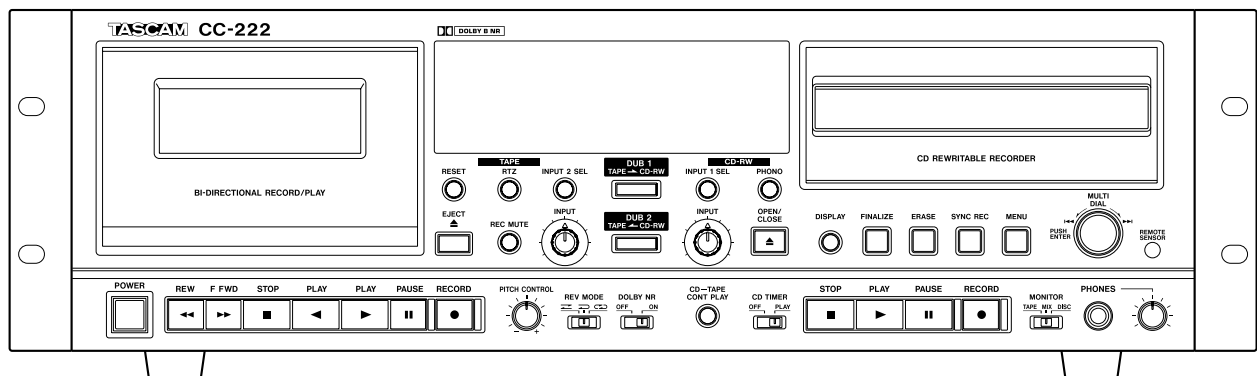

OWNER'S MANUAL



CAUTION
RISK OF ELECTRIC SHOCK
DO NOT OPEN

CAUTION: TO REDUCE THE RISK OF ELECTRIC SHOCK, DO NOT REMOVE COVER (OR BACK). NO USER-SERVICEABLE PARTS INSIDE. REFER SERVICING TO QUALIFIED SERVICE PERSONNEL.



The lightning flash with arrowhead symbol, within an equilateral triangle, is intended to alert the user to the presence of uninsulated "dangerous voltage" within the product's enclosure that may be of sufficient magnitude to constitute a risk of electric shock to persons.



The exclamation point within an equilateral triangle is intended to alert the user to the presence of important operating and maintenance (servicing) instructions in the literature accompanying the appliance.

This appliance has a serial number located on the rear panel. Please record the model number and serial number and retain them for your records.
Model number _____
Serial number _____

WARNING: TO PREVENT FIRE OR SHOCK HAZARD, DO NOT EXPOSE THIS APPLIANCE TO RAIN OR MOISTURE.

Important Safety Precautions

IMPORTANT (for U.K. Customers)

DO NOT cut off the mains plug from this equipment.

If the plug fitted is not suitable for the power points in your home or the cable is too short to reach a power point, then obtain an appropriate safety approved extension lead or consult your dealer.

If nonetheless the mains plug is cut off, remove the fuse and dispose of the plug immediately, to avoid a possible shock hazard by inadvertent connection to the mains supply.

If this product is not provided with a mains plug, or one has to be fitted, then follow the instructions given below:

IMPORTANT: DO NOT make any connection to the larger terminal which is marked by the letter E or by the safety earth symbol \perp or coloured GREEN or GREEN-and-YELLOW.

The wires in this mains lead are coloured in accordance with the following code:

BLUE : NEUTRAL
BROWN : LIVE

As the colours of the wires in the mains lead of this apparatus may not correspond with the coloured markings identifying the terminals in your plug proceed as follows:

The wire which is coloured BLUE must be connected to the terminal which is marked with the letter N or coloured BLACK.

The wire which is coloured BROWN must be connected to the terminal which is marked with the letter L or coloured RED.

When replacing the fuse only a correctly rated approved type should be used and be sure to re-fit the fuse cover.

IF IN DOUBT — CONSULT A COMPETENT ELECTRICIAN.

For Canada

AC POWER CORD CONNECTION

CAUTION:

TO PREVENT ELECTRIC SHOCK, MATCH WIDE BLADE OF PLUG TO WIDE SLOT, FULLY INSERT.

CORDE DE CONNEXION CA

ATTENTION:

POUR ÉVITER LES CHOCS ÉLECTRIQUES, INTRODUIRE LA LAME LA PLUS LARGE DE LA FICHE DANS LA BORNE CORRESPONDANTE DE LA PRISE ET POUSSER JUSQU'AU FOND.

For U.S.A

TO THE USER

This equipment has been tested and found to comply with the limits for a Class A digital device, pursuant to Part 15 of the FCC Rules. These limits are designed to provide reasonable protection against harmful interference when the equipment is operated in a commercial environment. This equipment generates, uses, and can radiate radio frequency energy and, if not installed and used in accordance with the instruction manual, may cause harmful interference to radio communications.

Operation of this equipment in a residential area is likely to cause harmful interference in which case the user will be required to correct the interference at his own expense.

CAUTION

Changes or modifications to this equipment not expressly approved by TEAC CORPORATION for compliance could void the user's authority to operate this equipment.

For the consumers in Europe

WARNING

This is a Class A product. In a domestic environment, this product may cause radio interference in which case the user may be required to take adequate measures.

Pour les utilisateurs en Europe

AVERTISSEMENT

Il s'agit d'un produit de Classe A. Dans un environnement domestique, cet appareil peut provoquer des interférences radio, dans ce cas l'utilisateur peut être amené à prendre des mesures appropriées.

Für Kunden in Europa

Warnung

Dies is eine Einrichtung, welche die Funk-Entstörung nach Klasse A besitzt. Diese Einrichtung kann im Wohnbereich Funkstörungen verursachen ; in diesem Fall kann vom Betreiber verlang werden, angemessene Maßnahmen durchzuführen und dafür aufzukommen.

IMPORTANT SAFETY INSTRUCTIONS

CAUTION:

- Read all of these Instructions.
- Save these Instructions for later use.
- Follow all Warnings and Instructions marked on the audio equipment.

- 1) Read Instructions** — All the safety and operating instructions should be read before the product is operated.
- 2) Retain Instructions** — The safety and operating instructions should be retained for future reference.
- 3) Heed Warnings** — All warnings on the product and in the operating instructions should be adhered to.
- 4) Follow Instructions** — All operating and use instructions should be followed.
- 5) Cleaning** — Unplug this product from the wall outlet before cleaning. Do not use liquid cleaners or aerosol cleaners. Use a damp cloth for cleaning.
- 6) Attachments** — Do not use attachments not recommended by the product manufacturer as they may cause hazards.
- 7) Water and Moisture** — Do not use this product near water — for example, near a bath tub, wash bowl, kitchen sink, or laundry tub; in a wet basement; or near a swimming pool; and the like.
- 8) Accessories** — Do not place this product on an unstable cart, stand, tripod, bracket, or table. The product may fall, causing serious injury to a child or adult, and serious damage to the product. Use only with a cart, stand, tripod, bracket, or table recommended by the manufacturer, or sold with the product. Any mounting of the product should follow the manufacturer's instructions, and should use a mounting accessory recommended by the manufacturer.
- 9)** A product and cart combination should be moved with care. Quick stops, excessive force, and uneven surfaces may cause the product and cart combination to overturn.



- 10) Ventilation** — Slots and openings in the cabinet are provided for ventilation and to ensure reliable operation of the product and to protect it from overheating, and these openings must not be blocked or covered. The openings should never be blocked by placing the product on a bed, sofa, rug, or other similar surface. This product should not be placed in a built-in installation such as a bookcase or rack unless proper ventilation is provided or the manufacturer's instructions have been adhered to.
- 11) Power Sources** — This product should be operated only from the type of power source indicated on the marking label. If you are not sure of the type of power supply to your home, consult your product dealer or local power company. For products intended to operate from battery power, or other sources, refer to the operating instructions.
- 12) Grounding or Polarization** — This product may be equipped with a polarized alternating-current line plug (a plug having one blade wider than the other). This plug will fit into the power outlet only one way. This is a safety feature. If you are unable to insert the plug fully into the outlet, try reversing the plug. If the plug should still fail to fit, contact your electrician to replace your obsolete outlet. Do not defeat the safety purpose of the polarized plug.
- 13) Power-Cord Protection** — Power-supply cords should be routed so that they are not likely to be walked on or pinched by items placed upon or against them, paying particular attention to cords at plugs, convenience receptacles, and the point where they exit from the product.
- 14) Outdoor Antenna Grounding** — If an outside antenna or cable system is connected to the product, be sure the antenna or cable system is grounded so as to provide some protection against voltage surges and built-up static charges. Article 810 of the National Electrical Code, ANSI/NFPA 70, provides information with regard to proper grounding of the mast and supporting structure, grounding of the lead-in wire to an antenna discharge unit, size of grounding conductors, location of antenna-discharge unit, connection to grounding electrodes, and requirements for the grounding electrode.

"Note to CATV system installer:

This reminder is provided to call the CATV system installer's attention to Section 820-40 of the NEC which provides guidelines for proper grounding and, in particular, specifies that the cable ground shall be connected to the grounding system of the building, as close to the point of cable entry as practical.

Example of Antenna Grounding as per National Electrical Code, ANSI/NFPA 70

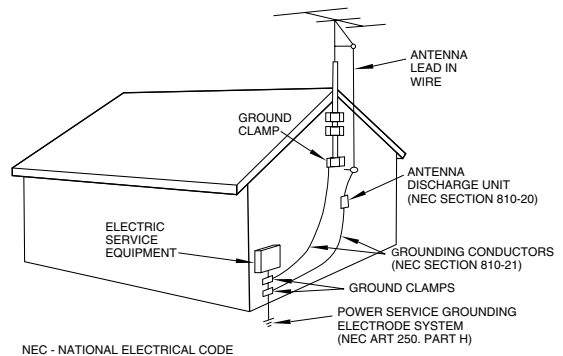

- 15) Lightning** — For added protection for this product during a lightning storm, or when it is left unattended and unused for long periods of time, unplug it from the wall outlet and disconnect the antenna or cable system. This will prevent damage to the product due to lightning and power-line surges.
- 16) Power Lines** — An outside antenna system should not be located in the vicinity of overhead power lines or other electric light or power circuits, or where it can fall into such power lines or circuits. When installing an outside antenna system, extreme care should be taken to keep from touching such power lines or circuits as contact with them might be fatal.
- 17) Overloading** — Do not overload wall outlets, extension cords, or integral convenience receptacles as this can result in risk of fire or electric shock.
- 18) Object and Liquid Entry** — Never push objects of any kind into this product through openings as they may touch dangerous voltage points or short-out parts that could result in a fire or electric shock. Never spill liquid of any kind on the product.
- 19) Servicing** — Do not attempt to service this product yourself as opening or removing covers may expose you to dangerous voltage or other hazards. Refer all servicing to qualified service personnel.
- 20) Damage Requiring Service** — Unplug this product from the wall outlet and refer servicing to qualified service personnel under the following conditions:
 - a) when the power-supply cord or plug is damaged.
 - b) if liquid has been spilled, or objects have fallen into the product.
 - c) if the product has been exposed to rain or water.
 - d) if the product does not operate normally by following the operating instructions. Adjust only those controls that are covered by the operating instructions as an improper adjustment of other controls may result in damage and will often require extensive work by a qualified technician to restore the product to its normal operation.
 - e) if the product has been dropped or damaged in any way.
 - f) when the product exhibits a distinct change in performance — this indicates a need for service.
- 21) Replacement Parts** — When replacement parts are required, be sure the service technician has used replacement parts specified by the manufacturer or have the same characteristics as the original part. Unauthorized substitutions may result in fire, electric shock, or other hazards.
- 22) Safety Check** — Upon completion of any service or repairs to this product, ask the service technician to perform safety checks to determine that the product is in proper operating condition.
- 23) Wall or Ceiling Mounting** — The product should be mounted to a wall or ceiling only as recommended by the manufacturer.
- 24) Heat** — The product should be situated away from heat sources such as radiators, heat registers, stoves, or other products (including amplifiers) that produce heat.

SAFETY INFORMATION

This product has been designed and manufactured according to FDA regulations "title 21, CFR, chapter 1, subchapter J, based on the Radiation Control for Health and Safety Act of 1968", and is classified as a class 1 laser product. There is no hazardous invisible laser radiation during operation because invisible laser radiation emitted inside of this product is completely confined in the protective housings.

The label required in this regulation is shown in ①.

CAUTION

- DO NOT REMOVE THE PROTECTIVE HOUSING USING A SCREWDRIVER.
- USE OF CONTROLS OR ADJUSTMENTS OR PERFORMANCE OF PROCEDURES OTHER THAN THOSE SPECIFIED HEREIN MAY RESULT IN HAZARDOUS RADIATION EXPOSURE.
- IF THIS PRODUCT DEVELOPS TROUBLE, CONTACT YOUR NEAREST QUALIFIED SERVICE PERSONNEL, AND DO NOT USE THE PRODUCT IN ITS DAMAGED STATE.



For U.S.A.

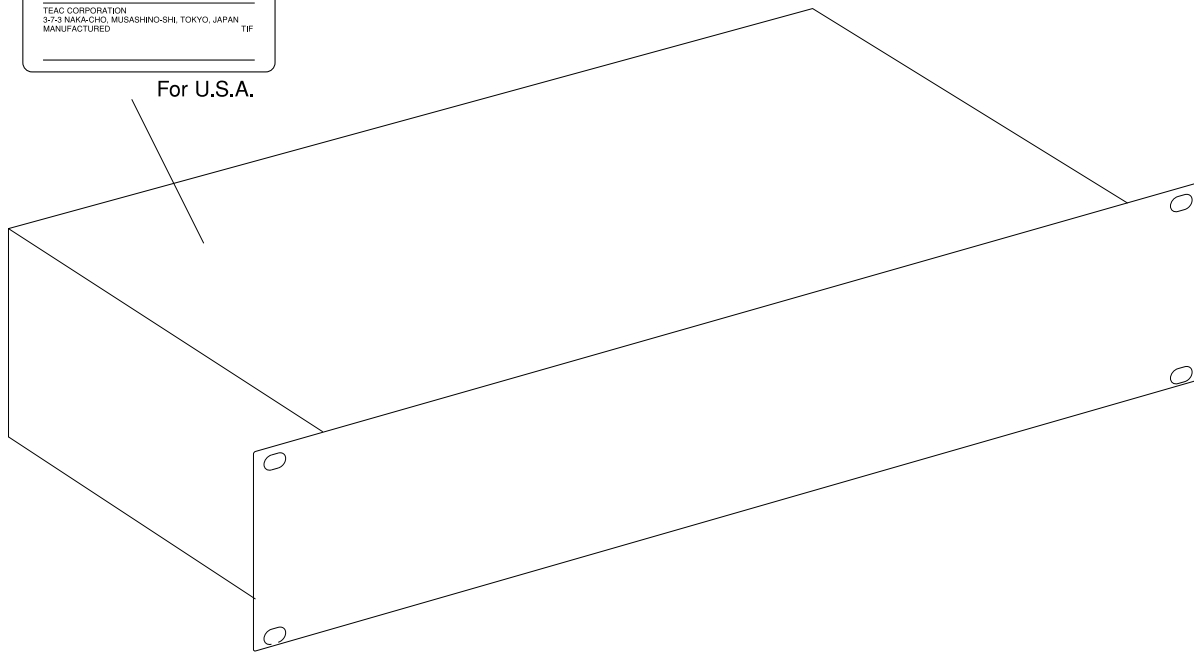

Optical pickup: Type : KRS-202A or KRS-220B
Manufacturer : SONY Corporation
Laser output : Less than 0.1 mW (Play) and 32 mW (Record) on the objective lens
Wavelength : 777 - 787 nm

1 – Introduction	
Supplied accessories	6
Some notes and precautions	6
Rack-mounting the unit	7
Environmental considerations	7
Beware of condensation	7
About tapes	7
About CD-R and CD-RW discs	8
Finalizing	8
"Recordable" discs	8
Handling of compact discs	9
Additional notes with regard to CD-R and CD-RW discs	9
Never use a stabilizer or printable discs	9
Recommended media	10
Use of the remote control unit	10
About this manual	10
1, "Introduction"	10
2, "Features and controls"	10
3, "Cassette operations"	10
4, "CD player"	10
5, "Recording CDs"	10
6, "After recording"	10
7, "Reference and specifications"	10
2 – Features and controls	
Rear panel features	12
Remote control features	13
3 – Cassette operations	
Playback operations	15
Continuous tape/CD playback	15
Recording operations	16
Dubbing tapes from the CD deck	16
If the tape is in stop mode	16
If the tape is in record pause mode	16
Dubbing to tape from the middle of a CD	17
Bypassing the INPUT level for dubbing	17
Recording tapes from the PHONO deck ...	17
Other recording features	18
Recording silences between items	18
Erasing tapes	18
Other tape functions and features	18
Tape counter	18
Pitch control	18
Fast forward and rewind	19
Search keys	19
4 – CD player	
Simple playback operations	20
Time display modes	20
Track search	20
Playback modes	21
Programmed order playback	21
Repeat play	22
Setting the A and B repeat points	22
Intro check	22
Auto spacing	23
5 – Recording CDs	
Input selection	24
Signal volume	24
Input monitoring	24
Frequency conversion	24
Basic recording	25
Playing back tracks	26
Time display while recording	26
Manual track division	26
Restricting the number of tracks	26
Full disc	26
Dubbing from tape to disc	27
Dubbing to CD from the middle of the tape	27
Recording to disc from the RIAA	
PHONO inputs	27
Advanced recording	28
Setting the trigger level	28
Using the trigger level	29
Synchronized recording	30
Automatic track division	31
Digital direct	32
Rec mute function	32
Fade-in and fade-out	32
To perform a fade-in:	32
To perform a fade-out:	32
Copy-protection	33
6 – After recording	
Finalizing	34
Unfinalizing CD-RW discs	34
Erasing	34
Erasing tracks	35
Erasing a whole disc	35
Refreshing a disc	35
7 – Reference and specifications	
Troubleshooting	37
Menu items	38
Resetting default menu values	38
Specifications	39
CD recorder section	39
Cassette recorder section	39
Phono input and headphones	40
Dimensional drawing	41
Tape maintenance	41
Cleaning the tape path	41
Demagnetizing heads	41

1 – Introduction

The CC-222 provides you with an advanced system for the recording and playback of digital compact discs and analog cassettes, providing easy duplication facilities in both directions, and combining the most advanced technology in both fields.

Additional audio units, both analog and digital, can be connected easily through the rear panel connections, allowing the recording of other sources.

Additionally, the CC-222 is fitted with a dedicated phono connection, which eliminates the need for an additional RIAA-equipped amplifier when archiving vinyl recordings.

TASCAM's legendary attention to detail provides a high-quality full-featured cassette tape deck, complete with Dolby noise reduction circuitry.¹

24-bit digital-to-analog and analog-to-digital converters provide excellent recording and playback quality for the CD recorder.

A sampling frequency convertor is incorporated, allowing the recording of CDs from digital audio

1. Dolby noise reduction manufactured under license from Dolby Laboratories Licensing Corporation.
“DOLBY” and the double-D  symbol are trademarks of Dolby Laboratories Licensing Corporation.

sources which are at frequencies other than the CD standard sampling frequency of 44.1 kHz.

Disc track divisions can be entered manually, or can be produced automatically as a response to the input signal level.

“One-touch” fade-ins and fade-outs over a specified time allow you to edit program material to your specific requirements.

A multi-function “multi dial” is used to set and confirm parameter settings.

A convenient wireless remote control unit provides additional functionality and permits the operation of the unit from a distance.

NOTE

This product is designed to help you record and reproduce sound works to which you own the copyright, or where you have obtained permission from the copyright holder or the rightful licensor. Unless you own the copyright, or have obtained the appropriate permission from the copyright holder or the rightful licensor, your unauthorized recording, reproduction or distribution thereof may result in severe criminal penalties under copyright laws and international copyright treaties. If you are uncertain about your rights, contact your legal advisor. Under no circumstances will TEAC Corporation be responsible for the consequences of any illegal copying performed using the CC-222.

Supplied accessories

As well as this manual, you should also find a RC-222 remote control unit packed with the unit. Only use this remote control unit with the CC-222.

Some notes and precautions

Treat the CC-222 as you would any other piece of precision equipment.

Avoid exposing it to extremes of temperature and humidity and avoid mechanical shocks and vibration.

Keep the unit away from strong magnetic fields (TV sets, computer monitors, large electric motors, etc.).

1 – Introduction—Some notes and precautions

Rack-mounting the unit

Use the rack-mounting kit to mount the unit in a standard 19-inch equipment rack, as shown below. Remove the feet of the unit before mounting it.

See “Environmental considerations” on page 7 below for details of ventilation, etc.

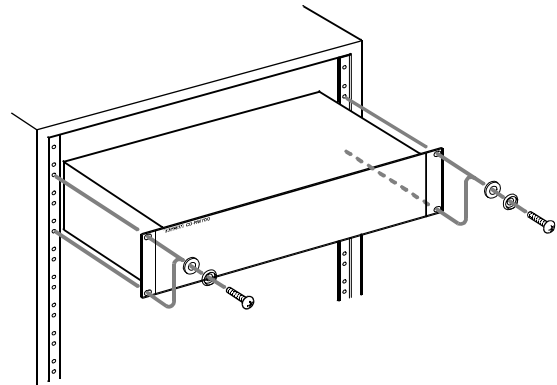

Environmental considerations

The CC-222 may be used in most areas, but to maintain top performance, and prolong operating life, observe the following environmental conditions:

The nominal temperature should be between 5°C and 35°C (41°F and 95°F). The CC-222 is more sensitive to extremes of temperature than ordinary CD players.

Relative humidity should be 30 to 90 degrees non-condensing.

As the unit may become hot during operation, always leave sufficient space above the unit for ventilation. If you are mounting the unit in a rack, leave 1U of space above it. Allow at least 10 cm (4 in) at the rear of the unit for ventilation.

You should not place the unit on a piece of equipment generating heat, e.g. an amplifier, to avoid possible problems with overheating.

Make sure that the unit is mounted in a level position for correct operation. Do not mount the unit in a rack tilted 5° or more from the vertical position.

NOTE

If the mounting surface is more than 5 degrees away from the horizontal, the tray will not open or close.

The voltage supplied to the unit should match the voltage as printed on the rear panel. If you are in any doubt regarding this matter, consult an electrician.

NOTE

When transporting the unit, always use the original packing materials. For this reason, we strongly recommend that you save all the packing materials that came with the CC-222, in case you need to transport it in the future.

In addition, when transporting the unit, you should tape the disc tray closed, using an adhesive tape that will not spoil the finish of the unit.

Beware of condensation

If the unit (or a compact disc) is moved from a cold to a warm place, or used after a sudden temperature change, there is a danger of condensation; vapor in the air could condense on the internal mechanism,

making correct operation impossible. To prevent this, or if this occurs, leave the player for one or two hours with the power turned on, then turn the power off and on again.

About tapes

Do not store tapes in the following places:

- On top of heaters, exposed to direct sunlight, or in any other places with high temperatures.
- Near speakers, on TV sets or amplifiers or where they would be exposed to strong magnetic fields.

- Where humidity is high, or in dirty, dusty places.
- Avoid dropping or subjecting cassettes to excessive shocks.

As C-120 tapes are mechanically weak, and could become entangled in the transport mechanism, we do not recommend their use.

1 – Introduction—Finalizing

For the automatic tape selection function to work properly, metal and high position (cobalt) tapes must have the appropriate identification holes.

Note that Type I (normal), Type II (high-position/chrome) and Type IV (metal) tapes can be played back. Recording is possible with Type I (normal) and Type II (high-position/chrome) tapes.

About CD-R and CD-RW discs

The CC-222 uses CD-R and CD-RW media, and can also use CD-R and CD-RW Digital Audio media.

In this manual, when we refer to “CD-R” and CD-RW” discs, we always include “CD-R Digital Audio” and “CD-RW Digital Audio”, even when this is not explicitly stated.

CD-R discs can be recorded once only. Once they have been used for recording, they cannot be erased or re-recorded. However, if space is available on the disc, additional material can be recorded. The packaging of CD-R discs will include one of the following logos:



By contrast, a CD-RW disc can be used in much the same way as a CD-R disc, but the last track or tracks

recorded can be erased before the disc has been “finalized”, and the space on the disc can be re-used for other recordings. The packaging of CD-RW discs will include one of the following logos:



However, you should note that an audio CD created using a CD-RW disc may not play back satisfactorily on every audio CD player. It will, naturally, be playable on the CC-222. This is in no way a limitation of the CC-222 itself, but of the difference between the different types of media and the methods used to read them.

CD-R discs created on the CC-222, by contrast, may be played satisfactorily on the majority of audio CD players.

Finalizing

Although audio data may be written on a CD-R or CD-RW disc, a standard CD player will not be able to read the data (i.e. play back the audio) until a final table of contents (TOC) has been written at the start of the disc.

The process of writing this table of contents is known as “finalizing”. Once this has been done, no further data can be written to the disk. See “Finalizing” on page 34 for details.

In the case of a CD-RW disc which has been finalized, the whole of the disc may be erased, or the disc may be “refreshed”, and the disc re-used.

In addition, a CD-RW disc that has been finalized may be “unfinalized”, i.e. the TOC is removed. This allows further tracks to be recorded to the disc, provided that there is space on the disc.

“Recordable” discs

In this manual, we use the term “recordable” disc to describe a CD-R or CD-RW disc that has not been

finalized, i.e. further recording is possible on the disc.

Handling of compact discs

Observe the following:

- Always place compact discs in the tray with their label facing upward (compact discs can only be played on one side).
- To remove a disc from its storage case, press down on the center of the case, and lift the disc out, holding it carefully by the edges.

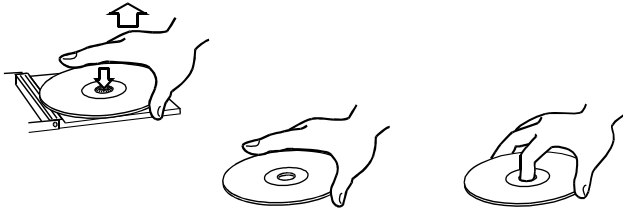

- Finger marks and dust should be carefully wiped off the disc's recorded surface with a soft cloth. Unlike conventional records, the compact disc has no grooves to collect dust and microscopic debris, so gently wiping with a soft cloth should remove most particles.
- Wipe in a straight motion from the inside to the outside of the disc. Small dust particles and light

stains will have absolutely no effect on reproduction quality.



- Never use such chemicals as record sprays, anti-static sprays or fluid, benzine or thinner to clean compact discs. Such chemicals will do irreparable damage to the disc's plastic surface.
- Discs should be returned to their cases after use to avoid serious scratches that could cause the laser pickup to "skip".
- Don't expose discs to direct sunlight or high humidity and temperature for extended periods. Long exposure to high temperature can warp the disc.
- Only use circular compact discs. Avoid using non-circular promotional, etc. discs.

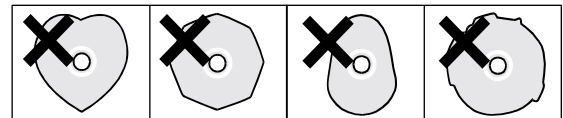

- To keep the laser pickups clean, don't touch them. For the same reason, don't leave the disc trays opened unnecessarily.

Additional notes with regard to CD-R and CD-RW discs

There are additional precautions that you should take when handling CD-R and CD-RW discs, that are different to those that you should take when handling ordinary CDs.

- Avoid touching the recording (non-label) side of a disc on which you will be recording. Recording on a disc requires a cleaner surface than playing back, and fingerprints, grease, etc. can cause errors in the recording process.
- CD-R discs are more sensitive to the effects of heat and ultraviolet rays than ordinary CDs. It is important that they are not stored in a location where direct sunlight will fall on them, and which is away from sources of heat such as radiators or heat-generating electrical devices.

- Always store CD-R discs in their "jewel cases" to avoid dirt and dust accumulating on their surfaces.
- Do not put labels or protective sheets on the discs and do not use any protective coating spray.
- When labeling CD-R discs, always use a soft oil-based felt-tipped pen to write the information. Never use a ball-point or hard-tipped pen, as this may cause damage to the recorded side.
- Dirty discs may be cleaned using a soft dry cloth and/or a commercial CD cleaning fluid or ethyl alcohol. Do not use thinner, gasoline, benzene or LP cleaning fluid, as these will damage the disc.
- If you are in any doubt as to the care and handling of a CD-R disc, read the precautions supplied with the disc, or contact the disc manufacturer directly.

Never use a stabilizer or printable discs

Using commercially available CD stabilizers or printable recordable discs with this player will damage the mechanism and cause it to malfunction.

1 – Introduction—About this manual

NOTE

Never use a disc that has had a stabilizer mounted to it. The residual adhesive may cause the disc to stick to the mechanism of the CC-222. If it sticks to the mechanism, you will need a technician to get it out.

Recommended media

An up-to-date list of manufacturers who produce media suitable for use in the CC-222 can be obtained from your TASCAM dealer.

Use of the remote control unit

When using the remote control unit, make sure:

- There is a clear unobstructed path between the remote control unit and the remote sensor on the main unit.
- The remote control unit is located within 5 m (15 ft.) of the main unit, and is pointing at approximately right angles ($\pm 30^\circ$) to the front panel.

When fitting or replacing the batteries:

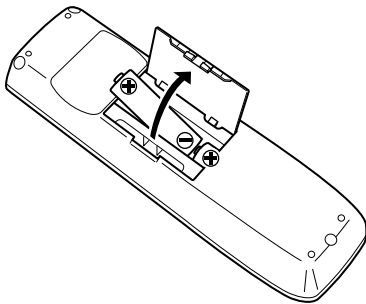

- Always make sure that both batteries are replaced together. Do not mix old and new batteries.
- Do not mix batteries of different types.
- Always make sure that the batteries are located with the correct polarity (the positive terminals of the batteries should match the + markings inside the battery compartment, and the negative terminals should match the – markings).
- If you are not going to use the remote control unit for an extended period of time, remove the batteries. Old batteries can leak, causing damage to the remote control unit.
- Always dispose of old batteries in the way recommended by your local garbage disposal authorities.

About this manual

In this manual, we use the following conventions:

- The names of keys and controls are given in the following typeface: **ERASE**.
- When the alphanumeric portion of the display shows a message, this is shown in the following typeface: `Welcome`.
- If a preset indicator in the display (i.e. one which cannot change, but is either on or off) is shown, this is shown as follows: `RANDOM`.

The sections of this manual are arranged as follows:

1, "Introduction" This section, introducing the features and concepts of the CC-222.

2, "Features and controls" The front and rear panel controls, indicators and connections, as well as a description of the remote control unit.

3, "Cassette operations" Includes dubbing to cassette from CD as well as other cassette-based playback and recording operations.

4, "CD player" About CD playback, including programmed and repeat playback functions

5, "Recording CDs" About recording CDs, including dubbing from cassette to disc, as well as other CD recording functions.

6, "After recording" More information regarding the finalizing of discs and the erasing and refreshing of CD-RW media.

7, "Reference and specifications" Some troubleshooting tips, together with menu default settings, and the facts and figures about the CC-222.

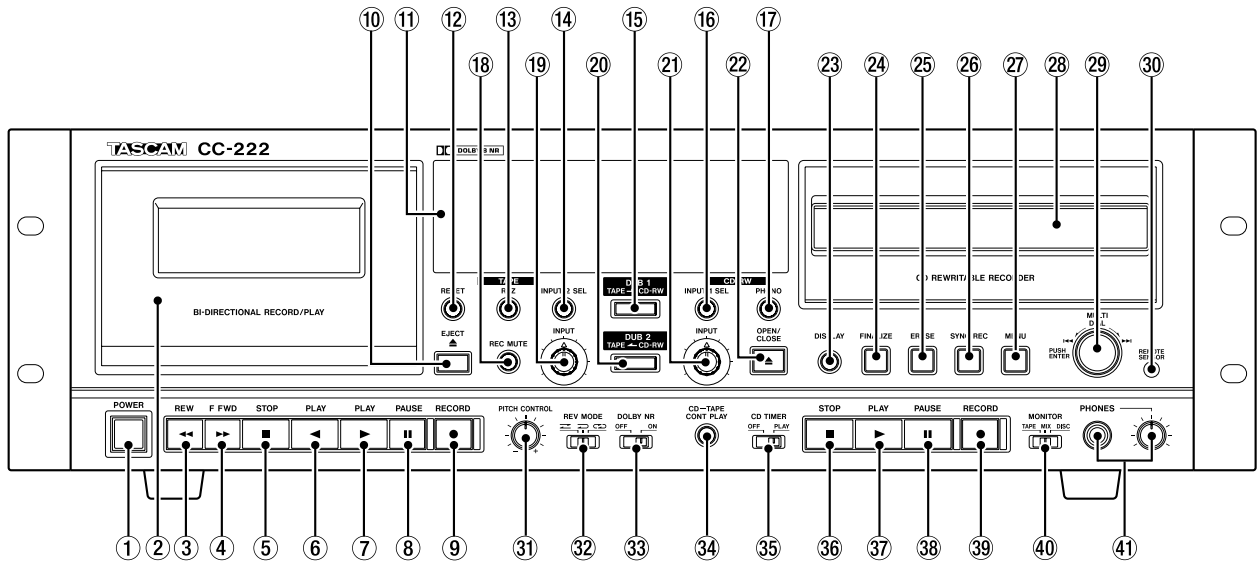

This is not a comprehensive explanation of the meaning and functions of all of the controls. These are described more comprehensively in other parts of the manual, but this section provides a brief reminder of the functions provided by these controls.

- ① **Power switch (POWER)** Push to turn on, and push again to turn the unit off.
- ② **Cassette holder** Open this holder using the **EJECT** key. Insert cassettes tape side downwards, and close the holder by hand.
- ③ **REW key** Starts the tape moving fast in the right-to-left direction. If the tape is already in play mode, it acts as a search key.
- ④ **FFWD key** Starts the tape moving fast in the left-to-right direction. If the tape is already in play mode, it acts as a search key.
- ⑤ **Tape STOP key** Stops the current tape transport operation.
- ⑥ **Tape PLAY key (◀)** Starts tape playback, or recording from record pause, from right to left.
- ⑦ **Tape PLAY key (▶)** Starts tape playback, or recording from record pause, from left to right.
- ⑧ **Tape PAUSE key** Pauses tape playback or recording.
- ⑨ **Tape RECORD key** Goes from tape stop to tape record pause mode.
- ⑩ **Tape EJECT key** Opens the cassette holder.
- ⑪ **Display** Provides information on the status of the cassette and disc transport and the selected input sources, etc.
- ⑫ **RESET key** Resets the tape counter to zero.
- ⑬ **RTZ key** Returns the tape to the zero position.
- ⑭ **INPUT 2 SEL key** Repeated presses of this key cycle between the different sources available for the cassette recorder: **LINE 2**, and **DISC**.
- ⑮ **DUB 1 TAPE → CD-RW key** Starts the process of automatic recording from the cassette to a recordable disc. See the section on recording to disc for full details.
- ⑯ **INPUT 1 SEL key** Repeated presses of this key cycle between the different sources available for the CD-RW drive: **LINE 1**, **PHONO**, **TAPE**, **OPTICAL**, and **COAXIAL**.
- ⑰ **PHONO key** Starts recording from the phono source to the cassette or disc recorder, depending on the selection made in the menu system. See the appropriate sections on recording to either tape or disc.
- ⑱ **REC MUTE key** When recording to cassette and this key is pressed, the sound is muted for about four seconds, and the unit enters record pause mode.
- ⑲ **INPUT (cassette) control** This rotary control affects the level fed to the cassette. Note that it has no effect during automatic disc-to-tape dubbing if the menu item bypassing the volume during dubbing is set to “through”.
- ⑳ **DUB 2 TAPE ← CD-RW key** Starts the process of automatic recording from the disc to tape. See the section on recording to tape for full details.
- ㉑ **INPUT (CD) control** This rotary control affects the level fed to the disc. Note that it has no effect during automatic tape-to-disc dubbing if the menu item bypassing the volume during dubbing is set to “through”.

2 – Features and controls—Rear panel features

- ②② **OPEN/CLOSE key** Opens and closes the disc tray.
- ②③ **DISPLAY key** Changes the time display for the disc recording and playback.
- ②④ **FINALIZE key** Used when finalizing recordable discs.
- ②⑤ **ERASE key** Used when erasing data from CD-RW discs.
- ②⑥ **SYNC REC key** Turns synchronized recording of the disc recorder on and off.
- ②⑦ **MENU key** Repeated presses of this key cycle through the different menu options.
- ②⑧ **MULTI DIAL** Used to select and confirm menu settings etc. (turn to make the setting, push to confirm), and also as a track search facility when playing back discs.
- ②⑨ **Disc tray** Open and close this tray with the **OPENCLOSE key** ②② to load and unload discs.
- ③① **REMOTE SENSOR window** Receives the infra-red signals from the remote control unit. Do not block this window if you are using the remote control unit.
- ③① **PITCH CONTROL knob** This is a center-detented knob which allows the tape speed (and therefore the pitch) to be changed by $\pm 12\%$.
- ③② **REV MODE switch** This three-position switch allows the choice of single-side or bidirectional playback and recording ($\overleftarrow{\text{C}}$ or $\overrightarrow{\text{C}}$), or (C) continuous playback only (not recording).
- ③③ **Dolby NR (OFF/ON) switch** Use this switch to turn the Dolby noise reduction off and on for the cassette deck.
- ③④ **CD-TAPE CONT PLAY switch** Use this to turn continuous playback (alternating between disc and cassette) on and off.
- ③⑤ **CD TIMER (OFF/PLAY) switch** Use this switch to turn the CD timer option on or off (when this is in the **PLAY** position, turning on the machine with a disc inserted will automatically start playback).
- ③⑥ **CD STOP key** Stops CD playback or disc recording.
- ③⑦ **CD PLAY key** Starts CD playback or recording (from record ready mode).
- ③⑧ **CD PAUSE key** Pauses or unpauses CD playback or recording (starts recording from record pause mode).
- ③⑨ **CD RECORD key** places the disc in record ready mode and performs manual track incrementing while recording.
- ④① **MONITOR (TAPE 1/1+2/2 DISC) switch** This switch selects the source for the headphone outputs as either the cassette deck, the disc recorder, or a mixture of both.
- ④① **PHONES jack and volume control**
Connect a standard pair of stereo headphones to this 1/4" jack, and adjust the level with the control.

Rear panel features

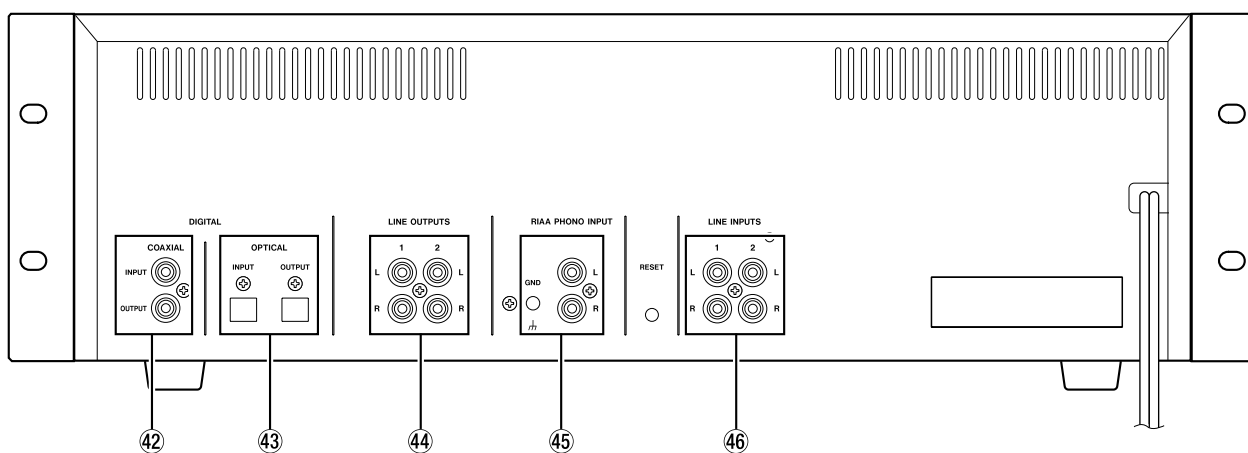

The CC-222 line analog inputs and outputs all operate at the -10dBV level. For details of input and out-

put impedances, etc., consult the specifications.

2 – Features and controls—Remote control features

④② **DIGITAL COAXIAL (INPUT and OUTPUT) jacks** These RCA jacks accept (INPUT) and transmit (OUTPUT) SPDIF digital audio data to and from the disc recorder.

Digital audio data received can be at any sampling frequency between 32kHz and 48kHz. The output is always 44.1 kHz.

④③ **DIGITAL OPTICAL (INPUT and OUTPUT) jacks** These TOSLINK-compatible connectors accept (INPUT) and transmit (OUTPUT) SPDIF digital audio data to and from the disc recorder.

Digital audio data received can be at any sampling frequency between 32kHz and 48kHz. The output is always 44.1 kHz.

④④ **LINE OUTPUTS (1, 2) (L, R)** Use these connectors to connect the amplifier to the analog outputs of the disc recorder (1) or the outputs of the cassette deck (2).

LINE OUTPUTS 2 output both the signals from the disc recorder and the cassette deck. However, if both are playing, the cassette deck takes priority (the disc recorder will not be heard).

④⑤ **RIAA PHONO INPUT (L, R) and GND terminal** Use these connectors to connect a record deck to the CC-222. The destination of the signal is determined by a menu item.

Connect the earth (grounding) wire of the record deck to the **GND** terminal.

NOTE

*Do not connect a record deck to the **LINE** inputs and do not connect any other equipment to these jacks.*

④⑥ **LINE INPUTS (1, 2) (L, R)** Use these connectors to connect signal sources to the analog inputs of the disc recorder (1) or the inputs of the cassette deck (2).

Remote control features

For the most part, the remote control unit duplicates the front panel controls, with a few differences, as explained here:

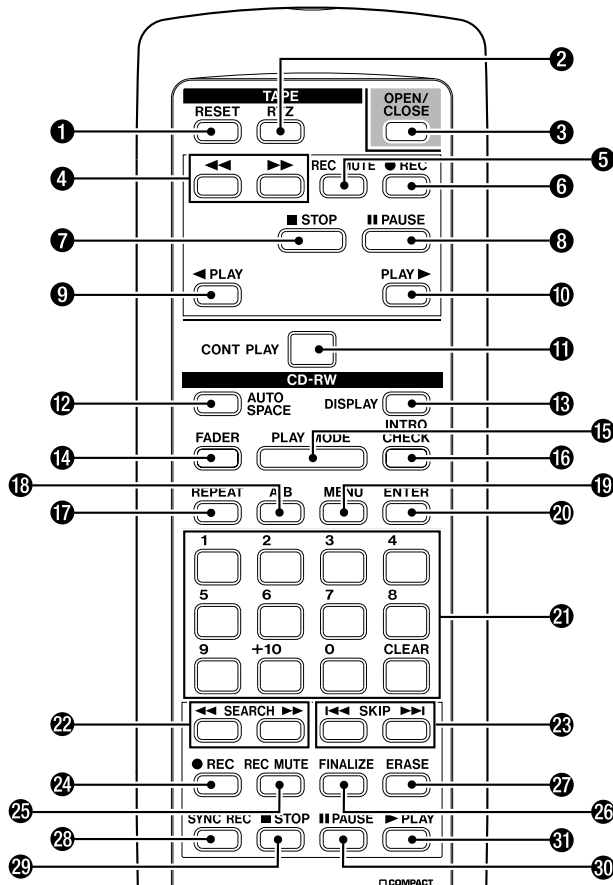

① **RESET key** Performs the same function as ⑫.

② **RTZ key** Performs the same function as ⑬.

③ **OPEN/CLOSE key** Performs the same function as ⑩.

④ **Wind/search keys (◀, ▶)** Perform the same functions as ③ and ④.

⑤ **REC MUTE key** Performs the same functions as ⑱.

⑥ **REC key** Performs the same functions as ⑨.

⑦ **STOP key** Performs the same functions as ⑤.

⑧ **PAUSE key** Performs the same functions as ⑧.

⑨ **PLAY key (◀)** Performs the same functions as ⑥.

⑩ **PLAY key (▶)** Performs the same functions as ⑦.

⑪ **CONT PLAY key** Performs the same functions as ⑳.

⑫ **AUTO SPACE** Automatically adds a space of about four seconds between disc tracks on playback.

⑬ **DISPLAY key** Performs the same functions as ㉓.

2 – Features and controls—Remote control features

- ⑭ **FADER key** Used to perform automated fade-in and fade-out when recording to disc. The time is set using menu items.
- ⑮ **PLAY MODE key** Allows the selection of either normal, single, programmed or random playback.
- ⑯ **INTRO CHECK** Allows the first 10 seconds of every track on a disc to be played before automatically moving on to the next track to be played.
- ⑰ **REPEAT key** Enables or disables repeat mode (single track, or disc repeat playback) of the CD.
- ⑱ **A-B key** Used to set the start and end points of a repeat loop and to cancel such a loop.
- ⑲ **MENU key** Performs the same functions as ⑳.
- ㉑ **ENTER key** Performs the same functions as pushing the **MULTI DIAL** (㉒).
- ㉒ **Number keys (0 through 10, +10, and CLEAR)** Used for entering track numbers for disc playback.
- ㉓ **SEARCH keys** Used for “fast forward” and “fast reverse” through a disc.
- ㉔ **SKIP keys** Perform the same functions as turning the **MULTI DIAL** (㉒) (selecting tracks and selecting menu parameter values).
- ㉕ **REC key** Performs the same function as ㉖.
- ㉖ **REC MUTE key** Inserts a silence of about four seconds and pauses recording when recording to disc.
- ㉗ **FINALIZE key** Performs the same functions as ㉘.
- ㉘ **ERASE key** Performs the same functions as ㉙.
- ㉙ **SYNC REC key** Performs the same functions as ㉚.
- ㉛ **STOP key** Performs the same functions as ㉜.
- ㉜ **PAUSE key** Performs the same functions as ㉝.
- ㉝ **PLAY key** Performs the same functions as ㉞.

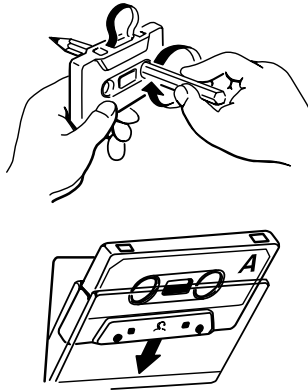

Note the following when loading tapes:

- 1 Use your finger or a pencil to turn the cassette's hub and take up any slack tape.

NOTE

Avoid touching the tape. Fingerprints attract dust and dirt.

- 2 Press the **EJECT** key to open the cassette compartment door.
- 3 Load the cassette tape with its open edge facing down.
- 4 Gently close the compartment door.



NOTE

The cassette holder cannot be opened during recording or playback.

If the power has been switched off during play or recording, ejecting the cassette may be impossible. In such a case, switch the power on and press the **EJECT** key again.

Playback operations

- 1 With the power on, set the **REV MODE** switch to the required tape mode.

	Single-sided playback
	One side, then the other side, then stop
	One side, then the other side, then the first side again, etc.

- 2 Load a pre-recorded cassette with its open edge facing down and side **A** facing toward you.
- 3 Set the **Dolby NR** system on or off.
- 4 Press either **PLAY** key to start playback.
- 5 Adjust the volume with the amplifier's volume control.
- 6 To stop playback, press the **STOP** key.

Continuous tape/CD playback

- 1 Load the tape (as described above) to be played back into the unit. Load the disc (use the **OPEN/CLOSE** key and load the disc recorded side downwards and close the tray).
- 2 Press the **CD-TAPE CONT PLAY** key.
- 3 Press either of the **PLAY** keys of the tape deck, or the **PLAY** key of the CD deck.

Playback will start on the appropriate unit. When playback reaches the end of the disc, or the end of the tape (either one side or two

sides, as determined by the **REV MODE** setting), playback starts on the other unit.

Media (tape or disc) can be changed in the unit that is not playing.

NOTE



The cassette deck and CD deck can be used to play back through different outputs, or the **LINE OUTPUTS 2** jacks can be used for both disc and tape playback. However, note that if both are playing, the cassette takes priority (the disc will not be heard through these outputs). Disc playback is always through the **LINE OUTPUTS 1** jacks.

Recording operations

NOTE

Recording pre-recorded tapes, records, or other published or broadcast material may infringe copyright laws. Check before recording.

- 1 With the power on, set the **REV MODE** switch.

If you want to make a bi-directional recording, set the **REV MODE** switch to the  or  position.

Set to the  (single side) position if recording is to be made on a single side of the tape.

- 2 Load a recordable cassette. Check that the safety tabs on the spine of the cassette are in place. If they have been broken off, block the holes with adhesive tape.
- 3 Press the **INPUT 2 SEL** key to select the source (either **LINE2** or **DISC**).
When **DISC** is selected, the built-in CD player's output is selected as a source.
When **LINE2** is selected, the external signal from the **LINE 2** jacks is selected as a source.

- 4 Set the **Dolby NR** system on or off.
- 5 Press the **RECORD** key. The deck enters record pause mode (the display indicators light).
- 6 Play back the source, and adjust the recording level with the **INPUT** level control so that the loudest sound to be recorded just makes the meters briefly reach around the “0 dB” point for normal or high-position tapes (recording is not possible with metal tapes).
- 7 Press either the **PAUSE** or **PLAY** key to start recording.

To stop recording temporarily, press the **PAUSE** key. To restart the tape, press either the **PAUSE** key or either of the **PLAY** keys. When the unit is in record pause mode, if the **PLAY** key whose indicator is lit is pressed recording will restart. If the **PLAY** key whose indicator is unlit is pressed, the recording direction will reverse, and the **PLAY** key must be pressed again to restart recording.

To stop recording, press the **STOP** key.

Dubbing tapes from the CD deck

To record from the internal CD deck:

- 1 Prepare for recording as described above (load a tape, set the **REV MODE**, etc.).
- 2 Load the source CD disc (press **OPEN/CLOSE**, put the disc in the tray, recorded side downwards, and close the tray).
- 3 Use the **MENU** key to set the dubbing volume to **THRU** to bypass the input level control (see “Bypassing the **INPUT** level for dubbing” on page 17).

NOTE

If you want to record the tracks on the tape in a different order from those on the disc, use the programmed playback mode to rearrange the tracks (“Programmed order playback” on page 21). Leave the disc in stop mode when you have finished programming the order.

- 4 Press the **DUB 2** key.

If the tape is in stop mode If the tape is in stop mode, the tape rewinds to the beginning of the current side.

At the start of the tape, recording starts, but the CD does not start playback for eight seconds (this is to allow for the leader tape at the start of a cassette). The **DUB** indicator flashes.

The CD starts playback after the eight seconds at the start of the cassette. The **DUB** indicator lights steadily.

If the tape is in record pause mode If the tape is in record pause mode, recording starts immediately, and the CD starts playback immediately. The **DUB** indicator lights.

If you want to adjust the input volume, set the **DUB >VOL** menu to **ON** and use the left (tape) **INPUT** control to adjust the level of signals fed to the tape from the CD player.

3 – Cassette operations—Recording tapes from the PHONO deck

The dubbing stops when playback reaches the end of the CD, or when the tape reaches the end of its run (one side in the case of single-sided (⌂) reverse mode, both sides in the ⌂ reverse mode), whichever comes first.

Note that if the tape is set to auto-reverse, and the last item recorded on one side of a tape was not completely recorded before the tape was reversed, that item will be automatically repeated.

Also note that when the tape automatically reverses, eight seconds are used as non-recorded time at the beginning of the second side (the tape is in record

mode, but the CD does not play back), again to allow for leader tape at the start of the cassette.

The dubbing process can also be stopped manually with the **STOP** key of the cassette deck or the CD deck. All other transport keys are disabled.

NOTE

Dubbing is not possible if: a cassette is not loaded, or a CD is not loaded. It is not possible if the cassette is write-protected, or if the CD is a recordable disc which does not currently have any material recorded on it.

It is also not possible to enter the dubbing mode if the tape is not in stop or record ready mode, or if the CD is not in stop or pause mode.

Dubbing to tape from the middle of a CD

The above procedure describes the playback and recording from the start of a disc (or the start of a programmed playback list).

To record from a point other than the ones above:

- 1 **Locate the disc to the point where the playback is to start.**
- 2 **Press the disc PAUSE key to pause playback at the point where the playback is to start.**

- 3 **If recording is to start at the beginning of the cassette, make sure the cassette is stopped, otherwise, locate the cassette to the appropriate position where recording is to start, and enter record ready mode.**

Using the headphones with the MONITOR switch set to 1+2 will help here.

- 4 **Press the DUB 2 key. Playback starts on the disc, and recording starts on the cassette.**

Bypassing the INPUT level for dubbing

The **INPUT** control can be bypassed so that it has no effect when dubbing, in the following way:

- 1 **Press the MENU key until the DUB>VOL item appears.**
- 2 **Turn the dial to select either THRU (the control is bypassed and disabled) or ON (the control is enabled).**

NOTE

This setting applies only to dubbing procedures, not to other recordings.

It is not possible to make this menu setting (or any other menu settings) when dubbing is actually taking place.

Recording tapes from the PHONO deck

To record from an external record deck connected through the **RIAA PHONO** inputs:

- 1 **Prepare for recording as described above (load a tape, set the REV MODE, etc.).**
- 2 **Press the MENU key until the PHONO > ×××× menu item is shown.**

If the display does not show PHONO > TAPE, turn the MULTI DIAL (or press the SKIP keys on the remote control) until it does and press the MULTI DIAL (or ENTER on the remote control unit).

- 3 **Press the PHONO key ⑰. The PHONO indicator lights on the display.**

If the tape is currently in stop mode, the tape rewinds, and the deck enters record ready mode (about eight seconds from the start of the cassette, to allow for leader tape).

If the tape deck is already in record ready mode, it will remain in record ready mode.

- 4 **Start playback of the record.**
- 5 **Start recording with either the PLAY or PAUSE key.**

3 – Cassette operations—Other recording features

Press **STOP** (cassette deck) to stop the recording. The **STOP** key is the only key which is enabled during phono recording.

After the phono recording has finished, the original tape signal source is restored.

NOTE

It is not possible to perform phono recording as described above under the following circumstances: a

tape is not loaded or the tape is write-protected (the phono to tape function is disabled with no recordable tape inserted), or the tape is not either stopped or in record ready mode.

*Only recording as described above is possible from the **RIAA PHONO** sources to tape. Manual recording is not possible.*

Other recording features

Recording silences between items

At least four seconds of silence must be recorded between items on tape when using the search functions (“Search keys” on page 19).

When recording, press and release either of the **REC MUTE** keys (main or remote). With the tape moving, the record source is muted for about four seconds (the display record indicator flashes), and the deck then enters record pause mode. Press **PAUSE** or **PLAY** to re-start recording.

If the **REC MUTE** key is pressed while the deck is in record pause mode, four seconds of silence will be recorded on the tape, and the deck will return to record pause mode.

If the **REC MUTE** key is held and pressed for longer than four seconds while recording is in progress, silence is recorded on the tape while the key is held down. The deck enters record pause mode when the key is released.

Erasing tapes

Anything previously recorded on the tape will automatically be erased when you make a new recording

on it. It can also be erased by “recording” on it with the **INPUT** level control set to “0”.

Other tape functions and features

Tape counter

The tape counter value is incremented when the tape is moving from left to right, and decremented when it moves from right to left.

Use either of the **RESET** keys (main or remote) to reset the value to 0000.

When the counter has been set to 0000, this position can be reached easily by pressing either of the RTZ

keys (main or remote). The tape fast forwards or fast rewinds to the 0000 mark.

NOTE

If the current tape position is too close to the 0000 mark (greater than 9995 or less than 0005), this function does not work.

Pitch control

The tape speed can be controlled using the **PITCH CONTROL**.

Turning this to the right of the center position results in faster tape speed (higher pitch) and turning it to the left of the center position results in slower tape

speed (lower pitch). The maximum is 12% away from normal.

The center “neutral” position is marked by a click detent.

3 – Cassette operations—Other tape functions and features

Fast forward and rewind

The **REW** and **FFWD** keys (and their remote control equivalents) act as ordinary fast forward and rewind

keys when pressed when the unit is stopped or paused.

Search keys

When the unit is playing back, the wind keys mentioned above act as Computer-controlled Program Search (CPS) keys, moving to the next (or previous) recorded item. To locate items correctly, there must be at least four seconds of silence between these items (see “Recording silences between items” on page 18).

Repeated presses of these keys will search forward or backward by the appropriate number of items. The tape counter value is replaced by *CPxx* if searching forward, and *CP–xx* when searching backwards.

Note that the terms “forwards” and “backwards” here are relative to the currently-selected play position.

When the item is reached, playback starts. When the end of the tape is reached, the transport stops.

If a key are pressed too many times, so that a search is being made for the wrong item, pressing the “opposite” key corrects the mistake.

NOTE

This function depends on the presence of 4-second silent intervals on tape. If these intervals are too short, or not truly silent, the search function will not work properly. Also note that this function can be “confused” by the presence of longer quiet or select passages in programs (e.g. spoken word drama or classical music).

4 – CD player

The CC-222 can be used to play back CDs (including CD-R and CD-RW discs that have been recorded and finalized on other types of recorder), as well as CD-R

discs and CD-RW discs that have been recorded on the unit.

Simple playback operations

- 1 Press the **OPEN/CLOSE** key to open the disc tray.
- 2 Discs should be inserted in the tray with the label uppermost.
- 3 Press the **OPEN/CLOSE** key to close the tray again.

When a disc is loaded into the unit, the display briefly shows **TOC Reading.**, with a flashing period following the word “Reading” as the unit determines the contents of the disc. When the TOC has been read, the display shows (at the left of the display) one of the following:

CD	A commercial pre-recorded CD or a finalized CD-R
CD-R, NO TOC	A CD-R which has yet to be finalized
CD-RW, NO TOC	A CD-RW which has yet to be finalized
CD-RW	A finalized CD-RW (this differs from a CD, as it may be unfinalized and erased)
[blank]	Unusable or unreadable disc or no disc

- 1 Press the **PLAY** key to start playback
- 2 Press the **STOP** key to stop playback
- 3 Press the **PAUSE** key to pause playback temporarily.

The track number indicators at the bottom of the display light, to show the available unplayed tracks. If there are thirteen tracks on the disc, for example, indicators 1 through 13 will light. If there are more than 20 tracks on a disc, the track number **OVER** indicator (at the bottom of the display) will light.

Time display modes

When playing back a CD (or when in pause mode), there are four different time display modes.

In each mode, the current track number is given, followed by the time, as given below, e.g.

10Tr 0:48

Press the **DISPLAY** key to cycle through these time display modes, as described here:

Display shows	Meaning
TOTAL	Total elapsed time of the disc
[blank]	Elapsed time of the current track
TOTAL REMAIN	Time remaining of the current disc
REMAIN	Time remaining of the current track

NOTE

If programmed playback has been selected (“Programmed order playback” on page 21), the elapsed time and total remaining time refer to the programmed material, not the whole disc.

Track search

Use the **MULTI DIAL** (or the **SKIP** keys on the remote control unit) to jump forward or backward by one track at a time, as shown on the display.

Note that going forward from the last track of the disc will “wrap round” to track 1, and going backward from the first track of the disc will “wrap round” to the last track of the disc.

The track number indicators at the bottom of the display shows the selected track (the lit indicator at the left of the row of indicators).

It is also possible to use the number keys on the remote control unit to jump directly to a particular track:

- 1 To play tracks 1 through 9, simply press the appropriate key (1 through 9).

- 2** To play a track whose number is higher than 9, press the +10 key an appropriate number of times to set the “tens” digit of the track number, followed by a single key to set the “units” digit. For example:

Track 13 = +10, 3

Track 30 = +10, +10, +10, 0

NOTE

On the remote control unit only, the search keys can be used to “fast-forward” and “fast-rewind” through the disc.

Playback modes

The unit can be set to play back a single track, the whole disc in the order in which it was created, the tracks of the disc in a random (shuffled) order, or a programmed order.

NOTE

Selecting the playback mode is only possible using the remote control unit. It is not possible to select the playback mode using the main unit alone.

- 1** Press the **PLAY MODE** key repeatedly to cycle the display through the following:

- **Continue**. Normal playback mode. Programming is cancelled, and playback continues in the normal order.
- **Single**. The currently selected track is played and then playback stops. The **SINGLE** indicator lights in this mode.
- **Random** (random track order). In this mode, each track is played once before the disc repeats.

Using the track search functions will move backwards or forwards through the random order, e.g. if track 7 is followed by track 10, it is possible to use the track search keys to go back to track 7, which is remembered as being before immediately before track 10. The red **RANDOM** display indicator lights in this mode.

- **Program** (see “Programmed order playback” on page 21 below). The red **PROGRAM** display indicator lights in this mode.

The selected mode is shown in large characters disappears from the display a few seconds after selecting the mode, and the display returns to its previous mode.

Changing to programmed play mode is not possible when playback is taking place. This change must be made while the tape is stopped.

Programmed order playback

The steps to set up to 25 program steps (tracks) to be played back in a specified order are as follows:

- 1** Press the **PLAY MODE** key until the display shows **Program**.
- 2** The display changes to show
`0Tr 00:00 00,`
 meaning that no program steps have yet had tracks assigned to them.
- 3** Use the number keys on the remote control to enter a track number (including the +10 key to enter values greater than 9, as described above). There is no need to press **ENTER**.
 The track entered is assigned to the program step, and the display changes, showing the track number, the total time of the program so far, and the step number, e.g.
`2Tr14:56 03.`
- 4** The next program step can then be entered.

NOTE

Steps 3 and 4 above can also be carried out from the main unit by turning and pushing the **MULTI DIAL**.

- 5** Repeat steps 3 and 4 above until the program is complete.
- 6** Press the **PLAY** key to start playback at the first program step.

The display shows the track, the current time display, and the program step number.

While in programmed playback mode, using the **SKIP** keys or the **MULTI DIAL** moves backwards and forwards in the order set in the program.

Use the **PAUSE** key to halt playback temporarily or the **STOP** key to stop playback of the program.

If the **STOP** key is used, when playback is restarted, it starts from the first program step.

4 – CD player—Repeat play

Clear the program by pressing **PLAY MODE** until the display shows **Continue**. The program is also cleared when the disc tray is opened, and if the **STOP** key is pressed when playback is stopped in programmed order mode.

The programmed play order is not memorized when power is turned off.

If an attempt is made to enter more than 25 program steps, the message **PGM Full !** appears on the display.

Repeat play

The unit can repeat the whole of the disc (or program), an A–B portion set as described here, or the current track only.

NOTE

Selecting the repeat mode is only possible using the remote control unit. It is not possible to select the repeat mode using the main unit alone.

- 1 **The unit should be in playback, pause or stop mode.**

Continue to press the REPEAT key so that the display shows Repeat 1 (the REPEAT 1

indicator lights) to repeat one track, Repeat ALL (the REPEAT ALL indicator lights) to repeat the whole disc or program, Repeat A-B (the REPEAT A-B indicator lights) to repeat between two points as explained below.

- 2 **If playback has not started, restart it.**

To cancel repeat mode, press the **REPEAT** key so that the display shows **Repeat OFF** and the REPEAT indicator goes out. Pressing **STOP** also cancels repeat mode.

Setting the A and B repeat points

While the REPEAT A-B indicator is lit, you can set the points between which playback should loop.

- 1 **Start playback before the point where you want the loop to start.**
- 2 **Press the A-B key (remote control) at the point where the loop is to start.**
- 3 **Press the A-B key once more at the point at where the loop is to end.**

Playback jumps back to the first (A) point and continues to the second (B) point and

then returns to the A point again, repeating the loop.

Cancel the A-B repeat mode by pressing the **A-B** key.

NOTE

If the A and B points are too close together, A-B looping is not possible.

The A and B points can be on either side of a track division, but there may be a gap in the loop during playback in this case.

Intro check

This is a useful facility to skip through the first 10 seconds of all the tracks on a CD to refresh your memory of the contents of the CD.

- 1 **With the disc stopped, press the INTRO CHECK key.**

The first 10 seconds of each track on the disc will be played. Press STOP to stop this playback process.

Pressing **INTRO CHECK** again cancels the mode and returns to normal playback.

NOTE

This function is only available from the remote control unit. It is not possible to use this function with the main unit only.

Auto spacing

This function inserts a gap of about four seconds between tracks on playback. This can be useful when recording to tape, so that automatic searching can take place more easily on tapes recorded from disc (see “Search keys” on page 19).

NOTE

This function is only available from the remote control unit. It is not possible to use this function with the main unit only.

If you press the **AUTO SPACE** key while the playback is automatically paused between tracks as a result of the auto space function being enabled, the unit remains in pause mode, and playback will not restart after the auto pause time is elapsed.

If you press the **AUTO SPACE** key while playback is taking place, and the auto space function is enabled, the auto space function is then cancelled.

5 – Recording CDs

Before you start recording using the CC-222, make sure that you understand the following key points:

- Once you have recorded on a CD-R disc, the data cannot be erased from it.

- You can add tracks to an unfinalized recordable disc. Once finalized, a CD-R disc is “fixed” and behaves in the same way as a pre-recorded disc. Finalized CD-RW discs, however, can be erased, refreshed and re-recorded.

Input selection

To select the input to be recorded, press the **INPUT 1 SEL** key on the main unit.

Repeated presses of the key cycle through the following options:

OPTICAL	Optical digital in
COAXIAL	Coaxial digital in
LINE1	Analog in (LINE 1)
PHONO	Phono inputs
TAPE	The CC-222 cassette deck

In the case of either the coaxial or optical inputs being selected, the appropriate indicator: COAXIAL or OPTICAL, lights on the display.

If any of the analog signals is selected, the LINE 1 or TAPE indicator lights on the display.

Signal volume

- The analog signals received at the **LINE 1** jacks, the **RIAA PHONO** jacks and the tape (if the input volume is not being bypassed—see below) are controlled with the CD deck’s **INPUT** control. When this control is at the 12 o’clock position, the signal is neither cut nor boosted.
- The level of the digital inputs may be controlled using the digital volume menu, as described below.

- 1 Press the RECORD key to place the unit in record ready mode.**
- 2 Repeatedly press the MENU key until the display shows VOLUME XXXdB where XXX is the current setting.**

- 3 Use the MULTI DIAL or the SKIP keys to adjust the input level. The maximum boost is +18db (relative to the original input level), and the signal may be cut by up to 60dB. There is also a — — — — setting which represents a complete signal cut.**

NOTE

If digital direct is selected, as described below (“Digital direct” on page 32), the digital volume is bypassed and the menu item does not appear.

Input monitoring

When the unit is in record ready, or record mode, the input signal is output from the **OUT** jacks (digital and analog), allowing you to hear the input signal.

The meters also show the current signal level.

However, it is only possible to record, or to enter record ready mode, when a recordable disc is inserted. To allow monitoring of the input signal at other times, or when the unit is stopped, use the **RECORD** key on the main unit or remote control to

enter monitor mode from stop mode when there is no recordable disc in the unit (when there is a recordable disc in the unit, pressing the **RECORD** key enters record ready mode).

The word **MONITOR** appears on the display to show that the output signal is an echo of the input signal(s). The meters show the current input level.

Exit the monitor mode by using the **STOP** key.

Frequency conversion

The sampling frequency for CDs is 44.1 kHz. The CC-222 will always record (and play back) CDs at this frequency.

However, if recording through a digital connection (either coaxial or optical) and the source has been recorded at a frequency other than 44.1 kHz, or is

being played back at a non-standard speed using a varispeed unit (more than 1% away from the standard), the CC-222's internal frequency converter will automatically convert the incoming frequency to 44.1 kHz.

NOTE

If digital direct is selected, as described below ("Digital direct" on page 32), the frequency converter is bypassed. In this case, recording from digitally-connected devices is only possible when the source frequency is 44.1 kHz. If an attempt is made to record from a digitally-connected source at a different frequency, the error message `Not F=44.1k!` is displayed.

Basic recording

NOTE

According to the "Red Book" (the specification for audio CDs), a track cannot be less than four seconds in length, and there can be a maximum of 99 tracks on an audio CD. Bear these limitations in mind when recording.

If you press either the **STOP** or the **PAUSE** key within four seconds of starting recording, the unit will continue recording until four seconds have elapsed (since the start of recording) and then stop or pause as appropriate.

After selecting the input source(s) (, "Input selection"), it is possible to start recording.

The basic record procedure is as follows:

- 1 **Load a recordable disc into the unit. As the disc is loaded, the display shows TOC Reading.**

When the disc has been loaded, the display indicators show CD-R, NO TOC, or CD-RW, NO TOC, as appropriate.
- 2 **Press the RECORD key. The unit enters record ready mode, as shown by the REC and pause indicators on the display. As the unit enters record ready mode, the display shows Now OPC (Optimum Power Control), as the unit prepares to record on the disc.**
- 3 **Adjust the level of the source(s), following the guidelines in "Signal volume" on page 24.**

NOTE

The red OVER indicators on the meters should never light. Unlike analog equipment, digital audio units produce extremely unpleasant sounds when distorted, and there is no "headroom" after the 0 mark. If recording digitally from a commercially-produced CD, the volume set in the menu should be 0dB. This will maintain all the dynamic range of the source CD without clipping. Only boost the signal if the source is exceptionally quiet.

An analog signal input at nominal level, with no cut or boost from the volume controls, is equivalent to a reading of -16 dB on the meters (on other words, 0 is equivalent to 16 dBFS).

- 4 **Press the PLAY key or the PAUSE key to start recording.**

Note that there is no need to "cue up" the recording position—the unit always finds the next available location on the disc and start recording to it.

- 5 **Press the PAUSE key to pause recording temporarily. The pause indicator on the display shows this.**

Pressing PAUSE or PLAY again restarts recording with a new track number.

- 6 **Press STOP to stop recording. When recording stops, the display shows PMA Writing (Program Memory Area) and the REC indicator flashes for a few seconds as the unit writes to the disc.**

NOTE

While the "PMA Writing" message is displayed, all keys are disabled, and the unit is actually writing to disc. Do not disconnect the power or subject the unit to severe vibration or shocks at this time, as this will prevent proper recording of the information.

- 7 **When this message disappears, you must press the RECORD key (step 2) before restarting the recording. Recording restarts with a new track number.**

NOTE

Remember that every time recording is paused or stopped, when recording is restarted, a new track will always be started. It is not possible to record in two "stages" within one track.

5 – Recording CDs—Basic recording

Playing back tracks

Although an unfinalized disc cannot be played back on an ordinary CD player, the CC-222 can play back tracks that have been recorded.

Use the **MULTI DIAL** control or the **SKIP** keys to select a track for playback.

Time display while recording

While a recordable disc is being played back, the four time display modes available in normal playback as described in , “Time display modes”: TOTAL, TOTAL REMAIN, track REMAIN and elapsed track time.

However, during recording there are fewer options available (obviously, the unit cannot see into the future and know how much time remains of the track which is being currently recorded!).

When in record or record ready mode, repeated presses of the **DISPLAY** key cycle between displaying the remaining time left for recording on the disc (TOTAL REMAIN) and the elapsed time of the track currently being recorded (no indicator lit).

When playback is stopped at the start of a recordable disc, there are only two options available: TOTAL (the total time recorded so far on the disc) and TOTAL REMAIN (the total time available on the disc for further recording).

Manual track division

It is possible to divide the recording into tracks “on the fly” while recording.

While recording is taking place, press the **RECORD** key. The current track number is incremented by one.

For details of automatic track division while recording, see “Automatic track division” on page 31.

NOTE

According to the “Red Book” (the specification for audio CDs), a track cannot be less than four seconds in length, and there can be a maximum of 99 tracks on an audio CD. Bear these limitations in mind when adding track divisions.

Restricting the number of tracks

When making a recording using the CC-222, it is possible to restrict the number of tracks that may be recorded at one time. This applies whether the tracks are being divided manually, as described above (“Manual track division” on page 26) or being divided automatically (“Automatic track division” on page 31).

At any time within record or record ready mode, turn the **MULTI DIAL** control or use the **SKIP** keys.

This sets the number of remaining tracks, as shown to the right of the time display. The maximum number here is limited by the standard limit of 99 tracks, and the number of tracks currently recorded. In other

words, if 8 tracks have already been recorded on the disc, the maximum value that can be set here is 91 (91+8=99). If 49 tracks have already been recorded on the disc, the maximum value that can be set here is 50 (49+50=99).

Every time a track division is made, the number shown at the right of the display goes down by one. When the number shown is 1, and a track division is made, the display shows **PMA Writing** and the unit enters stop mode.

The number of remaining tracks can be changed during recording using the **MULTI DIAL** control.

Full disc

If recording a long program, and the number of tracks has not been restricted, when there is no space remaining on the disc for recording, as shown by the time display (see “Time display while recording” on page 26), just before the end of the disc is reached,

the unit starts a fade-out over a few seconds (the display shows **FADE OUT**).

When the fade-out has finished, the display shows **Disc Full!!!** for a few seconds, and the unit then goes into stop mode (the display shows **PMA Writing**).

5 – Recording CDs—Dubbing from tape to disc

If the disc is a CD-RW, the final track can be erased, if required (see “Erasing tracks” on page 35) and the

disc then finalized. If the disc is a CD-R, it must be finalized prior to use (see “Finalizing” on page 34).

Dubbing from tape to disc

When dubbing from tape to disc, follow the instructions here.

- 1 **Load the tape with the side that will be recorded first to be played first. Set the Dolby, etc. as well as the reverse mode.**
- 2 **Load a recordable disc.**
- 3 **Use the MENU key to set the dubbing volume to THRU to bypass the input level control (see “Bypassing the INPUT level for dubbing” on page 17).**

NOTE

Note that while dubbing with auto track enabled, the start trigger level (see “Synchronized recording” on page 30) is set to -36dB.

- 4 **Press the DUB 1 key.**

The CD goes into record ready The tape rewinds to the start of the tape and starts playing back. The CD recorder starts recording.

- 5 **When the available recording time on the disc is finished, or the tape has stopped playing according to the reverse mode setting, whichever is the earliest, the tape will stop, and recording will stop on the disc.**

If you want to adjust the input volume, set the DUB > VOL menu to ON and use the right (CD-RW) INPUT control to adjust the level of signals fed to the disc from the tape deck. If you wish to adjust the volume before recording starts, put the CD-RW into record ready or monitor mode and use the INPUT 1 SEL key to select TAPE.

You can also stop the dubbing process by pressing either of the STOP keys (these are the only keys which will work in dubbing mode).

NOTE

A recordable disc must be loaded in the drive, and a cassette in the tape deck for the dubbing to work. The DUB 1 key is disabled if the media are not loaded, and if the drives are in any mode other than stop.

Dubbing to CD from the middle of the tape

The previous instructions refer to recording from the start of the tape.

- 1 **To record from the middle of the tape, set noise reduction, reverse mode, etc. and locate the tape to the position where playback will start.**
- 2 **Press the tape PAUSE key to leave the tape in paused mode.**

- 3 **With a recordable disc in the drive, press the DUB 1 key. The tape will start playing back, and the disc will start recording.**

Recording stops under the same circumstances as for the whole tape (end of tape, end of disc or either STOP key pressed).

Recording to disc from the RIAA PHONO inputs

NOTE

Because of the background noise often experienced when playing back analog vinyl recordings, although the following features are enabled in the phono recording mode: trigger level, sync recording and automatic track division, the use of them is not recommended.

To record to disc from an external record player connected to the RIAA PHONO jacks:

- 1 **Load a recordable disc and put the unit in stop mode.**
- 2 **Press the MENU key until the PHONO > ×××× menu item is shown.**

If the display does not show PHONO > DISC, turn the MULTI DIAL (or press the SKIP keys on the remote control) until it does and press the MULTI DIAL (or ENTER on the

5 – Recording CDs—Advanced recording

remote control unit). Prepare to play the record on the external record player.

- 3 Press the **PHONO** key. The input changes to the **RIAA PHONO** input (the **INPUT 1 PHONO** indicator lights on the display), and the disc recorder enters record ready mode.
- 4 Start playing back the record.
- 5 Start recording on the disc by pressing the disc **PLAY** key.

The level can be adjusted using the **CD INPUT** control.

Recording will stop when the recording time on the disc ends, or when the disc **STOP** key is pressed. The input source returns to the previously-selected key.

NOTE

No keys are enabled in this phono recording mode, except for the disc **STOP** key. This includes the

RECORD key, which can therefore not be used for manual track increments (“Manual track division” on page 26). If you want to use manual track division, use the normal recording procedure, with the phono inputs selected as the source.

During dubbing with auto track enabled, the trigger level (“Setting the trigger level” on page 28) is fixed at -24 dB and cannot be changed.

This mode cannot be entered if a recordable disc is not loaded in the drive.

It is also possible to perform manual recording to disc from the **RIAA PHONO** source. This is the same as the standard manual recording procedure (“Basic recording” on page 25), except that the **PHONO** input option should be selected (**INPUT 1 SEL** key) before recording starts.

NOTE

It is not possible to make manual recordings from the **RIAA PHONO** source to tape.

Advanced recording

These sections cover more advanced recording techniques.

Setting the trigger level

The signal level which may be used with synchronized recording operations (here called the “trigger level” or “threshold”) is set as below:

- 1 With a recordable disc loaded, press the **MENU** key until the display shows: **S_LVL>>**
xxdB, where **xx** is the current value.
- 2 Turn the **MULTI JOG** control or use the **SKIP** keys to change the value between -24 , -30 , -36 , -42 , -48 , -54 , -60 , -66 , and -72 dB. (-60 , -66 and -72 are only for digital).

Low numerical values of this setting (towards -24) mean that it takes a louder signal to trigger the start

of the synchronized recording. A high numerical value (towards -72) means that a relatively quiet signal will trigger the start of recording.

When a digital source is selected, there is another option, **DD**, which means that any digital signal above the zero level will trigger the recording.

NOTE

When dubbing from tape to disc (“Dubbing from tape to disc” on page 27) and auto track enabled, this level is fixed at -36 dB. When dubbing from a **RIAA PHONO** source with auto track on, the level is fixed at -24 dB.

Using the trigger level

The conditions under which an input signal is used as the trigger to start recording are:

- when recording digitally, a digital start signal is detected, and audio is subsequently detected

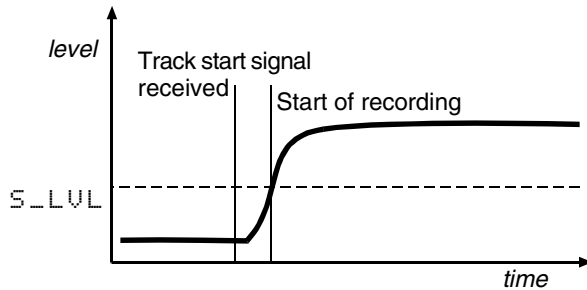

or

- the sound level rises above the threshold (see below) after having been below the threshold for one second or more. Note that the diagram below represents a special case (the source is stopped or paused) of the more general condition, as explained later:

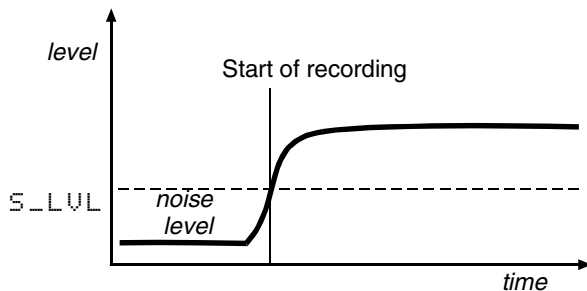

To start synchronized recording when the source is stopped or in pause mode:

- 1 The unit must be in record ready mode, and the SYNC indicator in the display must be lit, as explained above.**
- 2 Start playing the source. The pause indicator disappears from the display, and the unit starts recording.**

The conditions under which synchronized recording stops are:

- when recording digitally, an appropriate digital signal is detected. If the signal is detected from a CD, the unit enters record ready mode after 2 seconds. If the signal is detected from an MD, the unit enters

record ready mode immediately (note that the trigger level is not used here):

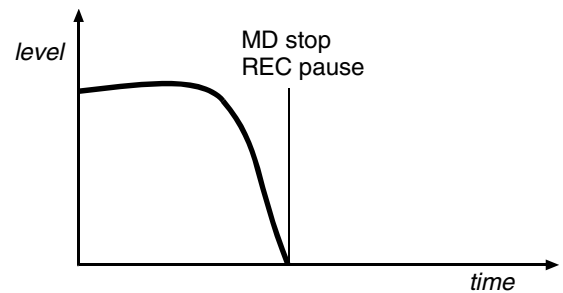
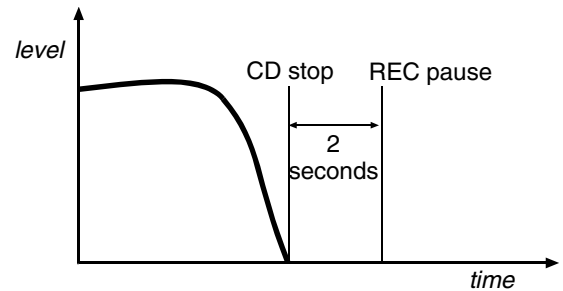

or

- the sound level drops below the threshold level for five seconds

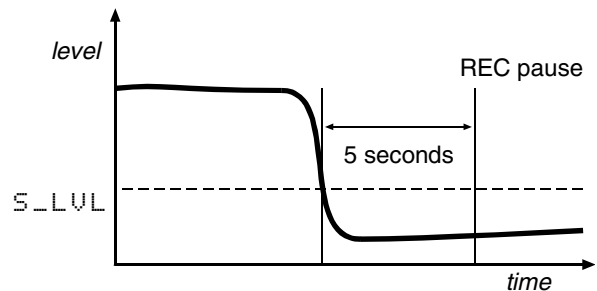

If you set the threshold value so that only high-level signals trigger recording, remember that this will not record the start of a piece with a slow fade-in:

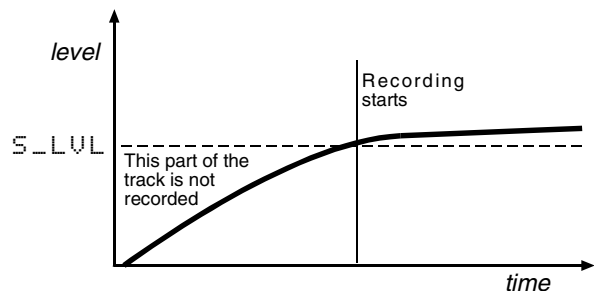

Also remember that when recording from an analog source, the threshold should be set so that it is higher than the “noise floor” (the base level of hiss, pops and crackles which may come from an older vinyl recording, for example).

5 – Recording CDs—Advanced recording

If the “noise floor” is higher than the threshold, synchronized recording will not take place (but remember that synchronized recording is not recommended with the **PHONO** mode — see “Recording to disc from the RIAA PHONO inputs” on page 27):

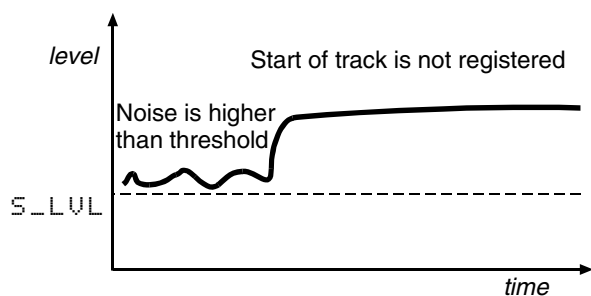

Because synchronized recording can be turned on and off while recording is taking place, it is therefore possible to record with a synchronized automatic start, and a manual end, or *vice versa*.

When the source material is being played back before synchronized recording is enabled, the conditions under which synchronized recording will start (after synchronized recording has been enabled) are:

When the signal drops below the threshold for one second or more and then rises above the threshold again (this is the general condition, of which starting synchronized recording from a stopped or paused source is a special case):

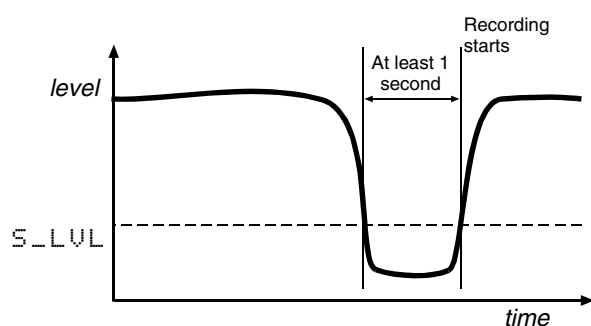

Alternatively, when recording digitally from sources (MD, CD and DAT) which output track divisions, synchronized recording starts when a track division is received, regardless of the level:

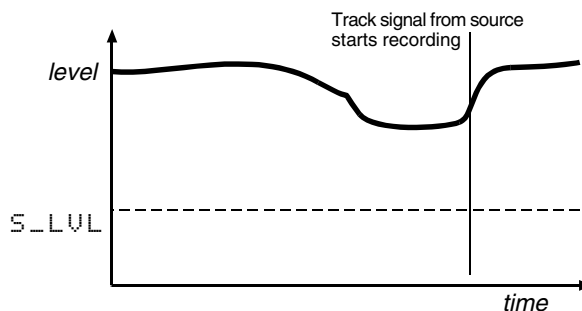

To stop synchronized recording:

- 1 The unit must be in record mode, and the SYNC indicator in the display must be lit.**
- 2 Stop the source. After a few seconds, the unit enters record ready mode. The time between the stopping of the source and entering record ready mode is used to record a gap at the end of the track.**
- 3 If no changes are made to the unit's controls, restarting the source restarts recording, as the unit is still in sync mode and will start recording again when the source is detected.**

NOTE

When recording in sync mode, you may notice a slight delay between starting the source, and the CC-222 responding. This is due to the way in which the unit works, storing the data in a memory buffer before writing it to the disc. The resulting delay is therefore not a cause for concern—all audio data received between the start and end points will be recorded.

Synchronized recording

Synchronized recording means that recording will begin automatically when a signal is received, and will stop when the signal ends.

To enable or disable synchronized recording:

- 1 A recordable disc must be loaded.**
- 2 With the unit in record ready or record mode, press the SYNC REC key.**

The display shows SYNC ON briefly, and then changes to the track and time display. When synchronized recording is enabled, the SYNC indicator lights in the display.

The SYNC REC key is also used to turn off synchronized recording (the display briefly shows SYNC OFF and then returns to the track and time display).

Automatic track division

The trigger level, as set above (“Synchronized recording” on page 30) can also be used to divide tracks if the A-TRACK (auto track) function is enabled.

When this function is enabled, the unit automatically inserts a track division in the recorded material when:

- recording digitally from MD, CD or DAT, an increment signal is detected and the sound level rises above the threshold:

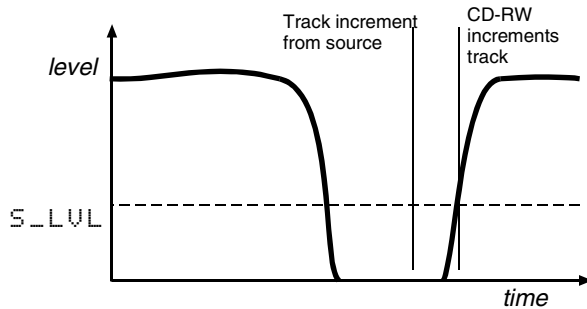

or

- increment signals are unavailable (e.g. analog recording or digital sources other than MD, CD or DAT) and the sound level has dropped below the threshold for more than two seconds, and sound has re-started

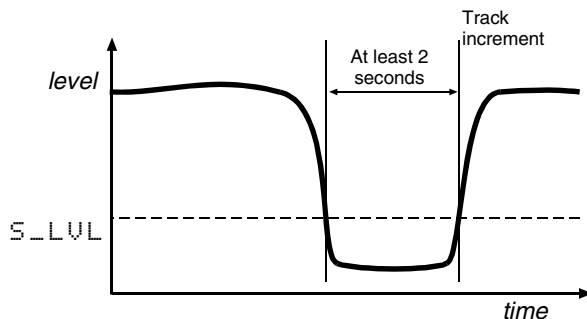

To enable or disable automatic track division:

- 1 With a recordable disc inserted, and with the unit in record ready mode, press the MENU key repeatedly until A_TRACK>XX is shown, where XX may be ON or OFF.
- 2 Turn the MULTI DIAL or use the SKIP keys to change the value as required.

The A-TRACK indicator at the top right of the display lights when the auto track function is enabled.

NOTE

When recording certain types of material (e.g. certain types of classical music or spoken word) through the analog connections, since the track divisions are determined by relative silence, it is possible that spurious track divisions will be inserted. Under these conditions, it may be better to use manual track division (“Manual track division” on page 26).

However, if recording through a digital connection, the track number will be incremented only when a track division signal is received, followed by a rise in volume.

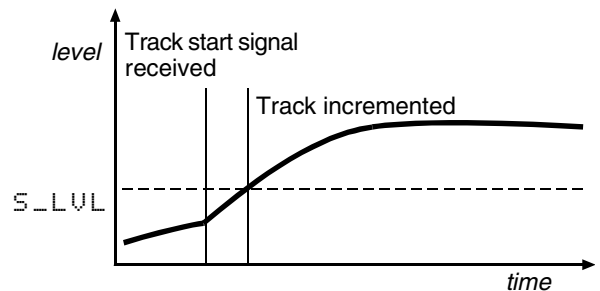

A fall and subsequent rise in volume alone when recording digitally from CD, MD or DAT is not sufficient to trigger an automatic track increment.

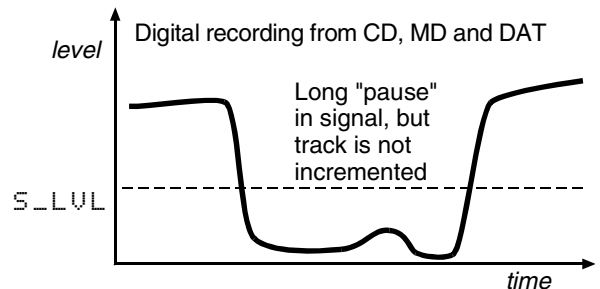

You may find it helpful to use the track restriction facility (see “Restricting the number of tracks” on page 26) together with the automatic track division.

For instance, if you have recorded two albums on one DAT tape, and you wish to make two separate CDs from this tape, you can use the MULTI DIAL to set the number of tracks to the number of tracks comprising the first album.

When the final track of the first album has been recorded, the unit automatically performs the PMA writing procedure and enters stop mode.

5 – Recording CDs—Advanced recording

Digital direct

As mentioned earlier, the digital direct mode bypasses some of the input circuitry of the CC-222 (the frequency convertor and the digital level control) to write directly to the disc.

To enable or disable digital direct recording:

- 1 **Ensure that the input source is set to DIGITAL (either COAXIAL or OPTICAL).**

- 2 **Press the MENU key until the display shows D_L DIRECT > XXX where XXX is either ON or OFF.**
- 3 **Turn the MULTI DIAL or use the SKIP keys to turn this setting on or off.**

NOTE

As mentioned earlier, the digital direct feature bypasses the frequency convertor. Recording is therefore only possible from sources recorded with 44.1 kHz sampling frequency.

Rec mute function

The rec mute function allows instant cut-off of the input signal, and records four seconds of silence on the disc.

- 1 **While recording is in progress, press the REC MUTE key.**

The display shows REC MUTE, the meters stop displaying the current level and the monitored sound is cut.

- 2 **After about four seconds, the unit enters record ready mode.**

NOTE

This function is only available from the remote control unit. It is not possible to use this function with the main unit only.

Fade-in and fade-out

To provide smooth beginnings and endings to recorded tracks, the unit provides fade facilities.

Fade-ins are from $-\infty$ (silence) to the set input level ("Signal volume" on page 24) and fade-outs go from the current input volume to silence.

The fade-in and fade-out times can be set independently in increments of one second, from 1 second to 24 seconds.

To set the fade times:

- 1 **Press the MENU key repeatedly until the display shows FADE IN > XXS, where XX is the current fade-in time, in seconds.**
- 2 **Turn the MULTI DIAL or use the SKIP keys to change the value of the fade-in time.**
- 3 **Press the MENU key again so that the display shows FADE OUT > XXS, where XX is the current fade-out time, in seconds.**
- 4 **Turn the MULTI DIAL or use the SKIP keys to change the value of the fade-out time.**

It is possible to set the fade-in time only (perform step 5 after step 2) or the fade-out time only (in step 1, press the MENU key until the fade-out time menu item is shown).

To perform a fade-in:

- 1 **With a recordable disc loaded, press the RECORD key so that the unit enters record ready mode.**
- 2 **Start the source material, and press the FADER key.**

The display shows FADE IN for the time specified in the menu item above.

As the fade progresses, the monitored signal gradually becomes louder, reflecting the level recorded on disc.

To perform a fade-out:

- 1 **While recording, press the FADER key.**

The display shows FADE OUT for the time specified in the menu above.

As the fade progresses, the monitored signal gradually becomes quieter, reflecting the level recorded on disc.

- 2 **When the end of the fade-out time is reached, the unit goes into record ready mode. Recording can be restarted with the FADER key or the PLAY or PAUSE keys.**

The fade-in and fade-out times can be reset to new values while recording is in progress.

Fades are also possible in digital direct mode (“Digital direct” on page 32).

Copy-protection

The CC-222 allows copy-protection to be applied to the discs produced. Naturally, the copy-protection applies only to digital-to-digital copies.

There are three settings:

- **FREE** (may be freely copied), where no copy-protection is applied to the recorded disc.
- **1 GEN** (single-generation copying), where one digital copy (“child”) can be made from the recorded disc, but no digital copies (“grandchildren”) can be made from the child.
- **PROH** (copy prohibited) which prevents any digital copies being made from the recorded disc

- 1 Press the MENU key repeatedly until the display shows COPY ID>XXXX, where**

XXXX is the current setting for copy-protection as shown above.

- 2 Turn the MULTI DIAL or use the SKIP keys to change the copy-protection setting.**

NOTE

Copy-protection applies on a “per-track”, not a per-disc basis. This means that you can apply different copy-protection levels to different tracks (but you can’t apply different copy-protection levels to different parts of the same track). If copy-protection is important to your work, you may want to check this setting every time you make a recording, to ensure that you have the protection level that you want.

6 – After recording

This section deals with the actions taken after recording: finalizing for CD-R and CD-RW discs, and erase operations for CD-RW discs.

Once finalized, CD-R discs are truly final—no more can be recorded on them. By contrast, CD-RW discs

can be “unfinalized” using the CC-222, that is, their TOC can be deleted, and if there is space, further material can be recorded on them. Even if the disc is full, tracks can be erased following the unfinalize process, and new material can be recorded.

Finalizing

As has been explained earlier (“Finalizing” on page 8), in order for a disc to become a standard CD, it must have a Table of Contents (TOC) written to it. This process is known as finalizing.

An unfinalized disc can always be distinguished on the CC-222 by the NO TOC indicator under the disc type on the display being lit when the disc is inserted.

To finalize a disc:

- 1 **With the unfinalized (recordable) disc loaded, and the unit in stop mode, press the FINALIZE key.**

The display shows `Finalize OK?`.

- 2 **To start the finalizing process, press the MULTI DIAL or press the ENTER key.**

If you do not want to proceed with the finalizing process, press any other key (such as the STOP key).

If finalization has been chosen, the display changes. The NO TOC indicator goes out, and the word `TOC` and the REC indicator flash in the display. The unit starts counting down from a time shown on the display (about 1 minute 10 seconds).

After finalization, a CD-RW NO TOC changes to CD-RW and a CD-R NO TOC changes to a CD.

NOTE

Although CD-R discs finalized on the CC-222 may be replayed on ordinary CD players, remember that finalized CD-RW discs may not play on CD players.

Unfinalizing CD-RW discs

If a CD-RW disc has been finalized, it is possible to erase the Table of Contents in the following way:

- 1 **With the finalized disc loaded and the unit in stop mode, press the ERASE key.**
- 2 **If the display does not show the word `Unfinalize?`, turn the MULTI DIAL or use the SKIP keys until it is displayed.**
- 3 **To start the unfinalizing process, press the MULTI DIAL control or press the ENTER key.**

If you do not want to proceed with the unfinalizing process, press any other key (such as the STOP key).

If unfinalization has been chosen, the NO TOC indicator starts flashing in the display, and the word `ERASE` also starts flashing. The unit starts counting down from a time shown on the display (depending on the disc and material, this value will be between 50 seconds and 1 minute 30 seconds).

After unfinalization, a CD-RW indicator changes to a CD-RW NO TOC indicator.

Erasing

Unfinalizing (described above) is a special case of erasing a disc. It is also possible to erase a track or tracks, starting with the last-recorded track, a whole disc, or to “refresh” a disc.

NOTE

Erase procedures are possible only on a CD-RW disc. Even if a CD-RW disc has been finalized, selecting an erase procedure will automatically unfinalize it prior to erasure. The disc may then have to be re-finalized. Remember that it is not possible to perform any erase procedures on a CD-R disc.

Erasing tracks

It is possible to erase the last recorded track, the last two recorded tracks, the last three recorded tracks, etc. It is not, however, possible to erase tracks in the “middle” of the disc.

- 1 With the disc loaded, and the unit in stop mode, press the **ERASE** key.
- 2 If the display does not show **ERASE XX-XX?**, where **XX** is the number of the last track recorded on the disc, turn the **MULTI DIAL** or use the **SKIP** keys until it is displayed.
- 3 Turn the **MULTI DIAL** or use the **SKIP** keys to change the number of the first track to be erased. The highest value that this number can take is the last track recorded (for example, if 17 tracks have been recorded on the disc, **17-17** means that the last track only, number 17, will be erased). The lowest value that this number can take is **2** (if this number was **1**, the whole disc would be erased, as described below).

If you do not want to proceed with the erase operation, press any other key (such as the STOP key).

NOTE

If only one track has been recorded on the disc, only the “erase disc” option (, “Erasing a whole disc”) is available.

- 4 When the range of tracks to be erased has been selected, press the **MULTI DIAL** or the **ENTER** key.

NOTE

This operation cannot be undone. If you are going to erase a track or tracks, make sure that they are recordings that you really want to erase!

If the erase operation has been selected, the word ERASE flashes on the display, and the timer starts counting down.

At the end of the countdown period, the word Complete appears briefly on the display, and the display returns to the track/time display.

Erasing a whole disc

When you want to erase a whole disc (all the tracks on a disc), follow the procedure below:

- 1 With the disc loaded, and the unit in stop mode, press the **ERASE** key.
- 2 Turn the **MULTI DIAL** or use the **SKIP** keys until the display shows **ERASE DISC?**.
If you do not want to proceed with the erase operation, press any other key (such as the **STOP** key).
- 3 To erase the contents of the disc, press the **MULTI DIAL** or the **ENTER** key.

NOTE

This operation cannot be undone. If you are going to erase a disc, make sure that it contains only recordings that you really want to erase!

If the erase operation has been selected, the word ERASE flashes on the display, and the timer starts counting down a time value shown on the display.

At the end of the countdown period, the word Complete appears briefly on the display, and the display returns to the track/time display.

Refreshing a disc

If a CD-RW disc has been corrupted at any point (e.g. power has been cut off in the middle of a finalize operation, etc.), or has been used in a computer or another piece of equipment that makes it unreadable, it is possible to “refresh” the disc to make it usable again. This is equivalent to formatting a disk on a computer to prepare it for use. This operation destroys all data on the disc.

- 1 With the disc loaded, and the unit in stop mode, press the **ERASE** key.
- 2 Turn the **MULTI DIAL** or use the **SKIP** keys until the display shows **DISC REFRESH**.
- 3 To refresh the disc, press the **MULTI DIAL** or the **ENTER** key.

6 – After recording—Erasing

If you do not want to proceed with the refresh operation, press any other key (such as the **STOP** key).

NOTE

This operation cannot be undone. If you are going to refresh a disc, make sure that it contains only recordings that you really want to erase!

If the refresh operation has been selected, the words **ERASE XX:XX** are shown on the

display, and the timer starts counting down (XX:XX).

At the end of the countdown period, the word **Complete** appears briefly on the display, and the display returns to the track/time display (of course, there are no tracks, and the disc is at the start, with the total time of the disc available for recording).

Troubleshooting

Symptom	Possible cause and remedy
No power when POWER is pressed	The power cord is not inserted properly. Check and correct this.
Hum on playback	Audio connections not made properly. Check the connections
No audio output	The external amplifier is not properly connected, or the wrong set of inputs connected to the active LINE OUTPUT s has been selected on the amplifier. Check and correct.
The remote control does not seem to work	Is the power on? Are the batteries in the remote control dead? Is the remote control unit too far away or at the wrong angle for correct operation ("Use of the remote control unit" on page 10)?
Low sound quality when playing back a tape	The heads are dirty or magnetized. See "Tape maintenance" on page 41.
Sound is odd when playing back a tape	Pitch control may be off center ("Pitch control" on page 18)
Tape recording cannot be carried out	The write-protect tabs have been broken off the cassette, the heads are dirty, or the recording level is set too low.
Hum appears at the PHONO input	The grounding wire is not connected from the record deck to the CC-222.
No sound on playback (the disc is playing and the time display is incrementing)	The connections from the CC-222 to the amplifier system have not been made properly, or the input source selector is not at the correct position.
No meter indication when a source is input	Analog and/or digital volume ("Signal volume" on page 24) is set too low. The signal is being input through an unselected input source ("Input selection" on page 24) or The input selection is not made correctly ("Recording operations" on page 16 (tape) or "Input selection" on page 24 (disc).
There is a gap in the A-B loop when played back	The A and B points are in different tracks.
The unit is in AUTO SPACE mode and is not playing (it is paused)	When the unit is automatically paused as a result of the auto space mode, pressing the AUTO SPACE key puts the unit into pause mode, and playback does not resume automatically after the auto pause time is elapsed (see "Auto spacing" on page 23).
D-IN UNLOCK!	A digital input source has been selected for CD recording, but the source is not connected or is not switched on.
Cannot record on a disc (pressing RECORD shows MONITOR)	A finalized disc has been inserted. Use an unfinalized recordable disc.
The recording level suddenly jumps (up or down) when switching to or from digital direct mode	When recording from digital sources, the digital direct mode bypasses the digital level ("Signal volume" on page 24), so that if this has been set to a non-zero value, the level will be different. See "Digital direct" on page 32.
PGM Full !	An attempt has been made to create more than 25 program steps.
Disc Full! or Cannot Rec!	There is no space on the disc, or no tracks are available, or a general recording error has occurred.
Not FS 44.1k!	You are trying to do digital direct recording from a source which has not been recorded at 44.1 kHz ("Digital direct" on page 32).
Disc Error	The disc is bad. If it is a CD-RW disc, you may refresh it ("Refreshing a disc" on page 35), otherwise replace the disc.
Erase Error!	An error has occurred while trying to erase the disc.
The display suddenly shows PMA Writing	Either the disc is full (this message will be prefaced by Disc Full!!! ("Full disc" on page 26) or an attempt has been made to write more than 99 tracks.
Rec Error	General recording error. This may be caused by vibration or a shock during recording, for example, or may be the result of a bad disc. Try recording again with the same disc. If the message appears again, try a different disc.
No OPC Area!	Appears only with CD-R discs. The OPC area is full, and no further recording is possible on this disc. Finalize the disc.
OPC Area CLR	Seen when a CD-RW disc OPC area is full, and the CC-222 automatically cleans up the OPC area for further recording.
Need Repair!	Current disc needs repair. Refresh the CD-RW disc using the procedure described in "Refreshing a disc" on page 35.
System Err!	System error.

7 – Reference and specifications—Menu items

Symptom	Possible cause and remedy
Tray Error!	Error in the CD tray mechanism.
Drive Error!	Error in the CD drive mechanism.

Menu items

The following are the menu items that can be set using the **MENU** key. The majority of them affect disc recording.

Pressing the **MENU** key repeatedly cycles through the menu items. Not every menu item is available in every situation (for instance, if a digital input is not selected, the digital direct option is not shown).

Turn the **MULTI DIAL** to change a value.

Press the **MULTI DIAL** to confirm the change and exit the menu system.

Alternatively, keep pressing the **MENU** key until the normal time counter is displayed.

Menu displayed	Meaning	Described in:	Default (factory) value
A-TRACK	Automatic track increment	"Automatic track division" on page 31	ON
S-LVL	Sound (trigger) level for track increment	"Setting the trigger level" on page 28 and "Using the trigger level" on page 29	-54dB
COPY ID	Copy-protection on recorded discs	"Copy-protection" on page 33	1 GEN
FADE IN	Allows fade in of recorded discs	"Fade-in and fade-out" on page 32	3s
FADE OUT	Allows fade out of recorded discs	"Fade-in and fade-out" on page 32	3s
DUB>VOL	Bypasses (THRU) or enables (ON) the internal volume when dubbing from tape to disc or disc to tape	"Dubbing tapes from the CD deck" on page 16 and "Dubbing from tape to disc" on page 27	THRU
PHONO	Sends the PHONO inputs to DISC or TAPE	"Recording tapes from the PHONO deck" on page 17 and "Recording to disc from the RIAA PHONO inputs" on page 27	DISC
D_DIRECT	Records directly from the digital source to disc	"Digital direct" on page 32	OFF
VOLUME	Digital volume control	"Signal volume" on page 24	0dB

Resetting default menu values

User settings and the values of the input selection for 1 and 2 are stored in memory, and are retained when the power is turned off.

To restore these settings to the factory defaults as in the table above, use a ballpoint pen or similar to hold down the **RESET** button on the rear panel:

While holding down the button, turn on the power to the unit and keep the **RESET** button pressed for at least two seconds after turning on the power. The menu values will be reset. The values for **INPUT 1** and **INPUT 2** are set to LINE 1 and LINE 2 respectively.

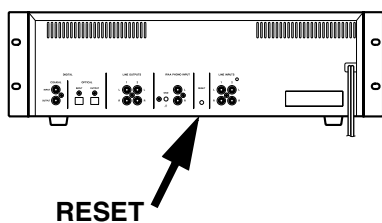

Specifications

CD recorder section

Recording media type	CD-R, CD-RW, CD-RDA, CD-RWDA
Recording resolution	16-bit linear
Recording sampling frequency	44.1 kHz
Frequency response	20 Hz — 20 kHz (playback ± 0.5 dB, recording ± 1 dB)
S/N ratio	> 88 dB (playback) > 83 dB (recording)
Dynamic range	> 88 dB (playback) > 83 dB (recording)
Total harmonic distortion	< 0.012% (playback) < 0.015% (recording)
Channel separation	80 dB (playback: 1 kHz) 75 dB (recording: 1 kHz)
Wow & flutter	Unmeasurable (< 0.001%)

Digital inputs

COAXIAL	RCA pin, IEC60958 TYPE II
OPTICAL	TOSLINK, IEC60958 TYPE II

Digital outputs

COAXIAL	RCA pin, IEC60958 TYPE II
OPTICAL	TOSLINK, IEC60958 TYPE II

LINE INPUTS 1

	Unbalanced RCA
Nominal input level	-10 dBV (6dBV -16 dB)
Maximum input level	+ 6dBV
Input impedance	10 k Ω

LINE OUTPUTS 1

	Unbalanced RCA
Nominal output level	-10 dBV (FS -16 dB)
Maximum output level	+6 dBV
Output impedance	1 k Ω (unbalanced)

Cassette recorder section

Number of channels	4-track, 2-channel stereo
Heads	Record/playback x 1 (rotary reverse), erase x 1
Type of tape	Compact Cassette C-60, C-90 (Type I (normal), Type II (high-position/chrome) –recording and playback; Type IV (metal)–playback only)
Tape speed	4.76 cm/s (1 7/8 ips)
Motor	DC servo motor (x 1)
Wow and flutter	0.19% (W. RMS)
Frequency response (overall)	50Hz — 12.5kHz ± 3 dB (high position) 50Hz — 10kHz ± 3 dB (normal)
Signal-to-noise ratio (overall)	46dB (Dolby NR off) 52dB (Dolby NR on)
Fast winding time	About 120 seconds (C-60)

7 – Reference and specifications—Specifications

LINE INPUTS 2	Unbalanced RCA
Nominal input level	Nominal input level 0.28V (-11 dBV)
Input impedance	50 k Ω

LINE OUTPUTS 2	Unbalanced RCA
Nominal output level	0.46V (-6.7 dBV)
Output impedance	50 k Ω

Phono input and headphones

RIAA PHONO INPUT	Unbalanced RCA (with ground)
Cartridge type	MM (moving magnet)
Input signal level	5.6mV
Input impedance	47 k Ω
Signal-to-noise ratio	60 dB

PHONES (headphone output)	6 mm (1/4") stereo
Output level	10 mW + 10 mW (into 32 Ω)

General specifications

Voltage requirements	USA/Canada 120 VAC, 60 Hz U.K./Europe 230 VAC, 50 Hz Australia 240 VAC, 50 Hz General export 120/230 VAC, 60 Hz
Power consumption	30 W
Applicable electromagnetic environment	E4
Peak inrush current	1.2 A
Dimensions	483 x 138 x 295 (mm) 19 x 5.4 x 11.6 (in)
Weight	8 kg (17.6 lbs)
Operating temperature	5°C to 35°C (41°F to 95°F)
Supplied accessories	RC-222 remote control unit

Dimensional drawing

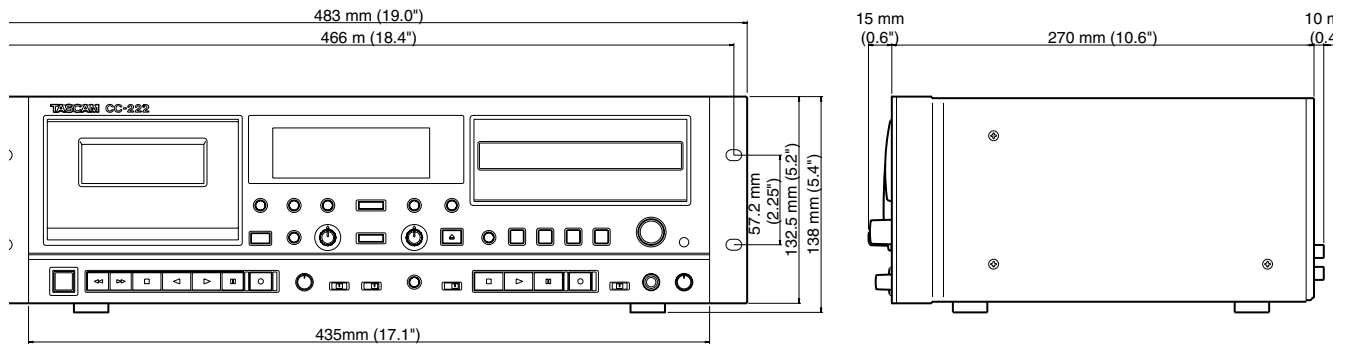

Tape maintenance

The heads and tape path should be cleaned and demagnetized periodically.

Cleaning the tape path Apply head cleaning fluid to a cotton bud or soft cloth, and lightly rub the heads, capstan and all metal parts in the tape path.

Also clean the pinch roller using rubber cleaning fluid.

Both fluids are available in TEAC Tape Cleaning Kits HC-2 and RC-2 in the U.S.A. or TZ-261 in other areas.

Demagnetizing heads Be sure that the power is off, then demagnetize the heads using a TEAC E-3 demagnetizer.

For details of its use, read the instructions supplied with the demagnetizer and make sure you understand them thoroughly before attempting this operation.

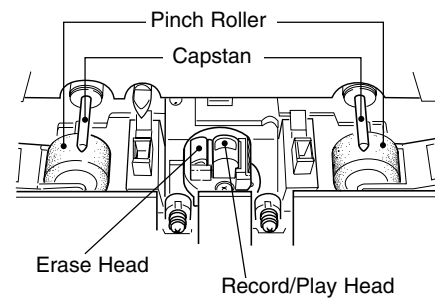

TASCAM

TEAC Professional Division

CC-222

TEAC CORPORATION

Phone: (0422) 52-5082

3-7-3, Nakacho, Musashino-shi, Tokyo 180-8550, Japan

TEAC AMERICA, INC.

Phone: (323) 726-0303

7733 Telegraph Road, Montebello, California 90640

TEAC CANADA LTD.

Phone: 905-890-8008 Facsimile: 905-890-9888

5939 Wallace Street, Mississauga, Ontario L4Z 1Z8, Canada

TEAC MEXICO, S.A. De C.V

Phone: 5-851-5500

Campesinos No. 184, Colonia Granjes Esmeralda, Delegacion Iztapalapa CP 09810, Mexico DF

TEAC UK LIMITED

Phone: 01923-819699

5 Marlin House, Croxley Business Park, Watford, Hertfordshire. WD1 8TE, U.K.

TEAC DEUTSCHLAND GmbH

Phone: 0611-71580

Bahnstrasse 12, 65205 Wiesbaden-Erbenheim, Germany

TEAC FRANCE S. A.

Phone: 01.42.37.01.02

17 Rue Alexis-de-Tocqueville, CE 005 92182 Antony Cedex, France

TEAC BELGIUM NV/SA

Phone: 0031-162-510210

Oeverkruid 15, NL-4941 VV Raamsdonksveer, Netherlands

TEAC NEDERLAND BV

Phone: 0162-510210

Oeverkruid 15, NL-4941 VV Raamsdonksveer, Netherlands

TEAC AUSTRALIA PTY.,LTD. A.B.N. 80 005 408 462

Phone: (03) 9672-2400 Facsimile: (03)9672-2249

280 William Street, Port Melbourne, Victoria 3000, Australia

TEAC ITALIANA S.p.A.

Phone: 02-66010500

Via C. Cantù 11, 20092 Cinisello Balsamo, Milano, Italy

Printed In China MA-0557

Free Manuals Download Website

<http://myh66.com>

<http://usermanuals.us>

<http://www.somanuals.com>

<http://www.4manuals.cc>

<http://www.manual-lib.com>

<http://www.404manual.com>

<http://www.luxmanual.com>

<http://aubethermostatmanual.com>

Golf course search by state

<http://golfingnear.com>

Email search by domain

<http://emailbydomain.com>

Auto manuals search

<http://auto.somanuals.com>

TV manuals search

<http://tv.somanuals.com>