

# *Stereo Cassette Deck*

---

Operating Instructions

*TC-WE525  
TC-WE425  
TC-WR681*

## WARNING

To prevent fire or shock hazard, do not expose the unit to rain or moisture.

NOTICE FOR THE CUSTOMERS IN THE U.S.A.

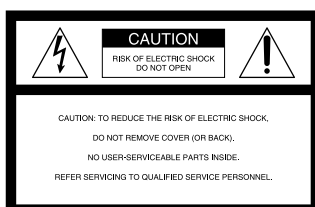

This symbol is intended to alert the user to the presence of uninsulated “dangerous voltage” within the product’s enclosure that may be of sufficient magnitude to constitute a risk of electric shock to persons.



This symbol is intended to alert the user to the presence of important operating and maintenance (servicing) instructions in the literature accompanying the appliance.

### Owner’s Record

The model and serial numbers are located on the rear panel of the unit. Record the serial number in the space provided below. Refer to them whenever you call upon your Sony dealer regarding this product.

Model No. \_\_\_\_\_

Serial No. \_\_\_\_\_

### INFORMATION

This equipment has been tested and found to comply with the limits for a Class B digital device, pursuant to Part 15 of the FCC Rules. These limits are designed to provide reasonable protection against harmful interference in a residential installation. This equipment generates, uses, and can radiate radio frequency energy and, if not installed and used in accordance with the instructions, may cause harmful interference to radio communications. However, there is no guarantee that interference will not occur in a particular installation. If this equipment does cause harmful interference to radio or television reception, which can be determined by turning the equipment off and on, the user is encouraged to try to correct the interference by one or more of the following measures:

- Reorient or relocate the receiving antenna.
- Increase the separation between the equipment and receiver.
- Connect the equipment into an outlet on a circuit different from that to which the receiver is connected.
- Consult the dealer or an experienced radio/TV technician for help.

### CAUTION

You are cautioned that any changes or modifications not expressly approved in this manual could void your authority to operate this equipment.

## Welcome!

Thank you for purchasing the Sony Stereo Cassette Deck. Before operating the unit, please read this manual thoroughly and retain it for future reference.

## About This Manual

The instructions in this manual are for models TC-WE525, TC-WE425 and TC-WR681. Check your model number by looking at the rear panel of your tape deck. In this manual, the TC-WE525 is the model used for illustration purposes. Any difference in operation is clearly indicated in the text, for example, “TC-WE525 only.”

### Type of differences

	Model	WE525	WE425	WR681
Feature				
Pitch control		•		
PHONES jack		•	•	
CD Synchro-Recording		•	•	

### The power switch

The power switch is different, depending on the place you purchased the tape deck.

### Where purchased The power switch

U.S.A. I/⏻

Other countries ①

### Convention

The following icon is used in this manual:



Indicates hints and tips for making the task easier.

# TABLE OF CONTENTS

---

## Getting Started

- Unpacking 4
  - Hooking Up the System 4
- 

## Playing a Tape 5

## Recording on a Tape 6

---

## Advanced Recording Operations

- Adjusting the Recording Level Automatically (Auto Rec Level) 8
  - Fading In and Out (Fader) 9
  - Dubbing a Tape 9
  - Inserting a Blank Space During Recording (Record Muting) 10
  - Synchro-Recording With a CD Player Through a Monaural (2P) Mini-plug Cord (TC-WE525/WE425 only) 11
- 

## Additional Information

- Precautions 13
  - Notes on Cassette Tapes 13
  - Cleaning 14
  - Troubleshooting 15
  - Specifications 16
- 

## Index 17

## Unpacking

Check that you received the following items:

- Audio connecting cords (2)

## Hooking Up the System

This section describes how to hook up the tape deck to an amplifier. Be sure to turn off the power of each component before making the connections.

To purchasers of the TC-WR681

For information on connecting your tape deck to the TA-AV581 Amplifier, refer to the Operating Instructions included with the TA-AV581.

To purchasers of the TC-WE525/WE425

Follow the instructions below to connect your tape deck to an amplifier.

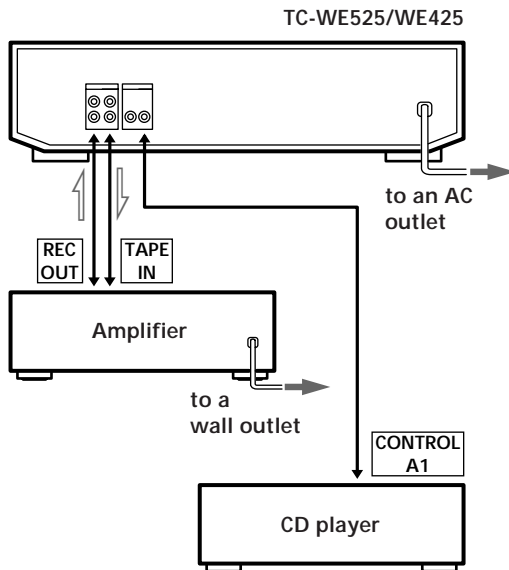

⇒: Signal flow

## Hookups

- Connecting the tape deck to an amplifier  
Connect the amplifier to the LINE IN/OUT connectors using the supplied audio connecting cords. When connecting an audio connecting cord, be sure to match the color-coded cord to the appropriate jacks on the components: Red (right) to Red and White (left) to White. Be sure to make connections firmly to avoid hum and noise.  
Connect the tape deck to the amplifier as shown below.

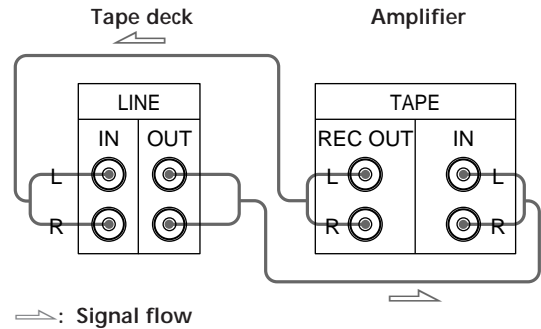

- Connecting the tape deck to a CD player equipped with CONTROL A1 connectors (TC-WE525/WE425 only)  
For information on connections through the CONTROL A1 connectors, refer to the pamphlet included with this manual.

## Connecting the AC power cord

Connect the AC power cord to an AC outlet.

## Where do I go next?

Now you're ready to use your tape deck.  
For basic operations, go to pages 5 to 7; for advanced operations, go to the sections starting from page 8.

# Playing a Tape

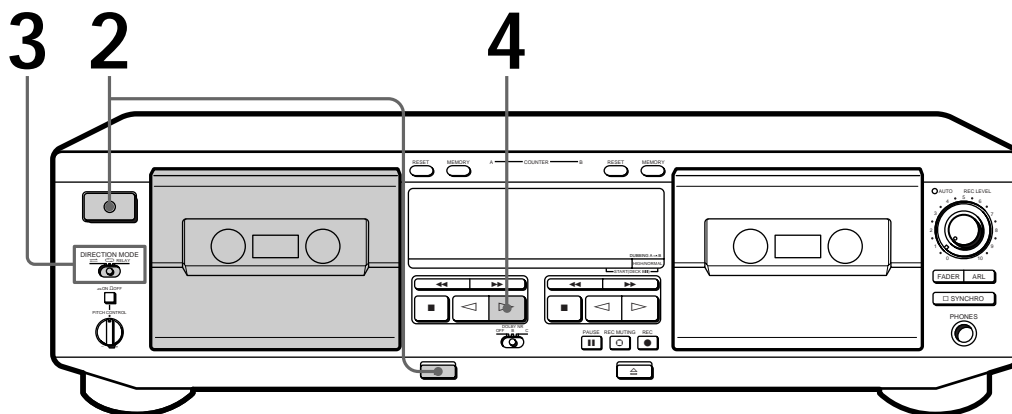

- See page 4 for hookup information.
- You can use either deck for playback.

**To locate the beginning of a tape and start playback automatically (Auto Play)**  
 Press ◀ while holding down ▷. For the reverse side, press ▶ while holding down ◀.

**To play a tape recorded with the Dolby NR\* system**  
 Set DOLBY NR to the same position that the tape was recorded in—B or C.

**What is the Dolby NR system?**  
 The Dolby NR (noise reduction) system eliminates tape hiss noise by boosting low-level signals in the high-frequency range during recording, then lowering them during playback. Type C provides greater noise reduction than type B.

**You can connect the headphones to PHONES (TC-WE525/WE425 only)**

\* Dolby noise reduction manufactured under license from Dolby Laboratories Licensing Corporation.

“DOLBY” and the double-D symbol are trademarks of Dolby Laboratories Licensing Corporation.

**1** Turn on the amplifier and select the tape deck position.

**2** Press I/⏻ (or ⏻), and then press ⏮ and insert a cassette.

With the side you want to play facing you

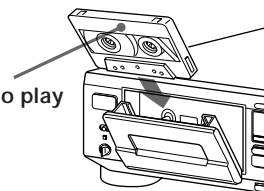

**3** Set DIRECTION MODE.

To play back	Set to
One side only	↔
Both sides continuously*	↻
Both decks in succession*	RELAY

\* The deck automatically stops after playing back five times.

**4** Press ▷.  
 The deck starts playing. Adjust the volume on the amplifier.

Do not turn off the deck during operation.

To	Press
Stop playing	■
Start playback from the reverse side	◀
Pause (deck B only)	PAUSE    . Press the button again to resume play.
Fast-forward or rewind	▶▶ or ◀◀
Take out the cassette	⏮ after stopping playing

**To adjust the pitch (Pitch Control function) (TC-WE525 only)**

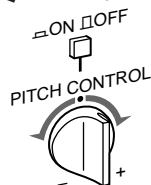

Push in the PITCH CONTROL button to activate Pitch Control function and turn the control clockwise to raise the pitch or counter-clockwise to lower it. You can adjust the pitch during playback on deck A or normal-speed dubbing.

# Recording on a Tape

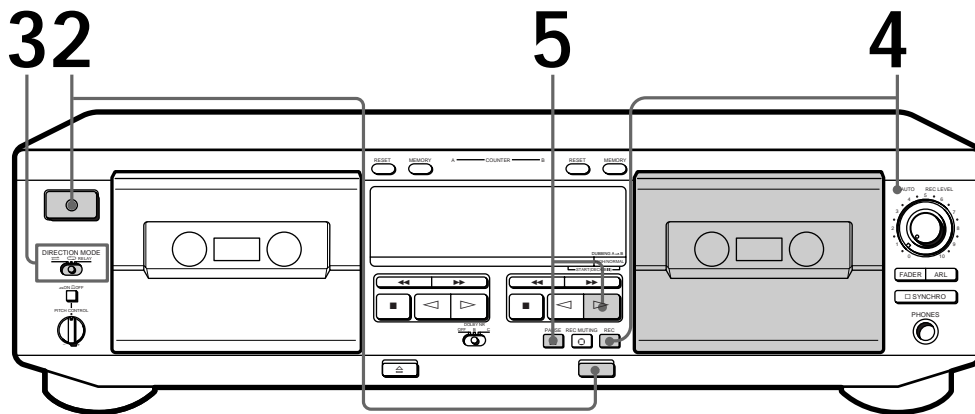

- See page 4 for hookup information.
- Use deck B (on your right hand side) for recording.
- See "Dubbing a Tape" (page 9) to make a copy of the tape.

**1** Turn on the amplifier and play the program source you want to record.

**2** Press I/⏻ (or ①), and then press ⏏ and insert a cassette into deck B.

With the side you want to record facing you

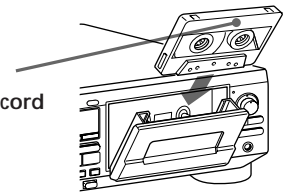

**3** Set DIRECTION MODE.

To record on	Set to
Only one side	↔
Both sides*	↻



\* Recording stops when the tape reaches the end of reverse side.

**4** Press REC ●.

▷ lights up for recording on the side facing you. If it doesn't, press ▷ once.





The tape deck automatically adjusts the recording level (see page 8). After the AUTO indicator lights up continuously, stop playing the program source. If you wish to adjust the recording level manually, see "To adjust the recording level manually" on page 7.

 To protect recordings against accidental erasure Break out the record-protect tab(s) (see page 13).

**5** Press PAUSE  or .  
Recording starts.

**6** Start playing the program source.

Do not turn off the deck during operation.

To	Press
Stop recording	
Start recording from the reverse side	 twice in Step 5
Pause	PAUSE  . Press the button again to resume recording.
Take out the cassette	 after stopping recording

 The Dolby HX PRO\* system automatically works during recording Distortion and noise in the high-frequency response are reduced to produce high-quality sound that can be enjoyed even during playback on other tape decks.

Use these switches (controls) to perform additional operations

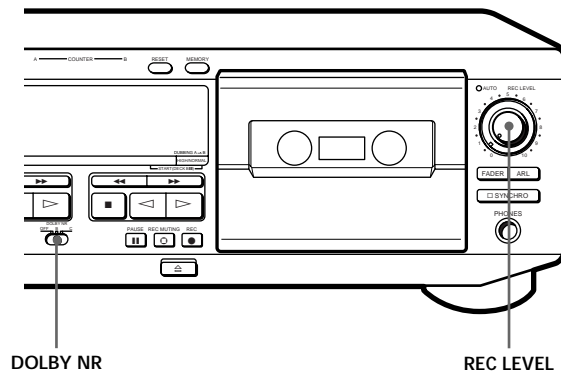

To record with the Dolby NR system

Set DOLBY NR to B or C before you start recording.

To adjust the recording level manually

After pressing REC ● in Step 4 on page 6, turn REC LEVEL so that the peak level meters reach the recommended level for the corresponding tape type. After completing the adjustment, stop playing the program source, then continue the procedure from Step 5.

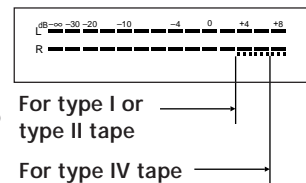

\* HX Pro headroom extension originated by Bang & Olufsen and manufactured under license from Dolby Laboratories Licensing Corporation.

“DOLBY”, the double-D symbol  and “HX PRO” are trademarks of Dolby Laboratories Licensing Corporation.

## Adjusting the Recording Level Automatically (Auto Rec Level)

The Auto Rec Level function automatically measures the peak signal level and adjusts the recording level accordingly.

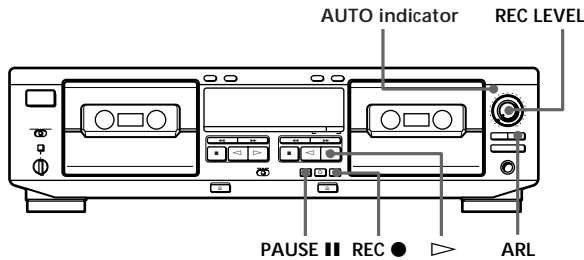

- 1 Follow Steps 1 to 3 of “Recording on a Tape” on page 6.  
Make sure that record-protect tabs on the cassette have not been removed.
- 2 Press REC ●.  
The AUTO indicator flashes and the deck automatically adjusts the recording level. The AUTO indicator lights up continuously after the recording level has been adjusted.
- 3 Press PAUSE || or ▷.  
Recording starts.

### To cancel the Auto Rec Level function

Press ARL or turn REC LEVEL so that the AUTO indicator goes off. If you do either of these during recording, recording will continue but with the Auto Rec Level function turned off.

### To stop recording

Press ■.

### 💡 What is the Auto Rec Level function?

The Auto Rec Level function automatically sets the recording level according to the peak signal level of the program source. While the AUTO indicator is flashing, the deck sets the recording level as high as possible without causing distortion. If the signal level rises excessively after the start of recording, the deck gradually decreases the recording level.

- 💡 You should adjust the recording level manually with REC LEVEL in the following cases:
- The recording level cannot be adjusted properly due to excessive noise in the program source.
  - The program source level is too low and the recording level does not increase.  
During a quiet passage in a program source such as classical music, the recording level may not increase for some time. If a high sound level is expected later on in the track, play that portion first so that the right adjustment can be obtained.
  - The recording level does not decrease for a long time. The Auto Rec Level function may not work properly when you try to record sound produced by a graphic equalizer that has extremely high-level signals.

- 💡 To record with the optimum recording level
- To prevent changes in the recording level after recording starts, press REC ● while playing the highest sound level portion of the program source to be recorded. The result is a more natural-sounding recording.
  - If you play the entire program source after the AUTO indicator has stopped flashing and is lit continuously, the deck will set the recording level for the portion of the program source with the highest signal level.

### 💡 Recording level setting remains even after the recording has ended

After you have finished recording with the Auto Rec Level function, the AUTO indicator remains on and the recording level setting remains the same. To cancel the setting, do one of the following:

- Press ARL to turn off the AUTO indicator
- Turn REC LEVEL
- Turn the deck off.



## Fading In and Out (Fader)

You can gradually increase the recording level at the beginning of a recording (fade in) or gradually decrease the recording level at the end of a recording (fade out).

It is convenient to use this function, for example, when the tape reaches to its end and you don't want the track to be cut off abruptly.

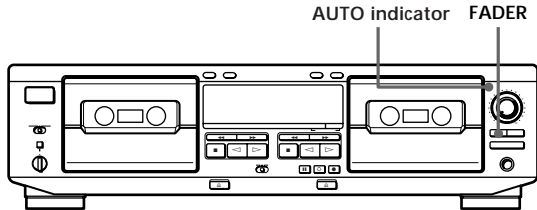

To	Do the following:
Fade in	<ol style="list-style-type: none"> <li>Follow Steps 1 to 4 of "Recording on a Tape" on page 6.</li> <li>Press FADER. During fade-in, the AUTO indicator flashes. When the fade-in has completed, the AUTO indicator goes off. (The AUTO indicator lights continuously if the Auto Rec Level function is on.)</li> </ol>
Fade out	Press FADER when you want to start fading out while recording. When the fade-out has completed, "REC" flashes in the display and the deck pauses.

**Note**

Fade-in or fade-out is not possible when REC LEVEL is set to 0 (minimum).

## Dubbing a Tape

You can copy a tape in deck A to a tape in deck B at normal or high speed.

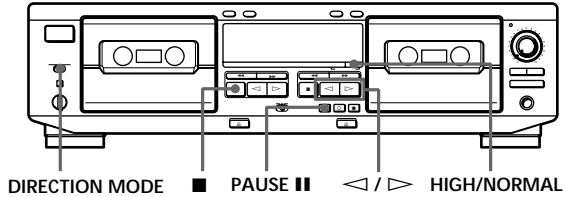

- 1 Insert the recorded cassette into deck A and a blank cassette into deck B. Make sure the record-protect tabs on the cassette in deck B have not been removed.

- 2 Select the side(s) to be recorded on.

To record on	Set DIRECTION MODE to
One side	↔
Both sides	↻ Recording on the reverse side on deck B starts independently of playback on deck A.
	RELAY. Recording on the reverse side on deck B starts simultaneously with playback of the reverse side on deck A.

- 3 Select the dubbing speed.

To select	Press HIGH/NORMAL
Normal speed	Once
High speed	Twice

"HIGH" or "NORM" appears in the display. The tape deck changes to dubbing standby.

- 4 Select the side from which to start dubbing.



To record from	Press
The front side	▷
The reverse side	◁

- 5 Press PAUSE ■ to start dubbing.

**To stop dubbing**

During	Press
Normal-speed dubbing	■ on deck B
High-speed dubbing	■ on either deck

(Continued)

-  During high-speed dubbing  
Only ■ is operative.
-  You don't have to adjust the recording level or select the Dolby NR system during dubbing  
Dubbing is automatically performed with the same recording level and Dolby NR system as the original in deck A. If, however, you want to monitor the sound during normal-speed dubbing, set DOLBY NR to match the tape in deck A (see page 5).
-  You can adjust the pitch of the playback on deck A (TC-WE525 only)  
See page 5.

### Note

If a TV set is placed near the tape deck, noise may occur during high-speed dubbing. In that case, turn the television set off or move it away from the tape deck.

### Dubbing only specific portions

You can do this only during the normal-speed dubbing.

- 1** Press ■ on deck A at the portion you want to skip.  
Deck B changes to recording pause.
- 2** Locate the point you want to resume recording on deck A, then stop the tape.
- 3** Press PAUSE ■■ to resume dubbing.

## Inserting a Blank Space During Recording (Record Muting)

You can insert a blank space of 4 seconds between each track or erase unwanted portions on a tape.

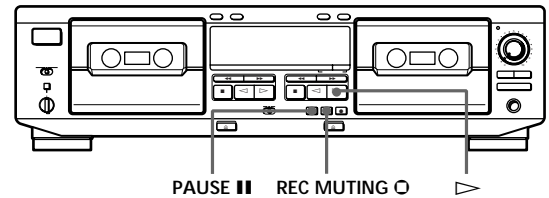

- 1** Start recording.
  - 2** Press REC MUTING ○ where you want to insert a blank space.  
“REC” flashes in the display and a blank is recorded on the tape.  
After 4 seconds, ■■ lights up and the tape deck changes to recording pause.
  - 3** Press PAUSE ■■ or ▷ to resume recording.
-  If you want to insert a blank space longer than 4 seconds  
Hold down REC MUTING ○ as long as you want.  
After 4 seconds, “REC” flashes faster.  
When you release REC MUTING ○, ■■ lights up and the tape deck changes to recording pause.  
Press PAUSE ■■ or ▷ to resume recording.

## Synchro-Recording With a CD Player Through a Monaural (2P) Mini-plug Cord (TC-WE525/WE425 only)

By pressing SYNCHRO, you can perform synchro-recording on your tape deck with a Sony CD player connected to the CONTROL A1 connector through an optional monaural (2P) mini-plug cord (connecting cord for CONTROL A1) (see page 4). The monaural (2P) mini-plug cord supports advanced functions not possible with the commander-based CD synchro-recording function on previous models. Further information on the various operations made possible by a monaural (2P) mini-plug cord is provided in the pamphlet attached to this manual.

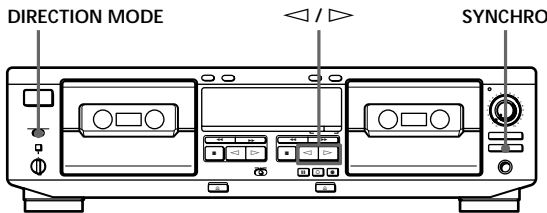

- 1 Set the source selector on the amplifier to CD player.
- 2 Insert a CD into the CD player.
- 3 Select the play mode (CONTINUE, SHUFFLE, or PROGRAM) of the CD player.
- 4 Insert a cassette into deck B.

To record on	Set DIRECTION MODE to
Only one side	⇒
Both sides	↻ or RELAY

- 5 Select the side(s) to be recorded on.
- 6 Press SYNCHRO.
- 7 Select the side you want to start recording from on deck B.

To record from	Press
The front side	▷
The reverse side	◁

If your CD player has the Peak Search function:  
The SYNCHRO button indicator lights up and the CD player locates the highest signal level among the tracks to be recorded as the tape deck adjusts the recording level. When the recording level adjustment is completed, CD Synchro-Recording starts automatically.

If your CD player does not have the Peak Search function:  
The CD player changes to play pause and deck B to recording pause. Press PAUSE ■ on deck B to start Synchro-Recording. Adjust the recording level automatically (see page 8) before pressing SYNCHRO.

To stop CD Synchro-Recording  
Press ■ on deck B or the CD player.

💡 You can use an optional remote to operate the CD player  
To start CD play, press ■ twice; to pause CD play, press ■ once; to locate a CD track, press ◀◀ or ▶▶.

💡 If the SYNCHRO button indicator goes off after flashing three times  
The tape cannot be recorded on because the record-protect tab(s) on the selected side(s) of the cassette has (have) been removed.

💡 Length of tape used for recording  
Tracks on a CD differ in length. Classical music CDs and others often have tracks that exceed the recording time of a single cassette side. In this case, record the tape manually.

💡 When recording from the middle of the tape  
A tape that is inserted and has not been played or recorded on is assumed by the deck to be a new tape, even if the present location is in the middle of the tape. The deck will transport the tape for 10 seconds before starting CD Synchro-Recording to bypass the portion corresponding with the leader. To begin CD Synchro-Recording without the ten-seconds delay, play or record on the tape for a few seconds before starting the CD Synchro-Recording procedure.

(Continued)



If the tape ends during CD Synchro-Recording on the front side of the tape (▷ lights up) and DIRECTION MODE is set to ↔ or RELAY Recording of the track ends immediately, the tape direction is reversed, and recording starts again from the beginning of the track. If the tape ends on the reverse side of the tape (◁ lights up), CD Synchro-Recording stops and the CD player stops playing.

### Notes

- To prevent interruption of the recording process, do not press any operation buttons on the CD player during CD Synchro-Recording.
- Certain operation buttons on the tape deck are disabled during CD Synchro-Recording.

### Precautions

#### On safety

- Do not disassemble the cabinet — this may result in an electrical shock. Refer servicing to qualified personnel only.
- Should any solid object or liquid fall into the cabinet, unplug the tape deck and have it checked by qualified personnel before operating it any further.

#### On power sources

- Before operating the tape deck, check that the operating voltage of the tape deck is identical with your local power supply. The operating voltage is indicated on the nameplate at the rear of the tape deck.
- The unit is not disconnected from the AC power source (mains) as long as it is connected to the wall outlet, even if the unit itself has been turned off.
- If you are not going to use the tape deck for a long time, be sure to disconnect the tape deck from the wall outlet. To disconnect the AC power cord, grasp the plug itself; never pull the cord.
- AC power cord must be changed only at the qualified service shop.

#### On operation

- Because of a safety mechanism, the function buttons will not operate if the cassette holder is not completely closed, if there is no cassette in the cassette holder, or if a cassette has been incorrectly inserted into the cassette holder.
- Be sure to stop the tape before turning off the tape deck. Otherwise, the tape may be damaged.

#### On placement

- Place the tape deck in a location with adequate ventilation to prevent heat build-up in the tape deck.
- Do not place the tape deck:
  - on a soft surface such as a rug that might block the ventilation holes on the bottom.
  - in a location near heat sources.
  - in a place subject to direct sunlight.
  - in an inclined position.
  - in a place subject to excessive dust or mechanical shock.

#### On cleaning the tape deck

Clean the cabinet, panel and controls with a soft cloth slightly moistened with a mild detergent solution. Do not use any type of abrasive pad, scouring powder or solvent such as alcohol or benzine.

If you have any questions or problems concerning your tape deck, please consult your nearest Sony dealer.

### Notes on Cassette Tapes

To protect a recording on side A or B  
Break out the respective tab.

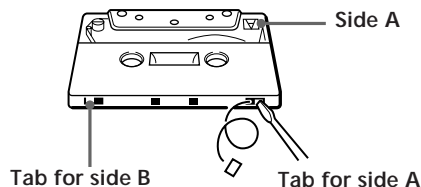

To record on a tape with a missing record-protect tab  
Cover the respective tab hole with adhesive tape.

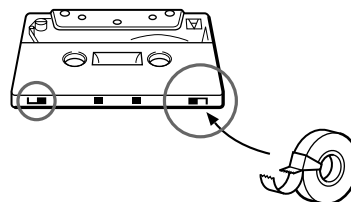

When you are using a type II or type IV tape, be careful not to cover the detector slots that the deck uses to determine the tape type.

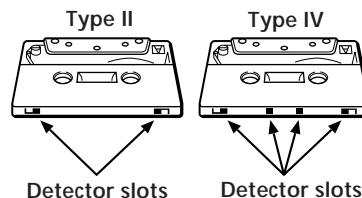

#### On tapes longer than 90 minutes

We do not recommend the use of tapes longer than 90 minutes except for a long continuous recording or playback. They are very thin and tend to stretch easily.

#### On handling cassettes

- To prevent the heads and tape path from getting dirty, avoid touching the tape surface of a cassette.
- Place cassettes away from equipment with magnets, such as speakers and amplifiers, which may cause tape distortion or erase the recordings.
- Do not expose cassettes to direct sunlight, extremely cold temperature, or moisture.

### Cleaning

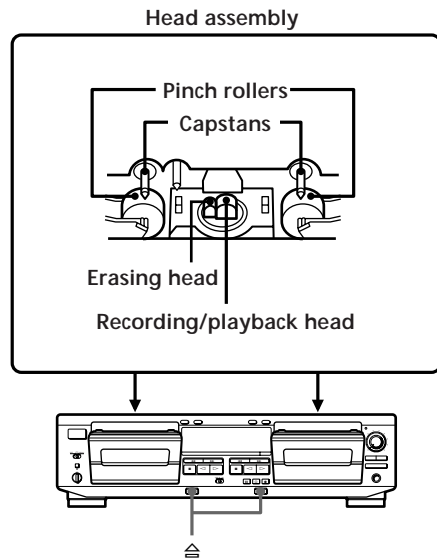

### Cleaning the heads and tape path

Clean the heads and tape path of the tape deck after every 10 hours of operation to guard against:

- low-quality sound
- a decrease in sound level
- excessive wow or flutter
- sound dropout
- incomplete erasure
- impairment of recording function

To ensure better recording, we recommend that you clean the heads and tape path before every recording.

- 1** Press  to open the cassette holder. Grasp the front cover on both sides and gently lift to remove it.
- 2** With the tape deck turned off, wipe the heads, the pinch rollers and the capstans with a cotton swab slightly moistened with alcohol or a commercially available cleaning fluid for tape decks.
- 3** Replace the front cover.

### Demagnetizing the heads

After 20 to 30 hours of use, or when you notice a hissing sound or loss of high frequencies, demagnetize the heads with a commercially available demagnetizer for tape decks. Please refer to the instructions of the demagnetizer.

## Troubleshooting

If you've experienced any of the following difficulties while using the tape deck, use this troubleshooting guide to help you remedy the problem. Should the problem persist, consult your nearest Sony dealer.

### The function buttons do not work.

- ➔ The tape deck has been just turned on and does not operate for about 3 seconds. Wait until **II** stops flashing.
- ➔ Check that the cassette is inserted correctly and the cassette holder is closed completely.

### The tape deck does not play or record.

- ➔ There is no cassette in the cassette holder.
- ➔ The tape has come to the end.
- ➔ The tape is slack. Take up the tape slack.
- ➔ The record-protect tab has been removed from the cassette (see page 13).
- ➔ Make sure the amplifier setting is correct.
- ➔ Check that the tape deck connections are secure.
- ➔ The heads and tape path are dirty. Clean them (see page 14).
- ➔ The recording/playback head is magnetized. Demagnetize it (see page 14).

### There is excessive wow, flutter or sound drop-out.

- ➔ The capstans and pinch rollers are dirty. Clean them (see page 14).

### There is a decrease in sound level, sound drop-out, or poor reproduction of high frequencies./The tape does not erase completely./Noise increases.

- ➔ The recording/playback or erasing head and tape path are dirty. Clean them (see page 14).
- ➔ The recording/playback or erasing head is magnetized. Demagnetize it (see page 14).

### There is hum or noise.

- ➔ The tape deck is placed near a TV or VCR. Move the tape deck away from the TV or VCR.
- ➔ The tape deck is placed on or under the amplifier. Move the tape deck away from the amplifier.

### There is an unbalanced tone.

- ➔ Check that DOLBY NR position is the same as when the tape was recorded.
- ➔ The tape deck is placed near a TV or VCR. Move the tape deck away from the TV or VCR.

### The tape stops before the tape has been fully rewind.

- ➔ The tape is slack. Take up the tape slack.
- ➔ The cassette shell is bent. Use another cassette.

### The DOLBY NR function does not work properly during playback.

- ➔ The Pitch Control function is on and the frequency characteristics of the sound is altered. Push the PITCH CONTROL button again to turn off the function (TC-WE525 only).

### There is excessively loud tape transport noise during fast-forwarding or rewinding.

- ➔ This noise is caused by the cassette and is not a mechanical problem.

### ⏪ does not work.

- ➔ There has been a power failure or the power cord has been disconnected during tape operation. Reconnect the power.

### There is a short break in sound output during playback.

- ➔ You pressed **▶▶**, **◀◀**, or **■** on one deck while the other deck was playing.  
Or you pressed PAUSE **II**, **▷**, or **◁** on deck B while deck A was playing.

### "--E--" appears in the display.

- ➔ All the operation buttons and controls on the deck do not work.  
Turn off the deck, then turn it on.

## Specifications

### System

#### Recording system

4-track 2-channel stereo

#### Fast-winding time (approx.)

100 sec. (with Sony C-60 cassette)

#### Bias

AC bias

#### Signal-to-noise ratio (at peak level and weighted with Dolby NR off)

Type I tape, Sony Type I (NORMAL): 55 dB

Type II tape, Sony Type II (HIGH): 57 dB

Type IV tape, Sony Type IV (METAL): 58 dB

#### S/N ratio improvement (approximate values)

With Dolby B NR on: 5 dB at 1 kHz, 10 dB at 5 kHz

With Dolby C NR on: 15 dB at 500 Hz, 20 dB at 1 kHz

#### Harmonic distortion

0.4% (with Type I tape, Sony Type I (NORMAL):

160 nWb/m 315 Hz, 3rd H.D.)

1.8% (with Type IV tape, Sony Type IV (METAL):

250 nWb/m 315 Hz, 3rd H.D.)

#### Frequency response (Dolby NR off)

Type I tape, Sony Type I (NORMAL): 30 – 16,000 Hz  
(±3 dB, IEC)

Type II tape, Sony Type II (HIGH): 30 – 17,000 Hz  
(±3 dB, IEC)

Type IV tape, Sony Type IV (METAL): 30 – 19,000 Hz  
(±3 dB, IEC)

30 – 13,000 Hz (±3 dB, -4 dB recording)

Type I tape, Sony Type I (NORMAL): 20 – 17,000 Hz  
(±6 dB)

Type II tape, Sony Type II (HIGH): 20 – 18,000 Hz  
(±6 dB)

Type IV tape, Sony Type IV (METAL): 20 – 20,000 Hz  
(±6 dB)

#### Wow and flutter

±0.15% W. Peak (IEC)

0.1% W. RMS (NAB)

±0.2% W. Peak (DIN)

### Inputs

#### Line inputs (phono jacks)

Sensitivity: 0.16 V

Input impedance: 47 kilohms

### Outputs

#### Line outputs (phono jacks)

Rated output level: 0.5 V at a load impedance of  
47 kilohms

Load impedance: Over 10 kilohms

#### Headphones (stereo phone jack) (TC-WE525/WE425 only)

Output level: 0.25 mW at a load impedance of  
32 ohms

### General

#### Power requirements

Where purchased	Power requirements
U.S.A.	120 V AC, 60 Hz
U.K., China and certain countries in Asia	220 – 230 V AC, 50/60 Hz
Australia	240 V AC, 50/60 Hz

#### Power consumption

18 W

#### Dimensions (approx) (w/h/d)

Model for U.K. and Australia:

430 × 120 × 310 mm (17 × 4 <sup>3</sup>/<sub>4</sub> × 12 <sup>1</sup>/<sub>4</sub> in.)

Model for other countries:

430 × 120 × 290 mm

including projecting parts and controls

#### Mass (approx.)

4 kg (8 lbs 13 oz)

#### Supplied accessories

Audio connecting cords (2 phono plugs - 2 phono plugs) (2)

#### Optional accessory

Remote commander RM-J920

For more information on the availability of the remote commander, contact your nearest Sony dealer.

Design and specifications are subject to change without notice.



## Index

### A, B

- Accessories
  - optional 16
  - supplied 4, 16
- Adjusting
  - recording level automatically. *See* Auto rec level
  - recording level manually 7
  - volume 5
- Audio connecting cord 4, 16
- Auto play 5
- Auto rec level 8

### C

- Cassette. *See* Tape
- CD Synchro-Recording 11
- Cleaning
  - cabinet 13
  - heads and tape path 14
- Connecting. *See* Hooking up

### D, E, F, G

- Difference among the models 3
- Dolby HX PRO system 7
- Dolby NR system 5, 7
- Dubbing
  - high-speed dubbing 9
  - normal-speed dubbing 9, 10
  - only specific portions 10
- Fader 9
- Fading
  - in. *See* Fader
  - out. *See* Fader

### H, I, J, K, L, M, N, O

- Heads
  - cleaning 14
  - demagnetizing 14
- Hooking up
  - hookups 4
  - overview 4
- Insert
  - blank space 10
  - cassette 5, 6
- Locating
  - beginning of the tape 5
- Monaural (2P) mini-plug cord 4, 11

### P, Q, R, S

- Pitch control function 5
- Playing
  - auto play 5
  - basic play 5
- Record muting 10
- Recording
  - basic recording 6
  - CD Synchro-Recording 11
- Remote commander 16
- Specifications 16

### T, U, V, W, X, Y, Z

- Tape
  - ejecting 5, 7
  - notes 13
  - path cleaning 14
  - protect the recording 13
  - type 13
- Troubleshooting 15
- Unpacking 4

## Names of Controls

### Buttons

- ARL (automatic recording level adjustment) 8
- FADER 9
- HIGH/NORMAL 9
- PAUSE ■■ 5, 7 - 10, 15
- PITCH CONTROL 5
- REC ● (recording) 6 - 8
- REC MUTING ○ (record muting) 10
- SYNCHRO 11
- ⊞ (eject) 5 - 7, 14, 15
- (stop) 5, 7 - 11, 15
- ▷ (forward play) 5 - 11, 15
- ◁ (reverse play) 5, 7, 9, 11, 15
- ▶▶, ◀◀ (fast-forwarding and rewinding) 5, 15

### Switches

- DIRECTION MODE 5, 6, 9, 11
- DOLBY NR 5, 7, 10, 15
- I/⏻ (or Ⓜ) (power) 5, 6

### Controls

- PITCH CONTROL 5
- REC (recording) LEVEL 7 - 9

### Jacks

- CONTROL A1 4
- LINE IN 4
- LINE OUT 4
- PHONES 5

### Others

- AUTO indicator 6, 8, 9
- Cassette holder 5, 6, 14
- Peak level meters 7







## Free Manuals Download Website

<http://myh66.com>

<http://usermanuals.us>

<http://www.somanuals.com>

<http://www.4manuals.cc>

<http://www.manual-lib.com>

<http://www.404manual.com>

<http://www.luxmanual.com>

<http://aubethermostatmanual.com>

Golf course search by state

<http://golfingnear.com>

Email search by domain

<http://emailbydomain.com>

Auto manuals search

<http://auto.somanuals.com>

TV manuals search

<http://tv.somanuals.com>