

SONY[®]

User guide

Xperia[™] J
ST26i/ST26a

Contents

Important information.....	6
Android™ – what and why?.....	7
Applications.....	7
Getting started.....	8
Assembly.....	8
Turning the phone on and off	10
Setup guide.....	11
Screen lock.....	11
Accounts and services.....	11
Getting to know your phone.....	13
Phone overview.....	13
Using the keys.....	14
Battery.....	14
Using the touchscreen.....	17
Home screen.....	19
Notification light for social networking services	21
Accessing and using applications.....	22
Status and notifications.....	24
Phone settings menu.....	25
Typing text.....	25
Keyboard and Phonepad settings.....	28
Customising your phone.....	29
Memory.....	32
Using a headset with your phone.....	32
Internet and messaging settings.....	33
Controlling data usage.....	34
Mobile network settings.....	35
Calling.....	37
Emergency calls.....	37
Call handling.....	37
Voicemail.....	39
Multiple calls.....	39
Conference calls.....	39
Call settings.....	40
Contacts	42
Transferring contacts to your new phone.....	42
Contacts screen overview.....	44
Managing your contacts.....	44
Communicating with your contacts.....	46

Sharing your contacts.....	46
Backing up contacts.....	47
Messaging.....	48
Using text and multimedia messaging.....	48
Text and multimedia message options.....	49
Email.....	50
Using email.....	50
Using email accounts.....	52
Gmail™ and other Google™ services	53
Google Talk™	54
Getting started with Google Play™.....	55
Downloading from Google Play™.....	55
Clearing your application data.....	55
Permissions.....	56
Installing applications not from Google Play™	56
PlayNow™ service.....	57
Before you download content.....	57
Downloading from the PlayNow™ service.....	57
Getting organised.....	58
Calendar.....	58
Alarm clock.....	58
Scanning with the NeoReader™ application.....	61
NeoReader™ application menu overview.....	61
Synchronising data on your phone.....	62
Synchronising with Google™.....	62
Synchronising your corporate email, calendar and contacts.....	63
Synchronising with Facebook™.....	63
Synchronising using SyncML™.....	64
Connecting to wireless networks.....	66
Wi-Fi®	66
Virtual private networks (VPNs).....	68
Web browser.....	70
Browsing the web.....	70
Navigating web pages.....	70
Managing bookmarks.....	71
Managing text and images.....	73
Multiple windows.....	73
Downloading from the web.....	74
Browser settings.....	74
Music.....	76
Protecting your hearing.....	76

Copying media files to your memory card	76
Using the music player	76
Identifying music using TrackID technology.....	81
Using TrackID™ technology results.....	81
Using the FM radio.....	83
FM radio overview.....	83
Using your favourite radio channels.....	83
Making a new search for radio channels.....	84
Switching the radio sound between devices.....	84
Identifying radio tracks using TrackID™.....	84
Sharing the details of music you like on Facebook™.....	84
Taking photos and recording videos.....	86
Camera controls overview.....	86
Using the still camera.....	86
Using the video camera.....	91
Viewing photos and videos in Album.....	95
Album tab overview.....	95
Viewing photos and videos saved in the phone	95
Viewing your photos on a map.....	98
Viewing your online albums.....	100
Playing video clips in Movies.....	101
Sharing content with DLNA Certified™ devices.....	102
Playing files from DLNA Certified™ devices on your phone.....	102
Preparing to play phone content on DLNA Certified™ devices....	102
Playing phone content on other DLNA Certified™ devices.....	103
Bluetooth™ wireless technology.....	104
Naming your phone.....	104
Pairing with another Bluetooth™ device.....	104
Sending and receiving items using Bluetooth™ technology.....	105
Connecting your phone to a computer.....	107
Transferring and handling content using a USB cable.....	107
Transferring files using Media transfer mode via Wi-Fi®.....	107
PC Companion.....	108
Media Go™	108
Using location services to find your position.....	110
Using GPS.....	110
Google Maps™.....	111
Using Google Maps™ to get directions.....	111
Locking and protecting your phone.....	112
IMEI number.....	112
SIM card protection.....	112

Setting a screen lock.....	113
Updating your phone.....	116
Updating your phone wirelessly.....	116
Updating your phone using a USB cable connection.....	116
Phone settings overview.....	118
Status and notification icons overview.....	120
Status icons.....	120
Notification icons.....	120
Application overview.....	122
User support.....	124
Troubleshooting.....	125
My phone is not working as expected.....	125
Resetting the phone.....	125
I cannot charge the phone.....	125
No battery charging icon appears when phone starts charging....	125
The battery performance is low.....	125
My wired headset does not work.....	126
I cannot transfer content between my phone and the computer, when using a USB cable.....	126
I cannot use Internet-based services.....	126
Error messages.....	126
Recycling your phone.....	127
Legal information.....	128
Index.....	129

Important information

Please read the *Important information* leaflet before you use your mobile phone.

- ! Some of the services and features described in this User guide are not supported in all countries/regions or by all networks and/or service providers in all areas. Without limitation, this applies to the GSM International Emergency Number 112. Please contact your network operator or service provider to determine availability of any specific service or feature and whether additional access or usage fees apply.

Android™ – what and why?

Your Xperia smartphone from Sony runs on the Android platform. Android phones can perform many of the same functions as a computer and you can customise them to your own needs. For example, you can add and delete applications, or enhance existing applications to improve functionality. On Google Play™ you can download a range of applications and games from a constantly growing collection. You can also integrate applications on your Android™ phone with other applications and with online services that you use. For example, you can back up your phone contacts, access your different email accounts and calendars from one place, keep track of your appointments, and engage in social networking.

Android™ phones are constantly evolving. When a new software version is available and your phone supports this new software, you can update your phone to get new features and the latest improvements.

💡 Your Android™ phone is pre-loaded with Google™ services. To get the most out of the provided Google™ services, you should have a Google™ account and sign in to it when you first start your phone. You also need to have Internet access to use many of the features in Android™.

! New software releases may not be compatible with all phones.

Applications

An application is a phone program that helps you perform a task. For example, there are applications to make calls, take photos and download more applications.

Getting started

Assembly

To remove the battery cover

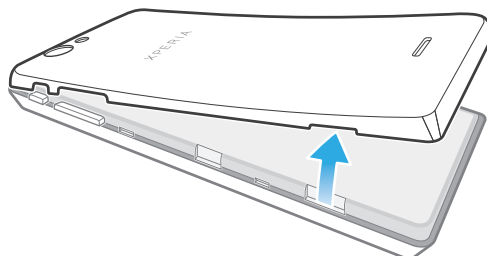

- Insert the tip of your finger firmly into the opening on the side of the phone, between the phone and the battery cover. Then lift up the cover slowly but firmly.
- ! Do not use sharp objects that may damage parts of the phone.

To remove the battery

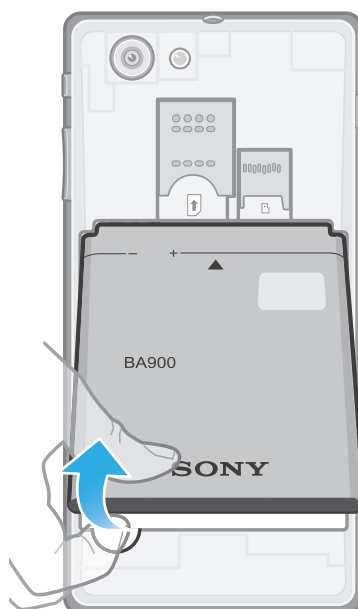

- 1 Remove the battery cover.
- 2 Place the tip of your finger into the opening on the bottom side of the battery and lift up the battery.

To insert the memory card and the SIM card

- ! Do not insert an incompatible SIM card, for example, a micro SIM card, into the SIM card slot. Doing so could permanently damage your SIM card or your phone.

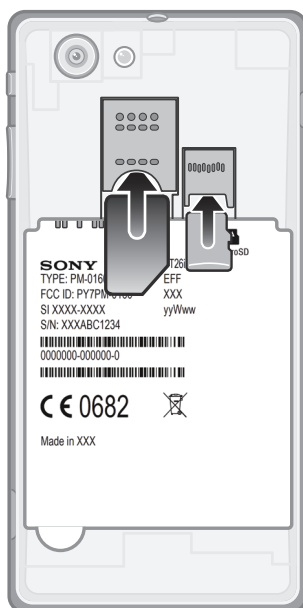

- 1 Turn off your phone.
 - 2 Remove the battery cover, then insert the memory card and the SIM card into the relevant slots.
- ! A memory card may not be included at purchase in all markets.

To remove the SIM card

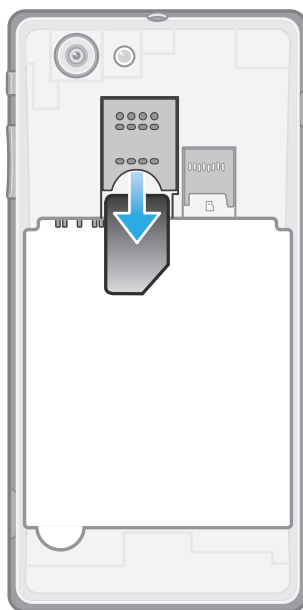

- 1 Turn off your phone.
- 2 Remove the battery cover.
- 3 Place the tip of your finger on the SIM card and slide it out of its slot.

To remove the memory card

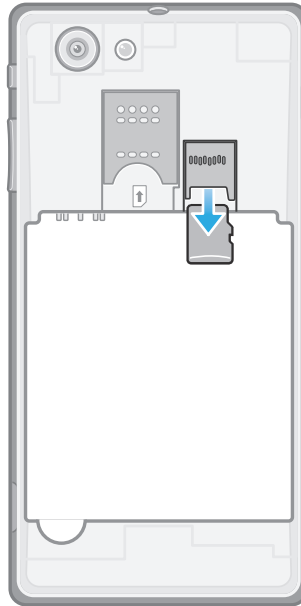

- 1 Turn off your phone, or unmount the memory card from **Settings > Storage > Unmount SD card**.
- 2 Remove the battery cover, then draw the memory card outwards to remove it.

To attach the battery cover

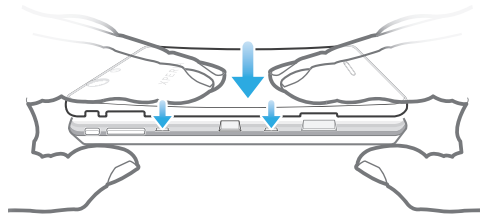





- 1 Place the cover over the back of the phone so that the camera lens hole in the cover fits over the camera lens.
- 2 Press down firmly on all edges of the battery cover to make sure it gets attached tightly.

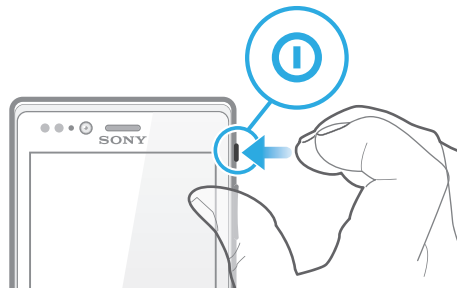

Turning the phone on and off

To turn on the phone



- 1 Press and hold down the power key  on the right side of the phone until the phone vibrates.
 - 2 If your screen goes dark, briefly press the power key  to activate the screen.
 - 3 To unlock the screen, drag  to the right across the screen.
 - 4 Enter your SIM card PIN when requested, and select **OK**.
 - 5 Wait a while for the phone to start.
-  Your SIM card PIN is initially supplied by your network operator, but you can change it later from the **Settings** menu. To correct a mistake made while entering your SIM card PIN, tap .

To turn off the phone

- 1 Press and hold down the power key  until the options menu opens.
 - 2 In the options menu, tap **Power off**.
 - 3 Tap **OK**.
-  It may take a while for the phone to shut down.

Setup guide

The first time you start your phone, a setup guide opens to explain basic phone functions and help you enter essential settings. This is a good time to configure the phone to your specific needs. You can also access the setup guide later from the Application screen.

To access the setup guide manually

- 1 From the Home screen, tap .
- 2 Find and tap **Setup guide**.

Screen lock

When your phone is on and left idle for a set period of time, the screen darkens to save battery power, and locks automatically. This lock prevents unwanted actions on the touch screen when you are not using it.

To activate the screen

- Briefly press the power key .

To unlock the screen



- Drag  to the right across the screen.

To lock the screen manually

- When the screen is active, briefly press the power key .

Accounts and services

Sign in to your online service accounts from your phone and benefit from a range of services. Combine services and get even more out of them. For example, collect contacts from your Google™ and Facebook™ accounts and integrate them into your phonebook, so you have everything in one place.

You can sign up to online services from your phone as well as from a computer. When you sign up for the first time, an account is created with your user name, password, settings and personal information. The next time you sign in, you get a personalised view.

Google™ account

Having a Google™ account is key to using a range of applications and services with your Android phone. You need a Google™ account, for example, to use the Gmail™ application in your phone, to chat with friends using Google Talk™, to synchronise your phone calendar with your Google Calendar™, and to download applications and games, music, movies and books from Google Play™.

Microsoft® Exchange ActiveSync® account

Synchronise your phone with your corporate Microsoft® Exchange ActiveSync® account. This way, you keep your work email, contacts and calendar events with you at all times.

Facebook™ account

Facebook™ connects you with friends, family and colleagues all over the world. Log in now to share your world with others.

SyncML™ account

Synchronise your phone with an Internet server using SyncML™. View and manage contacts, calendar events and bookmarks from your phone just as easily as you would from a computer.

Getting to know your phone

Phone overview

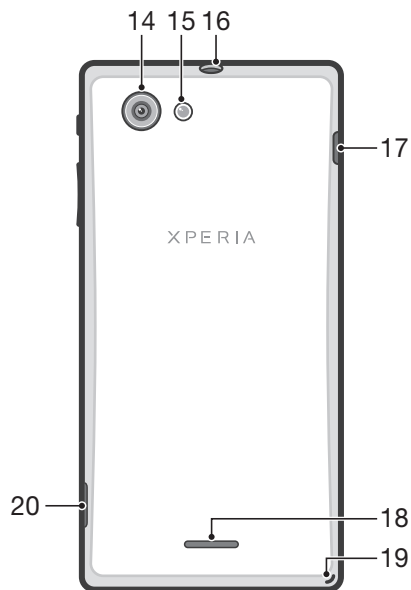
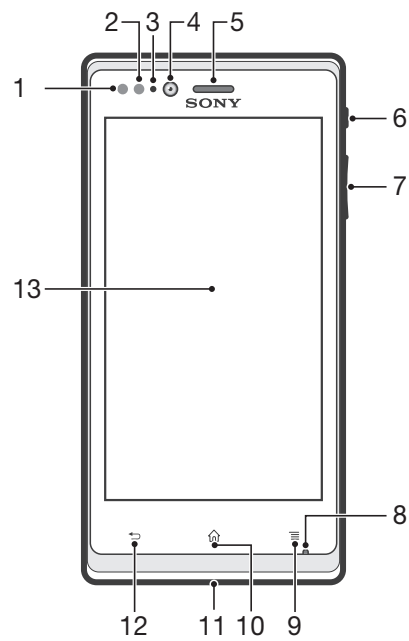

- | | |
|---------------------------|---|
| 1. Proximity sensor 1 | 11. Notification light for social networking services |
| 2. Proximity sensor 2 | 12. Back key |
| 3. Notification LED light | 13. Touchscreen |
| 4. Front camera lens | 14. Camera lens |
| 5. Ear speaker | 15. Camera LED light |
| 6. Power key | 16. Headset connector |
| 7. Volume/Zoom key | 17. Connector for charger/USB cable |
| 8. Microphone | 18. Speaker |
| 9. Menu key | 19. Strap hole |
| 10. Home key | 20. Battery cover opening |

Using the keys

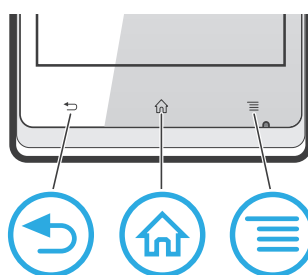

Back

- Go back to the previous screen
- Close the on-screen keypad, a dialog box, an options menu, or the Notification panel



Home

- Go to the Home screen
- Press and hold to open a window showing your most recently used applications



Menu

- Open a list of options available in the current screen or application

Battery

Charging the battery

Your phone battery is partly charged when you buy the phone. When you connect the phone charger cable to a power source, such as a USB port or a phone charger, it may take a few minutes before the battery icon  appears on the screen. You can still use your phone while it is charging. Charging the phone over a long period of time, for example, overnight, does not damage the battery or the phone.



The battery will start to discharge a little after it is fully charged and then charges again after a certain time when the phone charger is connected. This is to extend battery life and may result in the charge status showing a level below 100 percent.

To charge the phone

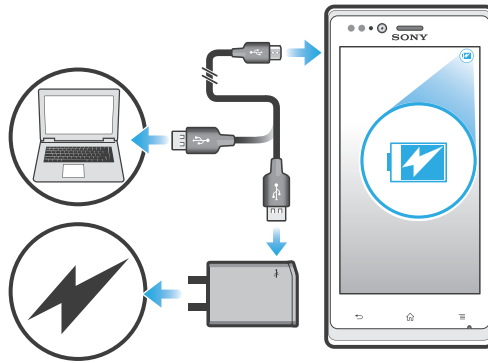

- 1 Plug the phone charger into a power outlet.
- 2 Plug one end of the USB cable into the charger (or into the USB port of a computer).
- 3 Plug the other end of the cable into the micro USB port on your phone, with the USB symbol facing up. The battery status LED lights up when charging starts. If the battery is completely discharged, it may take a few minutes before the LED lights up after you connect the phone charger cable to a power source.

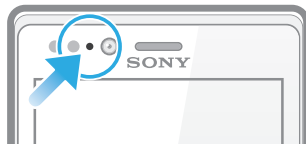

- 4 When the battery status LED is green, the phone is fully charged. Disconnect the USB cable from your phone by pulling it straight outwards. Make sure not to bend the connector when removing the cable from the phone.

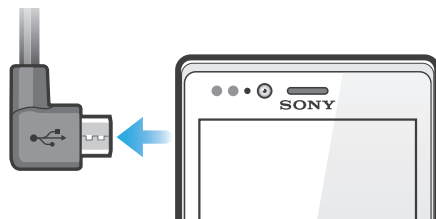

Battery LED status

Green	The battery is fully charged
Red	The battery level is low
Orange	The battery is charging. The battery level is between low and full

To check the battery level

- 1 From your Home screen, tap .
- 2 Find and tap **Settings** > **About phone** > **Status** > **Battery level**.

Improving battery performance

The following tips can help you improve battery performance:



- Charge your phone often. This will not affect the lifetime of the battery.
- Downloading data from the Internet is power consuming. When you're not using the Internet, you can save power by disabling all data connections over mobile networks. This setting does not prevent your phone from transmitting data over other wireless networks.
- Turn off GPS, Bluetooth™ and Wi-Fi® when you don't need these features. You can turn them on and off more easily by adding the Quick settings widget to your Home screen. You do not need to turn off 3G.

- Use the **Power Saver** feature to reduce battery consumption. You can select the power saving mode that best suits the way you use your phone. You can also customise the settings of each power saving mode.
- Set your synchronisation applications (used to synchronise your email, calendar and contacts) to synchronise manually. You can also synchronise automatically, but increase the synchronisation intervals.
- Check the battery usage menu in the phone to see which applications use the most power. Your battery consumes more power when you use video and music streaming applications, such as YouTube™. Some applications downloaded from Google Play™ may also consume more power.
- Close and exit applications that you are not using.
- Lower the screen display brightness level.
- Turn off your phone or activate the **Airplane mode** setting if you are in an area with no network coverage. Otherwise, your phone repeatedly scans for available networks, and this consumes power.
- Use a Sony original handsfree device to listen to music. Handsfree devices demand less battery power than the phone's loudspeakers.
- Keep your phone in standby whenever possible. Standby time refers to the time during which the phone is connected to the network and is not being used.
- Disable any live wallpaper.
- Go to www.sonymobile.com to get the latest battery performance tips for your phone model.

To access the battery usage menu

- 1 From your Home screen, tap .
- 2 Find and tap **Settings** > **Battery** to see which installed applications consume the most battery power.

To add the Data traffic widget to your Home screen

- 1 From your Home screen, press .
- 2 Tap .
- 3 Tap **Widgets** > **Tools** > **Data traffic**.

To add the Quick settings widget to your Home screen

- 1 From your Home screen, press .
- 2 Tap **Add** > **Widgets** > **Tools**.
- 3 Select the **Quick settings** widget.

Reducing battery consumption with Power Saver

Use pre-set power saving modes to manage power consuming applications and reduce battery consumption. With Power Saver, you can also customise the settings within each power saving mode to the way you use your phone.

To activate a power saving mode

- 1 From your Home screen, tap .
- 2 Find and tap **Power Saver**.
- 3 Tap the icon next to the power saving mode that you want to activate.



To deactivate a power saving mode

- 1 From your Home screen, tap .
- 2 Find and tap **Power Saver**.
- 3 Tap the illuminated icon next to the active power saving mode to turn it off.

To change the settings for a power saving mode

- 1 From your Home screen, tap .
- 2 Find and tap **Power Saver**.
- 3 To open the settings menu, tap the name of a power saving mode.
- 4 Mark the features that you want to turn off to save power.
- 5 Tap **Done**.

To display power saver notifications

- 1 From your Home screen, tap .
- 2 Find and tap **Power Saver**.
- 3 Tap .
- 4 Mark the **Status bar** checkbox.

Using the touchscreen

A protective plastic sheet is attached to the screen of your phone when you buy it. You should peel off this sheet before using the touchscreen. Otherwise, the touchscreen might not function properly.

When your phone is on and left idle for a set period of time, the screen darkens to save battery power, and locks automatically. This lock prevents unwanted actions on the touchscreen when you are not using it. You can also set personal locks to protect your subscription and make sure only you can access your phone content.

- ! Your phone screen is made from glass. Do not touch the screen if the glass is cracked or shattered. Avoid trying to repair a damaged screen yourself. Glass screens are sensitive to drops and mechanical shocks. Cases of negligent care are not covered by the Sony warranty service.

To open or highlight an item

- Tap the item.

To mark or unmark options

- Tap the relevant checkbox or list option.



Marked checkbox



Unmarked checkbox



Marked list option





Unmarked list option

Zooming

The zoom options available depend on the application you are using.

To zoom

- When available, tap  or  to zoom in or out.
- ! You may have to drag the screen (in any direction) to make the zoom icons appear.

To zoom with two fingers

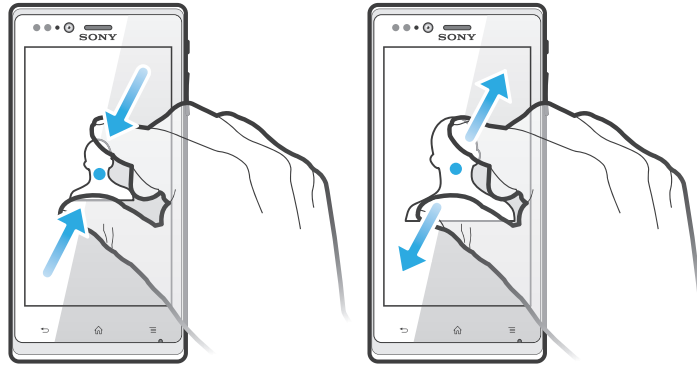

- Place two fingers on the screen at once and pinch them together (to zoom out) or spread them apart (to zoom in).

💡 Use the zoom function when viewing photos and maps, or when browsing the web.

Scrolling

Scroll by moving your finger up or down on the screen. On some web pages you can also scroll to the sides.

- ! Dragging or flicking will not activate anything on the screen.

To scroll

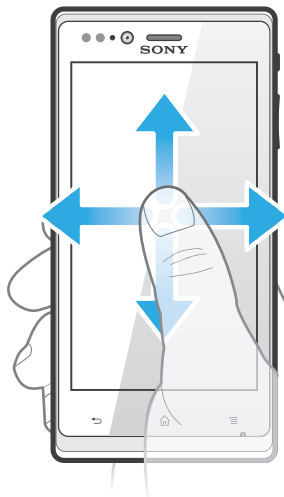

- Drag or flick your finger in the direction you want to scroll on the screen.
- 💡 To scroll more quickly, flick your finger in the direction you want to go on the screen.

To flick

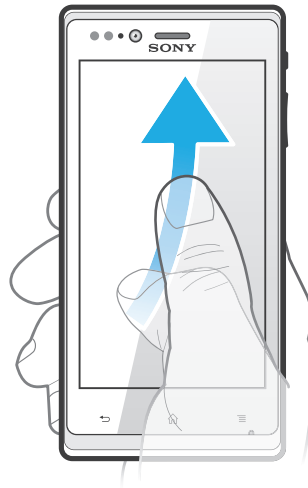

- To scroll more quickly, flick your finger in the direction you want to go on the screen. You can wait for the scrolling movement to stop by itself, or you can stop it immediately by tapping the screen.

Sensors

Your phone has sensors that detect both light and proximity. The light sensor detects the ambient light level and adjusts the brightness of the screen accordingly. The proximity sensor turns the touch screen off when your face touches the screen. This prevents you from unintentionally activating phone functions when you are engaged in a call.

Home screen

Your phone Home screen is the equivalent of the desktop on a computer. It's your gateway to the main features in your phone. You can customise your Home screen with widgets, shortcuts, folders, themes, wallpaper and other items.

The Home screen extends beyond the regular screen display width, so you need to flick left or right to view content in one of the screen's four extensions.  shows which part of the Home screen you are in.

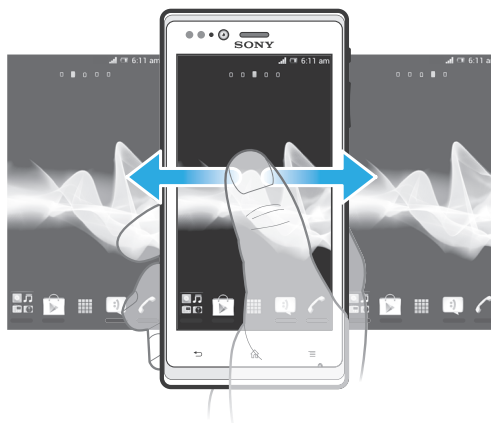

The items in the bar at the bottom of the screen are always available for quick access.



To go to the Home screen

- Press .

To browse the Home screen

- Flick right or left.

To share an item from your Home screen

- 1 Press  to open your Home screen.
- 2 Touch and hold an item until it magnifies and the phone vibrates, then drag the item to .
- 3 Select an option and confirm, if necessary. You can now share the applications and widgets you like with your friends so they can download and use them.

Widgets

Widgets are small applications that you can use directly on your Home screen. For example, the Music player widget allows you to start playing music directly.

Some widgets are resizable, so you can expand them to view more content or shrink them to save space on your Home screen.

To add a widget to the Home screen

- 1 From your Home screen, press .
- 2 Tap **Add > Widgets**.
- 3 Tap a widget.

To resize a widget

- 1 Touch and hold a widget until it magnifies and the phone vibrates, then release the widget. If the widget can be resized, a highlighted frame and resizing dots appear.
- 2 Drag the dots inward or outward to shrink or expand the widget.
- 3 To confirm the new size of the widget, tap anywhere on the Home screen.

To get an overview of all widgets on your Home screen

- Pinch on any area of your Home screen. All widgets from different parts of your Home screen are now displayed in one view.
-  When all Home screen widgets are combined in one view, tap on any widget to go to the part of the Home screen containing that widget.

Timescape™ Feed widget

The Timescape™ Feed widget shows all your most recent Timescape™ events in one view. You can flick up or down within the widget to view the full content of every event. You can also tap an event to view its content in fullscreen format or react to it using comments, likes and retweets.

Timescape™ Friends widget

The Timescape™ Friends widget notifies you of the latest social networking activities related to you and your friends. You can view all activities and communicate with your friends using comments, likes and retweets.

Timescape™ Share widget

Share your status through one of the services that you have logged into from your phone. For example, you can post updates on Facebook™ or Twitter™.

Rearranging your Home screen



Customise the appearance of your Home screen and change the features that you can access from it. Change the screen background, move items around, create folders, and add shortcuts to contacts.

To open the options menu of your Home screen

You can open the Home screen options menu in two ways:

- From your Home screen, press .
- Touch and hold on any part of your Home screen.

To add a shortcut to the Home screen

- 1 From your Home screen, press .
 - 2 Tap **Add > Shortcuts**.
 - 3 Find and select a shortcut.
-  Add an application shortcut directly from the Application screen by touching and holding the application.



To move an item on the Home screen

- 1 Press  to open your Home screen.
- 2 Touch and hold an item until it magnifies and the phone vibrates, then drag the item to the new location.

To delete an item from the Home screen

- Touch and hold an item until it magnifies and the phone vibrates, then drag the item to .

To add a folder to the Home screen

- 1 From your Home screen, press .
 - 2 Tap **Add > Folder**.
 - 3 Enter a name for the folder and tap **Done**.
-  Drag and drop an item on top of another item on your Home screen to create a folder automatically.

To add items to a folder

- Touch and hold an item until it magnifies and the phone vibrates, then drag the item to the folder.



To rename a folder

- 1 Tap the folder to open it.
- 2 Touch the folder's title bar to show the **Folder name** field.
- 3 Enter the new folder name and tap **Done**.



Changing the background of your Home screen

Adapt the Home screen to your own style using wallpapers and different themes.

To change your Home screen wallpaper

- 1 From your Home screen, press .
 - 2 Tap **Wallpaper**, then select an option.
-  You can use a photo you have taken, or an animation. Go to Google Play™ and other sources to download, for example, live wallpapers that change with the changing hours of the day.

To set a theme



- 1 From your Home screen, press .
 - 2 Tap **Theme**, then select a theme.
-  When you change a theme, the background also changes in some applications.

Notification light for social networking services



The notification light for SNS (Social Networking Services) on your phone becomes blue and flashes when you receive notifications from preloaded SNS applications, for example, Facebook™ and Twitter™.

The notification light also illuminates when you activate your screen. It then fades out after a few seconds to save power. Its colour varies depending on the theme you are using. The notification light for social networking services, however, stays blue even if you select a different theme colour.

To turn on the notification light for incoming Facebook™ notifications

- 1 From your Home screen, tap .
- 2 Tap Facebook™. Log in to Facebook™, if required.
- 3 Tap  > Settings.
- 4 Mark the Phone LED checkbox.

To turn on the notification light for incoming Twitter™ notifications

- 1 From your Home screen, tap .
- 2 Tap Twitter™. Log in to Twitter™, if required.
- 3 Tap  > Settings.
- 4 Tap your account.
- 5 Mark the Notification light checkbox.

Accessing and using applications

Open applications from shortcuts on your Home screen or from the Application screen.

Application screen

The Application screen, which you open from your Home screen, contains the applications that come installed with your phone as well as the applications you download.

The Application screen extends beyond the regular screen width, so you need to flick left and right to view all content.

To open the Application screen

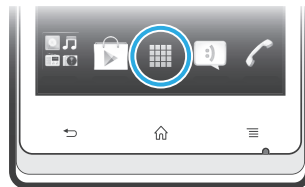

- From your Home screen, tap .



To browse the Application screen

- Open the Application screen, then flick right or left.

To create a shortcut to an application on the Home screen

- 1 From your Home screen, tap .
- 2 Touch and hold an application until it appears on your Home screen, then drag it to the desired location.

To share an application from your Application screen



- 1 From your Home screen, tap .
- 2 Touch and hold an application until it appears on your Home screen, then drag the item to .
- 3 Select an option and confirm, if necessary. You can now share the applications you like with your friends so they can download and use them.

Opening and closing applications

To open an application

- From your Home screen or the Application screen, tap the application.

To close an application

- Press .
- 💡 Some applications are paused when you press  to exit, while other applications may continue to run in the background. In the first case, the next time you open the application, you can continue where you left off.

Recently used applications window

You can view and access recently used applications from this window.

To open the recently used applications window

- Press and hold down .

Application menu

You can open a menu at any time when you are using an application by pressing the  key on your phone. The menu will look different depending on which application you are using.

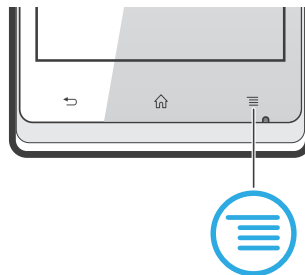



To open a menu in an application

- While using the application, press .
- ! A menu is not available in all applications.



Rearranging your Application screen

Move the applications around on the Application screen according to your preferences.



To arrange applications on the Application screen

- 1 From your Home screen, tap  to go to the Application screen.
- 2 Tap  and select an option.

To move an application on the Application screen

- 1 Open the Application screen, then tap .
 - 2 Touch and hold an item until it magnifies and the phone vibrates, then drag the item to the new location.
 - 3 Tap  to exit edit mode.
- ! You can only move your applications when  is selected.

To uninstall an application from the Application screen

- 1 From your Home screen, tap .
- 2 Tap . All uninstalleable applications are marked with a  icon.
- 3 Tap the application you want to uninstall, then tap **OK**.

Status and notifications

The status bar at the top of your screen shows what's going on in your phone. To the left you get notifications when there is something new or ongoing. For example, new message and calendar notifications appear here. The right side shows the signal strength, battery status, and other information.

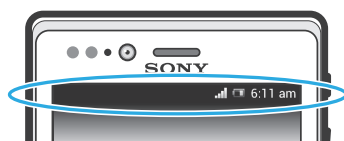

A notification light also gives you battery status information and some notifications. For example, a flashing blue light means there is a new message or a missed call. The notification light may not work when the battery level is low.

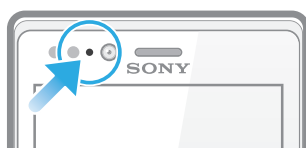

Checking notifications and ongoing activities

You can drag down the status bar to open the Notification panel and get more information. For example, you can use the panel to open a new message or view a calendar event. You can also open some applications that run in the background, such as the music player.

To open the Notification panel

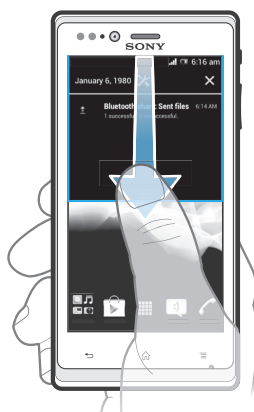

- Drag the status bar downwards.

To close the Notification panel

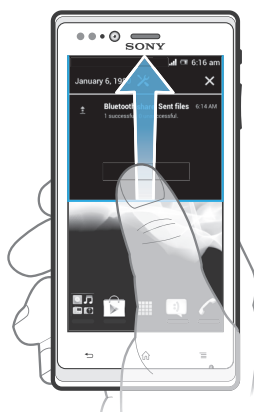

- Drag the tab at the bottom of the Notification panel upwards.

To open a running application from the Notification panel

- Tap the icon for the running application to open it.

To open the phone settings menu from the Notification panel

- Tap ✕.

To dismiss a notification from the Notification panel

- Place your finger on a notification and flick left or right.

To clear all notifications from the Notification panel

- Tap ✕.

Phone settings menu

View and change your phone settings from the Settings menu.

To access the phone settings

- 1 From your Home screen, tap .
- 2 Tap **Settings**.

- 💡 You can also drag the status bar downwards on the Home screen and tap  to access the phone settings.

Typing text

On-screen keyboard

Tap the keys of the on-screen QWERTY keyboard to enter text conveniently. Some applications open the on-screen keyboard automatically. You can also open this keyboard by touching a text field.

Using the on-screen keyboard

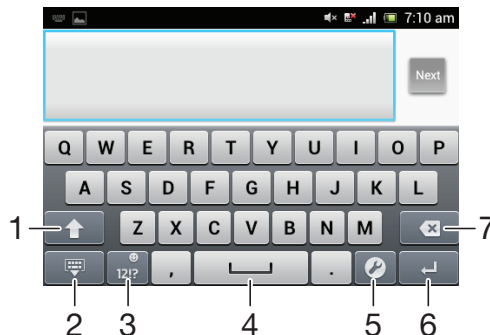

- 1 Change the character case and turn on the caps lock. For some languages, this key is used to access extra characters in the language.
- 2 Close the on-screen keyboard view.
- 3 Display numbers and symbols. Touch and hold to display smileys.
- 4 Enter a space.
- 5 Open the input settings menu to make a change, for example, under **Writing languages**. This key also changes the writing language when more than one input language is selected.
- 6 Enter a carriage return or confirm text input.

7 Delete a character before the cursor.

- ! All illustrations are for illustration purposes only and may not accurately depict the actual phone.

To display the on-screen keyboard to enter text

- Tap a text entry field.

To hide the on-screen keyboard

- When the on-screen keyboard is open, press .

To use the on-screen keyboard in landscape orientation



- When you enter text, turn the phone sideways.

- 💡 For the keyboard to support this feature, landscape mode must be supported by the application you are using, and your screen orientation settings must be set to automatic.



To enter text using the on-screen keyboard

- 1 To enter a character visible on the keyboard, tap the character.
- 2 To enter a character variant, touch and hold a regular keyboard character to get a list of available options, then select from the list. For example, to enter "é", touch and hold "e" until other options appear, then, while keeping your finger pressed on the keyboard, drag to and select "é".



To shift between upper-case and lower-case letters

- Before you enter a letter, tap  to switch to upper-case , or vice versa.

To turn on the caps lock

- Before you type a word, tap  or  until  appears.

To enter numbers or symbols

- When you enter text, tap . A keyboard with numbers and symbols appears. Tap  to view more options.

To insert a smiley

- 1 When you enter text, touch and hold .
- 2 Select a smiley.

To delete characters

- Tap to place the cursor after the character you want to delete, then tap .

To enter a carriage return

- When you enter text, tap .

To select text

- 1 When you enter text, touch and hold the text field or double-tap within the text field.
- 2 The word you touch gets highlighted by tabs on both sides. Drag the tabs left or right to select more text.

To edit text in portrait orientation

- 1 When you enter text, touch and hold the text field until an application bar appears.
- 2 Select the text you want to edit, and then use the application bar to make your desired changes.

- ! To paste text from the clipboard, you can also hold the text field until **Paste** appears, then tap **Paste**.

Application bar

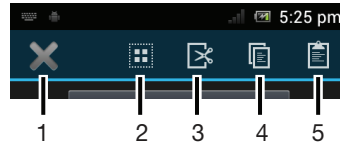

- 1 Close the application bar
- 2 Select all text
- 3 Cut text
- 4 Copy text
- 5 Paste text

!  only appears when you have text stored on the clipboard.

To edit text in landscape orientation

- 1 When you enter text, touch and hold the text field until **Edit...** appears.
 - 2 Select the text you want to work with, then tap **Edit...** and select an option.
- ! To paste text from the clipboard, you can also hold the text field until **Paste** appears, then tap **Paste**.

Phonepad

The Phonepad is similar to a standard 12-key telephone keypad. It gives you predictive text and multi-tap input options. You can activate the Phonepad text input method via the keyboard settings. The Phonepad is only available in portrait orientation.

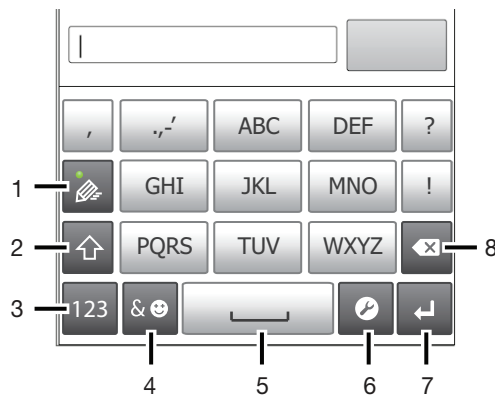

Using the Phonepad





- 1 Choose a text input option
- 2 Change the character case and turn on the caps lock
- 3 Display numbers
- 4 Display symbols and smileys
- 5 Enter a space
- 6 Open the input settings menu to change, for example, the **Writing languages**. This key also changes the writing language when more than one input language is selected.
- 7 Enter a carriage return or confirm text input

- ! All illustrations are for illustration purposes only and may not accurately depict the actual phone.



To open the Phonepad for the first time

- Tap a text entry field, then tap  or touch and hold  if you have already selected more than one input language. Tap **Portrait keyboard** and select an option.
- 💡 Once you've made the setting, you can simply activate the Phonepad by tapping a text entry field.

To switch between the on-screen keyboard and the Phonepad

- 1 When you enter text, tap , or touch and hold  if you have already selected more than one input language.
 - 2 Tap **Portrait keyboard** and select an option.
- ! Remember the Phonepad is only available in portrait orientation.

To enter text using the Phonepad

- When  appears in the Phonepad, tap each character key only once, even if the letter you want is not the first letter on the key. Tap the word that appears or tap  to view more word suggestions and select a word from the list.
- When  appears in the Phonepad, tap the on-screen key for the character you want to enter. Keep pressing this key until the desired character is selected. Then do the same for the next character you want to enter, and so on.

To enter numbers using the Phonepad

- When the Phonepad is open, tap . A Phonepad with numbers appears.



To insert symbols and smileys using the Phonepad

- 1 When the Phonepad is open, tap . A grid with symbols and smileys appears.
- 2 Scroll up or down to view more options. Tap a symbol or smiley to select it.



Keyboard and Phonepad settings

You can select settings for the on-screen keyboard and the Phonepad, such as writing language and automatic correction.

To access the keyboard and the Phonepad settings

- When you enter text using the on-screen keyboard or Phonepad, tap . If you have selected more than one writing language, touch and hold  instead.

To change writing language using the on-screen keyboard or the Phonepad

- 1 When you enter text, tap , or touch and hold  if you have already selected more than one input language.
- 2 Tap **Writing languages** and select the languages you want to use for writing.
- 3 If you have selected more than one input language, tap  to switch between the selected writing languages.



To switch keyboards

- 1 When you enter text, drag the status bar downwards to open the Notification panel.
- 2 Tap **Select input method**, and select an option.

Text input settings

When entering text using the on-screen keyboard or the Phonepad, you can access a text input settings menu that helps you set options for text prediction. For example, you can decide how you want the phone to present word alternatives and correct words as you type, or enable the text input application to remember new words you write.

To change the text input settings

- 1 When you enter text using the on-screen keyboard or the Phonepad, tap , or touch and hold .
- 2 Tap **Text input settings**.
- 3 Select the desired settings.

Customising your phone

Adapt the phone to your needs by adjusting, for example, your personal ringtone, phone language and your Privacy settings.

Adjusting the volume

You can adjust the ringtone volume for phone calls and notifications as well as for music and video playback.

To adjust the ring volume with the volume key

- Press the volume key up or down.

To adjust the media playing volume with the volume key

- When playing music or watching video, press the volume key up or down.

Adjusting the sound settings



You can adjust the sound settings in your phone. For example, you can set your phone to silent mode so that it doesn't ring when you're in a meeting.

To set the phone to silent mode

- 1 From your Home screen, tap .
- 2 Find and tap **Settings** > **Sound**.
- 3 Select **Silent mode**, then select **Mute**.

To set the phone to vibrate mode

- 1 From your Home screen, tap .
- 2 Find and tap **Settings** > **Sound**.
- 3 Select **Silent mode**, then select **Vibrate**.

- 💡 You can also tap  from the **Phone options** menu to set the phone to vibrate mode. To access the **Phone options** menu, press and hold down the power key .

To set the phone to vibrate and ring mode

- 1 From your Home screen, tap .
- 2 Find and tap **Settings** > **Sound**.
- 3 Select **Silent mode**, then select **Off**.
- 4 Mark the **Vibrate on ring** checkbox.

To enhance the speaker loudness

- 1 From your Home screen, tap .
- 2 Find and tap **Settings** > **Sound**.
- 3 Mark the **xLOUD™** checkbox.

Time and date

You can change the time and date in your phone.

To set the date manually

- 1 From the Home screen, tap .
- 2 Find and tap **Settings > Date & time**.
- 3 Unmark the **Automatic date & time** checkbox, if it is marked.
- 4 Tap **Set date**.
- 5 Adjust the date by scrolling up and down.
- 6 Tap **Set**.

To set the time manually

- 1 From your Home screen, tap .
- 2 Find and tap **Settings > Date & time**.
- 3 Unmark the **Automatic date & time** checkbox if it is marked.
- 4 Tap **Set time**.
- 5 Scroll up or down to adjust the hour and minute.
- 6 If applicable, scroll up to change **AM** to **PM**, or vice versa.
- 7 Tap **Set**.

To set the time zone

- 1 From the Home screen, tap .
- 2 Find and tap **Settings > Date & time**.
- 3 Unmark the **Automatic date & time** checkbox, if it is marked.
- 4 Tap **Select time zone**.
- 5 Select an option.

To set the date format

- 1 From your Home screen, tap .
- 2 Find and tap **Settings > Date & time > Select date format**.
- 3 Select an option.

Ringtone settings

To set a phone ringtone

- 1 From your Home screen, tap .
- 2 Find and tap **Settings > Sound > Phone ringtone**.
- 3 Select a ringtone.
- 4 Tap **Done**.

To enable touch tones

- 1 From your Home screen, tap .
- 2 Find and tap **Settings > Sound**.
- 3 Mark the **Dial pad touch tones** and **Touch sounds** checkboxes.

To select a notification ringtone

- 1 From your Home screen, tap .
- 2 Find and tap **Settings > Sound > Default notification**.
- 3 Select a ringtone.
- 4 Tap **Done**.

Screen settings

To adjust the screen brightness

- 1 From your Home screen, tap .
- 2 Find and tap **Settings > Display > Brightness**.
- 3 Drag the slider to adjust the brightness.
- 4 Tap **OK**.



 The brightness level affects your battery performance. For tips on how to improve battery performance, see *Improving battery performance* on page 15.

To set the screen to vibrate

- 1 From your Home screen, tap .
- 2 Find and tap **Settings > Sound**.
- 3 Mark the **Vibrate on touch** checkbox. The screen now vibrates when you tap soft keys and certain applications.

To adjust the idle time before the screen turns off

- 1 From your Home screen, tap .
- 2 Find and tap **Settings > Display > Sleep**.
- 3 Select an option.

 To turn off the screen quickly, briefly press the power key .

To keep the screen active while the phone is charging



- 1 From the Home screen, tap .
- 2 Find and tap **Settings > Developer options**.
- 3 Mark the **Stay awake** checkbox.

Phone language

You can select a language to use in your phone.

To change the phone language

- 1 From your Home screen, tap .
- 2 Find and tap **Settings > Language & input > Language**.
- 3 Select an option.

 If you select the wrong language and cannot read the menu texts, find and tap the **Settings** icon . Then select the entry beside , and select the first entry in the following menu. You can then select the language you want.



Airplane mode

In Airplane mode, your phone's network and radio transceivers are turned off to prevent disturbance to sensitive equipment. However, you can still play games, listen to music, watch videos and other content, as long as all this content is saved on your memory card or internal storage. You can also be notified by alarms, if alarms are activated.

 Turning on Airplane mode reduces battery consumption.

To turn on Airplane mode

- 1 From your Home screen, tap .
- 2 Find and tap **Settings > More....**
- 3 Mark the **Airplane mode** checkbox.

 You can also select **Airplane mode** from the **Phone options** menu. To access the **Phone options** menu, press and hold down the power key .

Memory

You can save content to a memory card, to your phone's internal storage and to the phone memory. Music, video clips and photos are saved to the internal storage or the memory card while applications, contacts and messages are saved to the phone memory.

- ! You can move some applications from the phone memory to the internal storage.

To move an application to the phone's internal storage

- 1 From your Home screen, tap .
- 2 Find and tap **Settings** > **Apps**.
- 3 Select the application that you want to move to the internal storage.
- 4 Tap **Move to internal storage**.

- 💡 It is not possible to move some applications from the phone memory to the internal storage.

Memory card

- ! You may have to purchase a memory card separately.

Your phone supports a microSD™ memory card, which is used for media content. This type of card can also be used as a portable memory card with other compatible devices.

Formatting the memory card

You can format the memory card in your phone, for example, to free up memory. This means that you erase all data on the card.

- ! All content on the memory card gets erased when you format it. Make sure you make backups of everything you want to save before formatting the memory card. To back up your content, you can copy it to your computer. For more information, refer to the chapter *Connecting your phone to a computer* on page 107.

To format the memory card

- 1 From your Home screen, tap .
- 2 Find and tap **Settings** > **Storage** > **Unmount SD card**.
- 3 After you have unmounted the memory card, tap **Erase SD card**.

Using a headset with your phone

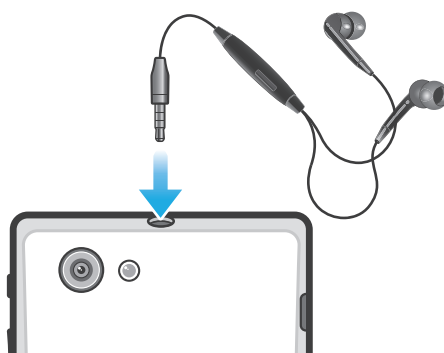

- ! Use the accessories provided with your phone, or other compatible accessories, for optimal performance.

To use a headset

- 1 Connect the headset to your phone.
- 2 To answer a call, press the call handling key.
- 3 To end the call, press the call handling key.

! If a headset is not included with the phone, you may purchase one separately.

💡 If you are listening to music, the music stops when you answer a call and resumes after you end the call.

Internet and messaging settings



To send text and multimedia messages and to access the Internet, you must have a 2G/3G mobile data connection and the correct settings. There are different ways to get these settings:

- For most mobile phone networks and operators, Internet and messaging settings come preinstalled on your phone. You can then start using the Internet and send messages right away.
- In some cases you will get the option to download Internet and messaging settings the first time you turn on your phone. It is also possible to download these settings later from the **Settings** menu.
- You can manually add and change Internet and network settings in your phone at any time. Contact your network operator for detailed information on your Internet and messaging settings.

To download Internet and messaging settings

- 1 From your Home screen, tap .
- 2 Find and tap **Settings** > **Xperia™** > **Internet settings**.

To reset the default Internet settings

- 1 From your Home screen, tap .
- 2 Tap **Settings** > **More...** > **Mobile networks**.
- 3 Tap **Access Point Names**, then press .
- 4 Tap **Reset to default**.

Access Point Names (APNs)





An APN is used to establish data connections between your phone and the Internet. The APN defines which type of IP address to use, which security methods to invoke, and which fixed-end connections to use. Checking the APN is useful when you cannot access the Internet, have no data connection, or cannot send or receive multimedia messages.

To view the current APN

- 1 From your Home screen, tap .
- 2 Find and tap **Settings** > **More...** > **Mobile networks**.
- 3 Tap **Access Point Names**.

! If you have several available connections, the active network connection is indicated by a marked button.

To configure APN settings manually

- 1 From the Home screen, tap .
 - 2 Find and tap **Settings** > **More...** > **Mobile networks** > **Access Point Names**.
 - 3 Press .
 - 4 Tap **New APN**.
 - 5 Tap **Name** and enter the name of the network profile you want to create.
 - 6 Tap **APN** and enter the access point name.
 - 7 Enter all other information required by your network operator.
 - 8 Press  and tap **Save** .
- ! Contact your network operator for detailed information about your network settings.

Controlling data usage

Keep track of and control the amount of data transferred to and from your phone during a given period. For example, you can set data usage warnings and limits for your phone to avoid additional charges. You can also limit the amount of data used by individual applications.

- ! Adjusting data usage settings can help you keep greater control over data usage but cannot guarantee the prevention of additional charges.

To access data usage settings

- 1 From your Home screen, tap .
- 2 Find and tap **Settings** > **Data usage**.

To turn data traffic on or off

- 1 From your Home screen, tap .
- 2 Find and tap **Settings** > **Data usage**.
- 3 To turn data traffic on or off, tap the on-off switch beside **Mobile data** accordingly.

-  You can also turn data traffic on or off by marking or unmarking the **Data enabled** checkbox under **Settings** > **More...** > **Mobile networks**.

To set a data usage warning

- 1 Make sure that you have turned on data traffic.
- 2 From your Home screen, tap .
- 3 Find and tap **Settings** > **Data usage**.
- 4 To set the warning level, drag the lines to the desired values. You receive a warning notification when the amount of data traffic approaches the level you set.

To set a data usage limit

- 1 Make sure that you have turned on data traffic.
- 2 From your Home screen, tap .
- 3 Find and tap **Settings** > **Data usage**.
- 4 Mark the **Set mobile data limit** checkbox if it is not marked, then tap **OK**.
- 5 To set the data usage limit, drag the lines to the desired values.

- ! Once your data usage reaches the set limit, data traffic on your phone will be turned off automatically.

To control the data usage of individual applications

- 1 From your Home screen, tap .
- 2 Find and tap **Settings** > **Data usage**.
- 3 Find and tap the desired application.
- 4 Make the necessary adjustments to change the data usage limit, restrict background data, or restrict all data traffic for the application.
- 5 To access more specific settings for the application, tap **View app settings** and make the desired changes.

! Specific settings for an application may not always be accessible.

💡 The performance of individual applications may be affected if you change the related data usage settings.

Mobile network settings

Your phone automatically switches between mobile networks depending on what mobile networks are available in different areas. You can also manually set your phone to access a particular mobile network type, for example, WCDMA or GSM.

To select a network type

- 1 From your Home screen, tap .
- 2 Find and tap **Settings** > **More...** > **Mobile networks**.
- 3 Tap **Network Mode**.
- 4 Select a network type.

To select another network manually

- 1 From the Home screen, tap .
- 2 Find and tap **Settings** > **More...** > **Mobile networks** > **Network operators**.
- 3 Tap **Search mode**.
- 4 When a popup window appears, tap **Manual**.
- 5 Select a network.

! If you select a network manually, your phone will not search for other networks, even if you move out of range of the manually selected network.

To activate automatic network selection

- 1 From the Home screen, tap .
- 2 Find and tap **Settings** > **More...** > **Mobile networks** > **Network operators**.
- 3 Tap **Search mode**.
- 4 Tap **Automatic**.

Turning off data traffic

You can disable all data connections over 2G/3G networks with your phone to avoid any unwanted data downloads and synchronisations. Contact your network operator if you need detailed information about your subscription plan and data traffic costs.

💡 When data traffic is turned off, you can still use Wi-Fi® and Bluetooth™ connections. You can also send and receive multimedia messages.

To turn off all data traffic

- 1 From your Home screen, tap .
- 2 Find and tap **Settings** > **More...** > **Mobile networks**.
- 3 Unmark the **Data enabled** checkbox.

Data roaming

Depending on your network operator, it might be possible to allow mobile data connections via 2G/3G outside of your home network (roaming). Please note that

data transmission charges may apply. Contact your network operator for more information.

- ! Applications may sometimes use the Internet connection in your home network without any notification, for example, when sending search and synchronisation requests. Additional charges may apply for data roaming. Consult your service provider.

To activate data roaming

- 1 From the Home screen, tap .
 - 2 Find and tap **Settings** > **More...** > **Mobile networks**.
 - 3 Mark the **Data roaming** checkbox.
- ! You can't activate data roaming when data connections have been deactivated

Calling

Emergency calls

Your phone supports international emergency numbers, for example, 112 or 911. You can normally use these numbers to make emergency calls in any country, with or without the SIM card inserted if you are within range of a network.

To make an emergency call

- 1 From your Home screen, tap .
- 2 Find and Tap **Phone**.
- 3 Enter the emergency number and tap **Call**. To delete a number, tap .

 You can make emergency calls when no SIM card is inserted or when outgoing calls are barred.



To make an emergency call while the SIM card is locked

- 1 Tap **Emergency call**.
- 2 Enter the emergency number and tap **Call**. To delete a number, tap .

Call handling

You can make a call by manually dialling a phone number, by tapping a number saved in your phone's contact list, or by tapping the phone number in your call log view. You can also use the smart dial feature to quickly find numbers from your contact list and call logs.

To make a call by dialling

- 1 From your Home screen, tap .
- 2 Find and tap **Phone**.
- 3 Enter the number of the recipient and tap **Call**. To delete a number, tap .

To make a call using smart dial

- 1 From your Home screen, tap .
- 2 Find and tap **Phone**.
- 3 Use the dialpad to enter letters or numbers that correspond to the contact you want to call. As you enter each letter or number, a list of possible matches appears.
- 4 Tap the contact you want to call.

To end a call

- Tap **End call**.

To make an international call

- 1 From your Home screen, tap .
- 2 Find and tap **Phone**.
- 3 Touch and hold 0 until a "+" sign appears.
- 4 Enter the country code, area code (without the first 0) and phone number, then tap **Call**.

To answer a call



- Drag  to the right across the screen.
- ! If you are using regular headphones without a microphone, you have to remove the headphones from the headset connector to be able to answer the call.

To decline a call

- Drag  to the left across the screen.

To reject a second call

- When you hear repeated beeps during a call, tap **Busy**.

To change the ear speaker volume during a call

- Press the volume key up or down.

To turn on the loudspeaker during a call

- Tap .

To mute the microphone during a call

- Tap .

To activate the screen during a call

- Press .

To enter numbers during a call

- 1 During a call, tap . A keypad appears.
- 2 Enter numbers.

To mute the ringtone for an incoming call

- When you receive the call, press the volume key.

Recent calls

In the call log, you can view recently missed , received  and dialled  calls.

To view your missed calls

- 1 When you have missed a call,  appears in the status bar. Drag the status bar downwards.
- 2 Tap **Missed call**.

To call a number from your call log

- 1 From your Home screen, tap .
- 2 Find and tap **Phone**. The call log view appears on the upper part of the screen.
- 3 To call a number directly, tap the number. To edit a number before calling, touch and hold the number, then tap **Edit number before call**.

- ! You can also call a number by tapping  > **Call back**.

To add a number from the call log to your contacts

- 1 From your Home screen, tap .
- 2 Find and tap **Phone**. The call log view appears on the upper part of the screen.
- 3 Touch and hold the number, then tap **Add to Contacts**.
- 4 Tap the desired contact, or tap **Create new contact**.
- 5 Edit the contact details and tap **Done**.

Voicemail

If your subscription includes a voicemail service, callers can leave voice messages for you when you can't answer calls. Your voicemail service number is normally saved on your SIM card. If not, you can get the number from your service provider and enter it manually.

To enter your voicemail number

- 1 From the Home screen, tap .
- 2 Find and tap **Settings** > **Call settings** > **Voicemail settings** > **Voicemail number**.
- 3 Enter your voicemail number.
- 4 Tap **OK**.

To call your voicemail service

- 1 From your Home screen, tap .
- 2 Find and tap **Phone**.
- 3 Touch and hold **1**.

Multiple calls

If you have activated call waiting, you can handle multiple calls at the same time. When it is activated, you will be notified by a beep if you receive another call.

To activate or deactivate call waiting

- 1 From the Home screen, tap .
- 2 Find and tap **Settings** > **Call settings** > **Additional settings**.
- 3 To activate or deactivate call waiting, tap **Call waiting**.



To answer a second call and end the ongoing call

- When you hear repeated beeps during a call, tap **End current call and answer**.

To answer a second call and put the ongoing call on hold

- When you hear repeated beeps during a call, tap **Answer**.

To make a second call

- 1 During an ongoing call, tap .
- 2 Enter the number of the recipient and tap .
- 3 If the recipient answers, the first call is put on hold.

- 💡 The same procedure applies to subsequent calls.

To switch between multiple calls

- To switch to another call and put the current call on hold, tap the desired number or contact.





To end the ongoing call and return to the next call on hold

- Tap .

Conference calls

With a conference or multiparty call, you can have a joint conversation with two or more persons.

To make a conference call

- 1 During an ongoing call, tap .
 - 2 Dial the number of your second participant and tap .
 - 3 If the second participant answers, the first call is put on hold.
 - 4 Tap .
-  To add more participants, repeat steps 1 to 4.

To have a private conversation with a conference call participant

- 1 During an ongoing conference call, tap the button showing the number of participants. For example, tap **3 participants** if there are three participants on the call.
- 2 Tap the name of the participant you want to talk to privately.
- 3 To end the private conversation and return to the conference call, tap .

To release a participant from a conference call

- 1 During an ongoing conference call, tap the button showing the number of participants. For example, tap **3 participants** if there are three participants.
- 2 Tap  next to the participant you want to release.

To end a conference call

- During the conference call, tap **End conference call**.

Call settings

Barring calls

You can bar all or certain categories of incoming and outgoing calls. When you use call barring for the first time, you need to enter your PUK (Personal Unblocking Key) and then a new password to activate the call barring function.

To bar incoming or outgoing calls

- 1 From your Home screen, tap .
- 2 Find and tap **Settings > Call settings > Call barring**.
- 3 Select an option.
- 4 Enter the password and tap **Enable**.

Rejecting a call with a message

You can reject a call with a predefined message. When you reject a call with such a message, the message is automatically sent to the caller and saved on your phone.

Six messages are predefined in the phone. You can select from these predefined messages, which can also be edited if necessary.

To reject a call with a predefined message

- Drag **Reject with message** upward, then select a message.

To reject a second call with a predefined message

- When you hear repeated beeps during a call, drag **Reject with message** upward, then select a message.

To edit the message used to reject a call

- 1 From your Home screen, tap .
- 2 Find and tap **Settings > Call settings > Reject call with message**.
- 3 Tap the message you want to edit, then make the necessary changes.
- 4 When you're done, tap **OK**.

Forwarding calls

You can forward calls, for example, to another phone number, or to an answering service.

To forward calls

- 1 From your Home screen, tap .
- 2 Find and tap **Settings** > **Call settings** > **Call forwarding**.
- 3 Select an option.
- 4 Enter the number you want to forward the calls to, then tap **Enable**.

To turn off call forwarding

- 1 From your Home screen, tap .
- 2 Find and tap **Settings** > **Call settings** > **Call forwarding**.
- 3 Select an option, then tap **Disable**.

Showing or hiding your phone number

You can select to show or hide your phone number on call recipients' devices when you call them.

To show or hide your phone number

- 1 From your Home screen, tap .
- 2 Find and tap **Settings** > **Call settings** > **Additional settings** > **Caller ID**.

Fixed Dialling Numbers

If you have received a PIN2 code from your service provider, you can use a list of Fixed Dialling Numbers (FDN) to restrict outgoing calls.

To enable or disable fixed dialling

- 1 From your Home screen, tap .
- 2 Find and tap **Settings** > **Call settings** > **Fixed dialling numbers**.
- 3 Tap **Activate fixed dialling** or **Deactivate fixed dialling**.
- 4 Enter your PIN2 and tap **OK**.

To access the list of accepted call recipients

- 1 From your Home screen, tap .
- 2 Find and tap **Settings** > **Call settings** > **Fixed dialling numbers** > **Fixed dialling numbers**.

Contacts

Use the Contacts application to store and manage all your numbers, email addresses, and other contact data in one place. Just tap on a contact to see all communications with that contact in one easy overview.

You can add new contacts in your phone and synchronise them with contacts saved in your Google™ account, Microsoft® Exchange ActiveSync® account, or other accounts that support synchronisation. The Contacts application automatically creates new entries and also helps you match data such as email addresses with existing entries. You can also manage this process manually. For more information, go to www.sonymobile.com.

Transferring contacts to your new phone



There are several ways to transfer contacts to your new phone. Select a transfer method that best suits your situation.

Transferring contacts using a PC

You can use a PC to transfer contacts from several phone brands, including iPhone, Samsung, HTC and Nokia.

You need:

- An Internet-connected PC running Windows®
- A USB cable for your old phone
- A USB cable for your new Android™ phone
- Your old phone
- Your new Android™ phone

! If you don't have access to all of the items listed above, go to www.sonymobile.com to find out about other ways to transfer your contacts.

Using the PC Companion program to transfer contacts

If you are transferring contacts using a PC, use the PC Companion program. It's free, and the installation files are already saved on your new phone. PC Companion also offers a range of other features, including help to update your phone software.

To install PC Companion

- 1 **New phone:** Turn on your new Android™ phone and connect it to a PC using a USB cable.
- 2 **New phone:** Tap **Install** to install PC Companion on the PC.
- 3 **Computer:** If a popup window appears, select *Run Startme.exe*. In the new popup window that appears, click *Install* to start the installation and then follow the instructions to complete the installation.

To transfer contacts to your new phone using PC Companion

- 1 Make sure that PC Companion is installed on your PC.
- 2 Open the PC Companion program on the PC, then click *Contacts Setup* and follow the instructions to transfer your contacts.





Transferring contacts using an Apple® Mac® computer

For detailed instructions on how to use an Apple Mac computer to transfer contacts from your old phone, go to www.sonymobile.com.

Transferring contacts using synchronisation accounts



Your phone works with popular online synchronisation accounts such as Google Sync™, Microsoft® Exchange ActiveSync® or Facebook™. If you have synced the contacts in your old phone or your computer with an online account, you can transfer your contacts to your new phone using that account. For more detailed information about synchronisation, see *Synchronising data on your phone* on page 62.

To synchronise your phone contacts with a synchronisation account

- 1 From your Home screen, tap , then tap .
- 2 Press , then tap **Settings > Accounts & sync**.
- 3 To set up a synchronisation account, tap **Add account** and follow the on-screen instructions. If you have already set up a synchronisation account and you want to sync with that account, tap the account, press , and tap **Sync now**.



Transferring contacts from a SIM card

To import contacts from a SIM card

- 1 From your Home screen, tap , then tap .
- 2 Press , then tap **Import contacts > SIM card**.
- 3 If you have set up a synchronisation account, you can choose to add the SIM card contacts under that account. Or you can choose to only use these contacts in the phone. Select your desired option.
- 4 To import an individual contact, find and tap the contact. To import all contacts, tap **Import all**.

Transferring contacts from a memory card

To import contacts from a memory card

- 1 From your Home screen, tap , then tap .
- 2 Press , then tap **Import contacts > SD card**.
- 3 If you have set up a synchronisation account, you can add the imported memory card contacts under that account. Or you can choose to only use the imported contacts in the phone. Select your desired option.
- 4 If you have more than one vCard file on the SD card, a list appears showing different batches of phone contacts, with the corresponding dates for when they were created. Select the batch you want to import.

Receiving contacts from other devices

To receive contact data sent using Bluetooth™ technology

- 1 Make sure you have the Bluetooth™ function turned on and your phone set to visible. If not, then you cannot receive data from other devices.
- 2 When you are asked to confirm whether you want to receive the file, tap **Accept**.
- 3 Drag down the Notification panel and tap the file you received to import the contact data.

To receive contacts sent using a messaging service

- 1 When you receive a new text message, multimedia message, or email message, open the message.
- 2 The received contact data appears as a vCard attachment. Tap, or touch and hold the vCard file to open a menu so you can save the contact data.

Contacts screen overview

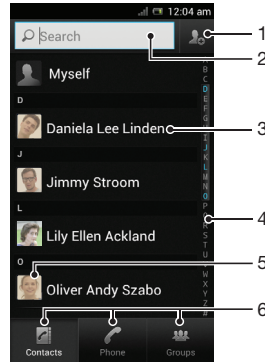

- 1 Tap here to create a contact
- 2 Contact search field
- 3 Touch a contact to view its details
- 4 Alphabetical index for browsing contacts
- 5 Tap a contact thumbnail to access the Quick Contact menu
- 6 Shortcut tabs

Managing your contacts

You can create, edit and synchronise your contacts in a few simple steps. You can select contacts saved in different accounts and manage how you display them in the phone.



If you synchronise your contacts with more than one account, you can join contacts in your phone to avoid duplicates.

- ! Some synchronisation services, for example, some social networking services, do not allow you to edit contact details.





To view your contacts

- From your Home screen, tap , then tap . Your contacts are listed here.



To select which contacts to display in the Contacts application

- 1 From your Home screen, tap , then tap .
- 2 Press , then tap **Filter**.
- 3 In the list that appears, mark and unmark the desired options. If you have synchronised your contacts with a synchronisation account, that account appears in the list. To further expand the list of options, tap the account.
- 4 When you are finished, tap **OK**.



To add a contact

- 1 From your Home screen, tap , then tap .
 - 2 Tap .
 - 3 If you have synchronised your contacts with one or more accounts, select the account to which you want to add this contact, or tap **Phone contact** if you only want to use this contact in your phone.
 - 4 Enter or select the desired information for the contact.
 - 5 When you are finished, tap **Done**.
-  If you add a plus sign and the country code before a contact phone number, you can use the number when you make calls from other countries.

To edit a contact



- 1 From the Home screen, tap , then tap .
- 2 Touch and hold the contact you want to edit, then tap **Edit contact**.
- 3 Edit the desired information. When you are finished, tap **Done**.

To associate a picture with a contact



- 1 From your Home screen, tap , then tap .
- 2 Touch and hold the contact you want to edit, then tap **Edit contact**.
- 3 Tap  and select the desired method for adding the contact picture.
- 4 When you have added the picture, tap **Done**.

-  You can also add a picture to a contact directly from the **Gallery** application.



To view your communication with a contact

- 1 From the Home screen, tap , then tap .
- 2 Tap the contact you want to view.
- 3 To view your communication with the contact for different media, tap or flick through the filter items at the bottom of the screen.

To delete contacts

- 1 From your Home screen, tap , then tap .
- 2 Press , then tap **Delete contacts**.
- 3 Mark the contacts you want to delete, or tap **Mark all** if you want to delete all contacts.
- 4 Tap **Delete > OK**.



To edit contact information about yourself

- 1 From your Home screen, tap , then tap .
- 2 Touch and hold **Myself** at the top of the contact list, then tap **Edit contact**.
- 3 Enter the new information or make the changes you want.
- 4 When you are done, tap **Done**.



Avoiding duplicate entries in the Contacts application

If you synchronise your contacts with a new account or import contact information in other ways, you could end up with duplicate entries in the Contacts application. If this happens, you can join such duplicates to create a single entry. And if you join entries by mistake, you can separate them again later.

To link contacts

- 1 From your Home screen, tap , then tap .
- 2 Touch and hold the contact you want to link with another contact, then tap **Link contact**.
- 3 From the list that appears, tap the contact whose information you want to join with the first contact, then tap **OK** to confirm. The information from the first contact is merged with the second contact, and the first contact is no longer displayed in the Contacts list.



To separate linked contacts

- 1 From your Home screen, tap , then tap .
- 2 Touch and hold the linked contact you want to edit, then tap **Edit contact**.
- 3 Tap **Unlink contact**.
- 4 Tap **OK**.



Favourites

You can mark contacts as favourites so that you can get quick access to them from the Contacts application.

To mark or unmark a contact as a favourite

- 1 From the Home screen, tap , then tap .
- 2 Tap the contact you want to add to or remove from your favourites.
- 3 Tap .



To view your favourite contacts

- 1 From your Home screen, tap , then tap .
- 2 Tap .

Groups



You can assign contacts to groups to get quicker access to them from within the Contacts application.

To assign a contact to a group

- 1 From the Home screen, tap , then tap .
- 2 Touch and hold the contact that you want to assign to a group, then tap **Edit contact**.
- 3 Tap the bar directly under **Assign to group**.
- 4 Mark the checkboxes for the groups to which you want to add the contact, then tap **Done**.

Communicating with your contacts

To search for a contact

- 1 From your Home screen, tap , then tap .
- 2 Enter the first few letters of the contact name in the **Search** field. All contacts beginning with those letters appear.



The quick contact menu

Tap a contact's thumbnail to view quick communication options for a particular contact. Options include calling the contact, sending a text or multimedia message, and starting a chat using the Google Talk™ application.



- ! For an application to appear as an option in the quick contact menu, you may need to set up the application in your phone and be logged in to the application. For example, you need to start the Gmail™ application and enter your login details before you can use Gmail™ from the quick contact menu.

Sharing your contacts



To send your business card

- 1 From your Home screen, tap , then tap .
- 2 Tap **Myself**.
- 3 Press , then tap **Send contact > OK**.
- 4 Select an available transfer method and follow the on-screen instructions.

To send a contact

- 1 From your Home screen, tap , then tap .
- 2 Tap the contact whose details you want to send.
- 3 Press , then tap **Send contact** > **OK**.
- 4 Select an available transfer method and follow the on-screen instructions.



To send several contacts at once

- 1 From your Home screen, tap , then tap .
- 2 Press , then tap **Send contacts**.
- 3 Mark the contacts you want to send, or select all if you want to send all contacts.
- 4 Tap **Send**, then tap **OK** to confirm.
- 5 Select an available transfer method and follow the on-screen instructions.



Backing up contacts

You can use a memory card, a SIM card or an online synchronisation tool such as Microsoft® Exchange ActiveSync® to back up contacts.

To export all contacts to a memory card

- 1 From your Home screen, tap , then tap .
- 2 Press , then tap **Back up contacts** > **SD card**.
- 3 Tap **OK**.

To export contacts to a SIM card

- 1 From your Home screen, tap , then tap .
- 2 Press , then tap **Back up contacts** > **SIM card**.
- 3 Mark the contacts you want to export, or tap **Mark all** if you want to export all your contacts.
- 4 Tap **Back up**.
- 5 Select **Add contacts** if you want to add the contacts to existing contacts on your SIM card, or select **Replace all contacts** if you want to replace the existing contacts on your SIM card.

- ! When you export contacts to a SIM card, not all information may get exported. This is due to memory limitations on SIM cards.





Messaging

Using text and multimedia messaging

You can send and receive text messages from your phone using SMS (Short Message Service). If your subscription includes MMS (Multimedia Messaging Service), you can also send and receive messages that contain media files, for example, pictures and videos. The number of characters you can send in a single text message varies depending on the operator and the language you use. If you exceed the character limit, then all your single messages are linked together and sent as one message. You are charged for each single text message you send. When you view your messages, they appear as conversations, which means that all messages to and from a particular person are grouped together.



- ! To send multimedia messages, you need the correct MMS settings in your phone. See *Internet and messaging settings* on page 33.

To create and send a message

- 1 From your Home screen, tap , then find and tap .
- 2 Tap **New message**.
- 3 Tap **Write message** and enter your message text.
- 4 To add a recipient, tap **Add recipient**, then select a contact or enter the full number manually.
- 5 If you want to add a media file, tap  and select an option.
- 6 If you want to add or remove recipients before sending the message, press . To add a recipient, tap **Add recipient**. To remove a recipient, tap **Edit recipients** and tap  next to a recipient field. When you are finished, tap **Done**.
- 7 To send the message, tap **Send**.



- 💡 If you exit a message before sending, it gets saved as a draft. The conversation gets tagged with the word **Draft**.

To read a received message

- 1 From your Home screen, tap , then find and tap .
- 2 Tap the desired conversation.
- 3 If the message is not yet downloaded, tap and hold the message, then tap **Download message**.

- 💡 You can also open messages from the status bar when  appears there. Just drag down the bar and tap the message.



To reply to a message

- 1 From your Home screen, tap , then find and tap .
- 2 Tap the conversation containing the message.
- 3 Enter your reply and tap **Send**.



To forward a message

- 1 From your Home screen, tap , then tap **Messaging**.
- 2 Tap the desired conversation.
- 3 Touch and hold the message you want to forward, then tap **Forward message**.
- 4 Select a recipient from the list, or tap **Add recipient** to add a recipient who is not in the list.
- 5 Edit the message and tap **Send**.



To delete a message

- 1 From your Home screen, tap , then find and tap .
- 2 Tap the conversation containing the message you want to delete.
- 3 Touch and hold the message you want to delete, then tap **Delete message > Yes**.



To delete conversations

- 1 From your Home screen, tap , then find and tap .
- 2 Press , then tap **Delete several**.
- 3 Mark the checkboxes for the conversations you want to delete, then tap **Delete**.



To save a sender's number to a contact

- 1 From your Home screen, tap , then tap **Messaging**.
- 2 Tap a conversation.
- 3 Tap the sender's number at the top of the screen.
- 4 Tap .
- 5 Select an existing contact, or tap  if you want to create a new contact.
- 6 Edit the contact information and tap **Done**.



To call a message sender

- 1 From your Home screen, tap , then tap **Messaging**.
- 2 Tap a conversation.
- 3 Tap the recipient name or number at the top of the screen.
- 4 If the recipient is saved in your contacts, tap the phone number you want to call. If you have not saved the recipient in your contacts, tap .

To save a file contained in a message you receive



- 1 From your Home screen, tap , then find and tap .
- 2 Tap the conversation you want to open.
- 3 If the message has not been downloaded yet, tap and hold the message, then tap **Download message**.
- 4 Touch and hold the file you want to save, then select the desired option.

To search for messages



- 1 From your Home screen, tap , then find and tap .
- 2 Press , then tap **Search**.
- 3 Tap **Search Messaging**.
- 4 Enter your search keywords, then tap **Go**.

Text and multimedia message options

To change your message notification settings



- 1 From your Home screen, tap , then find and tap .
- 2 Press , then tap **Settings**.
- 3 To set a notification sound, tap **Notification tone** and select an option.
- 4 For other notification settings, check or uncheck the relevant checkboxes.

To change the delivery report settings for outgoing messages

- 1 From your Home screen, tap , then find and tap .
- 2 Press , then tap **Settings**.
- 3 Tap **Delivery report** to activate or deactivate delivery reports.

- ! When a message has been delivered to a recipient,  appears in the message.

To view messages saved on the SIM card



- 1 From your Home screen, tap , then find and tap .
- 2 Press , then tap **Settings > SIM messages**.

Email

Use the Email application in your phone to send and receive emails through your regular email account or through your corporate account. Or you can do both. Your phone can handle several email accounts at the same time. You can set up these accounts to run through one combined inbox, or through separate inboxes. Note that emails you receive to your Gmail™ account can be accessed in the phone from both the Email and the Gmail™ applications.

- 💡 Your corporate Microsoft® Outlook® email messages have to be stored on a Microsoft® Exchange server for the functionality described above to work. See *Synchronising your corporate email, calendar and contacts* on page 63 for more information.









To set up an email account in your phone

- 1 From your Home screen, tap .
- 2 Find and tap .
- 3 Enter your email address and password, then tap **Next**.
- 4 If the settings for the email account cannot be downloaded automatically, complete the setup manually. If necessary, contact your email service provider for detailed settings. For corporate email setup on your phone, select **Exchange Active Sync** as the account type.
- 5 When you are prompted, enter a name for your email account, so that it is easily identifiable. The same name shows in the emails you send from this account. When you are finished, tap **Next**.







- 💡 You can set up more than one email account. See *To add an extra email account in your phone* on page 52.

Using email



To create and send an email message

- 1 From your Home screen, tap , then find and tap . The inbox of your default email account appears. If you want to use another email account that you have set up on your phone, tap the bar containing , then select the account you want to send the message from.
- 2 Tap .
- 3 Tap **To** and start typing the recipient's email address. Matches are displayed in a dynamic list. Tap the relevant match or continue typing the complete email address. To add more recipients, enter a comma (,) or a semicolon (;) and start typing another name. To delete a recipient, tap .
- 4 To select an email address saved in your contacts, tap , then find and mark the checkbox next to a recipient field. To add more than one recipient, mark the checkboxes for the desired recipients. When you are finished, tap **Done**.
- 5 Tap the subject field and enter the email subject.
- 6 To attach a file, press , then tap **Attach file**. Select the type of file, then tap the file you want to attach from the list that appears.
- 7 Tap the body text field and enter your message text.
- 8 To add Cc/Bcc fields, press , then tap **Show Cc/Bcc**.
- 9 To send the email, tap .





To receive email messages

- 1 From your Home screen, tap .
 - 2 Find and tap . The inbox of your default email account appears.
 - 3 If you want to check another email account that you have set up on your phone, tap the bar containing , then select the account you want to check. If you want to check all your email accounts at once, tap the bar containing , then tap **Combined view**.
 - 4 To download new messages, tap .
-  If you have set up a corporate email account, you can set the check frequency to **Automatic (Push)**.



To read your email messages

- 1 From your Home screen, tap .
- 2 Find and tap . The inbox of your default email account appears. If you want to check another email account that you have set up on your phone, tap the bar containing , and select the account you want to check.
- 3 In the email inbox, scroll up or down and tap the email you want to read.
- 4 In the body text field, spread two fingers apart, or pinch them together, to zoom in or out.
- 5 Use the forward and backward arrows to read your next or previous message.







To view an email message attachment

- 1 From your Home screen, tap .
- 2 Find and tap . The inbox of your default email account appears. If you want to check another email account that you have set up on your phone, tap the bar containing , then select the account you want to check.
- 3 Find and tap the desired message in your email inbox. Emails with attachments are identified by .
- 4 Tap the attachment tab in the email body. All attachments appear in a list.
- 5 Tap **Load** below an attachment item.
- 6 When the attachment is downloaded, tap **View** or **Save**.





To save a sender's email address to your contacts

- 1 From your Home screen, tap .
- 2 Find and tap . The inbox of your default email account appears. If you want to check another email account that you have set up on your phone, tap the bar containing , then select the account you want to check.
- 3 Find and tap the desired message in your email inbox.
- 4 Tap the name of the sender.
- 5 Tap **OK** when you are prompted to add the name to your contacts.
- 6 Select an existing contact, or tap **Create new contact** if you want to create a new contact.
- 7 Edit the contact information and tap **Done**.





To reply to an email message

- 1 From your Home screen, tap .
- 2 Find and tap . The inbox of your default email account appears. If you want to check another email account that you have set up on your phone, tap the bar containing , then select the account you want to check.
- 3 Find and tap the message you want to reply to, then tap .
- 4 To reply to all, tap , then tap **Reply all**.
- 5 Enter your reply, then tap .



To forward an email message

- 1 From your Home screen, tap .
- 2 Find and tap . The inbox of your default email account appears. If you want to check another email account that you have set up on your phone, tap the bar containing , then select the account you want to check.
- 3 Find and tap the message you want to forward.
- 4 Tap , then tap **Forward**.
- 5 Tap **To** and enter the recipient's address.
- 6 Enter your message text, then tap .





To delete an email message

- 1 From your Home screen, tap .
- 2 Tap . The inbox of your default email account appears. If you want to check another email account that you have set up on your phone, tap the bar containing , then select the account you want to check.
- 3 In your email inbox, mark the checkbox for the email you want to delete, then tap .



To manage your email in batches

- 1 From your Home screen, tap , then find and tap . The inbox of your default email account appears. If you want to check another email account that you have set up on your phone, tap the bar containing , then select the account you want to check.
- 2 Mark the checkboxes for the emails you want to select.
- 3 When you are finished, tap one of the icons in the tool bar to, for example, move the selected emails to another folder.

To view all folders for one email account



- 1 From your Home screen, tap , then find and tap . The inbox of your default email account appears. If you want to check another email account that you have set up on your phone, tap the bar containing , then select the account you want to check.
- 2 Tap  to view all the folders in the account.

To change the inbox check frequency



- 1 From your Home screen, tap .
- 2 Find and tap .
- 3 Press , then tap **Settings**.
- 4 If you are using several email accounts, tap the account you want to adjust.
- 5 Tap **Inbox check frequency** and select an option.

Using email accounts

To add an extra email account in your phone



- 1 From your Home screen, tap .
- 2 Find and tap .
- 3 Press , then tap **Settings**.
- 4 Tap **Add account**.
- 5 Enter the email address and password, then tap **Next**.
- 6 If the settings for the email account cannot be downloaded automatically, complete the setup manually. If necessary, contact your email service provider for detailed settings.
- 7 When prompted, enter a name for your email account so that it is easily identifiable. The same name shows in the emails that you send from this account.
- 8 When you are finished, tap **Next**.

To set an email account as your default account

- 1 From your Home screen, tap .
- 2 Find and tap .
- 3 Press , then tap **Settings**.
- 4 Tap the account you want to use as the default account for composing and sending emails.
- 5 Mark the **Default account** checkbox. The inbox of the default account appears every time you open the Email application.

 If you only have one email account, this account is automatically the default account.

To remove an email account from your phone

- 1 From your Home screen, tap .
- 2 Find and tap **Email**.
- 3 Press , then tap **Settings**.
- 4 Select the account you want to remove.
- 5 Tap **Delete account** > **OK**.

Gmail™ and other Google™ services

If you have a Google™ account, you can use the Gmail™ application in your phone to read, write and organise email messages. After you set up your Google™ account to work in the phone, you can also chat to friends using the Google Talk™ application, synchronise your phone calendar application with your Google Calendar™, and download applications and games from Google Play™.

 The services and features described in this chapter may not be supported in all countries or regions, or by all networks and/or service providers in all areas.

To set up a Google™ account in your phone

- 1 From your Home screen, tap .
- 2 Find and tap **Settings** > **Accounts & sync** > **Add account** > **Google**.
- 3 Follow the registration wizard to create a Google™ account, or sign in if you already have an account. Your phone is now ready to use with Gmail™, Google Talk™ and Google Calendar™.

 You can also sign in or create a Google™ account from the setup guide the first time you start your phone. Or you can go online and create an account at www.google.com/accounts.

To open the Gmail™ application

- 1 From the Home screen, tap .
- 2 Find and tap **Gmail**.

Google Talk™

You can use Google Talk™ instant messaging in your phone to chat with friends who also use this application.

To start Google Talk™

- 1 From your Home screen, tap .
- 2 Find and tap **Talk**.

To reply to an instant message with Talk

- 1 When someone contacts you on **Talk**,  appears in the status bar.
- 2 Drag the status bar downwards, then tap the message and begin to chat.

Getting started with Google Play™

Open Google Play™ and enter a world of applications and games. You can browse these applications and games through different categories. You can also rate an application or game and send feedback on it.

To use Google Play™, you need to have a Google™ account. See *To set up a Google™ account in your phone* on page 53.

- ! Google Play™ may not be available in all countries or regions

To open Google Play™

- 1 From the Home screen, tap .
- 2 Find and tap **Play Store**.

Downloading from Google Play™

You can download all kinds of applications from Google Play™, including free applications.

Before you download applications

Before you start downloading from Google Play™, make sure that you have a working Internet connection.

Also, remember that you might incur data traffic charges when you download content to your phone. Contact your operator for more information.

To download a free application

- 1 In Google Play™, find an item you wish to download by browsing categories, or by using the search function.
- 2 Tap the item to view its details, and follow the instructions to complete the installation.

To download a paid application

- 1 In Google Play™, find an item you wish to download by browsing categories, or by using the search function.
- 2 Tap the item to view its details, and follow the instructions in your phone to complete your purchase.

To open a downloaded application

- 1 In Google Play™, press , then tap **My Apps**.
- 2 Tap the downloaded application.

- 💡 You can also access downloaded applications from the Application screen.

Clearing your application data

You may sometimes need to clear data for an application. This might happen if, for example, the application memory becomes full, or you want to clear high scores for a game. You might also want to erase incoming email, text and multimedia messages in some applications.

To clear all cache for an application

- 1 From your Home screen, tap .
- 2 Find and tap **Settings**.
- 3 Tap **Apps**.
- 4 Tap the application for which you want to clear all cache.
- 5 Tap **Clear cache**.

- ! It is not possible to clear the cache for some applications.

To delete an installed application

- 1 From your Home screen, tap .
- 2 Find and tap **Settings**.
- 3 Tap **Apps**.
- 4 Select the application that you want to delete.
- 5 Tap **Uninstall**.

! It is not possible to delete some preinstalled applications.

Permissions

Some applications need to access parts of your phone to be able to work properly. For example, a navigation application needs permissions to send and receive data traffic, and access your location. Some applications might misuse their permissions by stealing or deleting data, or reporting your location. Make sure you only install and give permissions to applications you trust.

To view permissions of an application

- 1 From your Home screen, tap .
- 2 Find and tap **Settings**.
- 3 Tap **Apps**.
- 4 Tap the desired application.
- 5 Scroll down to view the relevant details under **Permissions**.

Installing applications not from Google Play™

Installing applications of unknown or unreliable origin can damage your phone. By default, your phone is set to block such installations. However, you can change this setting and allow installations from unknown sources.

! Sony does not warrant or guarantee the performance of any third-party applications or content transferred via download or other interface to your phone. Similarly, Sony is not responsible for any damage or reduced performance of your phone attributable to the transfer of third-party content. Only use content from reliable sources. Contact the content provider if you have any questions or concerns.

To allow the installation of applications not from Google Play™

- 1 From your Home screen, tap .
- 2 Find and tap **Settings > Security**.
- 3 Mark the **Unknown sources** checkbox.

PlayNow™ service

You can use the PlayNow™ service to download applications, music, games, ringtones and wallpapers. The PlayNow™ service offers both free and non-free downloads.



 The PlayNow™ service is not available in all countries.

Before you download content

Before you download, make sure that you have an Internet connection. Also, you may need to have a memory card inserted in your phone to download content.

 When you download content to your phone, you might be charged for the amount of data transferred. Contact your operator for information about data transfer rates in your country.

To start PlayNow™

- 1 From the Home screen, tap .
- 2 Find and tap .

Downloading from the PlayNow™ service

Download a range of content from the PlayNow™ service direct to your phone. Choose from a variety of applications, games, music, ringtones and other content. Note that payment options for non-free applications may vary per country.

To download a PlayNow item to your phone

- 1 From your Home screen, tap .
- 2 Find and tap **PlayNow™**.
- 3 Find an item you want to download by browsing categories, or by using the search function.
- 4 Tap the item to view its details.
- 5 Click “Buy now!” to start the purchase process. After your purchase has been validated, you can start to download your content.

Getting organised



Calendar

Your phone has a calendar for managing your time schedule. If you have a Google™ account, you can also synchronise your phone calendar with your web calendar. See *Synchronising data on your phone* on page 62.



To set the calendar view



- 1 From your Home screen, tap , then find and tap **Calendar**.
- 2 Press  and select an option.

To view multiple calendars

- 1 From your Home screen, tap , then find and tap **Calendar**.
- 2 Press , then tap **My calendars**.
- 3 Select the calendars you want to view.

To create a calendar event



- 1 From your Home screen, tap , then tap **Calendar**.
- 2 Press , then tap **New event**.
- 3 Enter the name, time, location and description for the event.
- 4 If desired, select another option under **Repetition**.
- 5 Select a reminder for the event. To add a new reminder for the event, tap .
- 6 Tap **Save**.

-  When the appointment time approaches, your phone plays a short sound to remind you. Also,  appears in the status bar.

To view a calendar event

- 1 From your Home screen, tap , then tap **Calendar**.
- 2 Tap the event you want to view.

To change the calendar settings

- 1 From your Home screen, tap , then tap **Calendar**.
- 2 Press , then tap **More > Settings**.
- 3 Tap to open the setting you want to change, and edit as desired.

Alarm clock

Use your phone as an alarm clock and select any sound in your phone as your alarm signal. The alarm does not sound if your phone is turned off. But it does sound when your phone is set to silent mode.

To open the alarm clock

- 1 From your Home screen, tap .
- 2 Find and tap **Clock**.
- 3 Tap **Set alarm**.

To set a new alarm

- 1 From your Home screen, tap .
- 2 Find and tap **Clock**.
- 3 Tap **Set alarm**.
- 4 Tap **Add alarm**.
- 5 Tap **Time** and adjust the time by scrolling up and down.
- 6 Tap **Set**.
- 7 If desired, edit other alarm settings.
- 8 Tap **OK**.

To edit an existing alarm

- 1 From your Home screen, tap .
- 2 Find and tap **Clock**.
- 3 Tap **Set alarm**.
- 4 Tap the alarm you want to edit.
- 5 Tap **Time**.
- 6 Scroll up or down to adjust the time.
- 7 Tap **Set**.
- 8 If desired, edit other alarm settings.
- 9 Tap **OK**.

! The alarm time format displayed is the same as the format you select for your general time settings, for example, 12-hour or 24-hour.

To deactivate an alarm

- 1 From your Home screen, tap .
- 2 Find and tap **Clock**.
- 3 Tap **Set alarm**.
- 4 Unmark the checkbox next to the alarm you want to deactivate.

To activate an existing alarm

- 1 From your Home screen, tap .
- 2 Find and tap **Clock**.
- 3 Tap **Set alarm**.
- 4 Mark the checkbox next to the alarm you want to activate.

To delete an alarm

- 1 From your Home screen, tap .
- 2 Find and tap **Clock**.
- 3 Tap **Set alarm**.
- 4 Touch and hold the alarm you want to delete.
- 5 Tap **Delete alarm**, then tap **OK**.

To set the ringtone for an alarm

- 1 From your Home screen, tap .
- 2 Find and tap **Clock**.
- 3 Tap **Set alarm**.
- 4 Tap the alarm you want to edit.
- 5 Tap **Ringtone** and select an option.
- 6 Tap **Done**, then tap **OK**.

To set a recurring alarm

- 1 From your Home screen, tap .
- 2 Find and tap **Clock**.
- 3 Tap **Set alarm**.
- 4 Tap the alarm you want to edit.
- 5 Tap **Repeat**.
- 6 Mark the checkboxes for the desired days, then tap **OK**.
- 7 Tap **OK**.



To set the title for an alarm

- 1 From your Home screen, tap .
- 2 Find and tap **Clock**.
- 3 Tap **Set alarm**.
- 4 Tap the alarm you want to edit.
- 5 Tap **Label** and enter a name for the alarm.
- 6 Tap **OK**.

To activate the vibrate function for an alarm

- 1 From your Home screen, tap .
- 2 Find and tap **Clock**.
- 3 Tap **Set alarm**.
- 4 Tap the alarm you want to edit.
- 5 Mark the **Vibrate** checkbox, then tap **OK**.

To set alarms to sound when the phone is in silent mode

- 1 From your Home screen, tap .
- 2 Find and tap **Clock**.
- 3 Tap **Set alarm**.
- 4 Press , then tap **Settings**.
- 5 Mark the **Alarm in silent mode** checkbox.

To snooze an alarm when it sounds

- When the alarm sounds, tap **Snooze**.



To turn off an alarm when it sounds

- When the alarm sounds, tap **Dismiss**.

Scanning with the NeoReader™ application

Use your phone as a barcode scanner to find out more about items you scan. For example, you see a coat in a magazine ad and want to find the nearest retail outlet to buy it. If the ad contains a readable barcode, the NeoReader™ application uses this code to access mobile web content, such as a web page with more product information or a map of nearby outlets. NeoReader™ supports most standard barcode types.

To start the NeoReader™ application

- 1 From the Home screen, tap .
- 2 Find and tap  NeoReader™.

To scan a barcode

- 1 When the NeoReader™ application is open, hold the phone camera over the barcode until the complete barcode is visible in the viewfinder.
- 2 The phone automatically scans the barcode, and vibrates when the barcode is recognised. If the barcode is not recognised, tap  to scan the code manually.









! Some bar codes might be too small to scan.

To enter a barcode manually

- 1 When the NeoReader™ application is open, tap .
- 2 Tap the text field, then enter the numbers of the barcode.

NeoReader™ application menu overview

The following menu options are available in the NeoReader™ application:

-  Capture the barcode using a higher image resolution in cases where NeoReader™ does not recognise the barcode automatically
-  Enter the bar code numbers manually. This option can be used if your camera has difficulty reading the bar code
-  View a list of previously scanned bar codes
-  Select preferences for how you use the NeoReader™ application
-  View information about the NeoReader™ application
-  Read more about different bar code types, and about how to use NeoReader™
-  Select your personal settings, such as language or country. This information is used to personalise bar code content
-  Send a text message to invite a friend to download the NeoReader™ application

Synchronising data on your phone

You can sync contacts, email, calendar events, and other information with your phone from multiple email accounts, synchronisation services and other kinds of accounts, depending on the applications installed on your phone. Synchronising your phone with other information sources is an easy and practical way to stay up to date.

You can:

- access your Gmail™, Google Calendar™, Google™ contacts, Google™ Chrome™ bookmarks and other Google services you use.
- access your corporate email, contacts and calendar applications.
- access your Facebook™ contacts, calendar, albums and other services you use.
- synchronise your phone with an Internet server using SyncML™.



Synchronising with Google™

Synchronise your phone with different Google™ services to keep your information up to date, regardless of which device you're using your Google™ account from. For example, you can synchronise your contacts, Gmail™, calendar and web browser data.

To set up a Google™ account in your phone for automatic synchronisation

- 1 From your Home screen, tap .
- 2 Tap **Settings > Accounts & sync**.
- 3 Make sure that synchronisation is turned on so that applications can synchronise data automatically.
- 4 Tap **Add account > Google**.
- 5 Follow the registration wizard to create a Google™ account, or sign in if you already have an account.
- 6 Tap **Next**.
- 7 Tap your newly created Google™ account, then tap the items you want to synchronise.

To synchronise manually with your Google™ account

- 1 From the Home screen, tap .
- 2 Tap **Settings > Accounts & sync**.
- 3 Tap the Google™ account you want to synchronise.
- 4 Press , then tap **Sync now**.



To synchronise an application with a Google™ account

- 1 From your Home screen, tap .
- 2 Tap **Settings > Accounts & sync**.
- 3 Tap the Google™ account that you want to synchronise with. A list appears of applications that can be synchronised with the Google account.
- 4 Tap the application that you want to synchronise with the selected Google account.

To synchronise the web browser data with Google™ Chrome™

- 1 From your Home screen, tap .
- 2 Tap **Settings > Accounts & sync**.
- 3 Tap the Google™ account that you want to synchronise with, then tap **Sync Browser**.

To remove a Google™ account from your phone

- 1 From your Home screen, tap .
- 2 Tap **Settings > Accounts & sync**.
- 3 Tap the Google™ account you want to remove from the accounts list.
- 4 Press , then tap **Remove account**.
- 5 Tap **Remove account** again to confirm.

Synchronising your corporate email, calendar and contacts

Access your corporate email messages, calendar appointments and contacts directly from your phone. View and manage them just as easily as you would from a computer. After setup, you can find your information in the **Email, Calendar and Contacts** applications.

- ! For you to access the functionality described above, your corporate information must be stored on a Microsoft® Exchange server.

To set up corporate email, calendar and contacts in your phone

- 1 From your Home screen, tap .
- 2 Tap **Settings > Accounts & sync**.
- 3 Make sure that synchronisation is turned on so that your data synchronises automatically according to the sync interval you set.
- 4 Tap **Add account > Corporate**.
- 5 Enter your corporate email address and password.
- 6 Tap **Next**. Your phone begins to retrieve your account information. If a failure occurs, contact your corporate network administrator for more information such as the domain name and Exchange server address.
- 7 Tap **OK** to allow your corporate server to control your phone.
- 8 Select what data you want to sync with the phone, such as contacts and calendar entries.
- 9 If desired, activate the device administrator to allow your corporate server to control certain security features in your phone. For example, allow your corporate server to set password rules and set storage encryption.
- 10 When the setup is done, you can enter a name for the corporate account so that it can be easily identified.

To edit the setup of corporate email, calendar and contacts

- 1 From your Home screen, tap .
- 2 Tap **Settings > Accounts & sync** and select your corporate account.
- 3 Tap **Account settings**.
- 4 Change the settings to suit your needs. For example, you can decide:
 - how often the phone should check for new email messages.
 - to get your corporate calendar and contacts in your phone.
 - server settings in **Incoming settings**.

To set a synchronisation interval for a corporate account

- 1 From your Home screen, tap .
- 2 Tap **Settings > Accounts & sync** and select your corporate account.
- 3 Tap **Account settings**.
- 4 Tap **Inbox check frequency** and select an interval option.

To remove a corporate account from your phone

- 1 From your Home screen, tap .
- 2 Tap **Settings > Accounts & sync**, then tap your corporate account.
- 3 Tap **Remove account**.
- 4 Tap **Remove account** again to confirm.

Synchronising with Facebook™



There are two ways to use Facebook™ on your phone. You can use the standard Facebook application to access your online Facebook account, or you can synchronise your Facebook account with your phone and get direct access to Facebook content from a range of other applications. For example, you can make Facebook posts from Timescape™ and access your Facebook contacts, photos and calendar entries from related applications in the phone, such as the Calendar application. To synchronise your phone with Facebook, you must first set up a Facebook integration account -- a solution developed by Sony to enable easy integration.

To set up a Facebook™ integration account on your phone

- 1 From your Home screen, tap .
- 2 Tap **Settings > Accounts & sync**.
- 3 Make sure that synchronisation is turned on so that applications can synchronise data automatically.
- 4 Tap **Add account > Facebook inside Xperia™**.
- 5 Follow the on-screen instructions to create a Facebook™ integration account, or sign in if you already have an account.



 You can also set up a Facebook™ integration account on your phone by marking the **Facebook integration** checkbox under **Settings > Xperia™ > Facebook inside Xperia™**.

To synchronise manually with your Facebook™ integration account

- 1 From your Home screen, tap .
- 2 Tap **Settings > Accounts & sync**.
- 3 Tap the **Facebook inside Xperia™** account.
- 4 Press , then tap **Sync now**.

To remove a Facebook™ integration account from your phone



 When you remove a Facebook™ integration account from your phone, the associated online Facebook account is not deleted and you can still access it from a computer.

- 1 From your Home screen, tap .
- 2 Tap **Settings > Accounts & sync**.
- 3 Tap the **Facebook inside Xperia™** account.
- 4 Press , then tap **Remove account**.
- 5 Tap **Remove account** again to confirm.



Synchronising using SyncML™

Synchronise your phone with an Internet server using SyncML™. View and manage contacts, calendar and bookmarks from your phone just as easily as you would from a computer.

To set up a SyncML™ account in your phone

- 1 From your Home screen, tap .
 - 2 Find and tap **Settings > Accounts & sync**.
 - 3 Make sure that synchronisation is turned on so that your data synchronises automatically according to the interval you set.
 - 4 Tap **Add account > SyncML**.
 - 5 Tap the account, server address, username and password fields, and enter the information required.
 - 6 Tap **Sync interval** and select how often you want the phone to synchronise automatically.
 - 7 Tap an item that you want to synchronise, for example, contacts. Then enter the server address, username, and password. Repeat this step for each item you want to synchronise.
 - 8 When you're finished, tap **Done**.
-  Contact your SyncML™ service provider for more information about your account settings.

To synchronise manually with your SyncML™ account

- 1 From your Home screen, tap .
- 2 Tap **Settings > Accounts & sync**.
- 3 Tap the SyncML™ account that you want to synchronise.
- 4 Press , then tap **Sync now**.

To set a synchronisation interval

- 1 From your Home screen, tap .
- 2 Tap **Settings > Accounts & sync**, then tap your SyncML™ account.
- 3 Tap **Account settings**.
- 4 Tap **Sync interval** and select an interval option.

To remove a SyncML™ account from your phone

- 1 From your Home screen, tap .
- 2 Tap **Settings > Accounts & sync**, then tap your SyncML™ account.
- 3 Tap **Remove account**.
- 4 Tap **Remove account** again to confirm.

Connecting to wireless networks

You can access the Internet wirelessly from your phone using Wi-Fi® technology. This way you can browse the web and access cheaper call and data rates.

If your company or organisation has a virtual private network (VPN), you can connect to this network with your phone. You can use a VPN to access intranets and other internal services at your company.

Wi-Fi®

Using Wi-Fi® technology you can access the Internet wirelessly with your phone. To access the Internet using a Wi-Fi® connection, you first need to search for and connect to an available Wi-Fi® network. The signal strength of the Wi-Fi® network may differ depending on your phone's location. Moving closer to the Wi-Fi® access point may increase the signal strength.

Before using Wi-Fi®





To browse the Internet using a Wi-Fi® connection, you need to search for and connect to an available Wi-Fi® network and then open the Internet browser. The signal strength of the Wi-Fi® network may differ depending on your phone's location. Move closer to the Wi-Fi® access point to increase the signal strength.

To turn on Wi-Fi®

- 1 From your Home screen, tap .
- 2 Find and tap **Settings**.
- 3 Tap **OFF** beside **Wi-Fi** so that **OFF** changes to **ON**. The phone scans for available Wi-Fi® networks.

! It may take a few seconds before Wi-Fi® is enabled.

To connect to a Wi-Fi® network

- 1 From the Home screen, tap .
- 2 Find and tap **Settings**.
- 3 Make sure that the Wi-Fi® function is on. Tap **Wi-Fi**.
- 4 Available Wi-Fi® networks are displayed. The available networks may be open or secured. Open networks are indicated by  and secured networks are indicated by  next to the Wi-Fi® network name.
- 5 Tap a Wi-Fi® network to connect to it. If you are trying to connect to a secure Wi-Fi® network, you are asked to enter a password.  is displayed in the status bar once you are connected.

! Your phone remembers Wi-Fi® networks you connect to. The next time you come within reach of a previously connected Wi-Fi® network, your phone automatically connects to it.

💡 In some locations, open Wi-Fi® networks require you to log in to a web page before you can get access to the network. Contact the relevant Wi-Fi® network administrator for more information.

To connect to another Wi-Fi® network

- 1 From your Home screen, tap .
- 2 Find and tap **Settings** > **Wi-Fi**. Detected Wi-Fi® networks are displayed.
- 3 Tap another Wi-Fi® network to connect to it.

To scan for Wi-Fi® networks manually

- 1 From your Home screen, tap .
- 2 Find and tap **Settings** > **Wi-Fi**.
- 3 Tap **Scan**. The phone scans for Wi-Fi® networks and displays available networks in a list.
- 4 Tap a Wi-Fi® network in the list to connect to it.



Advanced Wi-Fi® settings

Before you add a Wi-Fi® network manually, you need to turn on the Wi-Fi® setting in your phone.

Wi-Fi® network status

When you are connected to a Wi-Fi® network or when there are Wi-Fi® networks available in your vicinity, it is possible to see the status of these Wi-Fi® networks. You can also enable the phone to notify you whenever an open Wi-Fi® network is detected.

To enable Wi-Fi® network notifications

- 1 Turn on Wi-Fi®, if it is not already on.
- 2 From your Home screen, tap .
- 3 Find and tap **Settings > Wi-Fi**.
- 4 Press .
- 5 Tap **Advanced**.
- 6 Mark the **Network notification** checkbox.

To add a Wi-Fi® network manually

- 1 From the Home screen, tap .
- 2 Find and tap **Settings > Wi-Fi**.
- 3 Tap **Add network**.
- 4 Enter the **Network SSID** for the network.
- 5 Tap the **Security** field to select a security type.
- 6 If required, enter a password.
- 7 Tap **Save**.

! Contact your Wi-Fi® network administrator to get the Network SSID name and password.

To view detailed information about a connected Wi-Fi® network



- 1 From the Home screen, tap .
- 2 Find and tap **Settings > Wi-Fi**.
- 3 Tap the Wi-Fi® network that you are currently connected to. Detailed network information is displayed.

Wi-Fi® sleep policy

By adding a Wi-Fi® sleep policy, you can specify when to switch from Wi-Fi to mobile data.

! If you are not connected to a Wi-Fi® network, the phone uses mobile data connection to access the Internet (if you have set up and enabled a mobile data connection in your phone).

To add a Wi-Fi® sleep policy

- 1 From the Home screen, tap .
- 2 Find and tap **Settings > Wi-Fi**.
- 3 Press .
- 4 Tap **Advanced**.
- 5 Tap **Keep Wi-Fi on during sleep**.
- 6 Select an option.

Sharing your phone's mobile data connection

You can share your phone's mobile data connection with a single computer using a USB cable. This process is called USB tethering. You can also share your phone's data connection with up to eight devices at once, by turning your phone into a portable Wi-Fi® hotspot.

When your phone is sharing its data connection, the following icons may appear in the status bar or in the Notification panel:



USB tethering is active



Portable Wi-Fi® hotspot is active



Both USB tethering and portable hotspot are active

To share your phone's data connection using a USB cable

- 1 Deactivate all USB cable connections to your phone.
- 2 Using the USB cable that came with your phone, connect your phone to a computer.
- 3 From your Home screen, tap .
- 4 Find and tap **Settings** > **More...** > **Tethering & portable hotspot**.
- 5 Mark the **USB tethering** checkbox. The phone starts sharing its mobile network data connection with the computer over the USB connection. An ongoing notification appears in the status bar and the Notification panel.
- 6 Unmark the **USB tethering** checkbox, or disconnect the USB cable to stop sharing your data connection.

! You cannot share your phone's data connection and SD card over a USB cable at the same time. For more information, see *Connecting your phone to a computer* on page 107.

💡 You may need to prepare your computer to establish a network connection via USB cable. Go to android.com/tether to get the most current information.

To share your phone's data connection as a portable Wi-Fi® hotspot

- 1 From the Home screen, tap .
- 2 Find and tap **Settings** > **More...** > **Tethering & portable hotspot**.
- 3 Tap **Configure Wi-Fi hotspot**.
- 4 Enter the **Network SSID** for the network. Tap the **Security** field to select a security type.
- 5 If required, enter a password.
- 6 Tap **Save**.
- 7 Mark the **Portable Wi-Fi hotspot** checkbox. The phone starts broadcasting its Wi-Fi® network name (SSID). You can now connect to this network with up to 8 computers or other devices.
- 8 Unmark the **Portable Wi-Fi hotspot** checkbox when you want to stop sharing your data connection via Wi-Fi®.

To rename or secure your portable hotspot

- 1 From the Home screen, tap .
- 2 Find and tap **Settings** > **More...** > **Tethering & portable hotspot**.
- 3 Tap **Configure Wi-Fi hotspot**.
- 4 Enter the **Network SSID** for the network.
- 5 To select a security type, tap the **Security** field.
- 6 If required, enter a password.
- 7 Tap **Save**.

Virtual private networks (VPNs)

Use your phone to connect to virtual private networks (VPNs), which allow you to access resources inside a secured local network from outside the actual network. For example, VPN connections are commonly used by corporations and educational institutions for users who need to access intranets and other internal services when they are outside of the internal network, for example, when they are travelling.

VPN connections can be set up in many ways, depending on the network. Some networks may require you to transfer and install a security certificate in your phone. See *Connecting your phone to a computer* on page 107 for more information on how to transfer content to your phone. For detailed information on how to set up a connection to your virtual private network, please contact the network administrator of your company or organisation.

To add a virtual private network

- 1 From your Home screen, tap .
- 2 Find and tap **Settings > More... > VPN**.
- 3 Tap **Add VPN network**.
- 4 Select the type of VPN to add.
- 5 Enter your VPN settings.
- 6 Tap **Save**.

To connect to a virtual private network

- 1 From your Home screen, tap .
- 2 Find and tap **Settings > More... > VPN**.
- 3 In the list of available networks, tap the VPN that you want to connect to.
- 4 Enter the required information.
- 5 Tap **Connect**.

To disconnect from a virtual private network

- 1 Drag the status bar downwards.
- 2 Tap the notification for the VPN connection to turn it off.

Web browser

Use your web browser to view and navigate web pages, add pages as bookmarks, and save pages for offline viewing. You can open up to 16 windows at the same time and switch among them easily. You can also request the desktop version of a web page if you don't want to view the mobile version.

To open the web browser

- 1 From your Home screen, tap .
- 2 Find and tap .

Browsing the web

Search and address bar

Use the search and address bar to browse the web.



- 1 View the download progress of the current web page
- 2 Enter a search word to search for a web page, or enter a web page address to load a web page
- 3 Cancel the download of the current web page

 Sometimes the search and address bar is not displayed after a web page finishes downloading. It appears again if you flick downwards on the screen.



To go to a web page

- 1 Tap the search and address text field to activate the keypad.
- 2 Enter a web address.
- 3 Tap **Go**.

To search a web page

- 1 Tap the search and address text field to activate the keypad.
- 2 Enter a search word.
- 3 Tap **Go**.

To exit the web browser

- While browsing, press .
-  When you open the browser again, even after restarting the phone, the browser appears exactly as it did before you exited. For example, the same number of windows will be open.

Navigating web pages

To select a link

- To select a link in a web page, tap the link. The selected link gets highlighted, and the web page starts to load after you release your finger.
-  If you select a link by mistake before releasing your finger, you can drag your finger away from the link to deselect it.

To go to the previous page while browsing

- Press .

To zoom in or out on a web page

Use one of the following methods to zoom in or out on a web page:

- Double-tap to zoom in on the web page, or double-tap again to zoom out.
- Touch an area of the page with two fingers at once and spread them apart to zoom in, or pinch them together to zoom out.



To reload the current web page

- Press , then tap **Refresh**.

To save a web page for offline viewing

- 1 After the web page has loaded, press .
- 2 Tap **Save for offline reading**. You are then directed to the **Saved pages** tab, where you can view all saved web pages.



To view a previously saved web page

- 1 When the browser is open, flick downwards on the screen to make the search and address bar appear.
- 2 Tap  next to the search and address bar.
- 3 Tap , then tap the **Saved pages** tab.
- 4 Find and select a web page that you want to view.

To load the live version of an offline web page

- 1 When an offline web page is open, press .
- 2 Tap **Go live**.



To request the desktop version of a web page

- 1 While browsing the web page, press .
 - 2 Tap **Request desktop site**.
-  Once you choose to view the desktop version of a web page in a window, any other web pages that you view later in the same window will also show their desktop versions. Tap **Request desktop site** again to change the setting back.

To share a link to the current web page

- 1 While browsing, press .
- 2 Tap **Share page**.
- 3 Select an available transfer method, then follow the on-screen instructions.

To close a browser window

- 1 When the browser is open, flick downwards on the screen to make the search and address bar appear.
- 2 Tap  next to the search and address bar. A list of all open windows appears.
- 3 Tap  in the window you want to close, or flick the window left or right off the screen to close it.

Managing bookmarks



Bookmarks let you access your favourite and frequently visited web pages quickly. You can add bookmarks directly from your phone browser. You can also synchronise your phone browser with Google Chrome™ bookmarks that you have synchronised to your Google account using a computer. See *To synchronise the web browser data with Google™ Chrome™* on page 62.

Depending on your network operator, some bookmarks may be pre-installed on your phone.



To bookmark a web page

- 1 While you are viewing the web page, press .
- 2 Tap **Save to bookmarks**.
- 3 If desired, edit the bookmark.
- 4 When you're done, tap **OK**.



To open a bookmark

- 1 When the browser is open, flick downwards on the screen to make the search and address bar appear.
- 2 Tap  next to the search and address bar, then tap . The names of any accounts that you have synchronised with Google Chrome™ are displayed. Bookmarks that you have saved directly on the phone are listed under the **Local** account.
- 3 To show an account's bookmarks, tap the account. All bookmarks in the account are displayed.
- 4 To open a bookmark, tap it.



To edit a bookmark

- 1 When the browser is open, flick downwards on the screen to make the search and address bar appear.
- 2 Tap  next to the search and address bar, then tap .
- 3 Touch and hold a bookmark.
- 4 In the menu that appears, tap **Edit bookmark**.
- 5 Edit the bookmark as desired.
- 6 When you're done, tap **OK**.



To add a bookmarked web page to your Home screen

- 1 When the browser is open, flick downwards on the screen to make the search and address bar appear.
- 2 Tap  next to the search and address bar, then tap .
- 3 Tap and hold a bookmark that you want to add to your Home screen.
- 4 In the menu that appears, tap **Add shortcut to home**.

To delete a bookmark



- 1 When the browser is open, flick downwards on the screen to make the search and address bar appear.
- 2 Tap  next to the search and address bar, then tap .
- 3 Touch and hold a bookmark.
- 4 In the menu that appears, tap **Delete bookmark** to delete the selected bookmark.

To bookmark a previously visited web page

- 1 When the browser is open, flick downwards on the screen to make the search and address bar appear.
- 2 Tap  next to the search and address bar, then tap .
- 3 Tap the **History** tab, then tap one of the down arrows to view a list of previously visited web pages.
- 4 Tap  beside the web page that you want to add as a bookmark.
- 5 If desired, edit more detailed information such as the name and location of the bookmark.
- 6 When you're done, tap **OK**.

Managing text and images

To find text within a web page

- 1 When you are viewing a web page, press .
- 2 Tap **Find on page**.
- 3 Enter your search text. Characters that match your search get highlighted on the web page.
- 4 Tap the up or down arrows to go to the previous or next highlighted item.
- 5 Tap  to close the search bar.

To copy text from a web page

- 1 Touch and hold part of the text you want to copy until it becomes highlighted. Tabs appear at each end of the selection. Drag the tabs accordingly to select all the text that you want to copy.
 - 2 Tap , then tap **Copy**.
 - 3 To paste text into an email, text message or multimedia message, touch and hold the text field in the relevant application and tap **Paste** in the menu that appears.
- ! If the text that you want to copy is part of a link to another web page, a menu appears in which you need to tap **Select text** before you can continue.



To save an image from a web page

- 1 On the active web page, touch and hold the desired image until a menu appears.
 - 2 Tap **Save image**.
 - 3 If an SD card is inserted, you can select where you want to save the image. Select a location. If you prefer to making the current download setting the default setting, mark the **Set as default download memory** checkbox.
- ! If both the internal storage and the SD card are unavailable, the image cannot be saved.



Multiple windows

Your browser can run up to 16 different windows at the same time. You can, for example, log in to your webmail in one window and read the daily news in another. You can easily switch from one window to another. If you want to browse the web with more privacy, you can use the incognito tab to open a window that saves no personal information or cookies while you're connected through it.

To open a new browser window

- 1 When the browser is open, flick downwards on the screen to make the search and address bar appear.
- 2 Tap  next to the search and address bar, then tap .

To open an incognito window

- 1 When the browser is open, flick downwards on the screen to make the search and address bar appear.
- 2 Tap  next to the search and address bar.
- 3 Press , then tap **New incognito tab**.

To open a link in a new browser window

- 1 Touch and hold a link until a menu appears.
- 2 Tap **Open in new tab**.

To switch between browser windows

- 1 When the browser is open, flick downwards on the screen to make the search and address bar appear.
- 2 Tap  next to the search and address bar.
- 3 Scroll up and down to browse a list of all open windows.
- 4 Tap the window that you want to switch to.

Downloading from the web

You can download applications and content when you browse the web using the web browser in your phone. Usually you have to touch a download link for the desired file and the download then starts automatically.

To view your downloaded files

- 1 From your Home screen, tap .
- 2 Find and tap .

To cancel an ongoing download

- 1 When your phone starts downloading a file, drag down the status bar and tap the file you are downloading.
- 2 Mark the checkbox beside the downloading file that you want to cancel.
- 3 Tap .

Browser settings

You can change the browser settings and customise your browser view. For example, you can change the size of the text displayed to suit your needs, or you can clear cache, cookies, browser history, and other data linked to the websites you visit.

To change your browser settings

- 1 When the browser is open, press .
- 2 Tap **Settings**.

To change the text size on web pages

- 1 When the browser is open, press .
- 2 Tap **Settings > Accessibility**.
- 3 Adjust the text size settings as desired.

To clear the cache memory from your phone

- 1 When the browser is open, press .
- 2 Tap **Settings > Privacy & security**.
- 3 Tap **Clear cache**, then tap **OK** to confirm.

To clear your browser cookies

- 1 When the browser is open, press .
- 2 Tap **Settings > Privacy & security**.
- 3 Tap **Clear all cookie data**, then tap **OK** to confirm.

To clear your browser history

- 1 When the browser is open, press .
- 2 Tap **Settings > Privacy & security**.
- 3 Tap **Clear history**, then tap **OK** to confirm.

Auto-fitting web pages

Your browser has an auto-fit option which makes it easier to read large web pages with lots of text and images, such as news pages. When this option is enabled, your browser automatically refits images and columns of text on the screen when you

double-tap the screen directly after zooming with your fingers. If auto-fit is disabled, you may need to scroll sideways to read a full sentence.

To auto-fit web pages

- 1 When the browser is open, press .
- 2 Tap **Settings** > **Advanced** > **Auto-fit pages**.

Auto-filling text

Auto-filling allows you to automatically enter data such as names and addresses on various web forms, so you don't have to enter the same information repeatedly on different web pages.



To create text for auto-filling

- 1 When the browser is open, press .
- 2 Tap **Settings** > **General**.
- 3 Mark the **Form auto-fill** checkbox, if it is not already marked.
- 4 Tap **Auto-fill text**, then enter text that you want to use for auto-filling on web forms, for example, your name and address.
- 5 When you're done, tap **Save**.

Plug-in settings

You can adjust how a plug-in functions on a web page. For example, you can enable plug-ins to get optimal visual effect when you view a web page. Alternatively, to increase browsing speed, you can configure your browser to only run plug-ins on demand, or you can disable plug-ins completely.

To enable plug-ins on demand

- 1 When the browser is open, press .
 - 2 Tap **Settings** > **Advanced** > **Enable plug-ins**.
 - 3 Tap **On demand**.
-  You may need to restart your browser for the setting to take effect.

Music

Get the most out of your music player. Listen to and organise music, audio books and podcasts that you have transferred to your memory card from a computer, or purchased and downloaded from online stores.

To make content easily available to the music player, you can use the Media Go™ application. Media Go™ helps transfer music content between a computer and a phone. For more information, see *Connecting your phone to a computer* on page 107.

Protecting your hearing

Listening to the music player or other media players at excessive volume or for a prolonged period of time can damage your hearing, even when the volume is at a moderate level. To alert you to such risks, a volume level warning appears when the volume is too high, and after the music player is used for over 20 hours.

To turn off the volume level warning

- When  appears, tap OK to dismiss the warning.
- 💡 Every time you restart your phone, the media volume is automatically set to moderate level.

Copying media files to your memory card

Copy all your favourite media content from computer to phone and start using your phone's entertainment features to the full. It's easy to transfer music, photos, videos and other files. Just connect your phone to a computer with a USB cable and use either the computer's file manager application or the Media Go™ application to transfer your files.

See *Connecting your phone to a computer* on page 107 for more general information about connecting your phone to a computer and transferring files.

Using the music player

Music player overview

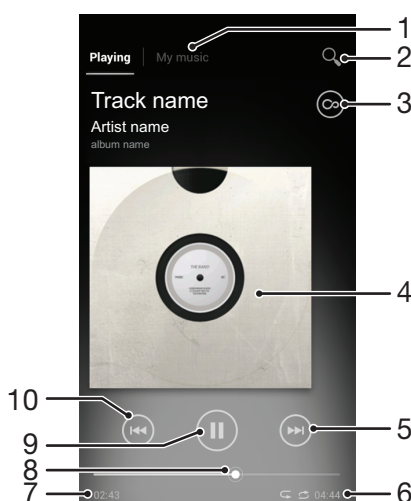

- 1 Browse the music on your memory card
- 2 Search all tracks saved to your phone's internal storage
- 3 Tap the infinite button to find related information online and plug-ins on Google Play™

- 4 Album art (if available)
- 5 Go to the next track in the current play queue, or fast forward
- 6 Total time length of the track
- 7 Elapsed time of current track
- 8 Progress indicator – drag the indicator or tap along the line to fast forward or rewind
- 9 Play/Pause button
- 10 Go to the previous track in the current play queue, or rewind



To change tracks

- When a track is playing, tap  or .
- When a track is playing, swipe the album art left or right.

To pause a track

- In the music player, tap .



To fast forward and rewind music

- In the music player, touch and hold  or .
- 💡 You can also drag the progress indicator marker right or left.



To adjust the audio volume

- When the music player is playing a track, press the volume key.

To improve the sound quality using the equalizer

- 1 When the music player is open, press .
- 2 Tap **Sound enhancements**.
- 3 If you want to adjust the sound manually, drag the frequency band buttons up or down. If you prefer to adjust the sound automatically, tap  and select a style.



To turn on the Surround sound

- 1 When the music player is open, press .
- 2 Tap **Sound enhancements** >  > **More** > **Headphone surround**.
- 3 Select a setting.
- 4 Tap **OK**.



To view the current play queue

- While a track is playing in the music player, tap the album art and then tap .

To minimise the music player

- When the music player is playing, press  to go to the previous screen, or press  to go to the Home screen. The music player stays playing in the background.

To return to the music player when it is playing in the background

- 1 While a track is playing in the background, drag the status bar downwards to open the Notification panel.
 - 2 Tap the track title to open the music player.
- 💡 Alternatively, you can press and hold  and then tap  to return to the music player.

To delete a track

- 1 Open the music player library and browse to the track you want to delete.
 - 2 Touch and hold the track title, then tap **Delete**.
- 💡 You can also delete albums this way.

To share a track

- 1 When browsing your tracks in the music player library, touch and hold a track title.
- 2 Tap **Send**.
- 3 Select an available transfer method, and follow the on-screen instructions.

💡 You can also share albums and playlists this way.

⚠️ You might not be able to copy, send or transfer copyright-protected items.

To recommend a track on Facebook™

- 1 While the track is playing in the music player, tap the album art.
- 2 Tap  to show that you "Like" the track on Facebook™. If desired, add a comment in the comments field.
- 3 Tap **Share** to send the track to Facebook™. If the track is received successfully, you will get a confirmation message from Facebook™.

Discovering related audio content

In the music player, you can discover audio content that is related to the artist you are listening to by tapping the infinite button .

You can also search for audio content related to a particular artist while you are browsing the music player. The music player searches for and lists the following types of results:

- Music videos on YouTube™
- Artist info on Wikipedia™
- Lyrics on Google
- Karaoke videos on YouTube™
- Extension searches on the web
- Content from the PlayNow™ service

To search for related content using the infinite button

- When a track is playing in the music player, tap .

Overview of My music

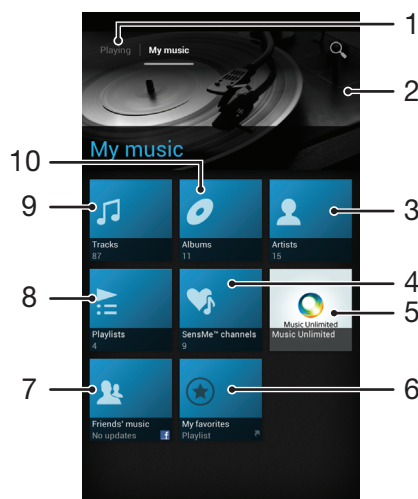





- 1 Go back to the current track in the music track
- 2 Picture of the currently playing artist (if available)
- 3 Browse your music by artist
- 4 Categorise your music using SensMe™ channels
- 5 Manage and edit your music using Music Unlimited™

- 6 Browse your favorite playlists
- 7 Collect links to music and music-related content that you and your friends have shared using online services
- 8 Browse all playlists
- 9 Browse audio by track
- 10 Browse by album

Using My music to organise your tracks

Tap the My Music tab in the Music player to get an overview of all the tracks you've saved to your phone's memory card. In My Music you can manage your albums and playlists, create shortcuts, and arrange music by mood and tempo.

To add a music track as a shortcut

- 1 In the music player, tap **MY MUSIC**.
- 2 Tap , ,  or , then browse to the track that you want to save as a shortcut.
- 3 Touch and hold the track title.
- 4 Tap **Add as shortcut**. The shortcut now appears in the My music main view.

To rearrange shortcuts

- 1 In the music player, tap **MY MUSIC**.
- 2 Touch and hold a shortcut until it magnifies and the phone vibrates, then drag the item to a new location.

To delete a shortcut

- 1 In the music player, tap **MY MUSIC**.
- 2 Touch and hold a shortcut until it magnifies and the phone vibrates, then drag the item to .

! You can't delete the following tabs: **Tracks**, **Albums**, **Artists**, **Playlists**, **Music Unlimited**, **Friends' music** and **SensMe™ channels**.

To update your music with the latest information

- 1 In the music player, tap **MY MUSIC**, then press .
- 2 Tap **Download music info > Start**. Your phone searches online and downloads the latest available album art and track information for your music.

💡 The SensMe™ channels application gets activated when you download music information.

Categorising your music using SensMe™ channels

The SensMe™ channels application helps you arrange your music by mood and tempo. SensMe™ groups all your tracks into twelve categories, or channels, so you can select music that matches your mood or suits the time of day.

To enable the SensMe™ channels application



- 1 In the music player, tap **MY MUSIC**.
- 2 Press , then tap **Download music info**.

! This application requires a mobile or Wi-Fi® network connection.

Playing music in random order

You can play tracks in playlists in random order. A playlist can be, for example, a playlist you have created yourself or an album.

To play tracks in random order

- 1 In the music player, tap **MY MUSIC**.
- 2 Tap  and navigate to an album, or tap  and browse to a playlist.
- 3 Open the album or playlist by tapping its name.
- 4 Tap  to turn on **Shuffle mode**.

Playlists

The music player automatically creates Smart playlists on the playlist tab  in the music player library. You can also create your own playlists from the music that is saved on your memory card.

In addition, you can install the Media Go™ application on a computer and use it to copy playlists from the computer to your phone's memory card. For more information, see *Connecting your phone to a computer* on page 107.

To create your own playlists

- 1 In the music player, tap **MY MUSIC**.
- 2 To add an artist, album or a track to a playlist, touch and hold the name of the artist or the title of the album or track.
- 3 In the menu that opens, tap **Add to playlist > Create new playlist**.
- 4 Enter a name for the playlist and tap **OK**.

To add tracks to a playlist

- 1 When browsing the music player library, touch and hold the name of the artist or the title of the album or track you want to add.
- 2 Tap **Add to playlist**.
- 3 Tap the name of the playlist to which you want to add the artist, album or track. The artist, album or track is added to the playlist.

To play your own playlists

- 1 In the music player, tap **MY MUSIC**.
- 2 Tap .
- 3 Under **Playlists**, tap a playlist.
- 4 Tap a track to play it.

To remove a track from a playlist

- 1 In a playlist, touch and hold the title of the track you want to delete.
- 2 Tap **Delete from playlist**.

To delete a playlist



- 1 In the music player, tap **MY MUSIC**, then select **Playlists**.
- 2 Touch and hold the playlist you want to delete.
- 3 Tap **Delete**.
- 4 Tap **Delete** again to confirm.

! You cannot delete default playlists.

Music player widget

The music player widget is a miniature application that gives you direct access to the music player from your Home screen. You need to add this widget to your Home screen before you can use it.

To add the music player widget to your Home screen

- 1 From your Home screen, press .
- 2 Tap .
- 3 Find and tap **Music player**.

Identifying music using TrackID technology



Use the TrackID™ music recognition service to identify a music track you hear playing in your surroundings. Just record a short sample of the song and you'll get artist, title and album info within seconds. You can purchase tracks identified by TrackID™ and you can view TrackID charts to see what TrackID users around the globe are searching for. For best results, use TrackID™ technology in a quiet area. If you have problems using this application, see *I cannot use Internet-based services* on page 126.

- ! The TrackID™ application and the TrackID™ service are not supported in all countries/regions, or by all networks and/or service providers in all areas.

To open the TrackID™ application

- 1 From your Home screen, tap .
 - 2 Find and tap **TrackID™**.
- 💡 You can also use the TrackID™ widget to open the TrackID™ application.

To search for track information using TrackID™

- 1 When the TrackID™ application is open, hold the phone towards the music source.
 - 2 Tap . If the track is recognised by the TrackID™ service, the results appear on the screen.
- 💡 To return to the TrackID™ start screen, press .

To view TrackID™ charts

- 1 When the TrackID™ application is open, tap **Charts**. The first time you view a chart, it is set to your own region.
- 2 To see charts of the most popular searches in other regions, tap  >
- 3 Select a country or region.

Using TrackID™ technology results

Track information appears when the TrackID™ application recognises a track. You can choose to purchase the track, recommend it on Facebook™, or share it using email, Bluetooth or SMS. You can also get more information about the track's artist, or search for related track content on YouTube™.

To buy a track using TrackID™ technology

- 1 When the TrackID™ application is open, tap a track title.
 - 2 In the track information screen, tap **Download**.
 - 3 Follow the instructions in your phone to complete your purchase.
- ! The track purchase feature may not be supported in all countries/regions, or by all networks and/or service providers in all areas.

To share a track using email or SMS

- 1 When the TrackID™ application is open, tap a track title.
- 2 Select a sharing method.
- 3 Follow the instructions in your phone to complete the procedure.

To view the artist information for a track

- 1 When the TrackID™ application is open, tap a track title.
- 2 Tap **Artist info**.

To delete a track from the track history

- 1 When the **TrackID™** application is open, tap **History**.
- 2 Tap a track title, then tap **Delete**.
- 3 Tap **Yes**.

Using the FM radio

The FM radio in your phone works like any FM radio. For example, you can browse and listen to FM radio stations and save them as favourites. You must connect a wired headset or headphones to the phone before you can use the radio. This is because the headset or headphones act as an antenna. After one of these devices is connected, you can then switch the radio sound to the phone speaker, if desired.

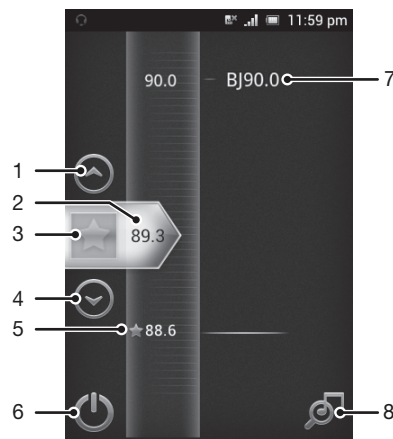

- 💡 When you open the FM radio, available channels appear automatically. If a channel has RDS information, it appears a few seconds after you start listening to the channel.

FM radio overview



- 1 Move upwards to the previous favourite (available when favourites are saved)
- 2 The tuned frequency
- 3 Save or remove a channel as a favourite
- 4 Move downwards to the next favourite (available when favourites are saved)
- 5 A saved favourite channel
- 6 Radio on/off key
- 7 RDS (Radio Data System) information – not available in all countries/regions
- 8 Open the TrackID™ application

To start the FM radio

- 1 Connect a headset or a set of headphones to your phone.
- 2 From your Home screen, tap .
- 3 Find and tap **FM radio** . The available channels appear as you scroll through the frequency band.

- ! When you start the FM radio, available channels appear automatically. If a channel has RDS information, it appears a few seconds after you start listening to the channel.

To move between radio channels

- Flick your finger up or down along the frequency band.

Using your favourite radio channels

You can save the radio channels you most frequently listen to as favourites. By using favourites you can quickly return to a radio channel.



To save a channel as a favourite

- 1 When the radio is open, navigate to the channel that you want to save as a favourite.
- 2 Tap .

To remove a channel as a favourite

- 1 When the radio is open, navigate to the channel that you want to remove as a favourite.
- 2 Tap .

To move between favourite channels

- When the radio is open, tap  or .
- ! To move between favourites, you need to save at least two channels as favourites.

Making a new search for radio channels

If you have moved to a new location or the reception has improved in your current location, you can start a new scan for radio channels.

- ! Any favourites you have saved are not affected by a new scan.



To start a new search for radio channels

- 1 When the radio is open, press .
- 2 Tap **Search for channels**. The radio scans the whole frequency band, and all available channels are displayed.

Switching the radio sound between devices

You can listen to the radio through a wired headset or through wired headphones. Once either device is connected, you can switch the sound to the phone speaker, if desired.



To switch the radio sound to the phone speaker

- 1 When the radio is open, press .
 - 2 Tap **Play in speaker**.
- 💡 To switch the sound back to the wired headset or headphones, press  and tap **Play in headphones**.

Identifying radio tracks using TrackID™

Use TrackID™ technology to identify music tracks as they play on your phone's FM radio.



To identify a song on the FM radio using TrackID™

- 1 While the song is playing on your phone's FM radio, tap .
 - 2 A progress indicator appears while the TrackID™ application samples the song. If successful, you are presented with a track result, or a list of possible tracks.
 - 3 Press  to return the FM Radio.
- ! The TrackID™ application and the TrackID™ service are not supported in all countries/regions, or by all networks and/or service providers in all areas.

Sharing the details of music you like on Facebook™

When you listen to music using the FM Radio, you can share details of tracks you like on Facebook. You need to be a Facebook user and must be logged in to Facebook.

To share details of music you like on Facebook™

- 1 When the FM radio is playing a music track that you want to share, find and tap .
 - 2 Add a comment in the comment field, if desired.
 - 3 Tap **Share** to send details of the track to **Facebook**.
 - 4 Tap **Cancel** to return to the **FM radio** application.
 - 5 Once you have posted a track to your **Facebook** account, a confirmation message appears on the FM radio screen.
- !  will not appear on the FM radio screen if you are not logged in to **Facebook**.

Taking photos and recording videos

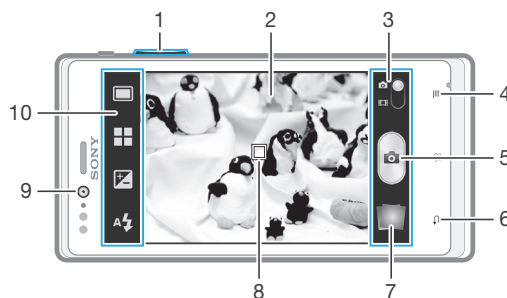

Take a photo or record a video with the camera in your phone. You can hold the camera horizontally or vertically. Use the front camera to take self-portraits. Photos and videos are saved automatically on the memory card. Share a photo or a video with friends, or upload your photos and videos to a web service.

Camera controls overview



- 1 Zoom in or out
- 2 Main camera screen
- 3 Switch between still and video camera
- 4 Display all settings
- 5 Take photos or record video clips
- 6 Go back a step or exit the camera
- 7 View photos and videos
- 8 Auto focus
- 9 Front camera
- 10 Camera setting icons

To open the camera

- From your Home screen, tap , then find and tap .





To close the camera

- Press  from the main camera screen.





Using the still camera

There are two ways to take photos with the still camera. You can tap the on-screen camera button, or touch a spot on the screen.



To take a photo by touching the screen

- 1 Activate the camera.
 - 2 If the still camera is not selected, drag  to .
 - 3 To display all settings, press .
 - 4 Tap **Capturing method** and select **Touch capture** if it is not already selected.
 - 5 Point the camera towards the subject.
 - 6 To activate auto focus, touch and hold a spot on the screen. When the focus frame turns green, lift your finger to take the photo.
- ! Be careful not to touch ,  or other icons when touching the screen to take a photo.

To take a photo by tapping the on-screen button

- 1 Activate the camera.
- 2 If the still camera is not selected, drag  to .
- 3 To display all settings, press .
- 4 Tap **Capturing method** and select **On-screen button** if it is not already selected.
- 5 Point the camera towards the subject.
- 6 Tap the on-screen button . The photo is taken as soon as you release your finger.

To take a self-portrait using the front camera

- 1 Activate the camera.
- 2 If the still camera is not selected, drag  to .
- 3 Tap the icon on the top left of the screen, then select **Front camera**.
- 4 To display all settings, press .
- 5 To take the photo, tap the screen. The photo is taken as soon as you release your finger.

To use the zoom function

- When the camera is open, press the volume key up or down to zoom in or out.
- ! The zoom is not available for all picture resolutions.



To use the still camera flash

- 1 When the camera is open, press .
- 2 Tap **Flash**, and select your desired flash setting.
- 3 Take the photo.

To view your photos and videos



- 1 Open the camera, then tap a thumbnail at the bottom of the screen to open a photo or video.
 - 2 Flick left or right to view your photos and videos. Videos are identified by .
- 💡 In step 1, you can also flick the thumbnails from right to left and then select the one you want to view.

To delete a photo





- 1 Open the photo you want to delete.
 - 2 Press , and then tap .
- 💡 To delete a recently taken photo or video, you can also flick the thumbnail at the bottom right of the viewfinder and then press and hold the item you want to delete.

Adding the geographical position to your photos

Turn on geotagging to add the approximate geographical location (a geotag) to photos when you take them. The geographical location is determined either by wireless networks (mobile or Wi-Fi® networks) or GPS technology.



When  appears on the camera screen, geotagging is turned on but the geographical position has not been found. When  appears, geotagging is turned on and the geographical location is available, so your photo can get geotagged. When neither of these two symbols appears, geotagging is turned off.

To turn on geotagging



- 1 Activate the camera.
- 2 If the still camera is not selected, drag  to .
- 3 Press , then tap **Geotagging > On**.
- 4 Tap **OK** to agree to enable GPS and/or wireless networks.
- 5 Check the options you want to select under **Location services**.
- 6 After you confirm your settings, press  to return to the camera screen.
- 7 If  appears on the camera screen, your location is available and your photo can get geotagged. If not, check your GPS and/or wireless network connection.

Using still camera settings

To adjust the still camera settings

- 1 Activate the camera.
- 2 If the still camera is not selected, drag  to .
- 3 Tap one of the settings icons on the left of the screen.
- 4 To display all settings, press .
- 5 Select the setting you want to adjust, then edit as desired.

To customise the still camera settings panel

- 1 When the camera is open, press  to display all settings.
 - 2 Touch and hold the setting you want to move and drag it to the desired position.
-  If you drag the setting outside of the settings panel, the change is cancelled.

Still camera settings overview



Normal



Front camera

Select the front camera if you want to take self-portrait photos.



Sweep Panorama

Use this setting to take wide-angle, panoramic photos. Just tap the screen and move the camera steadily from one side to the other.

Focus mode

The focus function controls which part of a photo should be sharp. When continuous autofocus is on, the camera keeps adjusting focus so that the area within the white focus frame stays sharp.



Single auto focus

The camera automatically focuses on the selected subject. Continuous autofocus is on. Touch and hold the camera screen until the white focus frame turns green, indicating that the focus is set. The photo is taken when you release your finger.



Infinity

Use when taking photos from a distance. Focus is set on subjects far away. Subjects close to the camera may be blurred. Continuous autofocus is off.



Touch focus

Touch a specific area on the camera screen to set the area of focus. Continuous autofocus is off. Touch and hold the camera screen until the white focus frame turns green, indicating that the focus is set. The photo is taken when you release your finger.

-  This setting is only available in **Normal** capturing mode.

Exposure value

 Determine the amount of light in the photo you want to take. A higher value indicates an increased amount of light.

! This setting is only available in **Normal** capturing mode.

Metering

This function automatically determines a well-balanced exposure by measuring the amount of light striking the image you want to capture.

 **Centre**
Adjust the exposure to the centre of the image.

 **Average**
Calculate the exposure based on the amount of light striking the whole image.

 **Spot**
Adjust the exposure in a very small part of image you want to capture.

! This setting is only available in **Normal** capturing mode.

White balance

The white balance setting adjusts the colour balance according to the lighting conditions.

 **Auto**
Adjust the colour balance automatically to the lighting conditions.

 **Incandescent**
Adjusts the colour balance for warm lighting conditions, such as under light bulbs.

 **Fluorescent**
Adjust the colour balance for fluorescent lighting.

 **Daylight**
Adjust the colour balance for sunny outdoor conditions.

 **Cloudy**
Adjust the colour balance for a cloudy sky.

! This setting is only available in **Normal** capturing mode.

Scenes

Use the Scenes feature to quickly set up the camera for common situations using pre-programmed scenes. The camera determines a number of settings for you to fit the selected scene, ensuring the best possible photo.

 **Off**
The Scenes feature is off and photos can be taken manually.

 **Landscape**
Use for landscape photos. The camera focuses on distant objects.

 **Night scene**
Use when taking photos at night or in poorly lit environments. Due to long exposure time, the camera must be held still or placed on a stable surface.

 **Beach and snow**
Use in bright environments to avoid underexposed photos.

 **Sports**
Use for photos of fast-moving objects. Short exposure time minimises motion blurring.

 **Document**

Use for photos of text or drawings. Gives the photo increased, sharper contrast.

! This setting is only available in **Normal** capturing mode.

Flash

Use the flash to take photos when lighting conditions are poor or when there is a backlight.



Auto

The camera automatically determines if the lighting conditions require the use of a flash.



Fill flash

Use this setting when the background is brighter than the subject. This removes unwanted dark shadows.



Off

The flash is turned off. Sometimes photo quality can be better without the flash, even if lighting conditions are poor. Taking a good photo without using the flash requires a steady hand. Use the self-timer to avoid blurred photos.



Red-eye reduction

Reduces the red colour of eyes when taking a photo.

Resolution

Choose between several picture sizes and aspect ratios before taking a photo. A photo with a higher resolution requires more memory.



5MP 4:3

5 megapixel picture size with 4:3 aspect ratio. Suitable for photos you want to view on non-widescreen displays or print in high resolution.



3MP 16:9

3 megapixel picture size with 16:9 aspect ratio. A high resolution widescreen format. Has a higher resolution than full HD. Suitable for photos you want to view on widescreen displays.



2MP 4:3

2 megapixel picture size with 4:3 aspect ratio. Suitable for photos you want to view on non-widescreen displays.



2MP 16:9

2 megapixel picture size with 16:9 aspect ratio. Suitable for photos you want to view on widescreen displays.

Self-timer.

With the self-timer you can take a photo without holding the phone. Use this function to take self-portraits, or group photos where everyone can be in the photo. You can also use the self-timer to avoid shaking the camera when taking photos.



On (10 s.)

Set a 10-second delay from when you tap the camera screen until the photo is taken.



On (2 s.)

Set a 2-second delay from when you tap the camera screen until the photo is taken.



Off

The photo is taken as soon as you tap the camera screen.

Geotagging



Tag photos with details of where you took them.



On

When geotagging is turned on, the approximate geographical location is added to photos when you take them. To use geotagging, you must enable location features from the **Settings** menu.

See *Using location services to find your position* on page 110.

For geotags to be added to a photo, the location must be determined before you take the photo. Your location is determined when  appears on the camera screen. When the phone is searching for your position,  appears.



Off

When geotagging is turned off, you cannot view the location where you took a photo.

Capturing method

Select the method you use to take photos.



On-screen button

Take a photo by tapping the on-screen button on the camera screen. The photo is taken as soon as you release your finger.



Touch capture

Identify a particular focus area by touching the camera screen with your finger. The photo is taken as soon as you release your finger. This applies only when focus mode is set to touch focus.

Quick launch

Tips on using the camera

Rule of thirds

Don't place your subject in the middle of the frame. By placing it a third of the way in, you achieve a better result.

Hold it steady

Avoid blurry photos by holding the camera steady. Try to steady your hand by leaning it against a solid object.

Get closer

By getting as close as possible to your subject, you can fill the camera screen view with your subject.

Consider variety

Think about different angles, and move towards the subject. Take some vertical photos. Try different positions.

Use a plain background



A plain background helps highlight your subject.

Keep your lens clean

Mobile phones are used in all kinds of weather and places, and carried in pockets and bags. This results in the camera lens becoming dirty and covered with fingerprints. Use a soft cloth to clean the lens.

Using the video camera







To record a video by tapping the screen

- 1 Activate the camera.
- 2 If the video camera is not selected, drag  to .
- 3 To display all settings, press .
- 4 Tap **Capturing method** > **Touch capture** if it is not already selected.
- 5 Tap the camera screen to start recording.
- 6 Tap the camera screen to stop recording.









Shoot your videos in landscape orientation to get the best results.



To record a video by tapping the on-screen button

- 1 Activate the camera.
 - 2 If the video camera is not selected, drag  to .
 - 3 To display all settings, press .
 - 4 Tap **Capturing method**, then select **On-screen button** if it is not already selected.
 - 5 Point the camera towards the subject.
 - 6 Tap  to start recording.
 - 7 Tap .
-  Shoot your videos in landscape orientation to get the best results.

To play recorded videos



- 1 Activate the camera.
 - 2 If the video camera is not selected, drag  to .
 - 3 Tap the thumbnails on the bottom of the screen.
 - 4 Flick left or right to browse all photo and video files. Videos are identified by .
 - 5 Tap  to play a video.
 - 6 To stop playing the video, tap  or .
-  You can also flick the thumbnails from right to left to find the file that you want to play.

To delete a recorded video



- 1 Browse to the video that you want to delete.
 - 2 Press , then tap .
-  To delete a recently taken photo or video, you can also flick the thumbnail at the bottom right of the viewfinder and then press and hold the item you want to delete.

Using video camera settings

To adjust video camera settings

- 1 Activate the camera.
- 2 If the video camera is not selected, drag  to .
- 3 Tap one of the settings icons on the left of the screen.
- 4 To display all settings, press .
- 5 Select the setting you want to adjust, then make your changes.

To customise the video camera settings panel

- 1 When the video camera is open, press  to display all settings.
 - 2 Touch and hold the setting you want to move and drag it to the desired position.
-  If you drag the setting outside of the settings panel, the change is cancelled.

Video camera settings overview

Scenes

The Scenes feature helps you to quickly set up the camera for common situations using pre-programmed scenes. The camera determines a number of settings for you to fit the selected scene, ensuring the best possible video.

 **Off**
The Scenes feature is off and you can shoot videos manually.

 **Landscape**
Use for videos of landscapes. The camera focuses on distant objects. When **Landscape** is selected, focus mode is changed to **Single auto focus**.





-  **Night**
When turned on, light sensitivity is increased. Use in poorly lit environments. Videos of fast-moving objects may get blurred. Hold your hand steady, or use a support. Turn off night mode when lighting conditions are good, to improve the video quality.
-  **Beach and snow**
Use in bright environments to avoid underexposed videos.
-  **Sports**
Use for videos of fast-moving objects. Short exposure time minimises motion blurring.



Photo light

Use the light to record videos when lighting conditions are poor or when there is a backlight.

-  **On**
-  **Off**
Sometimes the video quality can be better without a light, even if lighting conditions are poor.



Capturing method

Select the method you use to record a video.

-  **On-screen button**
Record a video by using the on-screen button on the camera screen.
-  **Touch capture**
Identify a particular focus area by touching the camera screen with your finger.



Focus mode

The focus setting controls which part of a video should be sharp. When continuous autofocus is on, the camera keeps adjusting focus so that the area within the white focus frame stays sharp.

-  **Single auto focus**
The camera automatically focuses on the selected subject. Continuous autofocus is on.
-  **Infinity**
Use when recording videos from a distance. Focus is set on subjects far away. Subjects close to the camera may be blurred.



Video size

Adjust the video size for different formats.

-  **VGA**
VGA format with 4:3 aspect ratio. 640x480 pixels.
-  **QVGA**
Quarter VGA format with 4:3 aspect ratio. 320x240 pixels.
-  **Multimedia message**
Record videos suitable for sending in multimedia messages. The recording time of this video format is limited to fit in a multimedia message.

Self-timer

With the self-timer you can record a video without holding the phone. Use it to record group videos where everyone can be in the video. You can also use the self-timer to avoid shaking the camera when recording videos.

-  **On (10 s.)**
Set a 10-second delay from when you tap the camera screen until the video begins to record.
-  **On (2 s.)**
Set a 2-second delay from when you tap the camera screen until the video begins to record.

**Off**

The video begins to record as soon as you tap the camera screen.

Exposure value



This setting allows you to determine the amount of light in the image you capture. A higher value indicates an increased amount of light.

White balance

The white balance setting adjusts the colour balance according to the lighting conditions.

**Auto**

Adjust the colour balance automatically to the lighting conditions.

**Incandescent**

Adjusts the colour balance for warm lighting conditions, such as under light bulbs.

**Fluorescent**

Adjust the colour balance for fluorescent lighting.

**Daylight**

Adjust the colour balance for sunny outdoor conditions.

**Cloudy**

Adjust the colour balance for a cloudy sky.

Microphone

Select whether to pick up the surrounding sound when recording videos.

Shutter sound

Choose to turn on or turn off the shutter sound when you record a video.

Viewing photos and videos in Album

Use Album to view photos and play videos that you've taken with your phone camera, or to view similar content that you've downloaded or copied to the memory card. You can add geotags to your photos and videos, and then view them on a world map. In Album, you can also view photos and videos that you've uploaded to an online service, for example, to a Picasa™ web album or to Facebook™. From Album, you can also share your favorite photos and videos with friends via using Bluetooth™ wireless technology, email, messaging and various online services. And you can perform basic editing tasks on photos and set them as wallpaper or contact pictures. For more information, see *Connecting your phone to a computer* on page 107.

Album tab overview

The following tabs are available in Album:

- **Pictures** – view all photos and videos saved to the memory card.
- **Map** – view your geotagged photos and video clips on a world map.
- **Online** – view your online albums.

To open Album

- 1 From your Home screen, tap .
- 2 Find and tap **Album**.

-  If the screen orientation does not change automatically when you turn the phone sideways, mark the **Auto-rotate** screen checkbox under **Settings > Display**.

Viewing photos and videos saved in the phone

In the grid view of the **Pictures** tab in Album, you can view the thumbnails of photos and videos. You can also go to the list view of all albums and find content in each folder.

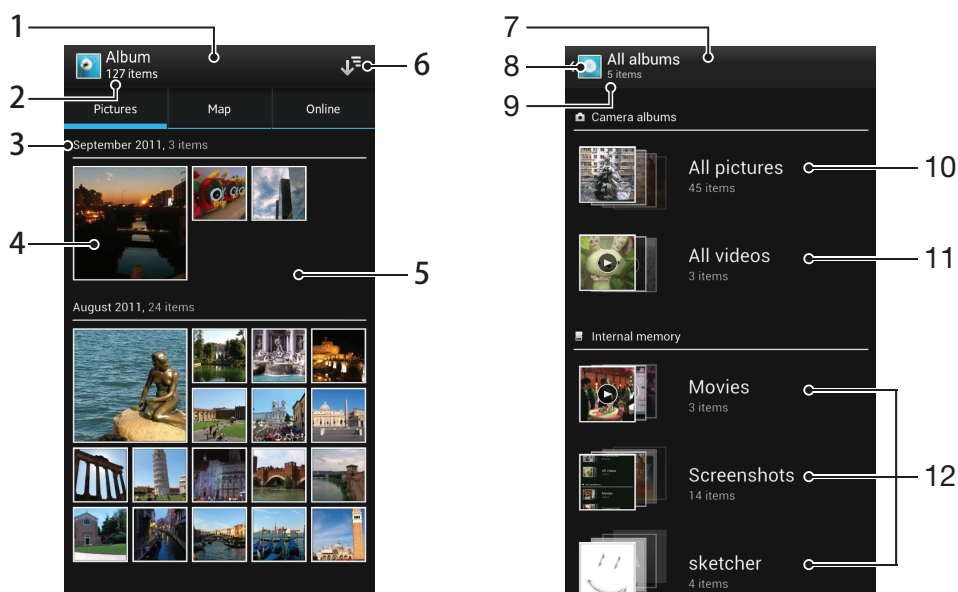

Overview of Pictures tab







- 1 Grid view of photos and videos.
- 2 Total number of photos and videos.
- 3 The date and number of items in the group below.

- 4 Tap a photo or video to view it.
- 5 Scroll up or down to view content.
- 6 Switch to a list view of all folders containing pictures and videos saved on your phone.
- 7 List view of all folders containing pictures and videos saved on your phone.
- 8 Tap to return to grid view in the **Pictures** tab.
- 9 The number of the folders containing pictures and videos.
- 10 Folder containing all pictures taken with your phone camera.
- 11 Folder containing all videos taken with your phone camera.
- 12 All other folders containing pictures and/or videos that you've downloaded or copied to your phone.

To view photos and videos in grid view

- 1 From your Home screen, tap .
 - 2 Find and tap **Album**. All photos and videos are displayed in a chronologically ordered grid. Videos are indicated by .
 - 3 Tap a photo or video to view it.
 - 4 Flick left to view the next photo or video. Flick right to view the previous photo or video.
-  If the screen orientation does not change automatically when you turn the phone sideways, mark the **Auto-rotate screen** checkbox under **Settings > Display**.



To view photos and videos in list view

- 1 From your Home screen, tap .
 - 2 Find and tap **Album > Pictures**.
 - 3 Tap . Folders containing photos and videos shot using the phone camera are displayed at the top. All other folders containing pictures and videos saved on your phone are displayed in an alphabetical list.
 - 4 Tap a folder you want to open. The folder's content appears in a chronologically ordered grid. Videos are indicated by .
 - 5 Tap a photo or video to view it.
 - 6 Flick left to view the next photo or video. Flick right to view the previous photo or video.
-  If the screen orientation does not change automatically when you turn the phone sideways, mark the **Auto-rotate screen** checkbox under **Settings > Display**.

To change the size of the thumbnails in Album

- When viewing thumbnails of photos and videos in Album, spread two fingers apart to zoom in, or pinch two fingers together to zoom out.

To work with batches of photos or videos in Album

- 1 When viewing thumbnails of photos and videos in Album, press  and tap **Select items** to activate selection mode.
 - 2 Tap the items you want to work with. Selected items are indicated by a blue frame.
 - 3 Use the tools in the toolbar at the top of the screen to work with your selected items.
-  To activate selection mode, you can also touch and hold an item until its frame turns blue. Then you can tap other items to select them.

Working with photos in Album

You can edit photos in Album. For example, you can crop photos, associate them with contacts, or use them as wallpaper.

To zoom a photo

- When you are viewing a photo, double-tap the screen to zoom in. Double-tap again to zoom out.
- When you are viewing a photo, spread two fingers apart to zoom in, or pinch two fingers together to zoom out.

To watch a slideshow of your photos

- 1 When you are viewing a photo, press  and tap **Slide show** to start playing all the photos in an album.
- 2 Tap a photo to end the slideshow.

To rotate a photo

- 1 When you are viewing a photo, press .
- 2 Select **Rotate left** or **Rotate right**. The photo is saved in the new orientation.

To crop a photo

- 1 When you are viewing a photo, press , then tap **Crop**.
- 2 To adjust the crop frame, touch and hold the edge of the crop frame. When the squares at the edges disappear, drag inward or outward to resize the frame.
- 3 To resize all sides of the crop frame at the same time, touch and hold one of the four corners to make the squares at the edges disappear, then drag the corner accordingly.
- 4 To move the crop frame to another area of the photo, touch and hold inside the frame, then drag it to the desired position.
- 5 To save a copy of the photo as you cropped it, tap **Crop**. The original uncropped version remains on your phone's memory card.

To use a photo as a contact picture

- 1 When you are viewing a photo, press , then tap **Use as > Contact picture**.
- 2 Select the contact you want to associate with the photo.
- 3 Crop the photo, if required.
- 4 Tap **Crop**.

To use a photo as wallpaper

- 1 When you are viewing a photo, press , then tap **Use as > Wallpaper**.
- 2 Crop the photo, if required.
- 3 Tap **Crop**.

To edit a photo

- When you are viewing a photo, press , then tap **Edit photo**.

To share a photo

- 1 When you are viewing a photo, tap the screen to display the toolbars, then tap .
- 2 In the menu that opens, tap the application that you want to use to share the photo, then follow the steps to send it.

To add a geotag to a photo

- 1 When you are viewing a photo, tap the screen to display the toolbars, then tap  to open the map screen.
- 2 Find and tap the desired location to put the photo on the map.
- 3 To adjust the location of the photo, tap the location on the map to where you want to move the photo.
- 4 When you are finished, tap **OK** to save the geotag and return to the photo viewer.

- 💡 When a photo is geotagged,  appears along with location information. You can tap this icon to view the photo on a map.

To delete a photo

- 1 When you are viewing a photo, tap the screen to display the toolbars, then tap .
- 2 Tap OK.

Working with videos in Album

Use Album to watch videos that you've taken with the camera, downloaded, or copied to your memory card. You can also share your videos with friends, or upload them to YouTube™.

To play a video

- 1 Open the **Pictures** tab in Album.
- 2 Using grid view or list view, locate the video that you want to open.
- 3 Tap the video to play it.
- 4 If the playback controls are not displayed, tap the screen to display them. To hide the controls, tap the screen again.

To pause a video

- 1 When a video is playing, tap the screen to display the controls.
- 2 Tap .

To fast forward and rewind a video

- 1 When a video is playing, tap the screen to display the controls.
- 2 Drag the progress bar marker left to rewind, or right to fast forward.

To adjust the volume of a video

- Press the volume key.

To share a video

- 1 When a video is playing, press , then tap **Share**.
- 2 In the menu that opens, tap the application that you want to use to share the selected video, then follow the relevant steps to send it.

- ! You might not be able to copy, send or transfer copyright-protected items. Also, some items may not send if the file size is too large.

To delete a video

- 1 In Album, find the video you want to delete.
- 2 Touch and hold the video to activate selection mode. The frame of the video thumbnail turns blue when it is selected.
- 3 Tap , then tap OK.

Viewing your photos on a map

If you enable location detection when taking photos, you can use the information gathered at a later stage. For example, you can view your photos on a map and show friends and family where you were when you took the photo. Adding location information is also referred to as geotagging. When you enable location detection, you can select to use either GPS satellites or wireless networks, or both, to find your position.

For more information, see *Using location services to find your position* on page 110.

Overview of Map tab







- 1 The number of geotagged photos and videos.
- 2 Double tap to zoom in. Pinch to zoom out. Drag to view different parts of the map.
- 3 A group of photos and/or videos geotagged with the same location.
- 4 Thumbnails of the selected group of photos and/or videos. Tap an item to view it in full screen.
- 5 Search a location on the map.
- 6 Switch to globe view.

To enable location detection

- 1 From your Home screen, tap .
- 2 Find and tap **Settings** > **Location services**.
- 3 Mark the **GPS satellites** and/or **Google's location service** checkboxes.

To view geotagged photos on a map in Album

- 1 From your Home screen, tap .
- 2 Find and tap **Album** > **Map**.
- 3 Tap a photo to view it in full screen.
- 4 If several photos were taken at the same location, only one of them appears on the map. The total number of photos appears in the top right corner, for example, . To view these photos, tap the cover photo and then tap one of the thumbnails at the bottom of the screen.

 When viewing a geotagged photo in the photo viewer, you can touch the screen to display the toolbars, then tap  to view the photo on the map.

To add a geotag when viewing the map in Album

- 1 When viewing the map in Album, press , then tap **Add geotag**.
- 2 Find and tap the photo to which you want to add the geotag.
- 3 Tap the desired location on the map to set the geotag, then tap **OK**.

To edit the geotag of a photo in Album

- 1 When viewing a photo on the map in Album, touch and hold the photo until its frame turns blue.
- 2 Drag the photo to the new location.

 You can also tap the desired location on the map instead of dragging.

To change the map view in Album

- When viewing the map in Album, press , then select **Classic view** or **Satellite view**.

Viewing your online albums

In Album, you can view the photos and videos you've uploaded to online services, such as Picasa™ and Facebook™. View comments from your friends and add your own comments as well. You can also recommend or "Like" a photo when you view your albums in Facebook™.

Overview of Online tab



- 1 Number of available online albums.
- 2 Active online service.
- 3 Name of an online album.
- 4 Number of items in the online album.

To view photos from online services in Album

- 1 Make sure you are signed in to the relevant online service, for example, Facebook™.
- 2 From your Home screen, tap .
- 3 Find and tap **Album** > **Online**. All your available online albums are displayed.
- 4 Tap any album to view its contents, then tap a photo in the album.
- 5 In the photo viewer, flick left to view the next photo or video. Flick right to view the previous photo or video.

To view and add comments to online album content

- 1 When viewing a photo from an online album, tap the screen to display the toolbars, then tap  to view the comments.
- 2 To view more comments, scroll down the screen.
- 3 To add your own comments, enter your comments at the bottom of the screen, then tap **Post**.

To recommend a photo or video on Facebook™



- While viewing a photo or video from one of your Facebook™ albums, tap the screen to display the toolbars, then tap  to show that you "Like" the item on Facebook™.

Playing video clips in Movies

Use the Movies application to play movies that you've copied or downloaded to your phone. Movies also helps you get poster art, plot summaries, genre info and director details for each movie. You can share your favourite movies with friends, for example, via Bluetooth™ wireless technology or via online services. You can also play your movies on other devices that are connected to the same network.

- ! Video clips taken with your phone camera are displayed in Album, not in Movies. For more information, see *Viewing photos and videos in Album* on page 95.

To play video clips in Movies

- 1 From your Home screen, tap .
- 2 Find and tap **Movies**. All movies are displayed in a grid.
- 3 Tap the movie you want to select, then tap  to play it.
- 4 To display or hide the controls, tap the screen.
- 5 To pause the movie, tap .
- 6 To rewind the movie, drag the progress bar marker left. To fast forward the movie, drag the progress bar marker right.

To play a movie in full screen





- 1 When a movie is playing, tap the screen to display the controls.
- 2 Tap .

- 💡 To play the movie in its original size, tap .

To share a movie

- 1 When a movie is playing, press , then tap **Share**.
- 2 In the menu that opens, tap the application that you want to use to share the selected video, then follow the relevant steps to send it.

To get movie information manually

- 1 From your Home screen, tap .
- 2 Find and tap **Movies**. All movies are displayed in a grid.
- 3 Press , then make sure that the **Online mode** checkbox is marked and that your phone has a data connection.
- 4 Touch and hold the movie for which you want to get information, then tap **Search for info** in the list that appears.
- 5 In the search field, enter keywords for the movie, then tap . All matches are displayed in a list.
- 6 Tap the result you want, then tap **Done**. The download of the information begins.
- 7 When the download is finished, tap the movie to view its information. If the information is not correct, tap  and search again.

- ! Data transmission charges may apply.

To clear the information for a movie

- 1 From your Home screen, tap .
- 2 Find and tap **Movies**. All movies are displayed in a grid.
- 3 Touch and hold the desired movie, then tap **Clear info** from the list that appears.

Sharing content with DLNA Certified™ devices

You can view or play media content saved in your phone on other devices such as, for example, a TV, a PlayStation®3, a computer, or a tablet. Such devices must be DLNA Certified™ by the Digital Living Network Alliance and must be connected to the same Wi-Fi® network as your phone in order for content to be shared.

After you set up the sharing of content between devices, you can, for example, print files from your phone on a printer, or view photos taken with your phone camera on a large-screen TV.

Playing files from DLNA Certified™ devices on your phone

When you play files from another DLNA Certified™ device on your phone, this other device acts as a server. In other words, it shares content over a network. The server device must have its content sharing function enabled and must be connected to the same Wi-Fi network as your phone. All server devices connected to the Wi-Fi network are displayed in the **Server list** on your phone.



To play a shared media file on your phone

- 1 Make sure the devices that you want to share files with are connected to the same Wi-Fi® network as your phone.
- 2 From your Home screen, tap , then find and tap **Connected devices**.
- 3 Select a connected device under **Server list**.
- 4 Browse the folders of the connected device and select the media file that you want to open. The file starts playing automatically.

Preparing to play phone content on DLNA Certified™ devices

Before you can view or play media files from your phone on other DLNA Certified™ devices, you must set up file sharing on your phone. The devices you share content with are called client devices. For example, a TV, computer or tablet can act as client devices. Your phone works as a media server when it makes content available to client devices. When you set up file sharing on your phone, you must also give access permission to client devices. After you do so, such devices appear as registered devices. Devices that are waiting for access permission are listed as pending devices.



To set up file sharing with other DLNA Certified™ devices

- 1 Connect your phone to a Wi-Fi® network.
- 2 From your Home screen, tap , then find and tap **Connected devices**.
- 3 Press , then tap **Media server**.
- 4 Tap **Change server name** and edit your phone name, if desired. This name will later appear on other client devices connected to the Wi-Fi network to identify your phone.
- 5 To turn on the **Share content** function, drag the slider.  appears in the status bar. Your phone can now work as a media server.
- 6 Connect your computer or other devices to the same Wi-Fi® network as your phone.
- 7 A notification appears in the status bar of the phone. Open the notification and set the relevant access permissions for other devices.



! The instructions described above may differ depending on the client devices used. Refer to your client device User guide for more information. If the device cannot connect, check that your Wi-Fi network is working.

 If you close the **Connected devices** view, the Media server function stays running in the background.



To stop sharing files with other DLNA Certified™ devices

- 1 From your Home screen, tap , then find and tap **Connected devices**.
- 2 Press , then tap **Media server**.
- 3 Drag the slider to turn off the **Share content** function.



To set access permissions for a pending device

- 1 From your Home screen, tap , then find and tap **Connected devices**.
- 2 Press , then tap **Media server**.
- 3 Select a device from the **Pending devices** list.
- 4 Select an access permission level.

To change the name of a registered device

- 1 From your Home screen, tap , then find and tap **Connected devices**.
- 2 Press , then tap **Media server**.
- 3 Select a device from the **Registered devices** list, then select **Change name**.
- 4 Enter a new name for the device.

To change the access level of a registered device



- 1 From your Home screen, tap , then find and tap **Connected devices**.
- 2 Press , then tap **Media server**.
- 3 Select a device from the **Registered devices** list.
- 4 Tap **Change access level** and select an option.



To get help about sharing content with other DLNA Certified™ devices

- 1 From your Home screen, tap , then find and tap **Connected devices**.
- 2 Tap .



Playing phone content on other DLNA Certified™ devices

To view photos or videos from your phone on another device

- 1 Make sure that you have correctly set up file sharing with other DLNA Certified™ devices and that all relevant devices are connected to the same Wi-Fi® network.
- 2 From your Home screen, tap .
- 3 Find and tap **Album**.
- 4 Touch and hold any photo or video until a toolbar appears.
- 5 Tap the item or items that you want to view, then tap  > .
- 6 Select a device. The selected files start playing in chronological order on the device that you select.

 You can also share a video from the Movies application on your phone by tapping the video and then tapping .

To play a music track from your phone on another device

- 1 Make sure that you have correctly set up file sharing with other DLNA Certified™ devices and that all relevant devices are connected to the same Wi-Fi® network.
- 2 From your Home screen, tap , then find and tap .
- 3 Tap **MY MUSIC** to open the music library.
- 4 Select a music category and browse to the track that you want to share, then tap the track.
- 5 Press , then tap **Play on device**.
- 6 Select a device. The track plays automatically on the device that you select.

Bluetooth™ wireless technology

Use the Bluetooth™ function to send files to other Bluetooth™ compatible devices, or to connect to handsfree accessories. Turn on the Bluetooth™ function in your phone and create wireless connections to other Bluetooth™ compatible devices such as computers, handsfree accessories, and phones. Bluetooth™ connections work better within a 10 meter (33 foot) range, with no solid objects in between. In some cases you have to manually pair your phone with other Bluetooth™ devices. Remember to set your phone to "discoverable" if you want other Bluetooth™ devices to detect it.

- ! Interoperability and compatibility among Bluetooth™ devices can vary.



To turn on the Bluetooth™ function and make your phone visible

- 1 From your Home screen, tap .
- 2 Find and tap **Settings**.
- 3 Tap the on-off switch beside **Bluetooth** to turn on the Bluetooth™ function.
- 4 Tap **Bluetooth**. Your phone and a list of available Bluetooth™ devices appear.
- 5 Tap your phone name to make your phone visible to other Bluetooth™ devices.

Naming your phone

You can give your phone a name. This name is shown to other devices after you have turned on the Bluetooth™ function and your phone is set to visible.

To give your phone a name

- 1 Make sure that the Bluetooth™ function is turned on.
- 2 From your Home screen, tap .
- 3 Find and tap **Settings > Bluetooth**.
- 4 Press  and select **Rename phone**.
- 5 Enter a name for your phone.
- 6 Tap **Rename**.

Pairing with another Bluetooth™ device

When you pair your phone with another device, you can, for example, connect your phone to a Bluetooth™ headset or a Bluetooth™ car kit and use these devices to make and receive calls.

Once you have paired your phone with a Bluetooth™ device the phone will remember this pairing. When pairing the phone with a Bluetooth™ device, you may need to enter a passcode. Your phone will automatically try the generic passcode 0000. If this does not work, refer to your Bluetooth™ device documentation for the device passcode. You do not need to re-enter the passcode the next time you connect to a paired Bluetooth™ device.

Some Bluetooth™ devices, for example, most Bluetooth™ headsets, require you to both pair and connect with the other device.

You can pair your phone with several Bluetooth™ devices, but you can only connect to one Bluetooth™ profile at the same time.



To pair your phone with another Bluetooth™ device

- 1 Make sure that the device you want to pair your phone with has the Bluetooth™ function activated and is visible to other Bluetooth™ devices.
- 2 From the Home screen, tap .
- 3 Find and tap **Settings** > **Bluetooth**. All available Bluetooth™ devices appear in a list.
- 4 Tap the Bluetooth™ device that you want to pair with your phone.
- 5 Enter a passcode, if required. The phone and the Bluetooth™ device are now paired.

To connect your phone to another Bluetooth™ device

- 1 If you are connecting to a Bluetooth device that requires you to first pair your phone before connecting, follow the relevant steps to pair your phone with that device.
- 2 From your Home screen, tap .
- 3 Find and tap **Settings** > **Bluetooth**.
- 4 Tap the Bluetooth™ device to which you want to connect your phone.

To unpair a Bluetooth™ device

- 1 From the Home screen, tap .
- 2 Find and tap **Settings** > **Bluetooth**.
- 3 Under **Paired devices**, tap  beside the name of the device that you want to unpair.
- 4 Tap **Unpair**.

Sending and receiving items using Bluetooth™ technology

Share items with other Bluetooth™ compatible devices such as phones or computers. You can send and receive several kinds of items using the Bluetooth™ function, such as:

- Photos and videos
- Music and other audio files
- Contacts
- Web pages

To send items using Bluetooth™

- 1 **Receiving device:** Make sure the Bluetooth™ device that you want to send the item to has Bluetooth™ turned on and is visible to other Bluetooth™ devices.
- 2 In the sending device, open the application which contains the item you want to send and scroll to the item.
- 3 Depending on the application and the item you want to send, you may need to, for example, touch and hold the item, open the item or press . Other ways to send an item may exist.
- 4 Select a share or send menu item.
- 5 In the menu that appears, select **Bluetooth**.
- 6 Turn on Bluetooth™, if you are asked to do so.
- 7 Tap the name of the receiving device.
- 8 **Receiving device:** If asked, accept the connection.
- 9 If asked, enter the same passcode on both devices, or confirm the suggested passcode.
- 10 **Receiving device:** Accept the incoming item.

To receive items using Bluetooth™

- 1 Make sure that the Bluetooth™ function is on and is visible to other Bluetooth™ devices.
- 2 The sending device now starts sending data to your phone.
- 3 If prompted, enter the same passcode on both devices, or confirm the suggested passcode.
- 4 When you are notified of an incoming file to your phone, drag the status bar downwards and tap the notification to accept the file transfer.
- 5 Tap **Accept** to start the file transfer.
- 6 To view the progress of the transfer, drag the status bar downwards.
- 7 To open a received item, drag the status bar downwards and tap the relevant notification.

Connecting your phone to a computer

Connect your phone to a computer and start transferring pictures, music and other file types. The easiest ways to connect are using a USB cable or Bluetooth wireless technology.

When you connect your phone to the computer using a USB cable, you are prompted to install the PC Companion application on your computer. PC Companion helps you access additional computer applications to transfer and organise media files, update your phone, synchronise phone content, and more.

- ! You might not be able to transfer some copyright-protected material between your phone and computer.

Transferring and handling content using a USB cable

Use a USB cable connection between a computer and your phone for easy transfer and management of your files. Once the two devices are connected, you can drag and drop content between them using the computer's file explorer. If you're transferring music, video, pictures or other media files to your phone, it's best to use the Media Go™ application on your computer. Media Go™ converts media files so that you can use them on your phone.

To transfer content between a phone and computer using a USB cable

- 1 Using a USB cable, connect your phone to a computer. **Int. storage & SD card connected** appears in the status bar.
- 2 **Computer:** Open Microsoft® Windows® Explorer from the desktop and wait until your phone's internal storage and SD card appear as external disks in Microsoft® Windows® Explorer.
- 3 **Computer:** Drag and drop the desired files between your phone and the computer.

Transferring files using Media transfer mode via Wi-Fi®

You can transfer files between your phone and other MTP compatible devices, such as a computer, using a Wi-Fi® connection. Before connecting, you first need to pair the two devices. If you're transferring music, video, pictures or other media files between your phone and a computer, it's best to use the Media Go™ application on the computer. Media Go™ converts media files so that you can use them on your phone.

- 💡 In order to use this feature, you need a Wi-Fi® enabled device that supports Media transfer, for example, a computer running Microsoft® Windows Vista® or Windows® 7.

To pair your phone wirelessly with a computer using Media transfer mode

- 1 Make sure Media transfer mode is enabled on your phone. It is normally enabled by default.
 - 2 Connect your phone to the computer using a USB cable.
 - 3 **Computer:** Once the phone name appears on the screen, click *Network configuration* and follow the instructions to pair the computer.
 - 4 When you are finished pairing, disconnect the USB cable from both devices.
- ! The above instructions only work if Windows® 7 is installed on your computer and the computer is connected to a Wi-Fi® Access Point via a network cable.

To connect paired devices wirelessly in Media transfer mode

- 1 Make sure Media transfer mode is enabled on your phone. It is normally enabled by default.
- 2 From your Home screen, tap .
- 3 Find and tap **Settings** > **Xperia™** > **Connectivity**.
- 4 Tap the paired device that you want to connect to under **Trusted devices**.
- 5 Tap **Connect**.

- ! Make sure your phone's Wi-Fi® function is turned on.

To disconnect a wirelessly paired device in Media transfer mode

- 1 From your Home screen, tap .
- 2 Find and tap **Settings** > **Xperia™** > **Connectivity**.
- 3 Tap the paired device that you want to disconnect from under **Trusted devices**.
- 4 Tap **Disconnect**.

To remove a pairing with another device

- 1 From your Home screen, tap .
- 2 Find and tap **Settings** > **Xperia™** > **Connectivity**.
- 3 Tap the paired device that you want to remove.
- 4 Tap **Forget**.

PC Companion

PC Companion is a computer application that gives you access to additional features and services which help you transfer music, video and pictures to and from your phone. You can also use PC Companion to update your phone and get the latest software version available. The installation files for PC Companion are saved on your phone and the installation is launched from the phone when you connect it to a computer via USB cable.

You need an internet connected computer running one of the following operating systems to use the PC Companion application:

- Microsoft® Windows® 7
- Microsoft® Windows Vista®
- Microsoft® Windows® XP (Service Pack 3 or higher)

To start PC Companion

- 1 Make sure that PC Companion is installed on your PC.
- 2 Open the PC Companion application on the PC, then click **Start** to open one of the features that you want to use.

Media Go™

The Media Go™ computer application helps you transfer and manage media content in your phone and computer. You can install and access Media Go™ from within the PC Companion application. See *PC Companion* on page 108 for more information.

You need one of these operating systems to use the Media Go™ application:

- Microsoft® Windows® 7
- Microsoft® Windows Vista®
- Microsoft® Windows® XP, Service Pack 3 or higher

To transfer content using the Media Go™ application

- 1 Connect your phone to a computer using a supported USB cable.
 - 2 **Phone:** In the status bar, **Internal storage connected** appears.
 - 3 **Computer:** Open the PC Companion application on the PC first. In PC Companion, click *Media Go* to start the Media Go™ application. In some cases, you may have to wait for Media Go™ to install.
 - 4 Using Media Go™, drag and drop files between your computer and phone.
-  Media Go™ can also be downloaded from www.sonymobile.com.

Using location services to find your position

Use your phone to find out where you are. There are two methods: GPS and wireless networks. Enable the wireless networks option if you only need your approximate location, and want it fast. If you want a more exact position, and have a clear view of the sky, enable the GPS option. In situations where the wireless network connection is weak, you should enable both options to ensure that your location is found.

- ! Sony does not warrant the accuracy of any location services including but not limited to navigational services.

To enable GPS

- 1 From your Home screen, tap .
- 2 Tap **Settings** > **Location services**.
- 3 Mark the **GPS satellites** checkbox.

To enable wireless networks

- 1 From your Home screen, tap .
- 2 Tap **Settings** > **Location services**.
- 3 Mark the **Google's location service** checkbox.

Using GPS

Your phone has a global positioning system (GPS) receiver that uses satellite signals to calculate your location.

- ! When you use features that require the GPS receiver to find your location, make sure you have a clear view of the sky.

Getting the best performance

The first time you use the GPS it can take 5 to 10 minutes for your location to be found. To help the search, make sure you have a clear view of the sky. Stand still and don't cover the GPS antenna (the highlighted area in the image). The GPS signals can pass through clouds and plastic, but not through most solid objects such as buildings and mountains. If your location isn't found after a few minutes, move to another location.

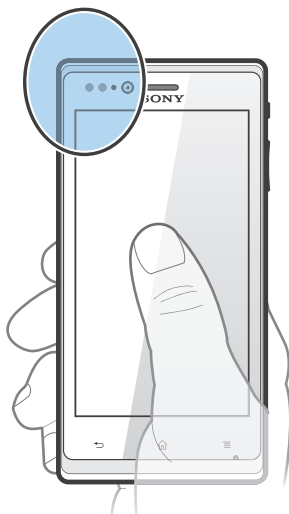

Google Maps™

Track your current location, view real-time traffic situations and receive detailed directions to your destination. Before taking trips, you can download and save maps to your memory card to avoid high roaming costs.

- ! The Google Maps™ application requires the use of an Internet connection. You may incur data connection charges when you connect to the Internet from your phone. Contact your network operator for more information. The Google Maps™ application may not be available in every market, country or region.

To use Google Maps™

- 1 From your Home screen, tap .
- 2 Find and tap **Maps**.

- ! If you want to use Google Maps™, you have to enable one of the location methods available under **Settings > Location services**.

To learn more about Google Maps™

- When you use Google Maps™, press , then tap **Help**.

Viewing your friends' locations with Google Latitude™

Join Google Latitude™ to view your friends' locations on maps and share your location and other information with them.

Using Google Maps™ to get directions

Use the Google Maps™ application to get directions when you travel by foot, public transportation, or car. You can add a shortcut to a destination on your Home screen to get quick directions from wherever you are.

When you view a map, you make an Internet connection, and data is transferred to your phone. So it's a good idea to download and save maps to your phone before you take a trip. This way, you can avoid high roaming costs.

- ! Sony does not warrant the accuracy of any directional services.

Using the Navigation application

Use the Navigation application in your phone to get turn-by-turn instructions on how to get places. The directions are both spoken and displayed on the screen.

- ! The Navigation application may not be available in every market.

To start Navigation

- 1 From your Home screen, tap .
- 2 Find and tap **Navigation**.

Locking and protecting your phone

IMEI number

Every phone has a unique IMEI (International Mobile Equipment Identity) number. You should keep a copy of this number. If your phone is stolen, your network provider can use your IMEI number to stop the phone from accessing the network in your country.

To view your IMEI number



- 1 Turn off your phone, then remove the battery cover and battery.
- 2 Look for the 15- to 17-digit number on the label. The first 15 digits represent the IMEI number.

To view your IMEI number in the phone

- 1 From your Home screen, tap .
- 2 Find and tap **Settings** > **About phone** > **Status**.
- 3 Scroll to **IMEI** to view the IMEI number.

SIM card protection

The SIM card lock only protects your subscription. Your phone will still work with a new SIM card. If the SIM card lock is on, you have to enter a PIN (Personal Identity Number). If you enter your PIN incorrectly more times than the maximum number of attempts allowed, your SIM card will become blocked. You need to enter your PUK (Personal Unblocking Key) and then a new PIN. Your PIN, PIN2 and PUK are supplied by your network operator.

To enable the SIM card PIN lock

- 1 From the Home screen, tap .
- 2 Find and tap **Settings** > **Security** > **Set up SIM card lock** > **Lock SIM card**.
- 3 Enter the SIM card PIN and tap **OK**.

To change the SIM card PIN

- 1 From the Home screen, tap .
- 2 Find and tap **Settings** > **Security** > **Set up SIM card lock** > **Change SIM PIN**.
- 3 Enter the old SIM card PIN and tap **OK**.
- 4 Enter the new SIM card PIN and tap **OK**.
- 5 Re-type the new SIM card PIN and tap **OK**.

To change the SIM card PIN2

- 1 From the Home screen, tap .
- 2 Find and tap **Settings** > **Call settings** > **Fixed dialling numbers** > **Change PIN2**.
- 3 Enter the old SIM card PIN2 and tap **OK**.
- 4 Enter the new SIM card PIN2 and tap **OK**.
- 5 Confirm the new PIN2 and tap **OK**.

To unblock a locked SIM card

- 1 When **Enter PUK and new PIN code** appears, enter the PUK code.
 - 2 Enter a new PIN code and tap **OK**.
- ! If you enter an incorrect PUK code too many times, the SIM card becomes blocked. If this happens, contact your service provider to get a new SIM card.

Setting a screen lock

There are several ways to lock your phone screen. For example, you can use the Face Unlock feature, which uses a picture of your face to unlock the screen. You can also set a screen unlock pattern, a number-based PIN lock, or a text-based password.

To set a screen lock

- 1 From your Home screen, tap  > **Settings** > **Security** > **Screen lock**.
 - 2 Select an option.
- 💡 It is very important that you remember your screen unlock pattern, PIN or password. If you forget this information, it may not be possible to restore important data such as contacts and messages. Refer to Sony Customer support for more information.

To set up the Face Unlock protection

- 1 From your Home screen, tap  > **Settings** > **Security** > **Screen lock**.
 - 2 Tap **Face Unlock**, then follow the instructions in your phone to capture your face.
 - 3 After your face is successfully captured, set up screen lock **Pattern** or **PIN** as a backup method to unlock the screen. For more information, refer to 'To create a screen unlock pattern' or 'To create a screen unlock PIN'.
- ! The Face Unlock feature is less secure than a screen lock pattern, PIN, or password. Someone who looks similar to you could unlock your phone.
- 💡 For best results, capture your face in an indoor area that is well lit but not too bright and hold the phone at eye level.

To unlock the screen using the Face Unlock feature

- 1 Activate the screen.
 - 2 Look at your phone from the same angle you used to capture your Face Unlock photo.
- 💡 If Face Unlock fails to recognise your face, you need to draw the backup pattern or PIN to unlock the screen.

To disable the Face Unlock protection

- 1 From your Home screen, tap  > **Settings** > **Security** > **Screen lock**.
- 2 Draw your backup screen unlock pattern or enter your PIN.
- 3 Tap **Slide**.

To create a screen unlock pattern

- 1 From the Home screen, tap .
- 2 Find and tap **Settings** > **Security** > **Screen lock** > **Pattern**.
- 3 Follow the instructions in your phone. You are asked to select a security question that will be used to unlock the phone if you forget your screen unlock pattern.

To unlock the screen using a screen unlock pattern

- 1 Activate the screen.
 - 2 Draw your screen unlock pattern.
- ! If the unlock pattern you draw on the screen is rejected five times in a row, you can select to either wait 30 seconds and then try again, or to answer the security question you have selected.



To change the screen unlock pattern

- 1 From your Home screen, tap .
- 2 Find and tap **Settings** > **Security** > **Screen lock**.
- 3 Draw your screen unlock pattern.
- 4 Tap **Pattern**.
- 5 Follow the instructions in your phone.

To disable the screen unlock pattern

- 1 From your Home screen, tap  > **Settings** > **Security** > **Screen lock**.
- 2 Draw the screen unlock pattern.
- 3 Tap **Slide**.



To create a screen unlock PIN

- 1 From your Home screen, tap  > **Settings** > **Security** > **Screen lock** > **PIN**.
- 2 Enter a numeric PIN.
- 3 If necessary, tap  to minimise the keyboard.
- 4 Tap **Continue**.
- 5 Re-enter and confirm your PIN.
- 6 If necessary, tap  to minimise the keyboard.
- 7 Tap **OK**.

To disable the screen unlock PIN

- 1 From your Home screen, tap  > **Settings** > **Security** > **Screen lock**.
- 2 Enter your PIN, then tap **Next**.
- 3 Tap **Slide**.

To create a screen lock password

- 1 From your Home screen, tap  > **Settings** > **Security** > **Screen lock** > **Password**.
- 2 Enter a password.
- 3 If necessary, tap  to minimise the keyboard.
- 4 Tap **Continue**.
- 5 Re-enter and confirm your password.
- 6 If necessary, tap  to minimise the keyboard.
- 7 Tap **OK**.

To disable the screen unlock password

- 1 From your Home screen, tap  > **Settings** > **Security** > **Screen lock**.
- 2 Enter your password and tap **Next**.
- 3 Tap **Slide**.

Updating your phone

Update your phone to the most recent software version to get optimal performance and the latest enhancements.

You can use the Update center application on your phone to run a wireless update or you can use the PC Companion application on a computer to run an update using a USB cable connection. If you update wirelessly, then you can use either a mobile network or a Wi-Fi® network connection. Just make sure you back up and save all data stored on your phone before you update.

- ! When you run an update using the Update center application, a data connection is established and related charges may be incurred. Also, the availability of updates over a mobile network depends on your operator. Contact your network operator for more information.

Updating your phone wirelessly



Use the Update center application to update your phone wirelessly. You can download software updates manually, or you can allow Update service to update your phone automatically whenever downloads become available. When the automatic update feature is activated, a notification appears in the status bar every time an update becomes available.

To download software updates manually from Update center

- 1 From your Home screen, tap .
- 2 Find and tap **Update Centre**.
- 3 Select the desired application or system update and tap **Download**, or tap **Update all** to download all application updates.

- ! Application updates launch automatically after download. With system updates, wait for your phone to restart, then install the update manually. Also, You may incur data connection charges when downloading updates over 3G/mobile networks.

To activate automatic software updates from Update center

- 1 From your Home screen, tap .
 - 2 Find and tap **Update Centre**.
 - 3 Press , then tap **Settings**.
 - 4 Tap **Allow automatic update**: and select whether to download updates via 3G and Wi-Fi® networks, or via Wi-Fi® networks only. Updates are now downloaded automatically as soon as they become available.
- ! You may incur data connection charges when downloading updates over 3G/mobile networks.

To install system updates

- 1 From your Home screen, tap .
- 2 Find and tap **Update Centre**.
- 3 Select a system update you want to install, then tap **Install**.

Updating your phone using a USB cable connection

Some updates are not available for wireless download. Notifications appear in the status bar to inform you of such updates. To download and run the updates, you need a USB cable and a computer running the PC Companion application. You can install PC Companion on the computer using installation files saved on your phone, or you can download the application directly from www.sonymobile.com.

To download the PC Companion application from your phone

- 1 Connect your phone to a computer using a USB cable.
- 2 When prompted, follow the instructions in the phone to launch the installation of PC Companion on the computer.

 PC Companion can also be downloaded from www.sonymobile.com.

To download software updates using a USB cable connection

- 1 Install the PC Companion application on the computer you are using, if it is not already installed.
- 2 Connect your phone to the computer using a USB cable.
- 3 **Computer:** Launch the PC Companion application. After a few moments, PC Companion detects your phone and searches for new phone software.
- 4 **Phone:** When notifications appear in the status bar, follow the on-screen instructions to carry out the relevant software updates.

To update your phone using an Apple® Mac® computer

- 1 Install the Bridge for Mac application on the Apple® Mac® computer you are using, if it is not already installed.
- 2 Using a USB cable, connect your phone to the Apple® Mac® computer.
- 3 **Computer:** Launch the Bridge for Mac application. After a few moments, Bridge for Mac detects your phone and searches for new phone software.
- 4 **Computer:** If a new phone software update is detected, a popup window appears. Follow the on-screen instructions to carry out the relevant software updates.

 The Bridge for Mac application is downloadable from www.sonymobile.com.

Phone settings overview

Get to know the settings in your phone so that you can personalise them to your own requirements.

Wi-Fi	Turn Wi-Fi® on or off, scan available Wi-Fi® networks, or add the Wi-Fi® network.
Bluetooth	Turn Bluetooth™ on or off, search for available Bluetooth™ devices, and make your phone visible or invisible to other Bluetooth™ devices.
Data usage	Turn the mobile data traffic on or off, and keep track of your data usage details over a specified period of time.
More...	Turn Airplane mode on or off, configure settings for VPN and mobile networks, and enable your phone to share its mobile data connection as a portable Wi-Fi® hotspot, or through USB tethering or Bluetooth™ tethering.
Call settings	Manage and configure settings for fixed dialing numbers, voicemail and Internet calls.
Sound	Configure how your phone rings, vibrates, or alerts you when you receive communications. You can also use these settings to set the volume level for music, video, games or other media with audio, and to make related adjustments.
Display	Enable your phone screen to switch orientation when you rotate your phone. You can also set the brightness, font size, wallpaper and screen timeout.
Storage	Check out the available space on your phone's internal storage and on the SD card. You can also erase the SD card, or unmount it for safe removal.
Battery	View your phone battery and see how different applications consume battery power.
Apps	Manage running applications, downloaded applications and applications on the SD card.
Xperia™	Configure the USB connection mode, network connection type and Internet settings. You can also enable Facebook features inside applications.
Accounts & sync	Enable your phone to synchronise data with the synchronisation accounts that you add.
Location services	Enable or disable Google's location service, GPS satellites, and Location & Google search.
Security	Protect your phone by setting up different locks and passwords. You can also allow the installation of applications not from Google Play™.
Language & input	Select the phone language, adjust text input options, add words to the personal dictionary and configure speech settings.
Backup & reset	Back up your data and reset your phone.
Date & time	Set the time and date, or choose the network-provided values. Select your preferred date and hour format.
Accessibility	Enable your installed accessibility services and adjust related settings.

Developer options

Set options for application development. For example, you can show CPU usage on the phone display. You can also set the phone to enter debug mode when USB connections are active.

























About phone

View information about your phone, such as the model number, firmware version, phone number and signal. You can also update your software to the latest version.

Status and notification icons overview



Status icons













The following status icons may appear on your screen:

	Signal strength
	No signal
	Roaming
	GPRS is available
	EDGE is available
	3G is available
	Sending and downloading GPRS data
	Sending and downloading EDGE data
	Sending and downloading 3G data
	Battery status
	The battery is charging
	GPS is activated
	Airplane mode is activated
	The Bluetooth™ function is activated
	Connected to another Bluetooth™ device
	The SIM card is not inserted
	The microphone is muted
	The speakerphone is on
	Silent mode
	Vibrate mode
	An alarm is set
	Synchronisation is ongoing
	Problem with sign-in or synchronisation
	A Wi-Fi® connection is enabled and wireless networks are available



























Notification icons

The following notification icons may appear on your screen:

	New email message
	New text message or multimedia message
	New voicemail

-  An upcoming calendar event
-  A song is playing
-  The phone is connected to a computer via a USB cable
-  Warning message
-  Error message
-  Missed call
-  Call ongoing
-  Call on hold
-  Call forwarding on
-  Software updates available
-  Downloading data
-  Uploading data
-  More (undisplayed) notifications

Application overview

-  Use the Alarm and clock application to set various kinds of alarms.
-  Use your web browser to navigate and view web pages, manage bookmarks, and manage text and images.
-  Use the Calculator application to perform basic calculations.
-  Use the Calendar application to keep track of your events and manage your appointments.
-  Use the camera to take photos and record video clips.
-  Use the Contact application to manage phone numbers, email address and other information related to your contacts.
-  Access your downloaded applications.
-  Use the Email application to send and receive emails through both private and corporate accounts.
-  Use the Facebook application to engage in social networking with friends, family members and colleagues around the world.
-  Browse and listen to FM radio stations.
-  Use the Gallery application to view and to work with your photos and videos.
-  Use the Gmail™ application in your phone to read, write and organise email messages.
-  Search for information in your phone and on the web.
-  Use the Latitude application to view your friends' locations on a map and share your location.
-  View your current location, find other locations, and calculate routes using Google Maps™.
-  Go to Google Play™ to download free and paid applications for your phone.
-  Use the Messaging application to send and receive text and multimedia messages.
-  Use the Movies application to play videos in your phone, and share videos with your friends or on other devices using DLNA.
-  Use the Music player application to organise and play music, audio books and podcasts.
-  View the updates of music and videos that your friends have shared on Facebook.
-  Navigate your way using spoken, turn-by-turn instructions.
-  View news stories and weather forecasts.
-  Make phone calls by dialling the number manually or by using the smart dial function.
-  Search for places, for example, restaurants and cafés.
-  Customise power saving modes to reduce battery consumption.
-  Use the Video Unlimited™ application to rent and purchase videos.



Use the subscription-based Music Unlimited™ application to access millions of songs over a 3G or Wi-Fi® connection.



Optimise phone settings to suit your own requirements.



Use the Setup guide application to learn about basic functions and to get help setting up the phone.



Use the Google Talk™ application to chat with friends online.



Identify music tracks that you hear playing in your surroundings, and get artist, album and other info.



Use Timescape™ to collect all your communications into one integrated view, including social networking events and text messages.



Use the Help application to access user support directly in the phone. For example, you can access a User guide, troubleshooting information, plus tips and tricks.



Use YouTube™ to share and view videos from around the world.



Download and install new applications and updates.

! Some applications are not supported by all networks and/or service providers in all areas.

User support

Access user support directly in your phone through the Help application. For example, you can open a User guide with instructions on how to use your phone. You can also get troubleshooting and other help from the Sony Mobile support zone, and from the Sony Mobile Customer support service.

- Help application features:
 - User guide in the phone – read and search information on how to use your phone.
 - Educate yourself – read tips and tricks, get the latest news, and watch how-to videos.
 - Email support – send an email to our support team.
 - Support zone – visit www.sonymobile.com to get comprehensive support for your phone.
 - Troubleshooting – find common problems and error messages at the end of our User guides and on the support zone.
 - Customer support – if all else fails. The relevant support numbers are listed in the supplied *Important information* leaflet.
- ! An extended User guide is also available at www.sonymobile.com.

To access the Help application

- 1 From your Application screen, find and tap .
- 2 Find and tap the required support item.

Troubleshooting

My phone is not working as expected

If you experience problems with your phone, check these tips before you try anything else:

- Restart your phone.
- Remove and re-insert the battery and SIM card. Then restart your phone.
- Update your phone. Updating your phone ensures optimal performance and provides the latest enhancements. See *Updating your phone* on page 116 for more information.
- Reset your phone.

 Be patient while resetting your phone. Restarting the phone during a reset procedure may damage the phone permanently.

Resetting the phone

You can reset your phone to its original settings. When you perform a factory data reset, you reset the phone to the state it was in before you turned it on for the first time, and all personal data is erased. You can also reset the phone to the original settings without erasing your personal data. Before you perform a reset, make sure to back up any important data saved on your phone.

To reset the phone without erasing personal data

 To avoid permanent phone damage, do not restart the phone while a reset procedure is underway.

- 1 From your Home screen, tap .
- 2 Find and tap **Settings** > **Backup & reset**.
- 3 Tap **Settings reset** > **Reset phone**.
- 4 To confirm, tap **Reset settings**.

To perform a factory data reset

 To avoid permanent phone damage, do not restart the phone while a reset procedure is underway.

- 1 From your Home screen, tap .
- 2 Find and tap **Settings** > **Backup & reset**.
- 3 Tap **Factory data reset** > **Reset phone**.
- 4 To confirm, tap **Erase everything**.

I cannot charge the phone

The charger is not properly connected or the battery connection is poor. Remove the battery and clean the connectors.

No battery charging icon appears when phone starts charging

It may take a few minutes before the battery icon appears on the screen.

The battery performance is low

Follow our smart tips on how to get more out of your battery. See *Improving battery performance* on page 15.

My wired headset does not work

- Make sure the wired headset that you are using complies to the CTIA standard. Your phone supports the CTIA standard, and may not be fully compatible with other standards such as OMTP.
- If you have a wireless headset that is compatible with your phone, try using that instead.

I cannot transfer content between my phone and the computer, when using a USB cable

The software or the USB drivers have not been properly installed. Go to www.sonymobile.com for more detailed installation instructions and troubleshooting sections.

I cannot use Internet-based services

Make sure your subscription covers data downloads and that the Internet settings in your phone are correct. See *Internet and messaging settings* on page 33 for more information on how to enable data traffic, data roaming, and download Internet settings. Contact your network operator for more information about your subscription settings.

Error messages

No network coverage

- Your phone is in Airplane mode. Make sure Airplane mode is turned off.
- Your phone is not receiving any network signal, or the received signal is too weak. Contact your network operator and make sure that the network has coverage where you are.
- The SIM card is not working properly. Insert your SIM card in another phone. If this works, it is probably your phone that is causing the problem. In this case, contact the nearest Sony service center.

Emergency calls only

You are within range of a network, but you are not allowed to use it. However, in an emergency, some network operators allow you to call the international emergency number 112. See *Emergency calls* on page 37 for more information.

SIM card locked

You have entered your PIN incorrectly 3 times in a row. To unlock the phone, you need the PUK provided by your operator.

SIM card is PUK locked

You have entered your PUK (Personal Unblocking Key) incorrectly 10 times in a row. Please contact your service provider.

Recycling your phone

Got an old phone lying around the house? Why not recycle it? By doing so, you will help us reuse its materials and components, and you'll protect the environment, too! Find out more about the recycling options in your region at www.sonymobile.com.

Legal information

Sony ST26i/ST26a

This User guide is published by Sony Mobile Communications AB or its local affiliated company, without any warranty. Improvements and changes to this User guide necessitated by typographical errors, inaccuracies of current information, or improvements to programs and/or equipment, may be made by Sony Mobile Communications AB at any time and without notice. Such changes will, however, be incorporated into new editions of this User guide.

©Sony Mobile Communications AB, 2012.

All rights reserved.

Publication number: 1268-7245.1

Your mobile phone has the capability to download, store and forward additional content, for example, ringtones. The use of such content may be restricted or prohibited by rights of third parties, including but not limited to restriction under applicable copyright laws. You, and not Sony, are entirely responsible for additional content that you download to or forward from your mobile phone. Prior to your use of any additional content, please verify that your intended use is properly licensed or is otherwise authorized. Sony does not guarantee the accuracy, integrity or quality of any additional content or any other third party content. Under no circumstances will Sony be liable in any way for your improper use of additional content or other third party content.

This User guide may reference services or applications provided by third parties. Use of such programming or services may require separate registration with the third party provider and may be subject to additional terms of use. For applications accessed on or through a third-party website, please review such websites' terms of use and applicable privacy policy in advance. Sony does not warrant or guarantee the availability or performance of any third-party websites or offered services.

Remove the battery to see regulatory information such as the CE mark.

All product and company names mentioned herein are the trademarks or registered trademarks of their respective owners. Any rights not expressly granted herein are reserved. All other trademarks are property of their respective owners.

Visit www.sonymobile.com for more information.

All illustrations are for illustration purposes only and may not accurately depict the actual phone.

This product is protected by certain intellectual property rights of Microsoft. Use or distribution of such technology outside of this product is prohibited without a license from Microsoft.

Content owners use Windows Media digital rights management technology (WMDRM) to protect their intellectual property, including copyrights. This device uses WMDRM software to access WMDRM-protected content. If the WMDRM software fails to protect the content, content owners may ask Microsoft to revoke the software's ability to use WMDRM to play or copy protected content. Revocation does not affect unprotected content. When you download licenses for protected content, you agree that Microsoft may include a revocation list with the licenses. Content owners may require you to upgrade WMDRM to access their content. If you decline an upgrade, you will not be able to access content that requires the upgrade.

This product is licensed under the MPEG-4 visual and AVC patent portfolio licenses for the personal and non-commercial use of a consumer for (i) encoding video in compliance with the MPEG-4 visual standard ("MPEG-4 video") or the AVC standard ("AVC video") and/or (ii) decoding MPEG-4 or AVC video that was encoded by a consumer engaged in a personal and non-commercial activity and/or was obtained from a video provider licensed by MPEG LA to provide MPEG-4 and/or AVC video. No license is granted or shall be implied for any other use. Additional information including that relating to promotional, internal and commercial uses and licensing may be obtained from MPEG LA, L.L.C. See <http://www.mpegla.com>. MPEG Layer-3 audio decoding technology licensed from Fraunhofer IIS and Thomson.

Index

A	
accounts	11
Exchange Active Sync®	12
Facebook™	12
Google™	12
adjusting volume	77
Airplane mode	31
alarm	58
Album	95
map	99
online albums	100
opening	95
pictures	95
thumbnail size	96
viewing	95, 99, 100
viewing local content	95
viewing online photos	100
Android Market™ - See Google Play™	55
Android™	7
animated wallpaper	21
answering service	39
applications	7
arranging	23
overview	122
screen	22
sorting	23
audio	79
adjusting volume	77
playing tracks in random order	80
audio content	
related content	78
B	
back up	
contacts	47
battery	14
cover	8
removing	8
Bluetooth™ wireless technology	104
brightness	31
business cards	
sending	46
C	
calendar	58
create an event	58
calling	32
calls	37, 41
barring	40
diverting	40, 41
emergency	37
forwarding	41
list	38
log	38
missed	38
multiple	39
recent	38
reject	40
settings	40
waiting	39
camera	86, 87, 88, 92
closing	86
controls	86
geotagging	87
icons	92
overview	86
recording videos	91, 92
screen	86
self-portraits	87
settings	88, 92
taking photos	86, 87
using the flash	87
video	91
viewing photos	87
viewing videos	92
zoom	87
caps lock	25
charging	14
chat	54
conference calls	39
contacts	42
back up	47
copy	47
favourite	46
groups	46
importing from SIM card	43
joining contact information	45
picture	45
sending	46
sharing	46
transferring	43
using a photo with	97
corporate email, calendar and contacts	63
cropping	
photos	97
D	
data traffic	34
date	
format	30
deleting	
an alarm	58
music	82
photos	98
tracks	77
videos	98
download	
Internet settings	33
driving directions	111
E	
editing	
photos	97
email	50
more than one account	52
emergency numbers	37
equalizer	77
events	
calendar	58
extensions	19
F	
Facebook™	85
Facebook™ integration	63
synchronisation	63
favourites	
moving between in the radio	84
removing radio channels as	84
saving radio channels as	84
fixed dialling	41
flash	
using when taking photos	87
Flight mode - See Airplane mode	31
FM radio	
selecting a channel	83
front camera	86

G	
geotagging	
of photos	87
Gmail™	53
Google Latitude™	111
Google Maps™	111
Google Play™	55
Google Talk™	54
Google™ account setup	53
Google™ synchronisation	62
GPS	110
H	
headset	32
using	33
Home screen	19
customising	20
I	
icons	120
in the camera	92
importing SIM contacts	43
infinite button	78
input method	28
instant messaging	54
Internet	
settings	33
web browser	70
K	
keyboard	25
settings	28
keys	14
L	
language	31
writing	28
Latitude	111
LCD backlight control	31
"Like" a photo on Facebook™	100
"Like" a track on Facebook™	78
"Like" a video on Facebook™	100
live wallpaper	21
location	88, 110
locks	
activating the screen	11
locking the screen	11
screen lock	11
M	
Maps	111
media files	
copying to memory card	76
Media Go™	108
messages	
settings	33
Microsoft® Exchange synchronisation	63
MMS	
settings	33
movies	101
multimedia	
copying to memory card	76
music	32, 76
adjusting volume	77
changing tracks	77
copying to memory card	76
copying to/from a computer	76
creating playlists	80
deleting	77, 82
downloading music information	79
hearing protection	76
My playlists	80
pausing a track	77
podcasts	76
purchasing	81
searching using TrackID™	81
sharing	78, 81
shortcuts	79
using a headset	33
viewing artist info	81
music player	76, 79
adding tracks to playlists	80
creating playlists	80
deleting tracks	77
minimising	77
My music	78
playing tracks in random order	80
playlists	80
SensMe™ channels	79
using the equalizer	77
music player widget	80
N	
Navigation application	111
notification	120
light	24
panel	24
ringtone	30
O	
on-screen keyboard	25
overview	
phone	76
P	
pausing a track	77
personal information	42
phone	
battery	15
performance	15
update	116
phonebook	42
Phonepad	25, 27
photo albums	
viewing	95
photos	97
adding a geotag	97
adding the geographical position	87
associating with a contact	45
copying to/from a computer	76
cropping	97
deleting	98
editing	97
photo viewer	96
rotating	97
selecting	96
sharing	97
slideshow	97
taking	86, 87
using as a contact picture	97
using as wallpaper	97
viewing	87, 95, 96
viewing on a map	98
viewing same location	88
zooming	97
PIN	112
playlists	80
adding a track	80
creating	80
deleting	80
playing your own	80
removing tracks	80
power saver	16
activating	16

changing settings	16	exporting contacts to	47
deactivating	16	importing contacts from	43
displaying notifications	17	removing	9
power saving mode	16	slideshow	97
powering off	10	SOS - See emergency numbers	37
powering on	10	status	120
presets		bar	24
removing radio channels as	84	still camera	86
saving radio channels as	84	settings	88
protective plastic sheet	17	surround sound	77
PUK	112	symbols	25
purchasing		synchronising	62
music	81	calendar, bookmarks	12, 64
R		contacts	12, 64
radio	83	Facebook™ contacts, calendar, photos	63
favourites	84	Google™ contacts, calendar, email	62
listening to with the speaker	84	Microsoft® Exchange contacts, calendar, email	63
moving between channels	83	SyncML™	12, 64
opening	83	T	
overview	83	taking photos	86
searching for channels	84	by tapping	87
selecting a channel	83	self-portraits	87
using with Facebook™	85	telephony - See calls	37
receiving items using Bluetooth™	105	text input method	25
recent calls	38	themes	21
recently used applications window	23	time	30
recommending music	78	time management	58
recommending photos and videos	100	TrackID™ technology	81
recording videos	86	buying a track	81
recycling your phone	127	deleting a track	82
resetting	125	opening	81
resizing		searching for track information	81
photos	97	sharing a track	81
ringtone	58	using results	81
rotating		using with the FM Radio	84
photos	97	viewing artist info	81
S		viewing charts	81
scanning barcodes	61	transferring	
screen	31	contacts	43
cracked	17	troubleshooting	125
glass	17	turning off	10
screen unlock pattern	112	turning on	10
warranty	17	U	
searching		updating phone	116
music using TrackID™	81	USB connection	107
track information	81	V	
self-portrait	86	vibration	30, 58
sending		video albums	
business cards	46	viewing	95
contacts	46	video camera	86, 91, 92
sending items using Bluetooth™	105	recording videos	91, 92
SensMe™ channels	79	settings	92
services	11	videos	98
settings		adjusting volume	98
call	40	copying to/from a computer	76
camera	88, 92	deleting	98
data usage	34	fast forwarding and rewinding	98
Internet	33	pausing	98
messaging	33	playing	98
MMS	33	recording	91, 92
still camera	88	selecting	96
video camera	92	sending	98
setup guide	11	sharing	98
sharing		viewing	92, 95, 96
music	78, 81	viewing	
photos	97	movies	101
shuffle music	80	photos	87
silent mode	29	videos recorded using the camera	92
SIM card	112		

voicemail	39
volume	
adjusting for videos	98
key	29
W	
wallpaper	21
using a photo as	97
web browser	70
managing bookmarks	71
settings	74
Wi-Fi®	66
widgets	20
resizing	20
Timescape™ Feed	20
Timescape™ Friends	20
Timescape™ Share	20
wireless networks	110
Z	
zoom	87
zooming	
photos	97

Free Manuals Download Website

<http://myh66.com>

<http://usermanuals.us>

<http://www.somanuals.com>

<http://www.4manuals.cc>

<http://www.manual-lib.com>

<http://www.404manual.com>

<http://www.luxmanual.com>

<http://aubethermostatmanual.com>

Golf course search by state

<http://golfingnear.com>

Email search by domain

<http://emailbydomain.com>

Auto manuals search

<http://auto.somanuals.com>

TV manuals search

<http://tv.somanuals.com>