

CMD-Z28

SERVICE MANUAL

E Model

Ver 1.0 2001.06

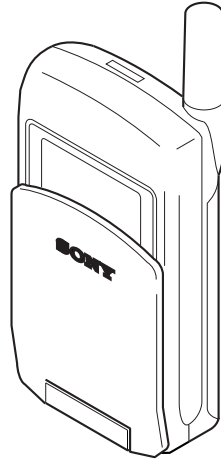

SPECIFICATIONS

Signalling format	Dual-Band
Frequency range	E-GSM 900 MHz, Transmit: 880 – 915 MHz Receive: 925 – 960 MHz DCS 1800 MHz, Transmit: 1710 – 1785 MHz Receive: 1805 – 1880 MHz
GSM power class	Class 4 (2W)
DCS power class	Class 1 (1W)
SIM chip	Pluggable mini SIM card
Display	High resolution grey scale full graphics display Resolution: 96 × 72 pixels Graphic Icons 5 lines × 12 (normal font numeric) characters
Channel spacing	200 kHz
Number of channels	E-GSM: 174 DCS: 374
Frequency stability	Transmit frequency drift (synchronized) < ± 0.1 p.p.m
RF output power	GSM: 2W DCS: 1W
Battery life	Standby: 30h – 130h standard battery 50h – 220h extended battery Talk time: 1h30 – 3h40 standard battery 2h30 – 6h extended battery
Power requirements	4.0 V (nominal)
Operating temperature	-10°C to +55°C
Accessories operating temperature	±0°C to +45°C
Battery pack charging temperature	±0°C to +40°C
Dimensions	88 mm × 47.5 mm × 22 mm
Weight	82 g
Volume	78 cm ³
<Supplied accessories>	
• AC Adaptor	QN-2TC
• Battery (std.)	QN-Z5BPS
• Desk Top Charger	QN-Z5DTC
• Hand Strap	
• AC Cable	

Design and specifications are subject to change without notice.

SONY®

TABLE OF CONTENTS

1. GENERAL	3
2. GENERAL DESCRIPTIONS	
2-1. Multi-band	4
2-2. Real Time Clock (RTC)	4
2-3. Vibra Functionality	4
2-4. Battery Safety	4
2-5. Battery Capacity	4
2-6. Accessory Interface	5
2-7. RF Antenna Connector/Antenna Switch	5
2-8. Languages	5
3. ACCESSORIES	
3-1. Travel Charger	6
3-2. Desk Top Charger (not for sale by itself)	6
3-3. Extended Battery (TBD)	6
3-4. Standard Battery	6
4. JIGS AND TOOLS	7
5. DISASSEMBLY	7
6. INTERFACE TO GSM-TESTER	9
7. PROGRAMMING INSTRUCTIONS	
7-1. Requirement	10
7-2. Hardware Set-up	10
7-3. Software Set-up	10
8. SAVE PERSONAL DATA IN MOBILE	11
9. EXPLODED VIEW	12

CAUTION

Danger of explosion if battery is incorrectly replaced.
Replace only with the same or equivalent type recommended by the manufacturer.
Discard used batteries according to the manufacturer's instructions.

ADVARSEL!

Lithiumbatteri-Eksplosionsfare ved fejlagtig håndtering.
Udskiftning må kun ske med batteri
af samme fabrikat og type.
Levér det brugte batteri tilbage til leverandøren.

ADVARSEL

Eksplosjonsfare ved feilaktig skifte av batteri.
Benytt samme batteritype eller en tilsvarende type
anbefalt av apparatfabrikanten.
Brukte batterier kasseres i henhold til fabrikantens
instruksjoner.

WARNING

Explosionsfara vid felaktigt batteribyte.
Använd samma batterityp eller en likvärdig typ som
rekommenderas av apparattillverkaren.
Kassera använt batteri enligt gällande föreskrifter.

VAROITUS

Paristo voi räjähtää, jos se on virheellisesti asennettu.
Vaihda paristo ainoastaan laitevalmistajan suosittelemaan tyyppiin.
Hävitä käytetty paristo valmistajan ohjeiden mukaisesti.

SAFETY-RELATED COMPONENT WARNING!!

COMPONENTS IDENTIFIED BY MARK \triangle OR DOTTED LINE
WITH MARK \triangle ON THE SCHEMATIC DIAGRAMS AND IN
THE PARTS LIST ARE CRITICAL TO SAFE OPERATION.
REPLACE THESE COMPONENTS WITH SONY PARTS WHOSE
PART NUMBERS APPEAR AS SHOWN IN THIS MANUAL OR
IN SUPPLEMENTS PUBLISHED BY SONY.

Welcome to Sony CMD-Z28

Welcome to the Sony CMD-Z28 designed for use in the worldwide network of GSM (Global System for Mobile Communications). Your phone is fully equipped with the Advanced Jog Dial and a visual menu for easy access and navigation - with only one hand!

What's Included in Your Kit

The kit should include the following:



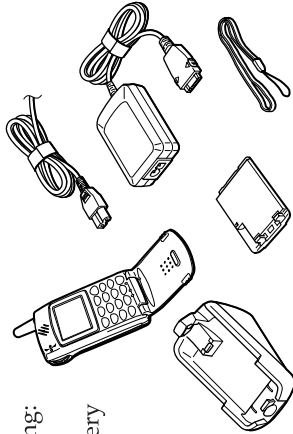

- One mobile phone
- One lithium ion standard battery
- One AC adaptor
- One AC cable
- One desktop holder
- One hand strap
- This manual

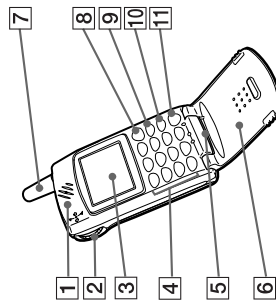

If one of these parts is missing, please contact your retail dealer immediately.

Parts and Controls



- 1 Ear piece
- 2 Advanced Jog Dial
- 3 Display
- 4 Keys (alphanumeric keys)
- 5 Microphone
- 6 Flip
- 7 Antenna
- 8 Send key 
- 9 Memo key 
- 10 Clear key 
- 11 On / Off key 
- 12 Battery pack
- 13 External connector (Charging and Accessories)
- 14 Ringer
- 15 Battery release hook
- 16 Charging indicator

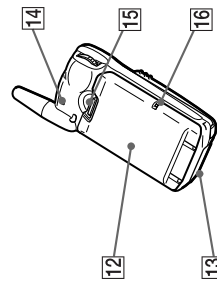



- 12 Silent
- 13 Single beep
- 14 Ringer
- 15 Go to
- 16 Search
- 17 Help notification









SECTION 1 GENERAL

Icon Glossary

Your phone lets you see at a glance if you have missed calls, have messages waiting and the status of options you have selected (for example if you have diverted your phone or turned the ringer off). Sony has developed the following icons to provide you with a quick overview of your mobile activity:



Status

Icon	Explanation
	Network signal strength
	Battery strength (flashing=battery level low)
	SMS message waiting (flashing=message storage full)
	Answering machine notification
	Answering machine on
	Network voice mail
	Active call
	Network not available (no calls possible)



Icon	Explanation
	Divert option activated
	Missed call
	Barring service in / out activated
	Barring service out activated
	Barring service in activated
	Alarm
	Ringer to Vibra alert
	Vibra alert to Ringer
	Vibra alert on



Manner

Icon	Explanation
	Silent
	Single beep

Icon	Explanation
	Vibra alert only
	Ringer off

Function

Icon	Explanation
	Go to
	Search
	Help notification

Icon	Explanation
	View
	Paste
	T9 (Text editing system)

SECTION 2 GENERAL DESCRIPTIONS

2-1 Multi-band :

CMD-Z28 support E-GSM 900 and DCS 1800 multi-band functionality.

Because the usage of multi-band depends on network capabilities, the phone is able to operate as a single band mobile in GSM 900 as well as in DCS 1800; In addition, it supports the extra functionality required for multi-band mobile stations: Inter-band/ "seamless" hand-over, channel assignment, cell selection and re-selection, all between both bands within a Public Land Mobile Network.

The manual and automatic PLMN selection in both bands is given.

The user does not need any special action to use the multi-band functionality of the phone.

Users are able to manually roam between PLMN's operating in GSM 900 and DCS 1800 bands.

The CMD-Z28 is a phase II, GSM 900 class 4, DCS 1800 class 1 mobile phone.

The nominal maximum output power for GSM 900 is 2 W, for DCS 1800 1 W.

2-2 Real Time Clock (RTC):

The real time clock is integrated into the phone.

When the mobile is switched on the RTC is powered via the CPP.

When the phone is powered down, the RTC is powered from the main battery via it's own low quiescent current regulator.

When the main battery is low or removed, a back-up battery keeps the clock alive.

After the main battery is removed the RTC keeps the time for 20 days (ability value).

2-3 Vibra Functionality

The vibrator is a 1.3 V device.

A general port pin of the SC1 controls the switch mode of the vibration motor. It is powered through regulator by an interface control unit.

If the mobile is in the phase of switching on or off the vibrator is off at all times.

2-4 Battery Safety

The battery pack contains a safety circuitry. The charging circuitry and the safety circuitry together guarantee a double fail-safe battery pack. This means that each component can be either short or open and still all the safety requirements will not be violated.

The safety concept protects against:

Over voltage: The charging is stopped when Battery Voltage (Vbat) reaches (4.24 V- 4.3 V). The charging resumes when Vbat falls below (4.06 V – 4.15 V).

Under voltage: When the cell voltage drops below (2.5 V – 2.7 V) the cell is disconnected for discharging.

Charging is still possible.

2-5 Battery Capacity:

Standard Battery 620 mAh typical Li-ion QN-Z5BPS

Extended Battery 1000 mAh typical Li-ion QN-Z5BPE (TBD)

The phone can be charged even during making phone calls.

However, the shortest charging time will be reached when the phone is switched off.

As the charging circuit is integrated in the battery pack, the phone cannot be powered up by the charger without the battery pack being attached.

2-6 Accessory Interface

The table explains what kind of pins the phone supplies to the different accessories.

Pins	GND 18	Charge 1/2	ACC_ power 3	Audio IN 14	Audio Out 13	ACC ID 11	ACC Detect 6	TX (OUT) 9	RX (IN) 10	AGND 12	RF GND 19/22	RF OUT 20
Travel charger (QN-2TC)	√	√										

I/O connector layout

Connector view from base of phone

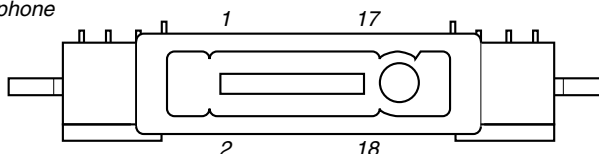

The connector comprises the following pins:

Detection:

The detection of accessory is done by the charge pin and the detect pin.

Any accessory with an active charge will wake up the phone, indicating the battery icon but can not be operated.

The insertion and removal of the charger (Cigar Lighter Charger, Desktop-Charger, AC-Charger) is detected via polling. To reduce the power consumption the polling can take up to 5 sec.

The insertion and removal of other accessory is detected via an Interrupt. This detection is only possible when the phone is powered up.

ID:

The ID pin indicates what kind of accessory is connected.

2-7 RF Antenna Connector / Antenna Switch

To connect an external antenna for accessory use, the CMD-Z28 contains a stable RF connector with an integrated mechanical switch. This connector is placed on the I/O connector. The integrated mechanical switch switches between the helix antenna and the external RF antenna connection. The switching criterium is mechanical pressure from the RF accessory connector.

2-8 Languages

The CMD-Z28 supports the following languages:

• English
• Chinese (Simplified)
• Chinese (Traditional)

SECTION 3 ACCESSORIES

3-1 Travel Charger

The Travel Charger QN-2TC is a small and lightweight device. It has a full Input Voltage Range from 110 – 240 Volts. Using a standard cable makes the connection to the mains socket.

Specifications:

Input voltage	110 to 240 V
Rated output voltage	5.0 V
Rated output current	500 mA

3-2 Desk Top Charger (not for sale by itself)

The desktop charger QN-Z5 DTC can charge either the Standard or Extended battery with the phone attached. The Desk Top Charger gets its power supply via the Power adapter or the Travel Charger QN-2TC.

Specifications:

Input voltage	DC 5 V
Rated output voltage	5.0 V
Rated output current	500 mA

3-3 Extended Battery (TBD)

Specifications:

Lithium Ion Battery	QN-Z5 BPE
Maximum output voltage	DC 4.2 V
Nominal output voltage	DC 4.0 V
Capacity	1000 mAh

3-4 Standard Battery

Specifications:

Lithium Ion Battery	QN-Z5 BPS
Maximum output voltage	DC 4.2 V
Nominal output voltage	DC 4.0 V
Capacity	620 mAh

SECTION 4 JIGS AND TOOLS

Description	Part No.	Remark
DATA TRANSFER JIG	1-792-172-11	NECESSARY FOR SOFTWARE UPDATE
HOOK RELEASE JIG	3-043-180-01	FOR HOUSING OPENING
TESTER CONNECTION CABLE	1-792-726-11	FOR CONNECTION TO GSM MEASURE EQUIPMENT

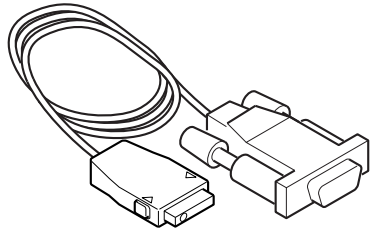

DATA TRANSFER JIG

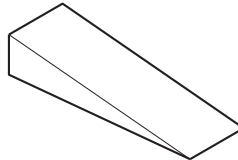

HOOK RELEASE JIG

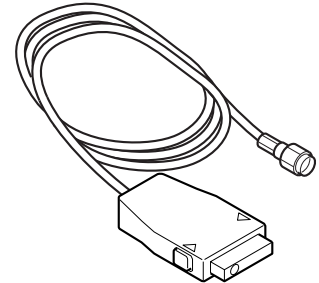

TESTER CONNECTION CABLE

SECTION 5 DISASSEMBLY

Note: Follow the disassembly procedure in the numerical order given.

CABINET (UPPER)

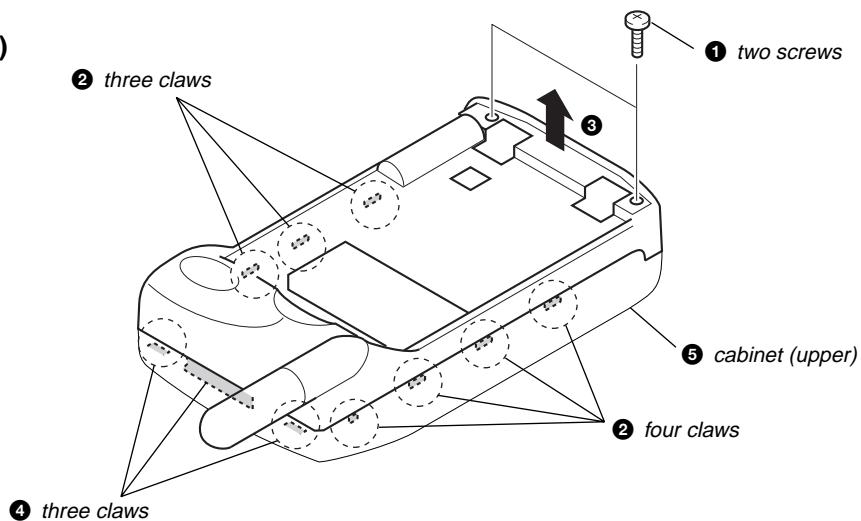

CABINET LOWER

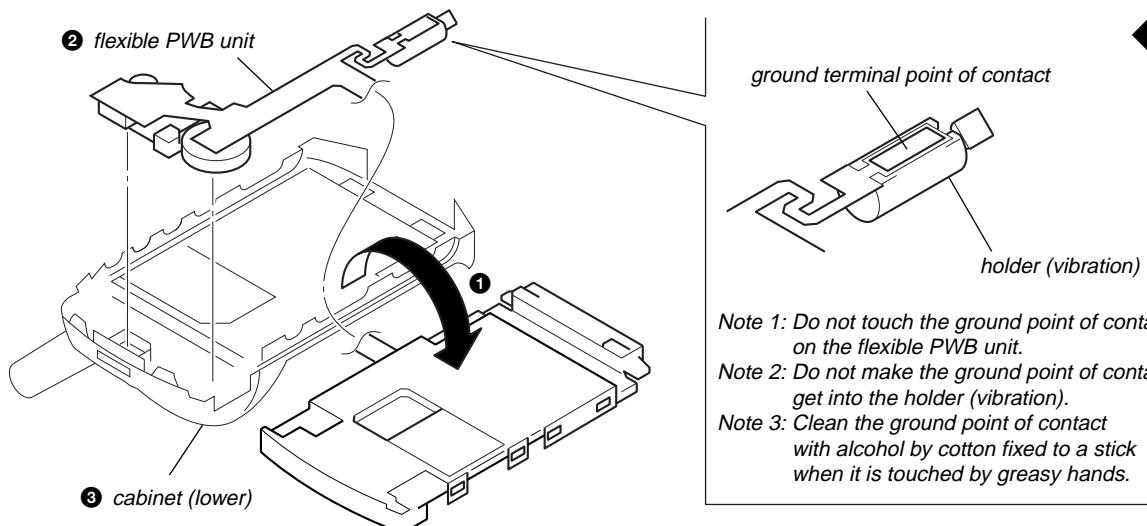

LCD

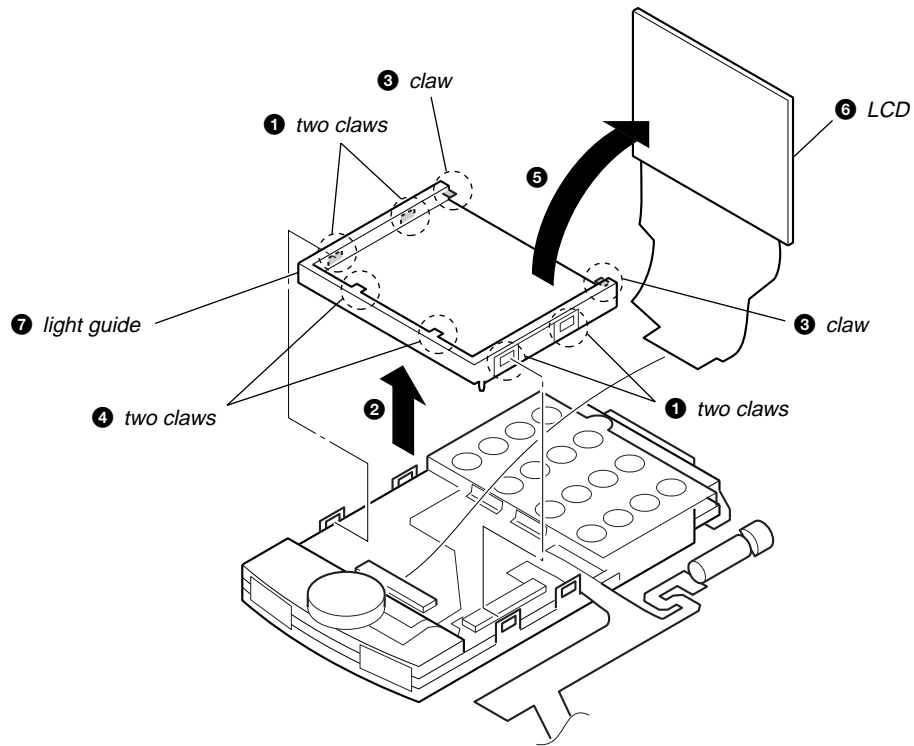

MAIN BOARD ASS'Y

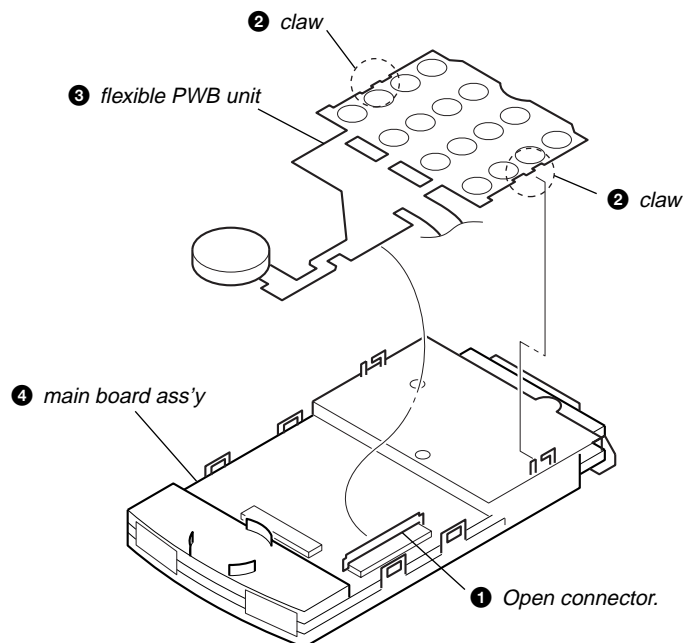

SECTION 6 INTERFACE TO GSM-TESTER

CMD-Z28 Level 1 Testing with GSM Tester

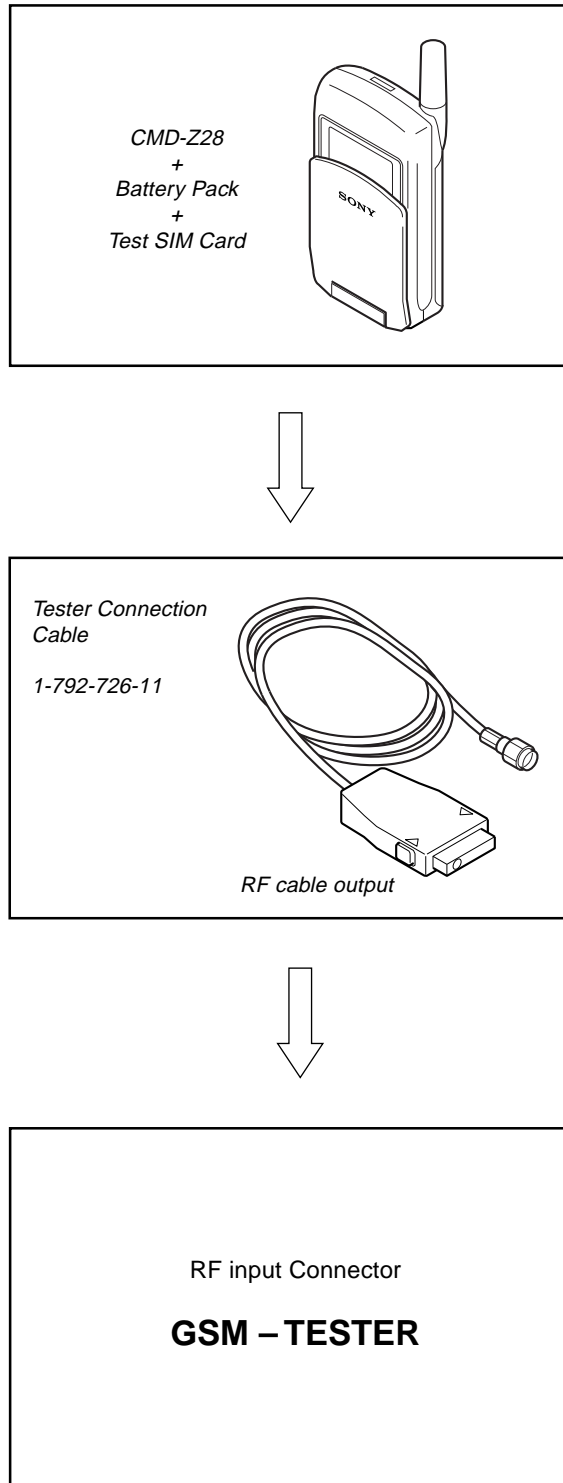

Level Test Procedure with GSM TESTER recommendation:

- Simulate GSM call processing – to check the functionality of transmit and receive audio of loudspeaker and microphone.
- Basic GSM transmission & reception parameter testing – to ensure handset's performance compile with standard GSM specification.

SECTION 7 PROGRAMMING INSTRUCTIONS

7-1 Requirement

- PC (486 type or higher) with Microsoft "Windows" Operating System
- One COM-port free for usage
- The Data Transfer Jig (p/n 1-792-172-11)

PREPARATION FOR SOFTWARE UPDATE

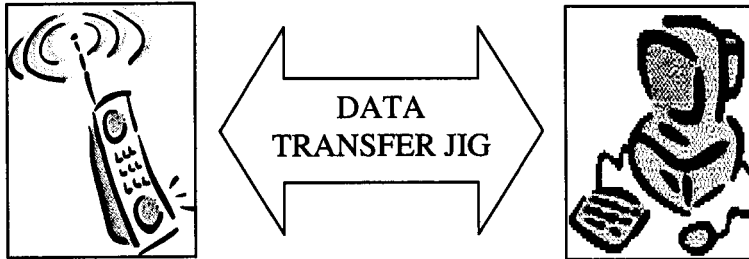

7-2 Hardware Set-up

- Copy all the files to the PC (define own directory).
- Connect the Data Transfer Jig to the PC COM-port (COM 1 or COM 2) and the CMD-Z28 external connector.
- Attach battery pack to CMD-Z28; the CMD-Z28 is powered up from the battery pack.
- The initial settings of the flash.exe program may not correspond with the normally correct settings. It is highly advisable to check the settings first (See page 12 for Software Set-up).

7-3 Software Set-up

Start the program Z28Loader.exe by double-clicking its icon on the Explorer in Windows.

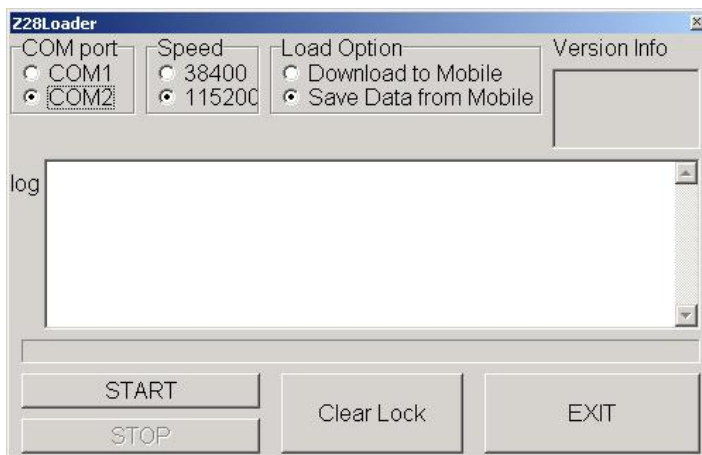

Z28 Loader.exe

Settings can be saved to "flash.ini" in the windows directory.

- Download Software to Mobile
 - Check Load Option to "Download to Mobile"
 - Click "START"
 - Select a file to download
 - Usually, you can download only a kind of file.
 - "nonvm.sre" Software without NVM area.
 - Flash erase area is automatically calculated with the contents of the file.
 - Connect CMD-Z28 and set battery pack, and then start loading.

SECTION 8

SAVE PERSONAL DATA IN MOBILE

Check Load Option to “Save Data in Mobile”

Click “START”

Select or input file to save data.

Connect CMD-Z28 and set battery pack, then start reading data from Mobile.

And then save read data in the selected file.

The read data can be downloaded to Mobile with this loader.

SECTION 9
EXPLODED VIEW

NOTE:

- The parts with no reference in the exploded view are not supplied.
- The construction parts of an assembled part are indicated with a collation number in the remark column.

The components identified by mark Δ or dotted line with mark Δ are critical for safety. Replace only with part number specified.

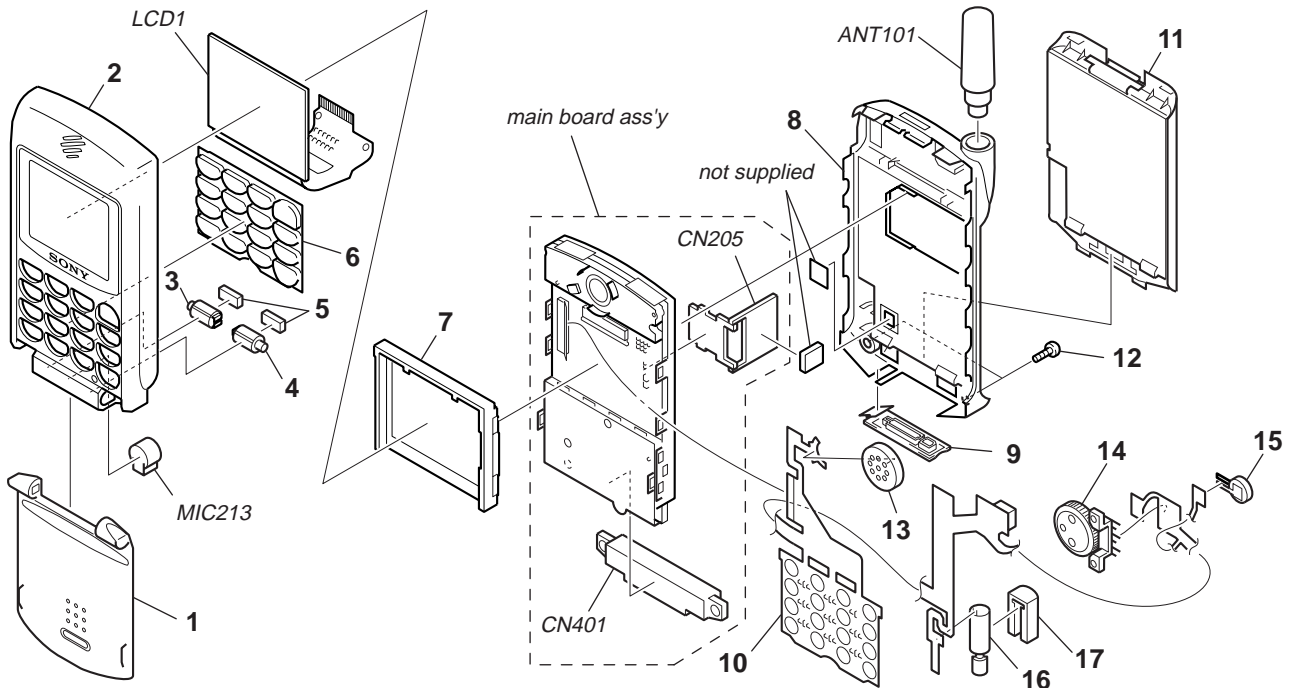

Ref. No.	Part No.	Description	Remark	Ref. No.	Part No.	Description	Remark
1	A-3649-323-A	CABINET (FLIP) ASSY		ANT101	1-754-123-11	ANTENNA (DUAL BAND)	
2	A-3649-322-A	CABINET (UPPER) ASSY		CN205	1-794-139-21	CONNECTOR, CARD (SIM)	
3	3-229-711-11	BEARING ASSY (L)		CN401	1-793-786-11	CONNECTOR, CELLULAR (WITH RF)	
4	3-229-712-11	BEARING ASSY (R)		LCD1	1-803-928-11	INDICATOR MODULE, LIQUID CRYSTAL	
5	3-046-958-01	CUSHION, BEARING		MIC213	1-542-470-11	MICROPHONE	
6	1-786-232-11	SWITCH, RUBBER KEY		*****			
7	X-3378-891-2	LIGHT GUIDE ASSY		ACCESSORIES & PACKING MATERIALS			
8	X-3380-985-1	CABINET REAR (S) ASSY		*****			
9	3-046-954-01	COVER (CONNECTOR)		Δ	1-418-645-14	AC POWER SUPPLY	
10	1-418-984-61	PWB UNIT, FLEXIBLE			1-418-868-13	DESK TOP CHARGER	
11	A-3649-324-A	BATTERY ASSY			1-791-964-12	CORD SET, POWER (EURO TYPE)	
12	3-926-356-01	SCREW (ROTARY SWITCH), FITTING			1-792-884-11	CORD SET, POWER (UK TYPE)	
13	1-544-939-11	SPEAKER			3-234-126-11	MANUAL, INSTRUCTION (ENGLISH)	
14	1-418-983-11	ENCODER, ROTARY			3-234-126-31	MANUAL, INSTRUCTION	
15	1-528-999-11	BATTERY, LITHIUM SECONDARY				(TRADITIONAL CHINESE)	
16	1-763-510-11	MOTOR, DC			3-047-243-01	HAND STRAP	
17	3-046-962-01	HOLDER (VIBRATION)					

(Hong Kong/Malaysia)

9-873-707-01

Sony Corporation
Digital Telecommunications Network Company

2001F0500-1
© 2001. 6

Free Manuals Download Website

<http://myh66.com>

<http://usermanuals.us>

<http://www.somanuals.com>

<http://www.4manuals.cc>

<http://www.manual-lib.com>

<http://www.404manual.com>

<http://www.luxmanual.com>

<http://aubethermostatmanual.com>

Golf course search by state

<http://golfingnear.com>

Email search by domain

<http://emailbydomain.com>

Auto manuals search

<http://auto.somanuals.com>

TV manuals search

<http://tv.somanuals.com>