

FM/MW/LW Compact Disc Player

Operating Instructions _____ **GB**

使用說明書 _____ **CT**

For installation and connections, see the supplied installation/connections manual.
關於本機的安裝及線路連接，請參見提供的“安裝／線路連接說明書”。



CDX-M1000TF

© 2003 Sony Corporation

Download from www.Somanuals.com. All Manuals Search And Download.

Welcome !

Thank you for purchasing this Sony Compact Disc Player.

FEATURING:

- MP3 file playback recorded on a disc is possible.
- CD-R/CD-RW which can have a session added can be played (page 7).
- Discs recorded in Multi Session (CD-Extra, Mixed CD, etc.) can be played, depending on the recording method (page 7).
- Optional CD/MD units (both changers and players)*1.
- ID3 tag*2 version 1 information (displayed when an MP3 file is played).
- CD TEXT information (displayed when a CD TEXT disc*3 is played).
- **Supplied controller accessory**
Card remote commander RM-X132
- **Optional controller accessories**
Rotary commander RM-X4S
Wireless rotary commander RM-X6S

*1 *This unit works with Sony products only.*

*2 *ID3 tag is an MP3 file that contains information about album name, artist name, track name, etc.*

*3 *A CD TEXT disc is an audio CD that includes information such as the disc name, artist name, and track names. This information is recorded on the disc.*

Instructions in this manual describe how to use the unit by mainly using the card remote commander.

Illustrations in this manual may differ from the actual device.



This label is located on the bottom of the chassis.



This label is located on the drive unit's internal chassis.

Table of Contents

Location of controls	4
Precautions	6
Notes on discs	6
About MP3 files	7
General top menu display	9

Getting Started

Resetting the unit	10
Setting the clock and the calendar	10

CD Player

CD/MD Unit (optional)

Playing a disc	11
Display items	12
Playing tracks repeatedly — Repeat Play	13
Playing tracks in random order — Shuffle Play	13
Labelling a CD — Disc Memo*	14
Locating a disc by name — List-up*	15

* Functions available with optional CD/MD unit

Radio

Storing stations automatically — Best Tuning Memory (BTM)	15
Display items	16
Receiving the stored stations	16
Storing only desired stations	17
Tuning in a station through a list — List-up	17

RDS

Overview of RDS	18
Automatic retuning for best reception results — AF function	19
Receiving traffic announcements — TA/TP	20
Presetting RDS stations with AF and TA setting	20
Tuning in stations by programme type — PTY	21
Setting the clock automatically — CT	22

Image Settings

Selecting the display mode and display pattern	23
Clearing display characters automatically — AutoClear (Spectrum analyzer/Pano- rama/Screen Saver mode)	25
Changing the translucence ratio of the characters — BlendLevel (Spectrum analyzer/ Panorama/Screen Saver mode)	25
Setting a Plaque — Plaque	26
Setting the character colour — Color Sel	26
Selecting the display period of the images — AutoImage	27

Other Functions

Using the rotary commander	28
Adjusting the sound characteristics	29
Quickly attenuating the sound	29
Changing the sound and display settings — Menu	30
Setting the Dynamic Soundstage Organiser (DSO)	31
Setting the equaliser (EQ7)	31
Adjusting the front and rear volume	32
Adjusting the volume of the subwoofer(s)	33
Connecting auxiliary audio equipment	34
Setting the security code	35

Additional Information

Maintenance	36
Removing the unit	37
Specifications	38
Troubleshooting	39
Error displays/Message	40

Location of controls

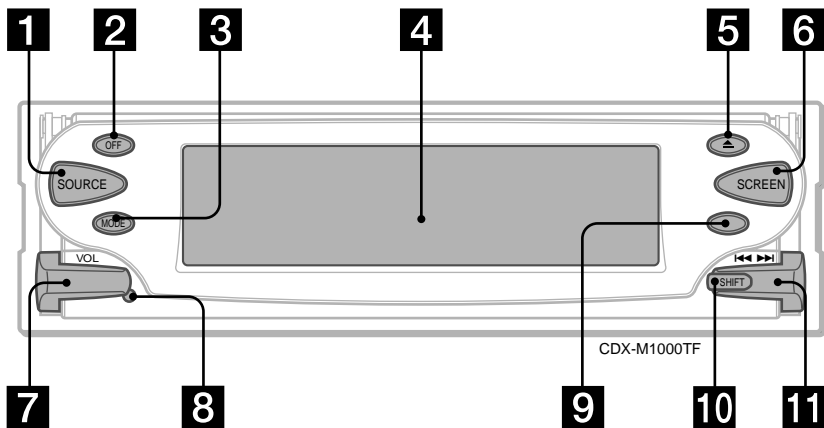

Refer to the pages listed for details.

- 1 SOURCE (Power on/Radio/CD/MD/AUX*1) button**
To select the source.
- 2 OFF (Stop/Power off) button*2** 11, 34
- 3 MODE button**
To change the operation.
- 4 Display window**
- 5 ▲ (eject) OPEN/CLOSE button**
To eject a disc, if a disc is already in the unit.
To open/close the front panel.
- 6 SCREEN button**
To select the display mode.
- 7 VOL (volume) control lever**
To turn up or down the volume by pressing up or down the VOL lever.
- 8 Reset button** 10
- 9 Receptor for the card remote commander and wireless rotary commander**
- 10 SHIFT (switching shift 1-3) button**
To change the function of the **11** lever (**11**).

11 ◀▶▶▶ lever

To select the desired radio station, the desired item to be adjusted, or the desired image by pressing up or down the **11** lever.

Press up

Press down

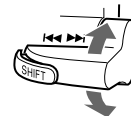

*1 When an optional CD/MD unit is connected, "AUX" is not displayed.

*2 **Warning**
when installing in a car without an ACC (accessory) position on the ignition switch
After turning off the ignition, be sure to press and hold (OFF) on the unit until the display disappears.
Otherwise, the clock display does not turn off and causes battery drain.

Card remote commander RM-X132

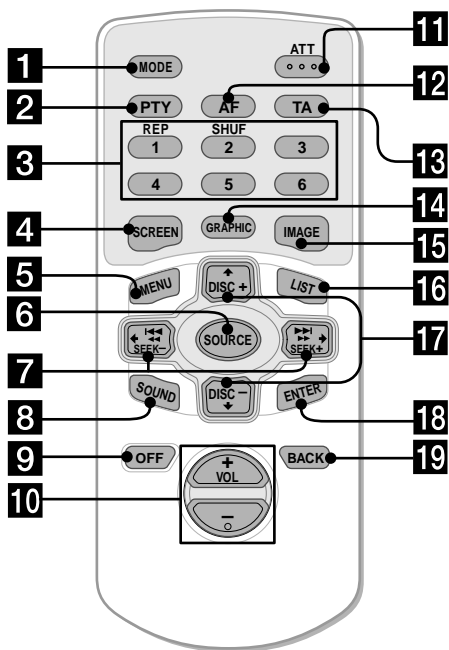

The corresponding buttons of the card remote commander control the same functions as those on this unit.

Instructions in this manual describe how to use the unit by mainly using the card remote commander.

Refer to the pages listed for details.

- 1** MODE button
- 2** PTY button
- 3** Number buttons
 - ① REP 13
 - ② SHUF 13To store stations and receive stored stations.
- 4** SCREEN button
- 5** MENU button
To display the general menus.
- 6** SOURCE button
- 7** \leftarrow/\rightarrow (SEEK $-/+$) buttons
- 8** SOUND button
To display the sound menus.
- 9** OFF button
- 10** VOL (+/-) buttons
- 11** ATT button 29
- 12** AF button 19
- 13** TA button 20
- 14** GRAPHIC button
To display the graphic menus.
- 15** IMAGE button
To switch the display patterns.
- 16** LIST button 15, 17
- 17** \uparrow/\downarrow (DISC $+/-$) buttons
- 18** ENTER button
To enter a setting.
- 19** BACK button
In a setting, to return to a previous operation.

Note

If the display disappears by pressing (OFF), it cannot be operated with the card remote commander unless (SOURCE) on the unit is pressed, or a disc is inserted to activate the unit first.

Tip

See "Replacing the lithium battery" on page 36 for details on how to replace the batteries.

Precautions

- If your car was parked in direct sunlight, allow the unit to cool off before operating it.
- Power aeriels will extend automatically while the unit is operating.
- Do not use the CUSTOM FILE feature while driving, or perform any other function which could divert your attention from the road.

If you have any questions or problems concerning your unit that are not covered in this manual, please consult your nearest Sony dealer.

Moisture condensation

On a rainy day or in a very damp area, moisture condensation may occur inside the lenses and display of the unit. Should this occur, the unit will not operate properly. In such a case, remove the disc and wait for about an hour until the moisture has evaporated.

To maintain high sound quality

Be careful not to splash juice or other soft drinks onto the unit or discs.

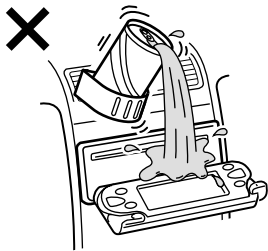

Notes on LCD display

- Do not push the LCD display strongly. It may cause injury or damage the display.
- Bright points of light (red, blue, or green) or black dots may appear on the LCD display. This is not a malfunction. The LCD is made with high-precision technology and more than 99.99 % of the picture element is intact. However, tiny elements of the picture may show the above symptoms.

Notes on discs

- To keep discs clean, do not touch the surface. Handle a disc by its edge.
- Keep your discs in their cases or disc magazines when not in use. Do not subject the discs to heat/high temperature. Avoid leaving them in parked cars or on dashboards/rear trays.

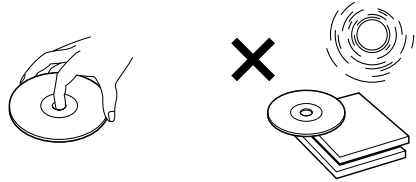

- Do not attach labels, or use discs with sticky ink/residue. Such discs may stop spinning when used, causing a malfunction, or may ruin the disc.

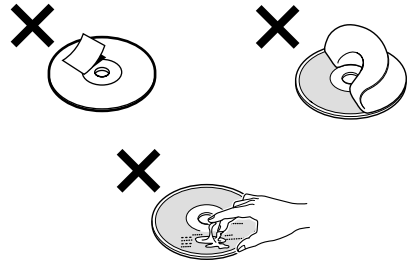

- Do not use any discs with labels or stickers attached. The following malfunctions may result from using such discs:
 - Inability to eject a disc (due to a label or sticker peeling off and jamming the eject mechanism).
 - Inability to read audio data correctly (e.g., playback skipping, or no playback) due to heat shrinking of a sticker or label causing a disc to warp.
- Discs with non-standard shapes (e.g., heart, square, star) cannot be played on this unit. Attempting to do so may damage the unit. Do not use such discs.
- You cannot play 8 cm CDs.

- Before playing, clean the discs with a commercially available cleaning cloth. Wipe each disc from the center out. Do not use solvents such as benzine, thinner, commercially available cleaners, or antistatic spray intended for analog discs.









Music discs encoded with copyright protection

This product is designed to play back discs that conform to the Compact Disc (CD) standard. Recently, various music discs encoded with copyright protection are marketed by some record companies. Please be aware that among those discs, there are some that do not conform to the CD standard and may not be playable by this product.

Notes on CD-Rs (recordable CDs)/CD-RWs (rewritable CDs)

This unit can play the following discs:

Type of discs	Label on the disc
Audio CD	 
MP3 files	   

- Some CD-Rs/CD-RWs (depending on the equipment used for its recording or the condition of the disc) may not play on this unit.
- You cannot play a CD-R/CD-RW that is not finalized*.
- You can play MP3 files recorded on CD-ROMs, CD-Rs, and CD-RWs.
- A CD-R/CD-RW to which a session can be added can be played.

* A process necessary for a recorded CD-R/CD-RW disc to be played on the audio CD player.

About MP3 files

MP3 (MPEG 1 Audio Layer-3) is a standard technology and format for compressing a sound sequence. The file is compressed to about 1/10 of its original size. Sounds outside the range of human hearing are compressed while the sounds we can hear are not compressed.

Notes on discs

You can play MP3 files recorded on CD-ROMs, CD-Rs, and CD-RWs.

The disc must be in the ISO 9660*1 level 1 or level 2 format, or Joliet or Romeo in the expansion format.

You can use a disc recorded in Multi Session*2.

*1 ISO 9660 Format

The most common international standard for the logical format of files and folders on a CD-ROM.

There are several specification levels. In Level 1, file names must be in the 8.3 format (no more than 8 characters in the name, no more than 3 characters in the extension “.MP3”) and in capital letters. Folder names can be no longer than 8 characters. There can be no more than 8 nested folder levels. Level 2 specifications allow file names up to 31 characters long.

Each folder can have up to 8 trees.

For Joliet or Romeo in the expansion format, make sure of the contents of the writing software, etc.

*2 Multi Session

This is a recording method that enables adding of data using the Track-At-Once method. Conventional CDs begin at a CD control area called the Lead-in and end at an area called Lead-out. A Multi Session CD is a CD having multiple sessions, with each segment from Lead-in to Lead-out regarded as a single session.

CD-Extra: The format which records audio (audio CD data) as tracks on session 1, and records data as tracks on session 2.

Mixed CD: In this format, data is recorded as track 1, and audio (audio CD data) is recorded as track 2.

continue to next page →

Notes

- With formats other than ISO 9660 level 1 and level 2, folder names or file names may not be displayed correctly.
- When naming, be sure to add the file extension “.MP3” to the file name.
- If you put the extension “.MP3” to a file other than MP3, the unit cannot recognize the file properly and will generate random noise that could damage your speakers.
- The following discs take a longer time to start playback.
 - a disc recorded with complicated tree structure.
 - a disc recorded in Multi Session.
 - a disc to which data can be added.

Cautions when playing a disc that is recorded in Multi Session

- When the first track of the first session is audio CD data:
 - Only audio CD data is played back.
 - Non-audio CD data/MP3 file information (track number, time, etc.) is displayed with no sound.
- When the first track of the first session is not audio CD data:
 - If an MP3 file is in the disc, only MP3 file(s) play back and other data is skipped (Audio CD data is not recognized).
 - If no MP3 file is in the disc, “NO Music” is displayed and nothing is played back (Audio CD data is not recognized).

The playback order of the MP3 files

The playback order of the folders and files is as follows:

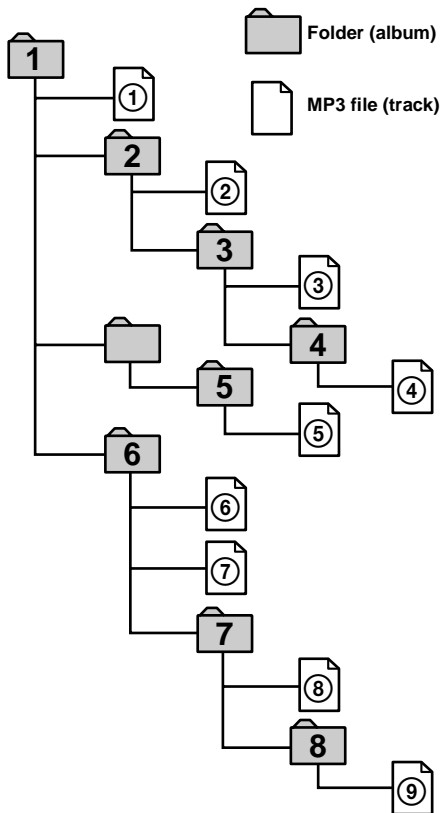

Tree 1 (root) Tree 2 Tree 3 Tree 4 Tree 5

Notes

- A folder that does not include an MP3 file is skipped.
- Maximum folder number: 150 (including root folder and empty folders).
- The maximum number of MP3 files and folders that can be contained in a disc: 300.
When a file/folder name contains many characters, this number may become less than 300.
- The maximum number of trees which can be played: 8.

Tip

To specify a desired playback order, before the folder or file name, input the order by number (e.g., “01,” “02”), then record contents onto a disc (The order differs depending on the writing software).

General top menu display

Press (MENU) to enter the general top menus, then select the category of menu. In the general menu display you can select various settings. To select, press (ENTER). To return to a previous operation, press (BACK). To complete the setting and return to the normal display, press (MENU).



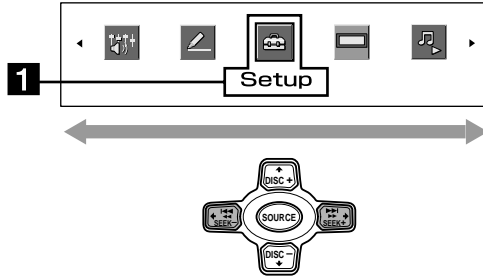

General top menu display

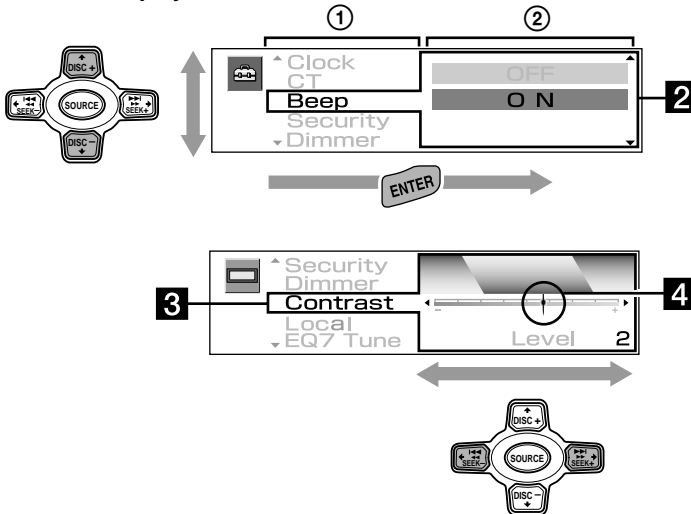

General menu display



Icons and the contents of settings

-  **Setup**
Basic settings
-  **Display**
Display setting
-  **PlayMode**
Settings for playback and radio reception
-  **SoundTuning**
Precise settings for sound quality
-  **Edit**
Display character setting

1 Selected category menu

Example: Setup

2 Selected item and setting

Example: Beep ON

Note

To move ① to ②, press (ENTER).

3 Selected item and setting

Example: Contrast Level 2

4 The light moves as the level changes

Note

The displayed item will differ depending on the source.

Getting Started

Resetting the unit

Before operating the unit for the first time, or after replacing the car battery or changing the connections, you must reset the unit. Press the reset button with a pointed object, such as a ballpoint pen.

After the reset is complete, the pre-stored images are displayed. Press (IMAGE) on the card remote commander to show the clock display and set the clock and calendar.



Reset button

Note

Pressing the reset button will erase the clock/calendar setting and some stored contents.

Setting the clock and the calendar

The clock uses a 24-hour digital indication (Day/Month/Year Time).

The factory setting is "01/01/2003 01:00."

- 1 Press (MENU).
- 2 Press ← or → repeatedly to select "Setup."

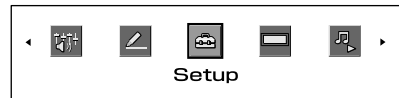

- 3 Press (ENTER).
- 4 Press ↑ or ↓ repeatedly to select "Clock."
- 5 Press (ENTER).

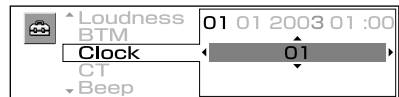

- 1 Press ↑ or ↓ repeatedly to set the day.
Each time you press ↑, the number of the day increases.
Each time you press ↓, the number of the day decreases.
- 2 Press → to move to the month, then press ↑ or ↓ repeatedly to set the month.
If you press ←, you can move back to the left.
- 3 Repeat step 2 to set the year, the hour, and the minute.
- 6 Press (ENTER).
The settings for clock and calendar are stored, and the display returns to the normal display.

Note

If your car has no ACC position, turn on the power of this unit first, then set the clock and the calendar.

Tip

You can set the year from 2000 to 2099.

CD Player

CD/MD Unit (optional)

In addition to playing a CD with this unit, you can also control external CD/MD units.

Note

If you connect an optional CD unit with the CD TEXT function, the CD TEXT information will appear in the display when you play a CD TEXT disc.



Operation by this unit



Operation by card remote commander



To	Press
Stop playback	(OFF)
Skip tracks – Automatic Music Sensor	◀/▶ [once for each track]
Fast-forward/ reverse – Manual Search	▶/▶▶ [hold until the desired point]
Skip discs – Disc selection	↑/↓ [once for each disc]
Skip albums* – Album selection	↑/↓ [once for each album]

* Available only when an MP3 file is played.

Notes

- There is a delay for a few seconds after pressing **▲** before the disc is ejected, while the data in the disc is being read.
- If you press **▲** on the front panel to eject a disc and leave it in the slot, the disc protective function will work. The ejected disc will be automatically pulled in the slot 15 seconds after being ejected.
- Do not apply excessive pressure to the front panel (especially when it is open), as this may cause a malfunction.
- Depending on the recording method used on the disc, it may take a minute or more before playing the first track.
- Depending on the condition of the disc, it may not play back (page 6, 7).
- While the first/last track on the disc is playing, if **↓** or **↑** is pressed, playback skips to the last/first track of the disc.
- When the last track on the disc has finished, playback restarts from the first track of the disc.
- With the optional unit connected, playback of the same source will continue on to the optional CD/MD unit.

Playing a disc

(With this unit)

Press **▲** to open the front panel and insert the disc (labelled side up).

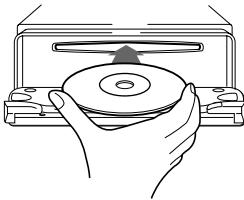

The front panel closes and playback starts automatically.

If a disc is already inserted, press **(SOURCE)** repeatedly until “**CD**” (CD icon) or “**CD**” appears in the display, and playback starts.

Note

The front panel closes automatically after the caution alarm beeps.



To	Press
Stop playback	(OFF)
Eject the disc	▲
Skip tracks – Automatic Music Sensor	◀▶▶▶ lever up/down [once for each track]
Fast-forward/ reverse – Manual Search	▶▶▶▶ lever up/down [hold until the desired point]
Skip albums* – Album selection	(SHIFT) , then ◀▶▶▶ lever up/down [once for each album]

(With optional unit)

1 Press **(SOURCE)** repeatedly until “**CD**” (CD icon), “**CD**”, “**MD** (MD icon)”, “**MD**”, or “**MS***” appears.

2 Press **(MODE)** repeatedly until the desired unit appears.
Playback starts.

* MS: MG Memory Stick System-up Player MGS-X1.

Locating a track and disc

See “Locating a disc by name” on page 15.

Display items

When the disc/album*¹/track changes, any prerecorded title of the new disc/album/track is automatically displayed. If "AutoScroll" is set to "ON," names will be scrolled (page 30).

Standard mode:

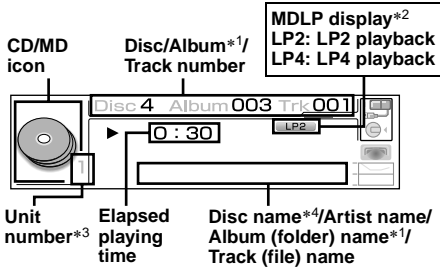

Spectrum analyser/Panorama/Screen saver mode:

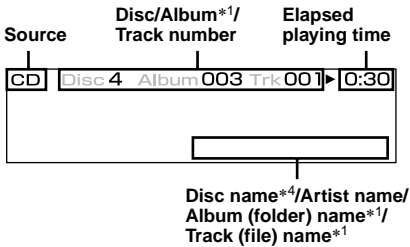

Clock mode:

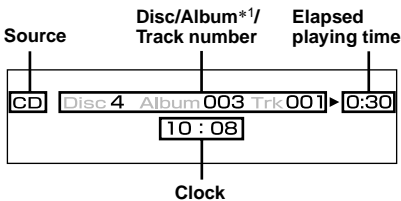

*¹ Available only when an MP3 file is played.
 *² Available only when an optional MD unit with the MDLP function is connected, and an MDLP disc is played.
 *³ Available only when two or more optional CD (MD) units are connected.
 *⁴ If the disc has been labelled by this unit using the CUSTOM FILE function, Disc Memo is displayed accordingly.

Notes

- Some characters cannot be displayed.
- For some CD TEXT discs with very many characters, some information may not be displayed nor scroll.
- This unit cannot display the artist name for each track of a CD TEXT disc.

Notes on MP3

- When playing MP3 with ID3 tag, ID3 tag (artist name/album name/track name) is displayed.
- ID3 tag applies only to version 1.
- The ID3 tag character codes comply with ASCII and ISO 8859-1 standards. Joliet format discs can only be displayed in ASCII. Incompatible characters will be displayed as "*".
- In the following cases, elapsed playing time may not be displayed accurately.
 - when an MP3 file of VBR (variable bit rate) is played.
 - during fast-forward/reverse.

Tip

When "AutoScroll" is set to "OFF" and the disc/album/track name is changed, the disc/album/track name does not scroll.

Playing tracks repeatedly

— Repeat Play

You can select:

- **REP** — to repeat the current track.
- **REP** *1 — to repeat the tracks in the current album.
- **REP** *2 — to repeat the tracks in the current disc.

*1 Available only when an MP3 file is played.

*2 Available only when one or more optional CD/MD units are connected.

During playback, press (REP) repeatedly until the desired setting appears in the display.

Repeat Play starts.

To return to normal play mode, press (REP) repeatedly until the icon disappears from the display.

Playing tracks in random order

— Shuffle Play

You can select:

- **SHUF** *1 — to play the tracks in the current album in random order.
- **SHUF** — to play the tracks on the current disc in random order.
- **SHUF** *2 — to play the tracks in the current optional CD (MD) unit in random order.
- **SHUF All** *3 — to play all the tracks in all the connected CD (MD) units (including this unit) in random order.

*1 Available only when an MP3 file is played.

*2 Available only when one or more optional CD (MD) units are connected.

*3 Available only when one or more optional CD units, or two or more optional MD units are connected.

During playback, press (SHUF) repeatedly until the desired setting appears in the display.

Shuffle Play starts.

To return to normal play mode, press (SHUF) repeatedly until the icon disappears from the display.

Note

"**SHUF All**" will not shuffle tracks between CD units and MD units.

Labelling a CD

— Disc Memo (With an optional CD unit with the CUSTOM FILE function)

You can label each disc with a custom name (Disc Memo). You can enter up to 8 characters for a disc. If you label a CD, you can locate the disc by name (page 15).

As a display item, the Disc Memo always takes priority over any original CD TEXT information.

Caution

Do not use the CUSTOM FILE feature while driving, or perform any other function which could divert your attention from the road.

- 1 Start playing a disc you want to label.
- 2 Press **(MENU)**.
- 3 Press **←** or **→** repeatedly to select "Edit."
- 4 Press **(ENTER)**.
- 5 Press **↑** or **↓** to select "Name Edit."
- 6 Press **(ENTER)**.



7 Enter the characters.

- 1 Press **↑***1 repeatedly to select the desired character.

A → B → C ... → 0 → 1 → 2 ... → + →
- → * ... → ■*2 → A

*1 For reverse order, press **↓**.

*2 blank space

- 2 Press **→** after locating the desired character.



If you press **←**, you can move back to the left.

- 3 Repeat steps 1 and 2 to enter the entire name.
- 8 Press **(ENTER)**.
The display returns to the top menu display.
- 9 Press **(MENU)**.
The display returns to the normal display.

Tips

- Simply overwrite or enter a blank space to correct or erase a name.
- You can label CDs on a unit without the CUSTOM FILE function if that unit is connected along with a CD unit that has the function. The Disc Memo will be stored in the memory of the CD unit with the CUSTOM FILE function.

Note

Repeat/shuffle play is suspended until the Name Edit is complete.

Erasing the Disc Memo

- 1 Press **(SOURCE)** repeatedly to select "CD."
- 2 Press **(MODE)** repeatedly to select the CD unit with the CUSTOM FILE function.
- 3 Press **(MENU)**.
- 4 Press **←** or **→** repeatedly to select "Edit."
- 5 Press **(ENTER)**.
- 6 Press **↑** or **↓** to select "Name Del."
- 7 Press **(ENTER)**.

The stored names will appear.



- 8 Press **↑** or **↓** repeatedly to select the disc name you want to erase.
- 9 Press **(ENTER)** for 2 seconds.
The name is erased.
Repeat steps 8 and 9 if you want to erase other names.
- 10 Press **(MENU)**.
The display returns to the normal display.

Notes

- When the Disc Memo for a CD TEXT disc is erased, the original CD TEXT information is displayed.
- If you cannot find the Disc Memo you want to erase, try selecting a different CD unit in step 2.

Tips

- In step 7, if there is no Disc Memo, the display will return to the normal display automatically.
- If all the Disc Memo is deleted in step 9, the display will return to the normal display automatically.

Locating a disc by name

— List-up

(With an optional CD unit with the CD TEXT/CUSTOM FILE function, or an MD unit)

You can use this function for discs that have been assigned custom names*1 or for CD TEXT discs*2.

1 Press **(LIST)**.

The assigned disc name appears in the display.

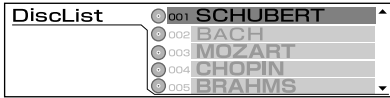

2 Press **↑** or **↓** repeatedly to select the desired disc.

3 Press **(ENTER)**.

*1 Locating a disc by its custom name: when you assign a name for a CD (page 14) or an MD.

*2 Locating discs by the CD TEXT information: when you play a CD TEXT disc on a CD unit with the CD TEXT function.

Note

In the case of CD TEXT discs and MDs, some letters cannot be displayed.

Tip

To stop selecting and return to the normal display, press **(LIST)**.

Radio

The unit can store up to 6 stations per band (FM1, FM2, FM3, MW, and LW).

Caution

When tuning in stations while driving, use Best Tuning Memory (BTM) to prevent accidents.

Storing stations automatically

— Best Tuning Memory (BTM)

The unit selects the stations with the strongest signals within the selected band, and stores them in the order of their frequency.

1 Press **(SOURCE)** repeatedly until “**📻** (tuner icon)” or the band appears.

2 Press **(MODE)** repeatedly to select the band.

3 Press **(MENU)**.

4 Press **←** or **→** repeatedly to select “Edit.”

5 Press **(ENTER)**.

6 Press **↑** or **↓** repeatedly to select “BTM.”



7 Press **(ENTER)**.

The stations with the strongest signals within the selected band are stored in order of frequency in the memory. To cancel storing, press **(ENTER)** while storing the stations.

8 Press **(MENU)**.

The display returns to the normal display.

Notes

- If only a few stations can be received due to weak signals, some stored preset numbers will retain their former settings.
- When a preset number is indicated in the display, the unit starts storing stations from the one currently displayed.

Display items

Standard mode:

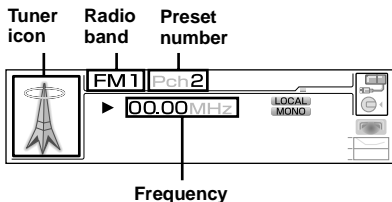

Spectrum analyser/Panorama/Screen saver mode:

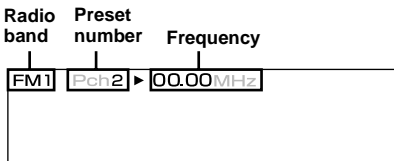

Clock mode:

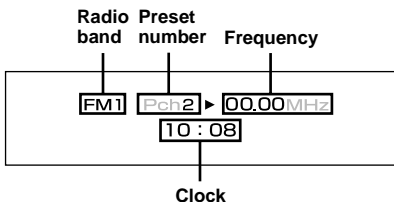

Receiving the stored stations

- 1 Press **(SOURCE)** repeatedly to select the radio.
- 2 Press **(MODE)** repeatedly to select the band.
- 3 Press the number button (**(1)** to **(6)**) on which the desired station is stored.

Tip

Press **↑** or **↓** to receive the stations in the order they are stored in the memory (Preset Search function).

If preset tuning does not work
— Automatic tuning

Press **←** (SEEK -) or **→** (SEEK +) to search for the station (automatic tuning).

Scanning stops when the unit receives a station. Repeat the operation until the desired station is received.

Tips

- If automatic tuning stops too frequently, turn on the Local Seek to limit seek to stations with stronger signals (see "Changing the sound and display settings" on page 30).
- If you know the frequency of the station you want to listen to, press and hold **←** or **→** to locate the approximate frequency, then press the **←** or **→** repeatedly to fine adjust to the desired frequency (manual tuning).

If FM stereo reception is poor

Select monaural reception mode
(see "Changing the sound and display settings" on page 30).

The sound improves, but becomes monaural ("STEREO" disappears).

Tip

If FM broadcasts are difficult to hear, set "DSO" to "OFF" (page 31).

Storing only desired stations

You can manually preset the desired stations on any chosen number button.

- 1 Press **(SOURCE)** repeatedly to select the radio.
- 2 Press **(MODE)** repeatedly to select the band.
- 3 Press **← (SEEK -)** or **→ (SEEK +)** to tune in the station that you want to store.
- 4 Press the desired number button (**1** to **6**) for 2 seconds until “Memory” appears.

The number of the button you pressed is displayed, and then the selected station is assigned to this number and stored.

Note

If you try to store another station on the same stored number, the previously stored station will be erased.

Tuning in a station through a list

— List-up

- 1 During radio reception, press **(LIST)** momentarily.

The frequency or the name assigned to the current station appears in the display.

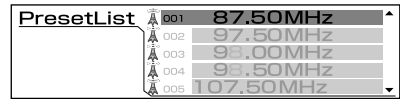

- 2 Press **↑** or **↓** repeatedly to select the desired station.

If no name is assigned to the station, the frequency appears in the display.

- 3 Press **(ENTER)** to tune in the desired station.

After tuning is completed, the display returns to the normal display.

Tip

To stop selecting and return to the normal display, press **(LIST)**.

RDS

Overview of RDS

FM stations with Radio Data System (RDS) service send inaudible digital information along with the regular radio programme signal. For example, one of the following will be displayed upon receiving a station with RDS capability.

Standard mode:

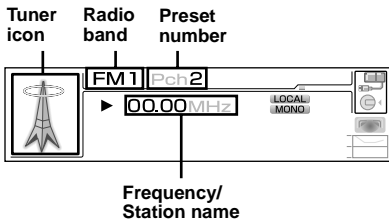

Spectrum analyser/Panorama/Screen saver mode:

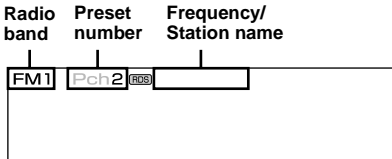

Clock mode:

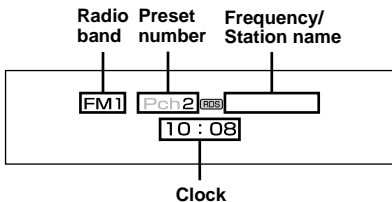

RDS services

RDS data offers you other conveniences, such as:

- **Automatic retuning** of a programme, helpful during long-distance drives. — AF → page 19
- Receiving **traffic announcements**, even when enjoying another programme/source. — TA → page 20
- Selecting stations by the **type of programme**. — PTY → page 21
- Automatic clock time setting. — CT → page 22

Notes

- Depending on the country or region, not all of the RDS functions are available.
- RDS may not work properly if the signal strength is weak or if the station you are tuned to is not transmitting RDS data.

Automatic retuning for best reception results

— AF function

The alternative frequencies (AF) function allows the radio to always tune into the area's strongest signal for the station you are listening to.

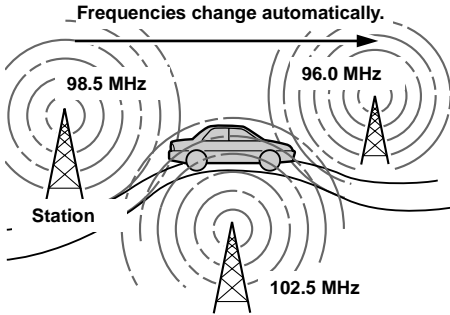

1 Select an FM station (page 15).

2 Press **(AF)** repeatedly until "**AF**" appears.

The unit starts searching for an alternative frequency with a stronger signal in the same network.

If "NO AF" is displayed, the currently tuned station does not have an alternative frequency.

Note

When there is no alternative frequency in the area, or when you do not need to search for one, turn the AF function off.

For stations without alternative frequencies

Press **←** or **→** while the station name is flashing (within 8 seconds).

The unit starts searching for another frequency with the same PI (Programme Identification) data ("PI Seek" appears).

If the unit cannot find the same PI, the unit returns to the previously selected frequency.

Staying with one regional programme

When the AF function is on: this unit's factory-set setting restricts reception to a specific region, so you won't be switched to another regional station with a stronger frequency.

If you leave this regional programme's reception area or would like to take advantage of the whole AF function, select "Regional OFF" from the Menu (page 30).

Note

This function does not work in the United Kingdom and some other areas.

Local Link function (United Kingdom only)

This function enables you to select other local stations in the area, even if they are not stored on your number buttons.

- 1** Press a number button (**1** to **6**) that has a local station stored on it.
- 2** Within 5 seconds, press the number button of the local station again.
- 3** Repeat this procedure until the desired local station is received.

Receiving traffic announcements

— TA/TP

By activating the Traffic Announcement (TA) and Traffic Programme (TP), you can automatically tune in an FM station broadcasting traffic announcements. These settings function regardless of the current FM programme, or source (CD/MD, AUX). The unit switches back to the original source when the bulletin is over.

Press **(TA)** repeatedly until “**(TA)**” appears.

The unit starts searching for traffic information stations.

“**(TP)**” indicates reception of such stations.

The unit will continue searching for stations available with TP if “NO TP” appears momentarily.

To cancel all traffic announcements, disappear “**(TA)**.”

To	Press
Cancel current announcement	(TA)

Tips

- You can also cancel the current announcement by pressing **(SOURCE)** or **(MODE)**.
- TA can also be set to on/off by pressing **(MODE)** on the unit for 2 seconds.

Presetting the volume of traffic announcements

You can preset the volume level of the traffic announcements so you won't miss hearing them.

1 Press **(VOL) to adjust the desired volume level.**

2 Press **(TA) for 2 seconds.**

“TA” appears and the setting is stored.

Receiving emergency announcements

If either AF or TA is on, the unit will switch to emergency announcements, if one comes in while listening to an FM station, CD/MD, or AUX.

Presetting RDS stations with AF and TA setting

When you preset RDS stations, the unit stores each station's AF/TA setting (on/off) as well as its frequency. You can select a different setting (for AF, TA, or both) for individual preset stations, or the same setting for all preset stations. If you preset stations with “**(AF)**” to on, the unit automatically stores stations with the strongest radio signal.

Presetting the same setting for all preset stations

1 Select an FM band (page 15).

2 Press **(AF) and/or **(TA)** to display “**(AF)**” and/or “**(TA)**.”**

Note that deactivating “**(AF)**” and “**(TA)**” applies to non-RDS stations as well as RDS stations.

3 Press **(MENU).**

4 Press **← or **→** to select “Edit.”**

5 Press **(ENTER).**

6 Press **↑ or **↓** to select “BTM.”**

7 Press **(ENTER).**

8 Press **(MENU).**

The display returns to the normal display.

Presetting different settings for each preset station

1 Select an FM band, and tune in the desired station (page 17).

2 Press **(AF) and/or **(TA)** to display “**(AF)**” and/or “**(TA)**.”**

3 Press the desired number button (1** to **6**) until “Memory” appears.**

Repeat from step 1 to preset other stations.

Tuning in stations by programme type

— PTY

You can tune in a station by selecting the type of programme you would like to listen to.

Programme types	Display
News	News
Current Affairs	Current Affairs
Information	Information
Sports	Sport
Education	Education
Drama	Drama
Culture	Cultures
Science	Science
Varied	Varied Speech
Popular Music	Pop Music
Rock Music	Rock Music
Easy Listening	Easy Listening
Light Classical	Light Classics M
Classical	Serious Classics
Other Music Type	Other Music
Weather	Weather & Metr
Finance	Finance
Children's Programmes	Children's Progs
Social Affairs	Social Affairs
Religion	Religion
Phone In	Phone In
Travel	Travel & Touring
Leisure	Leisure & Hobby
Jazz Music	Jazz Music
Country Music	Country Music
National Music	National Music
Oldies Music	Oldies Music
Folk Music	Folk Music
Documentary	Documentary

Note

You cannot use this function in some countries where no PTY (Programme Type selection) data is available.

1 Press (PTY) during FM reception.

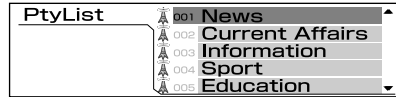

The current programme type name appears if the station is transmitting the PTY data. "-----" appears if the received station is not an RDS station, or if the RDS data is not received.

2 Press ↑ or ↓ repeatedly to select the desired programme type.

The programme types appear in the order shown in the table. "-----" appears if the programme type is not specified in the RDS data.

3 Press (ENTER).

The unit starts searching for a station broadcasting the selected programme type.

Setting the clock automatically

— CT

The CT (Clock Time) data from the RDS transmission sets the clock automatically.

- 1 Press **(MENU)**.
- 2 Press **←** or **→** repeatedly to select "Setup."
- 3 Press **(ENTER)**.
- 4 Press **↑** or **↓** repeatedly to select "CT."
- 5 Press **(ENTER)**.



- 6 Press **↑** or **↓** to select "ON."
The clock is set.
- 7 Press **(ENTER)**.
The display returns to the top menu display.
- 8 Press **(MENU)**.
The display returns to the normal display.

To cancel the CT function, select "OFF" in step 6.

Notes

- The CT function may not work even though an RDS station is being received.
- There might be a difference between the time set by the CT function and the actual time.

Image Settings

Selecting the display mode and display pattern

You can select from 5 different display modes. You can also select various display patterns in Standard, Spectrum analyzer, Panorama, Screen saver, and clock mode.

Standard mode

Displays various information such as source, track number, elapsed playing time, disc name, track name, and sound settings. You can display items such as an icon of the source on the left side of the display, spectrum analyzer pattern in smaller size in the centre of the display.

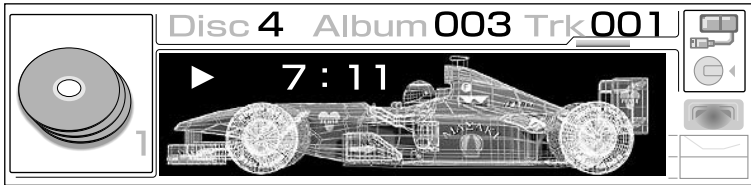

Spectrum analyzer mode

Displays a pre-stored spectrum analyzer setting on the whole screen.



Panorama mode

Displays pre-stored static images on the whole screen, and some of them scroll automatically.



Screen Saver mode

Plays back a pre-stored animation.



Clock mode

Displays playback or radio reception information and clock.

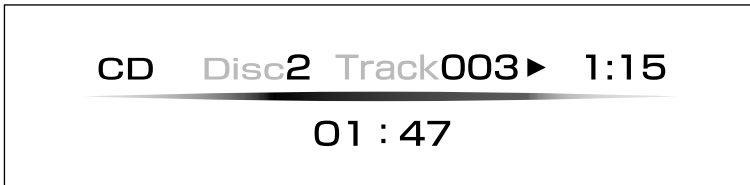

By the card remote commander

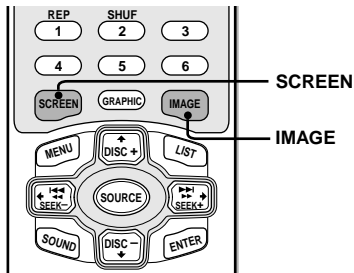

By the unit

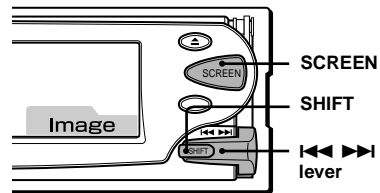

1 During playback or radio reception, press (SCREEN) repeatedly to select the display mode.

Each time you press (SCREEN), the display mode changes as follows:

Standard mode → Spectrum analyzer mode → Panorama mode → Screen saver mode → Clock mode* → Standard mode

2 Press (IMAGE) repeatedly to select the display pattern.

* You cannot select any display pattern in the Clock mode.

1 During playback or radio reception, press (SCREEN) repeatedly to select the display mode.

Each time you press (SCREEN), the display mode changes as follows:

Standard mode → Spectrum analyzer mode → Panorama mode → Screen saver mode → Clock mode* → Standard mode

2 Press up or down the <<<>>> lever while "Image" is displayed in the lower right of the display to select the display pattern.

* You cannot select any display pattern in the Clock mode.

When switching only the display pattern, press (SHIFT) until the desired image appears on the display lower right, and press up or down the <<<>>> lever until the desired image is displayed (If source is AUX, you do not need to press (SHIFT)).

Clearing display characters automatically

— AutoClear (Spectrum analyzer/Panorama/Screen Saver mode)

You can make display characters disappear for a moment in Spectrum analyzer/Panorama/Screen Saver mode. When set to ON, you can display the display characters only when the disc, album, or track is changed or the source or display mode is changed. You can enjoy full images.

- 1 Press **(SOURCE)** to select a source (radio, CD, MD or AUX).
- 2 Press **(GRAPHIC)**.
- 3 Press **←** or **→** repeatedly to select "AutoClear."
Each time you press **←** or **→**, the item changes as follows:
AutoClear ↔ BlendLevel ↔
Plaque ↔ Color Sel ↔
Autolmage ↔ AutoClear
- 4 Press **(ENTER)**.

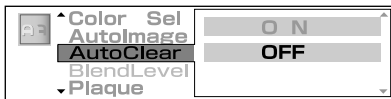

- 5 Press **(ENTER)**.



- 6 Press **↑** or **↓** to select "ON."
To cancel the Auto Clear function, select "OFF."
- 7 Press **(ENTER)**.
- 8 Press **(GRAPHIC)**.
The display returns to the normal display.

Note

In Standard/Clock mode, you cannot make the display characters disappear automatically.

Changing the translucence ratio of the characters

—BlendLevel (Spectrum analyzer/Panorama/Screen Saver mode)

You can set the translucence ratio (Colour density) of the characters in the Spectrum analyzer/Panorama/Screen Saver mode. By setting this level down, you can adjust the characters in the display to appear opaque.

- 1 Press **(SOURCE)** to select a source (radio, CD, MD or AUX).
- 2 Press **(GRAPHIC)**.
- 3 Press **←** or **→** repeatedly to select "BlendLevel."
Each time you press **←** or **→**, the item changes as follows:
AutoClear ↔ BlendLevel ↔
Plaque ↔ Color Sel ↔
Autolmage ↔ AutoClear
- 4 Press **(ENTER)**.



- 5 Press **(ENTER)**.



- 6 Press **←** or **→** to select the permeation ratio (Level 0-15).
The lower the level, the paler the display characters.
- 7 Press **(ENTER)**.
- 8 Press **(GRAPHIC)**.
The display returns to the normal display.

Notes

- In Standard/Clock mode, you cannot change the translucence ratio of the display characters.
- While "Plaque" is set to "ON," "BlendLevel" has no effect, regardless of setting.

Setting a Plaque

— Plaque

If characters fade into a similar coloured background image, the plaque setting will make the characters more readable.

- 1 Press **(SOURCE)** to select a source (radio, CD, MD or AUX).
- 2 Press **(GRAPHIC)**.
- 3 Press **←** or **→** repeatedly to select “Plaque.”
Each time you press **←** or **→**, the item changes as follows:
AutoClear ↔ BlendLevel ↔
Plaque ↔ Color Sel ↔
Autolmage ↔ AutoClear
- 4 Press **(ENTER)**.

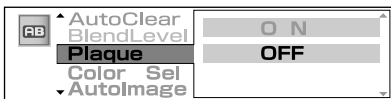

- 5 Press **(ENTER)**.



- 6 Press **↑** or **↓** repeatedly to select “ON.”
 - 7 Press **(ENTER)**.
 - 8 Press **(GRAPHIC)**.
- The display returns to the normal display.

Note

If “Plaque” is set to “ON,” “BlendLevel” you adjusted has no effect.

Setting the character colour

— Color Sel

You can select one of 7 colour settings for the character display. Besides, you can adjust and store the desired colour in the unit.

Selecting the character colour

- 1 Press **(SOURCE)** to select a source (radio, CD, MD or AUX).
- 2 Press **(GRAPHIC)**.
- 3 Press **←** or **→** repeatedly to select “Color Sel.”
Each time you press **←** or **→**, the item changes as follows:
AutoClear ↔ BlendLevel ↔
Plaque ↔ Color Sel ↔
Autolmage ↔ AutoClear
- 4 Press **(ENTER)**.



- 5 Press **(ENTER)**.



- 6 Press **↑** or **↓** repeatedly to select the desired character colour.
Each time you press **↑** or **↓**, the character colour changes.
Blue ↔ White ↔ Green ↔ Pink
↔ Yellow ↔ Purple ↔ Black ↔
Custom ↔ Blue
 - 7 Press **(ENTER)**.
 - 8 Press **(GRAPHIC)**.
- The display returns to the normal display.

Adjusting the character colour

- 1 Press **(SOURCE)** to select a source (radio, CD, MD or AUX).
- 2 Press **(GRAPHIC)**.
- 3 Press **←** or **→** repeatedly to select "Color Sel," then press **(ENTER)**.
Each time you press **←** or **→**, the item changes as follows:
AutoClear ↔ BlendLevel ↔
Plaque ↔ Color Sel ↔
AutoImage ↔ AutoClear
- 4 Press **(ENTER)**.
- 5 Press **↑** or **↓** to select "Custom," then press **(ENTER)**.

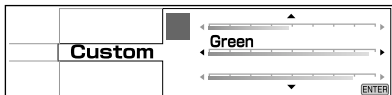

- 6 Press **↑** or **↓** repeatedly to select one among Red-Green-Blue.
Each time you press **↑** or **↓**, the item changes.
- 7 Press **←** or **→** to adjust the level of the colour.
Repeat steps 7 and 8 to set the character display to your desired colour.
- 8 Press **(ENTER)**.
- 9 Press **↑** or **↓** to select "Save," then press **(ENTER)**.
To return to the former character colour, select "Cancel," then press **(ENTER)**.
To restore the factory-set character colour, select "Reset," then press **(ENTER)**.
- 10 Press **(GRAPHIC)**.
The display returns to the normal display.

Selecting the display period of the images

— Autolmage

The pre-stored images switch in sequence automatically. You can select the display period for an image.

- 1 Press **(SOURCE)** to select a source (radio, CD, MD, or AUX).
- 2 Press **(GRAPHIC)**.
- 3 Press **←** or **→** repeatedly to select "Autolmage."
Each time you press **←** or **→**, the item changes as follows:
AutoClear ↔ BlendLevel ↔
Plaque ↔ Color Sel ↔
AutoImage ↔ AutoClear
- 4 Press **(ENTER)**.

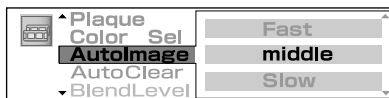

- 5 Press **(ENTER)**.
- 6 Press **↑** or **↓** repeatedly to select the display period for an image.
Each time you press **↑** or **↓**, the item changes as follows:
Middle ↔ Fast ↔ OFF ↔ Slow ↔ Middle
To cancel the Slide Show function, select "OFF."
- 7 Press **(ENTER)**.
- 8 Press **(GRAPHIC)**.
The display returns to the normal display.

Other Functions

You can also control the unit (and optional CD/MD units) with a rotary commander (**optional**).

Using the rotary commander

First, attach the appropriate label depending on how you want to mount the rotary commander. The rotary commander works by pressing buttons and/or rotating controls.

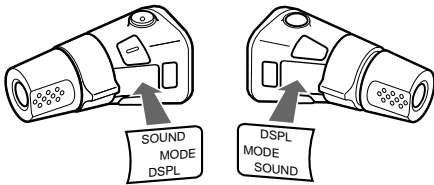

By pressing buttons

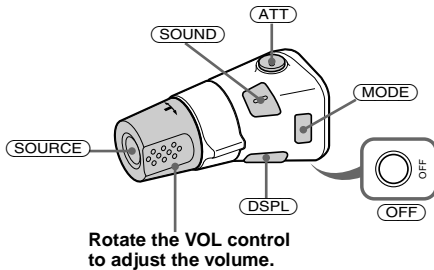

Press	To
(SOURCE)	Change source (radio/CD/MD*1/AUX)/ Power on
(MODE)	Change operation (radio band/CD unit*1/MD unit*1)
(ATT)	Attenuate sound
(OFF)*2	Stop playback or radio reception/Power off
(SOUND)	Display the sound menus
(DSPL)	Select the display mode

Note
The DSPL button on the rotary commander works as the SCREEN button for this unit.

By rotating the control

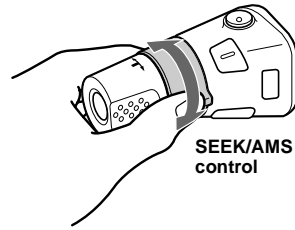

Rotate and release to:

- Skip tracks.
To continuously skip tracks, rotate once and rotate again within 2 seconds and hold the control.
 - Tune in stations automatically.
- ### Rotate, hold, and release to:
- Fast-forward/reverse a track.
 - Find a station manually.

By pushing in and rotating the control

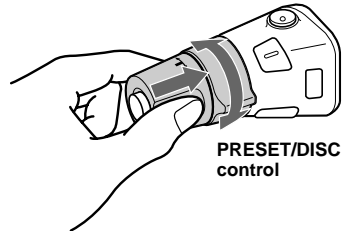

Push in and rotate the control to:

- Receive preset stations.
- Change discs during CD (MD) playback*1.

During playback of a CD containing MP3 files

(With this unit)

Push in and rotate the control to:

- Change albums.

(With optional unit)

Push in and repeat rotating quickly to:

- Change discs one by one.

Push in, then rotate and hold for a moment to:

- Enter the album skip mode. Within 2 seconds, push in and rotate again for continuous skip.

*1 Only if the corresponding optional equipment is connected.

*2 If your car has no ACC (accessory) position on the ignition key switch, after turning off the ignition, be sure to press and hold **(OFF)** until the display disappears.

Changing the operative direction

The operative direction of controls is factory-set as shown below.

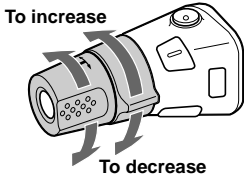

If you need to mount the rotary commander on the right hand side of the steering column, you can reverse the operative direction.

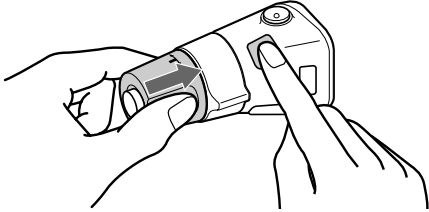

Press **(SOUND)** for 2 seconds while pushing the VOL control.

Note

If you press **(SOUND)** for 2 seconds while pushing the VOL control, "Normal" or "Reverse" appears in the display.

- "Normal" is to use the rotary commander at the factory-set position.
- "Reverse" is to use the rotary commander when it is mounted on the right side of the steering column.

Adjusting the sound characteristics

You can adjust the bass, treble, balance, fader, and subwoofer volume.

- 1 Press **(SOURCE)** to select a source (radio, CD, MD, or AUX).
- 2 Press **(SOUND)**.
- 3 Press **←** or **→** repeatedly to select the item you want to adjust.
Each time you press **←** or **→**, the item changes as follows:
DSO ↔ **EQ7** ↔ **Bass** ↔ **Treble**
↔ **Balance (left-right)**
↔ **Fader (front-rear)**
↔ **SubWoofer (subwoofer volume)**
- 4 Press **(ENTER)**.
- 5 Adjust the selected item by pressing **←** or **→**.
- 6 Press **(ENTER)**.

Quickly attenuating the sound

Press **(ATT)**.

"ATT" appears in the display for a while.

To restore the previous volume level, press **(ATT)** again.

Tip

When the interface cable of a car telephone is connected to the ATT lead, the unit decreases the volume automatically when a telephone call comes in (Telephone ATT function).

Changing the sound and display settings

— Menu

The following items can be set:



Setup

- Clock (page 10)
- CT (Clock Time) (page 22)
- Beep — to turn the beeps on or off.
- AUX Skip*¹ (page 34) — to turn the AUX source display on or off.
- Security (page 35) — to set the security code to discourage theft.



Display

- Dimmer — to change the brightness of the display.
 - Select “AUTO” to dim the display only when you turn the lights on.
 - Select “ON” to dim the display.
 - Select “OFF” to deactivate the Dimmer.
- Contrast — to adjust the contrast if the indications on the display are not recognizable because of the unit’s installation position.
- AutoScroll*²
 - Select “ON” to scroll all automatically displayed names.
 - When “Auto scroll” is set to “OFF” and the disc/track name is changed, the disc/track name does not scroll.



PlayMode

- Local (Local Seek Mode) (page 16)
 - Select “ON” to only tune into stations with stronger signals.
- Mono (Monaural Mode) (page 16)
 - Select “ON” to hear FM stereo broadcast in monaural. Select “OFF” to return to normal mode.
- Regional (page 19)



SoundTuning

- EQ7 Tune (page 31) — to adjust the equaliser curve.
- HPF (High pass filter) (page 32)
- LPF (Low pass filter) (page 33)
- Loudness — to enjoy bass and treble even at low volumes. The bass and treble will be reinforced.
- AUX Level*³ (page 34) — to adjust the volume level of connected auxiliary equipment.

*¹ Displayed only when the clock is displayed by pressing **OFF**.

*² Displayed only when CD or MD is playing back.

*³ Displayed only when the source is AUX.

Note

Only when an optional CD/MD unit is not connected, “AUX Skip” and “AUX Level” are displayed.

1 Press **MENU**.

To set “AutoScroll,” press **MENU** during CD/MD playback.

2 Press **←** or **→** repeatedly to select the desired item.

3 Press **ENTER**.

4 Press **↑** or **↓** repeatedly to select your desired items to be adjusted.

5 Press **ENTER**.

6 Press **↑** or **↓** repeatedly to select the desired setting (Example: “ON” or “OFF”).

7 Press **ENTER**.

The display returns to the top menu display.

8 Press **MENU**.

The display returns to the normal display.

Note

The displayed item will differ depending on the source.

Setting the Dynamic Soundstage Organiser (DSO)

If your speakers are installed into the lower part of the doors, the sound will come from below and may not be clear.

The DSO (Dynamic Soundstage Organiser) function creates a more ambient sound as if there were speakers above the dashboard (virtual speakers).

You can store the DSO setting for each source.

DSO mode and image of virtual speakers

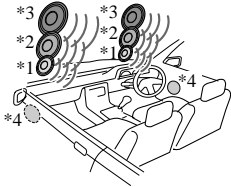

- *1 DSO 1
- *2 DSO 2
- *3 DSO 3
- *4 DSO OFF

- 1 Press **(SOURCE)** to select a source (radio, CD, MD, or AUX).
- 2 Press **(SOUND)**.
- 3 Press **←** or **→** repeatedly to select "DSO."
- 4 Press **(ENTER)**.



- 5 Press **←** or **→** repeatedly to select the DSO mode (DSO 1-3).
To cancel the DSO function, select "OFF."
- 6 Press **(ENTER)**.

Notes

- Depending on the type of car interior or type of music, DSO may not have a desirable affect.
- If FM broadcasts are difficult to hear, set "DSO" to "OFF."

Tip

The sound effect of the DSO mode increases as the number increases.

Setting the equaliser (EQ7)

You can select an equaliser curve for 7 music types (Xplod, Vocal, Club, Jazz, New Age, Rock, and Custom).

You can adjust a different equaliser setting for each source.

Selecting the equaliser curve

- 1 Press **(SOURCE)** to select a source (radio, CD, MD, or AUX).
- 2 Press **(SOUND)**.
- 3 Press **←** or **→** repeatedly to select "EQ7."
- 4 Press **(ENTER)**.

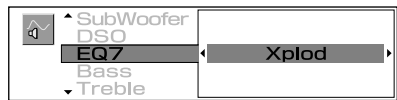

- 5 Press **←** or **→** repeatedly to select the Equaliser mode.
To cancel the equalising effect, select "OFF."
- 6 Press **(ENTER)**.

Note

While DSO is active, equaliser settings are automatically adjusted for best overall effect.

Adjusting the equaliser curve

You can store and adjust the equaliser settings for frequency and level.

- 1 Press **(SOURCE)** to select a source (radio, CD, MD, or AUX).
- 2 Press **(MENU)**.
- 3 Press **←** or **→** repeatedly to select "SoundTuning."
- 4 Press **(ENTER)**.
- 5 Press **↑** or **↓** repeatedly to select "EQ7 Tune."
- 6 Press **(ENTER)**.
Example: EQ7 Tune "Xplod"



continue to next page →

- 7 Press **↑** or **↓** repeatedly to select the desired equaliser curve.
- 8 Press **(ENTER)**.
- 9 Select the desired frequency and level.

- 1 Press **←** or **→** repeatedly to select the desired frequency.

Each time you press **←** or **→**, the frequency changes.

62 Hz ↔ 157 Hz ↔ 396 Hz
 ↔ 1000 Hz ↔ 2510 Hz
 ↔ 6340 Hz ↔ 16000 Hz

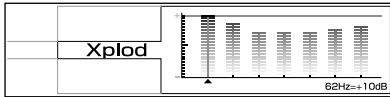

- 2 Press **↑** or **↓** repeatedly to adjust the desired level.

The level is adjustable by 1 dB steps from -10 dB to +10 dB.

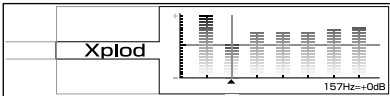

To restore the factory-set equaliser curve, press **(ENTER)** for 2 seconds.

- 3 Repeat steps 1 and 2 to adjust the equaliser curve.

- 10 Press **(ENTER)**.

After the effect setting is completed, the display returns to the normal display.

Adjusting the front and rear volume

- 1 Press **(SOURCE)** to select a source (radio, CD, MD, or AUX).
- 2 Press **(SOUND)**.
- 3 Press **←** or **→** repeatedly to select "Fader."
- 4 Press **(ENTER)**.

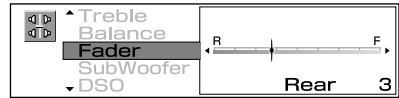

- 5 Press **←** or **→** repeatedly to adjust the volume of front/rear speakers.
- 6 Press **(ENTER)**.
The display returns to the normal display.

Adjusting the cut-off frequency for the front/rear speakers

To match the characteristics of the installed speaker system, you can select the cut-off frequency of the speakers.

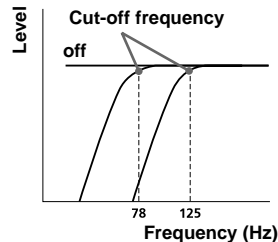

- 1 During playback or radio reception, press **(MENU)**.
- 2 Press **←** or **→** repeatedly to select "SoundTuning."
- 3 Press **(ENTER)**.
- 4 Press **↑** or **↓** repeatedly to select "HPF."
- 5 Press **(ENTER)**.

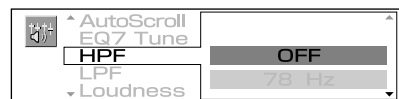

6 Press ↑ or ↓ repeatedly to select the cut-off frequency.

Each time you press ↑ or ↓, the frequency changes as follows:

OFF (default setting) ↔ 78 Hz ↔ 125 Hz

7 Press (MENU).

After the frequency setting is complete, the display returns to the normal display.

Adjusting the volume of the subwoofer(s)

1 Press (SOURCE) to select a source (radio, CD, MD, or AUX).

2 Press (SOUND).

3 Press ← or → repeatedly to select "SubWoofer."

4 Press (ENTER).

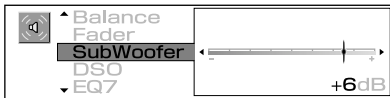

5 Press ← or → repeatedly to adjust the volume.

6 Press (ENTER).

The display returns to the normal display.

Tip

The volume level is adjustable from -10 dB to +10 dB (Below -10 dB, "-∞ dB" is displayed).

Adjusting the cut-off frequency for the subwoofer(s)

To match the characteristics of the connected subwoofer(s), you can cut out the unwanted high and middle frequency signals entering the subwoofer(s). By setting the cut-off frequency (see the diagram below), the subwoofer(s) will output only low frequency signals for a clearer sound.

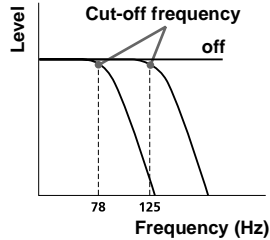

1 During playback or radio reception, press (MENU).

2 Press ← or → repeatedly to select "SoundTuning."

3 Press (ENTER).

4 Press ↑ or ↓ repeatedly to select "LPF."

5 Press (ENTER).



6 Press ↑ or ↓ repeatedly to select the cut-off frequency.

Each time you press ↑ or ↓, the frequency changes as follows:

OFF (default setting) ↔ 125 Hz ↔ 78 Hz

7 Press (MENU).

After the frequency setting is complete, the display returns to the normal display.

Connecting auxiliary audio equipment

The unit's AUX IN (external audio input) terminal on this unit is also used as the BUS AUDIO IN (audio input) terminal. You can listen to the sound from your car speakers by connecting optional Sony portable devices.

Note

If you connect an optional Sony CD/MD unit, you cannot connect any portable devices and cannot select "AUX."

Selecting auxiliary equipment

Press **(SOURCE)** repeatedly to select "AUX."

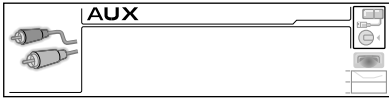

Adjusting the volume level

You can adjust the volume for each connected audio equipment.

- 1 Press **(MENU)**.
- 2 Press **←** or **→** repeatedly to select "SoundTuning."
- 3 Press **(ENTER)**.
- 4 Press **↑** or **↓** repeatedly to select "AUX Level."
- 5 Press **(ENTER)**.
- 6 Press **←** or **→** repeatedly to adjust the volume level.
The volume level is adjustable in 1 dB steps from -6 dB to +6 dB.
- 7 Press **(ENTER)**.
The display returns to the top menu display.
- 8 Press **(MENU)**.
The display returns to the normal display.

To deactivate auxiliary equipment in the music source display

- 1 Press **(OFF)**.
CD/MD playback or radio reception stops (the key illumination and display remain on).
- 2 Press **(MENU)**.
- 3 Press **←** or **→** repeatedly to select "Setup."
- 4 Press **(ENTER)**.
- 5 Press **↑** or **↓** repeatedly to select "AUX Skip."
- 6 Press **(ENTER)**.
- 7 Press **↓** to select "ON."
- 8 Press **(MENU)**.

To restore the indication, select "AUX Skip OFF."

Setting the security code

This unit has a security function to discourage theft. Input a 4-digit number as your security code.

If you set it, you need to input the stored code to turn on the unit should you re-install the unit in another car or after changing the battery.

- 1 Press **(MENU)**.
- 2 Press **←** or **→** repeatedly to select "Setup."
- 3 Press **(ENTER)**.
- 4 Press **↑** or **↓** repeatedly to select "Security."
- 5 Press **(ENTER)**.
Code Set display is displayed.

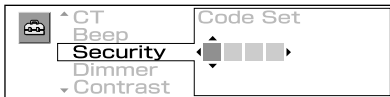

- 1 Press **↑** or **↓** repeatedly to enter the first digit (0-9).
- 2 Press **→** to move the cursor to the 2nd digit, then press **↑** or **↓** repeatedly to enter the 2nd digit. Each time you press **↑**, a digit goes up and each time you press **↓**, a digit falls.
- 3 Repeat step 2 to enter the 3rd digit and the 4th digit.
- 6 Press **(ENTER)**.
Check Code display appears.
- 7 Press **↑** or **↓** repeatedly to select "YES."

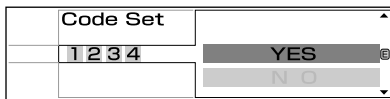

- 8 Press **(ENTER)**.
The display returns to the normal display.

Notes

- The security code cannot be entered by the number buttons (1-6).
- Make sure not to forget your security code.
- If you select "NO" in step 7 and press **(ENTER)**, the display returns to the Code Set display in step 5.

After the security code setup is completed

Should you re-install the unit in another car or change the battery, the Check Code display appears after turning on the unit. Enter your stored 4-digit code with the cursor buttons (**↑/↓/→**), and press **(ENTER)**.

Code Input display

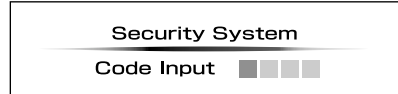

OK: returns to the calendar/clock display.

NG: "CODE ERROR" message appears.

Input the correct code using the cursor buttons.

Cancelling the security code

Repeat step 1 to 4 in "Setting the security code" (Code Del display appears). Enter your stored code with the cursor buttons (**↑/↓/→**), and press **(ENTER)**.

Code Del display

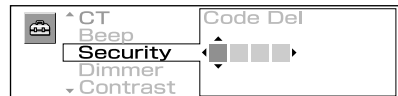

OK: returns to a normal display.

NG: the "CODE ERROR" message appears.

Input the correct code using the cursor buttons.

Note

You cannot change the security code unless you delete your stored code.

Tip

If the security code is not stored, the Code Del display does not appear.

Additional Information

Maintenance

Fuse replacement

When replacing the fuse, be sure to use one matching the amperage rating stated on the original fuse. If the fuse blows, check the power connection and replace the fuse. If the fuse blows again after replacement, there may be an internal malfunction. In such a case, consult your nearest Sony dealer.

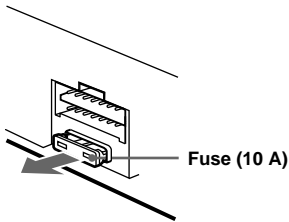

Warning

Never use a fuse with an amperage rating exceeding the one supplied with the unit as this could damage the unit.

Replacing the lithium battery

Under normal conditions, batteries will last approximately 1 year. (The service life may be shorter, depending on the conditions of use.) When the battery becomes weak, the range of the card remote commander becomes shorter. Replace the battery with a new CR2025 lithium battery. Use of any other battery may present a risk of fire or explosion.

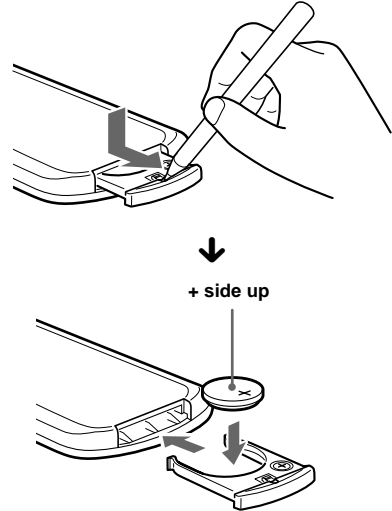

Notes on lithium battery

- Keep the lithium battery out of the reach of children. Should the battery be swallowed, immediately consult a doctor.
- Wipe the battery with a dry cloth to assure a good contact.
- Be sure to observe the correct polarity when installing the battery.
- Do not hold the battery with metallic tweezers, otherwise a short-circuit may occur.

WARNING

Battery may explode if mistreated.
Do not recharge, disassemble, or dispose of in fire.

Removing the unit

1 Remove the protection collar.

- 1 Engage the release keys together with the protection collar.

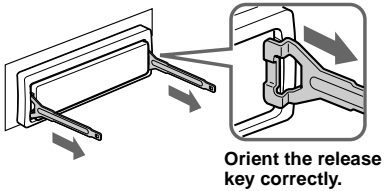

- 2 Pull out the release keys to remove the protection collar.

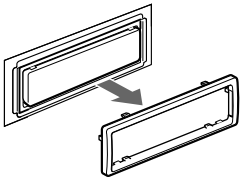

2 Remove the unit.

- 1 Insert both release keys together until they click.

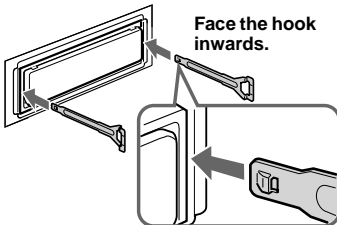

- 2 Pull the release keys to unseat the unit.

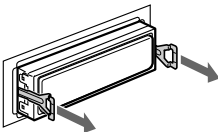

- 3 Slide the unit out of the mounting.

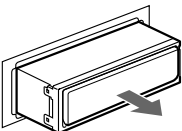

Specifications

CD Player section

Signal-to-noise ratio	90 dB
Frequency response	10 – 20,000 Hz
Wow and flutter	Below measurable limit

Tuner section

FM

Tuning range	87.5 – 108 MHz
Aerial terminal	External aerial connector
Intermediate frequency	10.7 MHz/450 kHz
Usable sensitivity	9 dBf
Selectivity	75 dB at 400 kHz
Signal-to-noise ratio	67 dB (stereo), 69 dB (mono)
Harmonic distortion at 1 kHz	0.5 % (stereo), 0.3 % (mono)
Separation	35 dB at 1 kHz
Frequency response	30 – 15,000 Hz

MW/LW

Tuning range	MW: 531 – 1,602 kHz LW: 153 – 279 kHz
Aerial terminal	External aerial connector
Intermediate frequency	10.7 MHz/450 kHz
Sensitivity	MW: 30 μ V LW: 40 μ V

Power amplifier section

Outputs	Speaker outputs (sure seal connectors)
Speaker impedance	4 – 8 ohms
Maximum power output	52 W \times 4 (at 4 ohms)

General

Outputs	Audio outputs (front/rear) Subwoofer output (mono) Power aerial relay control terminal Power amplifier control terminal
Inputs	Telephone ATT control terminal Illumination control terminal BUS control input terminal BUS audio input/AUX IN terminal Aerial input terminal
Tone controls	Bass \pm 8 dB at 100 Hz Treble \pm 8 dB at 10 kHz
Loudness	+8 dB at 100 Hz +2 dB at 10 kHz
Power requirements	12 V DC car battery (negative earth)
Dimensions	Approx. 178 \times 50 \times 181 mm (w/h/d)
Mounting dimensions	Approx. 182 \times 53 \times 160 mm (w/h/d)
Mass	Approx. 1.6 kg
Supplied accessories	Card remote commander RM-X132 (1) Parts for installation and connections (1 set) Front panel cover (1) Rotary commander RM-X4S Wireless rotary commander RM-X6S BUS cable (supplied with an RCA pin cord) RC-61 (1 m), RC-62 (2 m)
Optional accessories	CD changer (6 discs) CDX-T70MX, CDX-T69 MD changer (6 discs) MDX-66XLP MG-MS System-up Player MGS-X1 Source selector XA-C30 AUX-IN Selector XA-300
Optional equipment	

Note

This unit cannot be connected to a digital preamplifier or an equaliser which is Sony BUS system compatible.

Design and specifications are subject to change without notice.

Troubleshooting

The following checklist will help you remedy problems you may encounter with your unit. Before going through the checklist below, check the connection and operating procedures.

General

The operation buttons do not function.

Press the reset button.

No sound.

- Press up the VOL control lever to adjust the volume.
- Cancel the ATT function.
- Set the fader control to the centre position for a 2-speaker system.

The contents of the memory have been erased.

- The reset button has been pressed.
→ Store again into the memory.
- The power cord or battery has been disconnected.
- The power connecting cord is not connected properly.

No beep sound.

The beep sound is cancelled (page 30).

The display disappears from/does not appear in the display window.

The display disappears if you press and hold **(OFF)**.

→ Press and hold **(OFF)** again until the display appears.

Stored stations and correct time are erased. The fuse has blown.

Makes noise when the ignition key is in the ON, ACC, or OFF position.

The leads are not matched correctly with the car's accessory power connector.

No power is being supplied to the unit.

- Check the connection. If everything is in order, check the fuse.
- The car does not have an ACC position.
→ Press **(SOURCE)** to turn on the unit

The power is continuously supplied to the unit.

The car does not have an ACC position.
→ After turning off the ignition, be sure to press and hold **(OFF)** on the unit until the display disappears.

The power aerial does not extend.

The power aerial does not have a relay box.

CD/MD playback

Playback does not begin.

- Defective MD or dirty CD.
- Some CD-Rs/CD-RWs may not play due to its recording equipment or the disc condition.

MP3 files cannot be played back.

- Recording was not performed according to the ISO 9660 level 1 or level 2 format, or the Joliet or Romeo in the expansion format.
- The file extension ".MP3" is not added to the file name.
- Files are not stored in MP3 format.

Album name/track name/ID3 tag is not displayed correctly.

- A disc is not compliant with ISO 9660 level 1.
→ Use a compliant disc.
- The unit can only display the letter codes, such as ASCII, half sized European letters (ASCII only for Joliet), and Shift-JIS. Letter codes other than the above will not display correctly.

MP3 files take longer to play back than others.

The following discs take a longer time to start playback.

- a disc recorded with complicated tree structure.
- a disc recorded in Multi Session.
- a disc to which data can be added.

The sound skips from vibration.

- The unit is installed at an angle of more than 60°.
- The unit is not installed in a sturdy part of the car.

The sound skips.

- Defective or dirty disc.
 - The CD-R/CD-RW has been damaged.
-

continue to next page →

Radio reception

Preset tuning is not possible.

- Store the correct frequency in the memory.
- The broadcast signal is too weak.

The stations cannot be received.

The sound is hampered by noises.

- Connect a power aerial control lead (blue) or accessory power supply lead (red) to the power supply lead of a car's aerial booster. (Only if your car has a built-in FM/MW/LW aerial in the rear/side glass.)
- Check the connection of the car aerial.
- The auto aerial will not go up.
→ Check the connection of the power aerial control lead.
- Check the frequency.
- When the DSO mode is on, the sound is sometimes hampered by noises.
→ Set the DSO mode to "OFF" (page 31).

Automatic tuning is not possible.

- The local seek mode is set to "ON."
→ Set the local seek mode to "OFF" (page 30).
- The broadcast signal is too weak.
→ Perform manual tuning.

The "STEREO" indication flashes.

- Tune in the frequency accurately.
- The broadcast signal is too weak.
→ Set to the monaural reception mode (page 30).

A programme broadcast in stereo is heard in monaural.

- The unit is in monaural reception mode.
→ Cancel monaural reception mode (page 30).

RDS

Seek starts after a few seconds of listening.

- The station is non-TP or has weak signal.
→ Press (AF) or (TA) repeatedly until " [AF] " or " [TA] " disappears.

No traffic announcements.

- Activate TA function.
- The station does not broadcast any traffic announcements despite being TP.
→ Tune in another station.

PTY displays "-----"

- The current station is not an RDS station.
- RDS data has not been received.
- The station does not specify the programme type.

Error displays/Message

Error displays

(For this unit and optional CD/MD changers)

The following indications will flash for about 5 seconds, and an alarm sound will be heard.

Blank*1

- No tracks have been recorded on an MD*2.
→ Play an MD with recorded tracks on it.

Error*1

- A CD is dirty or inserted upside down.*2
→ Clean or insert the CD correctly.
- A CD/MD cannot play because of some problem.*2
→ Insert another CD/MD.

High Temp

- The ambient temperature is more than 50°C.
→ Wait until the temperature goes down below 50°C.

NO Disc

- No disc is inserted in the CD/MD unit.
→ Insert discs in the CD/MD unit.

NO Magazine

- The disc magazine is not inserted in the CD/MD unit.
→ Insert the magazine in the CD/MD unit.

NO Music*1

- A CD which is not a music file is inserted.
→ Insert a music CD.

Not Ready

- The lid of the MD unit is open or the MDs are not inserted properly.
→ Close the lid or insert the MDs properly.

Push Reset

- The CD/MD unit cannot be operated because of some problem.
→ Press the reset button on the unit.

*1 When the CD/MD changer is connected to the unit, the disc number of the CD or MD appears in the display.

*2 The disc number of the disc causing the error appears in the display.

If these solutions do not help improve the situation, consult your nearest Sony dealer.

Message

Local Seek up/Local Seek down

- The Local Seek mode is on during automatic tuning (page 16).

About ID3 tag version 2

Although not a malfunction, the following occurs when an MP3 file containing ID3 tag ver.2 is played:

- When skipping a portion of ID3 tag ver.2 (at the beginning of the track), sound is not output. Skip time changes depending ID3 tag ver.2 capacity.*
- The displayed elapsed playing time when skipping a portion of ID3 tag ver.2 is inaccurate. For MP3 files of a bit rate other than 128 kbps, time is not displayed accurately during playback.*
- When an MP3 file is created with MP3 conversion software, ID3 tag ver.2 will automatically be written.*

鳴謝惠顧！

感謝您惠購 Sony Compact Disc Player。

特色：

- 可以播放錄製在光碟上的 MP3 檔案。
- 可播放能增加一個片段的 CD-R/CD-RW (第 7 頁)。
- 視錄製方法而定，可以播放以 Multi Session (CD-Extra, Mixed CD 等) 錄製的光碟 (第 7 頁)。
- 選購的 CD/MD 裝置 (換碟機和播放機均在內) *1。
- ID3 標籤 *2 版本 1 資訊 (在播放 MP3 檔案時顯示)。
- CD TEXT 資訊 (在播放 CD TEXT 光碟 *3 時顯示)。
- **提供的操作附件**
卡片式遙控器 RM-X132
- **選購的操作附件**
旋轉式控制器 RM-X4S
無線旋轉式控制器 RM-X6S

*1 此裝置僅與 Sony 產品一起使用。

*2 ID3 標籤是一種 MP3 檔案，它包含了諸如光碟名稱、演唱者和樂曲名稱等資訊。

*3 CD TEXT 光碟是一種音頻 CD，它包含了諸如光碟名稱、演唱者和樂曲名稱之類的資訊。這些資訊記錄在光碟上。

本手冊中的說明講述如何主要使用卡片式遙控器操作本機。

本手冊中的插圖可能與實際圖案有所差異。



此標籤位於機殼的底部。



此標籤位於驅動裝置的內部機殼上。

目錄

控制器位置	4
注意事項	6
光碟注意事項	6
關於 MP3 檔案	7
普通頂部選單顯示	9

入門指南

復原本機	10
設定時鐘和日曆	10

CD 播放機

CD/MD 裝置 (選購件)

播放光碟	11
顯示項目	12
反覆播放樂曲	
— 重複播放	13
以隨機順序播放樂曲	
— 隨機播放	13
標註 CD	
— 光碟記憶功能*	14
通過名稱找出光碟	
— 列表功能*	15

* 配以選購件 CD/MD 裝置時可使用的功能

收音機

自動儲存電台	
— 最佳調諧記憶功能 (BTM)	15
顯示項目	16
收聽已儲存的電台	16
僅儲存所要的電台	17
通過列表調入電台	
— 列表功能	17

RDS

RDS 概述	18
用於最佳接收效果的自動調諧	
— AF 功能	19
接收交通通告	
— TA/TP 功能	20
用 AF 和 TA 設定預設 RDS 電台	20
通過節目類型調入電台	
— PTY	21
自動設定時鐘	
— CT	22

影像設定

選擇顯示模式和顯示圖案	23
自動消除顯示字元	
— AutoClear (頻譜分析器 / 全景 / 螢幕節能模式)	25
改變字元的透明度	
— BlendLevel (頻譜分析器 / 全景 / 螢幕節能模式)	25
設定飾板	
— Plaque	26
設定字元顏色	
— Color Sel	26
選擇影像的顯示時間	
— AutoImage	27

其它功能

使用旋轉式控制器	28
調節聲音特性	29
快速降低音量	29
改變聲音和顯示設定	
— 選單	30
設定動態攝影棚管理器 (DSO)	31
設定均衡器 (EQ7)	31
調節前後揚聲器音量	32
調節超重低音揚聲器音量	33
連接輔助音頻裝置	34
設定安全密碼	35

附加資訊

保養	36
拆卸本機	37
規格	38
故障排除	39
出錯顯示 / 訊息	40

控制器位置

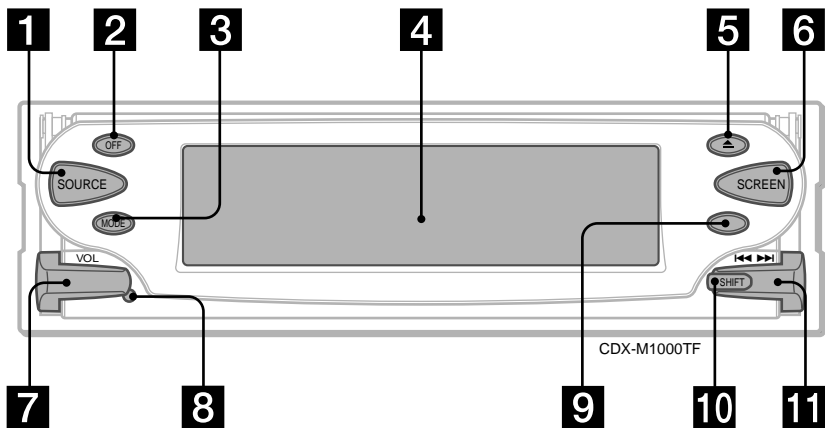

詳細說明，請參見列出頁。

- 1** SOURCE (電源打開 / 收音機 / CD/MD / AUX*1) 按鈕
用來選擇音源。
- 2** OFF (停止 / 電源關閉) 按鈕 *2 11, 34
- 3** MODE 按鈕
用來改變操作。
- 4** 顯示窗
- 5** ▲ (排出) OPEN/CLOSE 按鈕
如果本機內已經有光碟，用來排出光碟。
用來打開 / 關閉前面板。
- 6** SCREEN 按鈕
用來選擇顯示模式。
- 7** VOL (音量) 控制桿
向上或向下按 VOL 控制桿調高或調低音
量。
- 8** 復原按鈕 10
- 9** 用於卡片式遙控器和無線旋轉式控制器的
感應器
- 10** SHIFT (切換檔位 1-3) 按鈕
用來更改 I<<<<>>>I 控制桿的功能
(**11**)。

11 I<<<<>>>I 控制桿

向上或向下按 I<<<<>>>I 控制桿，來選擇
所需要的電台、想要調節的項目或所需要
的影像。

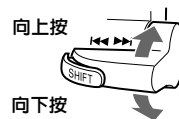

*1 當本機連接了 CD/MD 選購裝置時不顯示
“AUX”。

*2 警告

當安裝在點火開關上沒有 ACC (附件)
位置的汽車上時
關閉發動機後，必須按住裝置上的 (OFF)
不放，直至顯示消失。
否則，時鐘顯示將一直開著從而消耗電
池。

卡片式遙控器 RM-X132

卡片式遙控器上與本機上對應的按鈕控制相同的功能。

本手冊中的說明講述如何主要使用卡片式遙控器操作本機。

詳細說明，請參見列出頁。

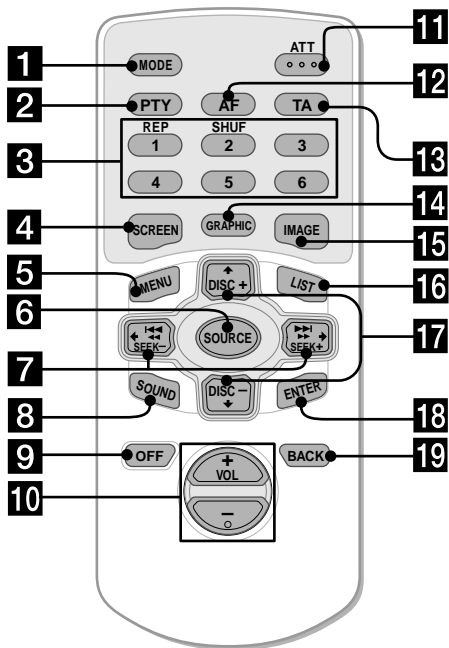

1 MODE 按鈕

2 PTY 按鈕

3 數字按鈕

① REP 13

② SHUF 13

存儲電台和收聽已儲存的電台。

4 SCREEN 按鈕

5 MENU 按鈕

用來顯示普通選單。

6 SOURCE 按鈕

7 ←/→ (SEEK-/+) 按鈕

8 SOUND 按鈕

用來顯示聲音選單。

9 OFF 按鈕

10 VOL (+/-) 按鈕

11 ATT 按鈕 29

12 AF 按鈕 19

13 TA 按鈕 20

14 GRAPHIC 按鈕

用來顯示影像選單。

15 IMAGE 按鈕

用來轉換顯示樣式。

16 LIST 按鈕 15, 17

17 ↑/↓ (DISC +/-) 按鈕

18 ENTER 按鈕

輸入設定。

19 BACK 按鈕

在某項設定中，用來返回前一個操作。

注意

按 (OFF) 使顯示消失後，除非先按本機上的 (SOURCE) 按鈕或裝入光碟激活本機，否則無法用卡片式遙控器操作。

提示

有關如何更換電池的詳細資訊請參見第 36 頁上的 "更換鋰電池"。

注意事項

- 倘若您的座車停在直射陽光下，則在操作前須先使本機充分冷卻。
- 本機運行時電動天線將自動伸出。
- 在駕駛中切勿使用 CUSTOM FILE 功能，或操作其他可能分散您對路況的注意力的功能。

若您有什麼關於本機的問題或困難，而本說明書沒有提及，請向您附近的 Sony 經銷商諮詢。

關於濕氣凝結

在雨天或非常潮濕的地區，本機的透鏡和顯示幕內會產生濕氣凝結。一旦如此，本機將無法正常運行。此時，請將光碟取出，並等待約一小時，直至濕氣蒸發。

為保持高品質聲音

時刻小心，切勿將果汁或其它飲料濺在本機或光碟上。

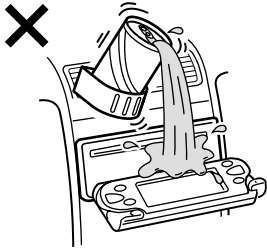

有關 LCD 顯示幕注意事項

- 切勿用力按 LCD 顯示幕。否則可能受傷或損壞顯示幕。
- LCD 顯示幕上可能會出現發光的亮點（紅色、藍色或綠色）或黑點。這是正常現象。LCD 是採用高精技術製造，有超過 99.99% 的像素是完整的。但是，可能有很少的像素會出現上述症狀。

光碟注意事項

- 為保持光碟清潔，切勿接觸表面。拿取光碟時請持其邊緣。
- 不使用時請將光碟裝入光碟盒或光碟匣內。切勿使光碟受到熱源 / 高溫的影響。避免將光碟遺留在停泊的車廂內、儀表盤 / 後托架上。

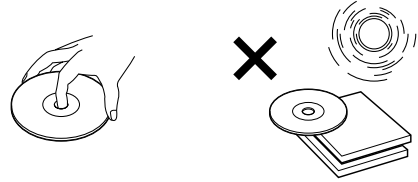

- 切勿貼標籤，或使用帶有黏性墨水 / 殘留物的光碟。這類光碟在使用時會停止轉動，從而造成故障或毀壞光碟。

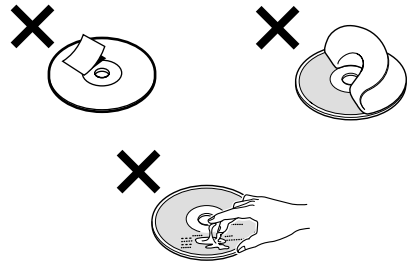

- 不要使用任何貼有標籤或粘紙的光碟。使用下列光碟將引起如下故障：
 - 不能排出光碟（因為標籤或粘紙脫落並堵塞彈出裝置）。
 - 不能正確讀取聲音數據（例如，跳躍播放或不播放），因為熱源使粘紙或標籤皺縮造成光碟彎曲。
- 本機不能播放非標準形狀的光碟（如，心型，正方形，星型）。若試圖播放此類光碟，則可能損壞本機。切勿使用此類光碟。
- 本機不能播放 8cm 光碟。
- 在播放之前，請使用商用清潔布清潔光碟。從光碟的中心向外擦拭。切勿使用汽油、稀釋劑、市場銷售的清潔劑或用於留聲機唱片的抗靜電噴霧劑等溶劑。

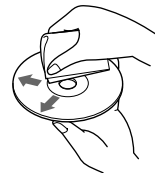

具有版權保護編碼的音樂光碟

本產品是專為播放符合 Compact Disc (CD) 標準光碟而設計。最近，一些唱片公司在市場上銷售各種具有版權保護編碼的光碟。請注意，這些光碟中可能有不符合 CD 標準的光碟，且可能無法使用本產品播放。

CD-Rs (可錄 CDs) / CD-RWs (可重寫 CDs)

注意事項

本裝置能播放下列光碟：

光碟類型	光碟上的標籤
音頻 CD	
MP3 檔案	

- 本機可能無法播放某些 CD-Rs/CD-RWs 光碟（視光碟錄製時所用設備或光碟狀況而定）。
- 本機無法播放尚未最終化* 的 CD-R/CD-RW 光碟。
- 您可以播放錄製在 CD-ROM，CD-Rs，和 CD-RWs 上的 MP3 檔案。
- 可播放能增加一個片段的 CD-R/CD-RW。

* 為使錄製的 CD-R/CD-RW 光碟能在音頻 CD 播放機上播放而必需的一個處理過程。

關於 MP3 檔案

MP3 (MPEG 1 Audio Layer-3) 是一項用於壓縮聲音順序的標準技術和格式。可將檔案壓縮到約為原大小的 1/10。超出人的聽覺範圍的聲音被壓縮，而我們能聽到的聲音未被壓縮。

光碟注意事項

您可以播放錄製在 CD-ROMs、CD-Rs 和 CD-RWs 上的 MP3 檔案。

光碟必須是 ISO9660*1 Level 1 或 Level 2 格式，或是擴展格式中的 Joliet 或 Romeo。您可以使用以 Multi Session*2 錄製的光碟。

*1 ISO 9660 格式

用於 CD-ROM 上的檔案和資料夾邏輯格式的最普通國際標準。

有幾個規格等級。在 Level 1 中，檔案名稱必須是 8.3 格式（名稱不能超過 8 個字符，擴展名 “.MP3” 中不能超過 3 個字符）且為大寫字母。資料夾名稱不能超過 8 個字符。不能有超過 8 個資料夾嵌套等級。Level 2 規格允許檔案名稱最多為 31 個字符。

每個資料夾最多能有 8 棵樹級。

對於擴展格式中的 Joliet 或 Romeo 格式，請確認寫入軟體等的容量。

*2 Multi Session

這是一種採用 Track-At-Once 方法，增加資料的錄製方法。普通 CDs 從稱為 Lead-in 的 CD 控制區開始，並在稱為 Lead-out 的控制區結束。Multi Session CD 是一種具有多話路的 CD，從 Lead-in 到 Lead-out 的每個分段被作為單獨的話路。

CD-Extra：是一種格式，將音頻（音頻 CD 資料）作為軌跡錄製在話路 1 中，將資料作為軌跡錄製在話路 2 中。

Mixed CD：在這種格式中，資料被錄製為軌跡 1 音頻（音頻 CD 資料）被錄製為軌跡 2。

續下頁 →

注意

- 除了 ISO 9660 level 1 和 level 2 格式，其它格式的資料夾名稱或檔案名稱可能無法正確顯示。
- 在命名時，必須在檔案名稱後加上擴展名 “.MP3”。
- 如果將擴展名 “.MP3” 加在非 MP3 檔案上，本機則無法正確識別該檔案，並將產生能損壞揚聲器的雜音。
- 以下光碟要花費較長時間才能開始播放。
 - 以複雜的樹形架構錄製的光碟。
 - 以 Multi Session 錄製的光碟。
 - 能增加資料的光碟。

播放以 Multi Session 錄製的光碟時的警告

- 當第一話路的第一個軌跡是音頻 CD 資料：
 - 僅播放音頻 CD 資料。
 - 無聲顯示非音頻 CD 資料 /MP3 檔案資訊（軌跡號碼和時間等）。
- 當第一話路的第一個軌跡不是音頻 CD 資料：
 - 如果光碟中有一個 MP3 檔案，則只播放 MP3 檔案，其他資料被跳過（未識別音頻 CD 資料）。
 - 如果光碟中沒有 MP3 檔案，則顯示 “NO Music” 且不播放任何內容（未識別音頻 CD 資料）。

MP3 檔案的播放順序

資料夾和檔案的播放順序顯示如下：

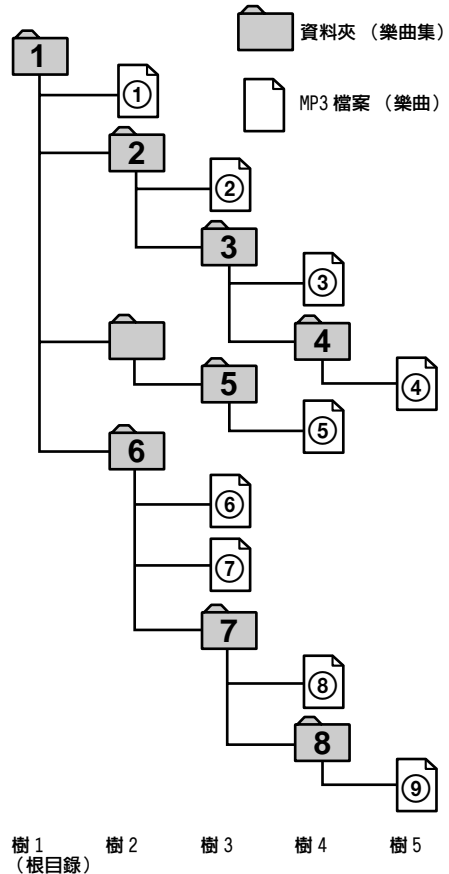

注意

- 不含有 MP3 檔案的資料夾被跳過。
- 最大資料夾數量：150（包括根目錄資料夾和空資料夾）。
- 一張光碟中能包含的 MP3 檔案和資料夾的最大數量：300。
 - 當檔案 / 資料夾名稱包含許多字符時，該數量可能小於 300。
- 能夠播放的最大樹級數量：8。

提示

若要規定所需要播放順序，在資料夾或檔案名稱之前，按照數字（例如：“01”，“02”）輸入順序，然後將內容錄製在光碟上（視寫入軟體而定，順序將有所不同）。

普通頂部選單顯示

按 (MENU) 進入普通頂部選單，然後選擇選單類別。您可以在普通選單顯示中選擇各種設定。如要進行選擇，按 (ENTER) 。若要回到前一個操作，按 (BACK) 鍵。若要完成設定並返回正常顯示，按 (MENU) 。

普通頂部選單顯示

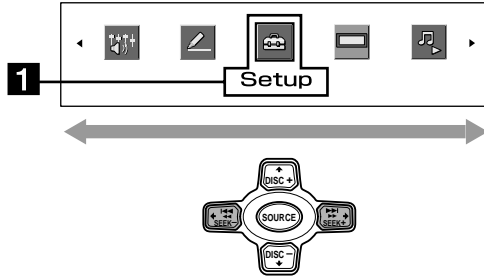

普通選單顯示

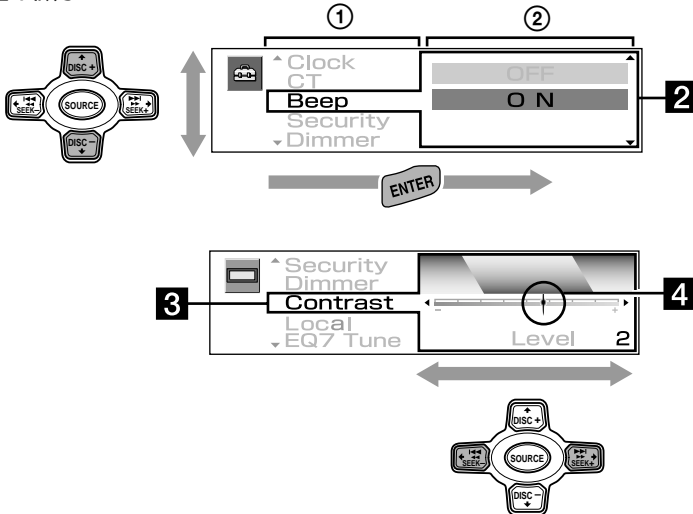

設定的圖示和目錄

-  Setup
基本設定
-  Display
顯示設定
-  PlayMode
播放和收聽電台的設定
-  SoundTuning
音質的精確設定
-  Edit
顯示字元設定

1 所選擇的選單類別

示例：Setup

2 所選擇的項目和設定

示例：Beep ON

注意

若要從 ① 移動到 ②，則按 (ENTER) 。

3 所選擇的項目和設定

示例：Contrast Level 2

4 發光點隨著等級的變換而移動

注意

所顯示的項目根據音源不同而有所區別。

入門指南

復原本機

在第一次使用本機前，或更換汽車電池或改變連接後，必須使本機復原。
用尖物按復原按鈕，如原子筆。
復原完成後將顯示預存的影像。按卡片式遙控器上的 (IMAGE) 顯示時鐘顯示，並設定時鐘和日曆。



復原按鈕

注意

按復原按鈕，將消除時鐘設定和某些已存儲的內容。

設定時鐘和日曆

時鐘採用 24 小時制數字顯示（日/月/年時間）。

預設設定為 “01/01/2003 01:00”。

- 1 按 (MENU)。
- 2 反覆按 ← 或 → 選擇 “Setup”。

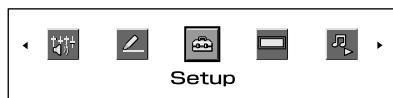

- 3 按 (ENTER)。
- 4 反覆按 ↑ 或 ↓ 選擇 “Clock”。
- 5 按 (ENTER)。

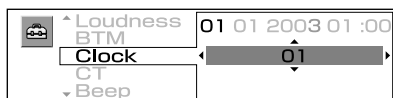

- 1 反覆按 ↑ 或 ↓ 按鈕，選擇日。
每按一次 ↑，日期號增加。
每按一次 ↓，日期號減小。
- 2 按 → 移動到月份，然後反覆按 ↑ 或 ↓ 設定月份。
如果按 ←，則將返回到左邊。
- 3 重複步驟 2 定年、小時和分鐘。
- 6 按 (ENTER)。
保存時鐘和日曆的設定，然後顯示返回正常顯示。

注意

如果您的汽車沒有 ACC 位置，請先關閉本機電源，然後設定時鐘和日曆。

提示

年份可以從 2000 設定至 2099。

CD 播放機

CD/MD 裝置 (選購件)

本機除播放 CD 外，還可控制外接的 CD/MD 裝置。

注意

若連接一台選購的帶 CD TEXT 功能的 CD 裝置，當播放 CD TEXT 光碟時，該 CD TEXT 資訊將出現在顯示幕上。

：用本機操作

：用卡片式遙控器操作



若要	按
停止播放	(OFF)
跳過樂曲 - 自動 音樂傳感器	←/→ 〔一次跳過一首樂曲〕
快進 / 後退 - 手動搜尋	←/→ 〔按住不放直至所需要的點〕
跳過光碟 - 光碟選擇	↑/↓ 〔一次跳過一張光碟〕
跳過樂曲集 * - 樂曲集選擇	↑/↓ 〔一次跳過一個樂曲集〕

播放光碟

(使用本機)

按 **▲** 打開前面板，然後插入光碟 (有標記的面朝上)。

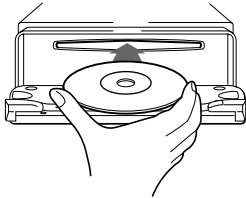

前面板關閉，然後自動開始播放。

若已裝入光碟，請反覆按 (SOURCE)，直至“ (CD 圖示)”或“CD”出現在顯示幕上，並開始播放。

注意

在提醒報警器發出提示音後前面板自動關閉。





若要	按
停止播放	(OFF)
排出光碟	▲
跳過樂曲 - 自動音樂傳感器	◀▶▶▶▶ 控制桿向上 / 向下 〔一次跳過一首樂曲〕
快進 / 後退 - 手動搜尋	◀▶▶▶▶ 控制桿向上 / 向下 〔按住不放直至所需要的點〕
跳過樂曲集 * - 樂曲集選擇	(SHIFT)，然後 ◀▶▶▶▶ 控制桿向上 / 向下 〔一次選擇一個專輯〕

* 僅在播放 MP3 檔案時適用。

注意

- 當正在讀取光碟中的資料時按 **▲**，在光碟排出前會有數秒鐘的延遲。
- 如果按前面板上的 **▲** 排出光碟，並將光碟留在槽內，則光碟保護功能將開始生效。光碟排出 15 秒鐘後，所排出的光碟將被自動拉出。
- 切勿對前面板施以過大的壓力 (特別在打開時)，否則會產生故障。
- 視光碟的錄製方法而定，開始播放第一首樂曲前可能需要等待 1 分鐘或更長時間。
- 視光碟的情況而定，可能無法播放光碟 (第 6, 7 頁)。
- 播放光碟上的第一首 / 最後一首樂曲時，若按 **↓** 或 **↑**，則跳至光碟的最後一首 / 第一首樂曲處開始播放。
- 當光碟中最後一首樂曲結束，則將從光碟的第一首樂曲重新開始播放。
- 當連接有選購裝置時，相同音源的播放也會在選購的 CD/MD 裝置上得已繼續。

(使用選購裝置)

- 反覆按 (SOURCE)，直至出現“ (CD 圖示)”、“CD”、“ (MD 圖示)”、“MD”或“MS*”。
- 反覆按 (MODE) 按鈕直至顯示所要的裝置。
播放開始。

* MS: MG Memory Stick System-up Player MGS-X1.

找到樂曲和光碟位置

請參見第 15 頁上的“通過名稱找出光碟”。

顯示項目

當更改光碟 / 樂曲集 *1/ 樂曲時，新光碟 / 樂曲集 / 樂曲中任何預先錄製的標題 將自動顯示。如果 “AutoScroll” 設定為 “ON”，名稱將捲動顯示（第 30 頁）。

標準模式：

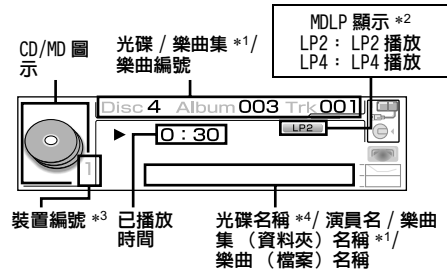

頻譜分析器 / 全景 / 螢幕節能模式：



時鐘模式：

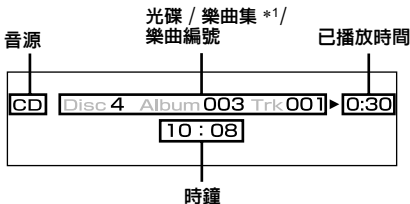

- *1 僅在播放 MP3 檔案時適用。
- *2 只有當連接了具有 MDLP 功能的 MD 裝置，而且播放 MDLP 光碟時才有效。
- *3 僅適用於當連接兩台或更多選購的 CD (MD) 裝置時。
- *4 如果該光碟已用本機的 CUSTOM FILE 功能標註過，因而顯示 光碟記憶功能。

注意

- 有些字元無法顯示。
- 對於一些帶很多字元的 CD TEXT 光碟，有些資訊可能無法顯示或捲動顯示。
- 本機不能顯示 CD TEXT 光碟上每個樂曲的演員名。

關於 MP3

- 當播放具有 ID3 標籤的 MP3 時，將顯示 ID3 標籤（演員名 / 樂曲集名稱 / 樂曲名稱）。
- ID3 標記僅適用於版本 1。
- ID3 標記的字元碼依照 ASCII 和 ISO 8859-1 標準。Joliet 格式光碟只能以 ASCII 顯示。不相容的字元將顯示為 “*”。
- 在下列情況中，已播放時間可能顯示不準確。
 - 當播放 VBR（可變比特速率）的 MP3 檔案時。
 - 快進 / 後退時。



提示

當 “AutoScroll” 設定為 “OFF”，且光碟 / 樂曲集 / 樂曲名稱被更改時，光碟 / 樂曲集 / 樂曲名稱不捲動顯示。

反覆播放樂曲

— 重複播放

您可以選擇：

- **REP**  — 重複當前樂曲。
 - **REP**  *1 — 重複當前樂曲集中的樂曲。
 - **REP**  *2 — 重複當前光碟中的樂曲。
- *1 僅在播放 MP3 檔案時適用。
*2 僅適用於當連接一台或多台選購的 CD/MD 裝置時。



在播放中，反覆按  (REP) 按鈕，直至所要的設定出現在顯示幕上。重複播放開始。

若要返回正常播放模式，則反覆按  (REP)，直至顯示幕中的圖示消失。

以隨機順序播放樂曲

— 隨機播放

您可以選擇：

- **SHUF**  *1 — 任意順序播放當前樂曲集中的樂曲。
- **SHUF**  — 任意順序播放當前光碟中的樂曲。
- **SHUF**  *2 — 任意順序播放當前選購 CD (MD) 裝置中的樂曲。
- **SHUF All** *3 — 以任意順序播放當前所有已連接的 CD (MD) 裝置 (包括本機) 中的全部樂曲。

*1 僅在播放 MP3 檔案時適用。

*2 僅適用於當連接一台或多台選購的 CD (MD) 裝置時。

*3 僅適用於連接一台或多台選購的 CD 裝置，或兩台及兩台以上選購的 MD 裝置時。

在播放中，反覆按  (SHUF) 按鈕，直至所要的設定出現在顯示幕上。隨機播放開始。

若要返回正常播放模式，則反覆按  (SHUF)，直至顯示幕中的圖示消失。

注意

“ **SHUF All** ” 不會打亂 CD 機和 MD 機互相之間的樂曲順序。

標註 CD

— 光碟記憶功能（用於帶 CUSTOM FILE 功能的選購 CD 機）

您能用自訂名稱標註每張光碟（光碟記憶功能）。您能給每盤光碟輸入最多 8 個字元。若標註了 CD，則可通過名稱找出光碟（第 15 頁）。

光碟記憶內容作為顯示項之一，其顯示總是優先於光碟中原有的 CD TEXT 資訊。

警告

在駕駛中切勿使用 CUSTOM FILE 功能，或操作其他可能分散您對路況的注意力的功能。

- 1 開始播放要標註的光碟。
- 2 按 (MENU)。
- 3 反覆按 ← 或 → 選擇 “Edit”。
- 4 按 (ENTER)。
- 5 按 ↑ 或 ↓ 選擇 “Name Edit”。
- 6 按 (ENTER)。

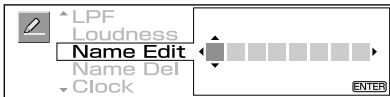

7 輸入字元。

- ① 反覆按 ↑ *1 選擇想要的字元。

A → B → C ... → 0 → 1 → 2 ... → + →
- → * ... → *2 → A

*1 相反順序按 ↓。

*2 空格

- ② 找到所需要的字元後按 →。



如果按 ←，則將返回到左邊。

- ③ 重複步驟 ① 和步驟 ②，以輸入整個名稱。
- 8 按 (ENTER)。
顯示幕返回頂部選單顯示。
- 9 按 (MENU)。
顯示返回正常顯示狀態。

提示

- 要更正或消除一個名稱，僅需覆蓋寫入或鍵入空格。
- 如連接了帶 CUSTOM FILE 功能的 CD 機，則可以在沒有此功能的裝置中對 CD 進行標註。光碟記憶將存儲在具有 CUSTOM FILE 功能的 CD 機記憶體中。

注意

在名稱編輯未完成時，重複 / 隨機播放暫時中斷。

刪除光碟記憶

- 1 反覆按 (SOURCE) 按鈕，選擇 “CD”。
- 2 反覆按 (MODE) 選擇具有 CUSTOM FILE 功能的 CD 機。
- 3 按 (MENU)。
- 4 反覆按 ← 或 → 選擇 “Edit”。
- 5 按 (ENTER)。
- 6 按 ↑ 或 ↓ 選擇 “Name Del”。
- 7 按 (ENTER)。
出現存儲的名稱。



- 8 反覆按 ↑ 或 ↓ 按鈕選擇想要刪除的光碟名稱。
- 9 按住 (ENTER) 2 秒鐘。
該名稱即被刪除。
若要刪除其它名稱，請重複步驟 8 和步驟 9 的操作。
- 10 按 (MENU)。
顯示返回正常顯示狀態。

注意

- 當 CD TEXT 光碟的光碟記憶被刪除後，則將顯示原有的 CD TEXT 資訊。
- 如果未找到您想要刪除的光碟記憶，請嘗試在步驟 2 中選擇另一個 CD 機。

提示

- 在步驟 7 中，如果沒有光碟記憶，則顯示將自動返回正常顯示狀態。
- 如果在步驟 9 中刪除全部光碟記憶，則顯示將自動返回正常顯示狀態。

通過名稱找出光碟

— 列表功能

(用於帶 CD TEXT/CUSTOM FILE 功能的 CD 機或 MD 機)

您能對已被賦予自訂名稱 *1 的光碟或對 CD TEXT 光碟 *2 使用此功能。

- 1 按 **(LIST)**。
顯示幕中出現所賦予的光碟名稱。

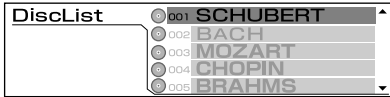

- 2 反覆按 **↑** 或 **↓**，選擇所需要的光碟。
- 3 按 **(ENTER)**。

*1 通過其自訂名稱尋找光碟：當對 CD (第14頁)或MD命名時。

*2 通過 CD TEXT 資訊尋找光碟：當在具有 CD TEXT 功能的 CD 機上播放 CD TEXT 光碟時。

注意

對於 CD TEXT 光碟和 MDs，某些字母無法被顯示。

提示

若要停止選擇並返回正常顯示，按 **(LIST)**。

收音機

本機在每一波段上 (FM1、FM2、FM3、MW 和 LW) 最多可存儲 6 個電台。

警告

當在駕車過程中要調諧電台時，須使用最佳調諧記憶功能 (BTM)，以免發生事故。

自動儲存電台

— 最佳調諧記憶功能 (BTM)

本機在選定的波段上篩選信號最強的電台，並按照它們的頻率順序進行儲存。

- 1 反覆按 **(SOURCE)**，直至出現 **(調諧器圖示)** “或波段”。
- 2 反覆按 **(MODE)** 按鈕選擇波段。
- 3 按 **(MENU)**。
- 4 反覆按 **←** 或 **→** 選擇 “Edit”。
- 5 按 **(ENTER)**。
- 6 反覆按 **↑** 或 **↓** 按鈕選擇 “BTM”。



- 7 按 **(ENTER)**。
所選擇波段中信號最強的電台按照頻率順序儲存在記憶體中。若要取消儲存，則在電台儲存過程中按 **(ENTER)**。
- 8 按 **(MENU)**。
顯示返回正常顯示狀態。

注意

- 若因信號微弱之故僅能接收到很少電台，則某些存儲的預設號碼仍將保留其以前的設定。
- 當顯示幕上顯示一個預設號碼時，本機會從當前顯示的數字開始儲存電台。

顯示項目

標準模式：

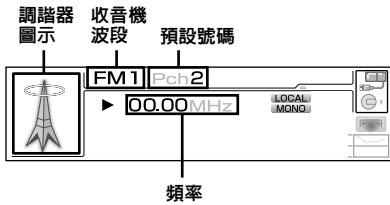

頻譜分析器 / 全景 / 螢幕節能模式：

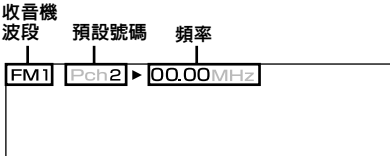

時鐘模式：

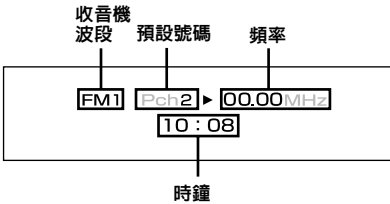

收聽已儲存的電台

- 1 反覆按 **(SOURCE)** 選擇收音機。
- 2 反覆按 **(MODE)** 選擇波段。
- 3 按存有所要電台的數字按鈕 (**①** 至 **⑥**)。

提示

按 **↑** 或 **↓**，按照已存入記憶體中的順序接收電台（預設搜尋功能）。

如果預設的調諧無效

— 自動調諧功能

按 **←** (SEEK-) 或 **→** (SEEK+) 搜尋電台（自動調諧）。

當本機接收到一個電台時，掃描即停止。如此反覆直至接收到所要的電台。

提示

- 如自動調諧中斷太頻繁，則開啓本地搜尋功能，把搜尋目標限制在信號較強的電台（請參見第 30 頁改變聲音和顯示設定）。
- 若您知道所要收聽的電台頻率，請按住 **←** 或 **→** 找到接近的頻率，然後反覆按 **←** 或 **→** 精確調整到所要的頻率（手動調諧）。

若 FM 立體聲的收音狀況不良

選擇單聲道收聽模式。

（請參見第 30 頁改變聲音和顯示設定）。聲音狀況得到改善，但變成了單聲道（“STEREO”顯示消失）。

提示

如果很難收聽到 FM 廣播，請將“DSO”設定為“OFF”（第 31 頁）。

僅儲存所要的電台

您可在任何指定的數字按鈕上手動預設所想要的電台。

- 1 反覆按 (SOURCE) 選擇收音機。
- 2 反覆按 (MODE) 選擇波段。
- 3 按 ←(SEEK-) 或 →(SEEK+) 調入想要儲存的電台。
- 4 按住所要的數字按鈕 (① 至 ⑥) 持續 2 秒鐘，直至顯示 “Memory”。
顯示您所預設的按鈕號碼，然後所選擇的電台被賦予此號碼並被儲存。

注意

若您試圖在已存入的號碼上儲存另一個電台，則以前存入的電台將被消除。

通過列表調入電台

— 列表功能

- 1 在收音機接收過程中，按 (LIST) 片刻。
當前調入電台的頻率和賦予的電台名稱出現在顯示幕上。

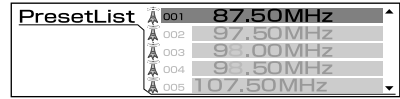

- 2 反覆按 ↑ 或 ↓，選擇所需要的電台。
若此電台未指定名稱，則電台的頻率顯示在顯示幕上。
- 3 按 (ENTER) 調入所要電台。
調諧完成後，顯示幕返回正常顯示。

提示

若要停止選擇並返回正常顯示，按 (LIST)。

RDS

RDS 概述

帶收音機資料系統 (RDS) 服務的 FM 電台在發送常規的收音機節目信號的同時還發送無聲的數碼資訊。例如，接收帶有 RDS 功能的電台時，將顯示下列資訊之一。

標準模式：

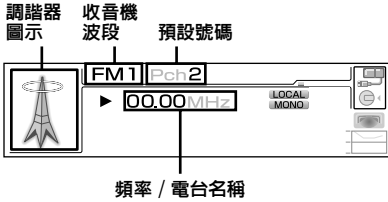

頻譜分析器 / 全景 / 螢幕節能模式：

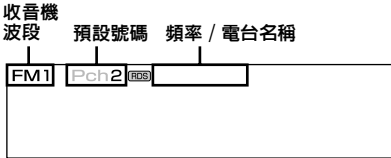

時鐘模式：

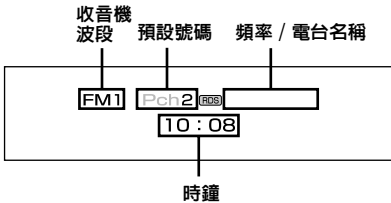

RDS 服務

RDS 資料還可為您提供其他方便，例如：

- 節目的**自動重調諧**，在長距離駕車時很有用。— AF→第 19 頁
- 在欣賞其他的節目 / 音源時接收**交通通告**。— TA→第 20 頁
- 通過廣播的 節目類型**選擇電台**。— PTY→第 21 頁
- 自動設定時鐘。CT→第 22 頁

注意

- 根據國家或地區而定，並非所有的 RDS 功能都可使用。
- 如果信號強度很弱或者如果您調入的電台不發射 RDS 資料，則 RDS 可能無法正確地工作。

用於最佳接收效果的自動調諧

— AF 功能

備用頻率 (AF) 功能允許收音機始終將該地區的最強信號調入您正在收聽的電台。

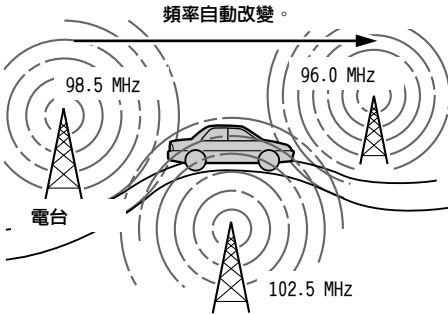

1 選擇一個 FM 電台 (第 15 頁)。

2 反覆按 **[AF]** 直至出現 “**[AF]**”。

本裝置開始在同一個網路中搜索信號更強的備用頻率。

若顯示 “NO AF”，表示當前調入的電台沒有備用頻率。

注意

當該地區沒有備用頻率時，或當無需搜尋備用頻率時，請關閉 AF 功能。

對於沒有備用頻率的電台

當電台名稱閃爍時按 **←** 或 **→** (8 秒鐘內)。

本機開始搜尋有相同 PI (節目標示) 資料的另一頻率 (出現 “PI Seek” 顯示)。

若本機無法找到相同的 PI，則本機返回至先前選擇的頻率。

停留在一個地區節目

當開啓 AF 功能時：本機的工廠設定將電台接收限制在一個指定的地區，因此您無法切換至頻率更強的另一個地區的電台。如果您離開該地區節目的接收範圍或希望利用整個 AF 功能，請從選單中選擇 “Regional OFF” (第 30 頁)。

注意

本功能在英國及其他一些地區無效。

本地連結功能 (僅限於英國)

本功能允許您選擇本區域中其他本地電台，即使這些電台未儲存在數字按鈕上。

- 1 按存有本地電台的數字按鈕 (① 至 ⑥)。
- 2 5 秒鐘之內，在此按該本地電台的數字按鈕。
- 3 如此反覆操作直至接收到所要的本地電台。

接收交通通告

— TA/TP

通過開啓交通通告 (TA) 和交通節目 (TP)，您可以自動調入正在廣播交通通告的 FM 電台。這些設定的功能與當前 FM 節目或音源 (CD/MD, AUX) 無關。當通告結束時，本機切回到最初的音源。

反覆按 (TA) 直至出現 “(TA)”。

本機開始搜尋交通資訊電台。

“(TP)” 表示這類電台的接收。若立即顯示 “NO TP”，本機將繼續搜尋有 TP 的電台。

要取消所有的交通通告，則使 “(TA)” 消失。

若要	按
----	---

取消當前通告	(TA)
--------	------

提示

- 您也可以通過按 (SOURCE) 或 (MODE) 按鈕取消當前通告。
- 按住本機上的 (MODE) 2 秒鐘也可以將 TA 設定為開/關。

預設交通通告的音量

您可以預設交通通告的音量電平，因此不會漏聽。

1 按 (VOL) 調節想要的音量電平。

2 按住 (TA) 2 秒鐘。
出現 “TA” 顯示且設定被保存。

收聽緊急通告

若 AF 或 TA 開啓，在收聽 FM 電台、CD/MD 或 AUX 時，若有緊急通告本機將切換至緊急通告。

用 AF 和 TA 設定預設 RDS 電台

預設 RDS 電台時，本機將儲存每個電台的 AF/TA 設定 (開啓/關閉) 及其頻率。您可以為單獨的預設電台選擇不同的設定 (AF、TA 或兩者)，或者為所有的預設電台選擇相同的設定。如果您用 “(AF)” 預設電台，本機自動儲存無線電信號最強的電台。

為所有的預設電台預設相同的設定

1 選擇一個 FM 波段 (第 15 頁)。

2 按 (AF) 和/或 (TA) 顯示 “(AF)” 和/或 “(TA)”。

請注意，關閉 “(AF)” 和 “(TA)” 將適用於非 RDS 電台，也適用於 RDS 電台。

3 按 (MENU)。

4 反覆按 ← 或 → 選擇 “Edit”。

5 按 (ENTER)。

6 按 ↑ 或 ↓ 選擇 “BTM”。

7 按 (ENTER)。

8 按 (MENU)。
顯示返回正常顯示狀態。

為每個預設電台預設不同的設定

1 選擇一個 FM 波段，並調入所要的電台 (第 17 頁)。

2 按 (AF) 和/或 (TA) 顯示 “(AF)” 和/或 “(TA)”。

3 按所要的數字按鈕 (① 至 ⑥)，直至顯示 “Memory”。

從步驟 1 重複操作預設其他電台。

通過節目類型調入電台

— PTY

您可以通過選擇想要收聽的節目類型來調入電台。

節目類型	顯示
新聞	News
時事	Current Affairs
資訊	Information
體育	Sport
教育	Education
戲曲	Drama
文化	Cultures
科學	Science
綜合	Varied Speech
流行音樂	Pop Music
搖滾樂	Rock Music
輕鬆悅耳的音樂或樂曲	Easy Listening
輕鬆的古典音樂	Light Classics M
嚴肅古典樂	Serious Classics
其他音樂類型	Other Music
天氣	Weather & Metr
財經	Finance
兒童節目	Children's Progs
社會事件	Social Affairs
宗教	Religion
來電	Phone In
旅遊	Travel & Touring
休閒	Leisure & Hobby
爵士樂	Jazz Music
鄉村音樂	Country Music
民族音樂	National Music
老歌	Oldies Music
民間音樂	Folk Music
紀錄片	Documentary

注意

在某些沒有可使用的 PTY（節目類型選擇）資料的國家無法使用此功能。

1 在收聽 FM 電台時按 (PTY)。

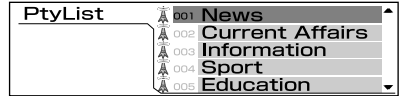

如果該電台正在發送 PTY 資料，則顯示當前的節目類型名稱。

如果接收的電台為非 RDS 電台，或未接收到 RDS 資料，則出現“-----”顯示。

2 反覆按 ↑ 或 ↓，選擇所需要的節目類型。

節目類型以表中所示的順序顯示。

如果節目類型不是 RDS 資料所指定的節目類型，則顯示“-----”。

3 按 (ENTER)。

本機開始搜尋正在廣播選定節目類型的電台。

自動設定時鐘

— CT

從 RDS 傳送的 CT（時鐘時間）資料自動設定時鐘。

- 1 按 **(MENU)**。
- 2 反覆按 **←** 或 **→** 選擇 “Setup”。
- 3 按 **(ENTER)**。
- 4 反覆按 **↑** 或 **↓** 按鈕選擇 “CT”。
- 5 按 **(ENTER)**。

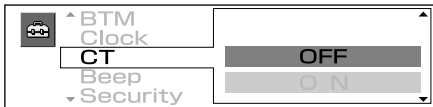

- 6 按 **↑** 或 **↓** 選擇 “ON”。
時鐘被設定。
- 7 按 **(ENTER)**。
顯示幕返回頂部選單顯示。
- 8 按 **(MENU)**。
顯示返回正常顯示狀態。

要取消 CT 功能，在步驟 6 中選擇 “OFF”。

注意

- 即使正在收聽 RDS 電台，CT 功能也可能不起作用。
- 用 CT 功能設定的時間可能與實際時間有差異。

影像設定

選擇顯示模式和顯示圖案

您可以選擇 5 種不同的顯示模式。您也可以選擇標準、頻譜分析器、全景、螢幕節能和時鐘模式等各種顯示圖案。

標準模式

顯示各種資訊，如音源、樂曲編號、已播放時間、光碟名稱、樂曲名稱和聲音設定。您可以顯示項目，如在顯示幕的左側顯示音源的圖示，在顯示幕的中間顯示較小的頻譜分析器圖案。

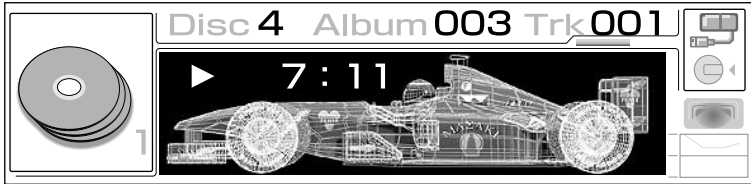

頻譜分析器模式

以整個螢幕顯示預先儲存的頻譜分析器設定。



全景模式

在整個螢幕上顯示預先儲存的靜止影像，其中一些影像自動捲動顯示。



螢幕節能模式

播放預先儲存的動畫。



自動消除顯示字元

— AutoClear (頻譜分析器 / 全景 / 螢幕節能模式)

在頻譜分析器 / 全景 / 螢幕節能模式中使顯示字元消失片刻。當設定為 ON，您可以只在改變光碟、樂曲集或樂曲時，或改變音源或顯示模式時顯示字元。您可以欣賞到完整的影像。

- 1 按 **(SOURCE)** 選擇音源 (收音機、CD、MD 或 AUX)。
- 2 按 **(GRAPHIC)**。
- 3 反覆按 **←** 或 **→** 選擇 “AutoClear”。
- 每按一次 **←** 或 **→**，項目如下改變。
AutoClear ↔ BlendLevel ↔
Plaque ↔ Color Sel ↔
AutoImage ↔ AutoClear

- 4 按 **(ENTER)**。

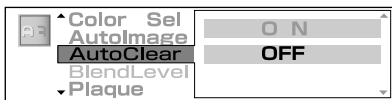

- 5 按 **(ENTER)**。



- 6 按 **↑** 或 **↓** 選擇 “ON”。
- 要取消自動消除功能，請選擇 “OFF”。
- 7 按 **(ENTER)**。
- 8 按 **(GRAPHIC)**。
- 顯示返回正常顯示狀態。

注意

在標準 / 時鐘模式中，您無法使顯示字元自動消失。

改變字元的透明率

— BlendLevel (頻譜分析器 / 全景 / 螢幕節能模式)

在頻譜分析器 / 全景 / 螢幕節能模式中，您可以設定字元的透明率 (色彩密度)。通過調低此等級，您可以調節顯示幕中的字元，使字元不再透明。

- 1 按 **(SOURCE)** 選擇音源 (收音機、CD、MD 或 AUX)。
- 2 按 **(GRAPHIC)**。
- 3 反覆按 **←** 或 **→** 選擇 “BlendLevel”。
- 每按一次 **←** 或 **→**，項目如下改變。
AutoClear ↔ BlendLevel ↔
Plaque ↔ Color Sel ↔
AutoImage ↔ AutoClear
- 4 按 **(ENTER)**。

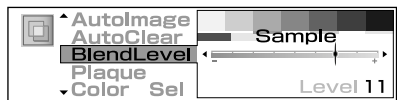

- 5 按 **(ENTER)**。

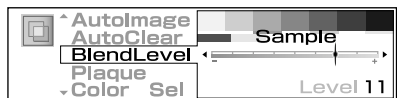

- 6 按 **←** 或 **→** 選擇透明率 (等級 0-15)。
- 等級越低，顯示字元越黯淡。
- 7 按 **(ENTER)**。
- 8 按 **(GRAPHIC)**。
- 顯示返回正常顯示狀態。

注意

- 在標準 / 時鐘模式中，您無法改變顯示字元的透明率。
- 當 “Plaque” 設定為 “ON”，不管如何設定 “BlendLevel” 均無效。

設定飾板

— Plaque

如果字元漸漸顯示出背景影像相似的色彩，飾板設定將使字元更容易看清。

- 1 按 **(SOURCE)** 選擇音源（收音機、CD、MD 或 AUX）。
- 2 按 **(GRAPHIC)**。
- 3 反覆按 **←** 或 **→** 選擇 “Plaque”。
每按一次 **←** 或 **→**，項目如下改變。
AutoClear ↔ BlendLevel ↔
Plaque ↔ Color Sel ↔
AutoImage ↔ AutoClear
- 4 按 **(ENTER)**。

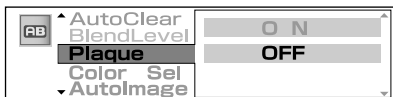

- 5 按 **(ENTER)**。



- 6 反覆按 **↑** 或 **↓** 按鈕選擇 “ON”。

- 7 按 **(ENTER)**。

- 8 按 **(GRAPHIC)**。
顯示返回正常顯示狀態。

注意

如果 “Plaque” 設定為 “ON”，您所調節的 “BlendLevel” 設定無效。

設定字元顏色

— Color Sel

您可以在 7 種顏色設定中選擇一種用於字元顯示。此外，您還可以調節顏色並將需要的顏色儲存在本機中。

選擇字元顏色

- 1 按 **(SOURCE)** 選擇音源（收音機、CD、MD 或 AUX）。
- 2 按 **(GRAPHIC)**。
- 3 反覆按 **←** 或 **→** 選擇 “Color Sel”。
每按一次 **←** 或 **→**，項目如下改變。
AutoClear ↔ BlendLevel ↔
Plaque ↔ Color Sel ↔
AutoImage ↔ AutoClear
- 4 按 **(ENTER)**。



- 5 按 **(ENTER)**。



- 6 反覆按 **↑** 或 **↓** 按鈕，選擇所需要的顏色。
每按一次 **↑** 或 **↓**，字元顏色發生改變。
藍色 ↔ 白色 ↔ 綠色 ↔ 粉紅色
↔ 黃色 ↔ 紫色 ↔ 黑色 ↔ 白訂 ↔ 藍色

- 7 按 **(ENTER)**。

- 8 按 **(GRAPHIC)**。
顯示返回正常顯示狀態。

調節字元顏色

- 1 按 **(SOURCE)** 選擇音源 (收音機、CD、MD 或 AUX)。
- 2 按 **(GRAPHIC)**。
- 3 反覆按 **←** 或 **→** 選擇 “Color Sel”，然後按 **(ENTER)**。
每按一次 **←** 或 **→**，項目如下改變：
AutoClear ↔ BlendLevel ↔
Plaque ↔ Color Sel ↔
AutoImage ↔ AutoClear
- 4 按 **(ENTER)**。
- 5 按 **↑** 或 **↓** 選擇 “Custom”，然後按 **(ENTER)**。



- 6 反覆按 **↑** 或 **↓** 選擇紅 - 綠 - 藍中的一種顏色。
每按一次 **↑** 或 **↓** 改變項目。
- 7 按 **←** 或 **→** 調節原色等級。
重複步驟 7 和 8 將自元顯示設定為所需要的顏色。
- 8 按 **(ENTER)**。
- 9 按 **↑/↓** 選擇 “Save”，然後按 **(ENTER)**。
若要返回原先色字元顏色，選擇 “Cancel”，然後按 **(ENTER)**。
若要恢復預設字元顏色，選擇 “Reset”，然後按 **(ENTER)**。
- 10 按 **(GRAPHIC)**。
顯示返回正常顯示狀態。

選擇影像的顯示時間

— AutoImage

按順序自動切換預先儲存的影像。您可以選擇一個影像的顯示時間。

- 1 按 **(SOURCE)** 按鈕選擇音源 (收音機、CD、MD 或 AUX)。
- 2 按 **(GRAPHIC)**。
- 3 反覆按 **←** 或 **→** 選擇 “AutoImage”。
每按一次 **←** 或 **→**，項目如下改變：
AutoClear ↔ BlendLevel ↔
Plaque ↔ Color Sel ↔
AutoImage ↔ AutoClear
- 4 按 **(ENTER)**。



- 5 按 **(ENTER)**。



- 6 反覆按 **↑** 或 **↓** 選擇一個影像的顯示時間。
每按一次 **↑** 或 **↓**，項目如下改變：
Middle ↔ Fast ↔ OFF ↔ Slow ↔ Middle
若要取消消幻燈片放映功能，請選擇 “OFF”。
- 7 按 **(ENTER)**。
- 8 按 **(GRAPHIC)**。
顯示返回正常顯示狀態。

其它功能

您也可用旋轉式控制器（選購件）控制本機（和選購的 CD/MD 裝置）。

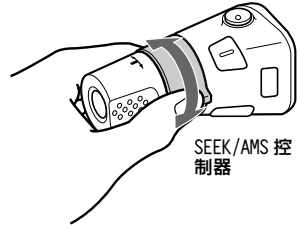

使用旋轉式控制器

首先，根據您設想的旋轉式控制器安裝方式貼上合適的標籤。
旋轉式控制器通過按按鈕和 / 或轉動控制器進行操作。

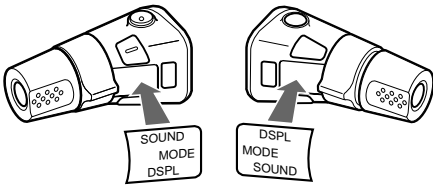

轉動然後鬆開，即可：

- 跳過樂曲
要連續跳過樂曲，轉動一次並在 2 秒鐘之內再次轉動並握住控制器。
- 自動調入電台。

轉動、握住、然後鬆開，即可：

- 快進 / 後退一首樂曲。
- 手動尋找電台。

推入並轉動控制器

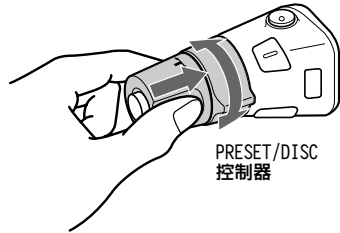

推入並轉動控制器，即可：

- 收聽預設的電台。
- 在 CD (MD) 播放過程中更換光碟 *1。

在播放包含 MP3 檔案的 CD 過程中 (使用本機)

推入並轉動控制器，即可：

- 更換樂曲集。

(使用選購裝置)

推入並轉動控制器，即可：

- 逐個更換光碟。

推入，然後轉動控制器並保持片刻，即可：

- 進入樂曲集跳躍模式。在 2 秒鐘內，再次推入並轉動繼續跳躍。

*1 僅當連接有相應的選購裝置時。

*2 如果您的汽車點火鑰匙開關上沒有 ACC (輔助) 位置，熄火後必須按住 (OFF) 直至顯示消失。

通過按按鈕

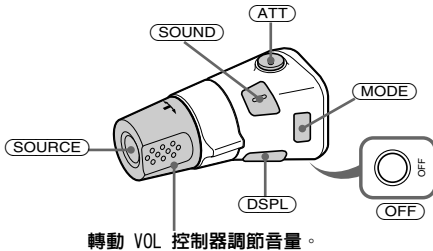

按	若要
(SOURCE)	改變音源 (收音機 /CD/MD*1 /AUX) / 電源開
(MODE)	改變操作 (收音機波段 /CD 裝置 *1/ MD*1 裝置)
(ATT)	減弱音量
(OFF) *2	停止播放或無線電 接收 / 關電源
(SOUND)	顯示聲音選單
(DSPL)	選擇顯示模式

注意

旋轉式遙控器上的 DSPL 按鈕與本機的 SCREEN 按鈕作用相同。

改變操作方向

控制器如下圖所示的操作方向為出廠設定。

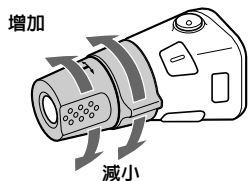

若需要將旋轉式控制器安裝在汽車方向盤軸的右側，您可以將控制器的操作方向反置。

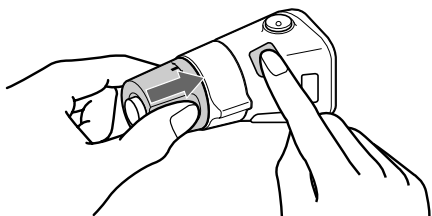

在推動“VOL”控制器的同時按住

SOUND 按鈕 2 秒鐘。

注意

當推入 VOL 控制器時如果按住 **SOUND** 2 秒鐘，顯示幕中將出現“Normal”或“Reverse”。

- “Normal” 為在預設位置使用旋轉式控制器。
- “Reverse” 是當旋轉式控制器安裝在方向盤軸的右側時使用。

調節聲音特性

您可以調節低音、高音、平衡、音量衰減和超低音揚聲器的音量。

- 1 按 **SOURCE** 按鈕選擇音源（收音機、CD、MD 或 AUX）。
- 2 按 **SOUND** 。
- 3 反覆按 **←** 或 **→** 選擇想要調節的項目。每按一次 **←** 或 **→**，項目如下改變：
DS0 ↔ EQ7 ↔ Bass ↔ Treble
↔ Balance（左-右）
↔ Fader（前-後）
↔ SubWoofer（超重低音揚聲器音量）
- 4 按 **ENTER** 。
- 5 按 **←** 或 **→** 調節選擇項目。
- 6 按 **ENTER** 。

快速降低音量

按 **ATT** 。

“ATT”暫時出現在顯示幕中。

要恢復原先的音量電平時，請再按一次

ATT 。

提示

當車載電話的連接電纜連接在 ATT 導線上，則在有電話打入時本機會自動減小音量（電話 ATT 功能）。

改變聲音和顯示設定

一 選單

您可設定以下項目：

Setup

- Clock (第 10 頁)
- CT (時鐘時間) (第 22 頁)
- Beep — 打開或關閉提示音
- AUX Skip*1 (第 34 頁) 打開或關閉 AUX 音源顯示。
- Security (第 35 頁) 設定安全密碼防止偷竊。

Display

- Dimmer — 改變顯示幕亮度。
 - 選擇 “AUTO”，僅在打開汽車照明時使顯示幕變暗。
 - 選擇 “ON” 使顯示幕變暗。
 - 選擇 “OFF” 關閉減光器。
- Contrast — 如果由於本機的安裝位置而導致顯示幕上的指示無法識別，則用來調整對比度。
- AutoScroll*2
 - 選 “ON” 則捲動顯示所有自動顯示的名稱。
 - 當 “Auto scroll” 設定為 “OFF”，且光碟 / 樂曲名稱被改變時，光碟 / 樂曲名稱不捲動顯示。

PlayMode

- Local (本地搜尋模式) (第 16 頁)
 - 選 “ON” 則只調入信號較強的電台。
- Mono (單聲道模式) (第 16 頁)
 - 選 “ON” 則以單聲道收聽 FM 立體聲廣播。選擇 “OFF” 則返回正常模式。
- Regional (第 19 頁)

SoundTuning

- EQ7 Tune (第 31 頁) 調節均衡曲線。
- HPF (高通濾波器) (第 32 頁)
- LPF (低通濾波器) (第 33 頁)
- Loudness — 在處於低音量時仍能欣賞到低音和高音。低音和高音將被增強。
- AUX Level*3 (第 34 頁) — 調節連接的輔助設備的音量電平。

*1 僅在按 (OFF) 顯示時鐘時顯示。

*2 僅在播放 CD 或 MD 時顯示。

*3 僅在音源為 AUX 時顯示。

注意

只有在未連接選購 CD/MD 機時，才顯示 “AUX Skip” 和 “AUX Level”。

1 按 (MENU)。

若要設定 “AutoScroll”，則在 CD/MD 播放過程中按 (MENU)。

2 反覆按 ← 或 → 選擇所需要的項目。

3 按 (ENTER)。

4 反覆按 ↑ 或 ↓ 選擇想要調節的項目。

5 按 (ENTER)。

6 反覆按 ↑ 或 ↓，選擇所需要的設定（例如：“ON” 或 “OFF”）。

7 按 (ENTER)。

顯示幕返回頂部選單顯示。

8 按 (MENU)。

顯示返回正常顯示狀態。

注意

所顯示的項目根據音源不同而有所區別。

設定動態攝影棚管理器 (DSO)

若您的揚聲器裝在車門的較低部位，則聲音將從下面傳出，且可能不清晰。

DSO (動態攝影棚管理器) 功能創造出更加環繞的聲音，好似在儀表板上裝有多個揚聲器 (虛擬揚聲器)。

您可以為每個音源存儲 DSO 設定。

DSO 模式和虛擬揚聲器的成像

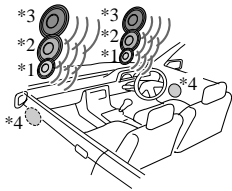

- *1 DSO 1
- *2 DSO 2
- *3 DSO 3
- *4 DSO OFF

- 1 按 (SOURCE) 按鈕選擇音源 (收音機、CD、MD 或 AUX)。
- 2 按 (SOUND) 。
- 3 反覆按 ← 或 → 選擇 “DSO”。
- 4 按 (ENTER) 。



- 5 反覆按 ← 或 → 選擇 DSO 模式 (DSO 1-3)。
若要取消 DSO 功能，請選擇 “OFF”。
- 6 按 (ENTER) 。

注意

- 根據不同的汽車內部類型和音樂類型，DSO 功能不一定能得到滿意的效果。
- 如果很難收聽到 FM 廣播，請將 “DSO” 設定於 “OFF”。

提示

DSO 模式的音響效果隨數字的增大而增加。

設定均衡器 (EQ7)

您可以為 7 種音樂類型 (Xplod、Vocal、Club、Jazz、New Age、Rock 和 Custom) 選擇均衡曲線。

您可以為每個音源調節不同的均衡設置。

選擇均衡曲線

- 1 按 (SOURCE) 按鈕選擇音源 (收音機、CD、MD 或 AUX)。
- 2 按 (SOUND) 。
- 3 反覆按 ← 或 → 選擇 “EQ7”。
- 4 按 (ENTER) 。



- 5 反覆按 ← 或 → 按鈕，選擇均衡器。
要取消均衡效果，選擇 “OFF”。
- 6 按 (ENTER) 。

注意

在 DSO 有效時，均衡設定將被自動調節到最佳整體效果。

調節均衡曲線

您可以存儲和調節均衡器設定的頻率和電平。

- 1 按 (SOURCE) 按鈕選擇音源 (收音機、CD、MD 或 AUX)。
 - 2 按 (MENU) 。
 - 3 反覆按 ← 或 → 選擇 “SoundTuning”。
 - 4 按 (ENTER) 。
 - 5 反覆按 ↑ 或 ↓ 選擇 “EQ7 Tune”。
 - 6 按 (ENTER) 。
- 示例：EQ7 Tune “Xplod”



續下頁 →

7 反覆按 **↑** 或 **↓**，選擇所需要的均衡曲線。

8 按 **(ENTER)**。

9 選擇您所要的頻率和電平。

① 反覆按 **←** 或 **→** 選擇所需要的頻率。
每按一次 **←** 或 **→**，頻率便改變。

62 Hz ↔ 157 Hz ↔ 396 Hz
↔ 1000 Hz ↔ 2510 Hz
↔ 6340 Hz ↔ 16000 Hz

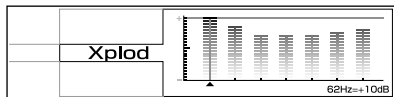

② 反覆按 **↑** 或 **↓**，調節所需要的電平。
音量電平以 1dB 遞增，從 -10dB 至 +10dB 進行調節。

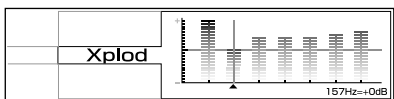

如要復原至出廠設定的均衡曲線，請按住 **(ENTER)** 按鈕持續 2 秒鐘。

③ 重複步驟 ① 和步驟 ②，調節均衡曲線。

10 按 **(ENTER)**。

完成效果設定之後，顯示幕即返回正常顯示。

調節前後揚聲器音量

1 按 **(SOURCE)** 按鈕選擇音源（收音機、CD、MD 或 AUX）。

2 按 **(SOUND)**。

3 反覆按 **←** 或 **→** 選擇 “Fader”。

4 按 **(ENTER)**。



5 反覆按 **←** 或 **→** 按鈕，調節前置 / 後置揚聲器的音量。

6 按 **(ENTER)**。
顯示返回正常顯示狀態。

調節前 / 後揚聲器的截止頻率。

為了與所安裝的揚聲器系統特性相匹配，您可以選擇揚聲器的截止頻率。

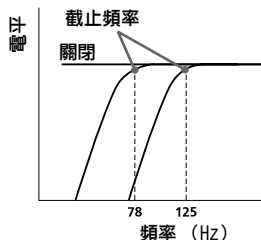

1 在播放中或無線電接收時，按 **(MENU)**。

2 反覆按 **←** 或 **→** 選擇 “SoundTuning”。

3 按 **(ENTER)**。

4 反覆按 **↑** 或 **↓** 按鈕選擇 “HPF”。

5 按 **(ENTER)**。



6 按 **↑** 或 **↓** 選擇截止頻率。
每按一次 **↑** 或 **↓**，頻率如下改變：

OFF（預設設定） ↔ 78 Hz ↔ 125 Hz

7 按 **(MENU)**。
完成頻率設定之後，顯示幕即返回正常顯示。

調節超重低音揚聲器音量

- 1 按 **(SOURCE)** 按鈕選擇音源（收音機、CD、MD 或 AUX）。
- 2 按 **(SOUND)**。
- 3 反覆按 **←** 或 **→** 選擇 “SubWoofer”。
- 4 按 **(ENTER)**。



- 5 反覆按 **←** 或 **→** 調節音量。
- 6 按 **(ENTER)**。
顯示返回正常顯示狀態。

提示

音量電平可以在 -10 dB 至 +10 dB 之間進行調節（低於 10 dB 時顯示 “-∞ dB”）。

調節超重低音揚聲器截止頻率

為了與所連接的超重低音揚聲器特性相匹配，您可以截斷不需要的高頻和中頻訊號進入超重低音揚聲器。通過設定截止頻率（見下圖），超重低音揚聲器將僅輸出低頻訊號，使您能獲得更清晰的聲音。

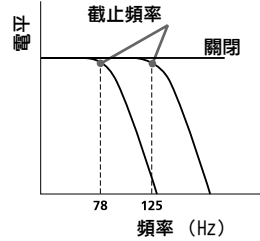

- 1 在播放中或無線電接收時，按 **(MENU)**。
- 2 反覆按 **←** 或 **→** 選擇 “SoundTuning”。
- 3 按 **(ENTER)**。
- 4 反覆按 **↑** 或 **↓** 按鈕選擇 “LPF”。
- 5 按 **(ENTER)**。



- 6 按 **↑** 或 **↓** 選擇截止頻率。
每按一次 **↑** 或 **↓**，頻率如下改變：
OFF（預設設定） ↔ 125 Hz ↔ 78 Hz
- 7 按 **(MENU)**。
完成頻率設定之後，顯示幕即返回正常顯示。

連接輔助音頻裝置

本機上的的 AUX IN（外部音頻輸入）端子也用作 BUS AUDIO IN（音頻輸入）端子。
通過連接一個選購的 Sony 輕便裝置，您可以從汽車揚聲器收聽聲音。

注意

如果連接了一個選購的 Sony CD/MD 機，則您不能再連接任何輕便裝置，並且不能選擇“AUX”。

選擇輔助設備

反覆按 (SOURCE) 按鈕，選擇“AUX”。

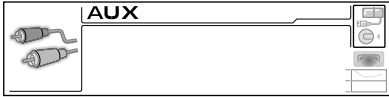

調節音量電平。

您可以為連接的各音響設備調節音量。

- 1 按 (MENU)。
- 2 反覆按 ← 或 → 選擇 “SoundTuning”。
- 3 按 (ENTER)。
- 4 反覆按 ↑ 或 ↓ 按鈕選擇 “AUX Level”。
- 5 按 (ENTER)。
- 6 反覆按 ← 或 → 調節音量電平。
音量電平以 1dB 遞增，從 -6dB 至 +6dB 進行調節。
- 7 按 (ENTER)。
顯示幕返回頂部選單顯示。
- 8 按 (MENU)。
顯示返回正常顯示狀態。

要關閉音源顯示中的輔助裝置

- 1 按 (OFF)。
CD/MD 播放或無線電接收停止（按鈕照明和顯示仍保留）。
- 2 按 (MENU)。
- 3 反覆按 ← 或 → 選擇 “Setup”。
- 4 按 (ENTER)。
- 5 反覆按 ↑ 或 ↓ 選擇 “AUX Skip”。
- 6 按 (ENTER)。
- 7 按 ↓ 選擇 “ON”。
- 8 按 (MENU)。

若要恢復指示，選擇 “AUX Skip OFF”。

設定安全密碼

本機具有防盜安全功能。輸入 4 位數作為您的安全密碼。

如果設定了安全密碼，則一旦您將本機重新安裝到其它汽車中或更換電池後，需要輸入已儲存的密碼才能打開本機。

- 1 按 **(MENU)**。
- 2 反覆按 **←** 或 **→** 選擇 “Setup”。
- 3 按 **(ENTER)**。
- 4 反覆按 **↑** 或 **↓** 按鈕選擇 “Security”。
- 5 按 **(ENTER)**。
顯示密碼設定顯示。

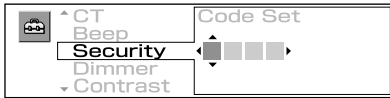

- 1 反覆按 **↑** 或 **↓** 按鈕輸入第一位數字 (0-9)。
 - 2 按 **→** 將游標移動到第二位數字，然後反覆按 **↑** 或 **↓** 輸入第二位數字。每按一次 **↑**，數字將增大，每按一次 **↓**，則數字減小。
 - 3 重複步驟 2 輸入第 3 位和第 4 位數字。
- 6 按 **(ENTER)**。
出現確認密碼顯示。
 - 7 反覆按 **↑** 或 **↓** 選擇 “YES”。



- 8 按 **(ENTER)**。
顯示返回正常顯示狀態。

注意

- 安全密碼不能用數字按鈕 (1-6) 輸入。
- 切勿忘記您的安全密碼。
- 如果您在步驟 7 中選擇 “NO”，並按 **(ENTER)**，則顯示將返回步驟 5 中的密碼設定顯示。

完成安全密碼設定後

一旦您將本機重新安裝到其它汽車上或更換電池，則打開本機後將出現確認密碼顯示。請用游標按鈕輸入您的 4 位數密碼 (**↑/↓/→**)，然後按 **(ENTER)**。

密碼輸入顯示

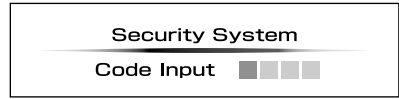

- OK**: 返回日曆 / 時鐘顯示。
- NG**: 出現 “CODE ERROR” 訊息。
使用游標按鈕輸入正確的密碼。

取消安全密碼

重複 “設定安全密碼” 中步驟 1 至步驟 4 (出現密碼刪除顯示)。用游標按鈕 (**↑/↓/→**) 輸入您儲存的密碼，然後按 **(ENTER)**。

顯示 Code Del

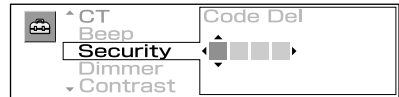

- OK**: 返回正常顯示。
- NG**: 出現 “CODE ERROR” 訊息。
使用游標按鈕輸入正確的密碼。

注意

只有刪除了已儲存的密碼，才能更改安全密碼。

提示

如果未儲存安全密碼，則不出現密碼刪除顯示。

附加資訊

保養

更換保險絲

更換保險絲時，必須確保所使用的保險絲與原保險絲的安培數相同。若保險絲燒斷，請檢查電源連接並再更換保險絲。若保險絲更換後又被燒斷，則可能是內部故障。此時，請向最近的 Sony 經銷商諮詢。

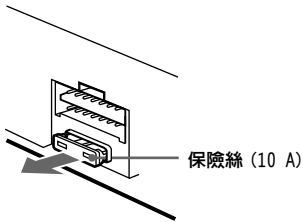

警告

切勿使用額定安培數超過本機附帶保險絲安培數的保險絲，否則會損壞本機。

更換鋰電池

一般情況下，電池能維持大約 1 年的時間。（使用壽命可能會變短，這取決於電池的使用狀況。）當電池的電力變弱時，卡片式遙控器的操作距離將變短。此時，請更換一個新的 CR2025 鋰電池。使用其他電池可能有引起火災或爆炸的危險。

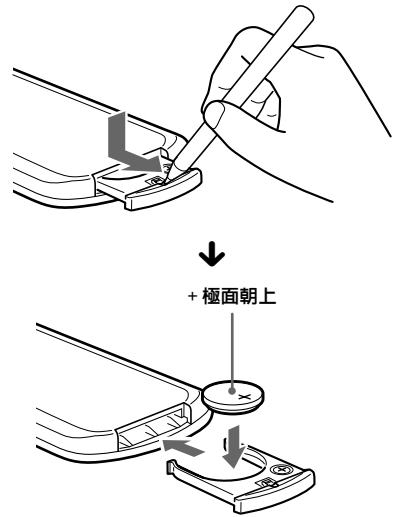

鋰電池的注意事項

- 鋰電池應放在兒童不易觸及的地方。萬一誤吞了電池，請立即找醫生。
- 用乾布擦拭電池，以保持接觸良好。
- 安裝電池時，必須保證極性正確。
- 別用金屬鑷子去夾電池，否則會引起短路。

警告

電池處置不當會引起電池爆炸。
切勿對電池充電，拆解或投入火中。

拆卸本機

1 拆卸保護環。

- ❶ 將開鎖鑰匙與保護環啮合。

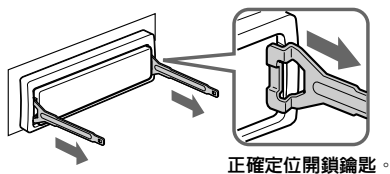

- ❷ 拉出開鎖鑰匙以拆下保護環。

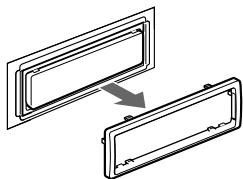

2 取出裝置。

- ❶ 將兩把開鎖鑰匙一起插入，直至聽到喀嗒聲。

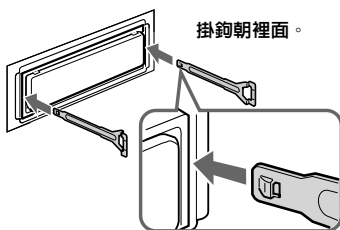

- ❷ 拉出開鎖鑰匙，使裝置脫離原位。

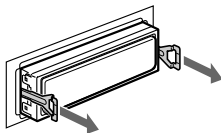

- ❸ 將本機從安裝位置滑出。

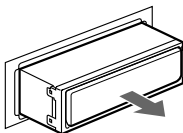

規格

CD 播放機部分

信噪比	90 dB
頻率響應	10-20,000 Hz
抖晃率	低於可測限制

調諧器部分

FM	
調諧範圍	87.5 -108 MHz
天線端子	外接天線連接器
中頻	10.7 MHz/450 kHz
可用靈敏度	9dBf
選擇度	400 kHz 時為 75 dB
信噪比	67 dB (立體聲), 69 dB (單聲道)

1 kHz 時諧波失真

	0.5 % (立體聲), 0.3 % (單聲道)
	1 kHz 時 35 dB
	30-15,000 Hz

分離度
頻率響應

MW/LW

調諧範圍	MW: 531-1,602 kHz LW: 153-279 kHz
天線端子	外接天線連接器
中頻	10.7 MHz/450 kHz
靈敏度	MW: 30 μ V LW: 40 μ V

功率放大器部分

輸出	揚聲器輸出 (可靠密封連接器)
揚聲器阻抗	4-8 Ω
最大功率輸出	52 W \times 4 (4 Ω 時)

一般

輸出	音頻輸出 (前/後) 超低音揚聲器輸出 (單聲道) 電動天線繼電控制端子 功率放大器控制端子 電話 ATT 控制端子 照明控制端子 BUS 控制輸入端子 BUS 音頻輸入/AUX IN 端子
輸入	天線輸入端子
音調控制	100 Hz 時低音 \pm 8dB 10 kHz 時高音 \pm 8dB
響度	100 Hz 時 +8dB 10 kHz 時 +2dB
電源要求	12 V DC 汽車電池 (負接地)
尺寸	約 . 178 \times 50 \times 181 mm (寬/高/深)
安裝尺寸	約 . 182 \times 53 \times 160 mm (寬/高/深)
質量	約 1.6 kg
提供的附件	卡片式遙控器 RM-X132 (1) 安裝和連接用配件 (一套) 前面板蓋 (1) 旋轉式控制器 RM-X4S 無線旋轉式控制器 RM-X6S BUS 電纜 (附帶一根 RCA 針型導線) RC-61 (1 m), RC-62 (2 m)
選購附件	CD 換碟機 (6 碟式) CDX-T70MX, CDX-T69 MD 換碟機 (6 碟式) MDX-66XLP MG-MS System-up Player MGS-X1 音源選擇器 XA-C30 AUX-IN 選擇器 XA-300
選購裝置	

注意

本裝置不能連接至數位前置放大器或與 Sony BUS 系統相容的均衡器。

設計和規格若有變更,恕不另行通知。

故障排除

下列檢查表有助於解決您使用本機時可能遇到的問題。
在使用下面的檢查表之前，請檢查連接和操作步驟是否正確。

一般

操作按鈕無效。
按復原按鈕。

無聲。

- 向上按 VOL 控制桿調節音量。
- 取消 ATT 功能。
- 將雙路揚聲器系統的衰減控制設定在中心位置。

記憶內容已被消除。

- 已按下復原按鈕。
→再將設定存入記憶中。
- 電源線或電池已被斷開。
- 電源連接導線未被正確連接。

無提示音。

提示音功能被取消（第 30 頁）。

顯示從顯示窗口消失或不出現在顯示窗口中。

- 如果按住 (OFF) 按鈕，顯示消失。
→再次按住 (OFF) 直至出現顯示。

儲存之電台及正確走時被消除。

保險絲已熔斷。

點火鑰匙處於 ON、ACC 或 OFF 位置時，裝置會產生噪聲。

導線與汽車附件電源連接器未正確匹配。

裝置無供電。

- 檢查電源的連接。若一切正常，則請檢查保險絲。
- 汽車不具有 ACC 位置。
→按 (SOURCE) 開啓本機。

本機始終處於通電狀態。

汽車不具有 ACC 位置。

- 關閉發動機後，必須按住本機上的 (OFF) 不放，直至顯示消失。

電動伸縮天線未伸出。

電動伸縮天線未裝繼電器。

CD/MD 播放

無法開始播放。

- MD 有缺陷或 CD 髒了。
- 由於錄製裝置或光碟狀況的原因，有些 CD-Rs/CD-RWs 可能無法播放。

無法播放 MP3 檔案。

- 未依照 ISO 9660 level 1 或 level 2 格式，或擴展格式中的 Joliet 或 Romeo 進行錄製。
- 未將檔案擴展名 “.MP3” 加入檔案名稱。
- 檔案未以 MP3 格式保存。

未正確顯示樂曲集名稱 / 樂曲名稱 / ID3 標籤。

- 光碟不符合 ISO 9660 level 1。
→請使用符合的光碟。
- 本機只能顯示字母代碼，如 ASCII、半形歐洲字母 (ASCII 僅適用於 Joliet) 和 Shift-JIS。除上述之外的字母代碼則無法正確顯示。

MP3 檔案的開始播放時間較其他檔案長。

以下光碟要花費較長時間才能開始播放。

- 以複雜的樹形架構錄製的光碟。
- 以 Multi Session 錄製的光碟。
- 能增加資料的光碟。

聲音顫動產生跳音。

- 本機安裝角度大於 60。
- 本機未安裝在汽車上較堅固的位置。

跳音。

- 光碟有缺陷或髒了。
- CD-R/CD-RW 被損壞。

續下頁 →

無線電接收

不能預設調諧。

- 將正確的頻率存儲在記憶體內。
- 廣播訊號太弱。

無法接收電台。

有噪音干擾。

- 請連接電動天線控制導線（藍色）或附件電源導線（紅色）至汽車天線升壓器的電源導線。（只有當您的汽車僅在後/側玻璃內有內置 FM/MW/LW 天線時。）
- 檢查汽車天線的連接。
- 自動天線不能上升。
→ 檢查電動天線控制導線的連接。
- 檢查頻率。
- DSO 模式開啓時，聲音有時會受到噪音的影響。
→ 將 DSO 模式設定為“OFF”（第 31 頁）。

不能自動調諧。

- 本地搜尋模式設定在“ON”。
→ 將本地搜尋模式設定在“OFF”（第 30 頁）。
- 廣播訊號太弱。
→ 進行手動調諧。

“STEREO”指示閃爍。

- 精確地調諧電台頻率。
- 廣播訊號太弱。
→ 設定至單聲道接收模式（第 30 頁）。

收聽到的立體聲廣播節目是單聲道。

- 本機處在單聲道接收模式。
→ 取消單聲道接收模式（第 30 頁）。

RDS

收聽幾秒鐘後開始搜索。

- 該電台為非 TP 電台或訊號微弱。
→ 反覆按 (AF) 或 (TA) 按鈕直至
“AF”或“TA”消失。

無交通通告。

- 開啓 TA 功能。
- 該電台儘管為 TP 電台但不廣播交通通告。
→ 調入另一個電台。

PTY 顯示為“-----”。

- 當前電台為非 RDS 電台。
- 未接收 RDS 資料。
- 該電台未指定節目類型。

出錯顯示 / 訊息

出錯顯示

（用於本機和選購的 CD/MD 換碟機）

下述指示將閃爍 5 秒鐘左右，隨之將聽到警告聲。

Blank *1

- MD *2 上沒有錄製樂曲。
→ 播放錄製有樂曲的 MD。

Error *1

- CD 髒了或 CD 上下裝反了。*2
→ 將 CD 擦拭乾淨或正確地裝入 CD。
- 由於某些原因，CD/MD 不能播放。*2
→ 裝入另一張 CD/MD。

High Temp

- 環境溫度高於 50°C。
→ 等待本機溫度低於 50°C。

NO Disc

- CD/MD 裝置中未裝入光碟。
→ 將光碟裝入 CD/MD 裝置。

NO Magazine

- 光碟匣未裝入 CD/MD 裝置。
→ 將光碟匣裝入 CD/MD 裝置。

NO Music*1

- 插入了不包含音樂檔案的 CD。
→ 插入音樂 CD。

Not Ready

- MD 裝置的蓋子被打開或 MD 未被正確地裝入。
→ 關上蓋子或正確地裝入 MD。

Push Reset

- 因某些原因 CD/MD 裝置不能工作。
→ 按下本機的復原按鈕。

*1 當 CD/MD 換碟機與本機連接時，CD 或 MD 的光碟號碼出現在顯示幕上。

*2 造成錯誤的光碟號碼出現在顯示幕上。

如果這些解答仍無法助您改善情況，請向距您最近的 Sony 經銷商諮詢。12

訊息

Local Seek up/Local Seek down

- 在自動調諧時，Local Seek 模式為開啓狀態（第 16 頁）。

關於 ID3 標籤版本 2

播放含有 ID3 標籤版本 2 的 MP3 檔案時會發生以下情況，但這都不是故障：

- 當正在跳過 ID3 標籤版本 2 一個部分時（位於樂曲的開頭）沒有聲音輸出。
 - 跳躍時間視 ID3 版本 2 容量將發生變化。
 - 當正在跳過 ID3 標籤版本 2 的一個部分時所顯示的已播放時間不是準確的時間。
- 對於除 128kbps 比特速率之外的 MP3 檔案，當播放時，其時間不能準確顯示。
- 當 MP3 檔案是由 MP3 轉換軟體所建立，ID3 標籤版本 2 將被自動寫入。

<http://www.sony.net/>

Sony Corporation Printed in Korea

Printed on recycled paper

Download from [Www.Somanuals.com](http://www.Somanuals.com). All Manuals Search And Download.

Free Manuals Download Website

<http://myh66.com>

<http://usermanuals.us>

<http://www.somanuals.com>

<http://www.4manuals.cc>

<http://www.manual-lib.com>

<http://www.404manual.com>

<http://www.luxmanual.com>

<http://aubethermostatmanual.com>

Golf course search by state

<http://golfingnear.com>

Email search by domain

<http://emailbydomain.com>

Auto manuals search

<http://auto.somanuals.com>

TV manuals search

<http://tv.somanuals.com>