

Read This First

Personal Entertainment Organizer

CLiÉ

PEG-T615C/PEG-T415

Chapter 1

What is the Sony
CLiÉ Handheld?

Chapter 2

Setting up your Sony
CLiÉ Handheld
– Basics

Chapter 3

Setting up your Sony
CLiÉ Handheld
– Advanced

WARNING

To prevent fire or shock hazard, do not expose the unit to rain or moisture. To avoid electrical shock, do not open the cabinet. Refer servicing to qualified personnel only.

For customers in the U.S.A and Canada

Owner's Record

The model number and serial number are located at the rear of the product. Record the model number and the serial number in the space provided below. Refer to them whenever you call upon your Sony dealer regarding this product.

Model No. _____
Serial No. _____

The socket-outlet shall be installed near the equipment and shall be easily accessible.

CAUTION

You are cautioned that any changes or modifications not expressly approved in this manual could void your authority to operate this equipment.

This Class B digital apparatus complies with Canadian ICES-003.

Cet appareil numérique de la classe B est conforme à la norme NMB-003 du Canada.

NOTE

This equipment has been tested and found to comply with the limits for a Class B digital device, pursuant to Part 15 of the FCC Rules. These limits are designed to provide reasonable protection against harmful interference in a residential installation. This equipment generates, uses, and can radiate radio frequency energy and, if not installed and used in accordance with the instructions, may cause harmful interference to radio communications.

However, there is no guarantee that interference will not occur in a particular installation. If this equipment does cause harmful interference to radio or television reception, which can be determined by rotating the equipment off and on, the user is encouraged to try to correct the interference using one or more of the following measures:

- Reorient or relocate the receiving antenna.
- Increase the separation between the equipment and receiver.
- Connect the equipment into an outlet on a circuit different from that to which the receiver is connected.
- Consult the dealer or an experienced radio/TV technician for help.

If you have a question about this product, call the Sony Customer Information Center at keep on next line 1-877-760-7669; or write to the Sony Customer Information Center at 12451 Gateway Boulevard, Fort Myers, FL 33913. The number below is for FCC-related matters only.

Declaration of Conformity

Trade Name: SONY

Model No.: PEG-T615C

PEG-T415

Responsible Party: Sony Electronics Inc.

Address: 680 Kinderkamack Road,
Oradell, NJ 07649 USA

Telephone No.: 201-930-6972

This device complies with part 15 of the FCC Rules.

Operation is subject to the following two conditions:

- (1) This device may not cause harmful interference, and
- (2) This device must accept any interference received, including interference that may cause undesired operation.

The supplied interface cable must be used with the equipment in order to comply with the limits for a digital device pursuant to Subpart B of Part 15 of FCC Rules.

On the supplied software

- Copyright laws prohibit reproducing the software or the software manual in whole or in part, or renting the software without the permission of the copyright holder.
- In no event will SONY be liable for any financial damage or loss of profits, including claims made by third parties, arising out of the use of the software supplied with this player.
- In the event a problem occurs with this software as a result of defective manufacturing, SONY will replace it at SONY's option or issue a refund. However, SONY bears no other responsibility.
- The software provided with this product cannot be used with equipment other than that which it is designated for use with.
- Please note that, due to continued efforts to improve quality, the software specifications may be changed without notice.

Program © 2001 Sony Corporation, © 2001 Palm, Inc. or its subsidiaries. All rights reserved.

Documentation © 2001 Sony Corporation

CAUTION

Please contact your nearest Sony dealer regarding the problem you are experiencing with your Sony product.

Notes

- Sony does not support third-party add-on applications. If you are having a problem with a third-party application, please contact the developer or publisher of that software.
- The illustrations in this manual may differ from the actual software.
- Explanations in this manual assume that you are familiar with basic operations of Windows®. For how to use your computer and operating system, please refer to their respective manuals.

Before using your CLIE handheld, be sure to read the accompanying End-User's License Agreement.

Sony, Memory Stick, the Memory Stick logo, Jog Dial, and PictureGear are trademarks of Sony Corporation.

Graffiti, HotSync, and Palm OS are registered trademarks, and the HotSync logo and Palm are trademarks of Palm, Inc. or its subsidiaries.

IBM and PC/AT are registered trademarks of International Business Machines Corporation.

Microsoft, Windows, Windows NT, Outlook, DirectX and the Windows 98 logo are registered trademarks of Microsoft Corporation.

MMX and Pentium are registered trademarks of Intel Corporation.

AvantGo, the AvantGo Client and the AvantGo logo are registered trademarks of AvantGo, Inc.

Pumatech, the Pumatech logo, Intellisync and Intellisync Lite are trademarks of Pumatech, Inc. that may be registered in some jurisdictions.

Adobe and Adobe Acrobat Reader are trademarks of Adobe Systems Incorporated.

QuickTime and the QuickTime logo are trademarks used under license. QuickTime is registered in the U.S. and other countries.

This product includes fonts owned by TypeBank Co., Ltd. under license.

All other trademarks are trademarks of their respective owners.

Sample movies and music: cocoro.prc
(from DVD Hawaiian Breeze - KOHALA Collection (CCBN-27013))

Music: Mango Cooler (Composed by Charles Michael Brotman. Performed by KOHALA)

Copyright © 2001 cocoronetworks, inc.

Copyright © 1998, 2001 Palm Records, Inc.

All rights reserved.

<http://www.cocoronet.com/en/>

Table of Contents

About this manual	5
Which manual to read?	7

Chapter 1

What is the Sony CLIÉ Handheld?	
What can you do with your Sony CLIÉ Handheld?	10
System requirements	11
Sony CLIÉ Handheld components ..	12
Locating front panel controls	12
Locating back panel components	14
Locating cradle components	17
Elements of the CLIÉ interface	18
What is on the CLIÉ Installation CD-ROM?	20
CD-ROM contents	20
How to read the PDF manuals on the CD-ROM	21

Chapter 2

Setting up your Sony CLIÉ Handheld – Basics	
Step 1: Charging your Sony CLIÉ Handheld	24
Step 2: Turning on your Sony CLIÉ Handheld for the first time	25
Step 3: Entering data into your Sony CLIÉ Handheld	29
Step 4: Installing the Palm™ Desktop for CLIÉ software on your computer	31
Step 5: Connecting your Sony CLIÉ Handheld and your computer via the cradle	35
Step 6: Performing a HotSync® operation for the first time	36

Chapter 3

Setting up your Sony CLIÉ Handheld – Advanced	
Checking the bundled applications on your Sony CLIÉ Handheld	40
Overview of basic Palm OS® applications	41
Overview of Sony applications	44
Installing the supplied applications on your computer	48
Installing PictureGear™ 4.4Lite	48
Installing QuickTime® 5	48
Installing DirectX® 6	49
Installing Memory Stick Export	49
Installing Sound Converter	50
Installing AvantGo® and other third-party applications	50
Installing Acrobat Reader® 5.0	51
Uninstalling the supplied applications	52
Installing add-on applications on your Sony CLIÉ Handheld or Memory Stick media	53
Installing add-on applications from the Palm™ Desktop for CLIÉ software	54
Installing add-on applications by beaming them from another Palm OS® device	57
Installing add-on applications directly from the Installation CD-ROM menu	59
Removing add-on applications	60
Customer registration	61

About this manual

Welcome to the Sony Personal Entertainment Organizer (referred to as the “CLIÉ handheld” or “Sony CLIÉ Handheld” in this manual).

Your CLIÉ handheld comes with three manuals:

- Read This First (this guide)
- Operating Instructions (as a PDF file contained in the CD-ROM)
- Add-on Application Guide

Before using your CLIÉ handheld, read this guide for an overview of features, setup and installation instructions, and other important details.

After you set up your CLIÉ handheld and become familiar with its basic functions, you can use the other two manuals (Operating Instructions and Add-on Application Guide) as references for detailed features, less common tasks, and maintenance of your CLIÉ handheld. These manuals can also serve as a source of information if you have problems operating your CLIÉ handheld.

The contents of the three manuals are as follows.

Read This First (this guide)

This guide is designed to help you quickly get your CLIÉ handheld up and running.

This guide shows you how to:

- Identify all the parts of your CLIÉ handheld
- Set up your CLIÉ handheld
- Install supplied applications on your CLIÉ handheld and your computer
- View and enter data

Continued on next page

About this manual

Operating Instructions

The Operating Instructions manual is contained in the supplied CD-ROM as a PDF file; you can view or print the file as necessary.

The manual describes how to use your CLIÉ handheld and the Personal Information Management (PIM) applications that come with your CLIÉ handheld.

Additionally, the manual shows you how to:

- View and enter data in greater detail
- Use your CLIÉ handheld with your computer
- Use Personal Information Management applications (Date Book, Address Book, To Do List, Memo Pad, and Calculator)
- Personalize your CLIÉ handheld with your own preference settings
- Maintain your CLIÉ handheld

Add-on Application Guide

The Add-on Application Guide describes how to install and use the supplied add-on applications, including:

- PictureGear™ Pocket/PhotoStand/CLIÉ Paint/PictureGear 4.4Lite
- gMovie™
- World Alarm Clock
- CLIÉ Remote Commander
- Sound Utility/Sound Converter
- MS Autorun
- MS Import/Export

The three manuals all describe operations of two models of the CLIÉ handheld (PEG-T615C and PEG-T415). All illustrations of the unit are of PEG-T415, unless specified otherwise. Points of difference between the two models are described in their relative sections.

Which manual to read?

After you set up your CLIÉ handheld and become familiar with its basic functions, you can refer to the rest of the manuals as follows:

When you want to:		Read:
Manage your personal information using your CLIÉ applications.	→	Operating Instructions Chapter 2 Using basic applications
Use your CLIÉ handheld and your computer in synchronization.	→	Operating Instructions Chapter 3 Exchanging and updating data using a HotSync® operation
Exchange and share information with other handheld users.	→	Operating Instructions Chapter 4 Communicating using your Sony CLIÉ Handheld
Enjoy viewing images on your CLIÉ handheld.	→	Add-on Application Guide Chapter 1 Viewing image files (PictureGear Pocket)
Enjoy drawing on image files on your CLIÉ handheld.	→	Add-on Application Guide Chapter 2 Drawing on image files (CLIÉ Paint)
Enjoy watching movies on your CLIÉ handheld.	→	Add-on Application Guide Chapter 3 Playing a movie (gMovie player)
View the World Alarm Clock on your CLIÉ handheld.	→	Add-on Application Guide Chapter 4 Viewing the World Alarm Clock (World Alarm Clock)
Use your CLIÉ handheld as a remote commander.	→	Add-on Application Guide Chapter 5 Using your CLIÉ handheld as a remote commander (CLIÉ Remote Commander)
Import your favorite sound from your computer to your CLIÉ handheld.	→	Add-on Application Guide Chapter 6 Importing your favorite sounds (Sound Utility/Sound Converter)

Chapter 1

What is the Sony CLIÉ Handheld?

This chapter describes the features of your CLIÉ handheld, its system requirements, its buttons and controls, and the contents of the Installation CD-ROM.

Contents

What can you do with your Sony CLIÉ Handheld?	10
System requirements	11
Sony CLIÉ Handheld components	12
Locating front panel controls	12
Locating back panel components	14
Locating cradle components	17
Elements of the CLIÉ interface	18
What is on the CLIÉ Installation CD-ROM?	20
CD-ROM contents	20
How to read the PDF manuals on the CD-ROM	21

What can you do with your Sony CLIÉ Handheld?

Your CLIÉ handheld can help you remember appointments and meeting times, people's names and personal details, and items on your To Do List. Your CLIÉ handheld can also help you improve your track record in all these areas, both at work and at home.

Once you familiarize yourself with the basic workings of your CLIÉ handheld, you'll easily be able to:

- Enter all your schedule details in the Date Book and view them by the day, week, or month, and even set an alarm to remind you of an important event.
- Keep all your contact names, addresses, phone numbers, and other details in the Address Book. In addition, you can paste an image to an address record using the supplied PictureGear™ Pocket application.
- Add your tasks to the To Do List, prioritize them, and assign them a due date.
- Synchronize your data with the Palm™ Desktop for CLIÉ software on your computer so you always have a backup copy of your important information.
- Customize your CLIÉ handheld and set different levels of security to prevent unauthorized users from viewing your data.
- Exchange data with your computer, other Sony CLIÉ handhelds, digital cameras, or other portable devices with Sony's Memory Stick™ media.
- Play back image files with the PictureGear™ Pocket application on your CLIÉ handheld or with the PictureGear™ Lite software on your computer.
- Watch a movie with the gMovie™ application on your CLIÉ handheld.
- Use other add-on applications for the Palm OS®.
- Enjoy Web Clipping*.

* Web Clipping is a system provided by Palm, Inc. and its subsidiaries for Palm OS handhelds, which enables easy access to information provided on the Web. If you install various Web Clipping applications on your CLIÉ handheld, you can retrieve specific information such as news, weather, or restaurant guides to display them on your CLIÉ handheld. Web clipping applications require Internet connections. For details on its use, or for answers to your questions, refer to the following homepage:
<http://www.palm.com/wireless/>

System requirements

To install and operate the Palm™ Desktop software on your computer, your computer system must meet the following requirements:

- OS: Microsoft® Windows® 98/Windows® 98 Second Edition/Windows® 2000 Professional/Windows® Millennium Edition/Windows® XP
- CPU: Pentium® processor 133MHz or more
- RAM: 32MB or more (64MB or more recommended)
- Hard disk drive: 128MB or more available space
- Display: High Color or more (800 × 600 pixels or more)
- CD-ROM drive
- Mouse or similar pointing device
- One available USB connector

Notes

- To install the Palm Desktop for CLIÉ software on Windows® 2000 Professional, log on as “Administrator.”
- Macintosh computers are not compatible with the Sony CLIÉ Handheld.

Sony CLIE™ Handheld components

Locating front panel controls

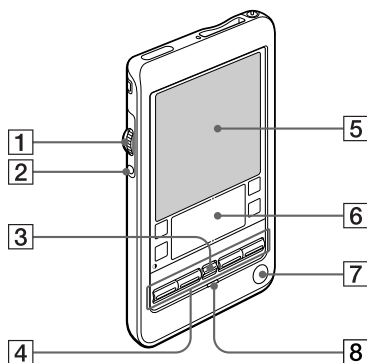

1 Jog Dial™ Navigator

Used to select and run applications or items. Depending on the application you use, specific functions are assigned to the navigator. For details, see “Using the Jog Dial™ navigator” in the Operating Instructions manual.

2 BACK Button

Releases the selection of an item or cancels the operation. Depending on the application you use, returning to the previous screen or other specific functions are assigned to this button.

3 Scroll Button

Displays text and other information that extends beyond the area of the screen. Pushing the scroll button downwards scrolls down to display information below the current viewing area, and pushing up the button scrolls up to display the information above the current viewing area. Depending on the application you use, specific functions are assigned to the scroll button.

4 Application Buttons

Activates the individual applications that correspond to the icons on the buttons: ☺≡ Date Book, ☎ Address Book, ☰ To Do List, and ✍ Memo Pad. See “Assigning applications to buttons” in the Operating Instructions manual for details on reassigning these buttons to activate any application on your CLIE handheld.

5 Screen

Displays the applications and information stored in your CLIE handheld. It is touch-sensitive and responds to the stylus. For details, see “Elements of the CLIE interface” on page 18.

6 Graffiti Writing Area

The area where you write letters and numbers using the Graffiti® alphabet. See “Using Graffiti® writing to enter data” in the Operating Instructions manual to learn how to write Graffiti characters.

7 POWER Button

Used to turn your CLIE handheld on or off. Also, press the POWER button and hold it down for two seconds or longer to turn the backlight of the LCD display on or off.

Tip

If your CLIE handheld is turned off, pressing any application button activates your CLIE handheld and opens the corresponding application.

8 LED indicator

Flashes to notify you at a given time if you set an alarm in Date Book or the World Alarm Clock application. Also lights while charging the battery, and turns off when charging is complete.

Sony CLIÉ Handheld components

Locating back panel components

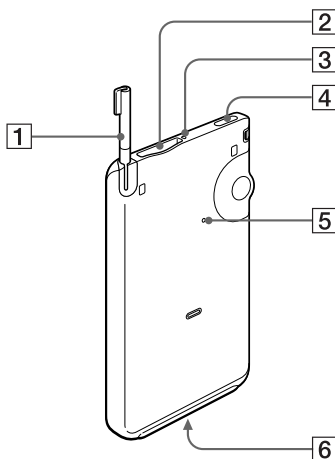

1 Stylus

Used to tap icons and buttons on the screen, or to write characters on the Graffiti writing area.

For details, see “Using the stylus” in the Operating Instructions manual.

2 Memory Stick™ Slot

Insert Memory Stick media into this slot.

3 Memory Stick Access Indicator

Lights in orange while your CLIÉ handheld is reading/writing the data in Memory Stick media.

4 Infrared Communication Port (IR port)

Uses infrared technology to:

- transmit data to and receive data from other CLIÉ or Palm OS® handhelds, and to perform HotSync® operations.

For details, see “Beaming between your Sony CLIÉ Handheld and another Palm OS® PDA” in the Operating Instructions manual.

- remote-control devices with the CLIE Remote Commander application. For details, see chapter 4 in the Add-on Application Guide.

5 Reset Button

Under normal use, you should not have to use this button. For details, see “Resetting your Sony CLIE Handheld” in the Operating Instructions manual.

6 Interface Connector

Used to connect your CLIE handheld to the cradle or to the accessories for the CLIE handheld (not supplied).

Sony CLIÉ Handheld components

Removing the supplied protective soft cover from your CLIÉ handheld

Slide both switches on the attached end of the cover towards the center (①), then remove the cover (②).

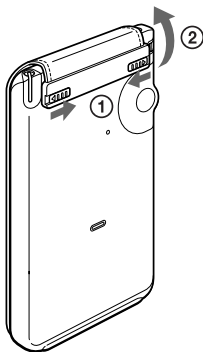

Reattaching the protective soft cover

Slide the switches towards the center (①) and place the tabs into the holes of the CLIÉ handheld (②). Then slide the switches outwards until they lock into place.

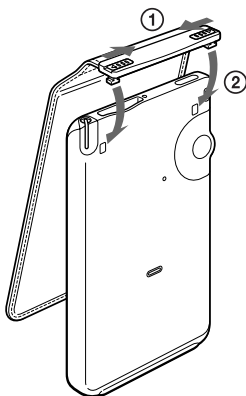

Locating cradle components

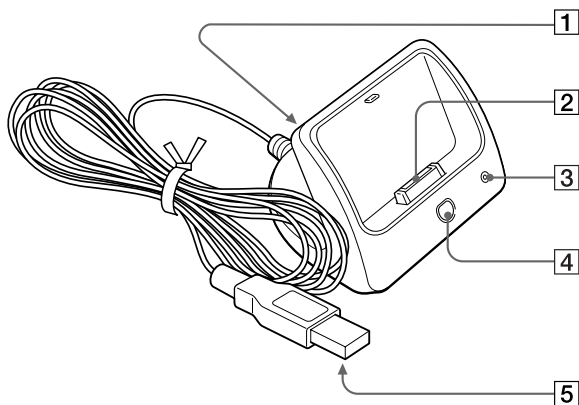

1 AC Adapter Connector

Connect the supplied AC adapter here.

2 Interface Connector

Connect your CLIÉ handheld here.

3 Cradle Indicator

When you connect the cradle to the AC adapter and place your CLIÉ handheld on the cradle, the green indicator lights and charging starts.

4 HotSync® Button

Synchronizes data in your CLIÉ handheld with the data saved on your computer.

For details, see “Exchanging and updating data using a HotSync® operation” in the Operating Instructions manual.

5 USB Connector

Connects to your computer’s USB port.

Sony CLIÉ Handheld components

Elements of the CLIÉ interface

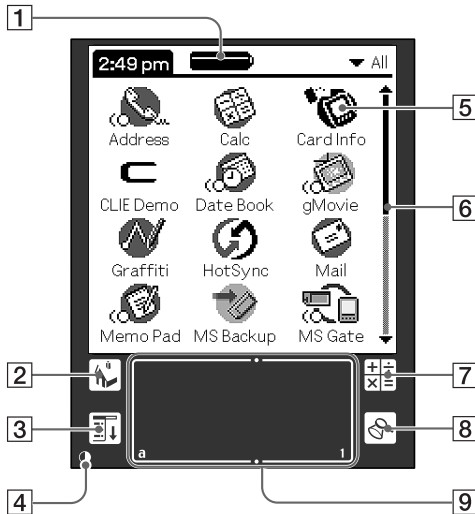

1 Battery Icon

Displays the remaining charge in the battery. While your CLIÉ handheld is placed in the cradle or operates on the AC power source, the battery charging icon (🔌) is displayed. Tapping the icon shows the amount of the battery's remaining charge by percentage, and free memory space.

2 Home Icon

Tap this icon and the Application Launcher screen appears, displaying a list of applications.

3 Menu Icon

Tap this icon and a menu of current applications appears.

4 Brightness/Contrast Adjustment Icon

Tap this icon to display the window used for adjusting the brightness level (PEG-T615C) or the contrast level (PEG-T415) of the LCD screen of your CLIÉ handheld.

Note

If the digitizer preferences are not set correctly, you cannot adjust the brightness/contrast level properly. For details, see “Adjusting the screen” in the Operating Instructions manual.

5 Application Icon

Tap an icon to activate the corresponding application.

6 Scroll Bar

Drag the slider up or down or tap the scroll arrows ▲ or ▼ on the ends of the bar to scroll the screen.

7 Calculator Icon

Tap this icon to display the onscreen Calculator.

8 Find Icon

Tap this icon to open the Find screen.

9 Graffiti Writing Area

This area is for hand-writing input with the Graffiti alphabet.

Tip

When the tip ⓘ icon is displayed, you can tap the icon to display online operational tips on the screen.

**Note on display resolutions**

Your CLIE handheld uses original technology to provide a 320 × 320 dot high resolution display. When you start an application supporting the high resolution, the screen switches automatically to the high resolution mode. When you start an application that does not support high resolution, the screen returns to the standard 160 × 160 dot resolution mode.

Note

In some third-party applications, the screen may not be displayed properly.

What is on the CLIÉ Installation CD-ROM?

CD-ROM contents

The Installation CD-ROM that comes with your CLIÉ handheld contains the following applications and manuals:

■ PC applications

You can install the following PC applications and related online help files from the installer's main launcher window:

- Palm Desktop for CLIÉ 4.0.1
(including Intellisync Lite 4.0)
- PictureGear™ 4.4Lite
- QuickTime® 5
- DirectX® 6
- Memory Stick™ Export
- Sound Converter

The following PC application has a separate installer package:

- Adobe Acrobat Reader® 5.0

■ Palm OS applications

You can install the following Palm OS® applications on your CLIÉ handheld:

- CLIÉ Paint
- World Alarm Clock
- CLIÉ Remote Commander
- Sound Utility

The following sample data and demonstration files are also available:

- CLIÉ Demo
- Sample data for gMovie and PictureGear Pocket
- Sample sound data

■ Manuals

The following manuals are available as PDF files on the CD-ROM:

- Read This First (this guide)
- Operating Instructions
- Add-on Application Guide
- PictureGear Pocket Manual
- CLIÉ Paint Manual
- gMovie Manual
- World Alarm Clock Manual
- CLIÉ Remote Commander Manual
- MS Gate Manual
- MSAutorun Manual
- MS Import Export Manual
- IntelliSync Lite Manual

Tip

You can view the manuals by clicking Manuals in the installation launcher window that appears when you insert the CLIÉ Installation CD-ROM into your computer.

How to read the PDF manuals on the CD-ROM

To view the PDF manuals contained on the Installation CD-ROM, you need the Acrobat Reader software installed on your computer. To install the Acrobat Reader software, see “Installing Acrobat Reader® 5.0” on page 51.

To open a PDF manual, do either of the following:

- Double-click a PDF file on the CD-ROM.
The Acrobat Reader software starts and the selected PDF manual is displayed. You can read and print the file.
- Start the Acrobat Reader software and select Open from the File menu. In the Open dialog box, select a PDF file and click Open.
The selected PDF manual is displayed. You can read and print the file.

Chapter 2

Setting up your Sony CLIÉ Handheld – Basics

This chapter describes basic hardware setup procedures that you should perform, before you start using your CLIÉ handheld in combination with your computer. These procedures include: charging your CLIÉ handheld with the cradle, synchronizing data with your computer, and entering data.

Contents

Step 1: Charging your Sony CLIÉ Handheld	24
Step 2: Turning on your Sony CLIÉ Handheld for the first time ..	25
Step 3: Entering data into your Sony CLIÉ Handheld	29
Step 4: Installing the Palm™ Desktop for CLIÉ software on your computer	31
Step 5: Connecting your Sony CLIÉ Handheld and your computer via the cradle	35
Step 6: Performing a HotSync® operation for the first time	36

Step 1: Charging your Sony CLIÉ Handheld

Note

Before you use your CLIÉ handheld for the first time, make sure to charge it.

Connect the supplied cradle to an AC power source in advance. Charging will start as soon as you place your CLIÉ handheld on the cradle. The battery icon in the screen changes to the battery charging icon ().

It takes about four hours for your CLIÉ handheld to be fully charged for the first time. Subsequent charges, if your CLIÉ handheld is charged frequently, will require less time.

To the wall outlet

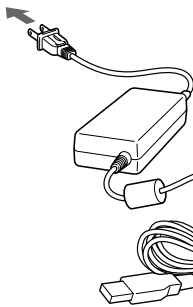

Insert your CLIÉ handheld at an angle to the cradle and lay it back to fit into place.

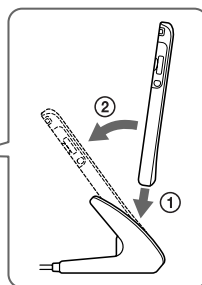

When you place your CLIÉ handheld on the cradle, the cradle indicator and the LED indicator of your CLIÉ handheld turns on, and charging starts.

When charging is completed

The LED indicator of your CLIÉ handheld turns off. When you remove your CLIÉ handheld from the cradle, the battery charging icon changes to the battery icon ().

The cradle indicator remains on even after charging is completed.

Note

If the battery in your CLIÉ handheld is fully discharged, all data stored on the DRAM (memory) is lost. Performing another HotSync[®] operation once the battery is recharged can restore information saved from the last HotSync operation.

Step 2: Turning on your Sony CLIE Handheld for the first time

The first time you start your CLIE handheld, setup instructions appear onscreen. Follow the onscreen instructions to perform initial settings, digitizer calibration, current time, date, and year settings (required for operation).

1 Press the POWER button.

Your CLIE handheld turns on, and the Welcome screen appears.

After a while, the Setup screen appears.

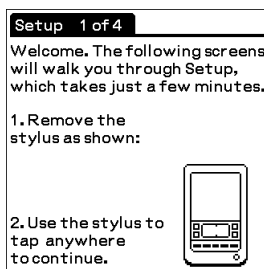
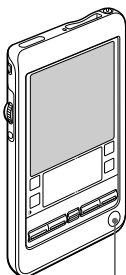

Press the POWER button.

2 Take out the Stylus.

You can use the stylus to tap or drag on the screen to open applications, choose options or menu commands, and select text or move objects just as you do with a mouse on your computer.

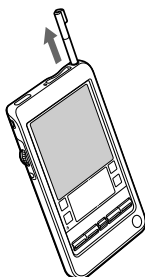

Note

Always use the point of the stylus for tapping or making strokes on the handheld screen. Never use a real pen, pencil, or other sharp object to write on the screen.

Continued on next page

Step 2: Turning on your Sony CLIÉ Handheld for the first time

3 Press lightly on the screen with the stylus.

This action is called “tapping.”

The digitizer calibration screen appears. Calibration aligns the internal circuitry of the handheld with its touch-sensitive screen so your CLIÉ handheld can detect the task you want to perform when you tap an element on the screen.

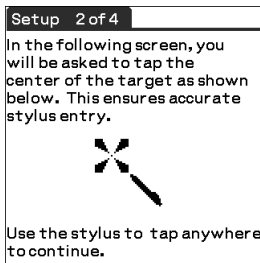

4 Tap anywhere on the screen.

The following screen is displayed.

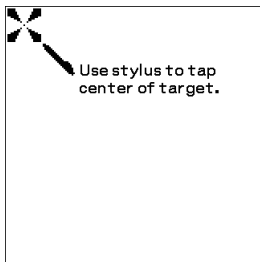

5 Following the onscreen instruction, tap the center of the displayed mark.

Note

If the digitizer is not configured correctly, the scroll bar may not operate properly, “tapping” may not work as expected, or other problems may occur. If this happens, please re-configure the digitizer manually. You can also re-configure the digitizer in the Digitizer Preferences screen. For details, see “What you can do with Preferences” in the Operating Instructions manual.

After calibration completes, a screen for setting time and date appears.

Setup 3 of 4

1. Tap arrows and boxes to change settings.

Region: ▼ United States
 Time Zone: USA (Pacific)

Daylight Saving: ▼ Off

Set Date: 7/21/01
 Set Time: 12:47 pm

2. Tap Next to continue.

Previous Next

- 6** Tap the Set Date box.
 The Set Date screen appears.

Set Date

◀ 2001 ▶

Jan	Feb	Mar	Apr	May	Jun	
Jul	Aug	Sep	Oct	Nov	Dec	
S	M	T	W	T	F	S
1	2	3	4	5	6	7
8	9	10	11	12	13	14
15	16	17	18	19	20	(21)
22	23	24	25	26	27	28
29	30	31				

Cancel Today

- 7** Tap the arrow ◀ or ▶ next to the year to select the current year.
- 8** Tap the current month, then tap the current date.
 The Set Date screen closes.
- 9** Tap the Set Time box.
 The Set Time screen appears.

Set Time

12 : 51 ◀ ▶ AM PM

OK Cancel

- 10** Tap the arrow ▲ or ▼ to set the hour to the current time.

Continued on next page

Step 2: Turning on your Sony CLIÉ Handheld for the first time

11 Tap each number of the minute, and then tap the arrow ▲ or ▼ to set the minutes to the current time.

12 Tap AM or PM.

13 Tap OK.

The Set Time screen closes.

14 Tap Next.

The Setup Complete screen appears.

15 Tap Next.

The Enter Data screen appears.



16 Tap Done.

The initial settings are complete, and the Application Launcher screen (Home screen) appears.

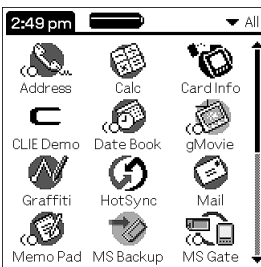

Your CLIÉ handheld is now ready for use!

Step 3: Entering data into your Sony CLIÉ Handheld

There are three ways to enter data into your CLIÉ handheld:

- Using Graffiti® writing
- Using the onscreen keyboard
- Using your computer keyboard

Graffiti writing

Your CLIÉ handheld includes Graffiti writing application as the primary system for entering text and numbers. With Graffiti writing, you write simple strokes with the stylus and they are instantly recognized as letters or numbers.

The Graffiti strokes closely resemble the upper case letters of the regular alphabet, which makes Graffiti writing easy to learn.



Graffiti writing examples:
A, B, C, D, and E

The Graffiti writing area is divided into two parts: one for writing the letters of the alphabet and one for writing numbers. The small marks at the top and bottom of the Graffiti writing area indicate the two areas.

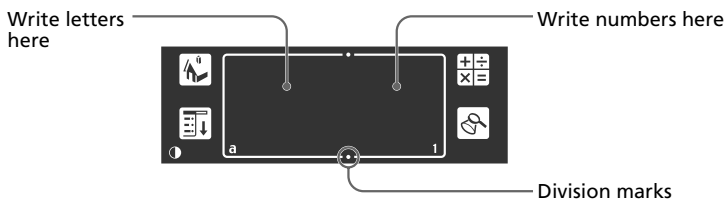

For details, see “Using Graffiti® writing to enter data” in the Operating Instructions manual.

Onscreen keyboard

When you use an application such as Date Book or Address Book, you can open the onscreen alphabetic and numeric keyboards to enter data.

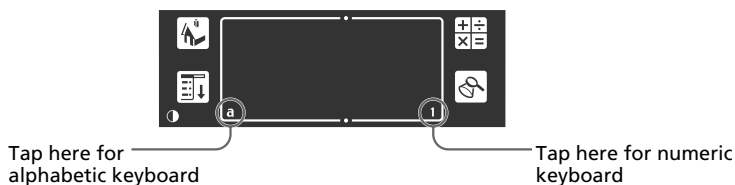

Step 3: Entering data into your Sony CLIÉ Handheld

After a keyboard is open, you can tap to open any of the other keyboards, including the international keyboard. For details, see “Using the onscreen keyboard” in the Operating Instructions manual.

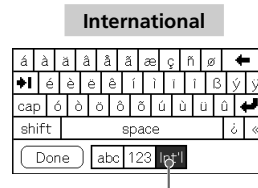
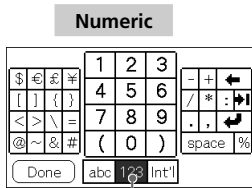
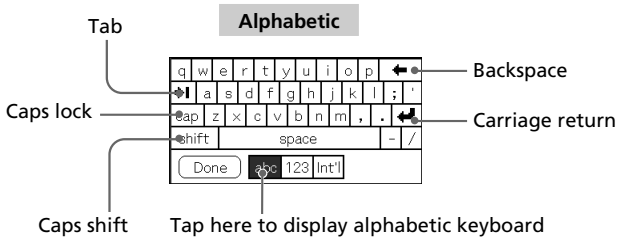

Computer keyboard

If you have a lot of data to enter, or prefer to use the computer keyboard, you can use the Palm™ Desktop for CLIÉ software or any supported PIM (Personal Information Management) applications to enter information. You can then perform a HotSync® operation to synchronize the information on your computer with the information on your CLIÉ handheld. All the main applications on your CLIÉ handheld are also available in the Palm Desktop for CLIÉ software and in most PIM applications, so you don't need to learn different applications.

Refer to the Palm Desktop for CLIÉ online Help for more information on entering data using your computer.

Step 4: Installing the Palm™ Desktop for CLIÉ software on your computer

The Palm™ Desktop for CLIÉ software extends many of the functions of your CLIÉ handheld to your computer, featuring the same main applications as those on your CLIÉ handheld: Address Book, Date Book, To Do List, Memo Pad, and desktop e-mail connectivity. You can use the HotSync® Manager feature of this software to back up and exchange data between your CLIÉ handheld and your computer.

Notes

- Do not connect the cradle to a USB connector of your computer before installing the Palm Desktop for CLIÉ software. The installation of the software might not be performed correctly.
- If you are already using a Sony CLIÉ Handheld (PEG-S300/S320/N610C/N710C) or other Palm™ OS PDA device, and Palm Desktop software is installed on your computer: uninstall it and reinstall the Palm Desktop for CLIÉ software using the supplied Installation CD-ROM. For details, see “Upgrading the existing Palm Desktop software” on page 34.
- The Palm Desktop for CLIÉ software supplied to this CLIÉ handheld (PEG-T615C/T415) does not support Expense.
- Do not simply copy the Palm Desktop for CLIÉ software files to your computer’s hard disk. You must use the installer and follow the procedures described in this section to place the files in their proper locations and to decompress the files.
- To introduce the CLIÉ data of your old CLIÉ handheld into the new one, see “Using data of another Sony CLIÉ Handheld” in the Operating Instructions manual.

1 Exit all applications running on Windows®.

You should quit all applications that automatically run at startup, such as fax communication software, anti-virus tools, screensavers, and the Microsoft® Office Shortcut Bar.

2 Insert the Installation CD-ROM into the CD-ROM drive of your computer.

The installation launcher window appears.

3 Select the model of your CLIÉ handheld (PEG-T615C or PEG-T415).

Continued on next page

Step 4: Installing the Palm™ Desktop for CLIÉ software on your computer

4 Click Install Palm Desktop for CLIÉ.

The setup program starts and the Welcome screen is displayed.

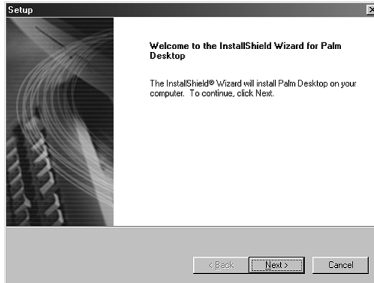

5 Click Next.

The Palm Desktop for CLIÉ 4.0.1 software installation begins.

Follow the onscreen instructions, then the following dialog box appears.

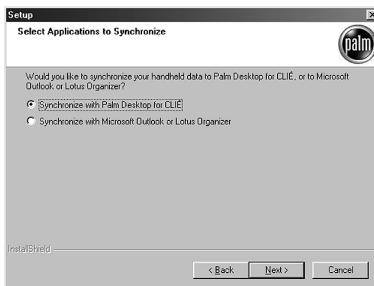

6 Select the software you will use to synchronize your CLIÉ handheld with your computer.

If you select "Synchronize with Palm Desktop for CLIÉ," Intellisync Lite will not be installed. If you select "Synchronize with Microsoft Outlook or Lotus Organizer," Palm Desktop and Intellisync Lite will be installed.

7 Click Next.

The Setup Type window is displayed.

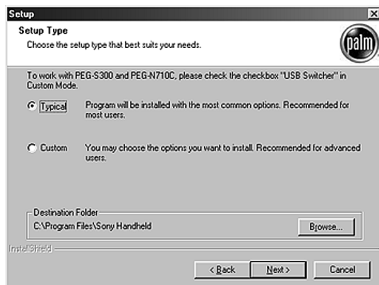

8 Select the setup type (Typical or Custom) and the destination folder.

If you wish to synchronize PEG-S300 or PEG-N710C with your CLIE handheld (PEG-T615C/T415), follow the steps below:

- ① Select Custom for the setup type and click Next.
- ② On the select components screen, make sure that USB Switcher is selected. For Windows® XP users, visit <http://www.sony.com/peg/support> for the latest driver information.
- ③ Follow the onscreen instructions until setup is complete.

When you follow the onscreen instructions, the Create User Account screen is displayed.

9 Fill in the user name in the Create User Account screen.

10 Click Next.

The Install Tool dialog box closes, then the Mail Setup dialog box appears.

11 Set up Mail.

Follow the onscreen instructions until Mail setup is complete.

Continued on next page

Step 4: Installing the Palm™ Desktop for CLIÉ software on your computer

12 Fill in the customer registration following the instructions shown onscreen.

You need Internet access for the online customer registration.

You can take advantage of Sony's commitment to quality customer support and nine months of the extended limited warranty for a total of 12 months from the original date of purchase when you register your CLIÉ handheld.

13 Click Finish.

Note

Make sure you perform a HotSync operation before installing any third-party applications. (See pages 35 - 37)

Upgrading the existing Palm Desktop software

Multiple versions of Palm Desktop software cannot be installed on one computer. If an older version of Palm Desktop for CLIÉ software already exists, it is recommended that you uninstall it prior to the new installation. All handheld user data is preserved when upgrading the Palm Desktop for CLIÉ software.

On Intellisync Lite

The Intellisync Lite software allows you to synchronize your Date Book, Address Book, To Do List, and Memo Pad data in your CLIÉ handheld with the data of a variety of popular Windows® applications including:

- Microsoft Outlook 97/98/2000/2002
- Lotus Organizer 5.0/6.0

During a HotSync operation, the Intellisync Lite software compares each record of information in your CLIÉ handheld to the information stored in the PIM (Personal Information Management) applications, and then makes necessary changes to both systems to make sure that they both contain the same data.

Step 5: Connecting your Sony CLIÉ Handheld and your computer via the cradle

The cradle that comes with your CLIÉ handheld enables you to synchronize the information on your CLIÉ handheld with the Palm™ Desktop for CLIÉ software on your computer using HotSync® technology.

- 1 Connect the USB connector of the cradle to a USB connector on your computer.

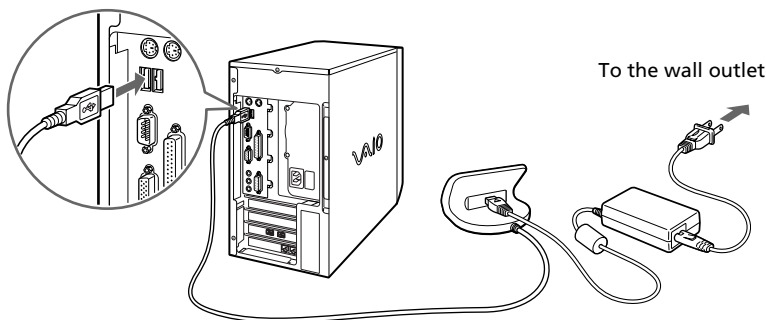

- 2 Place your CLIÉ handheld on the cradle.

Insert your CLIÉ handheld at an angle to the cradle and lay it back to fit it into place.

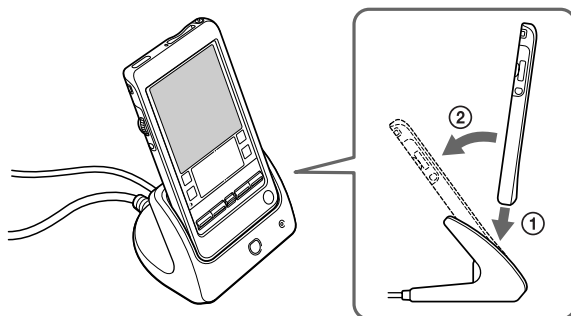

Step 6: Performing a HotSync® operation for the first time

What is a HotSync operation?

HotSync, which is a technology particular to a Palm OS® platform device, is the one-step operation that allows you to synchronize data between your CLIÉ handheld and your computer, and back up the CLIÉ data on your computer. For details, see “Exchanging and updating data using a HotSync® operation” in the Operating Instructions manual.

When performing a HotSync® operation for the first time, you have to enter your user information both into your CLIÉ handheld and into the Palm Desktop for CLIÉ software. After the user name is recognized, you do not have to enter the same information again.

- 1 Press the HotSync  button on the cradle.

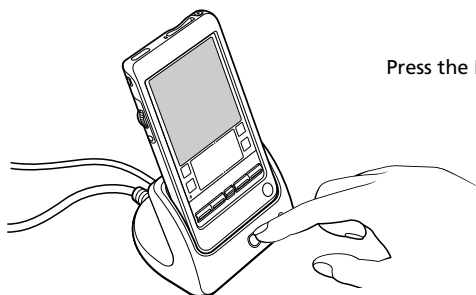

Press the HotSync button.

The USB Driver Installation Wizard starts automatically.

- 2 When the New User dialog box is displayed on your computer screen, select the user name.

Select the same user name you entered in step 8 on page 33.

Note

Every handheld should have a unique name. To prevent loss of a user's records, never try to synchronize more than one handheld to the same user name.



3 Click OK on your computer screen.

A beep sounds and the HotSync operation starts. When the HotSync process is complete, a message showing the HotSync operation completion is displayed on your CLIÉ handheld.

Notes

- Do not remove or move your CLIÉ handheld from the cradle during a HotSync operation.
- Do not push the HotSync button during a HotSync operation. It might cause errors and quitting of the operation.
- Do not enter power saving mode during a HotSync operation. If your computer enters power saving mode during a HotSync operation, the HotSync Manager will quit.

If the HotSync operation does not start

- Make sure that the HotSync  icon is displayed in the Windows task tray on your computer screen.
- If the HotSync  icon is not shown in the task tray, click Start, point to Programs (All Programs in Windows® XP), Sony Handheld, and then click HotSync Manager. Then click the HotSync button on your CLIÉ handheld to start the HotSync operation.

4 To open the Palm™ Desktop for CLIÉ software, double-click the Palm Desktop for CLIÉ icon on the Windows® desktop or click Start, point to Programs (All Programs in Windows® XP), Sony Handheld, and click Palm Desktop for CLIÉ.

The Palm Desktop for CLIÉ software starts. All the main applications on your CLIÉ handheld are also available in the Palm Desktop for CLIÉ software. You can synchronize the information on your computer with the information on your CLIÉ handheld.

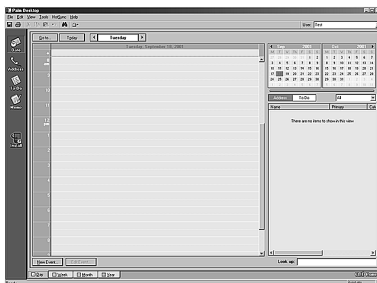

Chapter 3

Setting up your Sony CLIÉ Handheld – Advanced

This chapter describes advanced software setup procedures for your CLIÉ handheld and your computer. These procedures include: checking the bundled applications on your CLIÉ handheld, installing applications from the Installation CD-ROM on your computer, and installing add-on applications on your CLIÉ handheld.

Contents

Checking the bundled applications on your Sony CLIÉ Handheld	40
Overview of basic Palm OS® applications	41
Overview of Sony applications	44
Installing the supplied applications on your computer	48
Installing PictureGear™ 4.4Lite	48
Installing QuickTime® 5	48
Installing DirectX® 6	49
Installing Memory Stick Export	49
Installing Sound Converter	50
Installing AvantGo® and other third-party applications	50
Installing Acrobat Reader® 5.0	51
Uninstalling the supplied applications	52
Installing add-on applications on your Sony CLIÉ Handheld or Memory Stick media	53
Installing add-on applications from the Palm™ Desktop for CLIÉ software	54
Installing add-on applications by beaming them from another Palm OS® device	57
Installing add-on applications directly from the Installation CD-ROM menu	59
Removing add-on applications	60
Customer registration	61

Checking the bundled applications on your Sony CLIÉ Handheld

After you make your CLIÉ handheld ready for use, start the Application Launcher to display all the available applications on your CLIÉ handheld.

To open an application from the Application Launcher screen

- 1 Tap the Home  icon.

The Application Launcher screen appears.

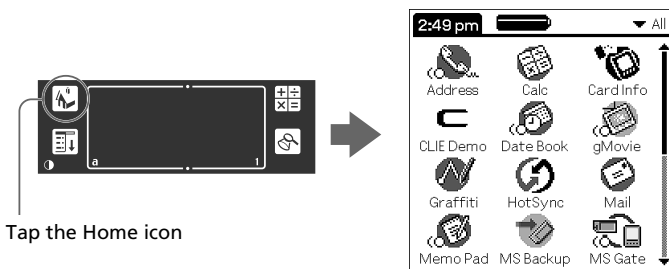

- 2 Do either of the following:

- Tap the desired application icon in the Application Launcher screen.
If you have many applications installed on your CLIÉ handheld, tap the scroll bar to see all the available applications.
- For the four main applications, you can press the application button on the front panel to display the selected application immediately:

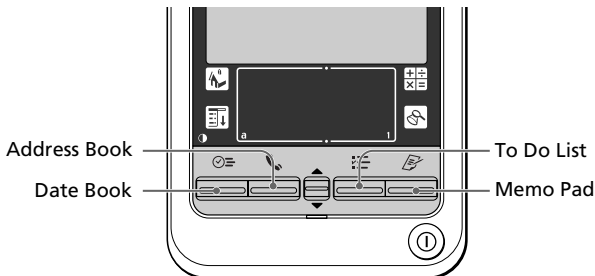

To quit the application and open another application

Tap the Home  icon (or press the BACK button repeatedly), and then perform step 2 to open the desired application. The next time you open the application, the last screen resumes.

Overview of basic Palm OS® applications

Your CLIE handheld comes with the following Palm OS basic applications: Date Book, Address Book, To Do List, Memo Pad, and Calculator applications. This section gives an overview of these basic applications.

Date Book



Date Book lets you quickly and easily schedule appointments or any kind of activity associated with a time and date.

In Date Book, you can do the following:

- Enter a description of your appointment and assign it to a specific time and date.
- Display a chart of your appointments for an entire week. The Week view makes it easy to spot available times and any potential scheduling overlaps or conflicts.
- Display a monthly calendar to quickly spot days where you have morning, lunch, or afternoon appointments.
- Set an alarm to sound prior to the scheduled activity.
- Create reminders for events that are based on a particular date, rather than time of day. Birthdays and anniversaries are easy to track with your CLIE handheld.
- Attach notes to individual events for a description or clarification of the entry in your Date Book.

Address Book



Address Book enables you to keep names, addresses, phone numbers, and other information about your personal or business contacts.

In Address Book, you can do the following:

- Quickly look up or enter names, addresses, phone numbers, and other information.
- Enter up to five phone numbers (home, work, fax, etc.) or e-mail addresses for each name.

Continued on next page

Checking the bundled applications on your Sony CLIÉ Handheld

- Define which phone number appears in the Address List for each Address Book entry.
- Attach a note to each Address Book entry, in which you can enter additional information about the entry.
- Assign Address Book entries to categories so that you can organize and view them in logical groups.
- Paste a PictureGear™ Pocket image to an address entry.

To Do List



To Do List is a convenient place to create reminders and prioritize the things that you have to do.

In To Do List, you can do the following:

- Make a quick and convenient list of things to do.
- Assign a priority level to each task.
- Assign a due date for any or all of your To Do List items.
- Assign To Do List items to categories so that you can organize and view them in logical groups.
- Sort your To Do List items either by due date, priority level, or category.
- Attach notes to individual To Do List items for a description or clarification of the task.

Memo Pad



Memo Pad provides a place to take notes that are not associated with records in Date Book, Address Book, or To Do List.

In Memo Pad, you can do the following:

- Take notes or write any kind of message on your CLIÉ handheld.
- Drag and drop memos into popular computer applications like the Microsoft® Word software when you synchronize using the Palm™ Desktop for CLIÉ software and HotSync® technology.
- Assign memos to categories so that you can organize and view them in logical groups.
- Write down phone numbers and other types of information. Later, you can copy and paste this information to other applications.

Calc (Calculator)



Calculator enables you to perform addition, subtraction, multiplication, division, and calculate square roots.

In Calculator, you can do the following:

- Perform basic calculations.
- Store and retrieve values.
- Display the last series of calculations, which is useful for confirming a series of “chain” calculations.

Checking the bundled applications on your Sony CLIÉ Handheld

Overview of Sony applications

In addition to the basic Palm OS applications, your CLIÉ handheld also contains original Sony applications: PictureGear™ Pocket, PhotoStand, CLIÉ Paint, MS Gate, gMovie, MS Autorun, MS Import, MS Backup, World Alarm Clock, CLIÉ Remote Commander, and Sound Utility. This section gives an overview of these original Sony applications.

PictureGear Pocket



The PictureGear Pocket application is the image management software for your CLIÉ handheld.

In the PictureGear Pocket application, you can do the following:

- View images.
- Beam your favorite image files to another CLIÉ handheld.
- Paste an image to your Address Book entry.

PhotoStand



The PhotoStand application is used to display PictureGear Pocket images one by one like a slide show. Placed on the cradle, your CLIÉ handheld functions as a photo stand.

In the PhotoStand application, you can do the following:

- Perform a slide show of the PictureGear Pocket images one by one.
- Display the time with the picture so that you can use it as a clock.
- Choose effect patterns or the time display mode.

CLIÉ Paint



The CLIÉ Paint application is used to draw shapes, letters, or patterns on PictureGear Pocket images. You can also draw from scratch on a white background. You need to install the CLIÉ Paint application from the Installation CD-ROM to your CLIÉ handheld.

In the CLIÉ Paint application, you can do the following:

- Draw on a PGP format image data using multiple drawing tools.
- Draw a picture on a white background.

MS Gate



The Memory Stick Gate (MS Gate) application is used to exchange Memory Stick data to and from your CLIÉ handheld.

In the MS Gate application, you can do the following:

- Copy or move data to and from your CLIÉ handheld and Memory Stick media.
- Delete data in Memory Stick media and in your CLIÉ handheld.
- Format Memory Stick media.

gMovie



The gMovie application is used to play a movie clip created using the PictureGear 4.4Lite software.

In the gMovie application, you can do the following:

- Play a movie file copied from your computer on your CLIÉ handheld.
- Play a movie file directly from Memory Stick media.
- Beam a movie file to another CLIÉ handheld.

MS Autorun



The Memory Stick Autorun (MS Autorun) application is used to start a specified application when Memory Stick media is inserted into your CLIÉ handheld.

In the MS Autorun application, you can do the following:

- Automatically start game software or other application stored in Memory Stick media.
- Display specified data immediately by automatically starting the associated application stored in Memory Stick media or your CLIÉ handheld.

Continued on next page

Checking the bundled applications on your Sony CLIÉ Handheld

MS Import



The Memory Stick Import (MS Import) application is used in combination with the Memory Stick Export (MS Export) software to copy your computer data on the Memory Stick media inserted in your CLIÉ handheld without performing a HotSync operation. You need to install the MS Export software from the Installation CD-ROM on your computer (The MS Import application is pre-installed on your CLIÉ handheld).

In MS Import/Export, you can do the following:

- Install CLIÉ applications directly on the Memory Stick media inserted in your CLIÉ handheld without performing a HotSync operation.
- View and handle the contents of the Memory Stick media inserted in your CLIÉ handheld as a removable device.
- Copy files between your computer's hard disk and the Memory Stick media with the Windows® Explorer.
- Choose folders other than the default folder to store CLIÉ handheld data.

MS Backup



The Memory Stick Backup (MS Backup) application is used to back up your CLIÉ data on a Memory Stick media, unlike the HotSync operation that takes a backup on your computer.

In the MS Backup application, you can do the following:

- Backup CLIÉ data on a Memory Stick media inserted in your CLIÉ handheld.
- Restore the backup data on the CLIÉ handheld once again.

World Alarm Clock



The World Alarm Clock application is a software to use your CLIÉ handheld as a world clock. You need to install the World Alarm Clock application from the Installation CD-ROM to your CLIÉ handheld.

In the World Alarm Clock application, you can do the following:

- View the date and time of multiple regions on a single screen. Daylight Saving Time settings are also available.
- Use your CLIÉ handheld as an alarm clock to remind you of a given time of a day of the week. You can also set your favorite sound as its alarm.

CLIÉ Remote Commander



The CLIÉ Remote Commander application is used to operate various multiple remote-controlled devices such as the TV, VCR, DVD player, etc. with just your CLIÉ handheld. You need to install the CLIÉ Remote Commander application from the Installation CD-ROM to your CLIÉ handheld.

In the CLIÉ Remote Commander application, you can do the following:

- Use your CLIÉ handheld as a remote commander for four devices, switching among them with just a single tap on the short-cut button. You can also control more devices by selecting from the Select menu.

Sound Utility



The Sound Utility application is used to play back and manage sound data imported from your computer. You need to install the Sound Utility application from the Installation CD-ROM to your CLIÉ handheld.

In the Sound Utility application, you can do the following:

- Play back, delete, and change the name of the sound data.

Installing the supplied applications on your computer

From the installation launcher window of the supplied CLIÉ Installation CD-ROM, you can install the following image, sound, and other applications on your computer's hard disk.

Installing PictureGear™ 4.4Lite

The PictureGear 4.4Lite software allows you to transfer image or movie files to and from your CLIÉ handheld from or to your computer. You can use the PictureGear Pocket or the gMovie application to view the transferred movie or image files on your CLIÉ handheld.

- 1** Insert the Installation CD-ROM into your computer's CD-ROM drive.

The installation launcher window is displayed.

- 2** Select the model of your CLIÉ handheld (PEG-T615C or PEG-T415).

- 3** Click Install CLIÉ Utilities.

The CLIÉ utilities window is displayed.

- 4** Click Install PictureGear Lite.

The PictureGear 4.4Lite software installation starts.

Follow the onscreen instructions to finish installation.

Installing QuickTime® 5

The QuickTime 5 software allows you to view QuickTime movies and is necessary for PictureGear Lite software to convert QuickTime movies for use on your CLIÉ handheld.

- 1** Insert the Installation CD-ROM into your computer's CD-ROM drive.

The installation launcher window is displayed.

- 2** Select the model of your CLIÉ handheld (PEG-T615C or PEG-T415).

- 3** Click Install CLIÉ Utilities.

The CLIÉ utilities window is displayed.

4 Click Install QuickTime.

The QuickTime 5 software installation starts.

Follow the onscreen instructions to finish installation.

Installing DirectX® 6

The DirectX 6 software, which is a set of graphics and sound drivers, is necessary for the PictureGear Lite software to function properly. If you already have DirectX 6.0 or later installed, you do not need to install the DirectX 6 software.

Installation is necessary when you use a computer with Windows 98 installed.

1 Insert the Installation CD-ROM into your computer's CD-ROM drive.

The installation launcher window is displayed.

2 Select the model of your CLIÉ handheld (PEG-T615C or PEG-T415).

3 Click Install CLIÉ Utilities.

The CLIÉ utilities window is displayed.

4 Click Install DirectX 6.

The DirectX 6 software installation starts.

Installing Memory Stick Export

To use the MS Import/Export feature, you need to install the MS Export software, a PC tool to save an application on the proper directory in the Memory Stick media, on your computer.

1 Insert the Installation CD-ROM into your computer's CD-ROM drive.

The installation launcher window is displayed.

2 Select the model of your CLIÉ handheld (PEG-T615C or PEG-T415).

Continued on next page

Installing the supplied applications on your computer

3 Click Install CLIÉ Utilities.

The CLIÉ Utilities window is displayed.

4 Click Install Memory Stick Export.

The software installation starts. Follow the onscreen instructions to finish the installation.

Installing Sound Converter

The Sound Converter software allows you to convert “WAVE format” or “Standard MIDI File Format 0” files on your computer to the sound data compatible with your CLIÉ handheld. To play back the converted data on your CLIÉ handheld, you must install the Sound Utility application on your CLIÉ handheld.

1 Insert the Installation CD-ROM into your computer’s CD-ROM drive.

The installation launcher window is displayed.

2 Select the model of your CLIÉ handheld (PEG-T615C or PEG-T415).

3 Click Install CLIÉ Utilities.

The CLIÉ Utilities window is displayed.

4 Click Install Sound Converter.

The software installation starts. Follow the onscreen instructions to finish the installation.

Installing AvantGo® and other third-party applications

AvantGo Client, which is an add-on application for your CLIÉ handheld, is a Web browser that allows you to easily access to the AvantGo Server site and to find and upgrade contents and applications on your CLIÉ handheld.

You can install AvantGo or other add-on applications on your computer and then install them on your CLIÉ handheld at the next HotSync® operation. For details, see “Installing add-on applications from the Palm™ Desktop for CLIÉ software” on page 54.

Note

You must be connected to the Internet to install AvantGo.

- 1** Insert the Installation CD-ROM into your computer's CD-ROM drive.
The installation launcher window is displayed.
- 2** Select the model of your CLIE handheld (PEG-T615C or PEG-T415).
- 3** Click FREE Third-party Software.
The FREE Third-party Software installation window is displayed.
- 4** Click Travel and Entertainment.
The Travel and Entertainment window is displayed.
- 5** Click AvantGo.
The AvantGo application installation starts. Follow the onscreen instructions to finish the installation.

Installing Acrobat Reader® 5.0

The Acrobat Reader 5.0 software allows you to view, navigate, and print Adobe Portable Document Format (PDF) documents. To open and read the PDF manuals in the CLIE Installation CD-ROM, you need the Acrobat Reader software installed in your computer's hard disk.

- 1** Insert the Installation CD-ROM into your computer's CD-ROM drive.
The installation launcher window is displayed.
- 2** Click Exit to close the installation launcher window.
- 3** Click Start from the taskbar, then click Run.
The Run window is displayed.
- 4** Type or select "D:\PC\Acrobat\ar500enu.exe" in the text box and click Run. ("D:" substitutes the drive letter of your CD-ROM drive.)
You can also use Browse to specify the setup program.
The Acrobat Reader 5.0 software installation starts. Follow the onscreen instructions to finish installation.

Installing the supplied applications on your computer

Uninstalling the supplied applications

In the event that you no longer need an application you installed, you can remove an application from your computer's hard disk as follows:

- 1** Click Start from the taskbar, point to Settings, and click Control Panel.

The Control Panel window is displayed.

- 2** Double-click Add/Remove Programs.

The Add/Remove Programs Properties window is displayed.

- 3** In the Install/Uninstall tab, select the software that you want to remove.

- 4** Click Add/Remove.

The confirmation dialog box is displayed.

- 5** Click OK to remove the software.

Follow the onscreen instructions to remove the application from your computer's hard disk.

Tip

Some applications have their own uninstaller program. To remove QuickTime, for example, click Start on the taskbar, point to Programs (All Programs in Windows® XP), QuickTime, and then click Uninstall QuickTime.

Installing add-on applications on your Sony CLIÉ Handheld or Memory Stick media

Your CLIÉ handheld comes with various applications such as Date Book, Address Book, To Do List, Memo Pad, Calculator, e-mail application, etc.

In addition to these applications, you can install additional applications called “add-on applications” from the Installation CD-ROM on your CLIÉ handheld, or to the Memory Stick media (sold separately) if you want to save your CLIÉ handheld’s memory space. A variety of third-party applications are also available for your CLIÉ handheld, such as games and other software that run on the Palm OS®. For information on the latest third-party applications, see the Sony official CLIÉ Web site (<http://www.sony.com/clié/>).

Notes

- Add-on applications reside in the RAM memory of your CLIÉ handheld. Performing a hard reset deletes all the add-on applications. However, if you perform a HotSync® operation before the hard reset and make a backup copy, you can restore add-on applications at the next HotSync operation.
- The add-on applications contained in the CLIÉ Installation CD-ROM are copied on your computer’s hard disk when you install the Palm™ Desktop for CLIÉ software. To install those applications from the Palm Desktop for CLIÉ software on your CLIÉ handheld, follow the procedures described in the next section.

Installing add-on applications on your Sony CLIÉ Handheld or Memory Stick media

Installing add-on applications from the Palm™ Desktop for CLIÉ software

This section describes how to install add-on applications on your CLIÉ handheld or to the Memory Stick media using the Install Tool during a HotSync® operation.

- 1 Copy or download the application you want to install into the Add-on folder in the Sony CLIÉ Handheld folder on your computer (example : C:\Program Files\Sony Handheld\Add-on).

If you want to copy to a different folder, specify the folder in step 5.

- 2 Double-click the Palm Desktop for CLIÉ software icon on the Windows® desktop or click Start, point to Programs (All Programs in Windows® XP), Sony Handheld, and click Palm Desktop for CLIÉ.

The Palm Desktop for CLIÉ software starts.

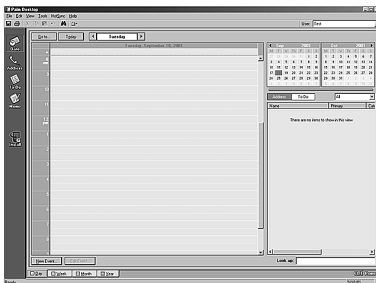

- 3 Click Install.

The Install Tool dialog box appears.

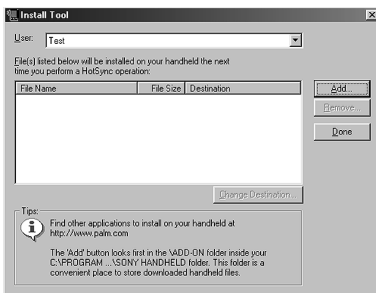

4 From the User drop-down list, select a user name to use.

5 Click Add.

The Open File dialog box appears. The supplied add-on applications are stored in the Add-on folder.

6 Select the application(s) you want to install on your CLIÉ handheld.

In the Install Tool dialog box, the list of applications you selected is displayed.

If you do not want to install an application, select it, and then click Remove. (The application is deleted from the list but remains on your computer's hard disk.)

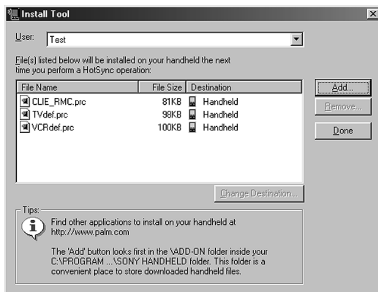

7 Click Done.

8 Click OK.

9 Perform a HotSync operation.

The application(s) you selected in step 6 will be installed on your CLIÉ handheld. See page 36 (Step 6: Performing a HotSync® operation for the first time) for details on a local HotSync operation.

Installing add-on applications on your Sony CLIÉ Handheld or Memory Stick media

To access the Install Tool dialog box

Do either of the following to display the Install Tool dialog box immediately:

- Click Start on the taskbar, point to Programs (All Programs in Windows® XP), Sony Handheld, and then click Install Tool.
- Double-click any file with a PRC, or PDB file extension.

To install applications to the Memory Stick media

You can install applications to the Memory Stick media by performing one of the following:

- Use the MS Import/Export applications to install applications directly on an inserted Memory Stick media (See the Add-on Applications Guide for details).
- To install applications through the Palm Desktop for CLIÉ software, click Change Destination after performing step 6 on page 55. Click the file name(s) to select the file(s), then click the arrow (>> or <<) button to select Memory Stick as the destination and click OK. Proceed to step 7.

Note

When installing add-on applications to the Memory Stick media, be sure to perform the HotSync operation with the Memory Stick media inserted in your CLIÉ handheld.

If you installed applications to the Memory Stick media through Palm Desktop for CLIÉ software

With some applications, your CLIÉ handheld may not be able to display data if you installed the application in the Memory Stick media.



This is because the Palm Desktop for CLIÉ software installs application data in the /PALM/Launcher directory when Memory Stick is selected. As a result, some application data cannot be started through normal process.

If the application you installed in the Memory Stick media fail to start, copy the data again, this time to your CLIÉ handheld. For details, see “Copying data in Memory Stick media to your CLIÉ handheld” in the Operating Instructions manual.

Installing add-on applications by beaming them from another Palm OS® device

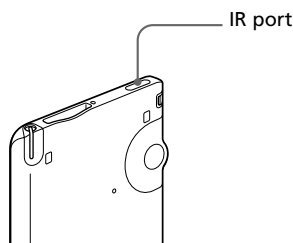
Your CLIE handheld is equipped with an IR (infrared) port that you can use to beam an application to another Palm OS® PDA device that is close by and also has an IR port. You can beam applications that are either installed in your CLIE handheld or stored in the inserted Memory Stick media. The IR port is located at the top of your CLIE handheld, behind the small dark shield.



- 1** Tap the Home  icon.
The Application Launcher screen appears.
- 2** Tap the Menu  icon.
The menu is displayed.
- 3** Tap Beam.
The Beam screen appears.

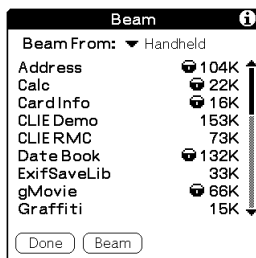

- 4** Tap the arrow ▼ next to Beam From, and select Handheld or Card.

Continued on next page

Installing add-on applications on your Sony CLIE Handheld or Memory Stick media

- 5** Tap the application you want to transfer.

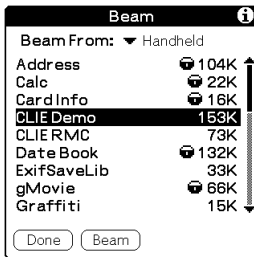

Note

Some applications are copy-protected and cannot be beamed. These are listed with the lock icon next to them.

- 6** Tap Beam.

- 7** When the Beam dialog box appears, point the IR port directly at the IR port of the receiving handheld.

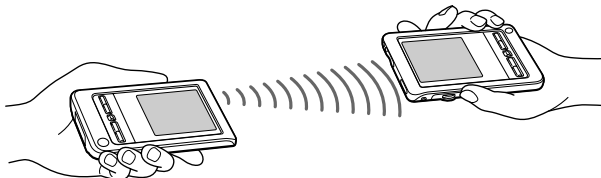
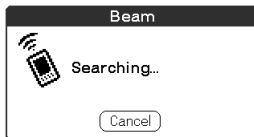

Tip

For best results, the handhelds should be 4 to 8 inches (approximately 10 to 20 centimeters) apart, and the path between the two handhelds must be clear of obstacles. Beaming distance to other Palm OS PDA devices may be different.

- 8** Wait for the Beam dialog box to indicate that the transfer is complete before you continue using your CLIE handheld.

Installing add-on applications directly from the Installation CD-ROM menu

You can also install applications directly from the supplied Installation CD-ROM menu to your CLIÉ handheld. You do not have to start the Palm Desktop for CLIÉ software.

- 1** Insert the Installation CD-ROM into the CD-ROM drive of your computer.
- 2** Select the model of your CLIÉ handheld (PEG-T615C or PEG-T415).
- 3** Click Install CLIÉ Add-on Applications.
- 4** Click CLIÉ Add-ons.
InstallShield Wizard starts and the Select Components window appears.
- 5** Click the check box to select the add-on applications you wish to install.
- 6** Click Next.
- 7** From the User name drop-down list, select your CLIÉ handheld's user name.
- 8** Click OK.
- 9** Click Done.
- 10** Perform a HotSync operation.

The application(s) you selected in step 4 will be installed on your CLIÉ handheld. See page 36 (Step 6: Performing a HotSync® operation for the first time) for details on a local HotSync operation.



Installing add-on applications on your Sony CLIÉ Handheld or Memory Stick media

Removing add-on applications

If the memory of your CLIÉ handheld or Memory Stick media is full, or you decide that an add-on application is no longer needed, you can remove it from your CLIÉ handheld or the Memory Stick media.

Note

You can remove only add-on applications, patches, and extensions that you have installed. You cannot remove the standard applications provided with your CLIÉ handheld, such as Address Book or Memo Pad.

- 1** Tap the Home  icon.
The Application Launcher screen appears.
- 2** Tap the Menu  icon.
The menu is displayed.
- 3** Tap Delete.
The Delete screen appears.
- 4** Tap the arrow ▼ next to Delete From and select Handheld or Card.
- 5** Tap the application you want to delete, and tap Delete.
A confirmation message for Delete Application is displayed.

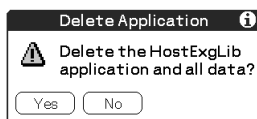

- 6** Tap Yes.
The application you selected in step 5 is deleted.
To cancel deletion, tap No.
- 7** Tap Done.
The Application Launcher screen appears again.

Customer registration

If you do not fill in the customer registration after installing the Palm™ Desktop for CLIÉ software, follow the instructions in this section to complete the registration.

Note

Your computer needs to be connected to the internet to complete the registration.

- 1** Double-click the Sony CLIÉ Registration icon on the Windows® desktop or click Start on the taskbar, point to Programs (All Programs in Windows® XP), Sony Handheld, and then click Sony CLIÉ Registration. The Sony CLIÉ Handheld Registration screen appears.
- 2** Click Start your registration process. Your computer is connected to the Internet, and the user registration Web page at the following URL is displayed:
<http://www.sony.com/clié/register/>
- 3** Follow the onscreen instructions.

For the latest support information,
check our official Sony CLIE Web site

<http://www.sony.com/clie/>

<http://www.sony.net/>

Free Manuals Download Website

<http://myh66.com>

<http://usermanuals.us>

<http://www.somanuals.com>

<http://www.4manuals.cc>

<http://www.manual-lib.com>

<http://www.404manual.com>

<http://www.luxmanual.com>

<http://aubethermostatmanual.com>

Golf course search by state

<http://golfingnear.com>

Email search by domain

<http://emailbydomain.com>

Auto manuals search

<http://auto.somanuals.com>

TV manuals search

<http://tv.somanuals.com>