

LCD Multi Function Display

***MFM-HT75W
MFM-HT95***

Owner's Record

The model and serial numbers are located at the rear of the unit. Record these numbers in the spaces provided below. Refer to them whenever you call upon your dealer regarding this product.
Model No. _____ Serial No. _____

WARNING

To prevent fire or shock hazard, do not expose the unit to rain or moisture.

Dangerously high voltages are present inside the unit. Do not open the cabinet. Refer servicing to qualified personnel only.

FCC Notice

This equipment has been tested and found to comply with the limits for a Class B digital device, pursuant to Part 15 of the FCC Rules. These limits are designed to provide reasonable protection against harmful interference in a residential installation. This equipment generates, uses, and can radiate radio frequency energy and, if not installed and used in accordance with the instructions, may cause harmful interference to radio communications. However, there is no guarantee that interference will not occur in a particular installation. If this equipment does cause harmful interference to radio or television reception, which can be determined by turning the equipment off and on, the user is encouraged to try to correct the interference by one or more of the following measures:

- Reorient or relocate the receiving antenna.
 - Increase the separation between the equipment and receiver.
 - Connect the equipment into an outlet on a circuit different from that to which the receiver is connected.
 - Consult the dealer or an experienced radio/TV technician for help.
- You are cautioned that any changes or modifications not expressly approved in this manual could void your authority to operate this equipment.

IMPORTANTE

Para prevenir cualquier mal funcionamiento y evitar daños, por favor, lea detalladamente este manual de instrucciones antes de conectar y operar este equipo.

If you have any questions about this product, you may call;
Sony Customer Information Services Center
1-800-222-7669 or <http://www.sony.com/>

Declaration of Conformity

Trade Name: SONY
Model: MFM-HT75W/HT95
Responsible Party: Sony Electronics Inc.
Address: 16450 W. Bernardo Dr,
San Diego, CA 92127 U.S.A.
Telephone Number: 858-942-2230

This device complies with part 15 of the FCC rules. Operation is subject to the following two conditions: (1) This device may not cause harmful interference, and (2) this device must accept any interference received, including interference that may cause undesired operation.

NOTICE

This notice is applicable for USA/Canada only.
If shipped to USA/Canada, install only a UL LISTED/CSA LABELLED power supply cord meeting the following specifications:

SPECIFICATIONS

Plug Type	Nema-Plug 5-15p
Cord	Type SVT or SJT, minimum 3 × 18 AWG
Length	Maximum 15 feet
Rating	Minimum 7 A, 125 V

NOTICE

Cette notice s'applique aux Etats-Unis et au Canada uniquement.

Si cet appareil est exporté aux Etats-Unis ou au Canada, utiliser le cordon d'alimentation portant la mention UL LISTED/CSA LABELLED et remplissant les conditions suivantes:

SPECIFICATIONS

Type de fiche	Fiche Nema 5-15 broches
Cordon	Type SVT ou SJT, minimum 3 × 18 AWG
Longueur	Maximum 15 pieds
Tension	Minimum 7 A, 125 V



As an ENERGY STAR Partner, Sony Corporation has determined that this product meets the ENERGY STAR guidelines for energy efficiency.

Important Safety Instructions









- 1) Read these instructions.
 - 2) Keep these instructions.
 - 3) Heed all warnings.
 - 4) Follow all instructions.
 - 5) Do not use this apparatus near water.
 - 6) Clean only with dry cloth.
 - 7) Do not block any ventilation openings. Install in accordance with the manufacturer's instructions.
 - 8) Do not install near any heat sources such as radiators, heat registers, stoves, or other apparatus (including amplifiers) that produce heat.
 - 9) Do not defeat the safety purpose of the polarized or grounding-type plug. A polarized plug has two blades with one wider than the other. A grounding type plug has two blades and a third grounding prong. The wide blade or the third prong are provided for your safety. If the provided plug does not fit into your outlet, consult an electrician for replacement of the obsolete outlet.
 - 10) Protect the power cord from being walked on or pinched particularly at plugs, convenience receptacles, and the point where they exit from the apparatus.
 - 11) Only use attachments/accessories specified by the manufacturer.
 - 12) Use only with the cart, stand, tripod, bracket, or table specified by the manufacturer, or sold with the apparatus. When a cart is used, use caution when moving the cart/apparatus combination to avoid injury from tip-over.
- 
- 13) Unplug this apparatus during lightning storms or when unused for long periods of time.
 - 14) Refer all servicing to qualified service personnel. Servicing is required when the apparatus has been damaged in any way, such as power-supply cord or plug is damaged, liquid has been spilled or objects have fallen into the apparatus, the apparatus has been exposed to rain or moisture, does not operate normally, or has been dropped.

Table of Contents

Precautions	5
Identifying parts and controls	6
Setup	9
Setup 1: Open the stand	9
Setup 2: Connect the cables	9
Setup 3: Connect the power cord	12
Setup 4: Replace the connector cover	12
Setup 5: Turn on the display and other equipment	12
Setup 6: Adjust the tilt	13
Setup 7: Insert batteries into the remote control	13
Watching the TV	14
 Setting the TV channels	14
Changing the TV channel	14
Skipping unnecessary channels	14
Choosing between cable and UHF/VHF	14
Using other features	15
Customizing Your Display	15
Navigating the menu	15
 Picture menu	17
Selecting the Picture Mode for PC 1/PC 2	17
Selecting the Picture Mode for TV/VIDEO 1/VIDEO 2	17
Adjusting "Backlight"	18
Adjusting "Contrast" ("Picture")	18
Adjusting "Brightness"	18
Adjusting "Color" (for TV/VIDEO 1/VIDEO 2 only)	18
Adjusting "Hue" (for TV/VIDEO 2 only)	18
Adjusting "Sharpness"(for TV/VIDEO 1/VIDEO 2 only)	18
Adjusting "Color Temp." (for PC 1/PC 2 only)	19
Adjusting "Gamma" (for PC 1/PC 2 only)	19
Resetting Picture Mode to the default	20
Setting "NR" (for TV/VIDEO 1/VIDEO 2 only)	20
Setting "Dynamic Picture" (for TV/VIDEO 1/VIDEO 2 only)	20
 Audio menu	21
Setting "Surround"	21
Adjusting "Treble," "Bass," and "Balance"	21
Setting "Auto Volume" (for TV/VIDEO 1/VIDEO 2 only)	21
Setting "MTS" (for TV only)	22
Resetting all audio settings to the default	22
 Screen menu	22
Setting "Zoom"	22
Automatic picture quality adjustment function (for PC 2 only)	23
Making further automatic adjustments to the picture quality for the current input signal (Auto Adjust) (for PC 2 only)	23
Adjusting the picture's sharpness manually (Phase/Pitch) (for PC 2 only)	24
Adjusting the picture's position manually (H Center /V Center) (for PC 2 only)	24

US

- Macintosh is a trademark licensed to Apple Computer, Inc., registered in the U.S.A. and other countries.
- Windows® is registered trademark of Microsoft Corporation in the United States and other countries.
- IBM PC/AT and VGA are registered trademarks of IBM Corporation of the U.S.A.
- VESA and DDC™ are trademarks of the Video Electronics Standards Association.
- ENERGY STAR is a U.S. registered mark.
- Adobe and Acrobat are trademarks of Adobe Systems Incorporated.
- WOW, SRS and  symbol are trademarks of SRS Labs, Inc.
- WOW technology is incorporated under license from SRS Labs, Inc.
- All other product names mentioned herein may be the trademarks or registered trademarks of their respective companies.
- Furthermore, "™" and "®" are not mentioned in each case in this manual.

 Parent menu	25
Activating the Parental Control feature	25
Selecting a Custom Rating	26
What the Ratings Mean	28
 Option menu	30
Setting "PIP" (Picture In Picture) (for PC 1/PC 2 only)	30
Setting "Caption Vision" (for TV/VIDEO 1/VIDEO 2 only)	32
Setting "Input Sensing" (for PC 1/PC 2 only)	32
Setting "Language"	32
Setting "Menu Position"	32
Setting "Menu Lock"	33
Setting "Demo Mode"	33
Resetting to the default setting	33
<hr/>	
Technical Features	34
Controlling the volume	34
Power saving function	34
Setting the Picture Mode	35
Automatic brightness adjustment function (light sensor)	35
Automatic picture quality adjustment function (for PC 2 only)	35
Turning off the display automatically (for TV/VIDEO 1/VIDEO 2 only)	36
<hr/>	
Troubleshooting	36
On-screen messages	36
Trouble symptoms and remedies	38
<hr/>	
Specifications	41

Precautions

Warning on power connections

- Use the supplied power cord. If you use a different power cord, be sure that it is compatible with your local power supply.

For the customers in the U.S.A.

If you do not use the appropriate cord, this display will not conform to mandatory FCC standards.

For the customers in the UK

If you use the display in the UK, be sure to use the appropriate UK power cord.

Example of plug types

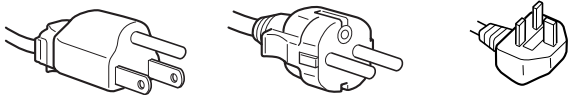

for 100 to 120 V AC for 200 to 240 V AC for 240 V AC only

The equipment should be installed near an easily accessible outlet.

Installation

Do not install or leave the display:

- In places subject to extreme temperatures, for example near a radiator, heating vent, or in direct sunlight. Subjecting the display to extreme temperatures, such as in an automobile parked in direct sunlight or near a heating vent, could cause deformations of the casing or malfunctions.
- In places subject to mechanical vibration or shock.
- The ventilation should not be impeded by covering the ventilation openings with items, such as newspapers, tablecloths, curtains, etc.
- Leave some space around the unit. Otherwise, adequate air-circulation may be blocked causing overheating and cause fire or damage the unit.

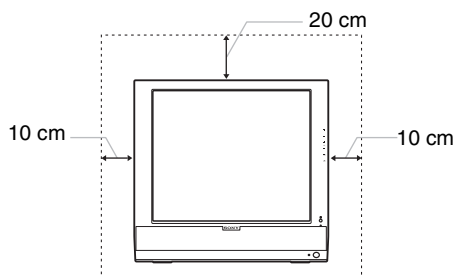

- Near any equipment that generates a strong magnetic field, such as a TV or various other household appliances.
- In places subject to inordinate amounts of dust, dirt, or sand, for example near an open window or an outdoor exit. If setting up temporarily in an outdoor environment, be sure to take adequate precautions against airborne dust and dirt. Otherwise irreparable malfunctions could occur.
- To reduce the risk of fire or electric shock, do not expose this Apparatus to rain or moisture.
- Apparatus shall not be exposed to dripping or splashing and no objects filled with liquids, such as vases, shall be placed on the apparatus.
- To prevent fire, keep inflammable objects or naked lights (e.g. candles) away from the unit.
- Do not place the unit near or over a radiator or heat register, or where it is exposed to direct sunlight.

Handling the LCD screen

- Do not leave the LCD screen facing the sun as it can damage the LCD screen. Take care when you place the display by a window.

- Do not push on or scratch the LCD screen. Do not place a heavy object on the LCD screen. This may cause the screen to lose uniformity or cause LCD panel malfunctions.
- If the display is used in a cold place, a residual image may appear on the screen. This is not a malfunction. The screen returns to normal as the temperature rises to a normal operating level.
- If a still picture is displayed for a long time, a residual image may appear for a while. The residual image will eventually disappear.
- The LCD panel becomes warm during operation. This is not a malfunction.

About the built-in stereo speakers

Be sure to keep magnetic recording equipment, tapes, and floppy discs away from the speaker's opening as the speakers generate a magnetic field. This magnetic field may affect data stored on magnetic tapes and discs.

Note on the LCD (Liquid Crystal Display)

Please note that the LCD screen is made with high-precision technology. However, black points or bright points of light (red, blue, or green) may appear constantly on the LCD screen, and irregular colored stripes or brightness may appear on the LCD screen. This is not malfunction.

(Effective dots: more than 99.99%)

Maintenance

- Be sure to unplug the power cord from the power outlet before cleaning your display.
- Clean the LCD screen with a soft cloth. If you use a glass cleaning liquid, do not use any type of cleaner containing an anti-static solution or similar additive as this may scratch the LCD screen's coating.
- Clean the cabinet, panel, and controls with a soft cloth lightly moistened with a mild detergent solution. Do not use any type of abrasive pad, scouring powder, or solvent, such as alcohol or benzene.
- Do not rub, touch, or tap the surface of the screen with sharp or abrasive items such as a ballpoint pen or screwdriver. This type of contact may result in a scratched picture tube.
- Note that material deterioration or LCD screen coating degradation may occur if the display is exposed to volatile solvents such as insecticide, or if prolonged contact is maintained with rubber or vinyl materials.

Transportation

- Disconnect all cables from the display, and grasp both side of the LCD display firmly taking care not to scratch the screen when transporting. If you drop the display, you may be injured or the display may be damaged.
- When you transport this display for repair or shipment, use the original carton and packing materials.

Disposal of the display

- Do not dispose of this display with general household waste.**
- The fluorescent tube used in this display contains mercury. Disposal of this display must be carried out in accordance to the regulations of your local sanitation authority.**

Disposal of used batteries

To preserve our environment, dispose the used batteries according to your local laws or regulations.

US

For customers in the United States

This product contains mercury. Disposal of this product may be regulated if sold in the United States. For disposal or recycling information, please contact your local authorities or the Electronics Industries Alliance (<http://www.eiae.org>).

Installation on a wall or a mounting arm

If you intend to install the display on a wall or a mounting arm, be sure to consult qualified personnel.

Identifying parts and controls

See the pages in parentheses for further details.

Front of the LCD display

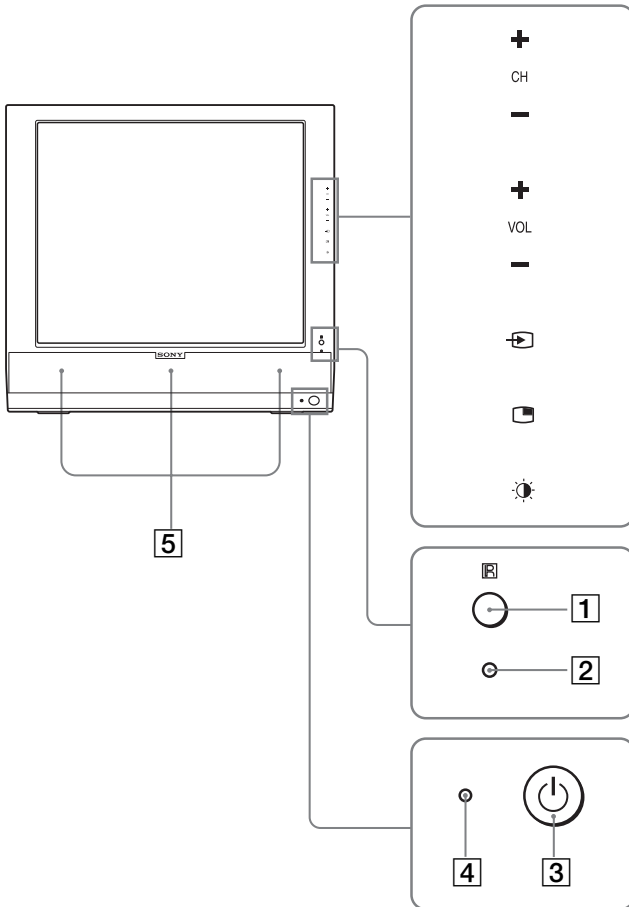

Side view of the LCD display

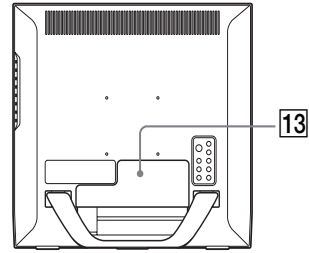
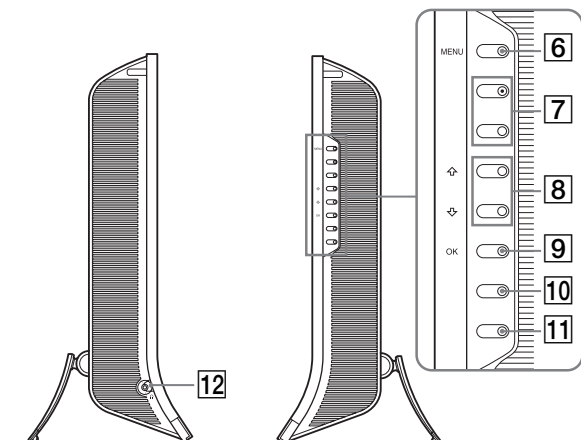

- 1 Remote control sensor**
This sensor receives a signal from the remote control. Be sure not to cover the sensor with papers, etc.
- 2 Light sensor (page 35)**
This sensor measures the brightness of the surrounding area. Be sure not to cover the sensor with papers, etc.
- 3 (power) switch (page 12)**
Press to turn the display on or off.
- 4 (power) indicator (pages 12, 34)**
The power indicator lights up in green when the display is turned on, and lights up in orange when the display is in the power saving mode. Also, the power indicator lights up in red when the display is in the standby mode or the Sleep timer is activated.
- 5 Stereo speakers (page 34)**
These speakers output the audio signals as sound.
- 6 MENU button (page 15)**
Press to turn the menu screen on and off.
- 7 CH+/- buttons (page 14)**
Press to change the TV channel.
- 8 ↑/↓ and VOL+/- (volume control) buttons (pages 15, 34)**
Use to select the menu items and to make adjustments, and also display the "Volume" adjustment bar to control the volume.
- 9 (input select)/OK button (page 12, 15)**
This button functions in two ways. As the (input select) button, this button switches the input signal between PC 1, PC 2, TV, VIDEO 1, and VIDEO 2 when two computers and two pieces of video equipment are connected. As the OK button, this button activates the selected menu item or adjustments made using the ↑/↓ buttons [8].
- 10 (PiP) button (page 30)**
Press to switch the "PiP" (Picture In Picture) setting. Each time you press this button, the PiP setting changes as follows.
PiP On → PiP Off → PiP On...
- 11 (Picture Mode) button (page 35)**
Press to switch the Picture Mode.
- 12 Headphones jack (page 34)**
This jack outputs audio signals to the headphones.

13 Connector cover (page 9)

Remove this cover when you connect cables or cords.

Rear of the LCD display

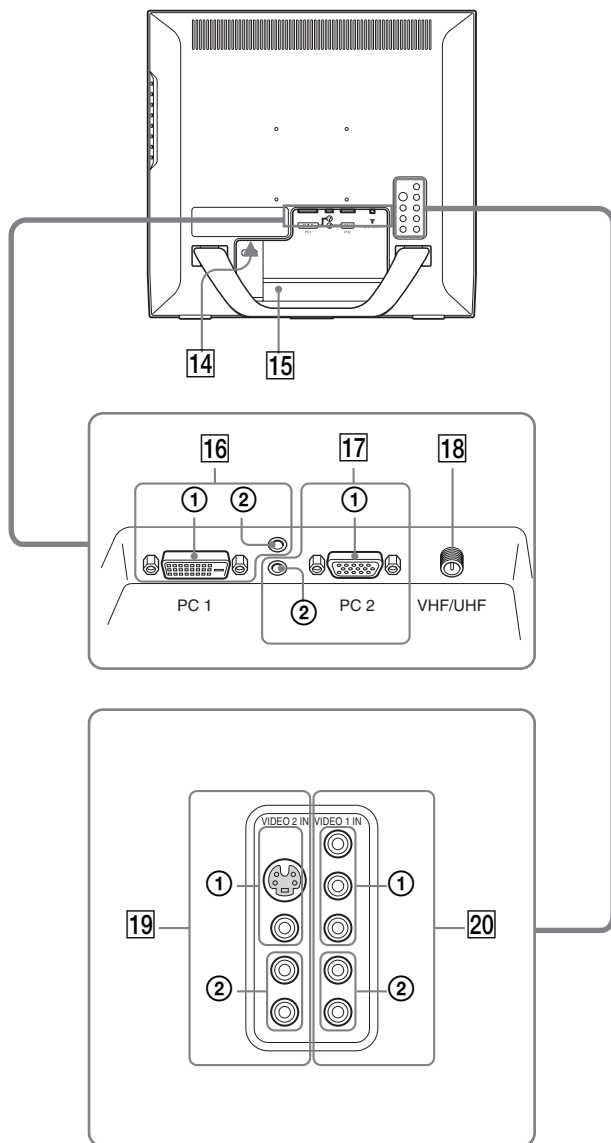

14 AC IN connector (page 12)

This connector connects the power cord (supplied).

15 Security Lock Hole

The security lock hole should be used with the Kensington Micro Saver Security System. Micro Saver Security System is a trademark of Kensington.

16 PC 1 connectors

① DVI-D input connector (digital RGB) for PC 1 (page 9)

This connector inputs digital RGB video signals that comply with DVI Rev.1.0.

② Audio input jack for PC 1 (page 9)

This jack inputs audio signals when connected to the audio output jack of a computer or other equipment connected to PC 1.

17 PC 2 connectors

① HD15 input connector (analog RGB) for PC 2 (page 9)

This connector inputs analog RGB video signals (0.700 Vp-p, positive) and sync signals.

② Audio input jack for PC 2 (page 9)

This jack inputs audio signals when connected to the audio output jack of a computer or other equipment connected to PC 2.

18 VHF/UHF jack (page 11)

This jack inputs a signal from an antenna.

19 VIDEO 2 jacks

① Composite/S video input jacks for VIDEO 2 (page 11)

These jacks input composite video or S video signals. When you connect video equipment to both composite video input and S video input jacks, the signal from the S video jack is displayed.

② Audio input jacks for VIDEO 2 (page 11)

These jacks input audio signals when connected to the audio output jacks of a VCR or other equipment connected to VIDEO 2.

20 VIDEO 1 jacks

① Y/P_B/P_R Component Video input jacks for VIDEO 1 (page 10)

These jacks input Y/P_B/P_R Component Video signals (Y/C_B/C_R, Y/B-Y/R-Y, or Y/P_B/P_R).

② Audio input jacks for VIDEO 1 (page 10)

These jacks input audio signals when connected to the audio output jacks of a DVD player or other equipment connected to VIDEO 1.

US

Remote control

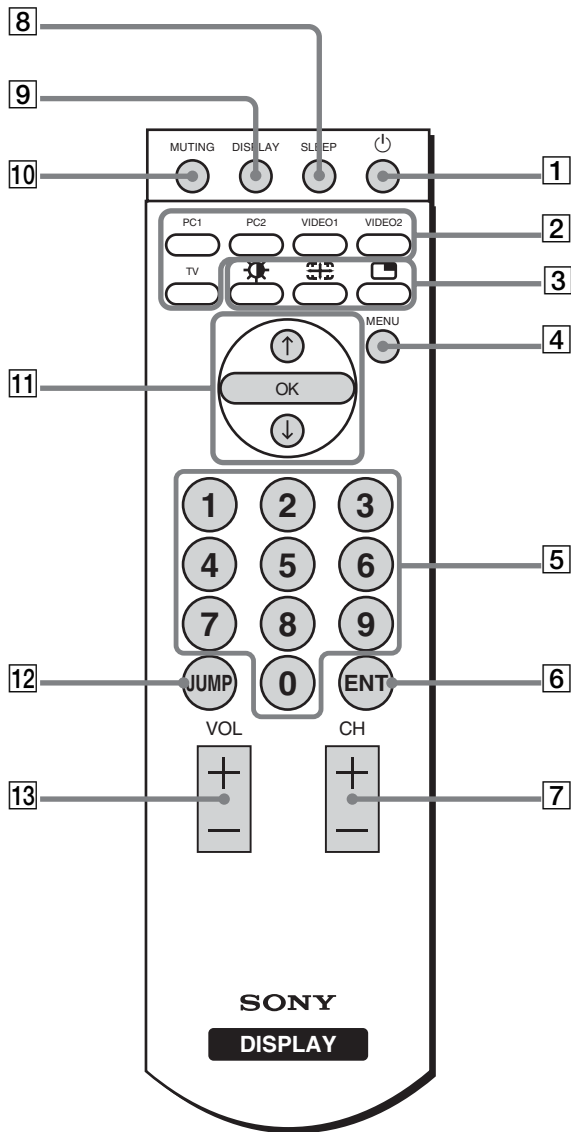

1 (power) switch (page 12)
Press to turn the display on or off.

2 **Input select buttons**

PC 1 (page 9): Press to select a signal input through the PC 1 connectors (DVI-D) on the rear.

PC 2 (page 9): Press to select a signal input through the PC 2 connectors (HD15) on the rear.

VIDEO 1 (page 10): Press to select a signal input through the VIDEO 1 jacks (Y/P_B/P_R Component) on the rear.

VIDEO 2 (page 11): Press to select a signal input through the VIDEO 2 jacks (composite/S video) on the rear.

TV (page 14): Press to select the TV input.

3 **Feature buttons**

(Picture Mode) (page 35):
Press repeatedly to step through the Picture Mode.

(Zoom) (page 22):
Press repeatedly to step through the “Zoom” settings.

(PinP) (page 30):
Press repeatedly to step through the “PIP” settings.

4 **MENU button (page 15)**

Press to turn the menu screen on and off.

5 **0-9 buttons (page 14)**

Use these buttons to input numbers.

6 **ENT (enter) button (page 14)**

Press to confirm the numbers you input using the 0-9 buttons.

7 **CH +/- buttons (page 14)**

Press to change the TV channel.

8 **SLEEP button (page 36)**

Press repeatedly to set the display to turn off automatically after a specified period of time. If you use this function and set the Sleep timer, the (power) indicator lights up in red.

9 **DISPLAY button (page 15)**

Press once to display the current channel number. The channel number displayed will remain until you press this button again.

10 **MUTING button (page 15)**

Press to turn the sound off. Press again or press the VOL + button to restore the sound.

11 **↑/↓ and OK buttons (page 15)**

Use the ↑/↓ buttons to select menu items and make adjustments.
Press the OK button to activate the selected menu item and adjustments made using the ↑/↓ buttons.

12 **JUMP button (page 15)**

Press to switch the TV channel between the current one and the last one that was selected using the 0-9 buttons.

13 **VOL +/- buttons (page 34)**

Press to adjust the sound volume.

Setup

Before using your display, check that the following items are included in your carton:

- LCD display
- Remote control
- Size AAA batteries (2)
- Power cord
- HD15-HD15 video signal cable (analog RGB)
- DVI-D video signal cable (digital RGB)
- Audio cord (stereo miniplug)
- 75-ohm coaxial cable
- CD-ROM (utility software for Windows/Macintosh, Operating Instructions, etc.)
- Warranty card
- Quick Setup Guide

Setup 1: Open the stand

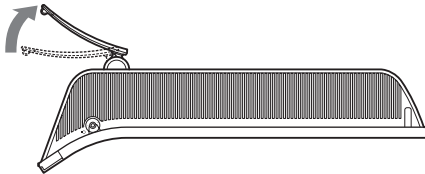

Note

The stand is folded at the factory. Be sure not to place the display vertically with the stand as it is. Otherwise, the display may topple over.

Setup 2: Connect the cables

- **Turn off the display, computer, and other equipment before connecting them.**
- **If you intend to connect:**
 - A computer equipped with an HD15 output connector (analog RGB)
 - See “Connecting a computer using the PC 2 connectors” on this page.
 - Video equipment that has component video output jacks
 - See “Connecting video equipment using the VIDEO 1 jacks” (page 10).
 - Video equipment that has composite/S video output jacks
 - See “Connecting video equipment using the VIDEO 2 jacks” (page 11).
 - An antenna
 - See “Connecting an antenna” (page 11).

Note

Do not touch the pins of the video signal cable connector as this might bend the pins.

Remove the connector cover.

Push the hooks and draw the connector cover towards you.

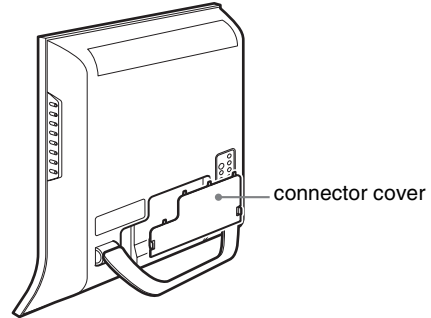

■ Connecting a computer using the PC 1 connectors

If you intend to connect a computer equipped with a DVI connector (digital RGB), follow the instructions below.

Using the supplied DVI-D video signal cable (digital RGB) and the supplied audio cord, connect the computer to the display's PC 1 connectors.

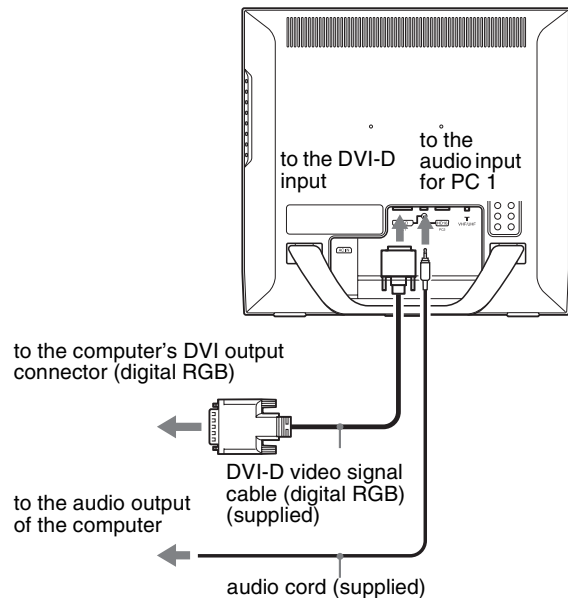

■ Connecting a computer using the PC 2 connectors

If you intend to connect a computer equipped with an HD15 connector (analog RGB), follow the instructions below.

Using the supplied HD15-HD15 video signal cable (analog RGB) and the supplied audio cord, connect the computer to the display's PC 2 connectors.

Connect the computer according to the following illustrations.

US

To connect to an IBM PC/AT or compatible computer

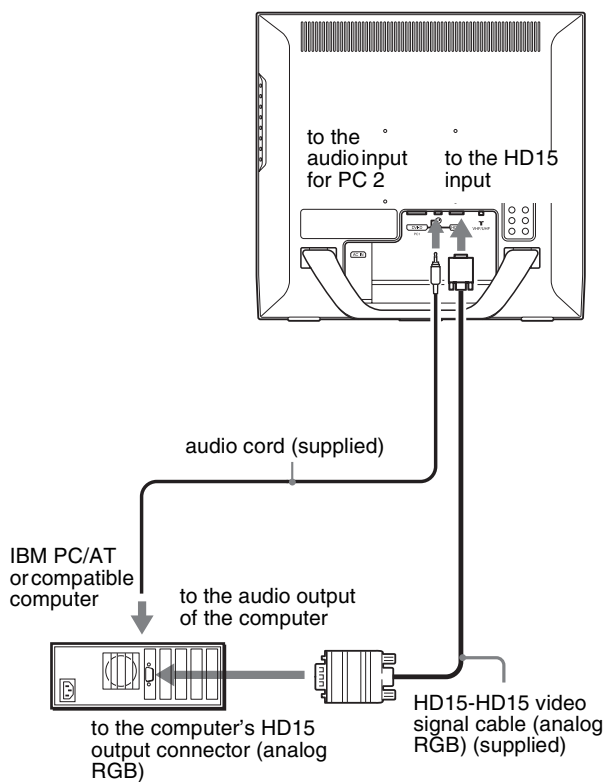

To connect to a Macintosh computer

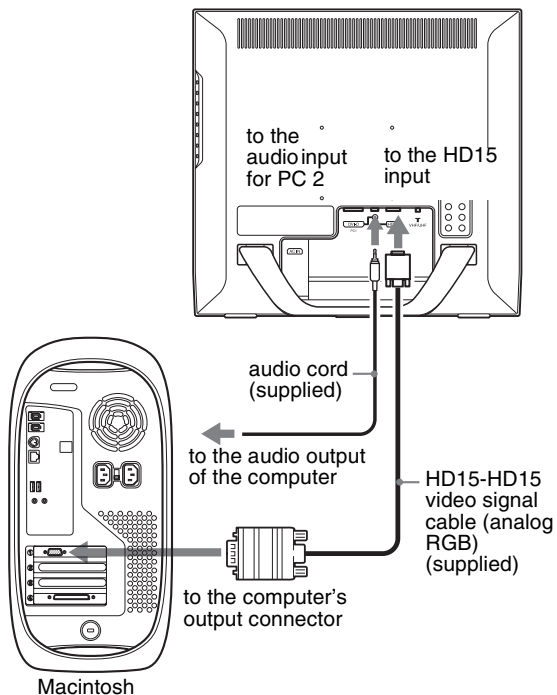

When connecting a Macintosh computer, use an adapter (not supplied), if necessary. Connect the adapter to the computer before connecting the video signal cable.

Connecting video equipment using the VIDEO 1 jacks

If you intend to connect video equipment that has component video output jacks, such as a DVD player, follow the instructions below.

Using a video signal cable (not supplied) and an audio cord (not supplied), connect the video equipment to the display's VIDEO 1 jacks.

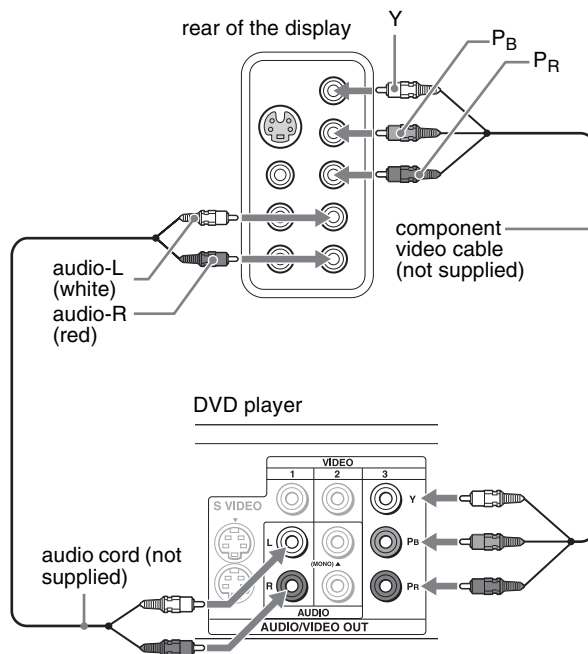

■ Connecting video equipment using the VIDEO 2 jacks

If you intend to connect video equipment that has composite/S video output jacks, such as a VCR, follow the instructions below. **Using a video signal cable (not supplied) and an audio cord (not supplied), connect the video equipment to the display's VIDEO 2 jacks.**

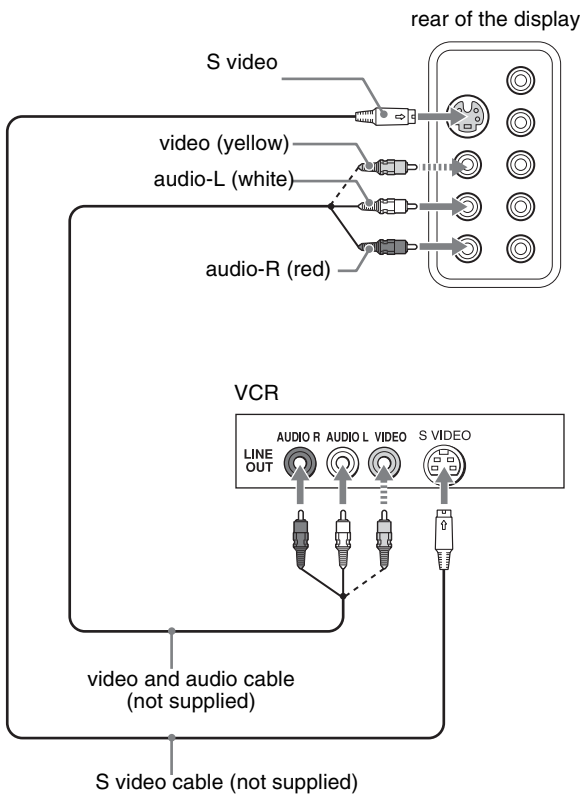

Note

When you connect video equipment to both composite video input and S video input jacks, the signal from the S video jack is displayed.

■ Connecting an antenna

If you intend to connect an antenna to receive the TV signal, follow the instructions below.

Using the 75-ohm coaxial cable (supplied), connect an antenna to the display's VHF/UHF jack.

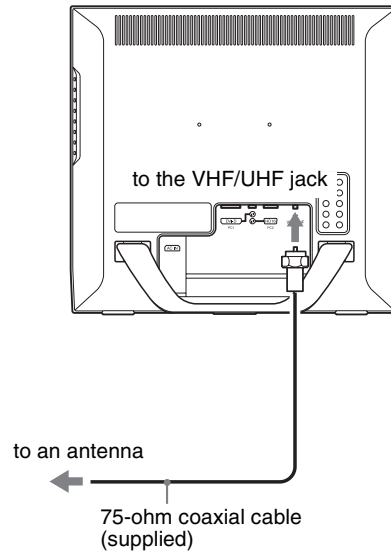

Note

It is strongly recommended that you connect the antenna using a 75-ohm coaxial cable to get optimum picture quality. A 300-ohm twin lead cable can be easily affected by radio noise and the like, resulting in signal deterioration. If you use a 300-ohm twin lead cable, keep it away as far as possible from the display.

US

Setup 3: Connect the power cord

- 1 Connect the supplied power cord securely to the display's AC IN connector.
- 2 Connect the other end securely to a power outlet.

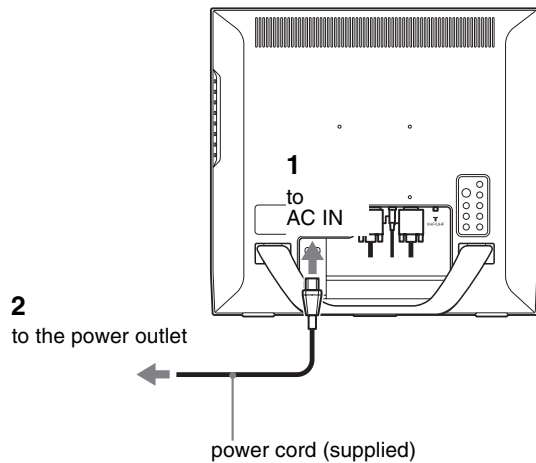

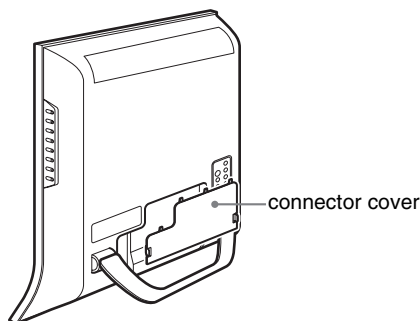

Setup 4: Replace the connector cover

While pressing the hooks, push the connector cover onto the display until it clicks.





Setup 5: Turn on the display and other equipment

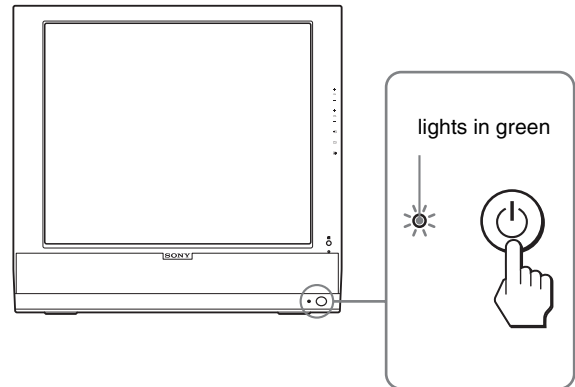

- 1 Press the  (power) switch on the front of the display.
The  (power) indicator lights up in green.

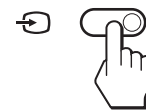



- 2 Turn on the computer or other video equipment.
- 3 Press the  button to select the desired input signal.



The input signal will change each time you press the  button.

On-screen message	Input signal configuration
DVI-D: PC 1	DVI-D input connector (digital RGB) for PC 1
HD15: PC 2	HD15 input connector (analog RGB) for PC 2
TV channels	TV
 : VIDEO 1	Y/P _B /P _R Component Video input jacks for VIDEO 1
 or  : VIDEO 2	Composite/S video input jacks for VIDEO 2



Note

When using the PIP function, if you switch the input using the  button or input select buttons, the PIP function may be released. If it happens, the input source that you have selected fills the entire screen. To use the PIP function again, set the "PIP Setting" menu to "PIP On" using the menu system or select "PIP On" by pressing the  button (pages 15, 30).

Tips

- You can also select the inputs using the input select buttons on the remote control.
- When you select the TV input, the number of the selected channel is displayed in the upper right corner of the screen.
- When using the PIP function, use "Sub" in the "PIP" menu in the "Option" menu to select the input source for sub picture (page 30). If the TV input is selected for sub picture, you can change the channel using the CH +/- buttons.

If no picture appears on the screen

- Check that the power cord and the video signal cable are properly connected.
- If “No Input Signal” appears on the screen:
 - The computer is in the power saving mode. Try pressing any key on the keyboard or moving the mouse.
 - Check that the input signal setting is correct by pressing the  button (page 12).
- If “Cable Disconnected” appears on the screen:
 - Check that the video signal cable is properly connected.
 - Check that the input signal setting is correct by pressing the  button (page 12).
- If “Out of Range” appears on the screen, reconnect the old display. Then adjust the computer’s graphics board within the following ranges.

MFM-HT75W

	Analog RGB	Digital RGB
Horizontal frequency	28–69 kHz	28–48 kHz
Vertical frequency	48–85 Hz	60 Hz
Resolution	1280 × 768 or less	1280 × 768 or less

MFM-HT95

	Analog RGB	Digital RGB
Horizontal frequency	28–86 kHz	28–64 kHz
Vertical frequency	48–85 Hz ¹⁾	60 Hz
Resolution	1280 × 1024 or less	1280 × 1024 or less

¹⁾ If the resolution is 1280 × 1024, the vertical frequency should be in the range of 48–75 Hz.

For more information about on-screen messages, see “Trouble symptoms and remedies” on page 38.

No need for specific drivers

The display complies with the “DDC” Plug & Play standard and automatically detects all the display’s information. No specific driver needs to be installed on the computer.

The first time you turn on your computer after connecting the display, the setup Wizard may appear on the screen. In this case, follow the on-screen instructions. The Plug & Play display is automatically selected so that you can use this display.

The vertical frequency is set to 60 Hz.

Since flickers are unobtrusive on the display, you can use it as it is. You do not need to set the vertical frequency to any particular high value.

Setup 6: Adjust the tilt

This display can be adjusted within the angles shown below.

Grasp the sides of the LCD panel, then adjust the screen angles.

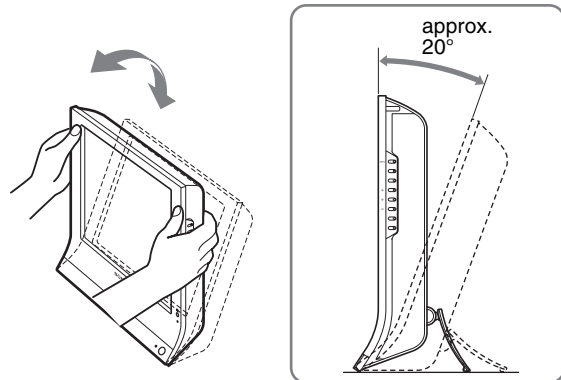

To use the display comfortably

Adjust the viewing angle of your display according to the height of your desk and chair so that light is not reflected from the screen to your eyes.

Notes

- When adjusting the screen tilt, proceed slowly and carefully, being sure not to hit the display against the desk.
- When adjusting the screen tilt, make sure not to knock or drop the display off the desk.

Setup 7: Insert batteries into the remote control

Insert two size AAA batteries (supplied) by matching the + and – marks on the batteries to the diagram inside the remote control’s battery compartment.

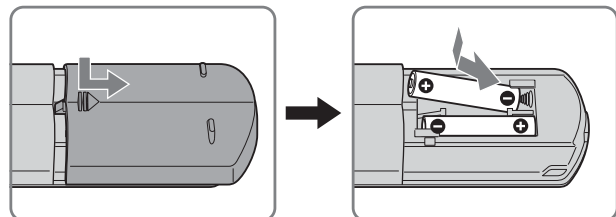

Notes

- Remove the batteries to avoid damage from possible battery leakage whenever you anticipate that the remote control will not be used for an extended period.
- Handle the remote control with care. Avoid dropping it, getting it wet, or placing it in direct sunlight, near a heater or where the humidity is high.

US

Watching the TV

Setting the TV channels

To watch TV programs, you need to run “Auto Program” to set up your channels.

Perform the following “Auto Program” procedure before you watch TV programs for the first time.

For details on the use of the menu and buttons, see “Navigating the menu” on page 15.

- 1 Press the MENU button.**
- 2 Press the ↑/↓ buttons to select  (Channel) and press the OK button.**
The “Channel” menu appears on the screen.
- 3 Press the ↑/↓ buttons to select “Auto Program” and press the OK button.**
The “Auto Program” menu appears on the screen.
- 4 Press the ↑/↓ buttons to select “OK” and press the OK button.**
The display starts scanning and preparing channels automatically.
Channel number and on-screen message appear.
- 5 Press the MENU button to exit the menu screen after Auto Program is completed.**

Changing the TV channel

Press the 0-9 buttons to input a channel number.

The channel changes after 3 seconds. Press the ENT (enter) button to select immediately.

Use the CH +/- buttons to scan through the channels.

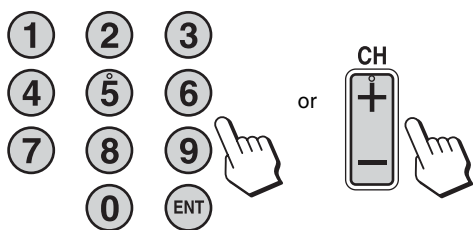

Tip

When you press and hold the CH + or – button, the channel number will change rapidly.

Skipping unnecessary channels

You can skip unnecessary channels when selecting channels using the CH +/- button.

- 1 Press the MENU button.**
- 2 Press the ↑/↓ buttons to select  (Channel) and press the OK button.**
The “Channel” menu appears on the screen.
- 3 Press the ↑/↓ buttons to select “Channel Skip/Add” and press the OK button.**
The “Channel Skip/Add” menu appears on the screen.
- 4 Press the ↑/↓ buttons to select the channel you want to skip and press the OK button.**
Tip
To scroll through the list, press and hold the ↑/↓ buttons.
- 5 Press the ↑/↓ buttons to select “Skip” and press the OK button.**
If you want to restore skipped channel, select “Add.”
- 6 Press the MENU button to exit the menu screen.**

Choosing between cable and UHF/VHF

To set the UHF/VHF channels, you need to set the “Cable” menu to “Off” by following the instructions below.

- 1 Press the MENU button.**
- 2 Press the ↑/↓ buttons to select  (Channel) and press the OK button.**
The “Channel” menu appears on the screen.
- 3 Press the ↑/↓ buttons to select “Cable” and press the OK button.**
The “Cable” menu appears on the screen.
- 4 Press the ↑/↓ buttons to select the desired mode and press the OK button.**
 - On: The cable TV channels can be set.
 - Off: The UHF/VHF channels can be set.

Note

You cannot set and receive cable TV channels and UHF/VHF channels at the same time.

Using other features

You can also use the following TV features.



■ Watching TV programs with closed captions

Set "Caption Vision" in the "Option" menu to "On." For details, see "Setting "Caption Vision" (for TV/VIDEO 1/VIDEO 2 only)" on page 32.



■ Using the Parental Control feature

Select control options in the "Parent" menu. For details, see "Parent menu" on page 25.

Button operations (remote control)

Press	To
MUTING	Turn off the sound. Press it again or press VOL+ to restore sound (page 34).
DISPLAY	Display the current channel number. Press it again to turn the display off.
JUMP	Jump back and forth between two channels. The display alternates between the current channel and the last channel.
SLEEP	Turn off the display automatically after a specified period of time (page 36).
	Switch the Picture Mode (page 35).
	Switch the "PIP" setting. Each time you press this button, the setting changes as follows. PIP On → PIP Off → PIP On...(page 30).
	Switch the "Zoom" setting. Each time you press this button, the setting changes as follows. MFM-HT75W: Normal → Full → Wide Zoom → Zoom → Normal... MFM-HT95: Normal → Full → 16:9 → Normal... (page 22)

Tip

The  and  buttons are also available on the display.

Customizing Your Display

Before making adjustments

Connect the display and equipment, then turn them on. For the best results, wait for at least 30 minutes before making adjustments.

You can make numerous adjustments to your display using the on-screen menu.

Navigating the menu



■ When you use the buttons on the display

1 Display the main menu.

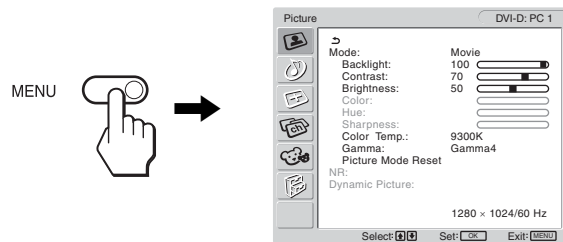
Press the MENU button to display the main menu on the screen.



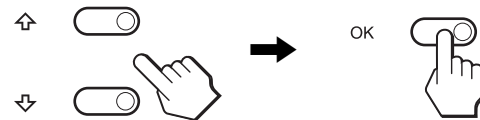

2 Select the menu.

Press the / buttons to display the desired menu. Press the OK button to move to the first menu item.



3 Select the item you want to adjust.

Press the / buttons to select the item you want to adjust, then press the OK button.

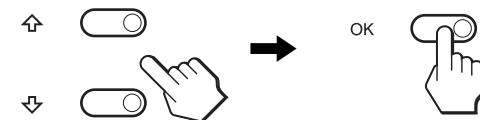

If is one of the menu items.

When you select  and press the OK button, the display returns to the previous menu.

US

4 Adjust the item.

Press the \uparrow/\downarrow buttons to make the adjustment, then press the OK button.

When you press the OK button, the setting is stored, then the display returns to the previous menu.

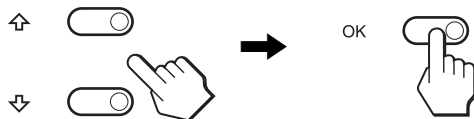

5 Close the menu.

Press the MENU button once to return to normal viewing. If no buttons are pressed, the menu closes automatically after about 45 seconds.



■ When you use the buttons on the remote control

1 Display the main menu.

Press the MENU button to display the main menu on the screen.

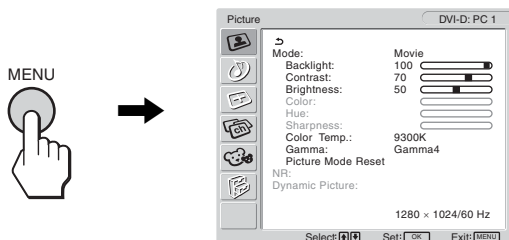

2 Select the menu.

Press the \uparrow/\downarrow buttons to display the desired menu. Press the OK button to move to the first menu item.

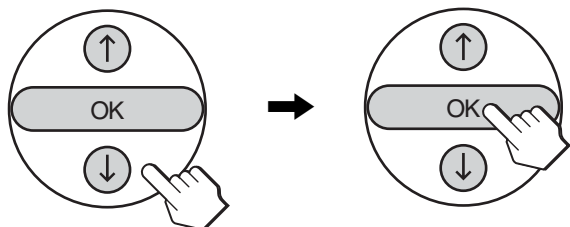

3 Select the item you want to adjust.

Press the \uparrow/\downarrow buttons to select the item you want to adjust, then press the OK button.

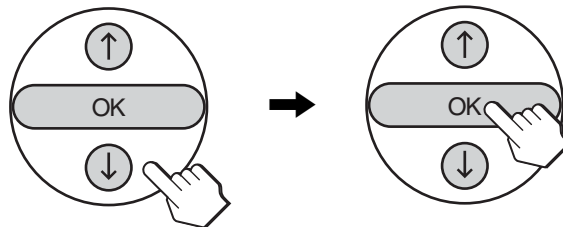

If \curvearrowright is one of the menu items.

When you select \curvearrowright and press the OK button, the display returns to the previous menu.

4 Adjust the item.

Press the \uparrow/\downarrow buttons to make the adjustment, then press the OK button.

When you press the OK button, the setting is stored, then the display returns to the previous menu.

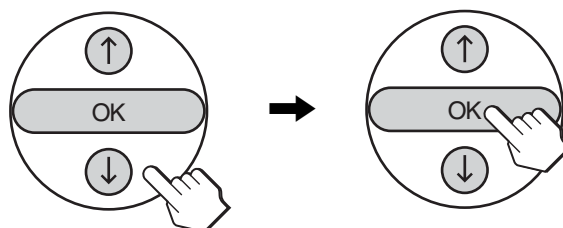

5 Close the menu.

Press the MENU button once to return to normal viewing. If no buttons are pressed, the menu closes automatically after about 45 seconds.



■ Resetting the adjustments to the default settings

You can reset the adjustments using the "All Reset" menu. For more information about resetting the adjustments, see "Resetting to the default setting" on page 33.

Picture menu

You can adjust the following items using the “Picture” menu.

- Mode
 - Backlight
 - Contrast (Picture)
 - Brightness
 - Color
 - Hue
 - Sharpness
 - Color Temp.
 - Gamma
 - Picture Mode Reset
- NR
- Dynamic Picture

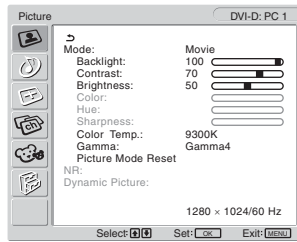

Tip

The “Backlight,” “Contrast,” “Brightness,” “Color,” “Hue,” “Sharpness,” “Color Temp.,” and “Gamma” menus can be set for each Picture mode. Also, Picture Mode can be set for each available input.

■ Selecting the Picture Mode for PC 1/PC 2

You can select the appropriate screen brightness for your purpose.

- 1 Press the MENU button.**
The main menu appears on the screen.
- 2 Press the ↑/↓ buttons to select  (Picture) and press the OK button.**
The “Picture” menu appears on the screen.
- 3 Press the ↑/↓ buttons to select “Mode” and press the OK button.**
The “Mode” menu appears on the screen.

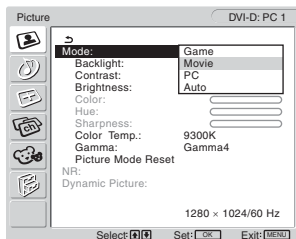

- 4 Press the ↑/↓ buttons to select the desired mode and press the OK button.**
The default setting is “Movie.”
 - Game: Bright picture.
 - Movie: Clear picture with strong contrast.
 - PC: Soft tone picture.
 - Auto: Automatically adjusts the screen brightness according to the brightness of the surroundings (automatic brightness adjustment function). For more information, see “Automatic brightness adjustment function (light sensor)” on page 35.

Note

When the Picture Mode is set to “Auto,” you cannot adjust the backlight.

■ Selecting the Picture Mode for TV/VIDEO 1/VIDEO 2

You can select the appropriate screen brightness for your purpose.

- 1 Press the MENU button.**
The main menu appears on the screen.
- 2 Press the ↑/↓ buttons to select  (Picture) and press the OK button.**
The “Picture” menu appears on the screen.
- 3 Press the ↑/↓ buttons to select “Mode” and press the OK button.**
The “Mode” menu appears on the screen.

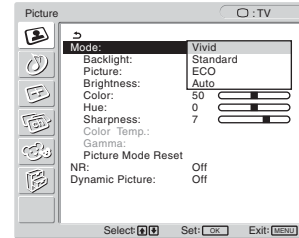

- 4 Press the ↑/↓ buttons to select the desired mode and press the OK button.**
The default setting is “Vivid.”
 - Vivid: Picture with enhanced contrast and sharpness.
 - Standard: Picture with contrast that suits the room light.
 - ECO: Picture with low brightness.
 - Auto: Automatically adjusts the screen brightness according to the brightness of the surroundings (automatic brightness adjustment function). For more information, see “Automatic brightness adjustment function (light sensor)” on page 35.

Note

When the Picture Mode is set to “Auto,” you cannot adjust the backlight.

US

■ Adjusting “Backlight”

If the screen is too bright, adjust the backlight to make the screen easier to see.

- 1 Press the MENU button.**
The main menu appears on the screen.
- 2 Press the ↑/↓ buttons to select  (Picture) and press the OK button.**
The “Picture” menu appears on the screen.
- 3 Press the ↑/↓ buttons to select “Backlight” and press the OK button.**
The “Backlight” menu appears on the screen.
- 4 Press the ↑/↓ buttons to adjust the light level and press the OK button.**

■ Adjusting “Contrast” (“Picture”)

You can adjust the picture contrast. The “Contrast” menu is available only for the PC 1 or PC 2 input. When you select the VIDEO 1, VIDEO 2, or TV input, the “Picture” menu is available instead.

- 1 Press the MENU button.**
The main menu appears on the screen.
- 2 Press the ↑/↓ buttons to select  (Picture) and press the OK button.**
The “Picture” menu appears on the screen.
- 3 Press the ↑/↓ buttons to select “Contrast” (“Picture”) and press the OK button.**
The “Contrast” (“Picture”) menu appears on the screen.
- 4 Press the ↑/↓ buttons to adjust the contrast and press the OK button.**

■ Adjusting “Brightness”

You can adjust the picture brightness (black level).

- 1 Press the MENU button.**
The main menu appears on the screen.
- 2 Press the ↑/↓ buttons to select  (Picture) and press the OK button.**
The “Picture” menu appears on the screen.
- 3 Press the ↑/↓ buttons to select “Brightness” and press the OK button.**
The “Brightness” menu appears on the screen.
- 4 Press the ↑/↓ buttons to adjust the brightness and press the OK button.**

■ Adjusting “Color” (for TV/VIDEO 1/VIDEO 2 only)

You can change the color intensity of the picture displayed.

- 1 Press the MENU button.**
The main menu appears on the screen.
- 2 Press the ↑/↓ buttons to select  (Picture) and press the OK button.**
The “Picture” menu appears on the screen.
- 3 Press the ↑/↓ buttons to select “Color” and press the OK button.**
The “Color” menu appears on the screen.
- 4 Press the ↑/↓ buttons to adjust the color intensity and press the OK button.**

■ Adjusting “Hue” (for TV/VIDEO 2 only)

You can change the color tones of the picture displayed.

- 1 Press the MENU button.**
The main menu appears on the screen.
- 2 Press the ↑/↓ buttons to select  (Picture) and press the OK button.**
The “Picture” menu appears on the screen.
- 3 Press the ↑/↓ buttons to select “Hue” and press the OK button.**
The “Hue” menu appears on the screen.
- 4 Press the ↑/↓ buttons to adjust the hue and press the OK button.**

■ Adjusting “Sharpness” (for TV/VIDEO 1/VIDEO 2 only)

You can adjust the sharpness of the edges of images, etc.

- 1 Press the MENU button.**
The main menu appears on the screen.
- 2 Press the ↑/↓ buttons to select  (Picture) and press the OK button.**
The “Picture” menu appears on the screen.
- 3 Press the ↑/↓ buttons to select “Sharpness” and press the OK button.**
The “Sharpness” menu appears on the screen.
- 4 Press the ↑/↓ buttons to adjust the sharpness and press the OK button.**

Note

If the input from VIDEO 1 is selected and the video signal being input is 1080i format, “Sharpness” is unavailable.

■ Adjusting “Color Temp.” (for PC 1/PC 2 only)

You can select the picture’s color level for the white color field from the default color temperature settings.

Also, if necessary, you can fine tune the color temperature.

1 Press the MENU button.

The main menu appears on the screen.

2 Press the ↑/↓ buttons to select (Picture) and press the OK button.

The “Picture” menu appears on the screen.

3 Press the ↑/↓ buttons to select “Color Temp.” and press the OK button.

The “Color Temp.” menu appears on the screen.

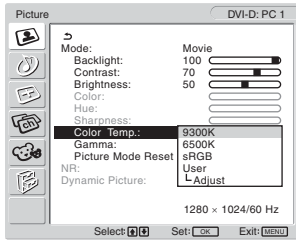

4 Press the ↑/↓ buttons to select the desired color temperature and press the OK button.

White balance changes from bluish to reddish as the color temperature is adjusted from 9300K to 6500K.

When you select “sRGB,” the colors adjust to the sRGB profile. (The sRGB color setting is an industry-standard color space protocol designed for computer products.) If you select “sRGB,” the color settings of your computer must be set to the sRGB profile.

Notes

- If a connected computer or other equipment is not sRGB-compliant, color cannot be adjusted to the sRGB profile.
- You cannot select “sRGB” when the Picture Mode is set to “Auto.”
- If you select “sRGB,” you cannot adjust “Contrast” and “Brightness” in the “Picture” menu. Also, you cannot adjust “Gamma.”

Fine tuning the color temperature

1 Press the MENU button.

The main menu appears on the screen.

2 Press the ↑/↓ buttons to select (Picture) and press the OK button.

The “Picture” menu appears on the screen.

3 Press the ↑/↓ buttons to select “Color Temp.” and press the OK button.

The “Color Temp.” menu appears on the screen.

4 Press the ↑/↓ buttons to select “Adjust” and press the OK button.

The fine tuning menu for color temperature appears on the screen.

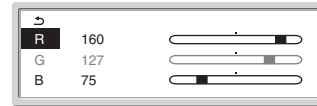

5 Press the ↑/↓ buttons to select R (Red) or B (Blue) and press the OK button. Then press the ↑/↓ buttons to adjust the color temperature and press the OK button.

Since this adjustment changes the color temperature by increasing or decreasing the R and B components with respect to G (green), the G component is fixed.

6 Press the ↑/↓ buttons to select , then press the OK button.

The new color setting is stored in memory and automatically recalled whenever “User” is selected.

The “Color Temp.” menu appears on the screen.

■ Adjusting “Gamma” (for PC 1/PC 2 only)

You can associate the picture’s color shade on the screen with the picture’s original color shade.

1 Press the MENU button.

The main menu appears on the screen.

2 Press the ↑/↓ buttons to select (Picture) and press the OK button.

The “Picture” menu appears on the screen.

3 Press the ↑/↓ buttons to select “Gamma” and press the OK button.

The “Gamma” menu appears on the screen.

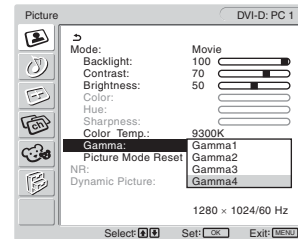

4 Press the ↑/↓ buttons to select the desired mode and press the OK button.

US

■ Resetting Picture Mode to the default

You can reset the adjustments to the default settings.

1 Press the MENU button.

The main menu appears on the screen.

2 Press the ↑/↓ buttons to select (Picture) and press the OK button.

The “Picture” menu appears on the screen.

3 Press the ↑/↓ buttons to select “Picture Mode Reset” and press the OK button.

The “Picture Mode Reset” menu appears on the screen.

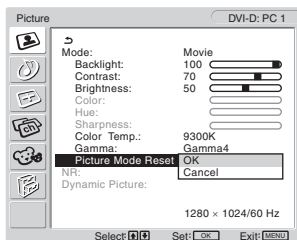

4 Press the ↑/↓ buttons to select the desired mode and press the OK button.

- OK: To reset the all items in the current Picture Mode to the default.
- Cancel: To cancel resetting and return to the “Picture” menu.

■ Setting “NR” (for TV/VIDEO 1/VIDEO 2 only)

You can set the noise reduction function to on or off.

This feature can be set for each available input.

1 Press the MENU button.

The main menu appears on the screen.

2 Press the ↑/↓ buttons to select (Picture) and press the OK button.

The “Picture” menu appears on the screen.

3 Press the ↑/↓ buttons to select “NR” and press the OK button.

The “NR” menu appears on the screen.

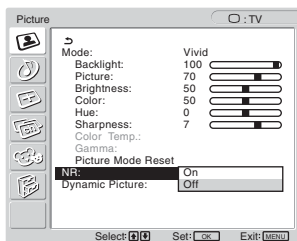

4 Press the ↑/↓ buttons to select the desired mode and press the OK button.

- On: The noise level is reduced.
- Off: The noise reduction function is turned off.

■ Setting “Dynamic Picture” (for TV/VIDEO 1/VIDEO 2 only)

You can set the “Dynamic Picture” function to on or off.

This feature can be set for each available input.

1 Press the MENU button.

The main menu appears on the screen.

2 Press the ↑/↓ buttons to select (Picture) and press the OK button.

The “Picture” menu appears on the screen.

3 Press the ↑/↓ buttons to select “Dynamic Picture” and press the OK button.

The “Dynamic Picture” menu appears on the screen.

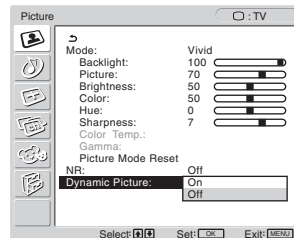

4 Press the ↑/↓ buttons to select the desired mode and press the OK button.

- On: The picture contrast is enhanced.
- Off: The “Dynamic Picture” function is turned off.

Audio menu

You can adjust the following items using the “Audio” menu. The items in the “Audio” menu can be set for each available input.

- Surround
- Treble
- Bass
- Balance
- Auto Volume
- MTS
- Audio Reset

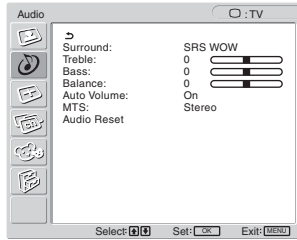

Setting “Surround”

- 1 Press the MENU button.**
The main menu appears on the screen.
- 2 Press the ↑/↓ buttons to select  (Audio) and press the OK button.**
The “Audio” menu appears on the screen.
- 3 Press the ↑/↓ buttons to select “Surround” and press the OK button.**
The “Surround” menu appears on the screen.

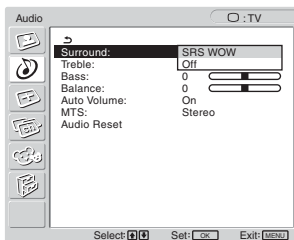

- 4 Press the ↑/↓ buttons to select the desired mode and press the OK button.**
 - SRS WOW: Deep rich bass tone and clear high tone creates a rich surround sound experience, and movies and games, especially, can be enjoyed with powerful sound.
 - Off: Turns off the SRS WOW effect.

Adopting the latest technology developed by SRS Labs, Inc., SRS WOW significantly improves the sound quality of various audio sources.

Adjusting “Treble,” “Bass,” and “Balance”

- 1 Press the MENU button.**
The main menu appears on the screen.
- 2 Press the ↑/↓ buttons to select  (Audio) and press the OK button.**
The “Audio” menu appears on the screen.
- 3 Press the ↑/↓ buttons to select “Treble,” “Bass,” or “Balance” and press the OK button.**
- 4 Press the ↑/↓ buttons to adjust the level and press the OK button.**

Setting “Auto Volume” (for TV/VIDEO 1/VIDEO 2 only)

You can set the loudness of the sound to keep it at a specified level.

- 1 Press the MENU button.**
The main menu appears on the screen.
- 2 Press the ↑/↓ buttons to select  (Audio) and press the OK button.**
The “Audio” menu appears on the screen.
- 3 Press the ↑/↓ buttons to select “Auto Volume” and press the OK button.**
The “Auto Volume” menu appears on the screen.

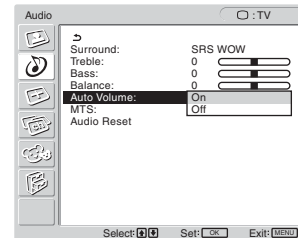

- 4 Press the ↑/↓ buttons to select the desired mode and press the OK button.**
 - On: Loudness of the sound stays at the specified level, independent of the broadcast signal (e.g. in the case of advertisements).
 - Off: Loudness of the sound changes automatically according to the broadcast signal.

US

■ Setting “MTS” (for TV only)

You can enjoy stereo, bilingual, and monaural programs.

1 Press the MENU button.

The main menu appears on the screen.

2 Press the ↑/↓ buttons to select (Audio) and press the OK button.

The “Audio” menu appears on the screen.

3 Press the ↑/↓ buttons to select “MTS” and press the OK button.

The “MTS” menu appears on the screen.

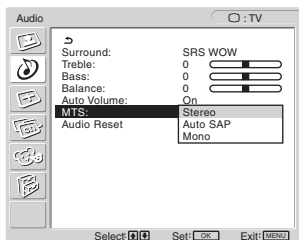

4 Press the ↑/↓ buttons to select the desired mode and press the OK button.

- Stereo: Stereo sound is output when viewing a program broadcast in stereo.
- Auto SAP: A second audio program channel is output automatically when a signal received. (If no SAP signal is present, the display remains in stereo mode.)
- Mono: Monaural sound is output. (Use to reduce noise during weak stereo broadcasts.)

■ Resetting all audio settings to the default

You can reset the adjustments to the default settings.

1 Press the MENU button.

The main menu appears on the screen.

2 Press the ↑/↓ buttons to select (Audio) and press the OK button.

The “Audio” menu appears on the screen.

3 Press the ↑/↓ buttons to select “Audio Reset” and press the OK button.

The “Audio Reset” menu appears on the screen.

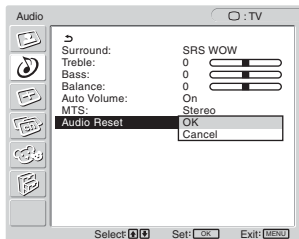

4 Press the ↑/↓ buttons to select the desired mode and press the OK button.

- OK: To reset the all items in the “Audio” menu to the default.
- Cancel: To cancel resetting and return to the “Audio” menu.

Screen menu

You can adjust the following items using the “Screen” menu.

- Zoom
- Auto Adjust
- Phase
- Pitch
- H Center
- V Center

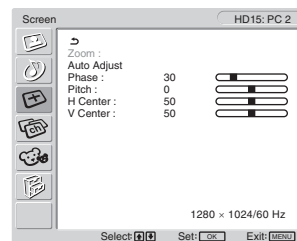

■ Setting “Zoom”

This feature lets you watch 4:3 normal broadcasts or other picture sizes such as Letter box movies in several “Zoom” modes. A “Zoom” value is set for each available input.

Tip

You can also switch the “Zoom” setting by pressing the  button on the remote control repeatedly.

1 Press the MENU button.

The main menu appears on the screen.

2 Press the ↑/↓ buttons to select (Screen) and press the OK button.

The “Screen” menu appears on the screen.

3 Press the ↑/↓ buttons to select “Zoom” and press the OK button.

The “Zoom” menu appears on the screen.

MFM-HT75W

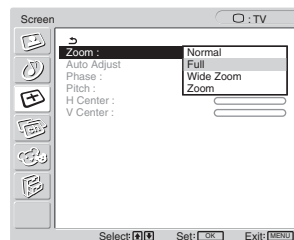

MFM-HT95

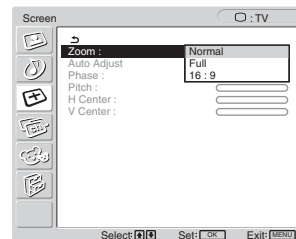

- 4 Press the **↑/↓** buttons to select the desired mode and press the **OK** button.

For the MFM-HT75W

- Normal: Original size.
- Full: A picture is enlarged horizontally (linear) to fill the 15:9 screen. Useful for viewing Squeeze signal.
- Wide Zoom: A picture is enlarged horizontally (non-linear) to fill the 15:9 screen, keeping the original image as much as possible.
- Zoom: A picture is enlarged horizontally and vertically to an equal aspect ratio that fills a 15:9 screen. Useful for viewing Letter Box signal.

Notes

- If the input from either PC 1 or PC 2 is selected, “Zoom” and “Wide Zoom” are unavailable.
- If the input from VIDEO 1 is selected and the video signal being input is 1080i format, “Wide Zoom” is unavailable.

For the MFM-HT95

- Normal: Original size.
- Full: A picture is enlarged horizontally (linear) to fill the 5:4 screen. Useful for viewing 4:3 signal or Letter Box signal.
- 16:9: A picture is squeezed horizontally to an equal aspect ratio that fills the 5:4 screen. Useful for viewing Squeeze signal.

Notes

- If the input from either PC 1 or PC 2 is selected, all three options are unavailable.
- If the input from VIDEO 1 is selected and the video signal being input is either 1080i, 1035i, or 720p format, “16:9” and “Full” are unavailable.

Tip

When the picture that looks like as illustrated below is displayed, even if the input from VIDEO 1 selected and the video signal being input is either 1080i or 720p format, “Full” is available.

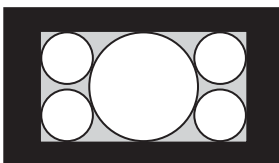

■ Automatic picture quality adjustment function (for PC 2 only)

When the display receives an input signal, it automatically adjusts the picture’s position and sharpness (phase/pitch), and ensures that a clear picture appears on the screen (page 35).

Note

While the automatic picture quality adjustment function is activated, only the **⏻** (power) switch will operate.

If the automatic picture quality adjustment function of this display seems to not completely adjust the picture

You can make further automatic adjustment of the picture quality for the current input signal (See “Auto Adjust” below).

If you still need to make further adjustments to the picture quality

You can manually adjust the picture’s sharpness (phase/pitch) and position (horizontal/vertical position).

These adjustments are stored in memory and automatically recalled when the display receives a previously input and registered input signal.

■ Making further automatic adjustments to the picture quality for the current input signal (Auto Adjust) (for PC 2 only)

- 1 Press the **MENU** button.

The main menu appears on the screen.

- 2 Press the **↑/↓** buttons to select **⊕** (Screen) and press the **OK** button.

The “Screen” menu appears on the screen.

- 3 Press the **↑/↓** buttons to select “Auto Adjust” and press the **OK** button.

Make the appropriate adjustments of the screen’s phase, pitch and horizontal/vertical position for the current input signal and store them.

■ Adjusting the picture's sharpness manually (Phase/Pitch) (for PC 2 only)

You can adjust the picture's sharpness as follows.

- 1 **Set the resolution to 1280 × 768 (MFM-HT75W), or 1280 × 1024 (MFM-HT95) on the computer.**
- 2 **Load the CD-ROM.**
- 3 **Start the CD-ROM, select the area and model, and display the test pattern.**
For Windows
Click [Utility] → [Windows]/[Win Utility.exe].
For Macintosh
Click [Utility] → [Mac]/[Mac Utility].
- 4 **Press the MENU button.**
The main menu appears on the screen.
- 5 **Press the ↑/↓ buttons to select  (Screen) and press the OK button.**
The "Screen" menu appears on the screen.
- 6 **Press the ↑/↓ buttons to select "Phase" and press the OK button.**
The "Phase" adjustment menu appears on the screen.
- 7 **Press the ↑/↓ buttons until the horizontal stripes are at a minimum.**
Adjust so that the horizontal stripes are at a minimum.

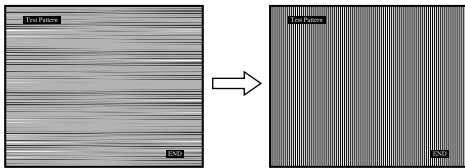

- 8 **Press the OK button.**
The main menu appears on the screen.
If vertical stripes are observed over the entire screen, adjust the pitch using the following procedures.
- 9 **Press the ↑/↓ buttons to select "Pitch" and press the OK button.**
The "Pitch" adjustment menu appears on the screen.
- 10 **Press the ↑/↓ buttons until the vertical stripes disappear.**
Adjust so that the vertical stripes disappear.

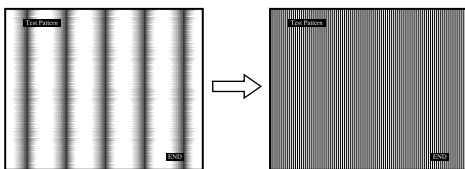

- 11 **Click [END] on the screen to turn off the test pattern.**

■ Adjusting the picture's position manually (H Center /V Center) (for PC 2 only)

If the picture is not in the center of the screen, adjust the picture's centering as follows.

- 1 **Set the resolution to 1280 × 768 (MFM-HT75W), or 1280 × 1024 (MFM-HT95) on the computer.**
- 2 **Load the CD-ROM.**
- 3 **Start the CD-ROM, select the area and model, and display the test pattern.**
For Windows
Click [Utility] → [Windows]/[Win Utility.exe].
For Macintosh
Click [Utility] → [Mac]/[Mac Utility].
- 4 **Press the MENU button.**
The main menu appears on the screen.
- 5 **Press the ↑/↓ buttons to select  (Screen) and press the OK button.**
The "Screen" menu appears on the screen.
- 6 **Press the ↑/↓ buttons to select "H Center" or "V Center" and press the OK button.**
The "H Center" adjustment menu or "V Center" adjustment menu appears on the screen.
- 7 **Press the ↑/↓ buttons to center the test pattern on the screen.**
- 8 **Click [END] on the screen to turn off the test pattern.**

Parent menu

TV programs and movies shown on TV are given a rating signal based on the following rating systems.

In the U.S.A.: U.S. Television Parental Guidelines to rate television programs (U.S. TV ratings), and Motion Picture Association of America (MPAA) Guidelines to rate movies including those shown on TV (movie ratings).

In Canada: Canadian English Language ratings to rate television programs in English, and Canadian French Language ratings to rate those in French.

To block programs you feel unsuitable for your children, you need to set the display for the desired rating systems. Sony's predetermined ratings are also available. See page 28 for a description of the ratings.

The TV's Parental Control feature functions by receiving the rating signal from your local broadcasting station or cable service provider.

■ Activating the Parental Control feature

- 1 Press the **MENU** button.
- 2 Press the **↑/↓** buttons to select **Parent** and press the **OK** button.

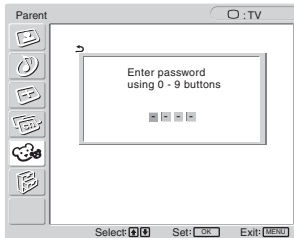

- 3 Enter a four-digit password using the **0-9** buttons. The "Parent" menu appears on the screen.

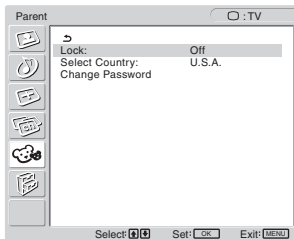

If you access the "Parent" menu for the first time, you are requested to enter the password again for confirmation.

Note

Do not enter "4357" corresponding to "HELP" on a phone number pad (see page 26).

Tips

- You need to enter the password here for any further access to the "Parent" menu. If you lose your password, see "Tip" on page 26.
- If you want to change the password, see page 25.

- 4 Press the **↑/↓** buttons to select "Select Country" and press the **OK** button.



- 5 Press the **↑/↓** buttons to select your country/region (U.S.A. or Canada) and press the **OK** button.
- 6 Press the **↑/↓** buttons to select "Lock" and press the **OK** button.

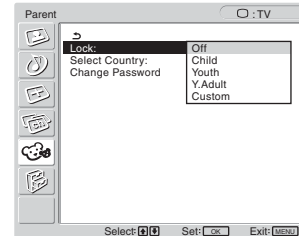

- 7 Press the **↑/↓** buttons to select a desired rating and press the **OK** button.

If you select "Child," "Youth," or "Y.Adult" (Young Adult), the level of Parental Control is activated automatically.

Tip

If you are not familiar with the Parental Guideline rating system, you should select "Child," "Youth," or "Y.Adult" to help simplify the rating selection. To set more restrictive ratings, select "Custom" (see "Selecting a Custom Rating" on page 26).

- 8 Press the **MENU** button to exit the menu screen.

To deactivate the Parental Control feature

Set "Lock" to "Off" in the "Parent" menu.

To change the password

- 1 Press the **MENU** button.
- 2 Press the **↑/↓** buttons to select **Parent** and press the **OK** button.
- 3 Enter your four-digit password using the **0-9** buttons. The "Parent" menu appears on the screen.
- 4 Press the **↑/↓** buttons to select "Change Password" then press the **OK** button.
- 5 Enter a new four-digit password using the **0-9** buttons.
- 6 Enter the password set in step 5 again to confirm.
- 7 Press the **MENU** button to exit the menu screen.

US

Tip

If you have forgotten your password, enter the master password “4357” (corresponding to “HELP” on a phone number pad) in step 3. You can then store a new password.



Notes

- If you entered “4357” as your password for the first time, you cannot store a new password (see step 3 of “Activating the Parental Control feature” on page 25).
- When you select a Parental Control program and the  indicator is displayed on the screen, you cannot view that program even if you enter “4357”.

■ Selecting a Custom Rating

If you want to select the ratings to be blocked from “Custom” once you have activated the Parental Control feature (page 25), follow the procedure below.

For a detailed description of each rating, see “What the Ratings Mean” on page 28.

- 1 **Perform steps 1 to 6 in “Activating the Parental Control feature” on page 25 to display the “Lock” menu.**
- 2 **Press the / buttons to select “Custom” and press the OK button.**

In the U.S.A.

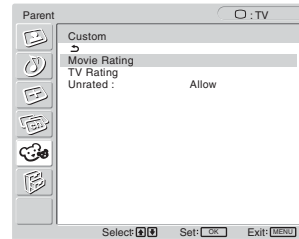

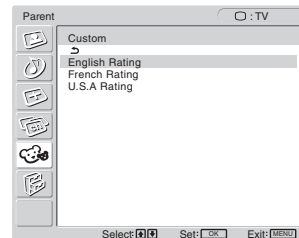

In Canada

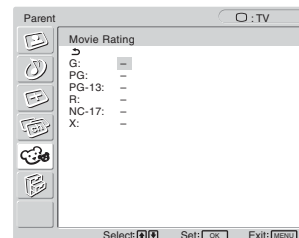

To select a rating in Canada, go to step 6.

- 3 **Press the / buttons to select “Movie Rating” and press the OK button.**





- 4 **Press the / buttons to select the rating to be blocked and press the OK button.**

The  indicator automatically appears beside the selected rating and all ratings below it, indicating that the programs that match the ratings will be blocked.

To unlock a rating, select  and press the OK button.

The  indicator changes to “-” and all ratings above it are unlocked.

- 5 **Press the / buttons to select  and press the OK button.**
- 6 **To select a TV rating in the U.S.A.:**

Press the **↑/↓** buttons to select “TV Rating” and press the OK button.

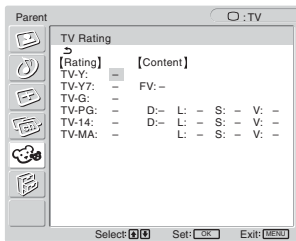

To select a TV rating in Canada:

Press the **↑/↓** buttons to select “English Rating,” “French Rating,” or “U.S.A. Rating” and press the OK button.

English Rating

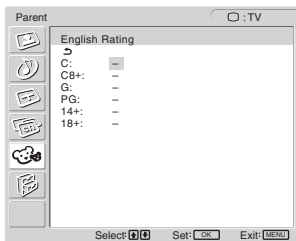

French Rating

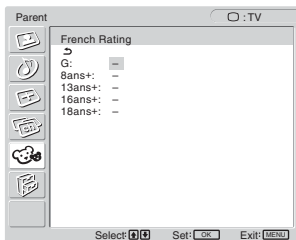

U.S.A. Rating

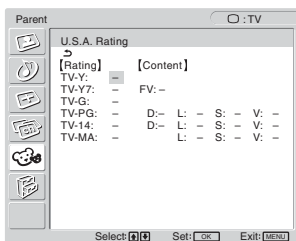

7 Press the **↑/↓ buttons to select the TV rating to be blocked and press the OK button.**

The **🔒** indicator automatically appears beside the selected rating and all ratings below it, indicating that the programs that match the ratings will be blocked.

Example: TV rating in the U.S.A.

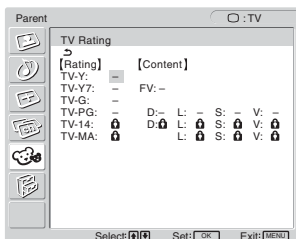

To unlock a rating, select **🔒** and press the OK button. The **🔒** indicator changes to “-” and all ratings above it are unlocked.

Some U.S. TV ratings have additional content ratings called “extenders.”

The extenders are defined as follows:

D (sexually suggestive Dialogue), FV (Fantasy Violence), L (coarse Language), S (Sexual situations) and V (Violence). By setting the extenders, you can define additional viewing limits.

For more details of extenders, see page 28.

All of the extenders included in the selected ratings will be blocked. If you want to allow any of them to be viewed, go to step 8. Otherwise, go to step 10.

8 Press the **↑/↓ buttons to select the extender to be viewed and press the OK button.**

“-” appears beside the selected extender, indicating that the programs that match the extender can be viewed.

To relock the canceled extender, select **🔒**.

The **🔒** indicator appears to show that the programs that match the extender will be blocked again.

9 Repeat step 8 for other extenders.

All programs that match the ratings you select and higher, except for the extenders that were canceled, will be blocked.

10 Press the MENU button to exit the menu screen.

To block programs or movies broadcast without a rating

The unrated option allows you to block programs or movies that are broadcast without a rating.

The unrated option is available only when you have selected “U.S.A.” as your country/region.

1 Perform steps 1 and 2 of “Selecting a Custom Rating” on page 26.

2 Press the **↑/↓ buttons to select “Unrated” and press the OK button.**

3 Press the **↑/↓ buttons to select “Block” and press the OK button.**

Option	Description
Allow	Allows programs and movies that are broadcast without a rating.
Block	Blocks all programs and movies that are broadcast without a rating.

4 Press the MENU button to exit the menu screen.

Note

If you choose to block unrated TV programs, be aware that the following types of programs may be blocked: programs broadcast from another country/region, emergency broadcasts, political programs, sports, news, public service announcements, religious programs, and weather.

US

■ What the Ratings Mean

Ratings in the U.S.A.

Sony's predetermined ratings

These are original ratings that Sony has predetermined based on the viewer's age. Each rating allows you to view certain programs, as follows:

Option	Description
Child	Suitable for children under the age of 7. Viewable U.S. movie ratings: G, NR, and N/A Viewable U.S. TV ratings: TV-Y, TV-G, and TV-NR
Youth	Suitable for children aged 7 and older. Viewable U.S. movie ratings: G, PG, NR, and N/A Viewable U.S. TV ratings: TV-Y, TV-Y7, TV-G, TV-PG, and TV-NR
Y.Adult (Young Adult)	Suitable for children aged 13 and older. Viewable U.S. movie ratings: G, PG, PG-13, NR, and N/A Viewable U.S. TV ratings: TV-Y, TV-Y7, TV-G, TV-PG, TV-14, and TV-NR

For descriptions of Child, Youth, and Y.Adult (Young Adult) ratings, see the following custom rating options.

U.S. movie ratings

U.S. movie ratings are for movies (including those shown on TV) rated according to the Motion Picture Association of America (MPAA) Guidelines.

Option	Description
G (General Audiences – All Ages Admitted)	In G-rated films no strong words are used, the violence is at a minimum, nudity and sex scenes are not present, nor is there any drug use.
PG (Parental Guidance Suggested – Some Material May Not Be Suitable For Children)	This is a film which may need to be monitored first by parents.
PG-13 (Parents Strongly Cautioned – Some Material May Be Inappropriate For Children Under 13)	Parents are alerted to be very careful about the attendance of their under-teenage children when viewing films with this rating.
R (Restricted – Under 17 Requires Accompanying Parent Or Adult Guardian)	This film includes hard language, tough violence, nudity, drug abuse or other elements of concern.
NC-17 or X (No One 17 And Under Admitted)	This is a film that most parents would consider not suitable for children aged 17 and under. There may be violence, sex, abhorrent behavior, drug abuse or other elements of concern.

U.S. TV ratings

U.S. TV ratings are for TV programs rated according to the U.S. Television Parental Guidelines.

Option	Description
TV-Y (All Children)	This program is designed for young children aged 2 – 6 and is appropriate for all children.
TV-Y7 (Directed to Older Children)	This program is designed for children aged 7 and older. Themes and elements in this program may include mild fantasy violence or slapstick violence, or may frighten children under the age of 7.
TV-G (General Audience)	Most parents would find this program suitable for all ages. It contains little or no violence, no strong language and little or no sexual dialogue or situations.
TV-PG (Parental Guidance Suggested)	This program contains some material that parents may find unsuitable for younger children.
TV-14 (Parents Strongly Cautioned)	This program contains some material that many parents would find unsuitable for children under the age of 14.
TV-MA (Mature Audience Only)	This program is specifically designed to be viewed by adults and therefore may be unsuitable for children under the age of 17.

About the extenders of U.S. TV ratings

TV-Y7, TV-PG, TV-14 and TV-MA ratings have additional content ratings called "extenders" to define additional viewing limits. The extenders are defined as follows:

Option	Description
FV (Fantasy Violence)	Programs containing cartoon violence occurring in TV-Y7 programs only.
D (sexually suggestive Dialogue)	Programs containing suggestive dialogue, or sexual innuendo.
L (coarse Language)	Programs containing coarse language.
S (Sexual situations)	Programs containing sexual content.
V (Violence)	Programs containing violence. There may be some profanity, violence or brief nudity in these programs.

Ratings in Canada

Sony's predetermined ratings

These are original ratings that Sony has predetermined based on the viewer's age. Each rating allows you to view certain programs, as follows:

Option	Description
Child	Suitable for children under the age of 8. Viewable Canadian English Language ratings: C and G Viewable Canadian French Language ratings: G Viewable U.S. TV ratings: TV-Y, TV-G, and TV-NR
Youth	Suitable for children aged 8 and older. Viewable Canadian English Language ratings: C, G, C8+, and PG Viewable Canadian French Language ratings: G and 8 ans+ Viewable U.S. TV ratings: TV-Y, TV-Y7, TV-G, TV-PG, and TV-NR
Y.Adult (Young Adult)	Suitable for children aged 14 and older. Viewable Canadian English Language ratings: C, G, C8+, PG, and 14+ Viewable Canadian French Language ratings: G, 8 ans+, and 13 ans+ Viewable U.S. TV ratings: TV-Y, TV-Y7, TV-G, TV-PG, TV-14, and TV-NR

For descriptions of Child, Youth, and Y.Adult (Young Adult) ratings, see the following custom rating options.

Canadian English Language ratings

The Canadian English Language ratings are for TV programs in English broadcast in Canada.

Option	Description
C (Programming intended for children under the age of 8)	There will be no realistic scenes of violence or no offensive language, nudity or sexual content. Careful attention is paid to themes, which could threaten children's sense of security and well-being.
C8+ (Programming generally considered acceptable for children aged 8 and older to watch on their own)	Violence will not be portrayed as the preferred, acceptable, or only way to resolve conflict; or children will not be encouraged to imitate dangerous acts which they may see on television. There will be no profanity, nudity or sexual content.
G (General Audience)	Will contain very little violence, either physical or verbal or emotional. There may be some inoffensive slang, no profanity and no nudity.
PG (Parental Guidance)	Programming intended for a general audience but which may not be suitable for younger children. Parents may consider some content inappropriate for unsupervised viewing by children aged 8 – 13.

Option	Description
14+ (Programming contains themes or content which may not be suitable for viewers under the age of 14)	Parents are strongly cautioned to exercise discretion in permitting viewing by pre-teens and early teens.
18+ (Adult)	May contain violence integral to the development of the plot, character or theme, intended for adult audiences. May contain graphic language and explicit portrayals of nudity and/or sex.

Canadian French Language ratings

The Canadian French Language ratings are for TV programs in French broadcast in Canada.

Option	Description
G (General)	Programming intended for audiences of all ages. Contains no violence, or the violence it contains is minimal or is depicted appropriately with humor or caricature or in an unrealistic manner.
8 ans+ (8+ General – Not recommended for young children)	Programming intended for a broad audience but contains light or occasional violence that could disturb young children. Viewing with an adult is recommended for young children (under the age of 8).
13 ans+ (Programming may not be suitable for children under the age of 13)	Viewing with an adult is strongly recommended for children under the age of 13.
16 ans+ (Programming is not suitable for children under the age of 16)	Contains frequent scenes of violence or intense violence.
18 ans+ (Programming restricted to adults)	Contains constant violence or scenes of extreme violence.

US

Option menu

You can adjust the following items using the “Option” menu.

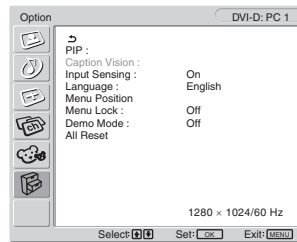

- PIP
- Caption Vision
- Input Sensing
- Language
- Menu Position
- Menu Lock
- Demo Mode
- All Reset



■ Setting “PIP” (Picture In Picture) (for PC 1 / PC 2 only)

When the “PIP Setting” menu is set to “PIP On,” pictures from two input sources are displayed on the screen at the same time. The main picture is displayed in full size, and the sub picture is displayed smaller in the corner of the screen. Also, you can choose either the sound from the main picture or the sub picture.





Notes

- When using the “PIP” function, if you switch the input using the  button or the input select buttons, the “PIP” function may be released. If it happens, the input source that you have selected fills the entire screen. To use the “PIP” function again, set the “PIP Setting” menu to “PIP On” using the menu system or select “PIP On” by pressing the  button (page 15).
- When the “Input Sensing” menu in the “Option” menu is set to “On,” if the computer that is selected for main picture input enters the power saving mode, the display try to detect a signal from the other computer input and display it, if available. At this time, the “PIP” function will be released. To use the “PIP” function again, set the “PIP Setting” menu to “PIP On” using the menu system or select “PIP On” by pressing the  button (page 15).

Tip

You can also switch the “PIP” setting by pressing the  button repeatedly.

To switch the PIP function on and off

- 1 Press the MENU button.**
The main menu appears on the screen.
- 2 Press the  buttons to select  (Option) and press the OK button.**
The “Option” menu appears on the screen.
- 3 Press the  buttons to select “PIP” and press the OK button.**
- 4 Press the  buttons to select “PIP Setting” and press the OK button.**



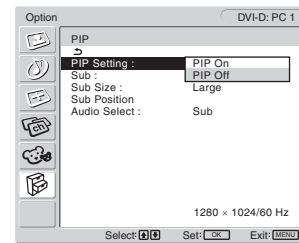



The “PIP Setting” menu appears on the screen.





- 5 Press the  buttons to select the desired mode and press the OK button.**

- PIP On: Pictures from two input sources are displayed on the screen. You can select the input for sub picture, the sub picture’s position, size, and audio input source.
- PIP Off: The “PIP” function is turned off.

To select the input for sub picture (PIP function: On)

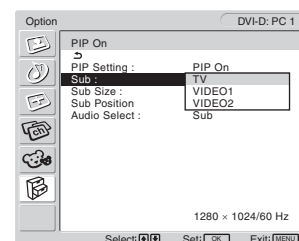
- 1 Press the MENU button.**
The main menu appears on the screen.
- 2 Press the  buttons to select  (Option) and press the OK button.**
The “Option” menu appears on the screen.
- 3 Press the  buttons to select “PIP” and press the OK button.**
- 4 Press the  buttons to select “PIP Setting” and press the OK button.**
The “PIP Setting” menu appears on the screen.
- 5 Press the  buttons to select “PIP On” and press the OK button.**
- 6 Press the  buttons to select “Sub” and press the OK button.**
The “Sub” menu appears on the screen.



- 7 Press the  buttons to select the desired input source and press the OK button.**
 - TV: A TV program is displayed in the sub-picture area.
 - VIDEO 1: The picture sent from the video equipment connected to the display’s video input jacks for VIDEO 1 is displayed in the sub-picture area.
 - VIDEO 2: The picture sent from the video equipment connected to the display’s video input jack for VIDEO 2 is displayed in the sub-picture area.

Note

The inputs for main/sub pictures must be selected as shown below.

Main	Sub
PC 1	TV
PC 2	VIDEO 1
	VIDEO 2

To change the sub picture's size (PIP function: On)

- 1 Press the MENU button.**
The main menu appears on the screen.
- 2 Press the ↑/↓ buttons to select  (Option) and press the OK button.**
The "Option" menu appears on the screen.
- 3 Press the ↑/↓ buttons to select "PIP" and press the OK button.**
- 4 Press the ↑/↓ buttons to select "PIP Setting" and press the OK button.**
The "PIP Setting" menu appears on the screen.
- 5 Press the ↑/↓ buttons to select "PIP On" and press the OK button.**
- 6 Press the ↑/↓ buttons to select "Sub Size" and press the OK button.**
The "Sub Size" menu appears on the screen.

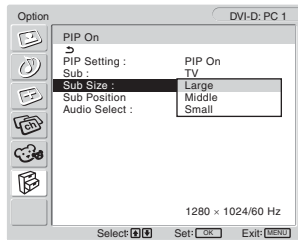

- 7 Press the ↑/↓ buttons to select the desired size and press the OK button.**
 - Large
 - Middle
 - Small

To change the sub picture's position (PIP function: On)

- 1 Press the MENU button.**
The main menu appears on the screen.
- 2 Press the ↑/↓ buttons to select  (Option) and press the OK button.**
The "Option" menu appears on the screen.
- 3 Press the ↑/↓ buttons to select "PIP" and press the OK button.**
- 4 Press the ↑/↓ buttons to select "PIP Setting" and press the OK button.**
The "PIP Setting" menu appears on the screen.
- 5 Press the ↑/↓ buttons to select "PIP On" and press the OK button.**

- 6 Press the ↑/↓ buttons to select "Sub Position" and press the OK button.**

The "Sub Position" menu appears on the screen.

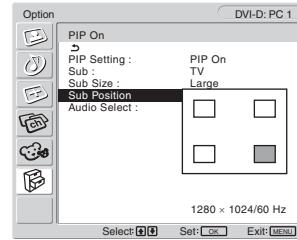

- 7 Press the ↑/↓ buttons to select the desired position and press the OK button.**

You can choose one of 4 positions for the sub picture.

To select the audio input source (PIP function: On)

- 1 Press the MENU button.**
The main menu appears on the screen.
- 2 Press the ↑/↓ buttons to select  (Option) and press the OK button.**
The "Option" menu appears on the screen.
- 3 Press the ↑/↓ buttons to select "PIP" and press the OK button.**
- 4 Press the ↑/↓ buttons to select "PIP Setting" and press the OK button.**
The "PIP Setting" menu appears on the screen.
- 5 Press the ↑/↓ buttons to select "PIP On" and press the OK button.**
- 6 Press the ↑/↓ buttons to select "Audio Select" and press the OK button.**
The "Audio Select" menu appears on the screen.

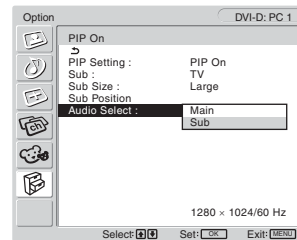

- 7 Press the ↑/↓ buttons to select the desired source and press the OK button.**

- Main: The sound from the input source selected for the main picture will be used.
- Sub: The sound from the input source selected in the "Sub" menu will be used.

Notes

- Volume should be adjusted on the connected computer or other equipment.
- If you set "PIP Setting" to "PIP On," "Audio Select" is set to "Sub" as the default.

Tip

If you select "Sub,"  is displayed in the upper left corner of the screen.

■ Setting “Caption Vision” (for TV/VIDEO 1/ VIDEO 2 only)

You can display Caption Vision if the broadcaster offers this service.

1 Press the MENU button.

The main menu appears on the screen.

2 Press the ↑/↓ buttons to select (Option) and press the OK button.

The “Option” menu appears on the screen.

3 Press the ↑/↓ buttons to select “Caption Vision” and press the OK button.

The “Caption Vision” menu appears on the screen.

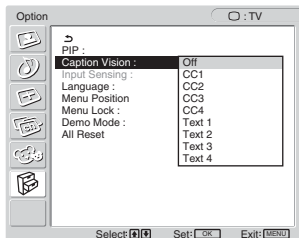

4 Press the ↑/↓ buttons to select the desired type of Caption Vision and press the OK button.

- Off: Caption Vision is turned off.
- CC1, CC2, CC3, CC4: A printed version of the dialogue or sound effects of a program is displayed. (CC1 is suitable for most programs.)
- Text1, Text2, Text3, Text4: Network/station information is presented using either half or the whole screen.

■ Setting “Input Sensing” (for PC 1/PC 2 only)

You can set the display to automatically detect an available input signal, and switches the input.

1 Press the MENU button.

The main menu appears on the screen.

2 Press the ↑/↓ buttons to select (Option) and press the OK button.

The “Option” menu appears on the screen.

3 Press the ↑/↓ buttons to select “Input Sensing” and press the OK button.

The “Input Sensing” menu appears on the screen.

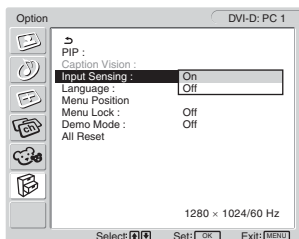

4 Press the ↑/↓ buttons to select either “On” or “Off” and press the OK button.

- On: When a signal from the selected input source drops off or you have selected the input that receives no

signal, the display try to detect a signal from the other computer input and display it, if available.

- Off: The display does not switch the input automatically. Press the  button or input select buttons to change the input.

■ Setting “Language”

1 Press the MENU button.

The main menu appears on the screen.

2 Press the ↑/↓ buttons to select (Option) and press the OK button.

The “Option” menu appears on the screen.

3 Press the ↑/↓ buttons to select “Language” and press the OK button.

The “Language” menu appears on the screen.

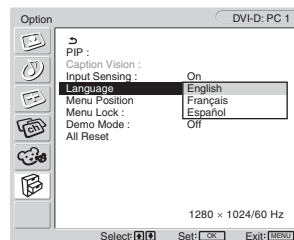

4 Press the ↑/↓ buttons to select a language and press the OK button.

- English
- Français: French
- Español: Spanish

■ Setting “Menu Position”

You can change the menu position if it is blocking an image on the screen.

1 Press the MENU button.

The main menu appears on the screen.

2 Press the ↑/↓ buttons to select (Option) and press the OK button.

The “Option” menu appears on the screen.

3 Press the ↑/↓ buttons to select “Menu Position” and press the OK button.

The “Menu Position” menu appears on the screen.

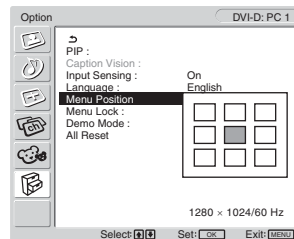

4 Press the ↑/↓ buttons to select the desired position and press the OK button.

You can choose one of 9 positions where the menu will appear.

■ Setting “Menu Lock”

You can lock in the menu adjustments to prevent accidental adjustments or resetting.

1 Press the MENU button.

The main menu appears on the screen.

2 Press the ↑/↓ buttons to select (Option) and press the OK button.



The “Option” menu appears on the screen.

3 Press the ↑/↓ buttons to select “Menu Lock” and press the OK button.

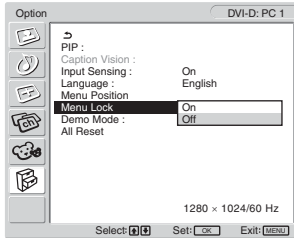
The “Menu Lock” menu appears on the screen.



4 Press the ↑/↓ buttons to select either “On” or “Off” and press the OK button.

- On: If “On” has been selected, when you attempt to operate the MENU button, the “Option” menu appears on the screen; when you attempt to operate the  button, the  icon appears.
- Off: The lock on the menu adjustments is released.

To release the lock of the menu adjustments

1 Press the MENU button.

The “Option” menu appears.

2 Press the OK button.

The “Menu Lock” menu appears.

3 Press the ↑/↓ buttons to select “Off” and press the OK button.

The lock on the menu adjustments is released.

■ Setting “Demo Mode”

You can set the “Demo Mode” function to on or off.

If you set the “Demo Mode” menu to “On,” the demonstration image appears on the screen.

■ Resetting to the default setting

This function resets the adjustments for all inputs to the default setting. Use this function with care.

1 Press the MENU button.

The main menu appears on the screen.

2 Press the ↑/↓ buttons to select (Option) and press the OK button.

The “Option” menu appears on the screen.

3 Press the ↑/↓ buttons to select “All Reset” and press the OK button.

The “All Reset” menu appears on the screen.

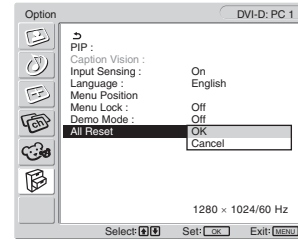

4 Press the ↑/↓ buttons to select the desired mode and press the OK button.

- OK: To reset all of the adjustment data to the default settings. Note that the “Language” setting is not reset by this method.
- Cancel: To cancel resetting and return to the menu screen.

Note

If you select OK in step 4, the adjustments made using the “Channel” menu are also set to the default. Therefore, after selecting OK, you need to run “Auto Program” to watch TV programs (page 14).

Technical Features

Controlling the volume

Using the display's speakers or headphones, you can listen to sound from your computer or other equipment connected to the display's audio input jacks.

You can control the volume by using the "Volume" adjustment bar.

- 1 Press the VOL+/- buttons when there is no menu displayed on the screen.

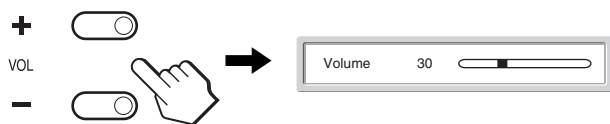

- 2 Press the VOL+/- buttons to set the desired volume level.

The bar automatically disappears after about 5 seconds.

Notes

- You cannot adjust the volume using the ↑/↓ buttons on the display when the main menu is displayed on the screen. Use the ◀ +/- buttons on the remote control instead.
- You cannot adjust the volume using the ↑/↓ buttons on the remote control.
- When your display is in power saving mode, no sound comes from the speakers or the headphones.

Power saving function

This display meets the power-saving guidelines set by VESA, ENERGY STAR, and NUTEK. If the display is connected to a computer or video graphics board that is DPMS (Display Power Management Standard) for Analog input/DMPM (DVI Digital Monitor Power management) for Digital input compliant, the display will automatically reduce power consumption as shown below.

MFM-HT75W

Power mode	Power consumption	⏻ (power) indicator
normal operation	68 W (max.)	green
active off* (deep sleep)**	1.2 W (max.)	orange

MFM-HT95

Power mode	Power consumption	⏻ (power) indicator
normal operation	74 W (max.)	green
active off* (deep sleep)**	1.2 W (max.)	orange

* When your computer enters the "active off" mode, the input signal is cut and "No Input Signal" appears on the screen. After 5 seconds, the display enters the power saving mode.

** "Deep sleep" is a power saving mode defined by the Environmental Protection Agency.

Tip

When the display is in the standby mode or the Sleep timer is activated, the ⏻ (power) indicator lights up in red.

Setting the Picture Mode

You can select the Picture Mode using the  button or “Mode” in the “Picture” menu.

When you select “Auto,” the display automatically adjusts the screen brightness according to the brightness of the surroundings (Automatic brightness adjustment function). For more information, see “Automatic brightness adjustment function (light sensor)”.

For details on using the “Mode” menu, see page 17.

For details on using the  button, see below.

Press the button repeatedly.

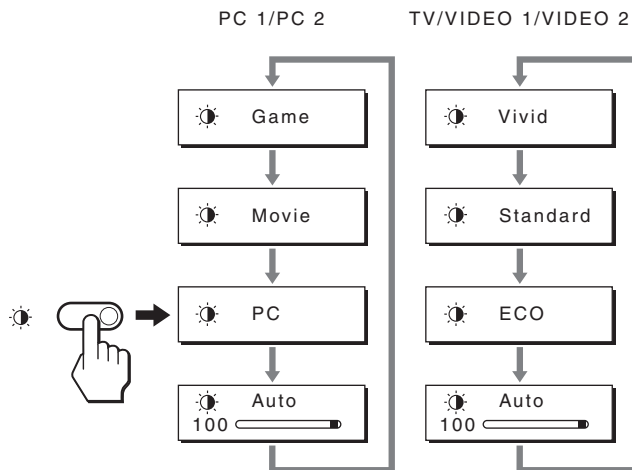

Each time you press the  button, the Picture Mode changes as follows.



Each indication appears on the screen and Picture Mode is changed. The menu automatically disappears after about 5 seconds.

Automatic brightness adjustment function (light sensor)

This display is provided with a feature to automatically adjust the screen brightness according to the brightness of the surroundings. The brightness of the screen is set to the most appropriate level by setting the Picture Mode to “Auto” with the  button or “Mode” in the “Picture” menu. (When you select the input from PC 1 or PC 2, “Movie” is selected as the default. When you select the input from VIDEO 1, VIDEO 2, or TV, “Vivid” is selected as the default.)

Also, when you set the Picture Mode to “Auto” with the  button, the adjustment bar is displayed. You can adjust the bar with the /  buttons. Screen brightness changes according to the level you set.

Automatic picture quality adjustment function (for PC 2 only)

When the display receives an input signal, it automatically adjusts the picture’s position and sharpness (phase/pitch), and ensures that a clear picture appears on the screen.

The factory preset mode

When the display receives an input signal, it automatically matches the signal to one of the factory preset modes stored in the display’s memory to provide a high quality picture at the center of the screen. If the input signal matches the factory preset mode, the picture appears on the screen automatically with the appropriate default adjustments.

If input signals do not match one of the factory preset modes

When the display receives an input signal that does not match one of the factory preset modes, the automatic picture quality adjustment function of this display is activated to ensure that a clear picture always appears on the screen (within the following display frequency ranges):

MFM-HT75W

Horizontal frequency: 28–69 kHz

Vertical frequency: 48–85 Hz

MFM-HT95

Horizontal frequency: 28–86 kHz

Vertical frequency: 48–85 Hz (resolution < 1280 × 1024),
48–75 Hz (resolution = 1280 × 1024)

Consequently, the first time the display receives input signals that do not match one of the factory preset modes, the display may take a longer time than normal to display the picture on the screen. This adjustment data is automatically stored in memory so that next time, the display will function in the same way as when the display receives the signals that match one of the factory preset modes.

If you adjust the phase, pitch, and picture position manually

For some input signals, the automatic picture quality adjustment function of this display may not completely adjust the picture position, phase, and pitch. In this case, you can set these adjustments manually (page 24). If you set these adjustments manually, they are stored in memory as user modes and automatically recalled whenever the display receives the same input signals.

US

Turning off the display automatically (for TV/VIDEO 1/VIDEO 2 only)

You can set the display to turn off automatically after a predetermined period of time (15, 30, 45, 60, or 90 minutes).

Press the SLEEP button on the remote control repeatedly.

Each time you press the SLEEP button, the period of time changes as follows:

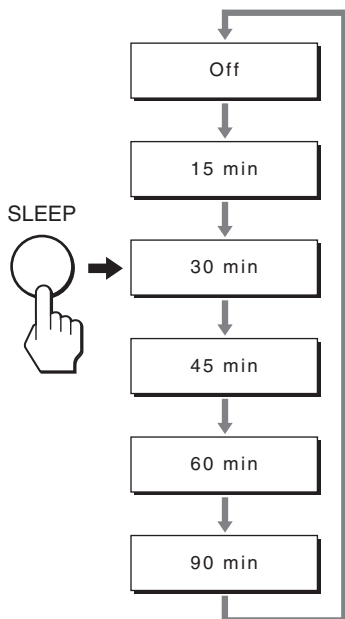

To cancel the Sleep timer

Press the SLEEP button repeatedly until “Off” appears.

Tips

- If you turn the display off, and then turn it on again, the Sleep timer is set to off.
- While the Sleep timer is activated, the  (power) indicator lights up in red.

Troubleshooting

Before contacting technical support, refer to this section.

On-screen messages

If there is something wrong with the input signal, one of the following messages appears on the screen. To solve the problem, see “Trouble symptoms and remedies” on page 38.

If “Out of Range” appears on the screen

This indicates that the input signal is not supported by the display’s specifications. Check the following items.

For more information about on-screen messages, see “Trouble symptoms and remedies” on page 38.

If “xxx.x kHz / xxx Hz” is displayed

This indicates that either the horizontal or vertical frequency is not supported by the display’s specifications.

The figures indicate the horizontal and vertical frequencies of the current input signal.

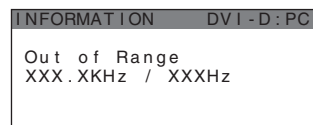

If “Resolution >1280 × 768” is displayed (MFM-HT75W)

This indicates that the resolution is not supported by the display’s specifications (1280 × 768 or less).

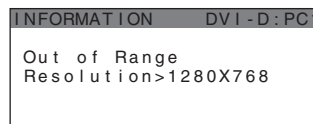

If “Resolution > 1280 × 1024” is displayed (MFM-HT95)

This indicates that the resolution is not supported by the display’s specifications (1280 × 1024 or less).

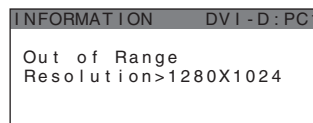

If “No Input Signal” appears on the screen

This indicates that no signal is being input via the currently selected connector.

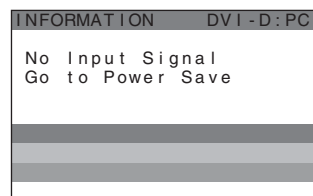

If “Cable Disconnected” appears on the screen

This indicates that the video signal cable has been disconnected from the currently selected connector.

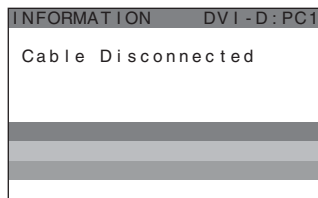
**If “Power will be turned off by off timer soon.” appears on the screen**

This indicates that the power provided to the display will be turned off by off timer in 1 minute.

If “Power will be turned off by auto shut off soon.” appears on the screen

This indicates that the power provided to the display will be turned off by auto shut off timer in 1 minute.





If “Feature Not Available” appears on the screen

This indicates that the function which you have attempted to operate is not available.

Trouble symptoms and remedies

If a problem occurs as a result of a connected computer or other equipment, refer to the connected computer/equipment's instruction manual.

For PC 1/PC 2

Symptom	Check these items
No picture.	
If the  (power) indicator is not lit, or if the  (power) indicator will not light up when the  (power) switch is pressed,	<ul style="list-style-type: none">• Check that the power cord is properly connected.
If "Cable Disconnected" appears on the screen,	<ul style="list-style-type: none">• Check that the video signal cable is properly connected and all plugs are firmly seated in their sockets (page 9).• Check that the video input connector's pins are not bent or pushed in.• Check that the input select setting is correct (page 12).• A non-supplied video signal cable is connected. If you connect a non-supplied video signal cable, "Cable Disconnected" may appear on the screen. This is not a malfunction.
If "No Input Signal" appears on the screen, or the  (power) indicator is orange,	<ul style="list-style-type: none">• Check that the video signal cable is properly connected and all plugs are firmly seated in their sockets (page 9).• Check that the video input connector's pins are not bent or pushed in.• Check that the input select setting is correct (page 12). <p>■ Problem caused by a computer or other equipment connected, and not caused by the display</p> <ul style="list-style-type: none">• The computer is in the power saving mode. Try pressing any key on the keyboard or moving the mouse.• Check that your graphics board is installed properly.• Check that the computer's power is on.• Restart the computer.
If "Out of Range" appears on the screen (page 36),	<p>■ Problem caused by a computer or other equipment connected, and not caused by the display</p> <ul style="list-style-type: none">• Check that the video frequency range is within that specified for the display. If you replaced an old display with this display, reconnect the old display and adjust the computer's graphics board within the following ranges: MFM-HT75W Horizontal frequency: 28–69 kHz (Analog RGB), 28–48 kHz (Digital RGB) Vertical frequency: 48–85 Hz (Analog RGB), 60 Hz (Digital RGB) Resolution: 1280 × 768 or less MFM-HT95 Horizontal frequency: 28–86 kHz (Analog RGB), 28–64 kHz (Digital RGB) Vertical frequency: 48–85 Hz (Analog RGB, resolution < 1280 × 1024), 48–75 Hz (Analog RGB, resolution = 1280 × 1024), 60 Hz (Digital RGB) Resolution: 1280 × 1024 or less For the MFM-HT75W only• SXGA picture is displayed with Safe Display Mode but it may be fuzzy. Set the resolution to 1280 × 768 on your computer.
If using Windows,	<ul style="list-style-type: none">• If you replaced an old display with this display, reconnect the old display and do the following. Select "SONY" from the "Manufacturers" list and select "MFM-HT75W or MFM-HT95" from the "Models" list on the Windows device selection screen. If "MFM-HT75W or MFM-HT95" does not appear in the "Models" list, try "Plug & Play."
If using a Macintosh system,	<ul style="list-style-type: none">• When connecting a Macintosh computer, use an adapter (not supplied) if necessary. Connect the adapter to the computer before connecting the video signal cable.

Symptom	Check these items
Picture flickers, bounces, oscillates, or is scrambled.	<ul style="list-style-type: none"> Adjust the pitch and phase (PC 2 only) (page 24). <p>■ Problem caused by a computer or other equipment connected, and not caused by the display</p> <ul style="list-style-type: none"> Check your graphics board manual for the proper display setting. Confirm that the graphics mode (VESA, Macintosh 19" Color, etc.) and the frequency of the input signal are supported by this display. Even if the frequency is within the proper range, some graphics boards may have a sync pulse that is too narrow for the display to sync with correctly. This display does not process interlace signals. Set for progressive signals. Adjust the computer's refresh rate (vertical frequency) to obtain the best possible picture (60 Hz is recommended).
Picture is fuzzy.	<ul style="list-style-type: none"> Adjust the contrast and brightness (page 18). Adjusting the sharpness (page 18). Adjust the pitch and phase (PC 2 only) (page 24). <p>■ Problem caused by a computer or other equipment connected, and not caused by the display</p> <ul style="list-style-type: none"> Set the resolution to 1280 × 768 (MFM-HT75W), or 1280 × 1024 (MFM-HT95) on your computer.
Picture is ghosting.	<ul style="list-style-type: none"> Eliminate the use of video cable extensions and/or video switch boxes. Check that all plugs are firmly seated in their sockets.
Picture is not centered or sized properly (PC 2 only).	<ul style="list-style-type: none"> Adjust the pitch and phase (page 24). Adjust the picture position (page 24). Note that some video modes do not fill the screen to the edges.
Picture is too small.	<p>■ Problem caused by a computer or other equipment connected, and not caused by the display</p> <ul style="list-style-type: none"> Set the resolution to 1280 × 768 (MFM-HT75W), or 1280 × 1024 (MFM-HT95) on your computer.
Picture is dark.	<ul style="list-style-type: none"> Adjust the backlight (page 18). Adjust the brightness (page 18). Adjust the gamma on the "Gamma" menu (page 19). It takes a few minutes for the display to become bright after turning on the display. When the Picture Mode is set to "Auto," the display brightness may become darker in low ambient light (pages 17, 35).
Wavy or elliptical pattern (moire) is visible.	<ul style="list-style-type: none"> Adjust the pitch and phase (PC 2 only) (page 24).
Color is not uniform.	<ul style="list-style-type: none"> Adjust the pitch and phase (PC 2 only) (page 24).
White does not look white.	<ul style="list-style-type: none"> Adjust the color temperature (page 19).
Display buttons do not operate (O_{ff} appears on the screen).	<ul style="list-style-type: none"> If "Menu Lock" is set to "On," set it to "Off" (page 33).
Resolution displayed on the menu screen is incorrect.	<ul style="list-style-type: none"> Depending on the graphics board setting, the resolution displayed on the menu screen may not coincide with the one set on the computer. <p>■ Problem caused by a computer or other equipment connected, and not caused by the display</p> <p>For the MFM-HT75W only</p> <ul style="list-style-type: none"> If you replaced an old display with this display, the computer may operate in safe mode. Press the MENU button to display the menu screen, and confirm that the resolution and refresh rate (vertical frequency) displayed in the lower right corner of the menu screen are 1280 × 768/60 Hz. If other than this value is displayed, replace this display with the display that was connected before and set the video output setting of the computer to 1280 × 768/60 Hz. If 1280 × 768/60 Hz is unavailable, the graphics board on the computer may not be supported by this display.

For TV/VIDEO 1/VIDEO 2

Symptom	Check these items
No picture.	
Cannot receive any channels.	<ul style="list-style-type: none"> • Make sure the power cord is connected securely. • Turn on the power of the display. • Check antenna cable connections.
No sound./Noisy sound.	
Good picture, no sound.	<ul style="list-style-type: none"> • Check audio cable connections. • Check the volume control. • Press the MUTING or VOL + button so that "Muting" disappears from the screen (pages 15, 34). • Disconnect your headphones.
Remote control does not operate.	<ul style="list-style-type: none"> • The batteries could be weak. Replace the batteries. • Check the polarity of the batteries. • If the ⏻ (power) indicator on the display does not light in orange, press the ⏻ (power) switch on the display. • If you intend to operate the TV functions, check the TV input is selected. • If you intend to operate the TV functions with the "PIP" function, check the TV input is selected for sub picture.
Lost password.	<ul style="list-style-type: none"> • Select the  (Parent) menu on the menu screen, then enter the following master password: 4357. The master password clears your previous password and allows you to enter a new password (page 25).
Noisy picture when viewing a TV channel.	<ul style="list-style-type: none"> • Set the "NR" menu to "On" to reduce the noise on the picture (page 20) • Decrease the setting value for the "Sharpness" menu (page 18).

Displaying information for this display

While the display is receiving a video signal, press and hold the MENU button for more than 5 seconds until the information box appears.

Press the MENU button again to make the box disappear.

Example

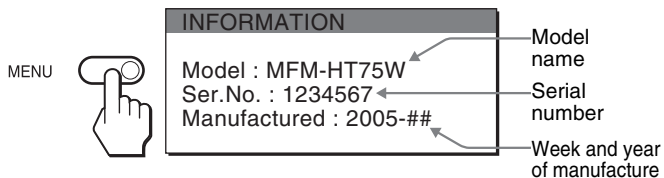

If any problem persists, call your authorized Sony dealer and give the following information:

- Model name: MFM-HT75W or MFM-HT95
- Serial number
- Detailed description of the problem
- Date of purchase
- Name and specifications of your computer and graphics board
- Type of input signals (PC 1/PC 2/TV/VIDEO 1/VIDEO 2)

Specifications

LCD panel

Panel type: a-Si TFT Active Matrix

Screen size:

17 inch (43 cm) (MFM-HT75W)

19 inch (48 cm) (MFM-HT95)

Display resolution:

MFM-HT75W

Horizontal: Max. 1280 dots

Vertical: Max. 768 lines

MFM-HT95

Horizontal: Max. 1280 dots

Vertical: Max. 1024 lines

Signal input

PC 1

Signal format:

Digital RGB (DVI-D) (TMDS Single link)

Operating frequency:

MFM-HT75W

Horizontal: 28–48 kHz

Vertical: 60 Hz

MFM-HT95

Horizontal: 28–64 kHz

Vertical: 60 Hz

Audio:

Stereo mini jack, 500 mVrms (100% modulation)

PC 2

Signal format:

Analog RGB (HD-15D-sub)

Operating frequency:

MFM-HT75W

Horizontal: 28–69 kHz

Vertical: 48–85 Hz

MFM-HT95

Horizontal: 28–86 kHz

Vertical: 48–85 Hz (resolution<1280 × 1024)

48–75 Hz (resolution=1280 × 1024)

Signal levels:

RGB signal: 0.7 Vp-p, 75 Ω, positive

SYNC signal:

TTL level, 2.2 kΩ, positive or negative (Separate horizontal and vertical, or composite sync)

0.3 Vp-p, 75 Ω, negative (Sync on green)

Audio:

Stereo mini jack, 500 mVrms (100% modulation)

TV

TV system:

American TV standard (NTSC)

Channel coverage:

VHF: 2 to 13

UHF: 14 to 69

CATV: 1 to 125

Antenna:

75-ohm external terminal for VHF/UHF

VIDEO 1

Signal standard:

Component video (Y, P_B, P_R) (RCA jack)

Y: 1.0 Vp-p, 75-ohm unbalanced, sync negative

P_B: 0.7 Vp-p, 75 Ω

P_R: 0.7 Vp-p, 75 Ω

Signal format:

480i (525i), 480p (525p), 576i (625i), 576p (625p),

720p (750p), 1080i (1125i)

Audio:

RCA jack (stereo), 500 mVrms (100% modulation)

VIDEO 2

Signal standard:

S-Video (4-pin mini DIN)

Y: 1.0 Vp-p, 75-ohm unbalanced, sync negative

C: 0.286 Vp-p (Burst signal), 75 Ω

Composite video (RCA jack)

1.0 Vp-p, 75-ohm unbalanced, sync negative

Video format: NTSC, PAL, SECAM

Audio:

RCA jack (stereo), 500 mVrms (100% modulation)

Plug & Play

VESA, DDC2B

Speaker output

Max. 3 W × 2 +5 W

Headphones output

Stereo minijack

Power requirements

100–240 V AC, 50–60 Hz

Max. 1.3 A (MFM-HT75W)

Max. 1.4 A (MFM-HT95)

Power consumption

In use (Max.): 68 W (MFM-HT75W)/74 W (MFM-HT95)

In standby (Max.): 1.2 W

Operating temperature

0–35°C

Dimensions (width/height/depth)

Display (upright):

MFM-HT75W

Approx. 450.2 × 353.5 × 176 mm

(17 ³/₄ × 14 × 7 inches)

MFM-HT95

Approx. 466.6 × 437 × 185 mm

(18 ³/₈ × 17 ¹/₄ × 7 ³/₈ inches)

Mass

MFM-HT75W

Approx. 6.3 kg (13 lb. 14 oz.)

MFM-HT95

Approx. 7.8 kg (17 lb. 3 oz.)

Accessories

See page 9.

Design and specifications are subject to change without notice.

US

Free Manuals Download Website

<http://myh66.com>

<http://usermanuals.us>

<http://www.somanuals.com>

<http://www.4manuals.cc>

<http://www.manual-lib.com>

<http://www.404manual.com>

<http://www.luxmanual.com>

<http://aubethermostatmanual.com>

Golf course search by state

<http://golfingnear.com>

Email search by domain

<http://emailbydomain.com>

Auto manuals search

<http://auto.somanuals.com>

TV manuals search

<http://tv.somanuals.com>