SONY[®]

3-707-915-01 (1)

Black and White Monitor

SSM-121

Operating Instructions

Before operating the unit, please read this manual thoroughly and retain it for future reference.

Owner's Record

The model and serial numbers are located at the rear.

Record the serial number in the space provided below.

Refer to these numbers whenever you call upon your Sony dealer regarding this product.

Model No. SSM-121 Serial No. _____

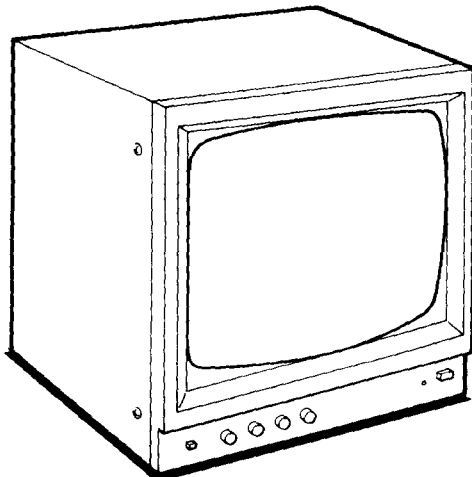

WARNING

To prevent fire or shock hazard, do not expose the unit to rain or moisture.

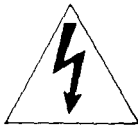
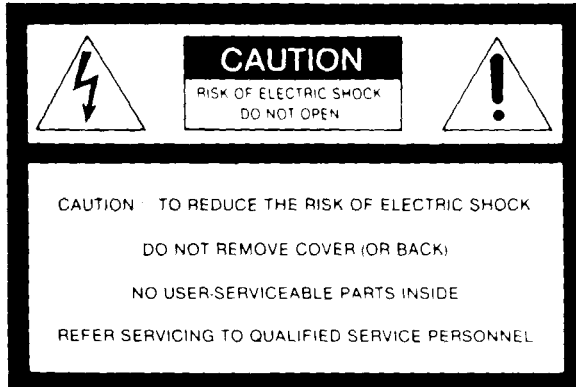

This symbol is intended to alert the user to the presence of uninsulated "dangerous voltage" within the product's enclosure that may be of sufficient magnitude to constitute a risk of electric shock to persons.



This symbol is intended to alert the user to the presence of important operating and maintenance (servicing) instructions in the literature accompanying the appliance.

CAUTION:

TO PREVENT ELECTRIC SHOCK, DO NOT USE THIS POLARIZED AC PLUG WITH AN EXTENSION CORD, RECEPTACLE OR OTHER OUTLET UNLESS THE BLADES CAN BE FULLY INSERTED TO PREVENT BLADE EXPOSURE.

Information

This equipment generates and uses radio frequency energy and if not installed and used properly, that is, in strict accordance with the manufacturer's instructions, may cause interference to radio and television reception. It has been type tested and found to comply with the limits for a Class B computing device in accordance with the specifications in Subpart J of Part 15 of FCC Rules, which are designed to provide reasonable protection against such interference in a residential installation. However, there is no guarantee that interference will not occur in a particular installation. If this equipment does cause interference to radio or television reception, which can be determined by turning the equipment off and on, the user is encouraged to try to correct the interference by one or more of the following measures:

- Reorient the receiving antenna
- Relocate the equipment with respect to the receiver
- Move the equipment away from the receiver
- Plug the equipment into a different outlet so that equipment and receiver are on different branch circuits.

If necessary, the user should consult the dealer or an experienced radio/television technician for additional suggestions. The user may find the following booklet prepared by the Federal Communications Commission helpful: "How to Identify and Resolve Radio-TV Interference Problems". This booklet is available from the U.S. Government Printing Office, Washington, DC 20402, Stock No. 004-000-00345-4.

Features

- This model can be used as a closed circuit television monitor or a video preview/playback monitor.
- Loop-through connection allows 3 monitors to display the same picture.
- Electronic circuits provide safeguards against interference, noise and change of signal level to maintain a clear and stable picture.

Precautions

Safety

- Operate the unit only on 120 V AC, 60 Hz.
- Should any liquid or solid object fall into the cabinet, unplug the unit and have it checked by the qualified personnel before operating it any further.
- Unplug the unit from the wall outlet if it is not going to be used for several days or more. To disconnect the unit, pull the plug. Never pull the cord itself.
- Allow adequate air circulation to prevent internal heat build-up. Do not place the unit on surfaces (rugs, blankets, etc.) or near materials (curtains, draperies) that may block the ventilation holes.
- Height and vertical linearity controls located at the rear panel are for special adjustments by qualified personnel only.

Installation

- Do not install the unit in an extremely hot or humid place or in a place subject to excessive dust or mechanical vibration.
- The unit is not designed to be waterproof. Exposure to rain or water may damage the unit.

Cleaning

Clean the unit with a slightly damp soft cloth. Use a mild household detergent. Never use strong solvents such as thinner or benzine as they might damage the finish of the unit.

If you have any question or problem concerning your unit that is not covered in this manual, please consult your nearest Sony dealer.

Specifications

System	EIA standard
Picture tube	12 inch picture measured diagonally 90-degree deflection
Resolution	More than 700 TV lines (horizontal)
Video input	Composite: 0.5 – 2 Vp-p, sync negative (× 2)
Video input impedance	High impedance for loop-through; 75 Ω terminated
Video output	Composite: 0.5 – 2 Vp-p, sync negative (× 2)
Video output impedance	Over 10 kilohms
Power requirements	120 V AC, 60 Hz
Power consumption	30 W
Dimensions	296 × 303 × 296 mm (w/h/d) (11 ³ / ₄ × 12 × 11 ³ / ₄ inches)
Weight	Approx. 9.2 kg (20 lb 5 oz)

Design and specifications are subject to change without notice.

Location and Function of Controls

Front

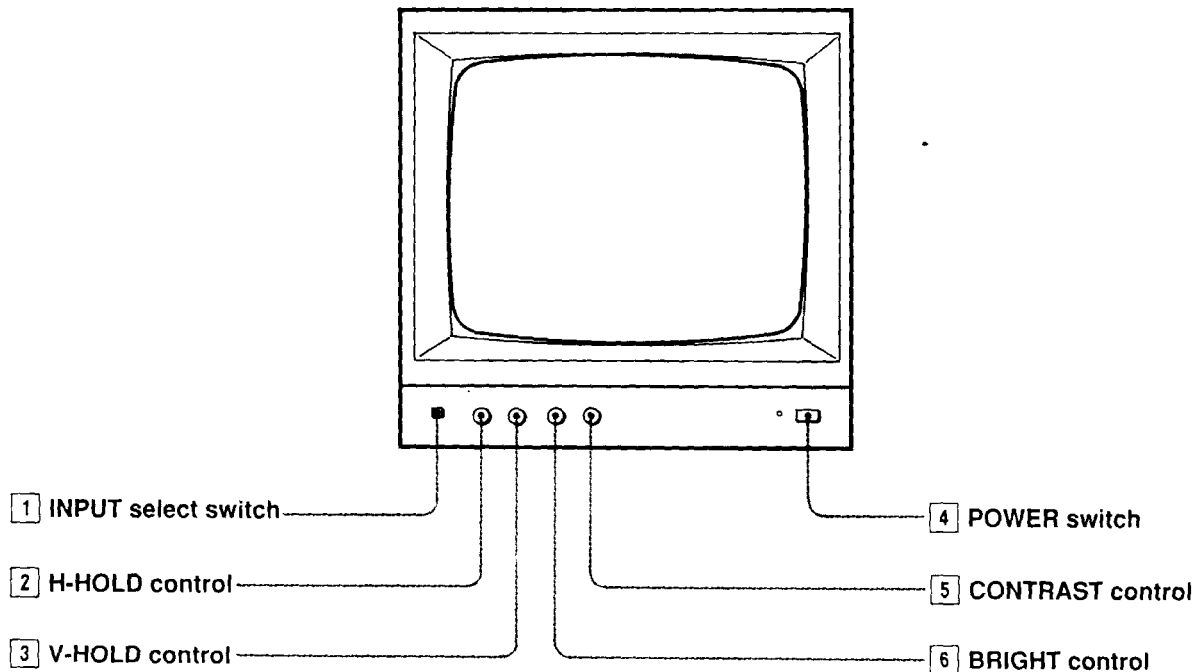

1 INPUT select switch

Keep this switch released (\square A) to monitor the signal from the VIDEO A IN connector. Depress the switch (\blacksquare B) to monitor the signal from the VIDEO B IN connector.

2 H-HOLD (horizontal hold) control

When the picture has slanting horizontal bars, turn the H-HOLD control until a stationary picture is obtained.

3 V-HOLD (vertical hold) control

When the picture rolls up or down on the screen, turn the V-HOLD control until a stationary picture is obtained.

4 POWER switch

Depress the POWER switch to turn the monitor on (\blacksquare ON). To turn it off, press the switch again (\square OFF).

5 CONTRAST control

Turn clockwise to increase picture contrast and counterclockwise to decrease it.

6 BRIGHT (brightness) control

Turn clockwise for a brighter picture and counterclockwise for a darker picture.

Rear

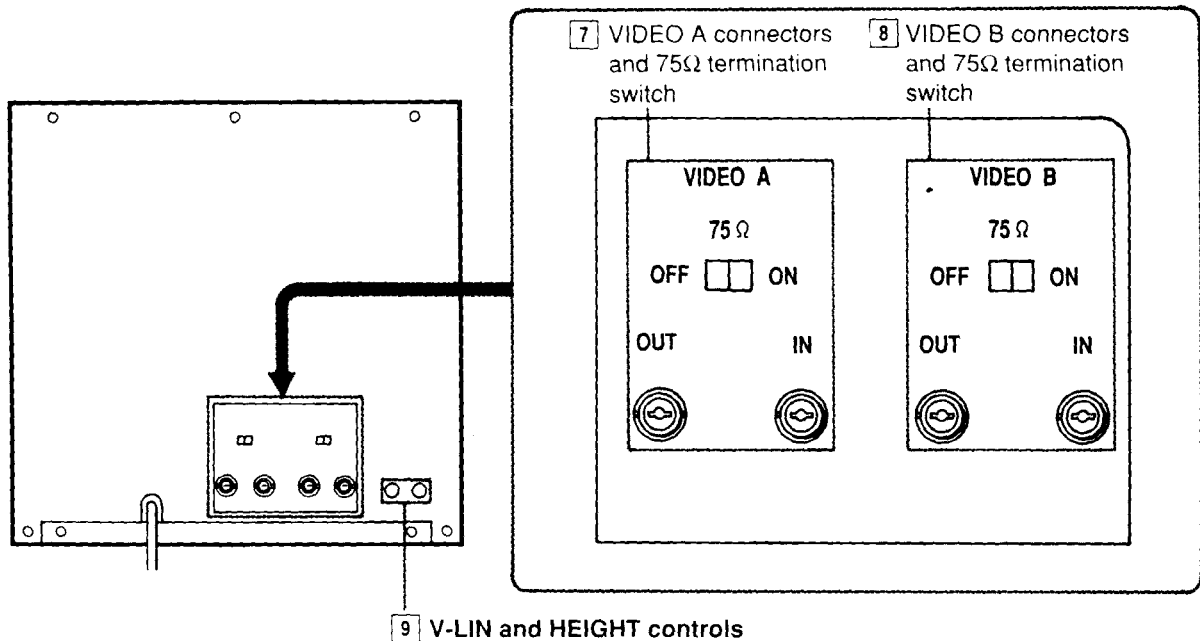

7 VIDEO A connectors and 75Ω termination switch

8 VIDEO B connectors and 75Ω termination switch

Two video input connectors (VIDEO A and VIDEO B) for the composite video signals and their loop-through output connectors.

To monitor the signals input to the VIDEO A IN connector, keep the INPUT select switch released (A).

To monitor the signals input to the VIDEO B IN connector, depress the INPUT select switch (B).

IN connector (BNC type)

Connect this connector to the video output connector of a VCR, a video camera, or another monitor (for a loop-through connection).

OUT connector (BNC type)

Connect this connector to the video input connector of a VCR or another monitor (for a loop-through connection).

75 Ω termination switch

Set this switch to ON when only the IN connector is used (the OUT connector is not used). Set this switch to OFF, when both the IN and OUT connectors are used together for a loop-through connection.

9 V-LIN (vertical linearity) and HEIGHT controls
For special adjustments by qualified personnel only.

Connections

Connecting a Video Camera or a VCR

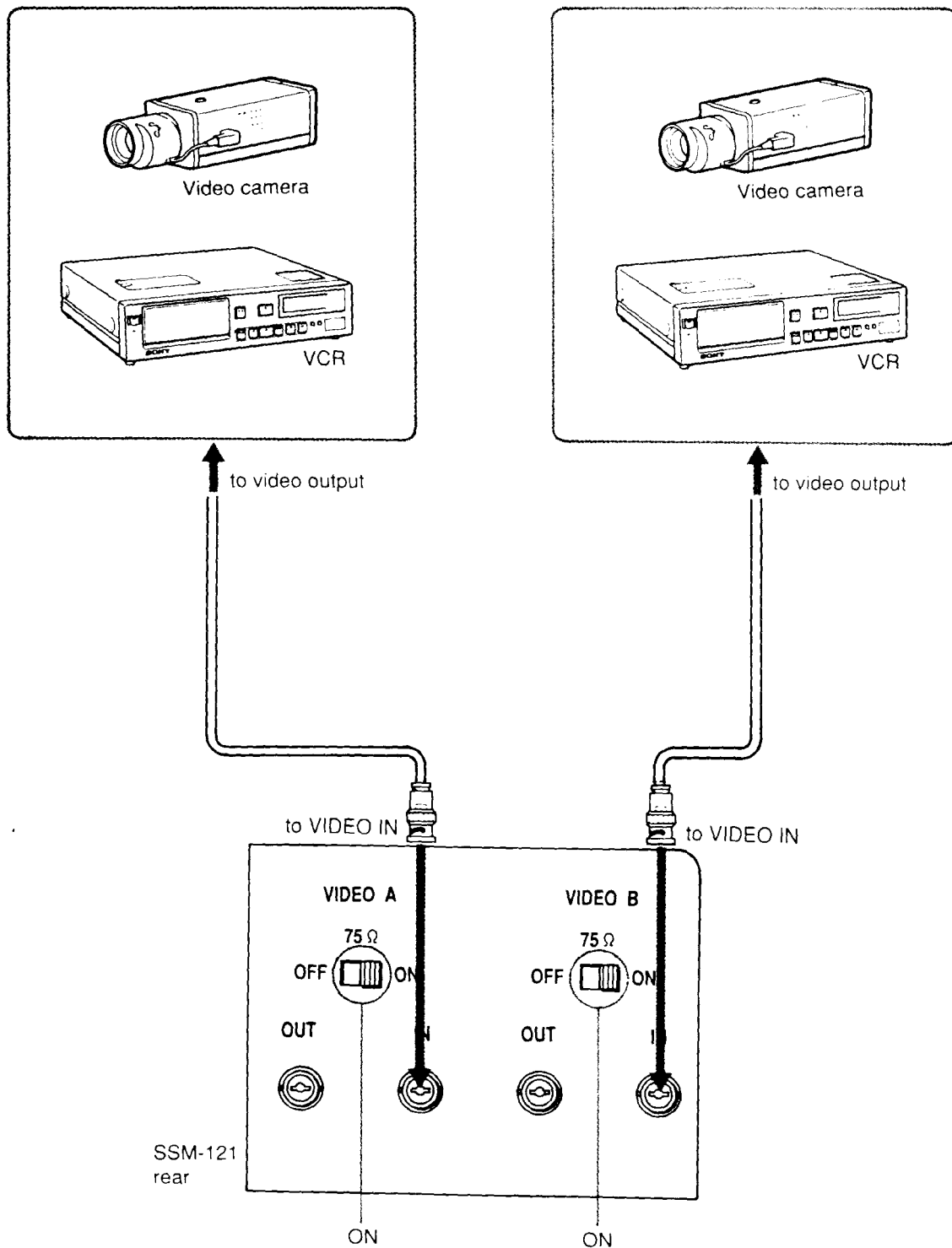

Connecting More Than One Monitor

Up to 3 monitors can be connected using the loop-through feature of this unit. When this monitor is connected to additional monitors, the same picture can be obtained on all the connected monitors.

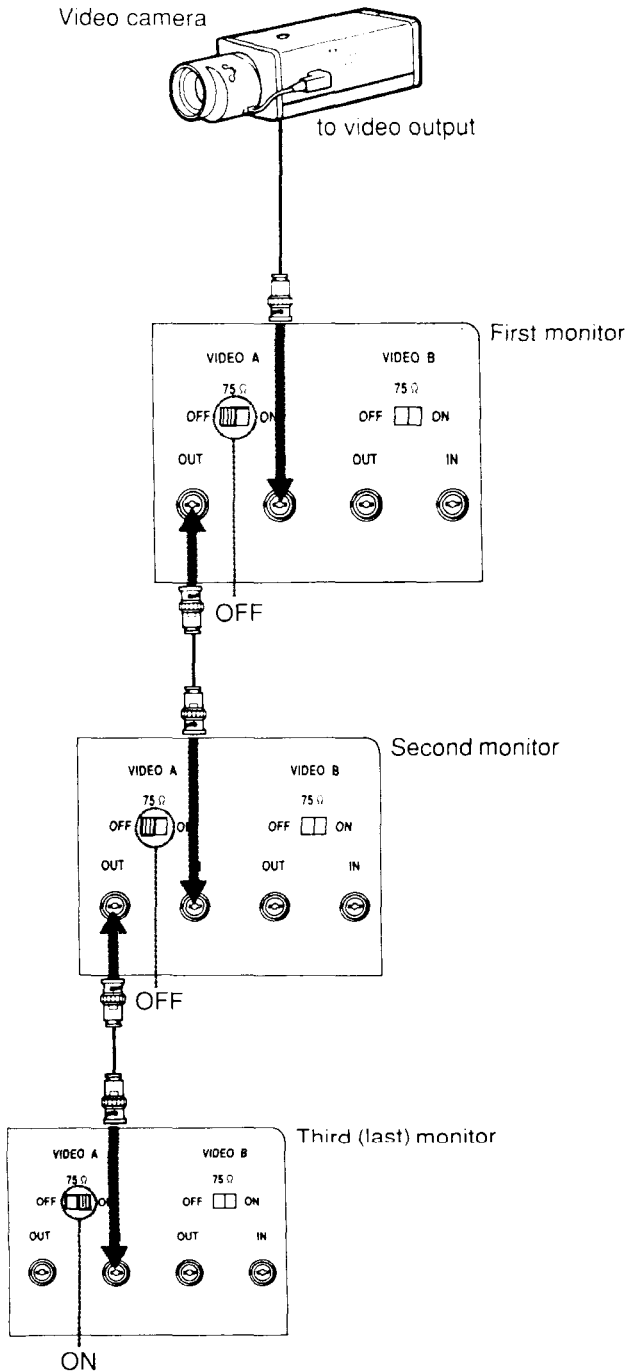

Adjust the picture contrast and brightness of each monitor.

Free Manuals Download Website

<http://myh66.com>

<http://usermanuals.us>

<http://www.somanuals.com>

<http://www.4manuals.cc>

<http://www.manual-lib.com>

<http://www.404manual.com>

<http://www.luxmanual.com>

<http://aubethermostatmanual.com>

Golf course search by state

<http://golfingnear.com>

Email search by domain

<http://emailbydomain.com>

Auto manuals search

<http://auto.somanuals.com>

TV manuals search

<http://tv.somanuals.com>