

# TABLE OF CONTENTS

<b>SAFETY INSTRUCTIONS .....</b>	<b>2</b>
<b>INTRODUCTION .....</b>	<b>4</b>
<b>Package Contents .....</b>	<b>4</b>
<b>Installing or Removing the Tilt/Swivel Base .....</b>	<b>5</b>
<b>Specifications .....</b>	<b>6</b>
<b>Recommended Use of the Monitor .....</b>	<b>7</b>
<b>CONTROLS AND ADJUSTMENTS .....</b>	<b>8</b>
<b>Front User Controls. ....</b>	<b>8</b>
<b>"General" .....</b>	<b>9</b>
<b>"Picture" .....</b>	<b>9</b>
<b>"Geometry" .....</b>	<b>9</b>
<b>"Color" .....</b>	<b>9</b>
<b>"Advance" .....</b>	<b>10</b>
<b>"Porperty" .....</b>	<b>10</b>
<b>"Signal" .....</b>	<b>11</b>
<b>Contrast .....</b>	<b>11</b>
<b>Energy Declaration .....</b>	<b>11</b>
<b>TECHNICAL INFORMATION .....</b>	<b>12</b>
<b>Compatibility .....</b>	<b>12</b>
Pin Assignment.....	12
Preset Timing Chart .....	13
<b>TROUBLESHOOTING .....</b>	<b>14</b>
<b>DIMENSION .....</b>	<b>15</b>
<b>PLUG &amp; PLAY: DISPLAY DATA CHANNEL (DDC) .....</b>	<b>16</b>
<b>MANUFACTURER'S LIMITED WARRANTY. ....</b>	<b>16</b>

## SAFETY INSTRUCTIONS

1. Please read carefully all of these instructions below and keep the manual for later use.
2. Please install the swivel base for this product before using it.
3. The voltage ratings and the rated frequency are on the overlay centered at the rear side of this product. Do not connect with any other sources of voltage or frequency, and, please follow all warnings and instructions marked on the product.
4. Unplug this product from the wall outlet before cleaning and use a damp cloth to clean it. Do not use liquid cleaners or aerosol cleaners.
5. Do not expose this product to rain or moisture.
6. Do not place this product on an unstable cart, stand, or table. The product may fall, causing serious damage to the product.
7. Do not block or cover ventilating openings with cloth or other material. Neither should this product be placed near or over a radiator or a heat register, nor should the product be placed in a built-in installation unless proper ventilation is provided.
8. This product is equipped with a 3-wire grounding model plug. This plug will only fit into a grounding-model power outlet. This is a safety feature. If you are unable to insert the plug into the outlet, contact your electrician to replace your obsolete outlet. Do not defeat the safety purpose of the grounding-model plug. Choose a Tandem Blade attachment plug configuration power cord for 230V AC input.

Due to the safety requirements of different areas, please select a suitable power cord according to the following rules, in addition to the electric rating:

- A. Northern America area: Please select a UL listed and CSA certified power cord.
- B. Germany: Please select a VDE certified power cord.
- C. Nordic countries: Please select a power cord certified by SEMKO, NEMKO, DEMKO or FIMKO.
- D. The other areas: Please select a power cord suitable to the local power system and power outlet.

## SAFETY INSTRUCTIONS

Usually when this product is sold a suitable power cord is provided by the manufacturer. However, this product is sometimes resold or transported to another area with a different power system and safety requirements. Please pay attention to the selection of a suitable power cord.

The plug on the power cord is intended to serve as the disconnect device, the socket-outlet shall be installed near the equipment and shall be easily accessible.

9. Do not allow anything to rest on the power cord. Do not locate this product where persons can walk on the cord.
10. Never push objects of any kind into this product through cabinet slots as they may touch dangerous voltage points or short out parts that could result in the risk of fire or electric shock. Never spill liquid of any kind on the product.
11. Do not attempt to service this product yourself, as opening or removing covers may expose you to dangerous voltage points, or other risks. Refer all servicing to service personnel.
12. Unplug this product from the wall outlet and refer servicing to qualified service personnel under the following conditions.
  - A. When the power cord or plug is damaged or frayed.
  - B. If liquid has been spilled into the product.
  - C. If the product has been exposed to rain or water.
  - D. If when the operating instructions are followed, the product does not operate normally, adjust only those controls that are covered by the operating instructions since improper adjustment of other controls may result in damage and will often require extensive work by a qualified technician to restore the product to normal operation.
  - E. If the product has been dropped or the cabinet has been damaged.
  - F. If the product exhibits a distinct change in performance, indicating a need for service.

# INTRODUCTION

## *Introduction*

The monitor is a multiple frequency high-resolution color monitor for IBM compatible PC's or Macintosh and workstation systems. The monitor is equipped with microprocessor based intelligence and multiple frequency scanning capability, allowing it to provide maximum compatibility for various system platforms.

The monitor uses the latest screen technology including a 0.24mm AG Trinitron® CRT to display crisp text and vivid color graphics. The full-function digital control and On-Screen Display (OSD) system provides easy adjustment of image geometry and color settings for different display modes with the precision of a fixed frequency monitor.

The monitor also has full ergonomic features. In addition to the friendly controls and user comfort features, the emission level of the electric and magnetic field is kept low to meet the Swedish MPR II and TCO standards.

The monitor is also equipped with energy saving functions; it is compatible with the VESA power saving standards.

## *Package Contents*

The following lists all of the items included in the monitor package box. Please save the original box and packing materials for future transportation or shipment of the monitor.

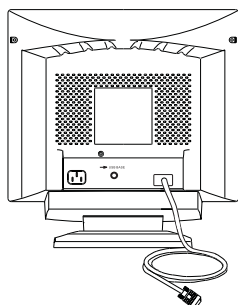

*Rear View*

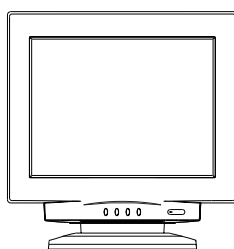

*Front View*

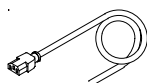

*Power Cord*

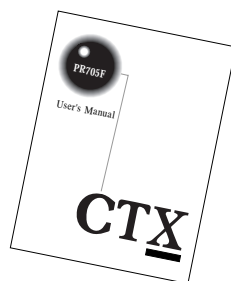

*User's Manual*

# INTRODUCTION

## ***Installing or Removing the Tilt/Swivel Base***

1. Turn off the system and all attached peripherals.
2. Carefully set the monitor upside down.

### **Remove the Tilt/Swivel Base:**

1. Squeeze and hold the latches.
2. Pull the tilt/swivel base to the rear of the monitor and lift to remove the base.

### **Installing the Tilt/Swivel Base:**

1. Align the base with the slots on the bottom of the monitor and insert the tilt/swivel base into the slots.
2. Push the tilt/swivel base firmly toward the front of the monitor until the latches click into the locked position.

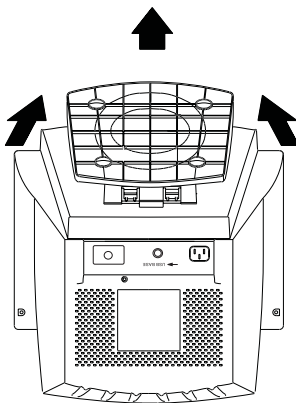

*Install*

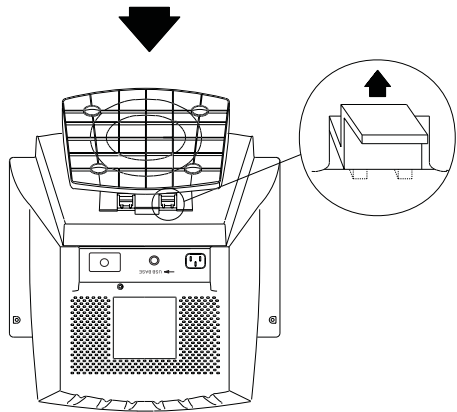

*Remove*

# INTRODUCTION

## Specifications

<i>Color Picture Tube</i>	43.1 cm / 17" (16" viewable screen size) diagonal measurement, 90 degree deflection, Trinitron® CRT, anti-glare, anti-reflection, anti-static
<i>AG Pitch</i>	0.24 mm, (at center)
<i>Input Signal</i>	Video: 0.7 Vp-p/75 ohm, analog positive Sync: Separate Sync.: TTL Level Horizontal Sync.: positive/negative Vertical Sync.: positive/negative Composite Sync.: TTL Level, positive/negative
<i>Scan Frequency</i>	Horizontal: 30 to 85 kHz automatically Vertical: 50 to 160 Hz automatically
<i>Max. Resolution</i>	1600 x 1200 pixel, non-interlaced
<i>Display Colors</i>	Analog input, unlimited colors
<i>Pixel Rate</i>	175.5 MHz
<i>Plug &amp; Play</i>	DDC 1 / DDC 2B
<i>Power Supply</i>	100-120 VAC/200-240 VAC, 50/60 Hz (automatically)
<i>Power Consumption</i>	110W max.
<i>Dimensions</i>	418(W) x 430(H) x 447(D) mm
<i>Weight</i>	23 kgs(G.W.), 20 kgs(N.W.)
<i>Environment Consideration</i>	Operating Temperature: 0°C to 35°C Humidity 20% to 80% Storage Temperature: -20°C to 60°C Humidity 10% to 90%

*Note: Specifications are subject to change without notice.*

# INTRODUCTION

## ***Recommended Use of the Monitor***

When setting up and using the monitor, pay special attention to the following for optimum performance:

- Do not use your monitor against a bright background or where sunlight or other light sources will shine directly on the screen.
- The monitor should be placed just below eye level ( $10^{\circ} \sim 15^{\circ}$ ) for optimum viewing.
- Set the monitor's brightness to match ambient room light.
- For optimum focus, the contrast control should not be set to the maximum level unless the input signal level is extremely low. Also, the brightness control should be set to a point where the overall background area just begins to disappear.
- Allow adequate ventilation around the monitor so that the heat from the monitor can be properly dissipated.
- Neither the monitor itself, nor any other heavy objects, should rest on the power cord. Damage to the power cord can cause fire or an electric shock.
- Keep the monitor away from high-capacity transformers, electrical motors, or other strong magnetic fields.
- Your monitor should not be used in damp, dusty, or dirty areas.
- Handle your monitor with care when transporting it.

## **CAUTION**



- **Do not scrape or knock the surface of the CRT with a pen, a screwdriver and so on.**
- **Clean the CRT surface with a lint-free, nonabrasive, soft cloth, do not use a solution or glass cleaner containing corpuscles like abrasives, alcohols and alkalines.**

# CONTROLS AND ADJUSTMENTS

## Controls and Adjustments

Once you have installed the monitor with your system, please read the instructions of this section which give you some guidelines on how to use the monitor more efficiently. It leads you through the various function of the user controls and explains how to adjust the monitor to your personal preference.

### Front User Controls

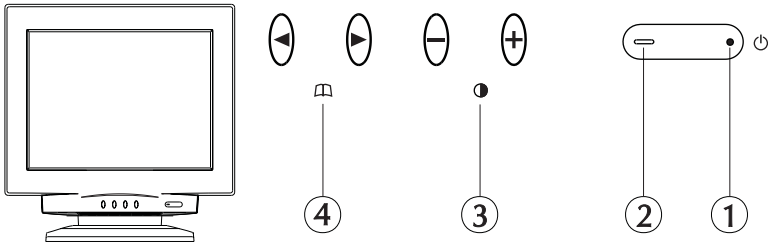

#### 1. Power Switch

To turn the monitor on or off.

#### 2. Power LED Indicator

As long as the monitor is powered, this indicator is lit. In normal operation, it lights green. While in power saving mode, the indicator will turn to amber.

#### 3. Adjust Keys

- To adjust the parameter of the selected function.
- To adjust the contrast level of the screen.

#### 4. Menu Key

To display and select the "General", "Picture", "Geometry", "Color", "Advance", "Property", "Signal" functions.

#### Power Saving Note:

This monitor is equipped with a automatic power-saving circuitry design that will work with any computer which meets the VESA DPMS standard. It also meets the ENERGY STAR low power state definition.



# CONTROLS AND ADJUSTMENTS

- (1) Press "◀" or "▶" to open the On-Screen menu function. Seven adjustment functions will appear on the On-Screen menu.  
Press "◀" key to scroll down through the selections.

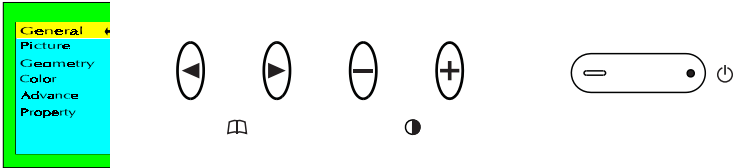

## A. General

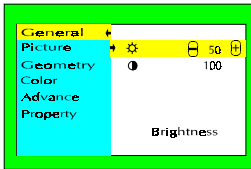

- Press "▶" to select Brightness or Contrast.
- Press "+" or "-" to preferred picture.

## B. Picture

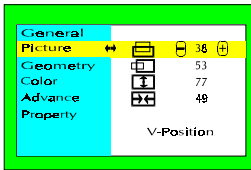

- Press "▶" to select Vertical and Horizontal position, Vertical and Horizontal size.
- Press "+" or "-" to preferred picture.

## C. Geometry

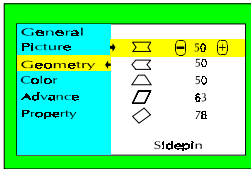

- Press "▶" to select Side-pin, Balance, Keystone, Parallel and Rotate.
- Press "+" or "-" to preferred picture.

## D. Color

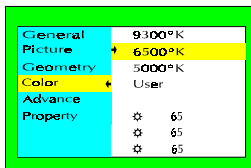

- Press "▶" to select various white color temperature standards.
- In User item press "+" to confirm action color adjustment.
- Press "▶" to select Red, Green and Blue.
- Press "+" or "-" increase or decrease density.

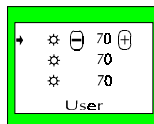
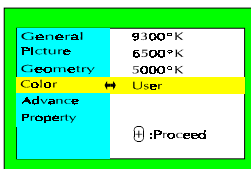

# CONTROLS AND ADJUSTMENTS

## E. Advance

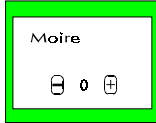
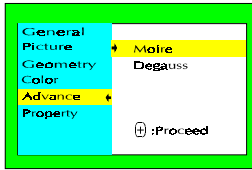

- Press "▶" to select Moire or Degauss.
- Press "+" to proceed.
- Press "+" or "-" to preferred picture.

### Caution:

- If moire reduction is overdone, picture quality, i.e. focus and vertical line stability will both be effected.
- Proper adjustment is recommended for not effecting picture performance.

## F. Property

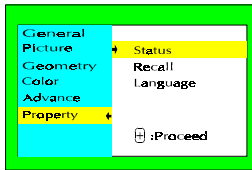

Press "▶" to select Status, Recall or Language sub-manual.

### F-1. Status

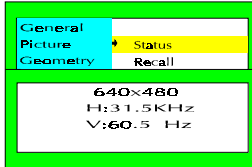

The status show the current input signal information such as Resolution, Horizontal Frequency and Vertical Frequency.

### F-2. Recall

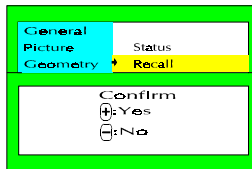

Confirm the Recall action by pressing the "+" or cancel the action by pressing the "-".

# CONTROLS AND ADJUSTMENTS

## F-3. Language

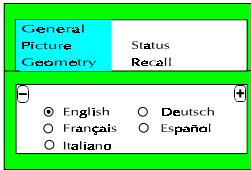

Press "+" or "-" to select the Language for OSD only.

(2) When OSD is off, "+" or "-" will increase or decrease contrast.



## Energy Declaration

This monitor is equipped with a function for saving energy which supports the VESA Display Power Management Signaling (DPMS) standard. This means that the monitor must be connected to a computer which also supports the VESA DPMS standard to fulfill the requirements of the NUTEK specification 803299/94/96. The time settings for switching to a power saving mode are adjusted from the system unit by software. From the first indication of inactivity to power saving position A2 the total time must not be set to more than 70 minutes.

### 1. VESA Power-Management Proposal

VESA DPMS Standard			
H. sync	V. sync	Video	State
Off	On	Blank	Stand-by
On	Off	Blank	Suspend
Off	Off	Blank	Off

### 2. Power Consumption (120/230 Vac)

NUTEK	VESA state	LED indicator	Power Consumption
Normal operation	On	Green	<110W
Power Saving Position A1	Suspend	Amber	≤15W
Power Saving Position A2	Off	Amber	≤5W

## TECHNICAL INFORMATION

### Compatibility

This color monitor supports multiple operating platforms such as IBM compatible and Macintosh family computers. This section provides you with detailed information on the pin assignment of the D-Sub connector and the preset timing chart of the prevailing video standards.

### Pin Assignment

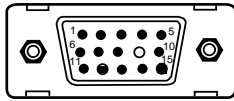

*Male Mini D-15 Connector*

Signal	15 Pin Mini D-Sub
Red Video	1
Green Video	2
Blue Video	3
Horizontal Sync	13
Vertical Sync	14
Ground	4,5,6,7,8,10,11
No Connection	9
SDA (DDC)	12
SCL (DDC)	15

## Preset Timing Chart

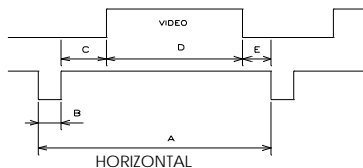

Note: This monitor is equipped with a micro-processor which allows the user to set his own preferred mode(s) beyond those standard mode listed below.

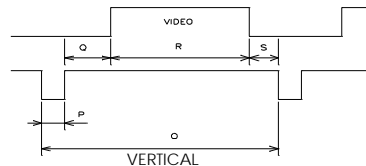

Display Format	VGA		VESA 640x480 at 85 Hz	640x480 at 120 Hz	MAC 832x624 at 75 Hz	VESA 800x600 at 85 Hz	800x600 at 120 Hz	MAC 1152x864 at 75 Hz	VESA 1024x768 at 85 Hz	1024x768 at 100Hz	VESA 1280x1024 at 75 Hz
	Horizontal Dots	640	720	640	640	832	800	800	1152	1024	1024
Vertical Lines	480	400	480	480	624	600	600	864	768	768	1024
H. Frequency(kHz)	31.469		43.269	63.530	49.726	53.674	75.985	67.500	68.677	80.468	79.976
H. Sync. Polarity	-	-	-	-	-	+	-	+	+	-	+
A $\mu$ s (Period)	31.778		23.111	15.741	20.110	18.631	13.160	14.815	14.561	12.427	12.504
*B $\mu$ s (Pulse Width)	3.813		1.556	1.749	1.117	1.138	1.074	1.185	1.016	1.073	1.067
C $\mu$ s (Back Porch)	1.907		2.222	1.731	3.910	2.702	1.951	2.370	2.201	1.945	1.837
D $\mu$ s (Active Area)	25.422		17.778	11.660	14.524	14.222	9.827	10.667	10.836	9.309	9.481
E $\mu$ s (Front Porch)	0.636		1.555	0.601	0.559	0.569	0.308	0.593	0.508	0.100	0.119
V. Frequency(Hz)	59.940	70.087	85.008	119.868	74.552	85.062	120.039	75.000	84.997	99.836	75.024
V. Sync. Polarity	-	+	-	-	+	+	-	+	+	-	+
Oms (Period)	16.683	14.268	11.763	8.343	13.413	11.756	8.330	13.333	11.765	10.016	13.329
Pms (Pulse Width)	0.064		0.069	0.094	0.060	0.056	0.039	0.044	0.044	0.037	0.038
Qms (Back Porch)	1.049	1.112	0.578	0.567	0.784	0.503	0.382	0.474	0.524	0.423	0.475
Rms (Active Area)	15.253	12.711	11.093	7.555	12.549	11.179	7.896	12.800	11.183	9.544	12.804
Sms (Front Porch)	0.318	0.381	0.023	0.127	0.020	0.018	0.013	0.015	0.014	0.012	0.012

\* B $\mu$ s (Pulse Width) should be more than 0.5  $\mu$ s.

To reduce visual tiredness and eye strain, it is recommended to choose the highest refresh modes available.

# TROUBLESHOOTING

## Troubleshooting

Before calling an authorized service center please check that the items below are properly connected or set.

In case of using a non-standard signal, please check the pin assignments and the signal timing of your adapter with the specifications outlined in sections "Pin Assignment Table" and "Preset Timing Chart".

Problem	Items to check
No picture	<ul style="list-style-type: none"> <li>Power Switch should be in the ON position and the power cord should be properly connected.</li> <li>Check the color of the power LED indicator; if it is orange, then the monitor is in a power saving mode.</li> <li>Check if the horizontal/vertical frequency are out of range.</li> <li>Maximize the Brightness and Contrast controls.</li> </ul>
"No Signal Input" is displayed on the screen	<ul style="list-style-type: none"> <li>The video card should be completely seated in its slot.</li> <li>The computer power switch should be in the ON position.</li> <li>The signal cable should be completely connected to the video card/computer.</li> </ul>
Display image is not centered, too small, or too large	<ul style="list-style-type: none"> <li>Change the Position and Size controls to adjust the image.</li> </ul>
Image is scrolling or unstable	<ul style="list-style-type: none"> <li>The signal cable should be completely attached to the computer.</li> <li>Check the pin assignments and signal timings of the monitor and your video card.</li> </ul>
Picture is fuzzy	<ul style="list-style-type: none"> <li>Adjust the Contrast and Brightness Controls.</li> <li>Push the degauss button once.</li> </ul> <p>CAUTION: A minimum interval of 20 minutes should exist before the degauss button is pressed a second time when not switching between modes. Do not hold the button down continuously.</p>
Picture bounces or a wave pattern is present in the picture	<ul style="list-style-type: none"> <li>Relocate electrical devices that may be causing electrical interference.</li> <li>See the inside front cover of this manual for FCC information.</li> </ul>
Edges of the display image are curved either inward or outward	<ul style="list-style-type: none"> <li>Adjust the Pincushion control.</li> </ul>
Color looks blotchy	<ul style="list-style-type: none"> <li>Press the Degauss button once.</li> </ul>
No Plug & Play functionality	<ul style="list-style-type: none"> <li>Check if the host system is Plug &amp; Play compatible.</li> <li>Check if the VGA card is DDC 1/DDC 2B compatible.</li> <li>Check if Window '95 is installed and the software key for DDC function is enabled).</li> </ul>

Our PR705F has built-in Trinitron® CRT. The CRT is sensitive to shocks and vibrations that may occur during transportation. Following are some adjustment tips when below mentioned symptoms occur.

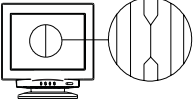
Symptom	Tip
Two horizontal lines are visible on the screen 	<ul style="list-style-type: none"> <li>This is normal characteristic of Trinitron® CRT.</li> <li>These are damper wires which are attached to the aperture grille are designed to dampen and prevent shock and vibration in the aperture grill.</li> </ul>
Black fine vertical lines are visible on the screen. Shock and vibration may cause the aperture grill to misalign resulting in a few fine black vertical lines across the screen 	<ul style="list-style-type: none"> <li>Degaussing the screen.</li> <li>Tap lightly (do not hit) the side of the monitor.</li> </ul> <p>If above mentioned remedies do not work, please do the following:</p> <ol style="list-style-type: none"> <li>Display full white window or wallpaper background over the area where the black lines appears.</li> <li>Set Contrast and Brightness to the maximum, wait for a moment until the problem is corrected. You may try to tap lightly the side of the monitor to help expedite the alignment.</li> </ol>

# DIMENSIONS

English

unit: mm

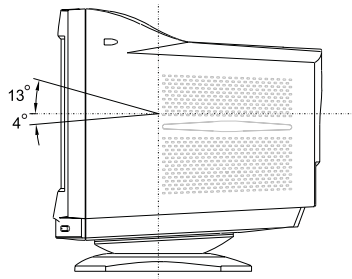
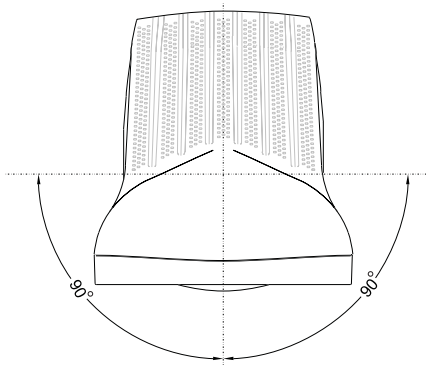
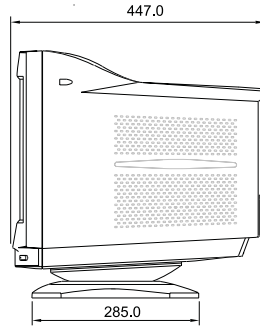
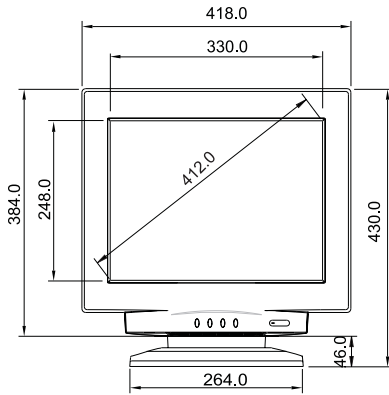

## PLUG & PLAY: DISPLAY DATA CHANNEL (DDC)



Notice : This monitor is equipped with Plug & Play capability(VESA DDC 1/2B). To utilize this capability, your graphic card and hosting system have to be Plug & Play compatible as well. When properly plugged(Plug), the graphic card and hosting system will automatically (Play)identify, configure, and most importantly, optimize this monitor's capabilities, providing you with simple and easy installation and setup.

## MANUFACTURER'S LIMITED WARRANTY

The Manufacturer guarantees the Purchaser of this product with one-year free parts & labor warranty in the unlikely event of product defect caused by material or workmanship. The product should be returned with **original packaging, proof of purchase, or RMA Number**. Furthermore, it is understood and agreed that the returned product is freightage-prepaid and fully-insured for one-way transit by the Purchaser within valid warranty period. The defective monitor will be repaired and/or replaced depending on the defective condition verified by technicians, or authorized/approved service companies. Due to world-wide distribution of this product, various customized-warranty of this product may be provided from country to country, please check the enclosed WARRANTY CARD, or, contact your local vendors, for different warranty details at your best interest.



## Free Manuals Download Website

<http://myh66.com>

<http://usermanuals.us>

<http://www.somanuals.com>

<http://www.4manuals.cc>

<http://www.manual-lib.com>

<http://www.404manual.com>

<http://www.luxmanual.com>

<http://aubethermostatmanual.com>

Golf course search by state

<http://golfingnear.com>

Email search by domain

<http://emailbydomain.com>

Auto manuals search

<http://auto.somanuals.com>

TV manuals search

<http://tv.somanuals.com>