

SACD/DVD Player

Operating Instructions



SUPER AUDIO CD



DVP-NS700V

© 2001 Sony Corporation

WARNING

To prevent fire or shock hazard, do not expose the unit to rain or moisture.

To avoid electrical shock, do not open the cabinet. Refer servicing to qualified personnel only.

Power cord (mains lead) must only be changed at a qualified service shop.

CAUTION

The use of optical instruments with this product will increase eye hazard. As the laser beam used in this SACD/DVD player is harmful to eyes, do not attempt to disassemble the cabinet.

Refer servicing to qualified personnel only.

Precautions

Safety

The power requirements and power consumption of this unit are indicated on the back of the unit. Check that the unit's operating voltage is identical with your local power supply.

Power requirements and power consumption →



Installing

- Allow adequate air circulation to prevent internal heat buildup.
- Do not install the unit in an inclined position. It is designed to be operated in a horizontal position only.
- Keep the unit and discs away from equipment with strong magnets, such as microwave ovens, or large loudspeakers.
- Do not place heavy objects on the unit.

Welcome!

Thank you for purchasing this Sony SACD/DVD Player. Before operating this player, please read this manual thoroughly and retain it for future reference.

For the model supplied with the AC plug adaptor

If the AC plug of your unit does not fit into the wall outlet, attach the supplied AC plug adaptor.

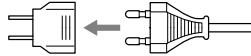

Precautions

On safety

- Caution – The use of optical instruments with this product will increase eye hazard.
- Should any solid object or liquid fall into the cabinet, unplug the player and have it checked by qualified personnel before operating it any further.

On power sources

- The player is not disconnected from the AC power source (mains) as long as it is connected to the wall outlet, even if the player itself has been turned off.
- If you are not going to use the player for a long time, be sure to disconnect the player from the wall outlet. To disconnect the AC power cord (mains lead), grasp the plug itself; never pull the cord.

On placement

- Place the player in a location with adequate ventilation to prevent heat build-up in the player.
- Do not place the player on a soft surface such as a rug that might block the ventilation holes on the bottom.
- Do not place the player in a location near heat sources, or in a place subject to direct sunlight, excessive dust, or mechanical shock.

On operation

- If the player is brought directly from a cold to a warm location, or is placed in a very damp room, moisture may condense on the lenses inside the player. Should this occur, the player may not operate properly. In this case, remove the disc and leave the player turned on for about half an hour until the moisture evaporates.
- When you move the player, take out any discs. If you don't, the disc may be damaged.

On adjusting volume

Do not turn up the volume while listening to a section with very low level inputs or no audio signals. If you do, the speakers may be damaged when a peak level section is played.

On cleaning

Clean the cabinet, panel, and controls with a soft cloth slightly moistened with a mild detergent solution. Do not use any type of abrasive pad, scouring powder or solvent such as alcohol or benzine.

If you have any questions or problems concerning your player, please consult your nearest Sony dealer.

On cleaning discs

Do not use a commercially available cleaning disc. It may cause a malfunction.

IMPORTANT NOTICE

Caution: This player is capable of holding a still video image or on-screen display image on your television screen indefinitely. If you leave the still video image or on-screen display image displayed on your TV for an extended period of time you risk permanent damage to your television screen. Projection televisions are especially susceptible to this.



Table of Contents

WARNING	2
Welcome!	2
Precautions	3
About this Manual	6
This Player Can Play the Following Discs	6
Notes about the Discs	7
Index to Parts and Controls	8
Guide to the Control Menu Display	12
<hr/>	
Getting Started	15
Quick Overview	15
Step 1: Unpacking	15
Step 2: Inserting Batteries into the Remote	15
Step 3: TV Hookups	16
Step 4: Playing a Disc	18
<hr/>	
Hookups	19
Hooking Up the Player	19
Step 1: Connecting the Video Cords	19
Step 2: Connecting the Audio Cords	21
Step 3: Connecting the Power Cord	28
Step 4: Quick Setup	28
<hr/>	
Playing Discs	33
Playing Discs	33
Resuming Playback from the Point Where You Stopped the Disc (Resume Play)	34
Using the DVD's Menu	35
Selecting "ORIGINAL" or "PLAY LIST" on a DVD-RW Disc	36
Selecting a Playback Area for an SACD Disc	37
Playing VIDEO CDs with PBC Functions (PBC Playback)	38
Various Play Mode Functions (Programme Play, Shuffle Play, Repeat Play, A-B Repeat Play)	39
<hr/>	
Searching for a Scene	45
Searching for a Particular Point on a Disc (Search, Scan, Slow-motion Play, Freeze Frame)	45
Searching for a Title/Chapter/Track/Index/Scene	47
Searching by Scene (VIEWER)	48

Viewing Information About the Disc	50
Viewing the Playing Time and Remaining Time on the Front Panel Display	50
Checking the Playing Time and Remaining Time	51
Checking the Play Information (ADVANCED)	53
<hr/>	
Sound Adjustments	54
Changing the Sound	54
SURROUND Mode Settings	56
<hr/>	
Enjoying Movies	60
Changing the Angles	60
Displaying the Subtitles	61
Adjusting the Picture Quality (BNR)	62
Adjusting the Playback Picture (VIDEO EQUALIZER)	63
Enhancing the Playback Picture (DIGITAL VIDEO ENHANCER)	64
<hr/>	
Using Various Additional Functions	65
Locking Discs (CUSTOM PARENTAL CONTROL, PARENTAL CONTROL)	65
Operation Sound Effects (Sound Feedback)	69
Controlling Your TV or AV Amplifier (Receiver) with the Supplied Remote	70
<hr/>	
Settings and Adjustments	74
Using the Setup Display	74
Setting the Display or Sound Track Language (LANGUAGE SETUP)	75
Settings for the Display (SCREEN SETUP)	76
Custom Settings (CUSTOM SETUP)	78
Settings for the Sound (AUDIO SETUP)	79
Settings for the Speakers (SPEAKER SETUP)	82
<hr/>	
Additional Information	86
Troubleshooting	86
Self-diagnosis Function (When letters/numbers appear in the display)	89
Glossary	89
Specifications	92
Language Code List	93
List of Setup Display Items	94
Index	98

About this Manual



- Instructions in this manual describe the controls on the remote. You can also use the controls on the player if they have the same or similar names as those on the remote.
- Displays on the screen are slightly different depending on the player model. Illustrations of the on-screen display in this manual are for one of the player models.
- The meaning of the icons used in this manual is described below:

Icon	Meaning
	Functions available for DVD VIDEOS or DVD-Rs/DVD-RWs in Video mode
	Functions available for DVD-RWs in VR (Video Recording) mode
	Functions available for VIDEO CDs or CD-Rs/CD-RWs
	Functions available for Super Audio CDs
	Functions available for music CDs or CD-Rs/CD-RWs
	More convenient features

“DVD” may be used as a general term for DVD VIDEOS, DVD-Rs, and DVD-RWs.

This Player Can Play the Following Discs

Format of discs	
DVD VIDEO	
DVD-RW	

Format of discs	
SACD	
VIDEO CD	
Music CD	

“DVD VIDEO” and “DVD-RW” are trademarks.

Region code

Your player has a region code printed on the back of the unit and only will play DVD VIDEO discs (playback only) labelled with identical region codes.

DVDs labelled  will also play on this player.

If you try to play any other DVD, the message “Playback prohibited by area limitations.” will appear on the TV screen. Depending on the DVD, no region code indication may be labelled even though playing the DVD is prohibited by area restrictions.



Example of discs that the player cannot play

The player cannot play the following discs:

- CD-ROMs (PHOTO CDs included)
- All CD-Rs/CD-RWs other than music and VCD format CD-Rs/CD-RWs
- Data part of CD-Extras
- DVD-ROMs
- DVD Audio discs

Also, the player cannot play the following discs:

- A DVD with a different region code (page 89).
- A disc that has a non-standard shape (e.g., card, heart).
- A disc with paper or stickers on it.
- A disc that has the adhesive of cellophane tape or a sticker still left on it.

Note

Some DVD-Rs, DVD-RWs, CD-Rs, or CD-RWs cannot be played on this player due to the recording quality or physical condition of the disc, or the characteristics of the recording device. DVD-RWs in VR mode may also take time to play back due to the recording condition.

Furthermore, the disc will not play if it has not been correctly finalized. For more information, see the operating instructions for the recording device.

Note on playback operations of DVDs and VIDEO CDs

Some playback operations of DVDs and VIDEO CDs may be intentionally set by software producers. Since this player plays DVDs and VIDEO CDs according to the disc contents the software producers designed, some playback features may not be available. Also, refer to the instructions supplied with the DVDs or VIDEO CDs.

Copyrights

This product incorporates copyright protection technology that is protected by method claims of certain U.S. patents, other intellectual property rights owned by Macrovision Corporation, and other rights owners. Use of this copyright protection technology must be authorized by Macrovision Corporation, and is intended for home and other limited viewing uses only unless otherwise authorized by Macrovision Corporation. Reverse engineering or disassembly is prohibited.

Notes about the Discs

On handling discs

- To keep the disc clean, handle the disc by its edge. Do not touch the surface.



- Do not expose the disc to direct sunlight or heat sources such as hot air ducts, or leave it in a car parked in direct sunlight as the temperature may rise considerably inside the car.
- After playing, store the disc in its case.

On cleaning

- Before playing, clean the disc with a cleaning cloth. Wipe the disc from the centre out.



- Do not use solvents such as benzine, thinner, commercially available cleaners, or anti-static spray intended for vinyl LPs.

Index to Parts and Controls

For more information, refer to the pages indicated in parentheses.

Front Panel

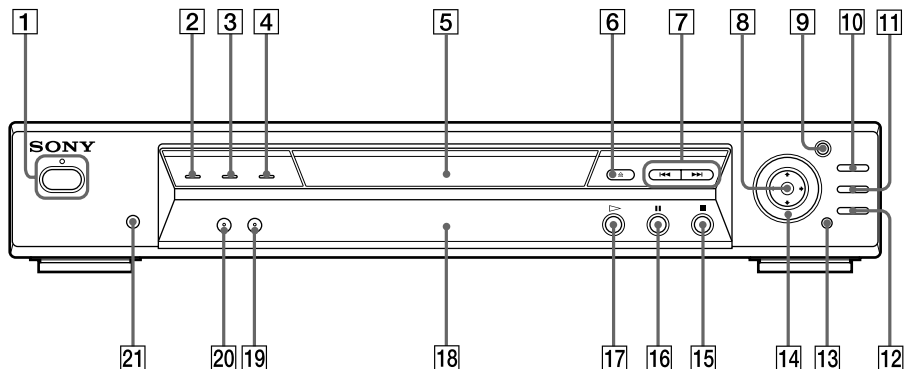

- | | |
|--|---|
| 1 POWER switch/indicator (33) | 11 MENU button (35) |
| 2 DVD indicator
Lights up when the disc is a DVD | 12 ⏪ RETURN button (38) |
| 3 SACD indicator
Lights up when the disc is an SACD | 13 DISPLAY button (12) |
| 4 MULTI CHANNEL indicator
Lights up when:
— playing a disc that contains more than
3 audio signal channels
— the disc is not inserted | 14 Click shuttle (46) |
| 5 Disc tray (33) | 15 ■ (stop) button (33) |
| 6 ⏏ (open/close) button (33) | 16 (pause) button (34) (69) |
| 7 ⏮/⏭ (previous/next) buttons (34) | 17 ▷ (play) button (33) |
| 8 ⏪/⏩/⏴/⏵/ENTER buttons (28) | 18 Front panel display (9) |
| 9 JOG button/indicator (46) | 19 SURROUND button/indicator (56) |
| 10 TOP MENU button (35) | 20 BNR (Block Noise Reduction) button/
indicator (62) |
| | 21 📶 (remote sensor) (15) |

Front panel display

When playing back a DVD VIDEO/DVD-RW

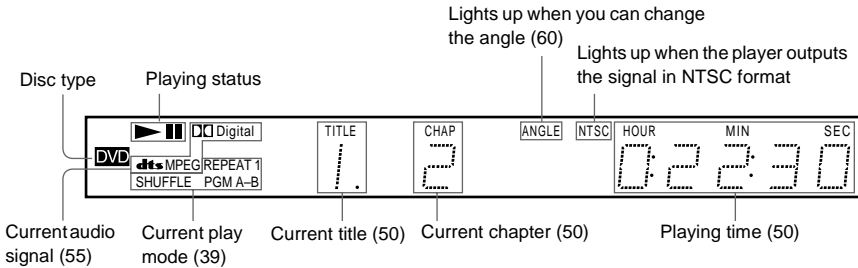

When playing back a VIDEO CD (PBC)

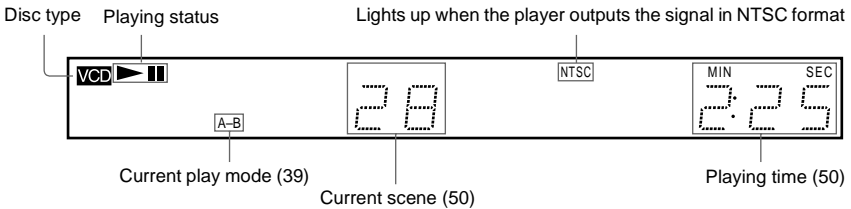

When playing back an SACD, CD, or VIDEO CD (without PBC)

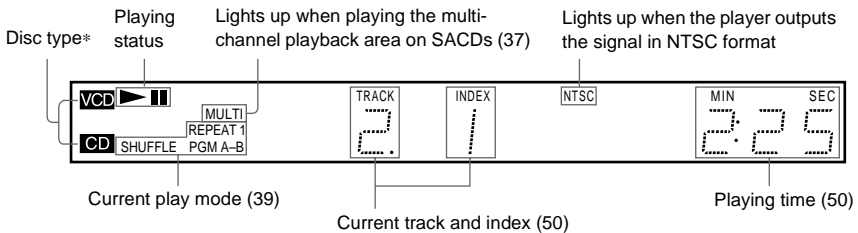

* When playing the SACD layer of SACD discs, the disc type is not displayed.

Rear Panel

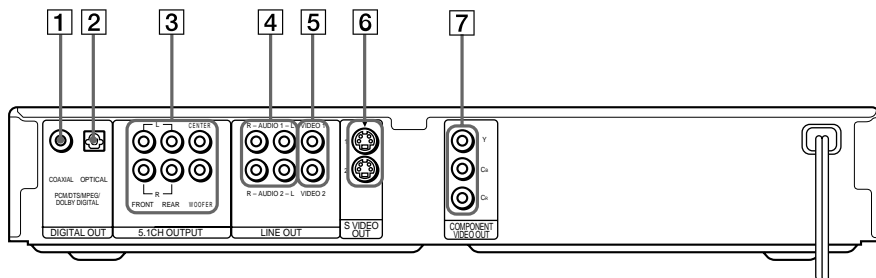

1 DIGITAL OUT (COAXIAL) jack (23)
(25) (26)

2 DIGITAL OUT (OPTICAL) jack (23)
(25) (26)

3 5.1CH OUTPUT jacks (23)

4 LINE OUT L/R (AUDIO) 1/2 jacks (22)
(25) (26)

5 LINE OUT (VIDEO) 1/2 jacks (19)

6 S VIDEO OUT 1/2 jacks (19)

7 COMPONENT VIDEO OUT jacks (19)

Remote

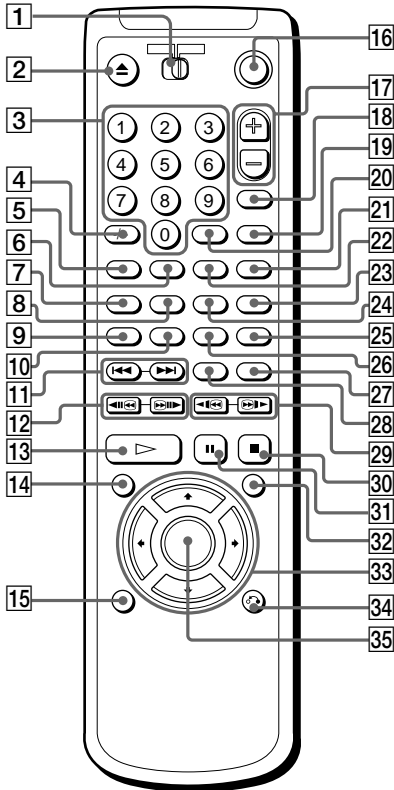

- 1** TV/DVD switch (71)
- 2** ▲ OPEN/CLOSE button (34)
- 3** Number buttons (35)
The number 5 button has a tactile dot.
- 4** CLEAR/-/- (ten's digit)* button (39) (71)
- 5** SACD MULTI/2CH button (37)
- 6** SACD/CD button (37)
- 7** AUDIO button (54)
- 8** ANGLE button (60)
- 9** SHUFFLE button (41)
- 10** PROGRAM button (39)
- 11** ◀▶ PREV (previous)/NEXT buttons (34)
- 12** ◀◀▶▶ SEARCH/STEP buttons (45)
- 13** ▷ PLAY button (33)
The ▷ button has a tactile dot.
- 14** TOP MENU button (35)
- 15** DISPLAY button (39)
- 16** I/⏻ (on/standby) button (33) (71)
- 17** VOL (volume) +/- buttons (71)
The + button has a tactile dot.
- 18** TV/VIDEO button (71)
- 19** DVE (Digital Video Enhancer)/ WIDE MODE button (64) (71)
- 20** ENTER button
- 21** BNR (Block Noise Reduction) button (62)
- 22** SEARCH MODE button (47)
- 23** TIME/TEXT button (50)
- 24** SUBTITLE button (61)
- 25** A-B button (43)
- 26** REPEAT button (42)
- 27** REPLAY button (34)
- 28** SURROUND button (56)
- 29** ◀◀▶▶ SCAN/SLOW buttons (45)
- 30** ■ STOP button (33)
- 31** || PAUSE button (34)
- 32** MENU button (35)
- 33** ←/↑/↓/→ buttons (28)
- 34** ↻ RETURN button (38)
- 35** ENTER button (28)

* Remote RMT-D131E and RMT-D131O only







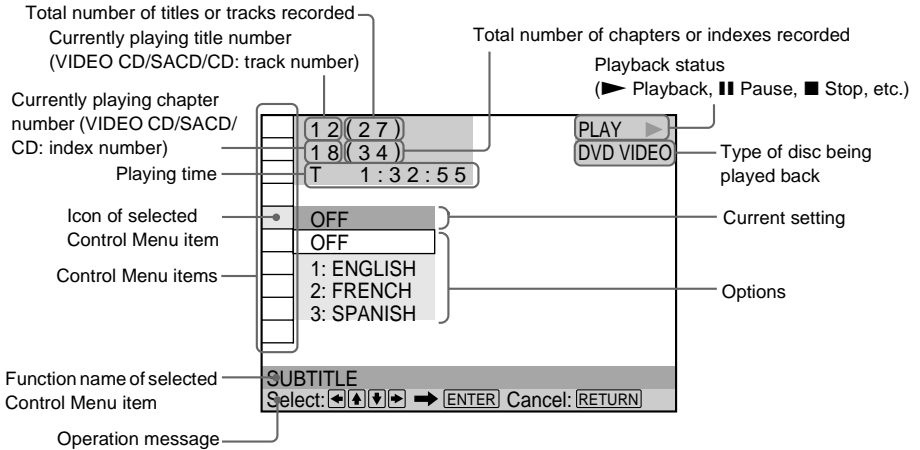

Guide to the Control Menu Display















Use the Control Menu to select a function that you would like to use. The Control Menu display appears when the DISPLAY button is pressed. For details, please refer to the page in parentheses.

Control Menu



List of Control Menu Items



 TITLE (page 47)/SCENE (page 47)/TRACK (page 47)	Selects the title, scene, or track to be played.
 CHAPTER (page 47)/INDEX (page 47)	Selects the chapter or index to be played.
 TRACK (page 47)	Selects the track to be played.
 INDEX (page 47)	Selects the index to be played.
 TIME/TEXT (page 47)	Checks the elapsed time and the remaining playback time. Input the time code for picture and music searching. Displays the DVD or the SACD/CD text.
 ORIGINAL/PLAY LIST (page 36)	Selects the type of titles (DVD-RW) to be played, the ORIGINAL one, or an edited PLAY LIST.
 AUDIO (page 54)	Changes the audio setting.
 MULTI/2CH (page 37)	Selects the playback area on 2 channel+Multi-channel SACDs.

	SUBTITLE (page 61)	Displays the subtitles. Changes the subtitle language.
	ANGLE (page 60)	Changes the angle.
	SURROUND (page 56)	Selects the surround functions.
	ADVANCED (page 53)	Checks the information (bit rate or layer) on the disc while playing a DVD.
	PARENTAL CONTROL (page 65)	Sets the disc to prohibit playing.
	SETUP (page 74)	<p>QUICK Setup (page 28) Use Quick Setup to choose the desired language of the on-screen display, the aspect ratio of the TV, the audio output, and the appropriate speaker settings.</p> <p>CUSTOM Setup In addition to the Quick Setup setting, you can adjust the image and sound quality, and other various settings.</p> <p>RESET Returns the settings in “SETUP” to the default setting.</p>
	PROGRAM (page 39)	Selects the title, chapter, or track to play a disc in the order you want.
	SHUFFLE (page 41)	Plays the title, chapter, or track in random order.
	REPEAT (page 42)	Plays the entire disc (all titles/all tracks) repeatedly or one title/chapter/track repeatedly.
	A-B REPEAT (page 43)	Specifies the parts you want to play repeatedly.
	BNR (page 62)	Adjusts the picture quality by reducing the “block noise” or mosaic like patterns that appear on your TV screen.
	VIDEO EQUALIZER (page 63)	Adjusts the video signal from the player. You can select the picture quality that best suits the programme you are watching.
	DIGITAL VIDEO ENHANCER (page 64)	Exaggerates the outline of the image to produce a sharper picture.
	VIEWER (page 48)	Divides the screen into 9 subscreens to help you find the scene you want quickly.

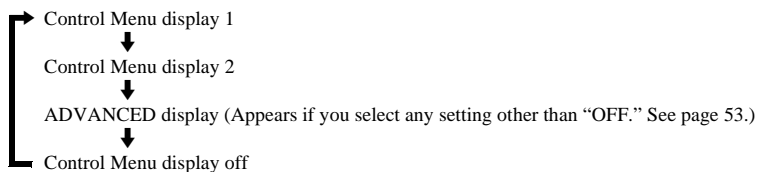
💡 Each time you press DISPLAY, the Control Menu display changes as follows:



When playing an SACD/CD disc, only the Control Menu display 1 will appear. The Control Menu items are different depending on the disc.

💡 The Control Menu icon indicator lights up in green  →  when you select any item except "OFF." ("SURROUND," "PROGRAM," "SHUFFLE," "REPEAT," "A-B REPEAT," "BNR," "DIGITAL VIDEO ENHANCER" only). The "ANGLE" indicator lights up in green only when the angles can be changed. The "VIDEO EQUALIZER" indicator lights up in green when any setting other than "STANDARD" is selected.

Quick Overview

A quick overview presented in this chapter will give you enough information to start using the player for your enjoyment. To use the surround sound features of this player, refer to “Hookups” on page 19.

Notes

- You cannot connect this player to a TV that does not have a video input jack.
- Be sure to turn off the power of each component before connecting.

Step 1: Unpacking

Check that you have the following items:

- Audio/video cord (pinplug × 3 ↔ pinplug × 3) (1)
- Remote commander (remote) (1)
- Size R6 (AA) batteries (2)
- A plug adaptor is included with some models.

Step 2: Inserting Batteries into the Remote

You can control the player using the supplied remote. Insert two size R6 (AA) batteries by matching the ⊕ and ⊖ ends on the batteries to the markings inside the compartment. When using the remote, point it at the remote sensor  on the player.

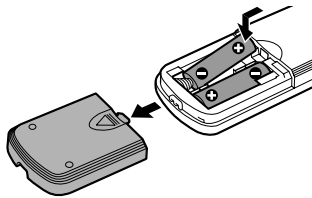

Notes

- Do not leave the remote in an extremely hot or humid place.
- Do not drop any foreign object into the remote casing, particularly when replacing the batteries.
- Do not expose the remote sensor to direct light from the sun or a lighting apparatus. Doing so may cause a malfunction.
- If you do not use the remote for an extended period of time, remove the batteries to avoid possible damage from battery leakage and corrosion.

Step 3: TV Hookups

Connect the supplied audio/video cord and power cord (mains lead) in the order (1~3) shown below. Be sure to connect the power cord (mains lead) last.

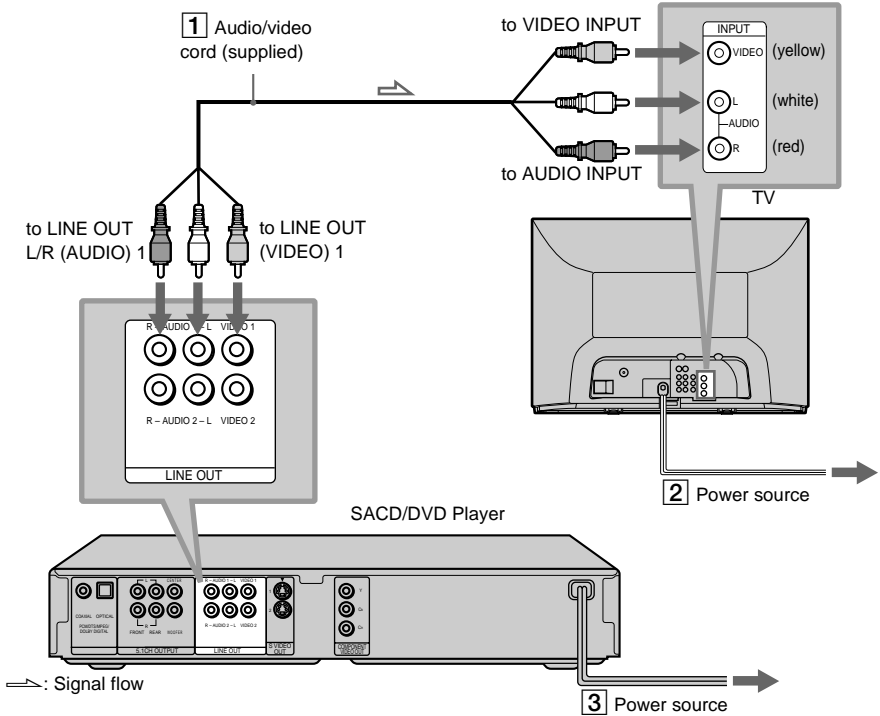

When connecting to a standard 4:3 screen TV

Depending on the disc, the image may not fit your TV screen. If you want to change the aspect ratio, please refer to page 76.

To change the colour system

The colour system of the player is set to NTSC or PAL. If the on-screen display of the player does not appear on the TV, change the colour system of the player to the same colour system (PAL or NTSC) of your TV. To change the colour system, hold POWER down while pressing **■** on the player. The power indicator lights up in green and changes to red. Then release **■**.

 This player switches the colour system, PAL or NTSC, according to the connected TV. To check the colour system of the player, press POWER on the player and then press **I/O** on the remote. The power indicator lights up in green. When "NTSC" appears on the front panel display, the colour system of the player is set to NTSC. When "NTSC" does not appear, the colour system is set to PAL.

Step 4: Playing a Disc

- 1 Turn on the TV.
- 2 Switch the input selector on the TV to the player.

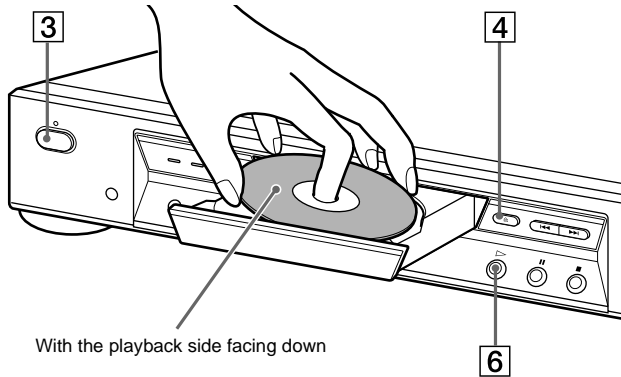

- 3 Press **POWER** on the player.
- 4 Press \triangleleft on the player to open the disc tray.
- 5 Place the disc on the tray with the playback side facing down.
- 6 Press \triangleright .
The disc tray closes and the player begins playing the disc.

After Step 6

Depending on the disc, a menu may be displayed on the TV screen. If so, select the item you want from the menu and play the DVD VIDEO (page 35) or VIDEO CD disc (page 38).

To stop playing

Press \blacksquare .

To take out the disc

Press \triangleleft .

To turn off the player

Press I/O on the remote. The player is set to standby mode and the power indicator lights up in red. Press **POWER** on the player to turn off completely.

Hooking Up the Player

Follow Steps 1 to 4 to hook up and adjust the settings of the player.

Before you start, turn off the power, check that you have all of the supplied accessories, and insert the batteries into the remote (page 15).

Notes

- Plug cords securely to prevent unwanted noise.
- Refer to the instructions supplied with the components to be connected.

Step 1: Connecting the Video Cords

Connect this player to your TV monitor, projector, or AV amplifier (receiver) using a video cord. Select one of the patterns **A** through **C**, according to the input jack on your TV monitor, projector, or AV amplifier (receiver).

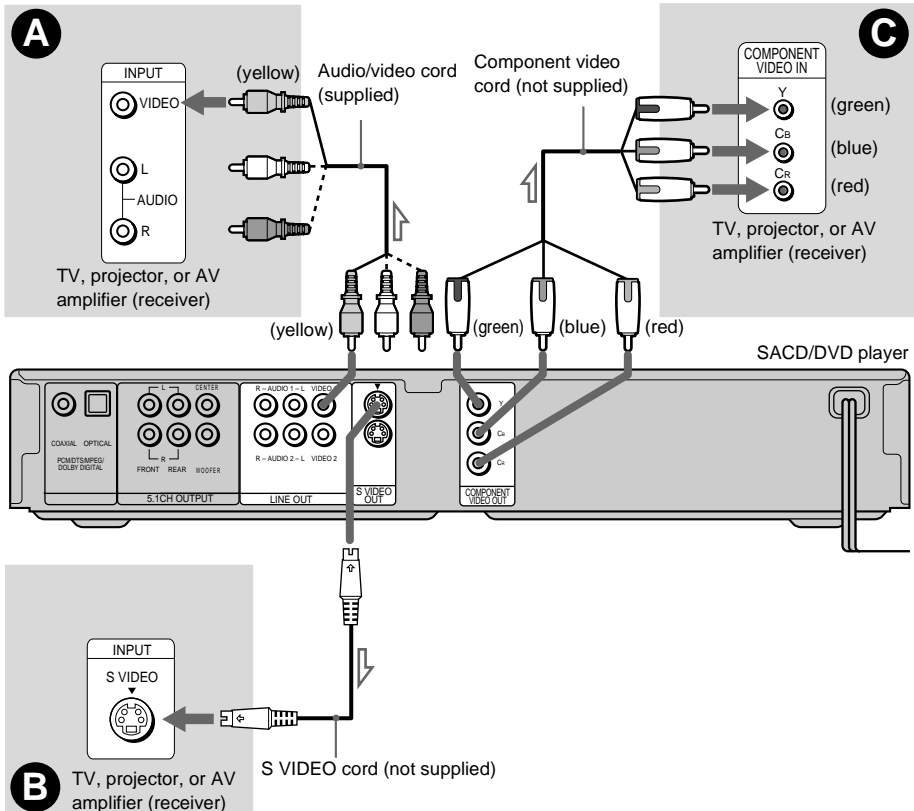

→ : Signal flow

continued

A If you are connecting to a video input jack

Connect the yellow plug of the audio/video cord (supplied) to the yellow (video) jacks. You will enjoy standard quality images.

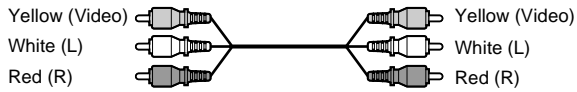

Use the red and white plugs to connect to the audio input jacks (page 22).

B If you are connecting to an S VIDEO input jack

Connect the S VIDEO cord (not supplied). You will enjoy high quality images.



C If you are connecting to a monitor, projector, or AV amplifier (receiver) having component video input jacks (Y, C_B, C_R)

Connect the component via the COMPONENT VIDEO OUT jacks using a component video cord (not supplied) or three video cords (not supplied) of the same kind and length. You will enjoy accurate colour reproduction and high quality images.

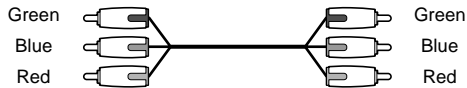

Notes

- This player switches the colour system, PAL or NTSC, according to the connected TV (page 16).
- Do not connect the player to a VCR. If you pass the player signals via the VCR, you may not receive a clear image on the TV screen.

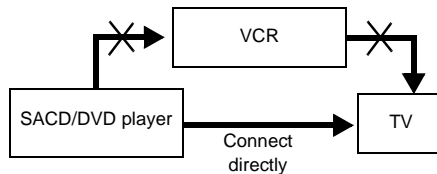

Step 2: Connecting the Audio Cords

Refer to the chart below to select the connection that best suits your system. The surround effects you will enjoy depend on the connections and components you use.

Select a connection

Select one of the following connections, **A** through **D**.

Connection	Components to be connected
A (page 22)	TV (stereo)
B (page 23)	AV amplifier (receiver) having 5.1ch input jacks <ul style="list-style-type: none"> • 4 speakers (front L and R, rear L and R) • 6 speakers (front L and R, centre, rear L and R, subwoofer)
B (page 23)	AV amplifier (receiver) having a Dolby [*] Digital, MPEG audio, or DTS ^{**} decoder and a digital input jack <ul style="list-style-type: none"> • 6 speakers (front L and R, centre, rear L and R, subwoofer)
C (page 25)	Stereo amplifier (receiver) (having L and R audio input jacks only, or having a digital input jack) <ul style="list-style-type: none"> • 2 speakers (front L and R)
C (page 25)	MD deck/DAT deck
D (page 26)	AV amplifier (receiver) with a Dolby Surround (Pro Logic) decoder (having L and R audio input jacks only, or having a digital input jack) <ul style="list-style-type: none"> • 3 speakers (front L and R, and rear (monaural)) • 6 speakers (front L and R, centre, rear L and R, subwoofer)

 To enjoy SACD Multi or 96kHz/24bit sound, use the connection **B**.

* Manufactured under license from Dolby Laboratories. "Dolby," "Pro Logic," and the double-D symbol are trademarks of Dolby Laboratories. Confidential unpublished works. © 1992-1997 Dolby Laboratories. All rights reserved.

** Manufactured under license from Digital Theater Systems, Inc. US Pat. No. 5,451,942 and other world-wide patents issued and pending. "DTS" and "DTS Digital Surround" are trademarks of Digital Theater Systems, Inc. © 1996 Digital Theater Systems, Inc. All rights reserved.

A Connecting to your TV

This connection will use your TV speakers for sound.

■ Recommended surround sound effects for this connection

- TVS DYNAMIC (page 56)
- TVS WIDE (page 56)

SACD/DVD player

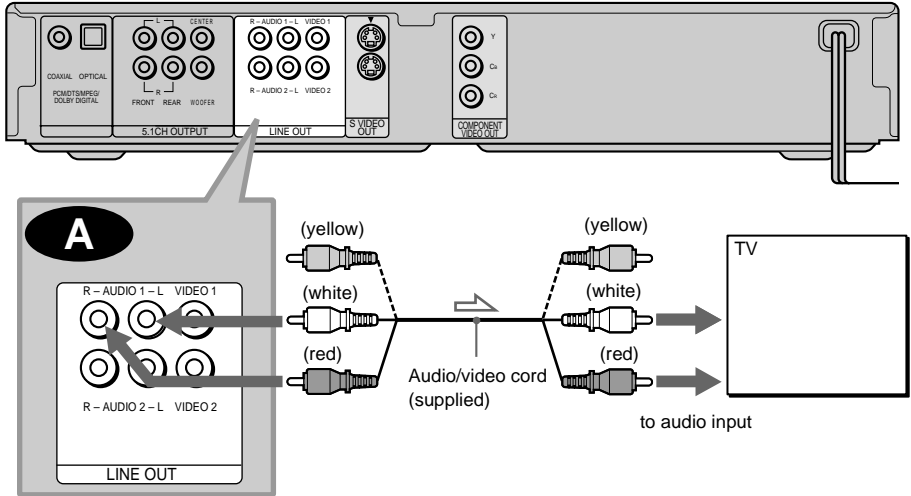

⇒ : Signal flow

The yellow plug is used for video signals (page 19).

B Connecting to an AV amplifier (having 5.1ch input jacks or a digital input jack) and 4 to 6 speakers

If your AV amplifier (receiver) has 5.1 channel inputs, use **B-1**.

If you want to use the Dolby Digital, MPEG audio, or DTS decoder function on your AV amplifier (receiver), connect to its digital jack using **B-2**. With the following connections, you can enjoy a more realistic audio presence in the comfort of your own home.

B-1: Connecting to the 5.1ch input jacks

You can enjoy 5.1ch surround sound using the internal Dolby Digital, MPEG audio, DTS, or SACD Multi decoder of this player. You can also enjoy Dolby Surround (Pro Logic) sounds, or surround sounds using various “SURROUND” modes (page 56).

■ Recommended surround sound effects for this connection

When 6 speakers are connected. (Set “SURROUND” to “OFF.”)

- Dolby Digital (5.1ch) (page 89)
- DTS (5.1ch) (page 89)
- SACD Multi channel (page 89)
- MPEG audio (5.1ch) (page 89)

B-2: Connecting to a digital jack

This connection will allow you to use the Dolby Digital, MPEG audio, or DTS decoder function of your AV amplifier (receiver). You are not able to enjoy the surround sound effects of the player.

■ Recommended surround sound effects using this connection with your amplifier (receiver)

- Dolby Digital (5.1ch) (page 89)
- DTS (5.1ch) (page 89)
- MPEG audio (5.1ch) (page 89)
- 96kHz/24bit PCM

Notes

- After you have completed the connection, be sure to set “DOLBY DIGITAL” to “DOLBY DIGITAL” (page 28) and “DTS” to “DTS” (page 28). If your AV amplifier (receiver) has a MPEG decoder function, set “MPEG” to “MPEG” (page 80). Otherwise, no sound or a loud noise will come from the speakers.
- When you connect an amplifier (receiver) that conforms to the 96kHz sampling frequency, set “48kHz/96kHz PCM” to “96kHz/24bit” (page 80).
- SACD audio signals are not output from the digital jack.

SACD/DVD player

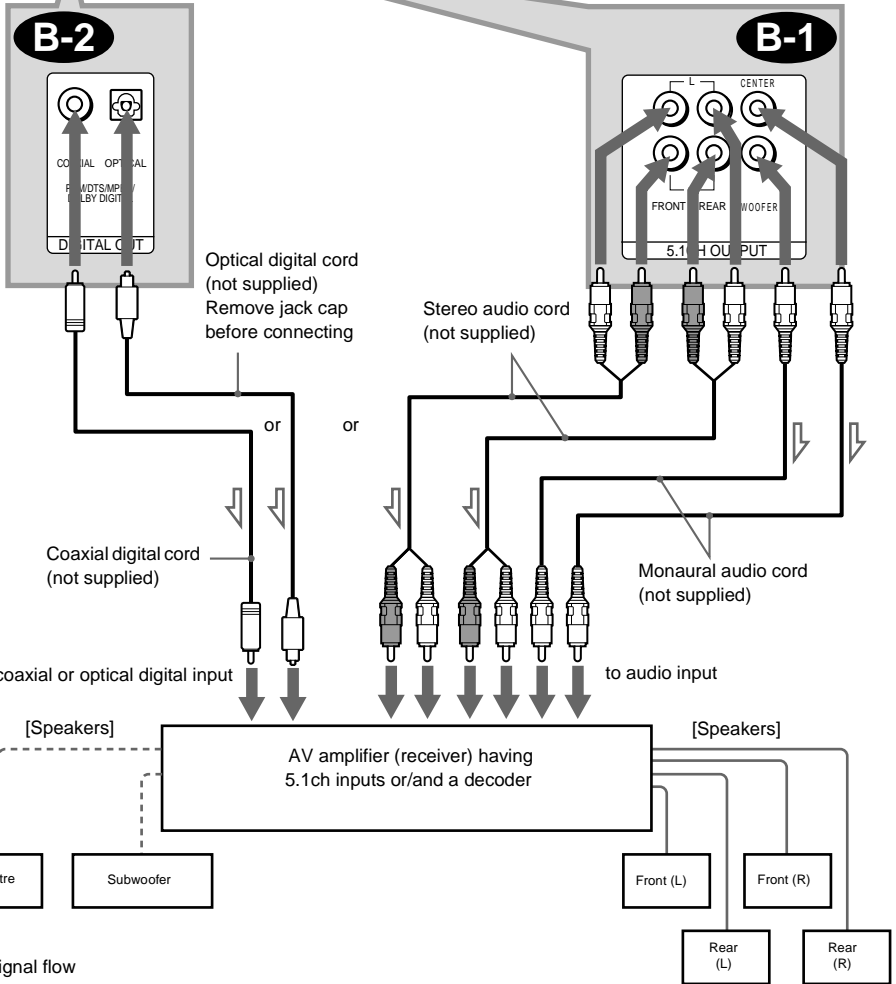
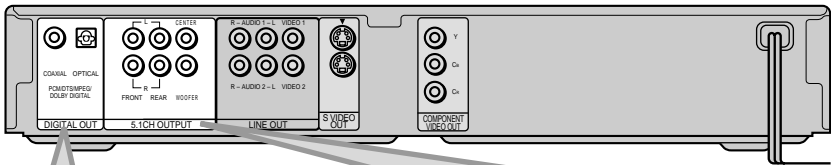

To enhance the surround sound effects:

- Use high-performance speakers.
- Use front, rear, and centre speakers having the same size and performance.
- Place a subwoofer between the right and left front speakers.
- When using connection **B-2**, refer to the operating instructions of the receiver (amplifier) for correct speaker setting location.

C Connecting to a stereo amplifier (receiver) and 2 speakers/Connecting to an MD deck or DAT deck

This connection will use your 2 front speakers connected to your stereo amplifier (receiver) for sound. If the stereo amplifier (receiver) has audio input jacks L and R only, use **C-1**. If the amplifier (receiver) has a digital input jack, use **C-2**. When connecting to an MD deck or a DAT deck, use **C-2**. In this case, you can also connect the player directly to the MD deck or DAT deck without using your stereo amplifier (receiver).

Recommended surround sound effects for the **C-1** connection only

- TVS STANDARD (page 56)

💡 In connection **C-1**, you can use the supplied audio/video cord instead of using a separate audio cord.

💡 To realize better surround sound effects, make sure that your listening position is in between your speakers.

Note

SACD audio signals are not output from the digital jack.

SACD/DVD player

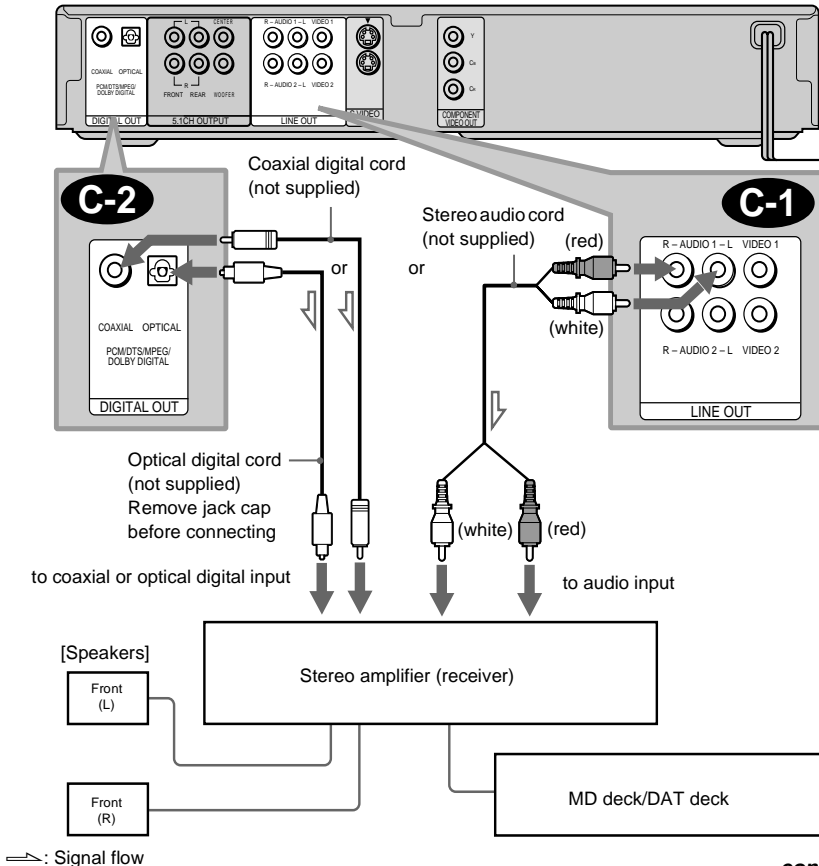

continued

D Connecting to an AV amplifier (receiver) having a Dolby Surround (Pro Logic) decoder and 3 to 6 speakers

This connection will allow you to enjoy the surround effects of the Dolby Surround (Pro Logic) decoder on your amplifier (receiver). If you have an AV amplifier (receiver) equipped with a Dolby Digital, MPEG audio, or DTS decoder, refer to page 23.

You can enjoy the Dolby Surround effects only when playing Dolby Surround audio or multi-channel audio (Dolby Digital) discs.

This connection needs a minimum of 3 speakers (front L and R, and rear (monaural)). The surround effects are enhanced if 6 speakers (front L and R, centre, rear L and R, and subwoofer) are used.

If your amplifier (receiver) has L and R audio input jacks only, use **D-1**. If your amplifier (receiver) has a digital input jack, use **D-2**.

Recommended surround sound effects using this connection with your amplifier (receiver)

- Dolby Surround (Pro Logic) (page 89)

 For correct speaker setting location, please refer to the operating instructions of the amplifier (receiver).

Note

SACD audio signals are not output from the digital jack.

SACD/DVD player

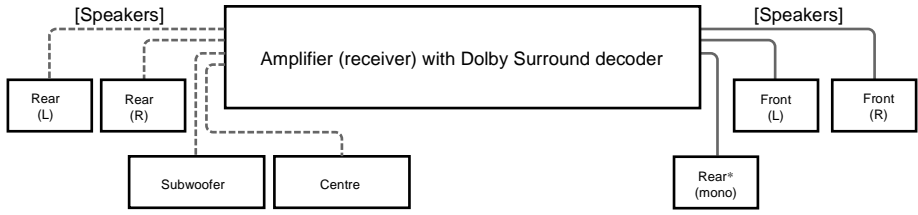
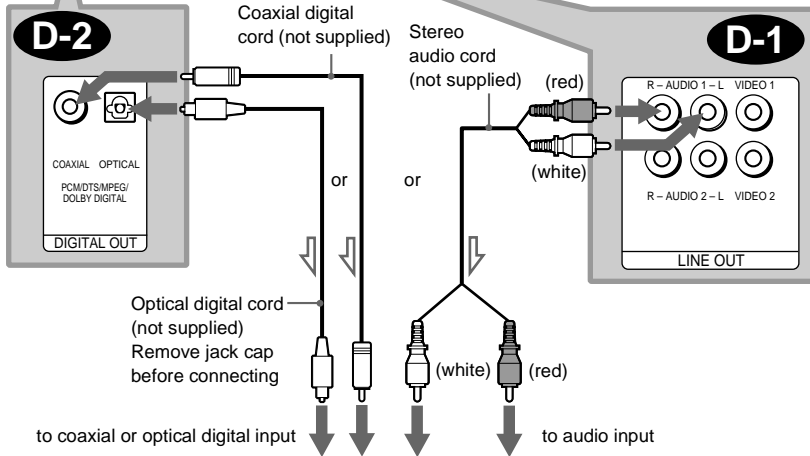
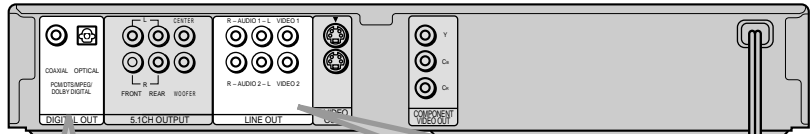

→: Signal flow

*When connecting 6 speakers, replace the monaural rear speaker with a centre speaker, 2 rear speakers and a subwoofer.

Step 3: Connecting the Power Cord

Plug the player and TV power cord (mains lead) into an AC outlet (mains).

Do not connect the AC power cord (mains lead) of your player to the “switched” power source of an amplifier (receiver). When you turn off the power of your amplifier (receiver), the menu setting for the player such as Playback Memory may be lost.

Step 4: Quick Setup

Follow the steps below to make the minimum number of basic adjustments for using the player. To skip an adjustment, press **▶▶I**. To return to the previous adjustment, press **I◀◀**.

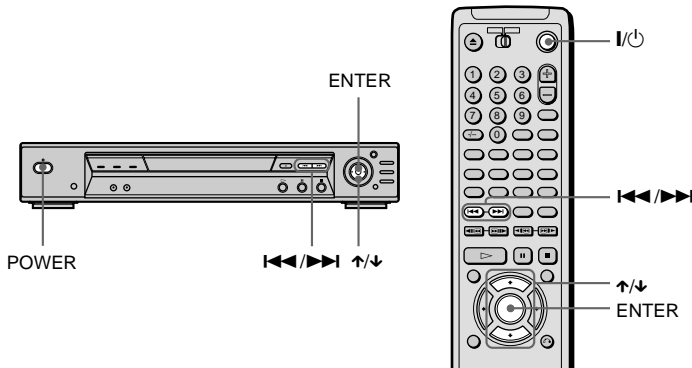

- 1** Turn on the TV.
- 2** Switch the input selector on the TV to the player.
- 3** Press **POWER** on the player and press **I/⏻** on the remote.

“Press [ENTER] to run QUICK SETUP” appears at the bottom of the screen. If this message does not appear, select “QUICK” under “SETUP” in the Control Menu to run Quick Setup (page 74).

4 Press ENTER without inserting a disc.

The Setup Display for selecting the language used in the on-screen display appears. The available languages differ depending upon the player model.

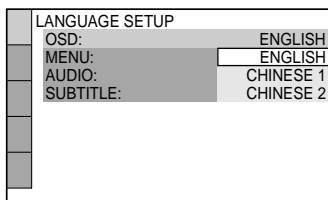

5 Press ↑/↓ to select a language.

The player uses the language selected here to display the menu and subtitles as well.

6 Press ENTER.

The Setup Display for selecting the aspect ratio of the TV to be connected appears.

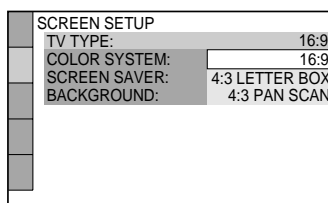

7 Press ↑/↓ to select the item.

TV Type	You select	Page
A wide-screen TV or a 4:3 standard TV with a wide-screen mode	16:9	76
4:3 standard TV	4:3 LETTER BOX or 4:3 PAN SCAN	76

8 Press ENTER.

The Setup Display for selecting the type of jack used to connect your amplifier (receiver) appears.

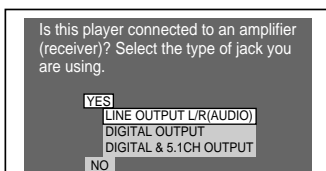

9 Press ↑/↓ to select the item, then press ENTER.

Audio Cord Connecting Type	You select
C-1 D-1	LINE OUTPUT L/R (AUDIO)
B-2 C-2 D-2	DIGITAL OUTPUT
B-1 or both B-1 and B-2	DIGITAL & 5.1CH OUTPUT
A	NO

continued

- When “NO” or “LINE OUTPUT L/R (AUDIO)” is selected, Quick Setup is finished and connections are complete.
- When “DIGITAL OUTPUT” or “DIGITAL & 5.1CH OUTPUT” is selected, the Setup Display for “DOLBY DIGITAL” appears.

10 Press ↑/↓ to select the item.

Choose the item that matches the audio connection you selected in page 23 to 26 (**B** through **D**).

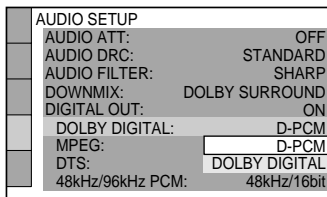

Audio Cord Connection Type	You select	Page
C-2 D-2	D-PCM	80
B-2	DOLBY DIGITAL (only if the amplifier (receiver) has a Dolby Digital decoder)	80

11 Press ENTER.

“DTS” is selected.

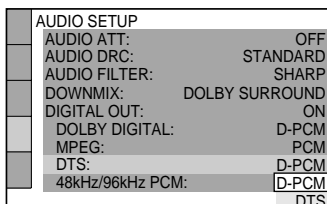

12 Press ↑/↓ to select the item.

Choose the item that matches the audio connection you selected in page 23 to 26 (**B** through **D**).

Audio Cord Connection Type	You select	Page
C-2 D-2	D-PCM	80
B-2	DTS (only if the amplifier (receiver) has a DTS decoder)	80

13 Press ENTER.

- When “DIGITAL OUTPUT” is selected in Step **9**, Quick Setup is finished. All connections and setup operations are complete.
If your AV amplifier (receiver) has an MPEG audio decoder, set “MPEG” to “MPEG” (page 80).
- When “DIGITAL & 5.1CH OUTPUT” is selected in Step **9**, the Setup Display for “SPEAKER SETUP” appears.

14 Press \uparrow/\downarrow to select the size of the centre speaker.

If no centre speaker is connected, select "NONE." Refer to page 82 for each selection item.

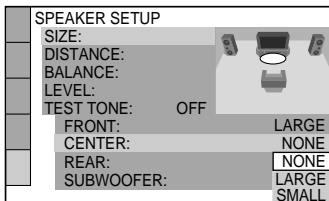

15 Press ENTER.

The Setup Display for selecting the size of the rear speaker appears.

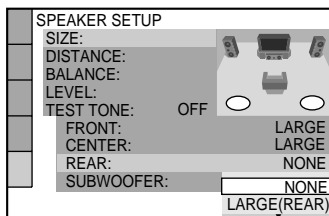

16 Press \uparrow/\downarrow to select the size.

If no rear speaker is connected, select "NONE."

"SIDE" and "REAR" refer to the speakers' position relative to your listening position.

Refer to page 82 for each selection item.

17 Press ENTER.

The Setup Display for selecting whether or not you have connected a subwoofer appears.

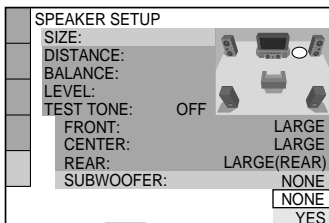

18 Press \uparrow/\downarrow to select the item.

19 Press ENTER.

Quick Setup is finished. All connections and setup operations are complete.

Note

You can directly start Quick Setup only when you run it for the first time.

To run Quick Setup a second time, select "QUICK" under "SETUP" in the Control Menu (page 74).

Enjoying the surround sound effects

To enjoy the surround sound effects of this player or your amplifier (receiver), the following items must be set as described below for the audio connection you selected in pages 23 to 26 (**B** through **D**). Each of these are the default settings and do not need to be adjusted when you first connect the player. Refer to page 74 for using the Setup Display.

Audio Connection (pages 23 to 26)

A

No additional settings are needed.

B-1

Item	You select	Page
DISTANCE	Set according to the connected	82
BALANCE	speakers	
LEVEL		

- If the sound distorts even when the volume is turned down, set “AUDIO ATT” to “ON” (page 79).

B-2 C-2 D-2

Item	You select	Page
DOWNMIX	DOLBY SURROUND	79
DIGITAL OUT	ON	79

- Set “48kHz/96kHz PCM” to “96kHz/24bit,” only if you connect an amplifier (receiver) that conforms to the 96 kHz sampling frequency (page 80).

C-1 D-1

Item	You select	Page
DOWNMIX	DOLBY SURROUND	79

- If the sound distorts even when the volume is turned down, set “AUDIO ATT” to “ON” (page 79).

Playing Discs

DVD VIDEO DVD-RW VIDEO CD

SACD CD

Depending on the DVD or VIDEO CD, some operations may be different or restricted. Refer to the operating instructions supplied with your disc.

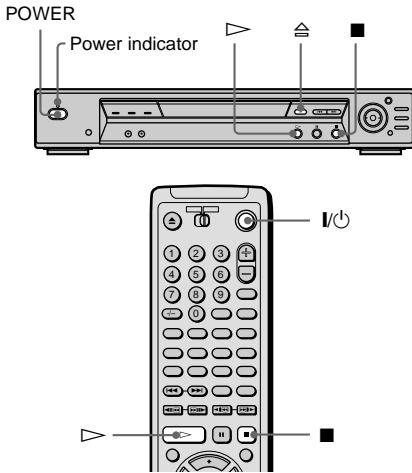

1 Turn on your TV.

2 Switch the input selector on the TV to the player.

When using an amplifier (receiver)

Turn on the amplifier (receiver) and select the appropriate channel.

3 Press **POWER** on the player.
The player enters standby mode and the power indicator lights up in red.

4 Press **▶** on the player, and place a disc on the disc tray.

The player automatically turns on and the power indicator lights up in green.

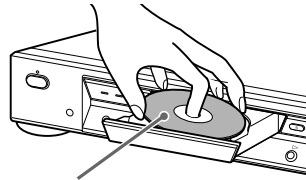

With the playback side facing down

5 Press **▶**.

The disc tray closes, and the player starts playback (continuous play). Adjust the volume on the TV or the amplifier (receiver).

After following Step 5

Depending on the disc, a menu may appear on the TV screen. You can play the disc interactively by following the instructions on the menu. DVD VIDEO (page 35), VIDEO CD (page 38).

To turn on the player

Press **POWER** on the player. The player enters standby mode and the power indicator lights up in red. Press **I/O** on the remote. The player turns on and the power indicator lights up in green. In standby mode, the player also turns on by pressing **▶** on the player or by pressing **▶**.

To turn off the player

Press **I/O** on the remote. The player enters standby mode and the power indicator lights up in red. To turn off the player completely, press **POWER** on the player. While playing a disc, do not turn off the player by pressing **POWER**. Doing so may cancel the menu settings. When you turn off the player, first press **■** to stop playback and then press **I/O** on the remote.

Notes

- If you don't operate the player or the remote for more than 30 minutes when a disc is not playing, the player automatically enters standby mode (Auto Power Off function).
- SACD audio signals are not output from the digital jack.

Additional operations

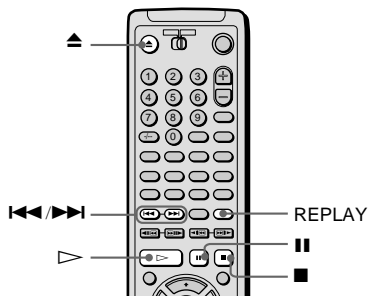

To	Operation
Stop	Press ■
Pause	Press
Resume play after pause	Press or ▷
Go to the next chapter, track or scene in continuous play mode	Press ►►
Go back to the preceding chapter, track or scene in continuous play mode	Press ◀◀
Stop play and remove the disc	Press ▲
Replay the previous scene (DVD VIDEO only)	Press REPLAY

💡 The Replay function is useful when you want to review a scene or dialog that you missed.

Note

You may not be able to use the Replay function with some scenes.

Resuming Playback from the Point Where You Stopped the Disc (Resume Play)

DVD VIDEO DVD-RW VIDEO CD

SACD CD

When you stop the disc, the player remembers the point where you pressed ■ and “RESUME” appears on the front panel display. As long as you do not open the disc tray, Resume Play works even if the player enters standby mode by pressing I/⏻.

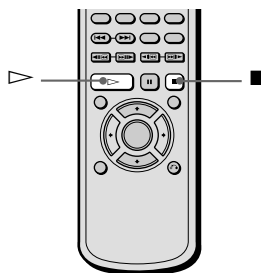

- 1 While playing a disc, press ■ to stop playback. “RESUME” appears on the front panel display and you can restart the disc from the point where you stopped the disc. If “RESUME” does not appear, Resume Play is not available.

- 2 Press ▷. The player starts playback from the point where you stopped the disc in Step 1.

💡 To play from the beginning of the disc, press ■ twice, then press ▷.

Notes

- Depending on where you stopped the disc, the player may not resume playback from exactly the same point.
- The point where you stopped playing is cleared when:
 - you turn the power off by pressing POWER on the player.
 - you change the play mode.
 - you change the settings on the Setup Display.

Using the DVD's Menu

DVD VIDEO

A DVD is divided into long sections of a picture or a music feature called "titles." When you play a DVD which contains several titles, you can select the title you want using the TOP MENU button. When you play DVDs that allow you to select items such as the language for the subtitles and the language for the sound, select these items using the MENU button.

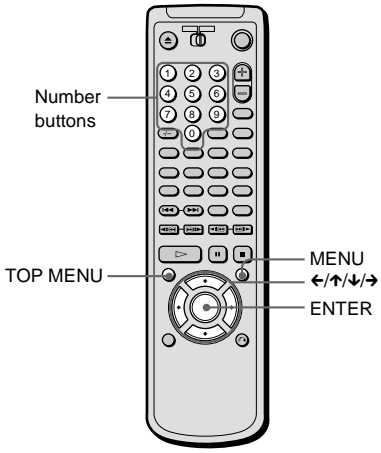

- 1 Press TOP MENU or MENU.**
The disc's menu appears on the TV screen.
The contents of the menu vary from disc to disc.
- 2 Press ←/↑/↓/→ or the number buttons to select the item you want to play or change.**
- 3 Press ENTER.**

You can also display the disc's menu by pressing TOP MENU or MENU on the player.

Selecting "ORIGINAL" or "PLAY LIST" on a DVD-RW Disc **DVD-RW**

Some DVD-RW discs in VR (Video Recording) mode have two types of titles for playback: originally recorded titles (ORIGINAL) and titles that can be created on recordable DVD players for editing (PLAY LIST). You can select the type of titles to be played.

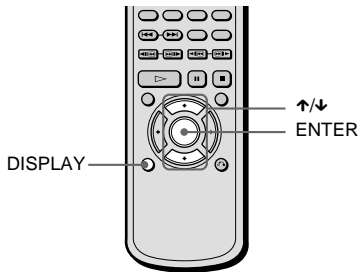

1 Press **DISPLAY** in stop mode.
The Control Menu appears.

2 Press **↑/↓** to select  (ORIGINAL/PLAY LIST), then press **ENTER**.
The options for "ORIGINAL/PLAY LIST" appear.

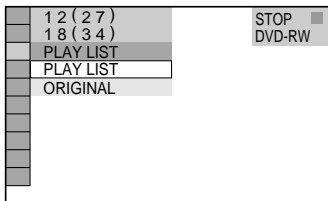

3 Press **↑/↓** to select the setting.

- **PLAY LIST**: plays the titles created from "ORIGINAL" for editing.
- **ORIGINAL**: plays the titles originally recorded.

4 Press **ENTER**.

To turn off the Control Menu

Press **DISPLAY** repeatedly until the Control Menu is turned off.

Note

Repeat Play and A-B Repeat Play work only within the titles of the selected type.

Selecting a Playback Area for an SACD **SACD**

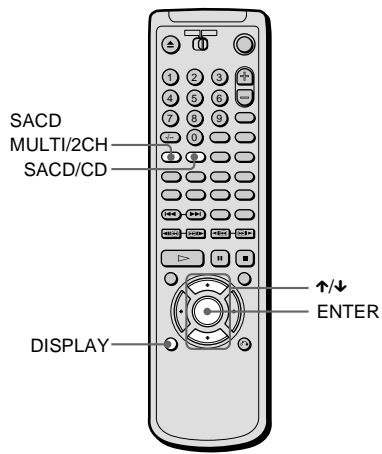

Selecting a playback layer when playing a hybrid SACD

Some SACDs consist of an HD layer and a CD layer. You can select the playback layer you want to listen to.

Press SACD/CD in stop mode.

Each time you press the button, an HD layer or a CD layer is alternately selected. When playing a CD layer, the “CD” indicator in the front panel display lights up.

Notes

- For details about SACD discs, see page 89 (Super Audio CD).
- Each play mode function works only within the selected layer or playback area.

Selecting a playback area on a 2 channel + Multi-channel SACD

Some SACDs consist of a 2 channel playback area and a multi-channel playback area. You can select the playback area you want to listen to.

Press SACD MULTI/2CH in stop mode.

Each time you press the button, the “MULTI” indicator turns on and off in the front panel display. When no indicator appears, the 2 channel playback area is selected.

To select a playback area using the Control Menu

- 1 Press DISPLAY.
The Control Menu appears.
- 2 Press ↑/↓ to select **2CH** (MULTI/2CH), then press ENTER.
- 3 Press ↑/↓ to select the playback area, “MULTI” or “2CH,” then press ENTER.

Playing VIDEO CDs with PBC Functions (PBC Playback)

VIDEO CD

With PBC (Playback Control) functions, you can enjoy simple interactive operations, search functions, and other such operations. PBC playback allows you to play VIDEO CDs interactively by following the menu on the TV screen.

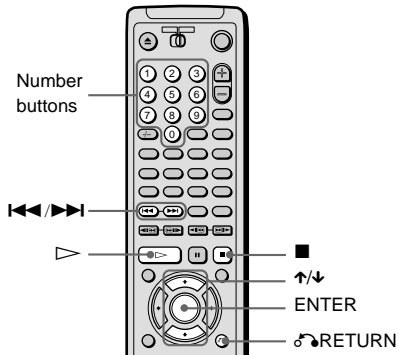

💡 To play without using PBC, press **⏮/⏭** or the number buttons while the player is stopped to select a track, then press **▶** or ENTER. "Play without PBC" appears on the TV screen and the player starts continuous play. You cannot play still pictures such as a menu. To return to PBC playback, press **■** twice then press **▶**.

Notes

- Depending on the VIDEO CD, "Press ENTER" in Step 3 may appear as "Press SELECT" in the instructions supplied with the disc. In this case, press **▶**.
- The PBC functions of Super VCDs do not work with this player. Super VCDs are played in continuous play mode only.

- 1** Start playing a VIDEO CD with PBC functions.
The menu for your selection appears.
- 2** Select the item number you want by pressing **↑/↓** or the number buttons.
- 3** Press ENTER.
- 4** Follow the instructions in the menu for interactive operations.
Refer to the instructions supplied with the disc, as the operating procedure may differ depending on the VIDEO CD.

To go back to the menu

Press **↶** RETURN.

Various Play Mode Functions (Programme Play, Shuffle Play, Repeat Play, A-B Repeat Play)

You can set the following play modes:

- Programme Play (page 39)
- Shuffle Play (page 41)
- Repeat Play (page 42)
- A-B Repeat Play (page 43)

Note

The play mode is cancelled when:

- you open the disc tray.
- the player enters standby mode by pressing **I/⏻** on the remote.
- you turn the power off by pressing **POWER** on the player.

Creating your own programme (Programme Play)

DVD VIDEO VIDEO CD SACD CD

You can play the contents of a disc in the order you want by arranging the order of the titles, chapters, or tracks on the disc to create your own programme. You can programme up to 99 titles, chapters, and tracks.

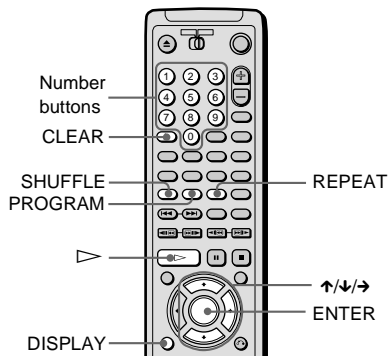

1 Press **DISPLAY** twice (when playing an SACD/CD, press once).
The Control Menu appears.

2 Press **↑/↓** to select  (PROGRAM), then press **ENTER**.
The options for “PROGRAM” appear.

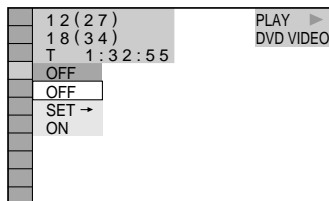

3 Press **↑/↓** to select “SET →,” then press **ENTER**.
The display for programming appears.

“TRACK” is displayed when you play a VIDEO CD, SACD, or CD.

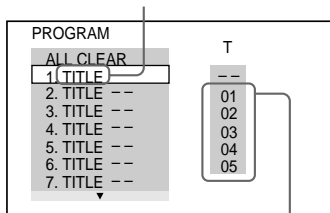

Titles or tracks recorded on a disc

4 Press **→**.
The cursor moves to the title or track (in this case, “01”).

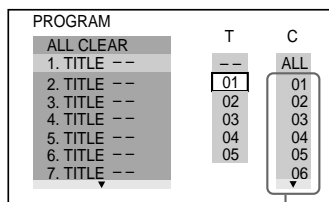

Chapters recorded on a disc

5 Select the title, chapter, or track you want to programme.

■ When playing a DVD VIDEO

For example, select chapter “03” of title “02.”

Press \uparrow/\downarrow or the number buttons to select “02” under “T,” then press ENTER.

PROGRAM		T	C
ALL CLEAR	--	--	ALL
1. TITLE --	01	01	01
2. TITLE --	02	02	02
3. TITLE --	03	03	03
4. TITLE --	04	04	04
5. TITLE --	05	05	05
6. TITLE --			06
7. TITLE --			

Next, press \uparrow/\downarrow or the number buttons to select “03” under “C,” then press ENTER.

PROGRAM		T
ALL CLEAR	--	--
1. TITLE (02-03)	01	01
2. TITLE --	02	02
3. TITLE --	03	03
4. TITLE --	04	04
5. TITLE --	05	05
6. TITLE --		
7. TITLE --		

Selected title and chapter

■ When playing a VIDEO CD, SACD, or CD

For example, select track “02.”

Press \uparrow/\downarrow or the number buttons to select “02” under “T,” then press ENTER.

A track number may be displayed in 3 digits for an SACD.

PROGRAM		T	0:15:30
ALL CLEAR	--	--	
1. TRACK (02)	01	01	
2. TRACK --	02	02	
3. TRACK --	03	03	
4. TRACK --	04	04	
5. TRACK --	05	05	
6. TRACK --			
7. TRACK --			

Total time of the programmed tracks

6 To programme other titles, chapters, or tracks, repeat Steps 4 to 5.

The programmed titles, chapters, and tracks are displayed in the selected order.

7 Press \triangleright to start Programme Play.

Programme Play begins.

When the programme ends, you can restart the same programme again by pressing \triangleright .

To return to normal play

Press CLEAR, or select “OFF” in Step 3.

To play the same programme again, select “ON” in Step 3 and press \triangleright .

To turn off the Control Menu

Press DISPLAY repeatedly until the Control Menu is turned off.

To change or cancel a programme

1 Follow Steps 1 through 3 of “Creating your own programme (Programme Play).”

2 Select the programme number of the title, chapter, or track you want to change or cancel using \uparrow/\downarrow or the number buttons, and press \rightarrow .

3 Follow Step 5 for new programming. To cancel a programme, select “--” under “T,” then press ENTER.

To cancel all the titles, chapters, or tracks in the programmed order

1 Follow Steps 1 through 3 of “Creating your own programme (Programme Play).”

2 Press \uparrow and select “ALL CLEAR.”

3 Press ENTER.

 You can do Repeat Play or Shuffle Play of the programmed titles, chapters, or tracks. Press REPEAT or SHUFFLE, or activate “REPEAT” or “SHUFFLE” in the Control Menu display during Programme Play.

💡 You can select "PROGRAM" directly by pressing PROGRAM.

Notes

- When playing Super VCDs, the total time of the programmed tracks does not appear on the screen.
- The number of titles, chapters, or tracks displayed are the same as the number of titles, chapters, or tracks recorded on a disc.

Playing in random order (Shuffle Play)

DVD VIDEO VIDEO CD SACD CD

You can have the player "shuffle" titles, chapters, or tracks and play them in random order. Subsequent "shuffling" may produce a different playing order.

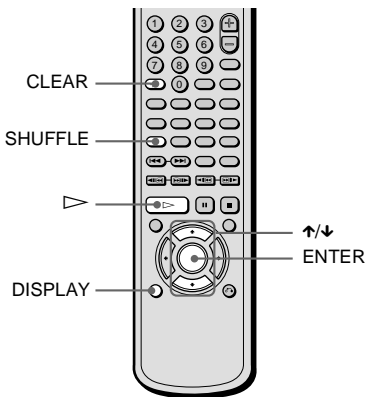

1 Press DISPLAY twice during playback (When playing an SACD/CD, press once).

The Control Menu appears.

2 Press \uparrow/\downarrow to select  (SHUFFLE), then press ENTER.

The options for "SHUFFLE" appear.

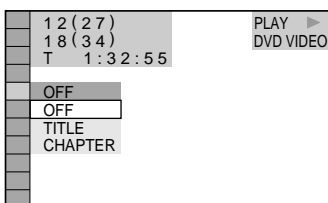

3 Press \uparrow/\downarrow to select the item.

■ When playing a DVD VIDEO (Programme Play is set to "OFF")

- TITLE: shuffles titles and plays them in random order.
- CHAPTER: shuffles chapters and plays them in random order.

■ When playing a VIDEO CD/ SACD/CD (Programme Play is set to "OFF")

- TRACK: shuffles tracks and plays them in random order.

■ When Programme Play is set to "ON"

- ON: shuffles titles or tracks selected in Programme Play and plays them in random order.

4 Press ENTER.

To return to normal play

Press CLEAR or select "OFF" in Step 3.

To turn off the Control Menu

Press DISPLAY repeatedly until the Control Menu is turned off.

💡 You can set Shuffle Play while the player is stopped. After selecting the "SHUFFLE" option, press \triangleright . Shuffle Play starts.

💡 You can select "SHUFFLE" directly by pressing SHUFFLE. Each time you press the button, the item changes.

Note

Up to 200 chapters in a disc can be played in random order when "CHAPTER" is selected.

Playing repeatedly (Repeat Play)

DVD VIDEO DVD-RW VIDEO CD SACD CD

You can play all of the titles or tracks on a disc or a single title, chapter, or track repeatedly.

You can use a combination of Shuffle or Programme Play modes.

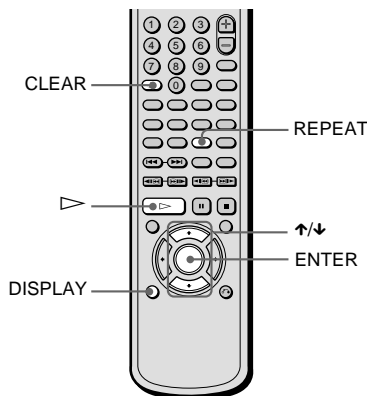

1 Press DISPLAY twice during playback (when playing an SACD/CD, press once). The Control Menu appears.

2 Select  (REPEAT) using ↑/↓, then press ENTER. The options for “REPEAT” appear.

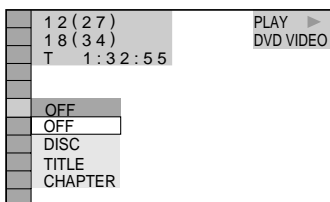

3 Press ↑/↓ to select the item.

■ **When playing a DVD VIDEO (Programme Play and Shuffle Play are set to “OFF”)**

- DISC: repeats all of the titles.
- TITLE: repeats the current title on a disc.
- CHAPTER: repeats the current chapter.

■ **When playing a DVD-RW**

- DISC: repeats all the titles of the selected type.
- TITLE: repeats the current title on a disc.
- CHAPTER: repeats the current chapter.

■ **When playing a VIDEO CD/ SACD/CD (Programme Play and Shuffle Play are set to “OFF”)**

- DISC: repeats all of the tracks.
- TRACK: repeats the current track.

■ **When Programme Play is set to “ON” or Shuffle Play is activated**

- ON: repeats Programme Play or Shuffle Play.

4 Press ENTER.

To return to normal play

Press CLEAR, or select “OFF” in Step 3.

To turn off the Control Menu

Press DISPLAY repeatedly until the Control Menu is turned off.

 You can set Repeat Play while the player is stopped. After selecting the “REPEAT” option, press ▷. Repeat Play starts.

 You can select “REPEAT” directly by pressing REPEAT. Each time you press the button, the item changes.

Repeating a specific portion (A-B Repeat Play)

DVD VIDEO DVD-RW VIDEO CD SACD CD

You can play a specific portion of a title, chapter or track repeatedly. (This function is useful when you want to memorize lyrics, etc.)

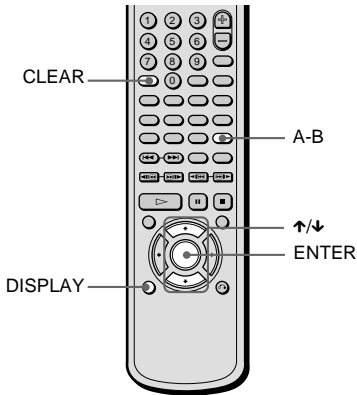

1 Press DISPLAY twice during playback (when playing an SACD/CD, press once). The Control Menu appears.

2 Press ↑/↓ to select  (A-B REPEAT), then press ENTER. The options for “A-B REPEAT” appear.

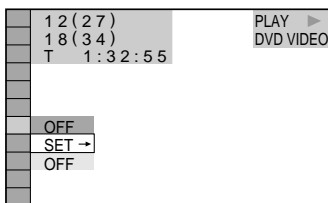

3 Press ↑/↓ to select “SET →,” then press ENTER. The “A-B REPEAT” setting display appears.

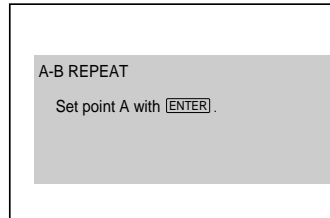

4 During playback, when you find the starting point (point A) of the portion to be played repeatedly, press ENTER. The starting point (point A) is set.

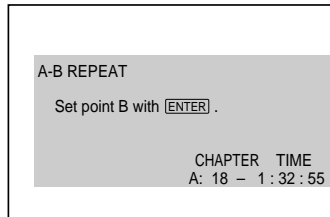

5 When you reach the ending point (point B), press ENTER again. The set points are displayed and the player starts repeating this specific portion. “A-B” appears on the front panel display during A-B Repeat Play.

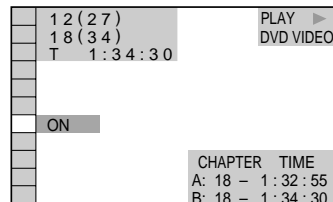

To return to normal play

Press CLEAR, or select “OFF” in Step 3.

To turn off the Control Menu

Press DISPLAY repeatedly until the Control Menu is turned off.

 You can select "A-B REPEAT" directly by pressing A-B. Press the button once to set the point A, and press it again to set the point B.

Notes

- You can set A-B Repeat Play for only one specific section.
- When you set A-B Repeat Play, the settings for Shuffle Play, Repeat Play, and Programme Play are cancelled.
- A-B Repeat Play does not work for titles containing still pictures on a DVD-RW in VR mode.

Searching for a Particular Point on a Disc (Search, Scan, Slow-motion Play, Freeze Frame)

You can quickly locate a particular point on a disc by monitoring the picture or playing back slowly.

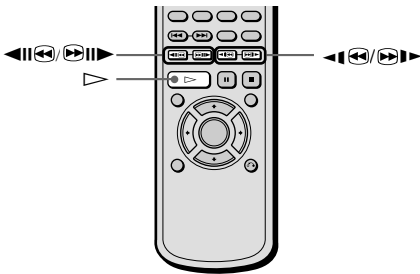

Note

Depending on the DVD/VIDEO CD, you may not be able to do some of the operations described.

Locating a point quickly (Search)

DVD VIDEO DVD-RW VIDEO CD SACD CD

During playback, keep pressing **▶▶** to locate a point in the playback direction or keep pressing **◀◀** to locate a point in the opposite direction. When you find the point you want, release the button to return to normal playback speed.

Locating a point quickly by playing a disc in fast forward or fast reverse (Scan)

DVD VIDEO DVD-RW VIDEO CD SACD CD

Press **◀◀** or **▶▶** while playing a disc. When you find the point you want, press **▷** to return to normal speed.

Each time you press **◀◀** or **▶▶** during scan, the playback speed changes. Three speeds are available. With each press the indication changes as follows:

Playback direction

×2▶ (DVD VIDEO/SACD/CD only)

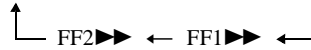

Opposite direction

×2◀ (DVD VIDEO only) → **FR1◀◀** → **FR2◀◀**



The “**×2▶**”/“**×2◀**” playback speed is about twice the normal speed. The “**FF2▶▶**”/“**FR2◀◀**” playback speed is faster than “**FF1▶▶**”/“**FR1◀◀**”.

Watching frame by frame (Slow-motion play)

DVD VIDEO DVD-RW VIDEO CD

Press **◀◀** or **▶▶** when the player is in the pause mode. To return to the normal speed, press **▷**.

Each time you press the **◀◀** or **▶▶** buttons during Slow-motion play, the playback speed changes. Two speeds are available. With each press the indication changes as follows:

Playback direction

SLOW2▶▶ ↔ **SLOW1▶▶**

Opposite direction (DVD VIDEO only)

SLOW2◀◀ ↔ **SLOW1◀◀**

The “**SLOW2▶▶**”/“**SLOW2◀◀**” playback speed is slower than “**SLOW1▶▶**”/“**SLOW1◀◀**”.

Playing one frame at a time

DVD VIDEO DVD-RW VIDEO CD

When the player is in the pause mode, press **▶▶** to go to the next frame. Press **◀◀** to go to the preceding frame (DVD VIDEO only). If you hold the button down, you can view the frames in succession. To return to normal playback, press **▷**.

Using the Click shuttle on the player (Shuttle mode)

DVD VIDEO DVD-RW VIDEO CD SACD CD

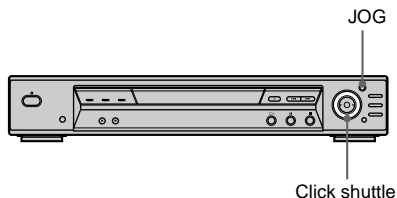

Turn the click shuttle on the player. The playback speed changes depending on the turning direction and degree of rotation as follows:

During playback

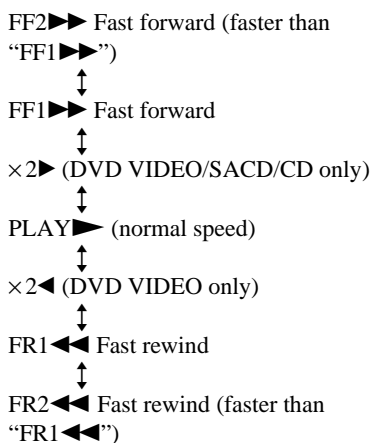

If you turn the click shuttle quickly, the playback speed goes to "FF2▶▶" or "FR2◀◀" at once.

During pause mode (DVD VIDEO, DVD-RW only)

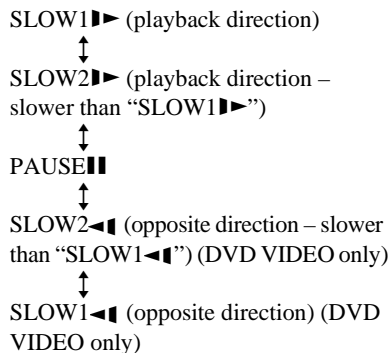

During pause mode (VIDEO CD only)

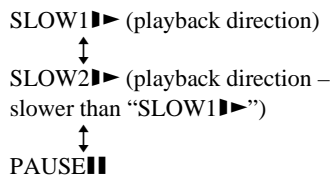

To return to Continuous Play

Press ▷.

Playing a disc frame by frame using the click shuttle (Jog mode)

DVD VIDEO DVD-RW VIDEO CD

1 Press JOG.

The player enters pause mode.

2 Turn the click shuttle.

Depending on the turning speed, playback goes to frame-by-frame playback in the direction that the click shuttle is turned. Turn the click shuttle clockwise to go forward, and anticlockwise to rewind (DVD VIDEO only). If you turn the click shuttle at a constant speed for a while, the playback speed goes to slow or normal.

To return to Continuous Play

Press ▷.

To turn off the Jog mode

Press JOG again so that the indicator turns off.

Searching for a Title/ Chapter/Track/Index/ Scene

DVD VIDEO DVD-RW VIDEO CD

SACD CD

You can search a DVD by title or chapter, and you can search a VIDEO CD/SACD/CD by track, index, or scene. As titles and tracks are assigned unique numbers on the disc, you can select the desired one by entering its number. Or, you can search for a scene using the time code (Time search).

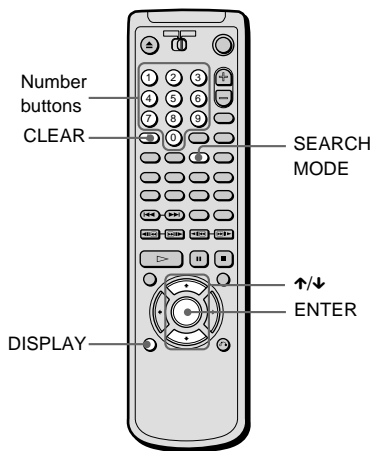

1 Press **DISPLAY**.
The Control Menu appears.

2 Press **↑/↓** to select the search method.

■ **When playing a DVD VIDEO/
DVD-RW**

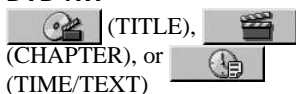

Select "TIME/TEXT" for "Time search" (see below).

■ **When playing a VIDEO CD**
 (TRACK) or (INDEX)

■ **When playing a VIDEO CD with
PBC Playback**
 (SCENE)

■ **When playing an SACD/CD**
 (TRACK) or (INDEX)

Example: when you select (CHAPTER)

"** (**)" is selected (** refers to a number).

The number in parentheses indicates the total number of titles, chapters, tracks, indexes or scenes.

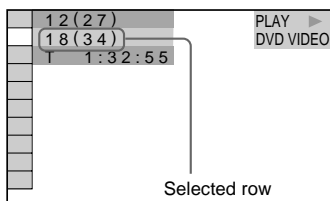

3 Press **ENTER**.
"** (**)" changes to "-- (**)."

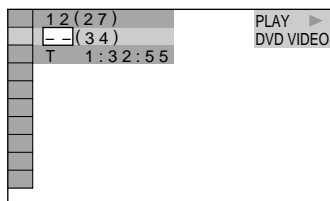

4 Press **↑/↓** or the number buttons to select the title, chapter, track, index, or scene number you want to search.

If you make a mistake

Cancel the number by pressing **CLEAR**, then select another number.

continued

5 Press ENTER.

The player starts playback from the selected number.

To turn off the Control Menu

Press DISPLAY repeatedly until the Control Menu is turned off.

To search for a scene using the time code (Time search) (DVD VIDEO/DVD-RW only)

1 In Step 2, select  (TIME/TEXT).

“T **:***:***” (playing time of the current title) is selected.

2 Press ENTER.

“T **:***:***” changes to “T --:--:--.”

3 Input the time code using the number buttons, then press ENTER.

For example, to find the scene at 2 hours, 10 minutes, and 20 seconds after the beginning, just enter “2:10:20.”

 You can select “TITLE,” “CHAPTER,” “TRACK,” “INDEX,” “SCENE,” or “TIME/TEXT” directly by pressing SEARCH MODE repeatedly.

 When the Control Menu display is turned off, you can search for a chapter (DVD VIDEO/DVD-RW) or track (SACD/CD) by pressing the number buttons and ENTER.

 You can display the first scene of titles, chapters, or tracks recorded on the disc on a screen divided into 9 sections. You can start playback directly by selecting one of the scenes. For details, see below.

Notes

- The title, chapter or track number displayed is the same number recorded on the disc.
- You cannot search for a still picture on a DVD-RW in VR mode.

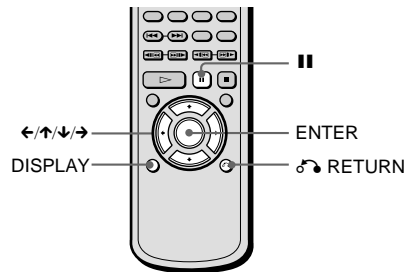

Searching by Scene (VIEWER)

You can divide the screen into 9 subscreens and find the desired scene quickly.



1 Press DISPLAY twice during playback.

The Control Menu appears.

2 Press  to select  (VIEWER), then press ENTER.

The options for “VIEWER” appear.

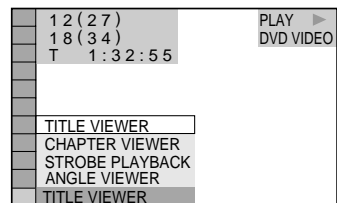

3 Press  to select the item.

Refer to the explanations given for each item in the following sections.

- TITLE VIEWER (for DVD VIDEO only)
- CHAPTER VIEWER (for DVD VIDEO only)
- TRACK VIEWER (for VIDEO CD only)
- STROBE PLAYBACK
- ANGLE VIEWER (for DVD VIDEO only)

4 Press ENTER.

To return to normal play

Press  RETURN.

To turn off the Control Menu

Press DISPLAY repeatedly until the Control Menu is turned off.

Notes

- The “VIEWER” is not available when playing Super VCDs.
- Depending on the disc, you may not be able to select all functions.
- The sound is muted when using this function.

Scanning the title, chapter, or track

DVD VIDEO VIDEO CD

You can divide the screen into 9 subscreens and display the first scene of titles, chapters, or tracks. You can also play back from the selected title, chapter, or track.

Select the item you want in Step 3, then press ENTER in Step 4.

■ When playing a DVD VIDEO





Select “TITLE VIEWER” or “CHAPTER VIEWER”.

■ When playing a VIDEO CD



Select “TRACK VIEWER”.

The initial scenes of titles, chapters, or tracks appear.

To start playback from the selected scene

Select the scene using /// and press ENTER. The playback starts from the selected scene.

 If there are more than 9 titles, chapters, or tracks, ▼ is displayed at the bottom right.

To display the additional titles, chapters, or tracks, select the bottom right scene (the position 9) and press . To return to the previous scene, select the top left scene (the position 1) and press .

1	2	3	
4	5	6	
7	8	9	▼

Dividing a scene into 9 sections (STROBE PLAYBACK)

DVD VIDEO VIDEO CD

You can display 9 consecutive moving pictures on the screen. When you press , the moving pictures pause.

Select “STROBE PLAYBACK” in Step 3, then press ENTER in Step 4.

Displaying different angles simultaneously **DVD VIDEO**

If various angles (multi-angles) for a scene are recorded on the DVD VIDEO, you can display all of the angles recorded on the disc on the same screen, and start playback in continuous mode at the chosen angle. The angles are displayed on a screen divided into 9 sections.

Select “ANGLE VIEWER” in Step 3, then press ENTER in Step 4.

Viewing the Playing Time and Remaining Time on the Front Panel Display

DVD VIDEO **DVD-RW** **VIDEO CD**

SACD **CD**

You can check information about the disc, such as the remaining time, current number of title (DVD), or track (VIDEO CD, SACD, CD) using the front panel display (page 9).



TIME/TEXT

Press TIME/TEXT.

Each time you press TIME/TEXT while playing the disc, the display changes as shown in the following charts.

When playing a DVD VIDEO or DVD-RW

Title playing time and the current title and chapter number

TITLE	CHAP	HOUR	MIN	SEC
1	2	1	03	24



Remaining time of the current title

TITLE	CHAP	HOUR	MIN	SEC
1	2	-	15	36



Playing time and number of the current chapter

CHAP	HOUR	MIN	SEC
2	0	22	30



Remaining time of the current chapter

CHAP	HOUR	MIN	SEC
2	-	01	320



Text

SONY HITS/5

When playing a VIDEO CD (without PBC functions), SACD, or CD

Track playing time and the current track and index number

TRACK	INDEX	MIN	SEC
2	1	2	25



Remaining time of the current track

TRACK	INDEX	MIN	SEC
2	1	-	150



Playing time of the disc

MIN	SEC
3	212



Remaining time of the disc

MIN	SEC
-	2018



Text

SONY HITS/5

💡 When playing VIDEO CDs with PBC functions, the scene number and the playing time are displayed.

💡 The playing time and remaining time of the current chapter, title, track, scene, or disc will also appear on your TV screen. See the following section “Checking the Playing Time and Remaining Time” for instructions on how to read this information.

Note

Depending on the type of disc being played and the playing mode, the above mentioned disc information may not be displayed.

Checking the Playing Time and Remaining Time

DVD VIDEO **DVD-RW** **VIDEO CD**

SACD **CD**

You can check the playing time and remaining time of the current title, chapter, or track, in addition to the playing time and remaining time of the disc. Also, you can check the DVD/SACD/CD text recorded on the disc.

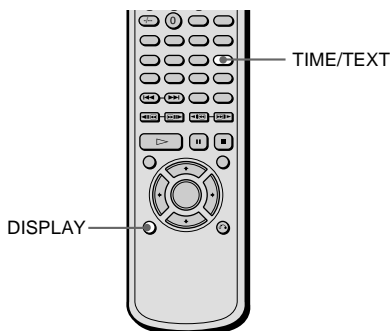

- 1 Press **DISPLAY** during playback. The Control Menu appears.

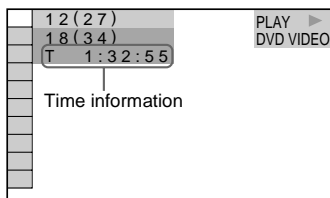

- 2 Press **TIME/TEXT** repeatedly to change the time information. The display and the kinds of time that you can change depend on the disc you are playing.

■ When playing a DVD VIDEO or DVD-RW

- T **: **: **
Playing time of the current title
- T- **: **: **
Remaining time of the current title
- C **: **: **
Playing time of the current chapter
- C- **: **: **
Remaining time of the current chapter

■ When playing a VIDEO CD (with PBC functions)

- **: **: **
Playing time of the current scene

■ When playing a VIDEO CD (without PBC functions), SACD, or CD

- T **: **: **
Playing time of the current track
- T- **: **: **
Remaining time of the current track
- D **: **: **
Playing time of the current disc
- D- **: **: **
Remaining time of the current disc

■ When playing a Super VCD

The remaining time cannot be displayed.

- T **: **: **
Playing time of the current track

To check the DVD/SACD/CD text

Press TIME/TEXT repeatedly in Step 2 to display the text recorded on the DVD/SACD/CD. The DVD/SACD/CD text appears only when the text is recorded in the disc. You cannot change the text. If the disc does not contain text, "NO TEXT" appears.

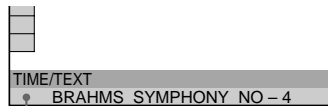

DVD/SACD/CD text

💡 If the DVD/SACD/CD text does not fit on a single line, you can see the entire text by watching it scroll across the front panel display.

💡 You can select the time and text directly by pressing TIME/TEXT.

Notes

- Only letters of the alphabet can be displayed.
- This player can only display the first level of DVD/SACD/CD text, such as the disc name or title.

To turn off the Control Menu

Press DISPLAY repeatedly until the Control Menu is turned off.

Checking the Play Information (ADVANCED)

DVD VIDEO DVD-RW

You can check information such as the bit rate or the disc layer that is being played. While playing a disc, an approximate bit rate of the playback picture is always displayed as Mbps (Mega bit per second) and the audio as kbps (kilo bit per second).

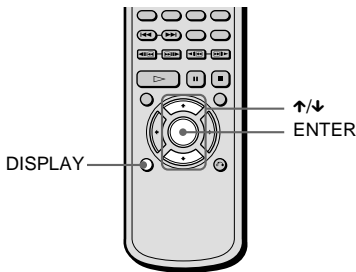

1 Press **DISPLAY** during playback. The Control Menu is displayed.

2 Press **↑/↓** to select  (ADVANCED), then press **ENTER**. The options for “ADVANCED” appear.

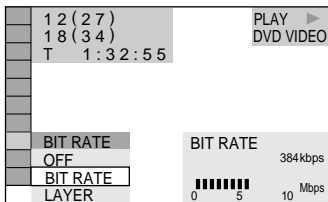

3 Press **↑/↓** to select items. For each item, please refer to “Displays of each item.”

- **BIT RATE:** displays the bit rate.
- **LAYER:** displays the layer and the pick-up point.

4 Press **ENTER**.

To close the ADVANCED window

Select “OFF” in Step 3.

To turn off the Control Menu

Press **DISPLAY** repeatedly until the Control Menu is turned off.

Displays of each item

By pressing **DISPLAY** repeatedly, you can display either “BIT RATE” or “LAYER,” whichever was selected in “ADVANCED.”

BIT RATE

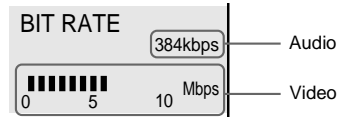

When playing MPEG audio sound tracks

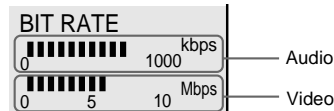

Bit rate refers to the amount of video/audio data per second in a disc. The higher the bit rate, the larger the amount of data. When the bit rate level is high, there is a large amount of data. However, this does not always mean that you can get higher quality pictures or sounds.

LAYER

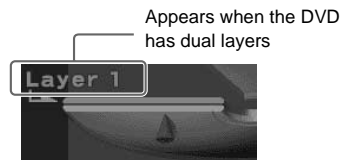

Indicates the approximate point where the disc is playing. If it is a dual-layer DVD, the player indicates which layer is being read (“Layer 0” or “Layer 1”).

For details on the layers, see page 89 (DVD VIDEO).

Changing the Sound

DVD VIDEO DVD-RW VIDEO CD CD

If the DVD VIDEO is recorded with multilingual tracks, you can select the language you want while playing the DVD VIDEO.

If the DVD VIDEO is recorded in multiple audio formats (PCM, Dolby Digital, MPEG audio, or DTS), you can select the audio format you want while playing the DVD VIDEO.

With stereo CDs or VIDEO CDs, you can select the sound from the right or left channel and listen to the sound of the selected channel through both the right and left speakers. (In this case, the sound loses its stereo effect.) For example, when playing a disc containing a song with the vocals on the right channel and the instruments on the left channel, you can select the left channel and hear the instruments from both speakers.

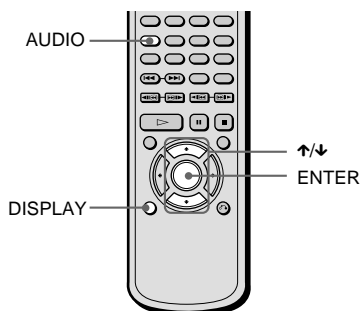

1 Press **DISPLAY** during playback.
The Control Menu is displayed.

2 Press **↑/↓** to select , then **ENTER**.
The options for “AUDIO” appear.

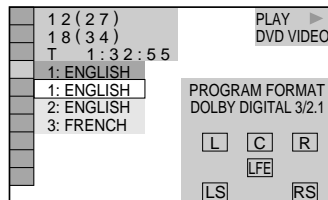

3 Press **↑/↓** to select the desired audio signal.

■ When playing a DVD VIDEO

Depending on the DVD VIDEO, the choice of language varies.

When 4 digits are displayed, they indicate a language code. Refer to “Language Code List” on page 93 to see which language the code represents. When the same language is displayed two or more times, the DVD VIDEO is recorded in multiple audio formats.

■ When playing a DVD-RW

The types of sound tracks recorded on a disc are displayed. The default setting is underlined.

Example:

- 1: MAIN (main sound)
- 1: SUB (sub sound)
- 1: MAIN+SUB (main and sub sound)

■ When playing a VIDEO CD or CD

The default setting is underlined.

- STEREO: The standard stereo sound
- 1/L: The sound of the left channel (monaural)
- 2/R: The sound of the right channel (monaural)

■ When playing a Super VCD

The default setting is underlined.

- 1:STEREO: The stereo sound of the audio track 1
- 1:1/L: The sound of the left channel of the audio track 1 (monaural)
- 1:2/R: The sound of the right channel of the audio track 1 (monaural)
- 2:STEREO: The stereo sound of the audio track 2
- 2:1/L: The sound of the left channel of the audio track 2 (monaural)
- 2:2/R: The sound of the right channel of the audio track 2 (monaural)

4 Press ENTER.

To turn off the Control Menu

Press DISPLAY repeatedly until the Control Menu is turned off.

💡 You can select "AUDIO" directly by pressing AUDIO. Each time you press the button, the item changes.

Notes

- While playing a Super VCD on which the audio track 2 is not recorded, no sound will come out when you select "2:STEREO," "2:1/L" or "2:2/R."
- While playing a DVD, the sound may change automatically.
- You cannot change the sound for SACDs.

Displaying the audio information of the disc **DVD VIDEO**

When you select "AUDIO," the channels being played are displayed on the screen. For example, in Dolby Digital format, multiple signals ranging from monaural to 5.1 channel signals can be recorded on a DVD. Depending on the DVD, the number of the recorded channels may differ.

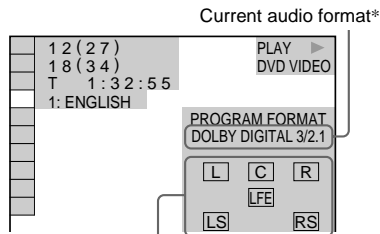

Currently playing programme format**

*"PCM," "MPEG," "DTS," or "DOLBY DIGITAL" is displayed. In the case of "DOLBY DIGITAL," the channels in the playing track are displayed by numbers as follows:

For Dolby Digital 5.1 ch:

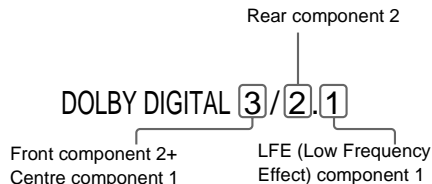

**The letters in the programme format display mean the following sound component:

- L: Front (left)
- R: Front (right)
- C: Centre
- LS: Rear (left)
- RS: Rear (right)
- S: Rear (monaural): The rear component of the Dolby Surround processed signal and the Dolby Digital signal
- LFE: Low Frequency Effect signal

The display examples are as follows:

- PCM (stereo)

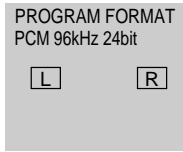

- Dolby Surround

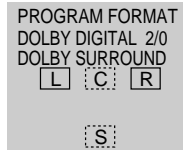

- Dolby Digital 5.1ch

When an LFE signal component is output, “LFE” is enclosed in a solid line. When an LFE signal component is not output, “LFE” is enclosed in a broken line.

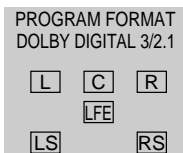

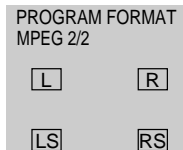

- MPEG

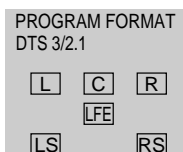

- DTS

When an LFE signal component is output, “LFE” is enclosed in a solid line. When an LFE signal component is not output, “LFE” is enclosed in a broken line.



 When the signal contains rear signal components such as “LS”, “RS”, or “S”, the surround effect is enhanced (page 56).

SURROUND Mode Settings

DVD VIDEO DVD-RW VIDEO CD CD

You can enjoy surround sounds while playing discs including Dolby Digital, DTS, and MPEG audio DVDs, even if you have only 2 or 4 speakers. Select the surround mode that best suits your speaker setup.

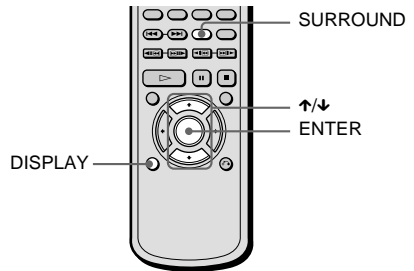

- 1 Press **DISPLAY** during playback. The Control Menu appears.

- 2 Press **↑/↓** to select  (**SURROUND**), then press **ENTER**.

The options for “SURROUND” appear.

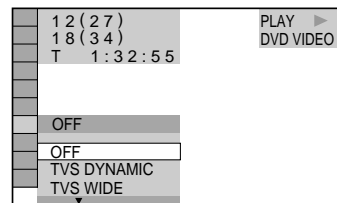

3 Press \uparrow/\downarrow to select one of the surround modes.

Refer to the following explanations given for each item.

For 2 speaker setups

- TVS DYNAMIC
- TVS WIDE
- TVS NIGHT
- TVS STANDARD

For 4 (or more) speaker setups

(If you select "NONE" in the setting of "REAR" in "SPEAKER SETUP"(page 82), you cannot select these modes.)

- NORMAL SURROUND
- ENHANCED SURROUND
- VIRTUAL REAR SHIFT
- VIRTUAL MULTI REAR
- VIRTUAL MULTI DIMENSION

4 Press ENTER.

To cancel the setting

Select "OFF" in Step 3.

To turn off the Control Menu

Press DISPLAY repeatedly until the Control Menu is turned off.

For 2 speaker setups

When you connect only 2 front speakers, TVS (TV Virtual Surround) lets you enjoy surround sound effects by using sound imaging to create virtual rear speakers from the sound of the front speakers (L: left, R: right) without using actual rear speakers. Select one of the following modes:

If the player is set up to output the signal from the DIGITAL OUT (OPTICAL or COAXIAL) jack, the surround effect will be heard only when "DOLBY DIGITAL" and "DTS" are set to "D-PCM" and "MPEG" is set to "PCM" in "AUDIO SETUP"(page 80).

TVS DYNAMIC

Uses sound imaging to create virtual rear speakers from the sound of the front speakers (L, R) without using actual rear speakers (shown below). The sound imaging effect is distinct and clearly reproduces each aural element of the audio track.

This mode is effective when the distance between the front L and R speakers is short, such as with built-in speakers on a stereo TV.



TVS WIDE

Uses sound imaging to create virtual rear speakers from the sound of the front speakers (L, R) without using actual rear speakers. The virtual speakers are reproduced as shown in the illustration below. This gives the sound an expanded effect that fills the area surrounding the listener.

This mode is effective when the distance between the front L and R speakers is short, such as with built-in speakers on a stereo TV.

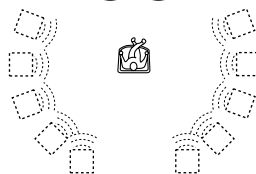

TVS NIGHT

Large sounds, such as explosions, are compressed, but the quieter sounds are unaffected. This feature is useful when you don't want to disturb other people but still want to hear the dialog and enjoy the surround sound effects of "TVS WIDE."

continued

TVS STANDARD

Uses sound imaging to create virtual rear speakers from the sound of the front speakers (L, R) without using actual rear speakers. The virtual speakers are reproduced as shown in the illustration below. Use this setting when you want to use TVS with 2 separate speakers and retain the sound quality.

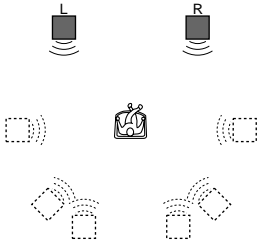

L : Front speaker (left)
R : Front speaker (right)
□ : Virtual speaker

For 4 (or more) speaker setups

You can enjoy the following surround effects by using the 2 front speakers and 2 rear speakers.

Connect the player to the amplifier (receiver) with the **B-1** connection (page 23).

You can experience Dolby Surround (Pro Logic) sounds or Digital Cinema Sound (DCS). DCS uses sound imaging to shift the sound of the rear speakers away from the actual speaker position or create entire sets of virtual rear speakers from one set of actual rear speakers. “VIRTUAL REAR SHIFT,” “VIRTUAL MULTI REAR,” and “VIRTUAL MULTI DIMENSION” make use of this technology.

NORMAL SURROUND

Software with 2 channel audio signals is decoded with the Dolby Surround (Pro Logic) decoder to create surround effects. The rear speakers will emit identical monaural sounds. If you are using a centre speaker, the appropriate sounds for the centre speaker will be delivered.

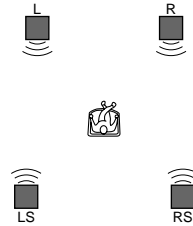

ENHANCED SURROUND

Provides a greater sense of presence from a Dolby Surround (Pro Logic) source with a monaural rear channel signal. Produces a stereo like effect in the rear channels.

VIRTUAL REAR SHIFT

Uses sound imaging to shift the sound of the rear speakers away from the actual speaker position. The virtual speakers are reproduced as shown in the illustration below. The shift position differs according to “REAR” or “SIDE” setting of the rear speakers (page 82).

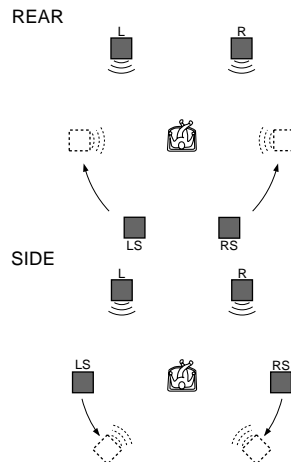

VIRTUAL MULTI REAR

Uses sound imaging to create an array of virtual rear speakers from a single pair of actual rear speakers. The virtual speakers are reproduced as shown in the illustration below. The position of the virtual rear speakers differs according to “REAR” or “SIDE” setting of the rear speakers (page 82).

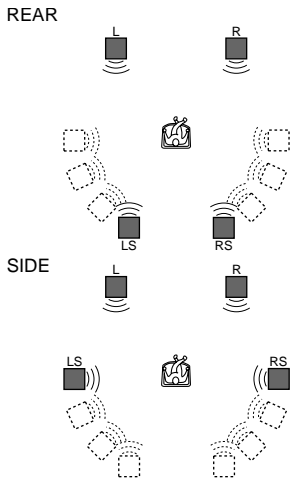

VIRTUAL MULTI DIMENSION

Uses sound imaging to create an array of virtual rear speaker positions higher than the listener from a single pair of actual rear speakers. This mode creates five sets of virtual speakers surrounding the listener at approximately a 30° angle of elevation. The effect differs according to “REAR” or “SIDE” setting of the rear speakers (page 82).

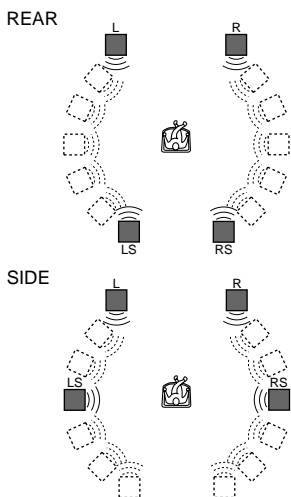

- L : Front speaker (left)
- R : Front speaker (right)
- LS :Rear speaker (left)
- RS :Rear speaker (right)
- : Virtual speaker

You can select “SURROUND” directly by pressing SURROUND. Each time you press the button, the item changes. If you select any setting other than “OFF,” the SURROUND indicator on the player lights up.

Notes

- To enjoy the multichannel audio through the 5.1CH OUTPUT jacks, correctly set each speaker position and distance. For details on setting each speaker, see page 82.
- When you select an item, the sound cuts off for a moment.
- When the playing signal does not contain a signal for the rear speakers (page 55), the surround effects may be difficult to hear.
- When you select “TVS DYNAMIC,” “TVS WIDE,” “TVS NIGHT,” or “TVS STANDARD,” the player does not output the sound from the centre speaker.
- When you select one of the surround modes, turn off the surround setting of the connected TV or amplifier (receiver).
- If the player is set up to output the signal from the DIGITAL OUT (OPTICAL or COAXIAL) jack, the TVS effect will not be heard when you play a CD.
- Make sure that your listening position is between and at an equal distance from your speakers, and that the speakers are located in similar surroundings. Otherwise, the TVS effect may be hard to discern.
- “TVS NIGHT” only works with Dolby Digital discs. However, not all discs will respond to the “TVS NIGHT” function in the same way.
- If you use the DIGITAL OUT (OPTICAL or COAXIAL) jack and set “DOLBY DIGITAL” to “DOLBY DIGITAL,” “DTS” to “DTS,” and “MPEG” to “MPEG” in “AUDIO SETUP,” sound will come from your speakers but it will not have the TVS effect.

Changing the Angles

DVD VIDEO

If various angles (multi-angles) for a scene are recorded on the DVD VIDEO, “ANGLE” appears in the front panel display. This means that you can change the viewing angle.

For example, while playing a scene of a train in motion, you can display the view from either the front of the train, the left window of the train or from the right window without having the train’s movement interrupted.

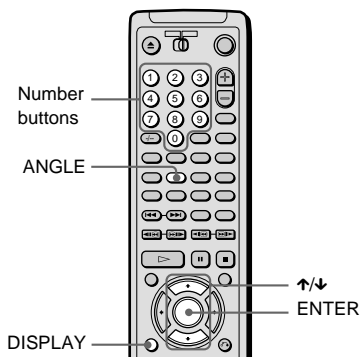

1 Press **DISPLAY** during playback.
The Control Menu appears.

2 Press **↑/↓** to select  (**ANGLE**).

The number of the angle appears.
The number in parentheses indicates the total number of angles.

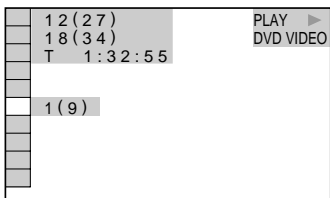

3 Press **→** or **ENTER**.

The number of the angle changes to “-.”

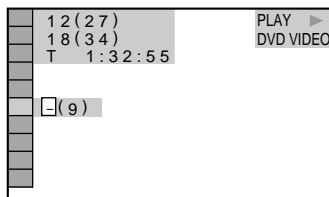



4 Select the angle number using the number buttons or **↑/↓**, then press **ENTER**.

The angle changes to the selected angle.

To turn off the Control Menu

Press **DISPLAY** repeatedly until the Control Menu is turned off.

 You can select the angle directly by pressing **ANGLE**. Each time you press the button, the angle changes.

 You can display all the angles recorded on the disc on the same screen, and start playback directly in continuous mode from the chosen angle. The angles are displayed on a screen divided into 9 sections. For details, see page 48.

Note

Depending on the DVD VIDEO, you may not be able to change the angles even if multi-angles are recorded on the DVD VIDEO.

Displaying the Subtitles

DVD VIDEO DVD-RW

If subtitles are recorded on the discs, you can turn the subtitles on and off whenever you want while playing. If multilingual subtitles are recorded on the disc, you can change the subtitle language while playing, and turn it on or off whenever you want. For example, you can select the language you want to practice and turn the subtitles on for better understanding.

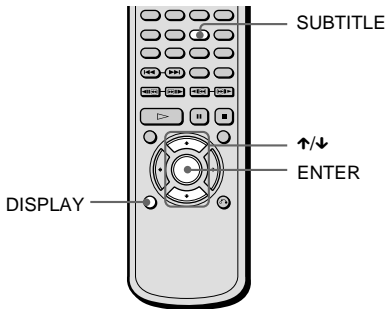

1 Press **DISPLAY** during playback.
The Control Menu appears.

2 Press **↑/↓** to select **(SUBTITLE)**, then press **ENTER**.

The options for “SUBTITLE” appear.

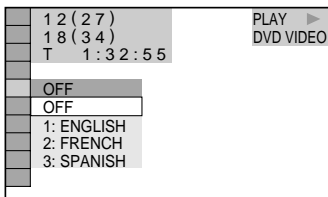

3 Press **↑/↓** to select the setting.

■ When playing a DVD VIDEO

Select the language.

Depending on the DVD VIDEO, the choice of language varies.

When 4 digits are displayed, they indicate a language code. Refer to “Language Code List” on page 93 to see which language the code represents.

■ When playing a DVD-RW

Select “ON.”

4 Press **ENTER**.

To cancel the SUBTITLE setting

Select “OFF” in Step 3.

To turn off the Control Menu

Press **DISPLAY** repeatedly until the Control Menu is turned off.

 You can select “SUBTITLE” directly by pressing **SUBTITLE**. Each time you press the button, the item changes.

Note

Depending on the DVD VIDEO, you may not be able to change the subtitles even if multilingual subtitles are recorded on it.

Adjusting the Picture Quality (BNR)

DVD VIDEO **DVD-RW** **VIDEO CD**

The Block Noise Reduction (BNR) function adjusts the picture quality by reducing the “block noise” or mosaic like patterns that appear on your TV screen.

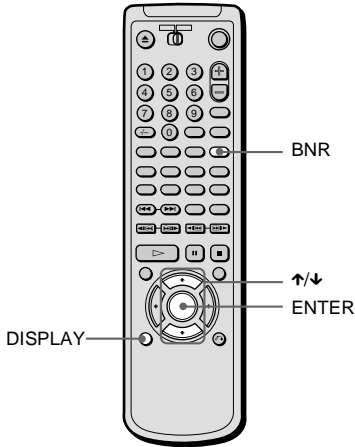

1 Press **DISPLAY** twice during playback.
The Control Menu appears.

2 Press **↑/↓** to select **BNR**, then press **ENTER**.

The options for “BNR” appear.

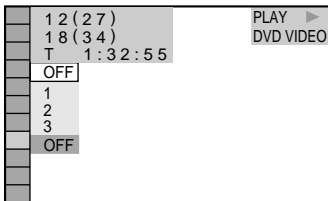

3 Press **↑/↓** to select a level.

As the value increases, the mosaic like patterns on your TV screen will decrease.

- 1: reduces the “block noise”.
- 2: reduces the “block noise” more than 1.
- 3: reduces the “block noise” more than 2.

4 Press **ENTER**.

The disc plays with the setting you selected.

To cancel the “BNR” setting

Select “OFF” in Step 3.

To turn off the Control Menu

Press **DISPLAY** repeatedly until the Control Menu is turned off.

 You can select “BNR” directly by pressing **BNR**. Each time you press the button, the item changes. If you select any setting other than “OFF,” the BNR indicator on the player lights up.

Notes

- If the outlines of the images on your screen should become blurred, set “BNR” to “OFF.”
- Depending on the disc or the scene being played, the “BNR” effect may be hard to discern.

Adjusting the Playback Picture (VIDEO EQUALIZER)

DVD VIDEO **DVD-RW** **VIDEO CD**

You can adjust the video signal of the DVD or VIDEO CD from the player, not from the TV, to obtain the picture quality you want. Choose the setting that best suits the programme you are watching.

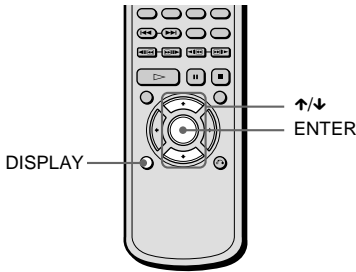

1 Press DISPLAY twice during playback.
The Control Menu appears.

2 Press ↑/↓ to select , then press ENTER.
The options for “VIDEO EQUALIZER” appear.

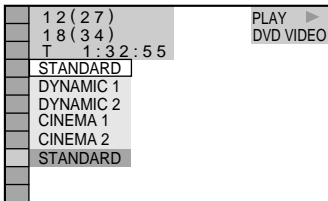

3 Press ↑/↓ to select the setting you want.

- **STANDARD**: displays a standard picture.
- **DYNAMIC 1**: produces a bold dynamic picture by increasing the picture contrast and the colour intensity.

- **DYNAMIC 2**: produces a more dynamic picture than DYNAMIC 1 by further increasing the picture contrast and the colour intensity.
- **CINEMA 1**: enhances details in dark areas by increasing the black level.
- **CINEMA 2**: White colours become brighter and black colours become richer, and the colour contrast is increased.

4 Press ENTER.

To turn off the Control Menu

Press DISPLAY repeatedly until the Control Menu is turned off.

 When you watch a movie, “CINEMA 1” or “CINEMA 2” is recommended.

Enhancing the Playback Picture (DIGITAL VIDEO ENHANCER)

DVD VIDEO **DVD-RW** **VIDEO CD**

The Digital Video Enhancer function makes the picture appear clear and crisp by enhancing the outlines of images on your TV screen. Also, this function can soften the images on the screen.

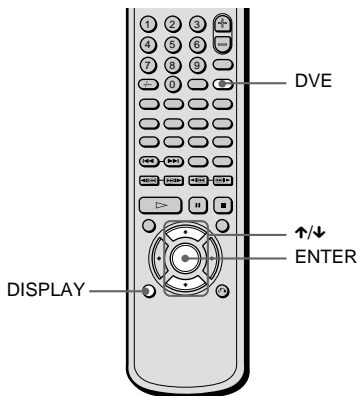

1 Press **DISPLAY** twice during playback.

The Control Menu appears.

2 Press **↑/↓** to select , then press **ENTER**.

The options for “DIGITAL VIDEO ENHANCER” appear.

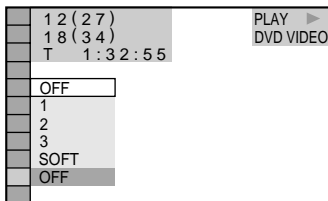

3 Press **↑/↓** to select a level.

As the value increases, the outlines of images on your TV screen will become crisper.

- 1: enhances the outline.
- 2: enhances the outline more than 1.
- 3: enhances the outline more than 2.
- SOFT: softens the image (DVD VIDEO/DVD-RW only).

4 Press **ENTER**.

The disc plays with the setting you selected.

To cancel the “DIGITAL VIDEO ENHANCER” setting

Select “OFF” in Step 3.

To turn off the Control Menu

Press **DISPLAY** repeatedly until the Control Menu is turned off.

 You can select “DIGITAL VIDEO ENHANCER” directly by pressing **DVE**. Each time you press the button, the item changes.

Note

Depending on the DVD/VIDEO CD disc or the scene being played, noise found in the disc may become more apparent. If this happens, it is recommended that you use the BNR function (page 62) with the DVE function. If the condition still does not improve, reduce the Digital Video Enhancer level, or select “SOFT” (DVD VIDEO/DVD-RW only) in Step 3 above.

Locking Discs (CUSTOM PARENTAL CONTROL, PARENTAL CONTROL)

You can set two kinds of playback restrictions for the desired disc.

- Custom Parental Control

You can set the playback restrictions so that the player will not play inappropriate discs.

- Parental Control

Playback of some DVD VIDEOS can be limited according to a predetermined level such as the age of the users.

The same password is used for both Parental Control and Custom Parental Control.

Custom Parental Control

DVD VIDEO VIDEO CD SACD CD

You can set the same Custom Parental Control password for up to 50 discs. When you set the fifty-first disc, the first disc is cancelled.

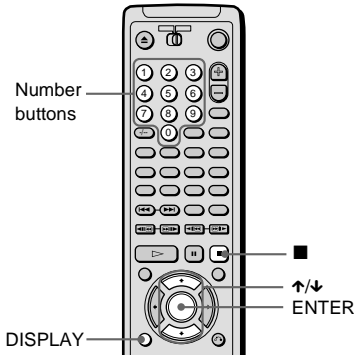

1 Insert the disc you want to lock.
If the disc is playing, press ■ to stop playback.

2 Press DISPLAY while the player is in stop mode.
The Control Menu appears.

3 Press ↑/↓ to select  (PARENTAL CONTROL), then press ENTER.

The options for “PARENTAL CONTROL” appear.

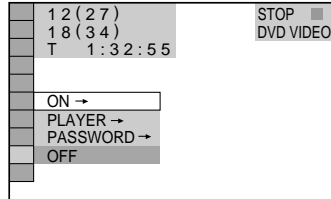

4 Press ↑/↓ to select “ON →,” then press ENTER.

■ If you have not entered a password

The display for registering a new password appears.

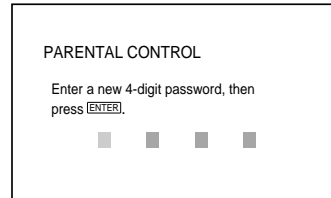

Enter a 4-digit password by using the number buttons, then press ENTER.
The display for confirming the password appears.

■ When you have already registered a password

The display for entering the password appears.

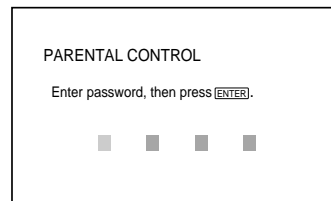

- 5 Enter or re-enter your 4-digit password by using the number buttons, then press ENTER.

“Custom parental control is set.” appears and then the screen returns to the Control Menu display.

To turn off the Custom Parental Control function

- 1 Follow Steps 1 through 3 of “Custom Parental Control.”
- 2 Press \uparrow/\downarrow to select “OFF \rightarrow ,” then press ENTER.
- 3 Enter your 4-digit password using the number buttons, then press ENTER.

To play a disc for which Custom Parental Control is set

- 1 Insert the disc for which Custom Parental Control is set.
The “CUSTOM PARENTAL CONTROL” display appears.

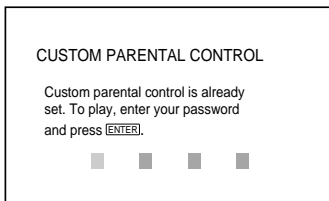

- 2 Enter your 4-digit password using the number buttons, then press ENTER.
The player is ready for playback.

If you forget your password, enter the 6-digit number “199703” using the number buttons when the “CUSTOM PARENTAL CONTROL” display asks you for your password, then press ENTER. The display will ask you to enter a new 4-digit password.

Parental Control (limiting playback by children) **DVD VIDEO**

Playback of some DVD VIDEOS can be limited according to a predetermined level such as the age of the users. The “PARENTAL CONTROL” function allows you to set a playback limitation level. A scene that is limited is not played, or it is replaced by a different scene.

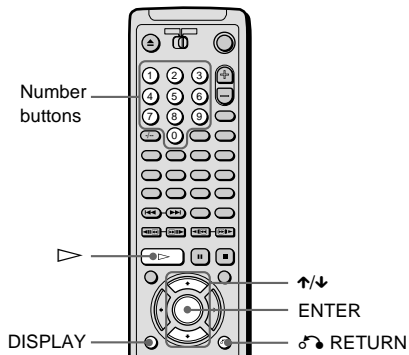

- 1 Press DISPLAY while the player is in stop mode.
The Control Menu appears.

- 2 Press \uparrow/\downarrow to select (PARENTAL CONTROL), then press ENTER.
The options for “PARENTAL CONTROL” appear.

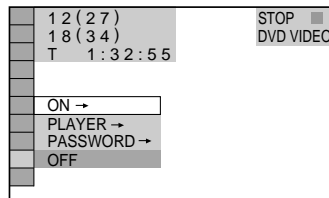

- 3** Press \uparrow/\downarrow to select "PLAYER \rightarrow ," then press ENTER.

■ If you have not entered a password

The display for registering a new password appears.

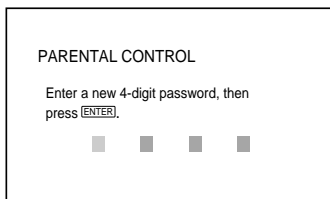

Enter a 4-digit password using the number buttons, then press ENTER. The display for confirming the password appears.

■ When you have already registered a password

The display for entering the password appears.

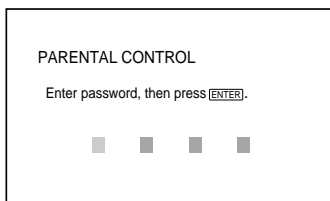

- 4** Enter or re-enter your 4-digit password by using the number buttons, then press ENTER.

The display for setting the playback limitation level appears.

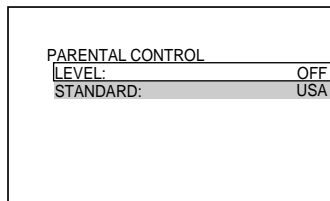

- 5** Press \uparrow/\downarrow to select "STANDARD," then press ENTER.

The selection items for "STANDARD" are displayed.

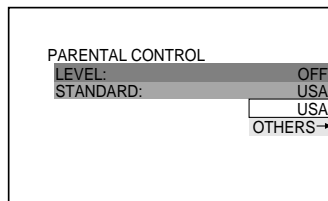

- 6** Press \uparrow/\downarrow to select a geographic area as the playback limitation level, then press ENTER.

The area is selected.

When you select "OTHERS \rightarrow ," select and enter a standard code in the table on page 68 using the number buttons.

- 7** Press \uparrow to select "LEVEL," then press ENTER.

The selection items for "LEVEL" are displayed.

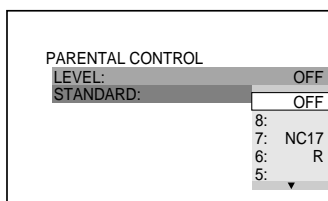

- 8** Select the level you want using \uparrow/\downarrow , then press ENTER.

Parental Control setting is complete.

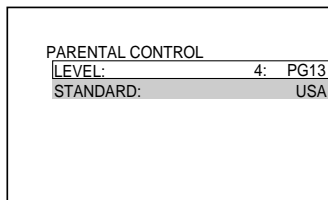

The lower the value, the stricter the limitation.

continued

To turn off the Parental Control function

Set “LEVEL” to “OFF” in Step 8.

To play a disc for which Parental Control is set

- 1 Insert the disc and press \triangleright .
The “PARENTAL CONTROL” display appears.
- 2 Enter your 4-digit password using the number buttons, then press ENTER.
The player starts playback.

 If you forget your password, remove the disc and repeat Step 1 to 3 of “Parental Control (limiting playback by children).” When you are asked to enter your password, enter “199703” using the number buttons, then press ENTER. The display will ask you to enter a new 4-digit password. After you enter a new 4-digit password in Step 4, replace the disc in the player and press \triangleright . When the “PARENTAL CONTROL” display appears, enter your new password.

Notes

- When you play DVD VIDEOS which do not have the Parental Control function, playback cannot be limited on this player.
- Depending on the DVD VIDEO, you may be asked to change the parental control level while playing the disc. In this case, enter your password, then change the level. If the Resume Play mode is cancelled, the level returns to the original level.

Area Code

Standard	Code number	Standard	Code number
Argentina	2044	Korea	2304
Australia	2047	Malaysia	2363
Austria	2046	Mexico	2362
Belgium	2057	Netherlands	2376
Brazil	2070	New Zealand	2390
Canada	2079	Norway	2379
Chile	2090	Pakistan	2427
China	2092	Philippines	2424
Denmark	2115	Portugal	2436
Finland	2165	Russia	2489
France	2174	Singapore	2501
Germany	2109	Spain	2149
Hong Kong	2219	Sweden	2499
India	2248	Switzerland	2086
Indonesia	2238	Taiwan	2543
Italy	2254	Thailand	2528
Japan	2276	United Kingdom	2184

Changing the password

DVD VIDEO VIDEO CD SACD CD

- 1 Press **DISPLAY** while the player is in stop mode.
The Control Menu appears.
- 2 Press **↑/↓** to select  (PARENTAL CONTROL), then press **ENTER**.
The options for "PARENTAL CONTROL" appear.
- 3 Press **↑/↓** to select "PASSWORD →," then press **ENTER**.
The display for entering the password appears.
- 4 Enter your 4-digit password using the number buttons, then press **ENTER**.
- 5 Enter a new 4-digit password using the number buttons, then press **ENTER**.
- 6 To confirm your password, re-enter it using the number buttons, then press **ENTER**.

If you make a mistake entering your password

Press **←** before you press **ENTER** in Step 5 and input the correct number.

If you make a mistake

Press **↶** RETURN.

To turn off the Control Menu

Press **DISPLAY** repeatedly until the Control Menu is turned off.

Operation Sound Effects

(Sound Feedback)

The player beeps when the following operations are performed.

The default setting of the Sound Feedback function is set to off.

Operation	Operation sound
Power is turned on	One beep
Power is turned off	Two beeps
▷ is pressed	One beep
 is pressed	Two beeps
Playback is stopped	One long beep
Operation is not possible	Three beeps

To set Sound Feedback

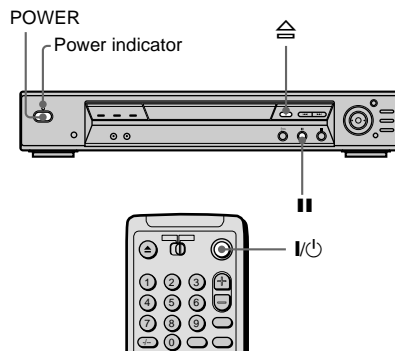

- 1 Press **POWER** on the player, then press **I/⏻** on the remote.
The power indicator lights up in green.
When there is a disc in the player, press **⏻** and remove the disc. Then press **⏻** again to close the disc tray.
- 2 Press and hold **||** on the player for more than two seconds.
You will hear one beep and the Sound Feedback function is turned on.

To turn off the Sound Feedback function

When there is no disc in the player, press and hold **II** on the player for more than two seconds. You will hear two beeps and the Sound Feedback function is turned off.

Controlling Your TV or AV Amplifier (Receiver) with the Supplied Remote

By adjusting the remote signal, you can control your TV with the supplied remote. If you connect the player with a AV amplifier (receiver), you can control the volume with the supplied remote.

Check the model name of your remote

The supplied remote commander is different depending on the player model. Check the model name of your remote (RMT-D131E, RMT-D131O, or RMT-D131A) and follow the instructions that correspond to your remote's model name. Note that the buttons you can use for operating your TV will differ according to the model of your remote.

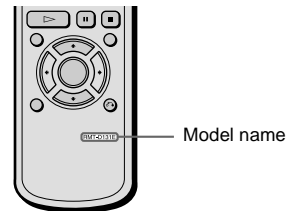

Notes

- Depending on the units being connected, you may not be able to control your TV or AV amplifier (receiver) using some of the buttons below.
- If you enter a new code number, the code number previously entered will be erased.
- When you replace the batteries of the remote, the code number you have set may be reset to the default setting. Set the appropriate code number again.

Controlling TVs with the remote

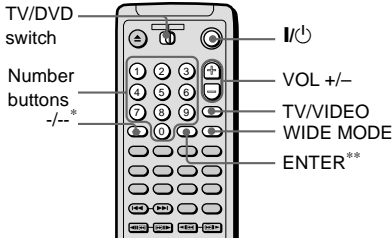

* RMT-D131E and D131O only

** RMT-D131A only

- 1** Slide the TV/DVD switch to TV.
- 2** Hold down I/Power, and enter your TV's manufacturer's code (see the table below) using the number buttons.
- 3** Release I/Power.

Code numbers of controllable TVs

If more than one code number is listed, try entering them one at a time until you find the one that works with your TV.

RMT-D131E

Manufacturer	Code number
Sony	01 (default), 03, 04
Aiwa	32
Akai	68
Blaupunkt	10, 21
Grundig	10, 11
Hitachi	24
JVC	33
Loewe	45
Mitsubishi	27, 28, 50
Mivar	09
NEC	66
Nokia	15, 16, 69
Orion	47, 48
Panasonic	17, 49

Manufacturer	Code number
Philips	06, 07, 08
Pioneer	26
Saba	12, 13
Samsung	22, 23
Sanyo	25
Sharp	29
Siemens	39
TEAC	67
Telefunken	36
Tomson	43
Toshiba	38

RMT-D131O

Manufacturer	Code number
Sony (default)	01
Grundig	11
Hitachi	24
Loewe	45
Nokia	15, 16, 69
Panasonic	17, 49
Philips	06, 07, 08
Saba	12, 13
Samsung	22, 23
Sanyo	25
Sharp	29
Telefunken	36
Thomson	43
Toshiba	38

continued

RMT-D131A

Manufacturer	Code number	Manufacturer	Code number
Sony (default)	01	Panasonic	06,19
Akai	04	Philco	03,04
AOC	04	Philips	08,21
Centurion	12	Pioneer	16
Coronado	03	Portland	03
Curtis-Mathes	12	Quasar	06,18
Daytron	12	Radio Shack	05,14
Emerson	03,04,14	RCA	04,10
Fisher	11	Sampo	12
General Electric	06,10	Samsung	20
Gold Star	03,04,17	Sanyo	11
Hitachi	02,03	Scott	12
J.C.Penney	04,12	Sears	07,10,11
JVC	09	Sharp	03,05,18
KMC	03	Sylvania	08,12
Magnavox	03,08,12	Teknika	03,08,14
Marantz	04,13	Toshiba	07
MGA/ Mitsubishi	04,12,13, 17	Wards	03,04,12
NEC	04,12	Yorx	12
		Zenith	15

Controlling the TV

When you set the TV/DVD switch to TV, you can control the following items with the supplied remote.

By pressing	You can
I/⏻	Turn the TV on or off
VOL +/-	Adjust the volume of the TV
WIDE MODE	Switch to or from the wide mode of a Wide TV (Sony's wide TV only for RMT-D131A)
TV/VIDEO	Switch the TV's input source between the TV and player The button works even if the TV/DVD switch is set to DVD.

RMT-D131E

and D131O only

Number buttons, Select the programme position -/--.*

RMT-D131A only

Number buttons, Select the channel of the TV
ENTER

* If you use number buttons to select the TV's programme position, press -/-- followed by the number buttons for two-digit numbers.

Controlling the volume of your AV amplifier (receiver) with the remote

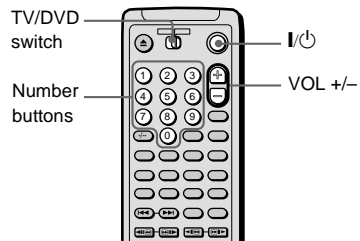

- 1 Slide the TV/DVD switch to DVD.
- 2 Hold down I/⏻, and enter your AV amplifier (receiver)'s manufacturer's code (see the table below) using the number buttons.
- 3 Release I/⏻.

Code numbers of controllable AV amplifiers (receivers)

If more than one code number is listed, try entering them one at a time until you find the one that works with your AV amplifier (receiver).

If you do not connect an AV amplifier (receiver), you can control your TV's volume by setting the code number to 90 (default). However, you must first set the code number of controllable TVs as explained above.

Manufacturer	Code number
Sony	80, 88, 89, 91
Denon	84, 85, 86
Kenwood	92, 93
Onkyo	81, 82, 83
Pioneer	99
Sansui	87
Technics	97, 98
Yamaha	94, 95, 96

Controlling the AV amplifiers (receivers)

When you set the TV/DVD switch to DVD, you can control the volume of the AV amplifier (receiver) using VOL +/-.

Using the Setup Display

By using the Setup Display, you can make various adjustments to items such as picture and sound. You can also set a language for the subtitles and the Setup Display, among other things. For details on each Setup Display item, see page 75. For an overall list of Setup Display items, see page 94.

Note

Playback settings stored in the disc take priority over the Setup Display settings and not all the functions described may work.

How to use the Setup Display

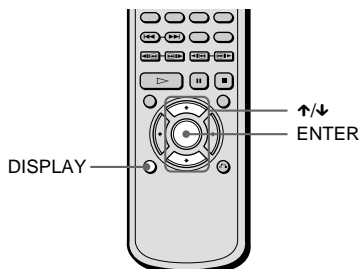

- 1 Press **DISPLAY** when the player is in stop mode.
The Control Menu appears.

- 2 Press **↑/↓** to select  (**SETUP**), then press **ENTER**.
The options for "SETUP" appear.

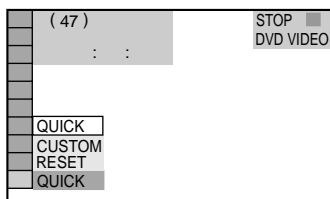

- 3 Press **↑/↓** to select "CUSTOM," then press **ENTER**.
The Setup Display appears.

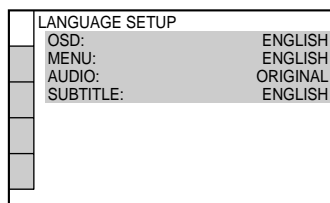

- 4 Press **↑/↓** to select the setup item from the displayed list: "LANGUAGE SETUP," "SCREEN SETUP," "CUSTOM SETUP," "AUDIO SETUP," or "SPEAKER SETUP." Then press **ENTER**.

The selected Setup item appears.
Example: "SCREEN SETUP"

Selected item

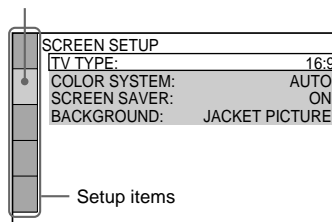

- 5 Select an item using **↑/↓**, then press **ENTER**.
The options for the selected item appear.
Example: "TV TYPE"

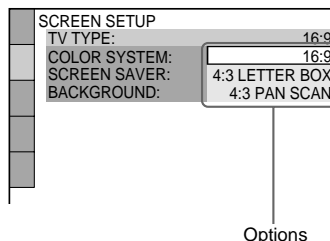

- 6** Select a setting using \uparrow/\downarrow , then press ENTER.
The setting is selected and setup is complete.
Example: "4:3 PAN SCAN"

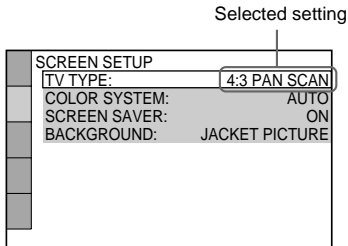

To turn off the Setup Display

Press DISPLAY repeatedly until the Setup Display is turned off.

If you select "QUICK" in Step 3, you will enter the Quick Setup mode (page 28). Follow from Step 5 of the Quick Setup explanation to make basic adjustments.

If you select "RESET" in Step 3, you can reset all of the "SETUP" settings on page 94 to 97 to the default settings. After you select "RESET" and press ENTER, select "YES" and press ENTER to reset the settings (it takes a few seconds to complete), or select "NO" and press ENTER to return to the Control Menu. Do not press POWER or I/O when resetting the player.

Setting the Display or Sound Track Language (LANGUAGE SETUP)

"LANGUAGE SETUP" allows you to set various languages for the on-screen display or sound track.

Select "LANGUAGE SETUP" in the Setup Display. For details on using the display, see "Using the Setup Display" (page 74).

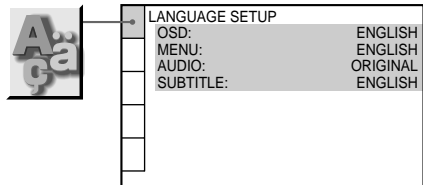

■ OSD (On-Screen Display)

Switches the display language on the screen. Select the language from the displayed list.

■ MENU (DVD VIDEO only)

You can select the desired language for the disc's menu.

■ AUDIO (DVD VIDEO only)

Switches the language of the sound track. Select the language from the displayed list. When you select "ORIGINAL," the language given priority in the disc is selected.

■ SUBTITLE (DVD VIDEO only)

Switches the language of the subtitle recorded on the DVD VIDEO. Select the language from the displayed list. When you select "AUDIO FOLLOW," the language for the subtitles changes according to the language you selected for the sound track.

 If you select “OTHERS →” in “MENU,” “SUBTITLE,” and “AUDIO,” select and enter a language code from “Language Code List” (page 93) using the number buttons.

Note

When you select a language that is not recorded on the DVD VIDEO, one of the recorded languages will be automatically selected (except for the “OSD”).

Settings for the Display (SCREEN SETUP)

Choose settings according to the TV to be connected.

Select “SCREEN SETUP” in the Setup Display. For details on using the display, see “Using the Setup Display” (page 74). The default settings are underlined.

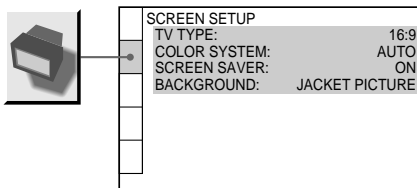

TV TYPE

Selects the aspect ratio of the connected TV (4:3 standard or wide).

<u>16:9</u>	Select this when you connect a wide-screen TV or a TV with a wide mode function.
4:3 LETTER BOX	Select this when you connect a 4:3 screen TV. Displays a wide picture with bands on the upper and lower portions of the screen.
4:3 PAN SCAN	Select this when you connect a 4:3 screen TV. Automatically displays the wide picture on the entire screen and cuts off the portions that do not fit.

16:9



4:3 LETTER BOX

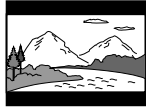

4:3 PAN SCAN



Note

Depending on the DVD, “4:3 LETTER BOX” may be selected automatically instead of “4:3 PAN SCAN” or vice versa.

■ COLOR SYSTEM (VIDEO CD only)

Selects the colour system when you play a VIDEO CD.

<u>AUTO</u>	Outputs the video signal in the system of the VIDEO CD, either PAL or NTSC. If your TV is the DUAL system, select AUTO.
PAL	Changes the video signal of an NTSC VIDEO CD and outputs it in the PAL system.
NTSC	Changes the video signal of a PAL VIDEO CD and outputs it in the NTSC system.

Notes

- You cannot change the colour system for DVDs.
- You can change the colour system of this player according to the connected TV. See page 16.

■ SCREEN SAVER

Turns on and off the screen saver so that the screen saver image appears when you leave the player in pause or stop mode for 15 minutes, or when you play back an SACD/CD for more than 15 minutes. The screen saver will help prevent your display device from becoming damaged (ghosting).

Press \triangleright to turn off the screen saver.

<u>ON</u>	Turns on the screen saver.
OFF	Turns off the screen saver.

■ BACKGROUND

Selects the background colour or picture on the TV screen in stop mode or while playing an SACD/CD.

<u>JACKET PICTURE</u>	The jacket picture (still picture) appears in the background, but only when the jacket picture is already recorded on the disc (CD-EXTRA, etc.). If the disc does not contain a jacket picture, the “GRAPHICS” picture appears.
GRAPHICS	A preset picture stored in the player appears in the background.
BLUE	The background colour is blue.
BLACK	The background colour is black.

Custom Settings (CUSTOM SETUP)

Use this to set up playback related and other settings.

Select “CUSTOM SETUP” in the Setup Display. For details on using the display, see “Using the Setup Display” (page 74). The default settings are underlined.



CUSTOM SETUP	
AUTO PLAY:	OFF
DIMMER:	BRIGHT
PAUSE MODE:	AUTO
PLAYBACK MEMORY:	ON
TRACK SELECTION:	OFF
CD DIRECT:	OFF

■ AUTO PLAY

Select the Auto Play setting when you turn on the player.

<u>OFF</u>	Does not use “TIMER,” “DEMO1,” or “DEMO2” to start playback.
TIMER	Starts playing when the player is turned on. The player can start playback at any time when connected to a timer (not supplied). Set the timer when the player is in standby mode (the power indicator lights up in red).
DEMO1	Starts playing the first demonstration automatically.
DEMO2	Starts playing the second demonstration automatically.

■ DIMMER

Adjusts the lighting of the front panel display.

<u>BRIGHT</u>	Makes the front panel display bright.
DARK	Makes the front panel display dark.
OFF	Turns off the lighting of the front panel display.

■ PAUSE MODE (DVD VIDEO/DVD-RW only)

Selects the picture in pause mode.

<u>AUTO</u>	The picture, including subjects that move dynamically, is output with no jitter. Normally select this position.
FRAME	The picture, including subjects that do not move dynamically, is output in high resolution.

■ PLAYBACK MEMORY (DVD VIDEO/VIDEO CD only)

The player can store the “SUBTITLE” and other settings of each disc for up to 50 discs (Playback Memory).

Set the Playback Memory function “ON” or “OFF.”

<u>ON</u>	Stores the settings in memory when you eject the disc.
OFF	Does not store the settings in memory.

The following settings are stored in memory by the Playback Memory function.

- ANGLE (page 60)*
 - AUDIO (page 54)*
 - BNR (page 62)
 - DIGITAL VIDEO ENHANCER (page 64)
 - SUBTITLE (page 61)*
 - VIDEO EQUALIZER (page 63)
- * DVD VIDEO only

Notes

- The player can store the settings of up to 50 discs. When you store the setting of disc number 51, the first disc setting is cancelled.
- The Playback Memory function cannot be used for DVD-RWs in VR mode.
- During playback, do not turn off the player by pressing POWER on the player. Doing so may cancel the settings. When you turn off the player, press ■ first to stop playback and then press I/⏻ on the remote. After the power indicator lights up in red and the player enters standby mode, press POWER on the player.

■ TRACK SELECTION (DVD VIDEO only)

Gives the sound track which contains the highest number of channels priority when you play a DVD VIDEO on which multiple audio formats (PCM, MPEG audio, DTS, or Dolby Digital format) are recorded.

<u>OFF</u>	No priority given.
AUTO	Priority given.

Notes

- When you set the item to “AUTO,” the language may change. The “TRACK SELECTION” setting has higher priority than the “AUDIO” settings in “LANGUAGE SETUP” (page 75).
- If PCM, DTS, MPEG audio, and Dolby Digital sound tracks have the same number of channels, the player selects PCM, DTS, Dolby Digital, and MPEG audio sound tracks in this order.

■ CD DIRECT

Eliminates the use of unnecessary circuits when playing CDs. This setting will be activated when you open/close the disc tray.

This function affects the output of the following jacks.

- LINE OUT L/R (AUDIO) 1/2 jacks
- 5.1CH OUTPUT jacks

<u>OFF</u>	Select this when playing CD discs, including CD type DTS discs.
ON	Eliminates the use of unnecessary circuits needed to play CDs.

Note

If you select “ON” when playing CD type DTS discs, the sound will become noisy.

Settings for the Sound (AUDIO SETUP)

“AUDIO SETUP” allows you to set the sound according to the playback and connection conditions.

Select “AUDIO SETUP” in the Setup Display. For details on using the display, see “Using the Setup Display” (page 74). The default settings are underlined.

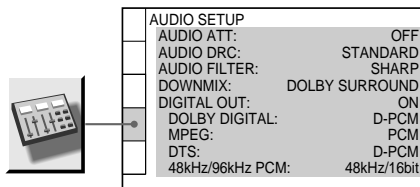

■ AUDIO ATT (attenuation)

If the playback sound is distorted, set this item to “ON.” The player reduces the audio output level.

This function affects the output of the following jacks:

- LINE OUT L/R (AUDIO) 1/2 jacks
- 5.1CH OUTPUT jacks

<u>OFF</u>	Turns off the audio attenuation. Normally, select this position.
ON	Reduces the audio output level so that no sound distortion occurs. Select this when the playback sound from the speakers is distorted.

■ AUDIO DRC (Dynamic Range Control) (DVD VIDEO/DVD-RW only)

Makes the sound clear when the volume is turned down when playing a DVD that has the “AUDIO DRC” function. This affects the output from the following jacks:

- LINE OUT L/R (AUDIO) 1/2 jacks
- 5.1CH OUTPUT jacks
- DIGITAL OUT (OPTICAL or COAXIAL) jack only when “DOLBY DIGITAL” is set to “D-PCM” (page 80).

continued

STANDARD	Normally select this position.
TV MODE	Makes the low sounds clear even if you turn the volume down. It is especially recommended when you listen to the sound using the speakers of the TV.
WIDE RANGE	Gives you the feeling of being at a live performance. When you use high quality speakers, it is even more effective.

■ AUDIO FILTER (except SACD)

Selects the digital filter to reduce noises above the 22.05 kHz (Sampling frequency (Fs) of the audio sources is 44.1 kHz), 24 kHz (Fs is 48 kHz), or 48 kHz (Fs is above 96 kHz).

SHARP	Provides a wide frequency range and spatial feeling.
SLOW	Provides smooth and warm sound.

Notes

- There may be little effect by changing the digital filter depending on discs or playback environment.
- There is no effect on SACDs.

■ DOWNMIX (DVD VIDEO/DVD-RW only)

Switches the mixing down methods when you play a DVD on which rear signal components such as “LS”, “RS”, or “S” are recorded in Dolby Digital or DTS format. For details on the rear signal components, see “Changing the Sound” (page 54). This function affects the output of the following jacks:

- LINE OUT L/R (AUDIO) 1/2 jacks
- DIGITAL OUT (OPTICAL or COAXIAL) jack when “DOLBY DIGITAL” and “DTS” are set to “D-PCM” (page 80).

DOLBY SUR-ROUND	Select this when the player is connected to an audio component that conforms to Dolby Surround (Pro Logic). The output signals which reproduce the Dolby Surround effect are downmixed to 2 channels.
NORMAL	Select this when the player is connected to an audio component that does not conform to Dolby Surround (Pro Logic). All of the output signals are downmixed to 2 channels without the Dolby Surround (Pro Logic) effect.

■ DIGITAL OUT

Selects if audio signals are output via the DIGITAL OUT (OPTICAL or COAXIAL) jack.

ON	Normally select this position. When you select “ON,” set “DOLBY DIGITAL,” “MPEG,” “DTS,” and “48kHz/96kHz PCM.” For details on setting these items, see “Setting the digital output signal.”
OFF	The player does not output the audio signals via the DIGITAL OUT (OPTICAL or COAXIAL) jack. The influence of the digital circuit upon the analog circuit is minimal.

Note

SACD audio signals are not output from a digital jack.

Setting the digital output signal

Switches the method of outputting audio signals when you connect the following component using an optical or a coaxial digital cord via the DIGITAL OUT (OPTICAL or COAXIAL) jack.

- Amplifier (receiver) with digital input jack
- Amplifier (receiver) with a built-in DTS, MPEG audio, or DOLBY DIGITAL decoder
- MD or DAT deck

For connection details, see page 21.
 Select “DOLBY DIGITAL,” “MPEG,”
 “DTS,” and “48kHz/96kHz PCM” after setting
 “DIGITAL OUT” to “ON.”

AUDIO SETUP	
AUDIO ATT:	OFF
AUDIO DRC:	STANDARD
AUDIO FILTER:	SHARP
DOWNMIX:	DOLBY SURROUND
DIGITAL OUT:	ON
DOLBY DIGITAL:	D-PCM
MPEG:	PCM
DTS:	D-PCM
48kHz/96kHz PCM:	48kHz/16bit

■ DOLBY DIGITAL (DVD VIDEO/DVD-RW only)

Selects the Dolby Digital signals to be output via the DIGITAL OUT (OPTICAL or COAXIAL) jack.

<u>D-PCM</u>	Select this when the player is connected to an audio component lacking a built-in Dolby Digital decoder. You can select whether the signals conform to Dolby Surround (Pro Logic) or not by making adjustments to the “DOWNMIX” item in “AUDIO SETUP” (page 79).
DOLBY DIGITAL	Select this when the player is connected to an audio component with a built-in Dolby Digital decoder. If the player is connected to an audio component lacking a built-in Dolby Digital decoder, do not set this. Otherwise, when you play the Dolby Digital sound track, a loud noise (or no sound) will come out from the speakers, affecting your ears or causing the speakers to be damaged.

■ MPEG (DVD VIDEO/DVD-RW only)

Selects the MPEG audio signals to be output via the DIGITAL OUT (OPTICAL or COAXIAL) jack.

<u>PCM</u>	Select this when the player is connected to an audio component lacking a built-in MPEG decoder. If you play MPEG audio sound tracks, the player outputs stereo signals via the DIGITAL OUT (OPTICAL or COAXIAL) jack.
MPEG	Select this when the player is connected to an audio component having a built-in MPEG decoder. If the player is connected to an audio component lacking a built-in MPEG decoder, do not set this. Otherwise, when you play the MPEG audio sound track, a loud noise (or no sound) will come out from the speakers, affecting your ears or causing the speakers to be damaged.

■ DTS (DVD VIDEO only)

Selects the DTS signals to be output via the DIGITAL OUT (OPTICAL or COAXIAL) jack.

<u>D-PCM</u>	Select this when the player is connected to an audio component lacking a built-in DTS decoder. If you play DTS audio sound tracks, the player outputs stereo signals via the DIGITAL OUT (OPTICAL or COAXIAL) jacks.
--------------	--

DTS	Select this when the player is connected to an audio component having a built-in DTS decoder. If the player is connected to an audio component lacking a built-in DTS decoder, do not set this. Otherwise, when you play the DTS sound track, a loud noise (or no sound) will come out from the speakers, affecting your ears or causing the speakers to be damaged.
-----	--

■ 48kHz/96kHz PCM (DVD VIDEO only)

Selects the sampling frequency of the audio signal to be output via the DIGITAL OUT (OPTICAL or COAXIAL) jack.

<u>48kHz/16bit</u>	The audio signals of DVD VIDEOS are always converted to 48kHz/16bit.
96kHz/24bit	All types of signals including 96kHz/24bit are output in their original format. However, if the signal is encrypted for copyright protection purposes, the signal is only output as 48kHz/16bit. If a receiver (amplifier) which cannot accept 96kHz is connected to the player, do not set this. Otherwise, a loud noise may come out from the speakers.

Notes

- Even if you set “48kHz/96kHz PCM” in “AUDIO SETUP” to “96kHz/24bit,” the sampling frequency is converted to 48kHz/16bit when a “SURROUND” mode (page 56) is selected.
- The analog audio signals from the LINE OUT L/R (AUDIO) 1/2 jacks are not affected by this setting and keep their original sampling frequency level.

Settings for the Speakers (SPEAKER SETUP)

To obtain the best possible surround sound, set the size of the speakers you have connected and their distance from your listening position. Then use the test tone to adjust the volume and the balance of the speakers to the same level.

This setting is effective when connecting the speaker with 5.1 CH OUTPUT jacks (page 23).

Select “SPEAKER SETUP” in the Setup Display. For details on using the display, see “Using the Setup Display” (page 74).

The default settings are underlined.

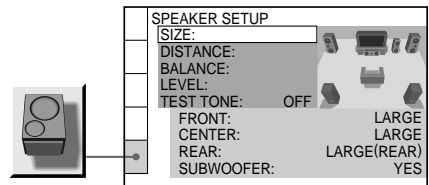

To return to the default setting

Select the item, then press CLEAR. Note that only the “SIZE” setting does not return to the default setting.

■ SIZE

Selects the size of the speakers to be connected.

- FRONT

<u>LARGE</u>	Normally select this position.
SMALL	When the sound cracks or the surround sound effects are difficult to hear, select this. This activates the bass redirection circuitry and outputs the bass frequencies of the front speaker from the subwoofer.

• CENTER

NONE	If you do not connect a centre speaker, select this.
LARGE	Normally select this position.
SMALL	When the sound cracks or the surround sound effects are difficult to hear, select this. This activates the bass redirection circuitry and outputs the bass frequencies of the centre speaker from other speakers.

• REAR

NONE	If you do not connect rear speakers, select this.
LARGE	(REAR/SIDE): Normally select this position. Select either of these according to the rear speaker's position*.
SMALL	(REAR/SIDE): When the sound cracks or the surround sound effects are difficult to hear, select this. Select either of these according to the rear speaker's position*. This activates the bass redirection circuitry and outputs the bass frequencies of the rear speaker from other speakers.

* Rear speaker position

Correctly specify the location of the rear speakers to enjoy the surround effect.

- Set to the "SIDE," if the location of the rear speakers corresponds to section **A** below.
- Set to the "REAR," if the location of the rear speakers corresponds to section **B** below.

This setting affects only "VIRTUAL REAR SHIFT," "VIRTUAL MULTI REAR," and "VIRTUAL MULTI DIMENSION" mode (page 56). These settings do not affect the SACD Multi audio signals.

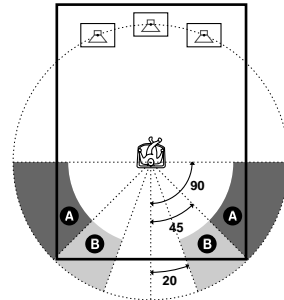

• SUBWOOFER

NONE	If you do not connect a subwoofer, select this. This activates the bass redirection circuitry and outputs the LFE signals from the front speakers as long as the front speaker size is set to "LARGE."
YES	If you connect a subwoofer, select this to output the LFE (low frequency effect) channel from the subwoofer. When you set the other speakers settings to "SMALL," the subwoofer makes up for the missing bass frequencies of the speakers.

Notes

- The cut off frequency for the subwoofer is fixed at 120 Hz.
- If your speakers are too small to reproduce low bass frequencies, please set all speaker settings to "SMALL" and utilize a subwoofer for low frequency sound.
- Even if there are fewer than 6 speakers connected, the player distributes the audio signal components to the front speakers.

■ DISTANCE

You can set distance from the listening position to your speakers. Set the distance to your front speakers in “FRONT” first. Values in “CENTER” (centre speaker) and “REAR” (rear speaker) will automatically change to the same value. Adjust these values to reflect the actual distance to your centre and rear speakers within the area described in the following table.

The default distance setting for the speakers in relation to the listening position is shown below.

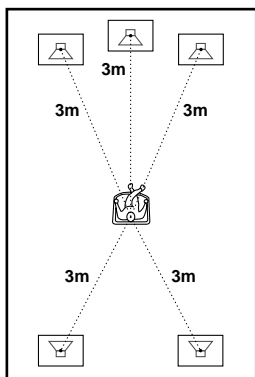

Be sure to change the value in the Setup Display when you move the speakers. The default adjustments are in parentheses.

FRONT (3m)	Front speaker distance from the listening position can be set in 0.2 metre increments from 1 to 15 metres.
CENTER (3m)	Centre speaker distance can be moved up to 0.6 metres backward from the front speakers or 1.6 metres forward closer to the listening position, in 0.2 metre increments.
REAR (3m)	Rear speaker distance can be moved up to 5 metres closer to your listening position from the front speaker position, in 0.2 metre increments.

Notes

- If each of the front or rear speakers are not placed at an equal distance from your listening position, set the distance according to the closest speaker.
- Do not place the rear speakers farther away from your listening position than the front speakers.
- These settings do not affect the SACD Multi audio signals.

■ BALANCE

You can vary the balance of the left and right speakers as follows. Be sure to set “TEST TONE” to “ON” for easy adjustment. The default adjustments are in parentheses.

FRONT (0dB)	Adjust the balance between the front left and right speakers (–6dB [L] to +6dB [R], 0.5dB increments).
REAR (0dB)	Adjust the balance between the rear left and right speakers (–6dB [L] to +6dB [R], 0.5dB increments).

■ LEVEL

You can vary the level of each speaker as follows. Be sure to set “TEST TONE” to “ON” for easy adjustment. The default adjustments are in parentheses.

FRONT (0dB)	Adjust the level of the front speakers (–6dB to 0dB, 0.5 dB increments).
CENTER (0dB)	Adjust the level of the centre speaker (–12dB to 0dB, 0.5dB increments).
REAR (0dB)	Adjust the level of the rear speakers (–12dB to 0dB, 0.5dB increments).
SUBWOOFER (0dB)	Adjust the level of the subwoofer (–10dB to +10dB, 0.5dB increments).

To adjust the volume of all the speakers at one time

Use the amplifier's (receiver's) volume control.

■ TEST TONE

The speakers will emit a test tone. Use this when you use the 5.1CH OUTPUT jacks and adjust the "BALANCE" and "LEVEL."

OFF	The test tone is not emitted from the speakers.
ON	The test tone is emitted from each speaker in sequence while adjusting balance or level. When you select one of the "SPEAKER SETUP" items, the test tone is emitted from both left and right speakers simultaneously.

Adjusting the speaker volume and level

- 1 Select "SPEAKER SETUP" in the Setup Display.

- 2 Select "TEST TONE" and set to "ON."
You will hear the test tone from each speaker in sequence.

- 3 From your listening position, select "BALANCE" or "LEVEL" and adjust the value of "BALANCE" using ←/→ and "LEVEL" using ↑/↓.
The test tone is emitted from both left and right speakers simultaneously.

- 4 Select "TEST TONE" and set to "OFF" to turn off the test tone.

Notes

- When you adjust the speaker settings, the sound cuts off for a moment.
- The test tone signals are not output from the digital jack.

Troubleshooting

If you experience any of the following difficulties while using the player, use this troubleshooting guide to help remedy the problem before requesting repairs. Should any problem persist, consult your nearest Sony dealer.

Power

The power is not turned on.

- ➔ Check that the AC power cord (mains lead) is connected securely.

Picture

There is no picture.

- ➔ The connecting cords are not connected securely.
- ➔ The connecting cords are damaged.
- ➔ The player is not connected to the correct TV input jack (page 19).
- ➔ The video input on the TV is not correctly set.

Picture noise appears.

- ➔ The disc is dirty or flawed.
- ➔ If the picture output from your player goes through your VCR to get to your TV, the copy-protection signal applied to some DVD programmes could affect picture quality. If you still experience problems even when you connect your player directly to your TV, please try connecting your player to your TV's S video input (page 19).
- ➔ If the colour system of your player does not match with that of your TV, change the colour system of the player. For details, see page 76. (You cannot change the colour system of the DVD disc itself.)

Even though you set the aspect ratio in "TV TYPE" or "SCREEN SETUP," the picture does not fill the screen.

- ➔ The aspect ratio of the disc is fixed on your DVD.

Sound

There is no sound.

- ➔ The connecting cord is not connected securely.
- ➔ The connecting cord is damaged.
- ➔ The player is connected to the wrong input jack on the amplifier (receiver) (page 23, 25, 26).
- ➔ The amplifier (receiver) input is not correctly set.
- ➔ The player is in pause mode or in Slow-motion Play mode.
- ➔ The player is in fast forward or fast reverse mode.
- ➔ If the audio signal does not come through the DIGITAL OUT (OPTICAL or COAXIAL) jack, check the audio settings (page 80).
- ➔ SACD audio signals are not output from the digital jack.
- ➔ While playing a Super VCD on which the audio track 2 is not recorded, no sound will come out when you select "2:STEREO," "2:1/L," or "2:2/R."

Sound is noisy.

- ➔ The disc is dirty or flawed.

Sound distortion occurs.

- ➔ Set "AUDIO ATT" in "AUDIO SETUP" to "ON" (page 79).

The surround effect is difficult to hear when you are playing a Dolby Digital, DTS, or MPEG audio sound track.

- ➔ Check the speaker connections and setting (page 23, 28, 80)

- ➔ Depending on the DVD, the output signal may not be the entire 5.1 channels. It may be monaural or stereo even if the sound track is recorded in Dolby Digital, DTS, or MPEG audio format.

The sound comes from the centre speaker only.

- ➔ Depending on the disc, the sound may come from the centre speaker only.
- ➔ Set "SURROUND" to "OFF" in the Control Menu display (page 56).

Operation

The remote does not function.

- ➔ There are obstacles between the remote and the player.
- ➔ The distance between the remote and the player is too far.
- ➔ The remote is not pointed at the remote sensor on the player.
- ➔ The batteries in the remote are weak.

The disc does not play.

- ➔ There is no disc inside.
- ➔ The disc is turned over.
Insert the disc with the playback side facing down on the disc tray.
- ➔ The disc is skewed.
- ➔ The player cannot play CD-ROMs, etc. (page 6).
- ➔ The region code on the DVD does not match the player.
- ➔ Moisture has condensed inside the player.
Remove the disc and leave the player turned on for about half an hour. Turn on the power again before playing the disc (page 3).
- ➔ The player cannot play DVD-Rs, DVD-RWs, CD-Rs, or CD-RWs that are not finalized.

The disc does not start playing from the beginning.

- ➔ Programme Play, Shuffle Play, Repeat Play, or A-B Repeat Play has been selected (page 39).
Press CLEAR to cancel these functions before playing a disc.
- ➔ Resume Play has been selected.
During stop, press ■ on the player or the remote and then start playback (page 34).
- ➔ Depending upon the disc, the menu may automatically appear on the screen.

The player starts playing the disc automatically.

- ➔ The disc features an auto playback function.
- ➔ "AUTO PLAY" in "CUSTOM SETUP" is set to "TIMER" (page 78).

Playback stops automatically.

- ➔ Some discs may contain an auto pause signal.
While playing such a disc, the player stops playback at the auto pause signal.

You cannot perform some functions such as Stop, Search, Slow-motion Play, Repeat Play, Shuffle Play, or Programme Play.

- ➔ Depending on the disc, you may not be able to do some of the operations above. See the operating manual that comes with the disc.

The language for the sound track cannot be changed.

- ➔ Try using the DVD's menu instead of the direct selection buttons on the remote (page 35).
- ➔ Multilingual tracks are not recorded on the DVD being played.
- ➔ The DVD prohibits the changing of the language for the sound track.

The subtitle language cannot be changed.

- ➔ Try using the DVD's menu instead of the direct selection buttons on the remote (page 35).
- ➔ Multilingual subtitles are not recorded on the DVD being played.
- ➔ The DVD prohibits the changing of the subtitles.

The subtitle cannot be turned off.

- ➔ Try using the DVD's menu instead of the direct selection buttons on the remote (page 35).
- ➔ The DVD prohibits the subtitles being turned off.

The angles cannot be changed.

- ➔ Try using the DVD's menu instead of the direct selection buttons on the remote (page 35).
- ➔ Multi-angles are not recorded on the DVD being played. The angle can only be changed when the "ANGLE" indicator lights up on the front panel display (page 9).
- ➔ The DVD prohibits changing of the angles.

The player does not operate properly.

- ➔ When static electricity, etc., causes the player to operate abnormally, press POWER on the player to turn the player off and then on again.

Nothing is displayed on the front panel display.

- ➔ "DIMMER" in "CUSTOM SETUP" is set to "OFF." Set "DIMMER" to "BRIGHT" or "DARK" (page 78).

5 numbers or letters are displayed on the screen and on the front panel display.

- ➔ The self-diagnosis function was activated. (See the table on page 89.)

The disc tray does not open and "LOCKED" appears on the front panel display.

- ➔ Contact your Sony dealer or local authorized Sony service facility.
-

Self-diagnosis Function

(When letters/numbers appear in the display)

When the self-diagnosis function is activated to prevent the player from malfunctioning, a five-character service number (e.g., C 13 00) with a combination of a letter and four digits appears on the screen and the front panel display. In this case, check the following table.

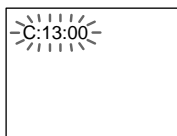

First three characters of the service number	Cause and/or corrective action
C 13	The disc is dirty. ➔ Clean the disc with a soft cloth (page 7).
C 31	The disc is not inserted correctly. ➔ Re-insert the disc correctly.
E XX (xx is a number)	To prevent a malfunction, the player has performed the self-diagnosis function. ➔ Contact your nearest Sony dealer or local authorized Sony service facility and give the 5-character service number. Example: E 61 10

Glossary

Chapter (page 9)

Sections of a picture or a music feature that are smaller than titles. A title is composed of several chapters. Depending on the disc, no chapters may be recorded.

Digital Cinema Sound (DCS) (page 58)

Technology that Sony developed to enjoy surround in a home using 4 or more speakers. It simulates the sound of a movie editing studio instead of the usual concert hall so that you can enjoy the surround sound of a movie theatre in the comfort of your own home.

Dolby Digital (page 23, 80)

Digital audio compression technology developed by Dolby Laboratories. This technology conforms to 5.1-channel surround sound. The rear channel is stereo and there is a discrete subwoofer channel in this format. Dolby Digital provides the same 5.1 discrete channels of high quality digital audio found in Dolby Digital cinema audio systems. Good channel separation is realized because all of the channel data are recorded discretely and little deterioration is realized because all channel data processing is digital.

Dolby Surround (Pro Logic) (page 26)

Audio signal processing technology that Dolby Laboratories developed for surround sound. When the input signal contains a surround component, the Pro Logic process outputs the front, centre and rear signals. The rear channel is monaural.

DTS (page 23, 80)

Digital audio compression technology that Digital Theater Systems, Inc. developed. This technology conforms to 5.1-channel surround sound. The rear channel is stereo and there is a discrete subwoofer channel in this format. DTS provides the same 5.1 discrete channels of high quality digital audio.

Good channel separation is realized because all of the channel data is recorded discretely and little deterioration is realized because all channel data processing is digital.

DVD VIDEO (page 6)

A disc that contains up to 8 hours of moving pictures even though its diameter is the same as a CD.

The data capacity of a single-layer and single-sided DVD is 4.7 GB (Giga Byte), which is 7 times that of a CD. The data capacity of a double-layer and single-sided DVD is 8.5 GB, a single-layer and double-sided DVD is 9.4 GB, and double-layer and double-sided DVD is 17GB.

The picture data uses the MPEG 2 format, one of the worldwide standards of digital compression technology. The picture data is compressed to about 1/40 (average) of its original size. The DVD also uses a variable rate coding technology that changes the data to be allocated according to the status of the picture. Audio information is recorded in a multi-channel format, such as Dolby Digital, allowing you to enjoy a more real audio presence.

Furthermore, various advanced functions such as the multi-angle, multilingual, and Parental Control functions are provided with the DVD.

DVD-RW (page 6)

A DVD-RW is a recordable and rewritable disc with the same size as the DVD VIDEO. The DVD-RW can be recorded in two different modes: VR mode and Video mode. VR (Video Recording) mode enables various programming and editing functions, some of which are limited in the case of Video mode.

Video mode complies with DVD VIDEO format and is compatible with DVD players while a DVD-RW recorded in VR mode can only be played on DVD-RW compliant players. The "DVD-RW" appears in this manual or the on-screen display refers to DVD-RWs in VR mode.

Index (SACD/CD)/Video Index (VIDEO CD) (page 9)

A number that divides a track into sections to easily locate the point you want on an SACD/CD or VIDEO CD. Depending on the disc, no index may be recorded.

MPEG audio (page 23, 80)

International standard coding system used to compress audio digital signals authorized by ISO/IEC. MPEG 1 conforms to up to 2-channel stereo. MPEG 2, used on DVDs, conforms to up to 7.1-channel surround.

Parental Control (page 65)

A function of the DVD used to limit playback of the disc according to the age of the user and the limitation level in each country. The limitation varies from disc to disc; when it is activated, or playback is completely prohibited, violent scenes are skipped or replaced with other scenes, etc.

Region Code (page 6)

This system is used to protect the copyrights. A region number is allocated on each DVD player or DVD disc according to the sales region. Each region code is shown on the player as well as on the disc packaging. The player can play the discs that match its region code. The player can also play discs with the  mark. Even when the region code is not shown on the DVD, the region limit may still be activated.

Scene (page 9)

On a VIDEO CD with PBC (playback control) functions, the menu screens, moving pictures and still pictures are divided into sections called "scenes."

Super Audio CD (SACD) (page 6)

An SACD disc can reproduce sounds that are extremely faithful to the original sound by use of DSD (Direct Stream Digital) technology. This technology utilizes a sampling frequency of 2.8224 MHz, which is 64 times that of a conventional CD, and 1-bit quantization that enables the disc to hold 4 times the amount of information that a standard PCM format CD can hold. SACDs are divided into the following types.

- Super Audio CD (single layer disc)
This disc consists of a single HD layer*.
* High density signal layer for the Super Audio CD



- Super Audio CD (dual layer disc)
This disc consists of dual HD layers and is capable of extended play over long periods. Also, as the dual layer disc consists of dual HD layers on one side only, you do not have to turn the disc over during playback.

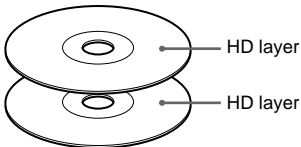

- Super Audio CD + CD (Hybrid disc)
This disc consists of an HD layer and a CD layer. Also, as the dual layers are on one side only, you do not have to turn the disc over during playback. You can play the CD layer using a conventional CD player.

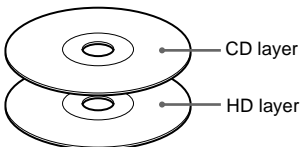

- 2 channel + Multi-channel Super Audio CD
This disc consists of the 2 channel playback area and the multi-channel playback area.

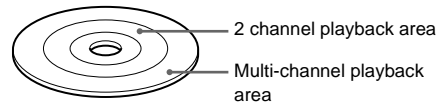

Title (page 9)

The longest section of a picture or music feature on a DVD, movie, etc., in video software, or the entire album in audio software.

Track (page 9)

Sections of a picture or a music feature on an SACD/CD or VIDEO CD (the length of a song).

TV Virtual Surround (TVS) (page 56)

Technology from Sony developed to produce surround sound for home use using just a stereo TV. Designed to work with the sound characteristics of your TV, this technology brings the excitement of surround sound to your home using nothing more than your stereo TV's internal speakers. Furthermore, various TVS modes are available. For example, "TVS WIDE" uses just two speakers to create a virtual sound environment that makes you feel like you are surrounded by multiple speakers.

Specifications

System

Laser	Semiconductor laser
Signal format system	NTSC/PAL (See page 76 to switch)

Audio characteristics

Frequency response	DVD (PCM 96 kHz): 2 Hz to 44 kHz ($-2 \text{ dB} \pm 2 \text{ dB}$ at 44 kHz) SACD: 2 Hz to 100 kHz ($-3 \text{ dB} \pm 2 \text{ dB}$ at 50 kHz) CD: 2 Hz to 20 kHz ($\pm 0.5 \text{ dB}$)
Signal-to-noise ratio (S/N ratio)	115 dB (DVD VIDEO) (LINE OUT L/R (AUDIO) 1/2 jacks only)
Harmonic distortion	0.0025 %
Dynamic range	DVD VIDEO/SACD: 103 dB CD: 99 dB
Wow and flutter	Less than detected value ($\pm 0.001\%$ W PEAK)

Outputs

Jack name	Jack type	Output level	Load impedance
LINE OUT L/R (AUDIO) (1, 2)	Phono jack	2 Vrms (at 50 kilohms)	Over 10 kilohms
DIGITAL OUT (OPTICAL)	Optical output jack	-18 dBm	Wave length: 660 nm
DIGITAL OUT (COAXIAL)	Phono jack	0.5 Vp-p	75 ohms terminated
5.1CH OUTPUT	Phono jack	2 Vrms (50 kilohms)	Over 10 kilohms
LINE OUT (VIDEO) (1, 2)	Phono jack	1.0 Vp-p	75 ohms, sync negative
S VIDEO OUT (1, 2)	4-pin mini DIN	Y: 1.0 Vp-p C: 0.3 Vp-p (PAL) 0.286 Vp-p (NTSC)	75 ohms, sync negative 75 ohms terminated
COMPONENT VIDEO OUT (Y,Cb,Cr)	Phono jack	Y: 1.0 Vp-p Cb, Cr: 0.7 Vp-p	75 ohms, sync negative 75 ohms terminated

General

Power requirements	220 to 240 V AC, 50/60 Hz 220 V AC, 50/60 Hz 220 V AC, 60 Hz 110 V AC, 60 Hz See page 2 for further information.
Power consumption	15 W
Dimensions (approx.)	430 × 74 × 256 mm (w/h/d) incl. projecting parts
Mass (approx.)	2.8 kg
Operating temperature	5 °C to 35 °C
Operating humidity	25 % to 80 %

Supplied accessories

See page 15.

Specifications and design are subject to change without notice.

Language Code List

For details, see pages 54, 61, 75.

The language spellings conform to the ISO 639: 1988 (E/F) standard.

Code Language	Code Language	Code Language	Code Language
1027 Afar	1183 Irish	1347 Maori	1507 Samoan
1028 Abkhazian	1186 Scots Gaelic	1349 Macedonian	1508 Shona
1032 Afrikaans	1194 Galician	1350 Malayalam	1509 Somali
1039 Amharic	1196 Guarani	1352 Mongolian	1511 Albanian
1044 Arabic	1203 Gujarati	1353 Moldavian	1512 Serbian
1045 Assamese	1209 Hausa	1356 Marathi	1513 Siswati
1051 Aymara	1217 Hindi	1357 Malay	1514 Sesotho
1052 Azerbaijani	1226 Croatian	1358 Maltese	1515 Sundanese
1053 Bashkir	1229 Hungarian	1363 Burmese	1516 Swedish
1057 Byelorussian	1233 Armenian	1365 Nauru	1517 Swahili
1059 Bulgarian	1235 Interlingua	1369 Nepali	1521 Tamil
1060 Bihari	1239 Interlingue	1376 Dutch	1525 Telugu
1061 Bislama	1245 Inupiak	1379 Norwegian	1527 Tajik
1066 Bengali; Bangla	1248 Indonesian	1393 Occitan	1528 Thai
1067 Tibetan	1253 Icelandic	1403 (Afan)Oromo	1529 Tigrinya
1070 Breton	1254 Italian	1408 Oriya	1531 Turkmen
1079 Catalan	1257 Hebrew	1417 Punjabi	1532 Tagalog
1093 Corsican	1261 Japanese	1428 Polish	1534 Setswana
1097 Czech	1269 Yiddish	1435 Pashto; Pushto	1535 Tonga
1103 Welsh	1283 Javanese	1436 Portuguese	1538 Turkish
1105 Danish	1287 Georgian	1463 Quechua	1539 Tsonga
1109 German	1297 Kazakh	1481 Rhaeto- Romance	1540 Tatar
1130 Bhutani	1298 Greenlandic	1482 Kirundi	1543 Twi
1142 Greek	1299 Cambodian	1483 Romanian	1557 Ukrainian
1144 English	1300 Kannada	1489 Russian	1564 Urdu
1145 Esperanto	1301 Korean	1491 Kinyarwanda	1572 Uzbek
1149 Spanish	1305 Kashmiri	1495 Sanskrit	1581 Vietnamese
1150 Estonian	1307 Kurdish	1498 Sindhi	1587 Volapük
1151 Basque	1311 Kirghiz	1498 Sindhi	1613 Wolof
1157 Persian	1313 Latin	1501 Sangho	1632 Xhosa
1165 Finnish	1326 Lingala	1502 Serbo-Croatian	1665 Yoruba
1166 Fiji	1327 Laothian	1503 Singhalese	1684 Chinese
1171 Faroese	1332 Lithuanian	1505 Slovak	1697 Zulu
1174 French	1334 Latvian; Lettish	1506 Slovenian	
1181 Frisian	1345 Malagasy		
			1703 Not specified

List of Setup Display Items

The default settings are underlined.



LANGUAGE SETUP (page 75)

<p>OSD (The available languages differ depending upon the player model.)</p>	<p><u>ENGLISH</u> CHINESE1 CHINESE2</p>	<p><u>ENGLISH</u> FRANÇAIS DEUTSCH ITALIANO ESPAÑOL NEDERLANDS DANSK SVENSKA SUOMI NORSK PORTUGUÊS РУССКИЙ OTHERS →</p>
<p>MENU (The available languages differ depending upon the player model.)</p>	<p><u>ENGLISH</u> CHINESE JAPANESE FRENCH GERMAN ITALIAN SPANISH DUTCH DANISH SWEDISH FINNISH NORWEGIAN PORTUGUESE RUSSIAN OTHERS →</p>	<p><u>ENGLISH</u> FRANÇAIS DEUTSCH ITALIANO ESPAÑOL NEDERLANDS DANSK SVENSKA SUOMI NORSK PORTUGUÊS РУССКИЙ CHINESE JAPANESE OTHERS →</p>
<p>AUDIO</p>	<p><u>ORIGINAL</u> (All other selections are the same as the “MENU” language.)</p>	
<p>SUBTITLE</p>	<p><u>AUDIO FOLLOW</u> (All other selections are the same as the “MENU” language.)</p>	

**SCREEN SETUP (page 76)**

TV TYPE	<u>16:9</u> 4:3 LETTER BOX 4:3 PAN SCAN
COLOR SYSTEM	<u>AUTO</u> PAL NTSC
SCREEN SAVER	<u>ON</u> OFF
BACKGROUND	<u>JACKET PICTURE</u> GRAPHICS BLUE BLACK

**CUSTOM SETUP (page 78)**

AUTO PLAY	<u>OFF</u> TIMER DEMO1 DEMO2
DIMMER	<u>BRIGHT</u> DARK OFF
PAUSE MODE	<u>AUTO</u> FRAME
PLAYBACK MEMORY	<u>ON</u> OFF
TRACK SELECTION	<u>OFF</u> AUTO
CD DIRECT	<u>OFF</u> ON

**AUDIO SETUP (page 79)**

AUDIO ATT	<u>OFF</u> ON		
AUDIO DRC	<u>STANDARD</u> TV MODE WIDE RANGE		
AUDIO FILTER	<u>SHARP</u> SLOW		
DOWNMIX	<u>DOLBY SURROUND</u> NORMAL		
DIGITAL OUT	<u>ON</u>	DOLBY DIGITAL	<u>D-PCM</u> DOLBY DIGITAL
		MPEG	<u>PCM</u> MPEG
		DTS	<u>D-PCM</u> DTS
		48 kHz/96 kHz PCM	<u>48 kHz/16 bit</u> 96 kHz/24 bit
	OFF		

**SPEAKER SETUP (page 82)**

SIZE	FRONT	<u>LARGE</u> SMALL
	CENTER	<u>NONE</u> LARGE SMALL
	REAR	<u>NONE</u> LARGE (REAR) LARGE (SIDE) SMALL (REAR) SMALL (SIDE)
	SUBWOOFER	<u>NONE</u> YES
DISTANCE (The distance from the listening position.)	FRONT	1.0m ~ 15.0m
	CENTER	0m ~ 15.6m (It changes according to the distance from the front speaker.)
	REAR	0m ~ 15.0m (It changes according to the distance from the front speaker.)
BALANCE	FRONT	- 6dB ~ + 6dB
	REAR	- 6dB ~ + 6dB
LEVEL	FRONT	- 6dB ~ 0dB
	CENTER	- 12dB ~ 0dB
	REAR	- 12dB ~ 0dB
	SUBWOOFER	- 10dB ~ + 10dB
TEST TONE	<u>OFF</u> ON	

Index

Numerics

- 16:9 76
- 4:3 LETTER BOX 76
- 4:3 PAN SCAN 76
- 48kHz/96kHz PCM 82
- 5.1 Channel Surround 23

A

- A-B REPEAT 43
- ADVANCED 53
- ANGLE 60
- ANGLE VIEWER 48
- AUDIO 54, 75
- AUDIO ATT 79
- AUDIO DRC 79
- AUDIO FILTER 80
- AUDIO SETUP 79
- AUTO PLAY 78

B

- BACKGROUND 77
- BALANCE 84
- Batteries 15
- BNR 62

C

- CD 33
- CD DIRECT 79
- CHAPTER 47
- Chapter 89
- CHAPTER VIEWER 48
- Click shuttle 46
- COLOR SYSTEM 77
- Colour system
 - adjusting for VIDEO CD 77
 - changing the output signal 77
- Connecting 19
- Continuous play
 - CD/SACD/VIDEO CD 33
 - DVD 33
- Control Menu 12
- CUSTOM 74
- CUSTOM PARENTAL CONTROL 65
- CUSTOM SETUP 78

D

- DCS (Digital Cinema Sound) 58, 89
- DIGITAL OUT 80

- Digital output 80
- DIGITAL VIDEO
 - ENHANCER 64
- DIMMER 78
- Display
 - Control Menu display 12
 - Front panel display 9
 - Setup Display 74
- DISTANCE 84
- DOLBY DIGITAL 26, 56, 81
- DOWNMIX 80
- DTS 23, 26, 56, 81, 90
- DVD 33, 90
- DVD-RW 36, 90

F

- Fast forward 45
- Fast reverse 45
- Front panel display 9

H

- Handling discs 7
- Hooking up 19

I

- INDEX 47
- Index 90

J

- JOG 46
- Jog mode 46

L

- LANGUAGE SETUP 75
- LEVEL 84
- Locating
 - a specific point by watching the TV screen 45

M

- MENU 75
- Menu
 - disc's menu 35
 - top menu 35
- MPEG 23, 56, 81, 90
- MULTI/2CH 37

O

- On-screen display

- Control Menu display 12
 - Setup Display 74
- ORIGINAL 36
- ORIGINAL/PLAY LIST 36
- OSD 94

P

- PARENTAL CONTROL 65
- PAUSE MODE 78
- PBC Playback 38
- PLAY LIST 36
- PLAYBACK MEMORY 78
- PRO LOGIC 26, 80, 89
- PROGRAM 39
- Programme Play 39

Q

- QUICK 75
- Quick Setup 28, 74

R

- Remote 15, 70
- REPEAT 42
- Repeat Play 42
- REPLAY 34
- RESET 75
- Resume Play 34

S

- S VIDEO output 19
- SACD 91
- SCENE 47
- Scene 90
- SCREEN SAVER 77
- SCREEN SETUP 76
- Searching. See Locating.
- SETUP 74
 - Setup Display 74
- SHUFFLE 41
- Shuffle Play 41
- Shuttle mode 46
- SIZE 82
- Slow-motion Play 45
- SPEAKER SETUP 82
- Speakers
 - Hooking 21
- STROBE PLAYBACK 48
- SUBTITLE 61, 75
- SURROUND 56

T

TEST TONE 85

Time search 48

TIME/TEXT 47, 50, 51

TITLE 47

Title 91

TITLE VIEWER 48

Top menu 35

TRACK 47

Track 91

TRACK SELECTION 79

TRACK VIEWER 48

Troubleshooting 86

TV TYPE 76

TVS (TV Virtual Surround)
57, 91

U

Usable discs 6

V

VIDEO CD 33

VIDEO EQUALIZER 63

VIEWER 48

Free Manuals Download Website

<http://myh66.com>

<http://usermanuals.us>

<http://www.somanuals.com>

<http://www.4manuals.cc>

<http://www.manual-lib.com>

<http://www.404manual.com>

<http://www.luxmanual.com>

<http://aubethermostatmanual.com>

Golf course search by state

<http://golfingnear.com>

Email search by domain

<http://emailbydomain.com>

Auto manuals search

<http://auto.somanuals.com>

TV manuals search

<http://tv.somanuals.com>