

4-Line CALLER ID Telephone

Operating Instructions

US

CALLER ID
with call waiting

IT-M804

Owner's Record

The model and the serial numbers are located at the bottom of the unit. Record the serial number in the space provided below. Refer to these numbers whenever you call upon your Sony dealer regarding this product.

Model No. IT-M804

Serial No. _____

IMPORTANT SAFETY INSTRUCTIONS

When using your telephone equipment, basic safety precautions should always be followed to reduce the risk of fire, electric shock and injury to persons, including the following:

1. Read and understand all instructions.
2. Follow all warnings and instructions marked on the product.
3. Unplug this product from the wall outlet before cleaning. Do not use liquid cleaners or aerosol cleaners. Use a damp cloth for cleaning.
4. Do not use this product near water, for example, near a bath tub, wash bowl, kitchen sink, or laundry tub, in a wet basement, or near a swimming pool.
5. Do not place this product on an unstable cart, stand, or table. The product may fall, causing serious damage to the product.
6. Slots and openings in the cabinet and the back or bottom are provided for ventilation. To protect it from overheating, these openings must not be blocked or covered. The openings should never be blocked by placing the product on the bed, sofa, rug, or other similar surface. This product should never be placed near or over a radiator or heat register. This product should not be placed in a built-in installation unless proper ventilation is provided.
7. This product should be operated only from the type of power source indicated on the marking label. If you are not sure of the type of power supply to your home, consult your dealer or local power company.
8. Do not allow anything to rest on the power cord. Do not locate this product where the cord will be abused by persons walking on it.
9. Do not overload wall outlets and extension cords as this can result in the risk of fire or electric shock.
10. Never push objects of any kind into this product through cabinet slots as they may touch dangerous voltage points or short out parts that could result in a risk of fire or electric shock. Never spill liquid of any kind on the product.
11. To reduce the risk of electric shock, do not disassemble this product, but take it to a qualified service personnel when some service or repair work is required. Opening or removing covers may expose you to dangerous voltages or other risks. Incorrect reassembly can cause electric shock when the appliance is subsequently used.
12. Unplug this product from the wall outlet and refer servicing to qualified service personnel under the following conditions:
 - A. When the power cord or plug is damaged or frayed.
 - B. If liquid has been spilled into the product.
 - C. If the product has been exposed to rain or water.
 - D. If the product does not operate normally by following the operating instructions. Adjust only those controls that are covered by the operating instructions because improper adjustment of other controls may result in damage and will often require extensive work by a qualified technician to restore the product to normal operation.
 - E. If the product has been dropped or the cabinet has been damaged.
 - F. If the product exhibits a distinct change in performance.

13. Avoid using a telephone (other than a cordless type) during an electrical storm. There may be a remote risk of electric shock from lightning.
14. Do not use the telephone to report a gas leak in the vicinity of the leak.

SAVE THESE INSTRUCTIONS

CAUTION:

To reduce the risk of fire or injury to persons by battery, read and follow these instructions.

1. Use only the following type and size battery: 6F22/6LR61 9V.
2. Do not dispose of the battery pack in a fire. The cell may explode. Check with local codes for possible special disposal instructions.
3. Do not open or mutilate the battery pack. Released electrolyte is corrosive and may cause damage to the eyes or skin. It may be toxic if swallowed.
4. Exercise care in handling battery pack in order not to short the battery with conducting materials such as rings, bracelets, and keys. The battery or conductor may overheat and cause burns.
5. Do not attempt to recharge the batteries provided with or identified for use with this product. The batteries may leak corrosive electrolyte or explode.
6. Do not attempt to rejuvenate the batteries provided with or identified for use with this product by heating them. Sudden release of the battery electrolyte may occur causing burns or irritation to the eyes or skin.
7. Remove the batteries from this product if the product will not be used for a long period of time (several months or more) since during this time the battery could leak in the product.
8. Discard "dead" batteries as soon as possible since "dead" batteries are more likely to leak in a product.
9. Do not store this product, or the batteries provided with or identified for use with this product, in high-temperature areas. Batteries that are stored in a freezer or refrigerator for the purpose of extending shelf life should be protected from condensation during storage and defrosting. Batteries should be stabilized at room temperature prior to use after cold storage.

INFORMATION FOR GENERAL TELEPHONES

1. This equipment complies with Part 68 of the FCC rules. On the bottom of this equipment is a label that contains, among other information, the FCC registration number and ringer equivalence number (REN) for this equipment. If requested, this information must be provided to the telephone company.
2. The applicable registration jacks (connectors) USOC-RJ11C/RJ14C are used for this equipment.
3. This equipment is designed to be connected to the telephone network or premises wiring using a compatible modular jack which is Part 68 compliant.
The FCC compliant telephone cord and modular plug is provided with this equipment.
4. The REN is used to determine the quantity of devices which may be connected to the telephone line. Excessive RENs on the telephone line may result in the devices not ringing in response to an incoming call. In most, but not all areas, the sum of the RENs should not exceed five (5.0). To be certain of the number of devices that may be connected to a line, as determined by the total RENs, contact the local telephone company.
5. If your equipment (IT-M804) causes harm to the telephone network, the telephone company will notify you in advance that temporary discontinuance of service may be required. But if advance notice isn't practical, the telephone company will notify the customer as soon as possible. Also, you will be advised of your right to file a complaint with the FCC if you believe it is necessary.
6. The telephone company may make changes in its facilities, equipment, operations or procedures that could affect the operation of the equipment. If this happens the telephone company will provide advance notice in order for you to make necessary modifications to maintain uninterrupted service.
7. If trouble is experienced with this equipment (IT-M804), for repair or warranty information, please contact Sony Direct Response Center: Tel 1-800-222-7669. If the equipment is causing harm to the telephone network, the telephone company may request that you disconnect the equipment until the problem is resolved.
8. All repairs will be performed in an authorized Sony service station.
9. This equipment cannot be used to party lines or coin lines.
10. This equipment is hearing aid compatible.

If your telephone is equipped with automatic dialers

When programming emergency numbers and (or) making test calls to emergency numbers:

1. Remain on the line and briefly explain to the dispatcher the reason for the call.
2. Perform such activities in the off-peak hours, such as early morning or late evenings.

Caution

You are cautioned that any changes or modifications not expressly approved in this manual could void your authority to operate this equipment.

Note

This equipment has been tested and found to comply with the limits for a Class B digital device, pursuant to Part 15 of the FCC Rules. These limits are designed to provide reasonable protection against harmful interference in a residential installation. This equipment generates, uses and can radiate radio frequency energy and, if not installed and used in accordance with the instructions, may cause harmful interference to radio communications. However, there is no guarantee that interference will not occur in a particular installation. If this equipment does cause harmful interference to radio or television reception, which can be determined by turning the equipment off and on, the user is encouraged to try to correct the interference by one or more of the following measures:

- Reorient or relocate the receiving antenna.
- Increase the separation between the equipment and receiver.
- Connect the equipment into an outlet on a circuit different from that to which the receiver is connected.
- Consult the dealer or an experienced radio/TV technician for help.

Table of contents

Getting Started

- 8 Read this first
 - 9 Step 1: Checking the package contents
 - 10 Step 2: Setting up the phone
 - 19 Step 3: Entering the area code
 - 22 Step 4: Setting the day and time
 - 24 Step 5: Changing the display language
 - 25 Identifying the parts
 - 27 Lamp indications
-

Basics

- 28 Making calls
 - 31 Redialing
 - 32 Making another call while talking
 - 33 Receiving calls
 - 36 Receiving a call while talking
-

Telephone Features

- 37 One-touch dialing
 - 37 Storing phone numbers and names
 - 39 Changing a stored name and/or phone number
 - 40 Erasing a stored name and phone number
 - 40 Making calls with one-touch dialing
- 41 Phone Directory
 - 41 Storing phone numbers and names

- 43 Changing a stored name and/or phone number
- 44 Erasing a memory location
- 44 Making calls from the Phone Directory
- 46 Setting the security code and enabling/disabling the Phone Directory security
- 47 Changing the security code
- 48 Having a three-way conference call
 - 48 Making another call while talking
 - 49 Receiving a call while talking

Caller ID Features

- 50 Understanding the Caller ID service
 - 50 When you receive a call
- 51 Looking at the Caller ID list
 - 51 Viewing the Caller ID list
 - 52 Saving the phone numbers in the Caller ID list
 - 53 Erasing data from the Caller ID list
- 55 Using the Caller ID list
 - 55 Calling back a number from the Caller ID list
 - 56 Storing a number of the Caller ID list into one-touch dial buttons
 - 57 Storing a number of the Caller ID list into Phone Directory
 - 58 To change the number of digits of the phone number

-
- 60 Using “Caller ID with call waiting” service
 - 61 Using visual message waiting service

Intercom Operation

- 63 Talking between the phones (Intercom)
- 65 Voice paging (PAGE)
- 66 Paging all phones (ALL PAGE)
- 67 Having an intercom conference call
- 68 Transferring a call
 - 69 To transfer during an intercom call
 - 69 To transfer during a page
 - 69 To transfer during an all page

Additional Information

- 70 Mounting the phone on a wall
- 71 Using the phone during a power failure
- 72 Maintenance
- 73 Troubleshooting
- 76 Specifications
- 77 Index

Back cover LIMITED WARRANTY

Read this first

Before you use your phone, you must first set it up. Here's a quick way to set up your phone: Steps 1, 2 and 3.

Step 1 (page 9)

First, unpack the phone and the supplied accessories.



Step 2 (pages 10 to 18)

Next, you need to do four things to set up the phone, including finding the best location for the phone.

Step 3 (pages 19 to 21)

Finally, enter the area code to use the Caller ID service.

That's it!

For the date and time setting, follow the procedure in “Step 4 Setting the day and time” on page 22.

For changing the display language, follow the procedure in “Step 5 Changing the display language” on page 24.

Step 1

Checking the package contents

Make sure you have received the following items in the package. If anything is missing, contact your local Sony dealer.

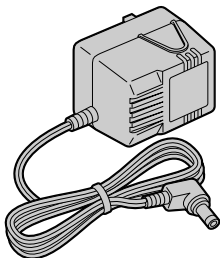

AC power adaptor (AC-T71)

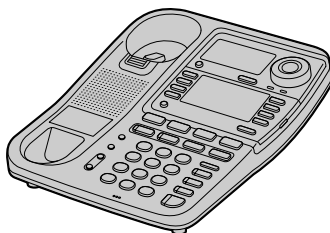

Phone

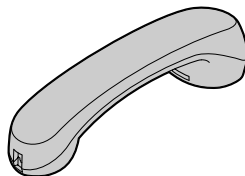

Handset

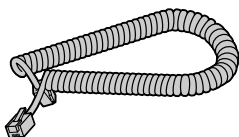

Handset cord

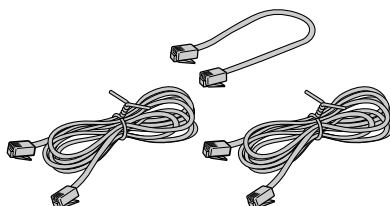

Telephone line cords (3)

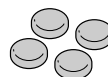

Pads (4)

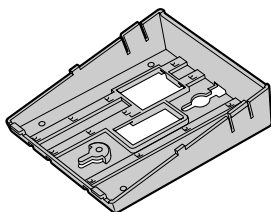

Wall bracket/stand for phone

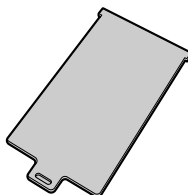

Quick sheet



Assignment of using line sticker

Step 2

Setting up the phone

Do the following steps:

- Connect the phone
- Assigning station number
- Choose the dialing mode
- Enabling/disabling the line

Note on installation

Install the unit:

- on a level surface
- away from heat sources, such as radiators, airducts, and sunlight
- away from excessive moisture, extremely low temperatures, dust, mechanical vibration, or shock

Connect the phone

You can connect a maximum of 16 phones (IT-M804 or IT-M704) to use your phone as an intercom phone, in addition to using as the 4-line telephone.

To use the intercom features, you must connect all phones (IT-M804 or IT-M704) to the LINE 1 jack correctly.

If you set the dialing mode, area codes and date and time on this phone after connecting other phones, these settings will be set automatically to every phone. Moreover, the Caller ID data can be viewed on every connected phone.

If you want to hang the phone on the wall, mount the phone first (see page 70).

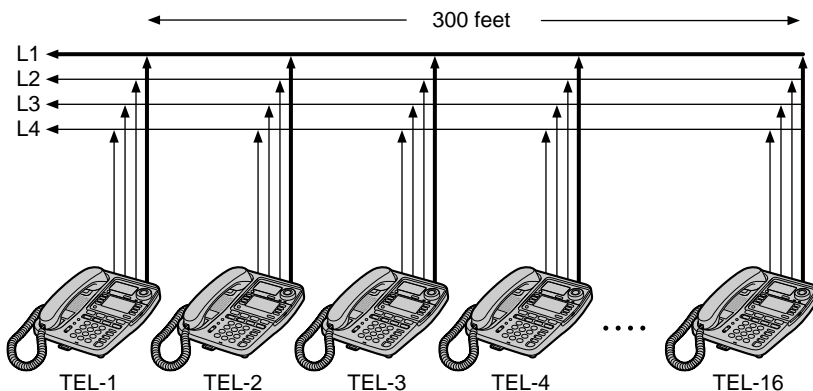

Note

If the each line is not connected correctly, you cannot use the functions of this phone.

The connection method differs according to the conditions of indoor wiring.

[Wiring 1]

Conduct connections follow the procedure in "To connect the phone to two outlets having two lines" on page 12.

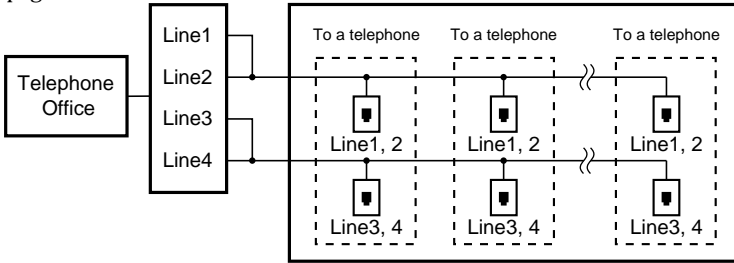

[Wiring 2]

Conduct connections follow the procedure in "To connect the phone to four separate outlets" on page 13.

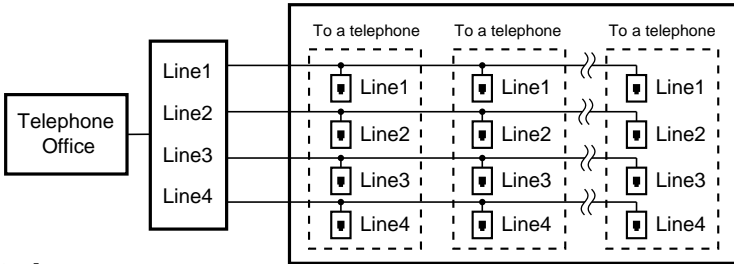

[Wiring 3, 4]

When there is only one outlet for one telephone, wiring work is necessary.

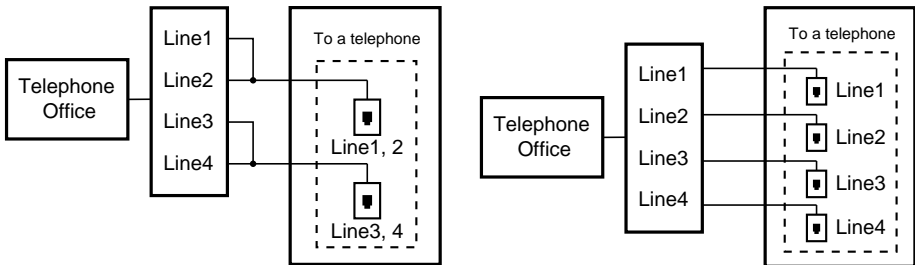

To connect the handset

Connect one end of the handset cord to the handset and the other end to the HANDSET jack on the phone.

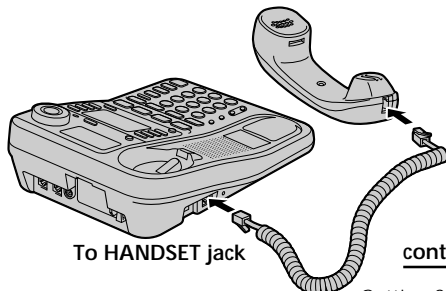

continued

Step 2: Setting up the phone (continued)

To connect the phone to two outlets having two lines

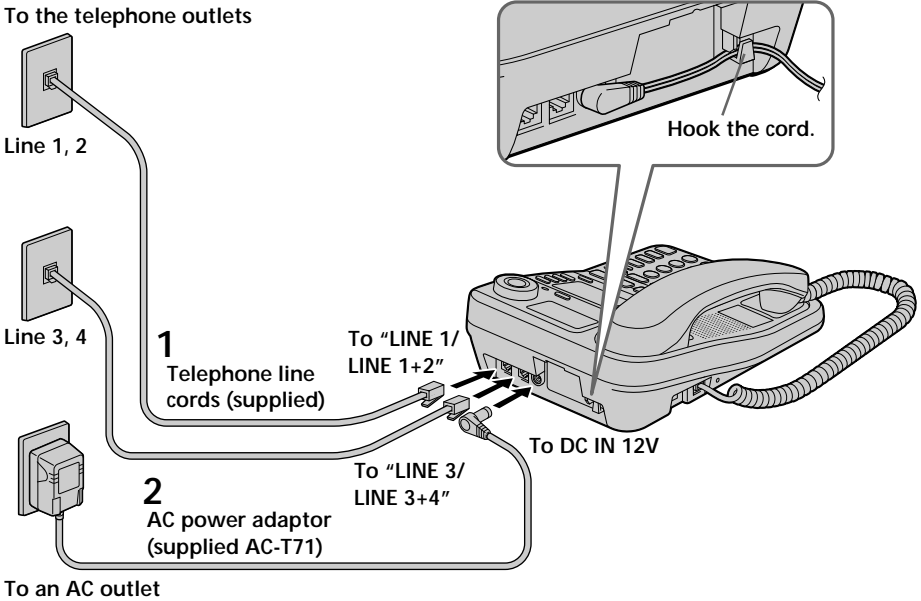

- 1 Connect the telephone line cords to the "LINE 1 / LINE 1+2" and "LINE 3 / LINE 3+4" jacks and to the telephone outlets.
- 2 Connect the AC power adaptor to the DC IN 12V jack and to an AC outlet.

Tips

- If your telephone outlet is not modular, contact your telephone service company for assistance.
- L1 is the first phone line connected to center pair of wires. L2 is the second phone line connected to outer pair of wires.

Modular

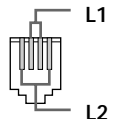

To connect the phone to four separate outlets

If you have single line outlet, you need two Two-Line adaptors (not supplied) to connect the phone to the four separate outlets.

To the telephone outlets

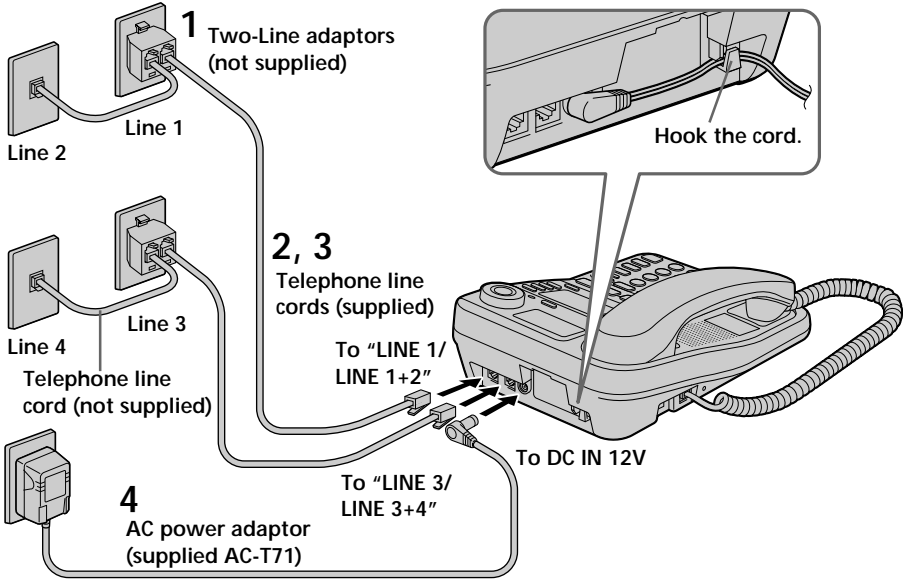

To an AC outlet

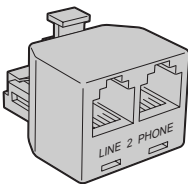

Two-Line adaptor

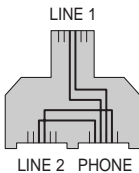

Two-Line adaptor interconnection

- 1** Connect the Two-Line adaptors to the line 1 and line 3 outlets.
- 2** Connect the telephone line cords to the "LINE 1/LINE 1+2" and "LINE 3/LINE 3+4" jacks and to the Two-Line adaptors.
- 3** Connect the telephone line cords to the Two-Line adaptors and to the line 2 and line 4 outlets.
- 4** Connect the AC power adaptor to the DC IN 12V jack and to an AC outlet.

Note

The Duplex Jack adaptor cannot be used as the adaptor, which is used in step 1.

continued

Step 2: Setting up the phone (continued)

Notes

- Conduct connections instructed on page 12 or 13 first, when inserting battery for backup (not supplied) in case for a power failure. If “POWER FAILURE” appears on the display instead of “NO AREA CODE” when you connect the AC power adaptor to an AC outlet for the first time, remove the battery from the phone and unplug the AC power adaptor, then plug it into an AC outlet.
- Use only the supplied AC-T71 AC power adaptor. Do not use any other AC power adaptor.
- Connect the AC power adaptor to a continuous power supply.
- Place the phone close to the AC outlet so that you can unplug the AC power adaptor easily.

Polarity of the plug



Tips

- Phones other than the IT-M804 and IT-M704 phones cannot be connected to LINE 1 jack.
- Connection and utilization of Private Branch Exchange (PBX) is not possible.

Connecting a computer or FAX

You can connect a computer or FAX, etc. to the DATA jack.

For the line to be used for data communication, select L2, L3 or L4 using the DATA LINE SELECT switch.

Notes

- “LINE 2”, “LINE 3” or “LINE 4” is used for receiving or sending computer or FAX data in addition to making or receiving calls.
If a call comes in on the line selected with the “call waiting” service while a computer or FAX connected to the DATA jack is receiving or sending data, that data may be effected.
If you have data communication frequently, we recommend that you and your callers use the line selected for data communication only.
- Connection to ADSL devices is not possible.
- Noise may occasionally be heard on other lines during data communication depending on the condition of the indoor wiring.

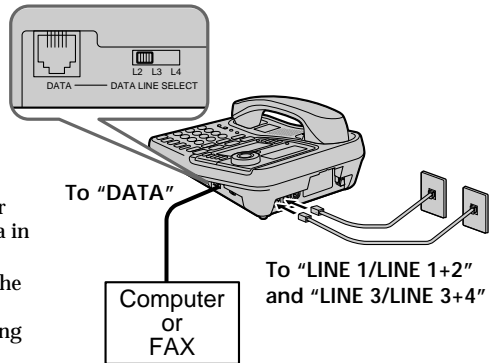

To attach the quick sheet

Attach the supplied quick sheet on the bottom of the phone.

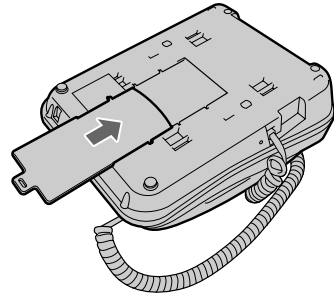

To attach assignment of using line sticker

Attach the supplied assignment of using line sticker under the speaker of the phone.

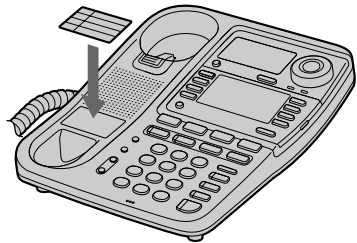

To tilt the phone

If you want to tilt the phone, attach the supplied wall bracket on the bottom of the phone.

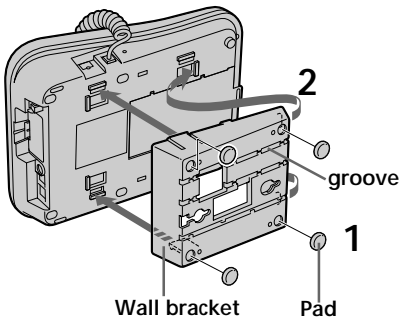

- 1** Put the four pads into the hollows of the wall bracket.
- 2** Attach the wall bracket to the telephone.
- 3** Connect the telephone line cords and AC power adaptor by following the procedure on page 12 or 13.

continued

Step 2: Setting up the phone (continued)

Assigning station number

Ensure to connect all phones (IT-M804 or IT-M704) to LINE 1 jack correctly, and then assign the station number to all phones. To confirm the assigned station number is set correctly, make an intercom call one another. See “Talking between the phones” on page 63.

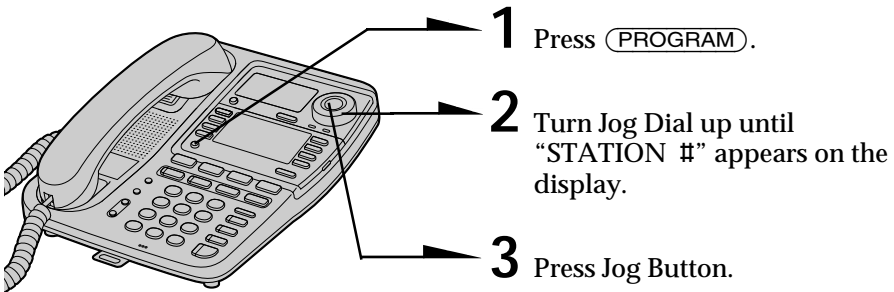

1 Press **PROGRAM**.

2 Turn Jog Dial up until “STATION #” appears on the display.

3 Press Jog Button.

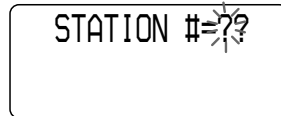

4 Enter the two digits station number (01 to 16) by pressing the dialing keys.

5 Press Jog Button.
You will hear a long confirmation beep.

Note

If the number already used for other phone or a number except for 01 to 16 is entered in step 4, “INVALID NUMBER” will be displayed. Enter the different number.

Tip

You can press **PROGRAM** instead of Jog Button in the procedure above.

Choose the dialing mode

For the telephone to work properly, select an appropriate dialing mode (tone or pulse).

When other phones (IT-M804 or IT-M704) are connected to the LINE 1 jack, the same dialing mode is automatically set to all the phones. Be sure to connect the phones beforehand, and set the dialing mode.

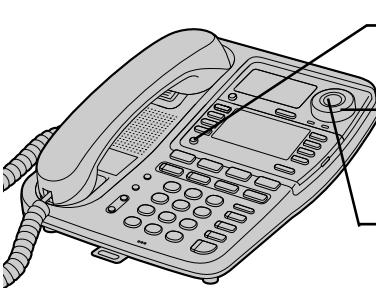

- 1 Press **PROGRAM**.
- 2 Turn Jog Dial up until “DIAL MODE” appears on the display.
- 3 Press Jog Button.

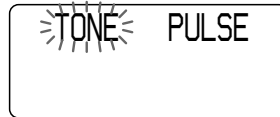

- 4 Turn Jog Dial to choose the dialing mode (“TONE” or “PULSE”), and then press Jog Button.

You will hear a long confirmation beep.

Notes

- Do not allow more than 20 seconds to elapse between each step of the procedure.
- The dialing mode cannot be set for every line.

Tip

You can press **PROGRAM** instead of Jog Button in the procedure above.

If you aren't sure of your dialing system

Make a trial call with the dialing mode set to “TONE”.

If the call connects, leave the setting as is; otherwise, set to “PULSE”.

continued

Step 2: Setting up the phone (continued)

Enabling/disabling the line

When you may not use all four lines, you need to disable the unused line for the telephone to work properly.

This setting can be set up at each phone separately.

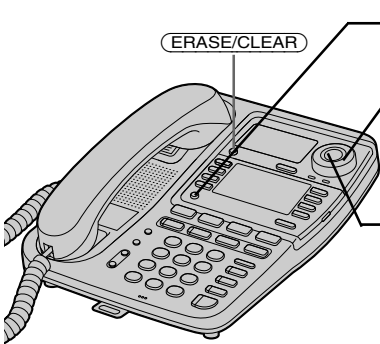

- 1 Press **(PROGRAM)**.
- 2 Turn Jog Dial up until “DISABLE LINE” appears on the display.
- 3 Press Jog Button.



- 4 Turn Jog Dial to choose the line you want to change, and then press Jog Button.



- 5 Turn Jog Dial to choose “ENABLE” or “DISABLE”, and then press Jog Button.

You will hear a long confirmation beep and the line next to the selected line will flash on the display.

Repeat steps 4 and 5 for other line setting, if necessary.

To end the setting, press **(ERASE/CLEAR)**.

Note

You cannot disable the line 1.

Tip

You can press **(PROGRAM)** instead of Jog Button in the procedure above.

Step 3

Entering the area code

When you use this phone for the first time, or move to an area that has a different area code, you must enter your home area code. Otherwise, you cannot use some functions of this phone and the Caller ID functions.

This is also necessary because the phone must be able to select an area code to properly dial call from the Caller ID list.

Depending on your region, enter 3-digit area code as follows:

Case 1.

If 7-digit dialing (no area code) is accepted for local calls in your area, see "To enter your home area code" below.

If you live in an area where calls from or to other local areas can also be made by 10-digit dialing (area code + number), you can register up to 5 local area codes with this telephone to take advantage of this system. See "To enter the local area code (For 10 digits phone number users)" on page 20.

Case 2.

If 10-digit dialing (area code + number) is required for all local calls in your area, at first, enter "000" in your home area code. See "To enter your home area code" below. Then see "To enter the local area code (For 10 digits phone number users)" on page 20.

When other phones (IT-M804 or IT-M704) are connected to the LINE 1 jack, the same home area code and local area codes are automatically set to all the phones. Be sure to connect the phones beforehand, and enter the area code.

When you connect the AC power adaptor to an AC outlet for the first time, the following display appears for about 20 seconds.

To erase the home area code, return the phone to the factory setting (see page 75).



NO AREA CODE

To enter your home area code

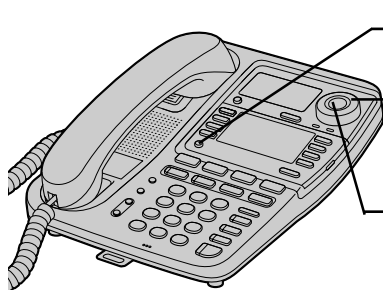

1 Press **PROGRAM**.

2 Turn Jog Dial up until "AREA CODE" appears on the display.

3 Press Jog Button.



HOME LOCAL

continued

Step 3: Entering the area code (continued)

4 Press Jog Button again.

AREA CODE=???

5 Enter three digits of your home area code by pressing the dialing keys.

6 Press Jog Button.
You will hear a long confirmation beep.

Notes

- Do not allow more than 20 seconds to elapse between each step of the procedure.
- If the home area code has not been entered, storing the caller ID data into one-touch dial buttons or Phone Directory cannot be performed. You will hear five short error beeps and the storing will be canceled.

Tip

You can press **PROGRAM** instead of Jog Button in the procedure above.

To change the home area code

- 1** Display the home area code by doing steps from 1 to 4 on pages 19 to 20.
The current home area code appears on the display.
- 2** Enter a new home area code by pressing the dialing keys.
- 3** Press Jog Button.
You will hear a long confirmation beep.

Tip

You can also correct a digit in step 2. Turn Jog Dial until the digit to be corrected flashes and enter a digit by pressing the dialing keys.

To enter the local area code (For 10 digits phone numbers users)

If a call matches one of the local area codes you entered, the phone number will be registered with 10 digits in the Caller ID list (area code + number). If a call does not match one of the local area codes you entered, the phone number will be registered with 11 digits in the Caller ID list (1 + area code + number). Some regions of the country allow you to have more than one local area code. (Up to five local area codes can be entered in this phone.)

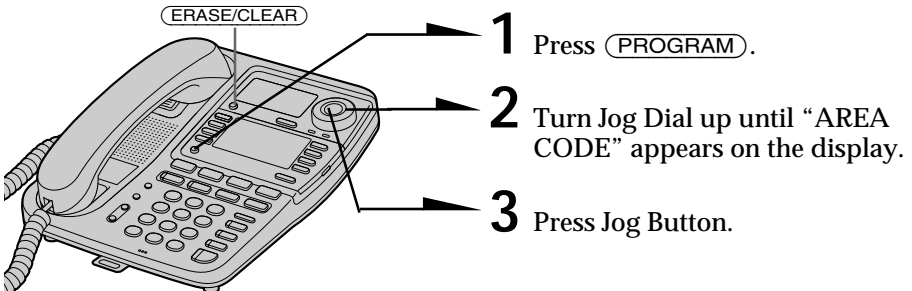

- 4** Turn Jog Dial up to make “LOCAL” flash, and then press Jog Button.

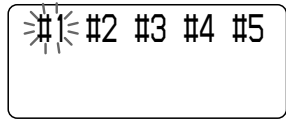

- 5** Select the number (“#1” to “#5”) to enter the local area code by turning Jog Dial, and then press Jog Button.

- 6** Enter three digits of the local area code by pressing the dialing keys.

- 7** Press Jog Button.
The number next to the selected number will flash and you will hear a long confirmation beep.

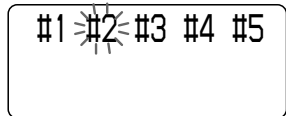

Repeat steps 5 to 7 to enter a local area code into another number, if necessary.

To end the setting, press **(ERASE/CLEAR)**.

Note

Do not allow more than 20 seconds to elapse between each step of the procedure.

Tip

You can press **(PROGRAM)** instead of Jog Button in the procedure above.

To change the local area code

- 1** Display the local area code you want to change by doing steps from 1 to 5 on pages 20 to 21.

The current local area code appears on the display.

- 2** Enter a new local area code by pressing the dialing keys.

- 3** Press Jog Button.

You will hear a long confirmation beep.

Tip

You can also correct a digit in step 2. Turn Jog Dial until the digit to be corrected flashes and enter a digit by pressing the dialing keys.

To erase the local area code

- 1** Display the local area code you want to erase by doing steps from 1 to 5 on pages 20 to 21.

The current local area code appears on the display.

- 2** Press **(ERASE/CLEAR)**.

- 3** Turn Jog Dial to choose “YES”, and then press Jog Button.

You will hear a long confirmation beep and the local area code is erased.

Step 4

Setting the day and time

When other phones (IT-M804 or IT-M704) are connected to the LINE 1 jack, the day and time is automatically set to all the phones. Be sure to connect the phones beforehand, and set the day and time.

If you have subscribed to the Caller ID service, the date and time are automatically set when you received a call (see page 50).

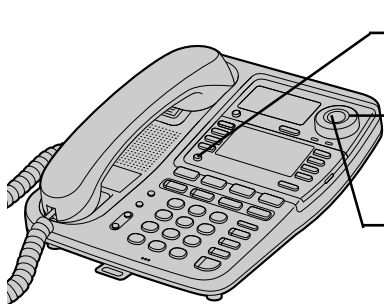

1 Press **PROGRAM**.

2 Turn Jog Dial up until “DATE TIME” appears on the display.

3 Press Jog Button.



4 Enter the two digits for the month (01 to 12 for January to December) by pressing the dialing keys.

5 Press Jog Button.

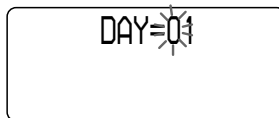

6 Enter the two digits for the day (01 to 31) by pressing the dialing keys.

7 Press Jog Button.

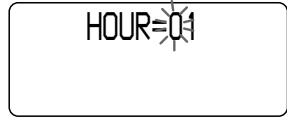

8 Enter the two digits for the hour (01 to 12) by pressing the dialing keys.

The hour is on a 12-hour cycle.

9 Press Jog Button.



10 Enter the two digits for the minute (00 to 59) by pressing the dialing keys.

11 Press Jog Button.



12 Turn Jog Dial to choose "AM" or "PM", and then press Jog Button.

You will hear a long confirmation beep.

Notes

- Do not allow more than 20 seconds to elapse between each step of the procedure in steps 1 to 11 and 60 seconds in step 12.
- The time is renewed each time the phone receives the Caller ID. Since the Caller ID sends time information by the unit of one minute, the time indication may be one minute behind at most.



Tip

You can press **PROGRAM** instead of Jog Button in the procedure above.

Step 5

Changing the display language

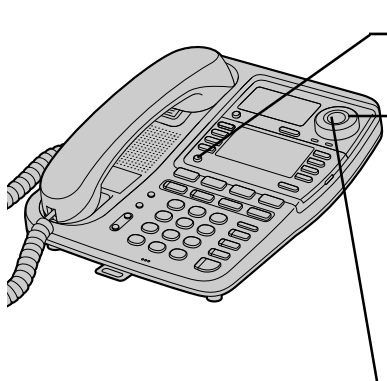
You can choose English or Spanish as the display language by following the procedure below.

- 
- 1** Press **PROGRAM**.
 - 2** Turn Jog Dial up until “LANGUAGE” appears on the display.
Display “IDIOMA” when you want to change the display language from Spanish to English.
 - 3** Press Jog Button.
The currently selected language flashes.

 - 4** Turn Jog Dial to change the display language, and then press Jog Button.
You will hear a long confirmation beep.

Note

Do not allow more than 20 seconds to elapse between each step of the procedure.

Tip

You can press **PROGRAM** instead of Jog Button in the procedure above.

Identifying the parts

Refer to the pages indicated in parentheses for details.

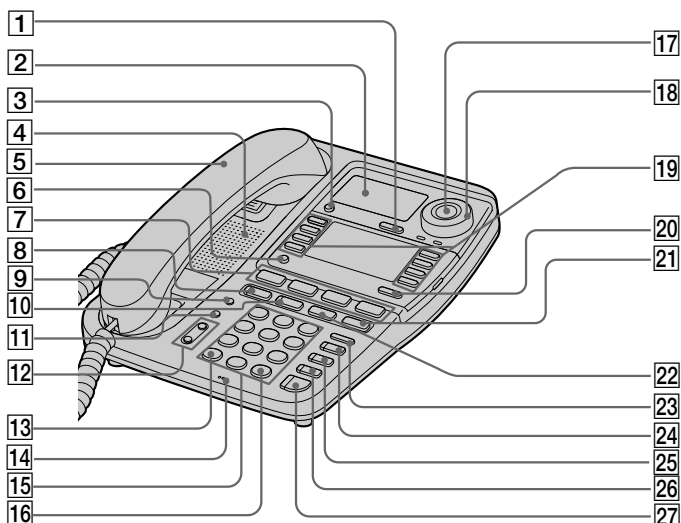

- 1 CALL WAITING/FLASH button** (p. 34, 60)
Switches to a second call if you have “call waiting” service, or lets you make a new call.
- 2 Display window** (p. 37, 51)
- 3 ERASE/CLEAR button** (p. 40, 44, 53, 61)
Used to erase a stored one-touch dialing and Phone Directory memory or Caller ID data, end the operation during the procedure.
- 4 Speaker**
- 5 Handset** (p. 11, 28, 33)
- 6 PROGRAM button** (p. 16, 37, 52)
Used to access the menu.
- 7 LINE buttons (1, 2, 3, 4)** (p. 28, 33)
Lets you make or receive a call.
- 8 INTERCOM button** (p. 63, 67)
Used to make an intercom call.
- 9 ALL PAGE button** (p. 66)
Used to page all phones through the speakerphone.
- 10 CONF (conference) button** (p. 48, 67)
Lets you talk with two parties at the same time.
- 11 PAGE button** (p. 65)
Used to page the other phone.
- 12 VOLUME +/- button** (p. 29, 34)
- 13 TONE * button** (p. 29)
Allows you to switch temporarily to tone dialing.
- 14 MIC (microphone)**
- 15 Dialing keys** (p. 28)
- 16 # button** (p. 58)
Used to change the number of digits of the phone number in the Caller ID list.
- 17 Jog Button** (p. 16)
- 18 Jog dial** (p. 16, 51)

continued

Identifying the parts (continued)

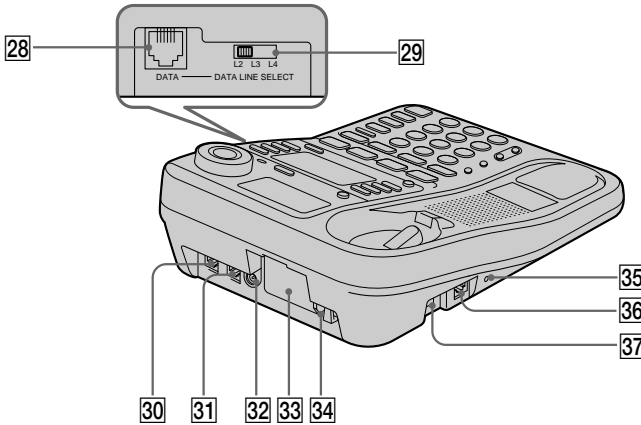

19 One-touch dial buttons
(p. 37, 56)

Used to store numbers on the one-touch dial.

20 LOWER button (p. 37)

Used to store numbers in the second memory of a one-touch dial button.

21 HOLD button (p. 29, 34)

Puts a call on hold.

22 TRANSFER button (p. 68)

Used to transfer a call.

23 REDIAL/PAUSE button (p. 31)

Redials the last number called, inserts a pause in the dialing sequence.

24 BUSY REDIAL button (p. 32)

Redials the last number called automatically when the line is busy.

25 MUTING button (p. 29, 34)

Mutes your voice during a conversation.

26 DO NOT DISTURB button (p. 35)

Used to turn off the call ringing and voice from the speaker.

27 SPEAKERPHONE (HEADSET) button (p. 28, 29)

Used to make or receive a call through the speakerphone or the headset.

28 DATA jack (p. 14)

29 DATA LINE SELECT switch (p. 14)

Used to select the line for data communication.

30 LINE 1/LINE 1+2 jack (p. 12, 70)

31 LINE 3/LINE 3+4 jack (p. 12, 70)

32 DC IN 12V jack (p. 12)

33 Battery compartment (p. 71)

34 Hook for AC power adaptor cord (p. 12)

35 RESET button (p. 74)

36 HANDSET jack (p. 11)

37 (HEADSET) jack (p. 29, 34)

Lamp indications

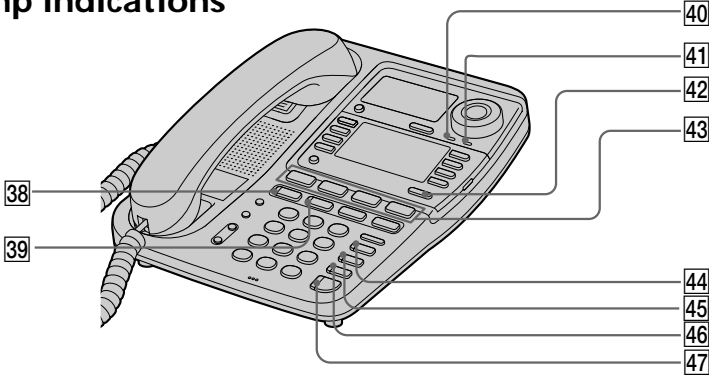

| Lamp/button | Lighting pattern | | Status |
|---------------------------|------------------|------------------------------|--|
| | Lights up | OFF | |
| 38 INTERCOM | Lights up | | Calling extension from your phone or conversation available. |
| | Flashes | | Receiving an intercom call. |
| | Flashes | | Other phone using extension. |
| 39 CONF | Lights up | | This function is activated. |
| 40 NEW CALL | Flashes | | There is new data in the Caller ID list. |
| 41 MESSAGES | Flashes | | There are voice mail messages. |
| 42 LOWER | Lights up | | Selecting the second memory of the one-touch dial button. |
| 43 LINE 1 to 4 | Lights up | | You are using this line. |
| | Flashes | | Receiving a call. |
| | Flashes | | Call being held on your phone line or transferred call being made. |
| | Flashes | | Call being held on other phone line. |
| | Flashes | | Receiving a transferred call. |
| Flashes | | Line is used by other phone. | |
| 44 BUSY REDIAL | Lights up | | This function is activated. |
| 45 MUTING | Lights up | | This function is activated. |
| 46 DO NOT DISTURB | Lights up | | This function is activated. |
| 47 SPEAKERPHONE (HEADSET) | Lights up | | Talking through the speakerphone or headset, paging or busy redialing. |

Making calls

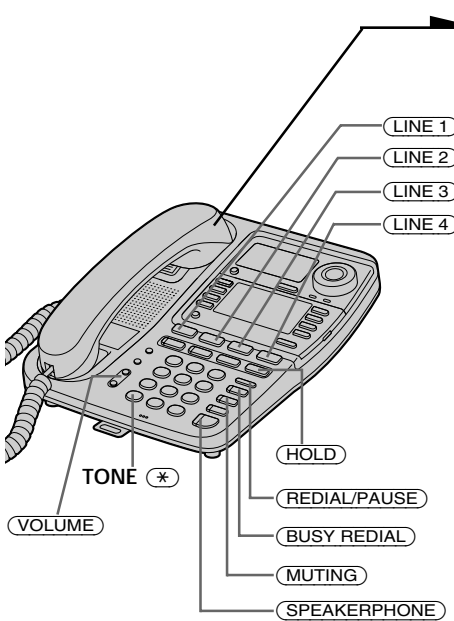

1 Pick up the handset (or press **(SPEAKERPHONE)**).

“=== TALK ===” appears on the display, and then the operation duration in hours, minutes and seconds is displayed.

The connected line button lights up.

When you want to select the line beforehand, press **(LINE 1)**, **(LINE 2)**, **(LINE 3)** or **(LINE 4)**.

The corresponding line button lights up.

2 Dial the phone number.

The phone number dialed appears on the display.

3 When you're done talking, replace the handset in the cradle (or press **(SPEAKERPHONE)**).

The disconnected line button goes off.

Note

If there is a line put on hold, you cannot make a call by just picking up the handset and pressing **(SPEAKERPHONE)** in step 1. Press a line button that is not used first, and then dial the phone number.

Tip

If you pick up the handset during speakerphone conversation, it will change to handset conversation, and conversely when you press **(SPEAKERPHONE)** during handset conversation, it becomes speakerphone conversation.

Making calls when the headset is connected

When the TL-HD1 headset (not supplied) is connected to the (HEADSET) jack, you can talk through the headset.

1 Press **(SPEAKERPHONE)** **(HEADSET)**.

The **SPEAKERPHONE** lamp lights up.

2 Dial the phone number.

3 When you're done talking, press **(SPEAKERPHONE)** **(HEADSET)**.

The **SPEAKERPHONE** lamp goes off.

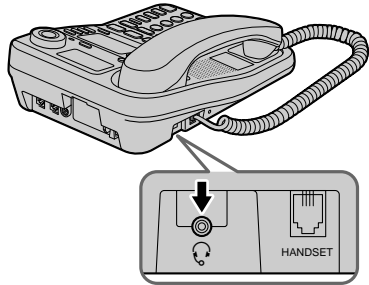

Notes

- If the headset is not connected, you will make a call through the speakerphone in step 1.
- If there is a line put on hold, you cannot make a call by just pressing **(SPEAKERPHONE)** **(HEADSET)** in step 1. Press a line button that is not used first, and then dial the phone number.

Additional tasks

| To | Do this |
|--------------------------------------|---|
| Adjust the handset or headset volume | During phone conversation, press (VOLUME +) or (VOLUME -) . Each press of (VOLUME +) or (VOLUME -) switches the handset or headset volume between "HIGH", "MID" (middle) and "LOW". |
| Adjust the speaker volume | During speakerphone conversation, press (VOLUME +) or (VOLUME -) . Each press of (VOLUME +) or (VOLUME -) switches the speaker volume by one of 16 levels. |
| Put a call on hold | Press (HOLD) . The line button on which a call is put on hold will flash. Press (LINE 1) , (LINE 2) , (LINE 3) or (LINE 4) that is flashing to resume the conversation. The corresponding line button can be pressed on every phone. |
| Mute your voice | Press (MUTING) to disable the microphone. The MUTING lamp lights up. Press (MUTING) again to cancel. |
| Switch to tone dialing temporarily | Press TONE (*) after you're connected. The line will remain in tone dialing until disconnected. |

continued

Making calls (continued)

Notes

- When another extension connected to line is in use, the line button flashes.
- When another call comes in on the other line, the corresponding line button flashes and two beeps are heard from the speaker, but the phone won't ring. (see page 36).
- If a call is put on hold for more than about three minutes, you will hear an alarm.

Tips

- You can switch to speakerphone during conversation by pressing **(SPEAKERPHONE)**. Then you can replace the handset in the cradle. To switch back to the handset, pick up the handset again.
- When you pick up the handset or press **(SPEAKERPHONE)**, the vacant line is automatically connected from line 1 to line 4. When neither line is in use, line 1 is connected.

To obtain the best speakerphone performance

- You may not be able to hear the other party's voice in a noisy place. Therefore, use the speakerphone in a quiet room.
- Do not bring your hand or other objects too close to the microphone or you will hear a shrill noise ("feedback").
- When the speaker volume is loud, or the telephone has been placed close to a wall, you may find that the volume drops suddenly. This is due to a circuit in the telephone designed to protect against feedback. In such cases, lower the speaker volume slightly.

Redialing

1 Pick up the handset (or press **(SPEAKERPHONE)**).

“=== TALK ===” appears on the display.

Press **(LINE 1)**, **(LINE 2)**, **(LINE 3)** or **(LINE 4)** to select the line, if necessary.

The corresponding line button lights up.

2 Press **(REDIAL/PAUSE)** to redial the last number dialed.

The last number dialed appears on the display and is automatically redialed.

Notes

- The last number dialed cannot be stored separately for each line. It is the very last one you have dialed using any line.
- If the last number dialed exceeds 32 digits or if it is erased, the number cannot be redialed.

Tip

When the redialed number exceeds 16 digits, the first 16 digits are displayed, and then the remaining digits are displayed one by one while the displayed numbers move from right to left across the display.

To check the last phone number dialed

When not making a call, press **(REDIAL/PAUSE)**.

The number appears on the display for 20 seconds.

To dial the number, pick up the handset (or press **(SPEAKERPHONE)**) while the number is displayed.

Note

“NO DATA” will appear on the display if the last dialed number exceeds 32 digits or if it is erased.

To erase the last phone number dialed

While the phone is not in use, press **(REDIAL/PAUSE)** twice within 20 seconds.

The number will be erased from the memory.

continued

Making calls (continued)

Busy redialing

If the other line you called is busy, the phone will automatically redial the last number dialed up to 10 times every 30 seconds until the call is connected.

When not making a call, press **(BUSY REDIAL)**.

The BUSY REDIAL lamp, MUTING lamp, SPEAKERPHONE lamp and selected line button light up and the last number dialed appears on the display.

Notes

- Busy redialing is canceled when you press **(BUSY REDIAL)**, or receive or make a call during busy redialing.
- If the last number dialed exceeds 32 digits or if it is erased, the number cannot be redialed.

Making another call while talking

Example: Making a call on line 2 while talking on line 1

1 Press **(HOLD)** while talking.

The line 1 is put on hold and the LINE 1 button flashes slowly.

2 Press **(LINE 2)**.

3 Dial a phone number for the second party.

Now you can talk to the second party on line 2.

To disconnect line 2, press **(LINE 1)**.

Notes

- If you do not press **(HOLD)** in step 1, line 1 will be disconnected.
- If a call is put on hold for more than about three minutes, you will hear an alarm.

To talk with two parties at the same time using two lines, see “Having a three-way conference call” on page 48.

Receiving calls

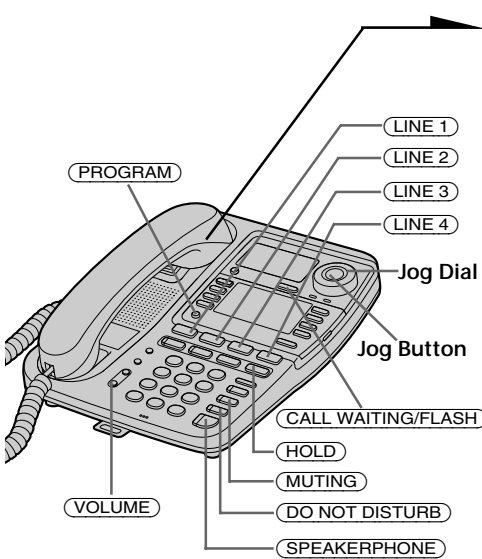

1 When you hear the phone ring;

- Pick up the handset from the phone (or press **(SPEAKERPHONE)**).

or

- Press **(LINE 1)**, **(LINE 2)**, **(LINE 3)** or **(LINE 4)** whichever button is flashing.

The **SPEAKERPHONE** lamp lights up and you can talk through the speakerphone. To talk through the handset, pick up it from the cradle.

The connected line button lights up.

“=== TALK ===” appears on the display and the display also shows the operation duration in hours, minutes and seconds.

2 When you're done talking, replace the handset in the cradle (or press **(SPEAKERPHONE)**).

The disconnected line button goes off.

When calls come in on two or more lines at the same time

Press **(LINE 1)**, **(LINE 2)**, **(LINE 3)** or **(LINE 4)** whichever button is flashing.

To put a call on hold or disconnect the line, see “Receiving a call while talking” on page 36.

continued

Basics

33^{US}

Receiving calls (continued)

Receiving calls when the headset is connected

When the TL-HD1 headset (not supplied) is connected to the  (HEADSET) jack, you can talk through the headset.

- 1 When you hear the phone ring, press **(SPEAKERPHONE)** (HEADSET).
The SPEAKERPHONE lamp lights up.
- 2 When you're done talking, press **(SPEAKERPHONE)** (HEADSET).
The SPEAKERPHONE lamp goes off.

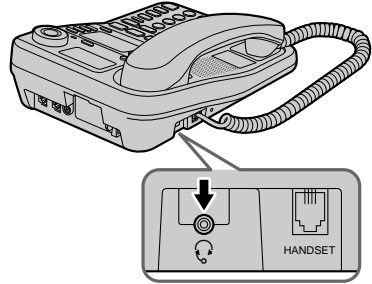

Note

If the headset is not connected, you will receive a call through the speakerphone in step 1.

Additional tasks

| To | Do this |
|---|---|
| Adjust the handset or headset volume | During phone conversation, press (VOLUME) (+) or (-). Each press of (VOLUME) (+) or (-) switches the handset or headset volume between "HIGH", "MID" (middle) and "LOW". |
| Adjust the speaker volume | During speakerphone conversation, press (VOLUME) (+) or (-). Each press of (VOLUME) (+) or (-) switches the speaker volume by one of 16 levels. |
| Put a call on hold | Press (HOLD) . The line button on which a call is put on hold will flash. Press (LINE 1) , (LINE 2) , (LINE 3) or (LINE 4) that is flashing to resume the conversation. The corresponding line button can be pressed on every phone. |
| Adjust the ringer volume | Press (PROGRAM) . Turn Jog Dial up until "RING VOLUME" appears on the display, and then press Jog Button. Turn Jog Dial to choose "HIGH", "MID" (middle), "LOW" or "OFF", and then press Jog Button. You will hear (monitor) the phone ring with the adjusted level. While the phone is ringing, you can adjust the ringer volume by pressing (VOLUME) (+) or (-), however, the ringer volume cannot be set to "OFF". |
| Mute your voice | Press (MUTING) to disable the microphone. The MUTING lamp lights up. Press (MUTING) again to cancel. |
| Switch to another call on ("call waiting" service*) | Press (CALL WAITING/FLASH) . Press (CALL WAITING/FLASH) again to return to the first caller. |

* You need to subscribe to the service from your telephone company.

If you have subscribed to the Caller ID service including the caller name service;

- the caller's number and/or name appears on the display, and the date and time are automatically set when you receive a call (see page 50).
- the ringer sound changes to a higher tone if the call matches the number stored on one-touch dial button or in the Phone Directory (memory match function; see page 50).

Notes

- When another phone connected to line is in use, the line button flashes slowly.
- If a call is put on hold for more than about three minutes, you will hear an alarm.

Using Do Not Disturb

You can turn off the outside call and intercom call ringing of all the lines and voice from the speaker during a Page and an All Page using this function. However, when a call comes in, “** RINGING **” will be displayed even if this function is activated.

Making calls is available even if this function is activated.

While the phone is not in use or the phone is ringing, you can press **(DO NOT DISTURB)**.

The DO NOT DISTURB lamp lights up.

To cancel this function, press **(DO NOT DISTURB)** again.

Note

An outside call cannot be transferred to the phone with the “DO NOT DISTURB” function activated.

Receiving a call while talking

If another call comes in while talking on the other line, the corresponding line button will flash and two beeps will be heard from the speaker.

Example: Receiving a call on line 2 while talking on line 1

1 Press **(HOLD)**.

Line 1 is put on hold and the LINE 1 button flashes slowly.

2 Press **(LINE 2)**.

Now you can talk to the other caller on line 2.

To disconnect line 2, press **(LINE 1)**.

Note

If you do not press **(HOLD)** in step 1, line 1 will be disconnected.

To talk with two parties at the same time using both line 1 and line 2, see “Having a three-way conference call” on page 48.

One-touch dialing

You can dial with a one-touch dial button by storing a phone number to that button. Since two phone numbers can be stored in a one-touch dial button, up to 16 phone numbers can be stored.

Storing phone numbers and names

Example: to store "SONY" "1234567".

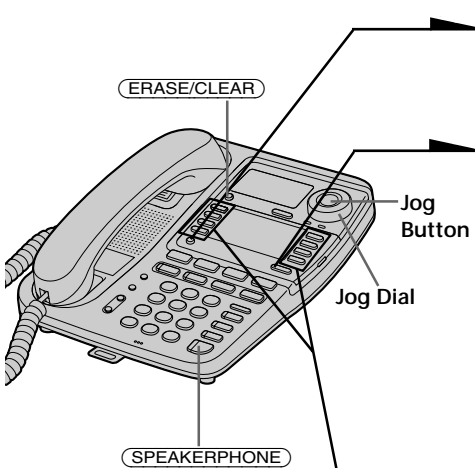

1 Press **PROGRAM**.
"DIRECTORY" appears on the display.

2 Select the first memory or second memory of the one-touch dial button by pressing **LOWER**.

When you store the phone number in the first memory of a one-touch dial button, make sure that the LOWER button is not lit.

When you store the phone number in the second memory of a one-touch dial button, press **LOWER** so that the LOWER button lights up.

3 Press one of the one-touch dial buttons.
"ENTER NAME" appears on the display.

4 Enter the name by pressing dialing keys. You can enter up to 15 characters.

Press a dialing key until the desired character appears. (See the character table for details.)

Enter successive characters in the same way.

Character table

| Key | Character |
|-----|------------------------------------|
| ① | 1 |
| ② | A → B → C → 2 |
| ③ | D → E → F → 3 |
| ④ | G → H → I → 4 |
| ⑤ | J → K → L → 5 |
| ⑥ | M → N → O → 6 |
| ⑦ | P → Q → R → S → 7 |
| ⑧ | T → U → V → 8 |
| ⑨ | W → X → Y → Z → 9 |
| ⑩ | 0 |
| * | * |
| # | & → ' → , → - → . → # → (space) |

continued

One-touch dialing (continued)

To enter two characters assigned to the same key, or to enter a “space”, turn Jog Dial up to move the cursor to the right.

Example: to enter “SONY”, press (7) four times (S), press (6) three times (O), turn Jog Dial up to move the cursor, press (6) twice (N), and press (9) three times (Y).



5 Press Jog Button.

“ENTER NUMBER” appears on the display.

6 Enter the phone number by pressing the dialing keys.

You can enter up to 20 digits, including a tone and a pause, each of which is counted as one digit.

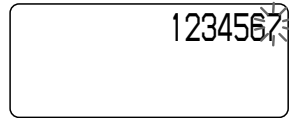

7 Press Jog Button.

You will hear a long confirmation beep, and the name and the number are stored. The display goes off.

Note

Do not allow more than 20 seconds to elapse between each step of the procedure.

Tips

- If you have entered a wrong number in step 6, press Jog Button, then follow the procedure in “Changing a stored name and/or phone number” on page 39.
- You can store a flash only to the first digit.

Changing a stored name and/or phone number

1 Display the name you want to change by pressing the one-touch dial button.

2 Press **(PROGRAM)**.

The cursor flashes at the first character of the name.

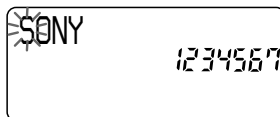

3 Turn Jog Dial up until the character to be changed flashes.

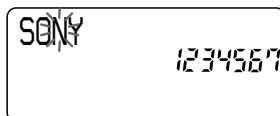

4 Enter the new name by pressing the dialing keys.

Repeat steps 3 and 4 to change the name. If you want to change only the number, skip these steps.

5 Press Jog Button.

The phone number appears.

The new phone number will be entered on the first line in step 6. The current phone number is displayed on the second line.

As shown below, the display of the entered phone number will change after registration.

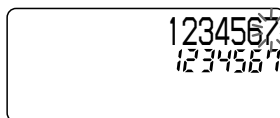

| Key | First line (Entered number) | Second line (Current number) |
|--|--------------------------------|---------------------------------|
| (*) | * | - |
| (#) | # | - |
| (REDIAL/PAUSE) (pause) | P | P |
| (CALL WAITING/FLASH) (flash) | F | F |
| TONE (*) (tone) | T | t |

6 Enter the new phone number as described previously by pressing the dialing keys.
If you don't want to change the number, skip this step.

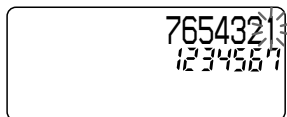

7 Press Jog Button.

You will hear a long confirmation beep and the name and/or the number is changed.

continued

One-touch dialing (continued)

Tip

When the phone number of 17 digits or more has been entered, “-” is displayed next to 15th digit and then the remaining digits are displayed after about 10 seconds.

Erasing a stored name and phone number

1 Display the name and phone number you want to erase by pressing the one-touch dial button.

2 Press **ERASE/CLEAR**.

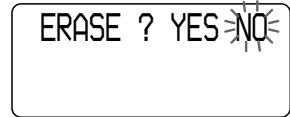

3 Turn Jog Dial to choose “YES”, and then press Jog Button.

You will hear a long confirmation beep and the name and phone number are erased.

Making calls with one-touch dialing

1 Pick up the handset, or press **SPEAKERPHONE**.

When you want to select the phone number stored in the second memory of the one-touch dial button, press **LOWER**.

2 Press the desired one-touch dial button.

The phone number stored in the one-touch dial button will be dialed.

To check the phone number before one-touch dialing

When not making a call, press the desired one-touch dial button. Each time the button is pressed, the display shows the name, the phone number, and then the display goes off successively.

To check the phone number stored in the second memory of the one-touch dial button, first press **LOWER** and then press the one-touch dial button.

The number stored in the button appears on the display for 20 seconds.

To dial the number, pick up the handset or press **SPEAKERPHONE** while the number is displayed.

Note

When there is no name stored to a one-touch dial button, “NO NAME” appears on the display. The display shows “NO DATA” when there is no phone number stored.

Tip

When the phone number of 17 digits or more has been entered, “-” is displayed next to 15th digit and then the remaining digits are displayed after about 10 seconds.

Phone Directory

You can dial a number by scrolling through the Phone Directory, in which up to 100 phone numbers can be stored.

Storing phone numbers and names

Example: to store "SONY" "1234567".

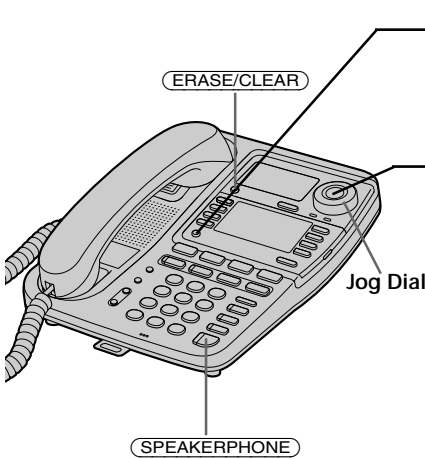

1 Press **PROGRAM**.
"DIRECTORY" appears on the display.

2 Press Jog Button.
"ENTER NAME" appears on the display.

3 Enter the name by pressing dialing keys. You can enter up to 15 characters.
Press a dialing key until the desired character appears. (See the character table for details.)
Enter successive characters in the same way.

To enter two characters assigned to the same key, or to enter a "space", turn Jog Dial up to move the cursor to the right.

Example: to enter "SONY", press **7** four times (S), press **6** three times (O), turn Jog Dial up to move the cursor, press **6** twice (N), and press **9** three times (Y).



Character table

| Key | Character |
|-----|------------------------------------|
| ① | 1 |
| ② | A → B → C → 2 |
| ③ | D → E → F → 3 |
| ④ | G → H → I → 4 |
| ⑤ | J → K → L → 5 |
| ⑥ | M → N → O → 6 |
| ⑦ | P → Q → R → S → 7 |
| ⑧ | T → U → V → 8 |
| ⑨ | W → X → Y → Z → 9 |
| ⑩ | 0 |
| * | * |
| # | & → ' → , → - → . → # → (space) |

continued

Phone Directory (continued)

4 Press Jog Button.

“ENTER NUMBER” appears on the display.

5 Enter the phone number by pressing the dialing keys.

You can enter up to 20 digits, including a tone and a pause, each of which is counted as one digit.

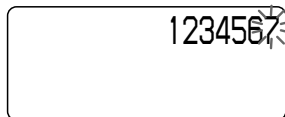

6 Press Jog Button.

You will hear a long confirmation beep, and the name and the number are stored. The display goes off.

Notes

- A total of 200 names and phone numbers can be stored into the Caller ID list and the Phone Directory combined.

For example, when 150 names and phone numbers are stored into the Caller ID list, up to 50 phone numbers can be stored into the Phone Directory. If you attempt to store a 51th phone number into the Phone Directory in this example, or a 101th phone number into the Phone Directory, you will hear five short error beeps and “MEMORY FULL” will be displayed. You cannot store the phone number. To store another phone number, erase one of the stored phone numbers (see page 44) or erase data from Caller ID list (see page 53).

- Do not allow more than 20 seconds to elapse between each step of the procedure.

Tip

If you have entered a wrong number in step 5, press Jog Button, then follow the procedure in “Changing a stored name and/or phone number” on page 43.

Changing a stored name and/or phone number

1 Display the name you want to change by doing steps 1 and 2 in “Making calls from the Phone Directory” on page 44.

2 Press **(PROGRAM)**.

The cursor flashes at the first character of the name.

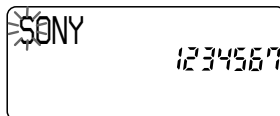

3 Turn Jog Dial up until the character to be changed flashes.

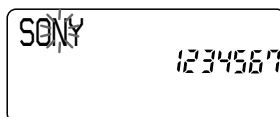

4 Enter the new name by pressing the dialing keys.

Repeat steps 3 and 4 to change the name. If you want to change only the number, skip these steps.

5 Press Jog Button.

The phone number appears.

The new phone number will be entered on the first line in step 6. The current phone number is displayed on the second line.

As shown below, the display of the entered phone number will change after registration.

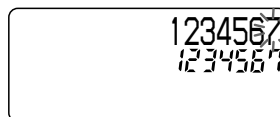

| Key | First line (Entered number) | Second line (Current number) |
|----------------------------------|--------------------------------|---------------------------------|
| (*) | * | - |
| (#) | # | - |
| (REDIAL/PAUSE) (pause) | P | P |
| TONE (*) (tone) | T | t |

continued

Phone Directory (continued)

- 6 Enter the new phone number as described previously by pressing the dialing keys.
If you don't want to change the number, skip this step.

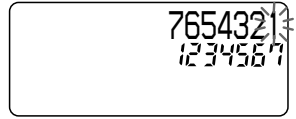

- 7 Press Jog Button.
You will hear a long confirmation beep and the name and/or the number is changed.

Tip

When the phone number of 17 digits or more has been entered, “-” is displayed next to 15th digit and then the remaining digits are displayed after about 10 seconds.

Erasing a memory location

- 1 Display the name and phone number you want to erase by doing steps 1 and 2 on “Making calls from the Phone Directory” below.

- 2 Press **ERASE/CLEAR**.

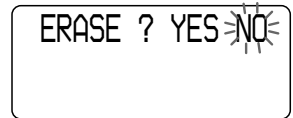

- 3 Turn Jog Dial to choose “YES”, and then press Jog Button.

You will hear a long confirmation beep and the memory location is erased.

Making calls from the Phone Directory

- 1 Press Jog Button.

“DIRECTORY 1” appears on the display. The number stored in the Phone Directory appears in the right of the display.

- 2 Display the name and phone number you want to call.
To search in alphabetical order: Turn Jog Dial up or down.
To search by entering the initial character: Press the dialing key of the desired character, then turn Jog Dial.

When the Phone Directory security mode is set to ON:

When Jog Dial is turned on or the dialing key is pressed, "SECURITY=???" is displayed.

Enter the four digits security code which you have stored in step 4 on page 46 by pressing the dialing keys.

When the security code is correct, "OK" is displayed.

Perform this step again. If the security code is not correct, "SECURITY=???" is displayed. Enter the correct security code.

3 Pick up the handset, press **SPEAKERPHONE** or press Jog Button.

The phone number will be dialed.

Notes

- Once the phone returns to idle status with the Phone Directory security mode ON setting, you must enter the security code when searching for or changing a phone number in the Phone Directory or when making calls from the Phone Directory.
- After displaying the phone number in step 2, perform step 3 within 20 seconds.

Tip

You can search the Phone Directory memory even while receiving calls. When you want to make a call from the Phone Directory memory while receiving a call, either press Jog Button, or press a line button that is not being used in step 3.

About the search order

The names appear in the following order when you turn Jog Dial up or down.

- Alphabetical order:

ABC...XYZ ↔ & ↔ ' ↔ , ↔ - ↔ . ↔ * ↔ # ↔ 0 - 9 ↔ (space)

- Initial character: To search for "SONY" for example, press **Z** and then turn Jog Dial to search through the names starting with P, Q, R, S or 7.

continued

Setting the security code and enabling/ disabling the Phone Directory security

The Phone Directory can be secured by presetting a security code. Once this setting is made, input of the correct security code is required to access the Phone Directory when searching for or changing a phone number or when making calls directly from the Phone Directory.

The four digits code you will enter in step 4 of the procedure below becomes the security code.

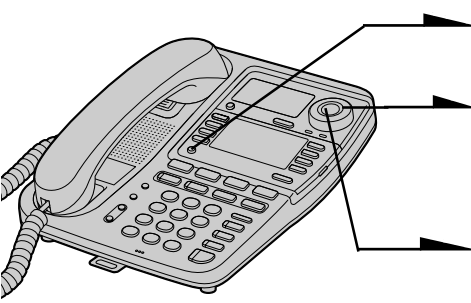
- 
- 1** Press **PROGRAM**.
 - 2** Turn Jog Dial up until “SECURITY MODE” appears on the display.
 - 3** Press Jog Button.
“NUMBER=????” appears on the display.
 - 4** Enter the four digits security code (0000 to 9999) by pressing the dialing keys.

NUMBER=1234

5 Press Jog Button.

You will hear a confirmation beep and the security mode ON/OFF setting is displayed.



6 Turn Jog Dial to choose “ON” or “OFF”, and then press Jog Button.

You will hear a long confirmation beep, and the security mode is enabled/disabled.

Tip

You can press **PROGRAM** instead of Jog Button in the procedure above.

Changing the security code

1 Perform steps 1 to 3 on page 46.

“SECURITY=????” appears on the display.

2 Enter the four digits security code (0000 to 9999) by pressing the dialing keys.

You will hear a confirmation beep when the entered security code is correct, and “CHANGE? YES NO” appears on the display.

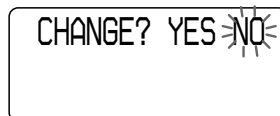
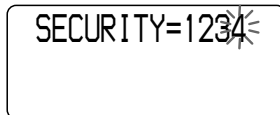

3 Turn Jog Dial to choose “YES”, and then press Jog Button.

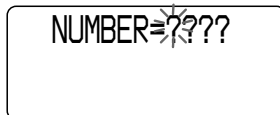

4 Enter a new four digits security code (0000 to 9999) by pressing the dialing keys.

5 Press Jog Button.

You will hear a confirmation beep and the security code is changed.

6 Turn Jog Dial to choose “ON” or “OFF”, and then press Jog Button.

You will hear a long confirmation beep, and the security mode is enabled/disabled.

Having a three-way conference call

You can talk on two lines at the same time.

Making another call while talking

You can talk with two parties at the same time using two lines. (Three-way conference)

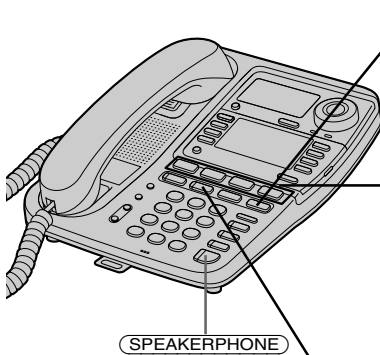

1 Press **(HOLD)** while talking on one line.

The line in use is put on hold.

2 Press **(LINE 1)**, **(LINE 2)**, **(LINE 3)** or **(LINE 4)** whichever button is not used.

3 Dial a phone number for the second party.

4 Press **(CONF)** (conference) after you're connected to the second party.

The CONF lamp lights up. Now you can talk to both parties.

When you want to return to a normal outside call, press the line button to continue the call.

Notes

- If you do not press **(HOLD)** in step 1, the first line will be disconnected.
- If three or four lines are connected or put on hold, "Three-way conference" will not be available.

Receiving a call while talking

If another call comes in while talking, the line button on which another call is coming will flash.

1 Press **(HOLD)**.

The line in use is put on hold.

2 Press **(LINE 1)**, **(LINE 2)**, **(LINE 3)** or **(LINE 4)**, in which another call is coming.

3 Press **(CONF)**.

Now you can talk to both parties. (Three-way conference)

Notes

- If you do not press **(HOLD)** in step 1, the first line will be disconnected.
- If three or four lines are connected or put on hold, “Three-way conference” will not be available.

To disconnect the lines during a three-way conference

Example: During a three-way conference between line 1 and 2

To disconnect both lines at the same time, replace the handset in the cradle.

If you talk through the speakerphone or headset, press **(SPEAKERPHONE)** (**HEADSET**).

To disconnect line 1 and continue talking on line 2 only:

Press **(LINE 2)**.

To disconnect line 2 and continue talking on line 1 only:

Press **(LINE 1)**.

To put the lines on hold during a three-way conference

Example: During a three-way conference between line 1 and 2

Press **(HOLD)**. Both lines are put on hold.

To resume the conversations on both lines, press **(CONF)**.

To resume the conversation only on one line, press **(LINE 1)** or **(LINE 2)**, for the line you want. The other line you did not select is kept on hold.

Note

During a three-way conference, you cannot use the “call waiting” service.

Understanding the Caller ID service

Caller ID allows the caller's phone number to be shown on the display before the call is answered. In order to use this feature, you must first subscribe to the Caller ID service. The name of this service may vary depending on your telephone company.

To use this feature, be sure to enter your home area code (see page 19).

When you receive a call

The phone number appears on the display with the date and time as shown in the following example.

If your Caller ID service includes the caller name service, the caller's name also appears on the display (up to 15 letters).

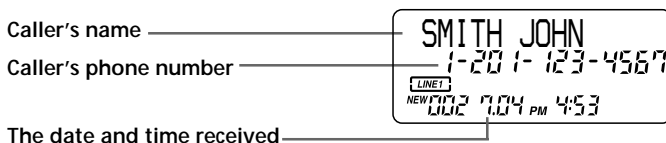

If you have subscribed to the Caller ID service, the date and time are automatically set when you received a call.

When you answer the call, the Caller ID display changes to the "=== TALK ===" display.

Notes

- The caller's phone number and/or name will not appear in the following cases:
 - "OUT OF AREA": when the call is made through a telephone company which does not offer Caller ID service (including international calls).
 - "PRIVATE": when the call is "blocked." For privacy reasons, many states allow callers the option to prevent his or her telephone data from being displayed on the other party's Caller ID display.
- If the call is from an office which uses multiple lines, the displayed phone number may not match the number you use to call the extension.
- The time is renewed each time the phone receives the Caller ID. Since the Caller ID sends time information by the unit of one minute, the time indication may be one minute behind at most.

About the memory match function

If you receive a call from a phone number which is stored on one of the one-touch dial buttons (see page 37), or in the Phone Directory (see page 41), the ringer sound will change to a higher tone from the second ring.

Tip

If calls come in on two or more lines simultaneously, the display will show the data on these lines sequentially.

Looking at the Caller ID list

The phone stores data for the last 200* calls received including “OUT OF AREA” and “PRIVATE” calls. It keeps track of all calls received; even if they were not answered.

* A total of 200 names and phone numbers can be stored into the Caller ID list and the Phone Directory combined. For example, when 150 names and phone numbers are stored into the Caller ID list, up to 50 phone numbers can be stored into the Phone Directory.

Viewing the Caller ID list

When the phone is not in use, the display shows the following.

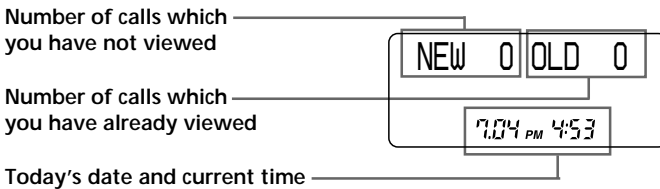

You can look through the data in the Caller ID list to check the number and/or name of the calls received.

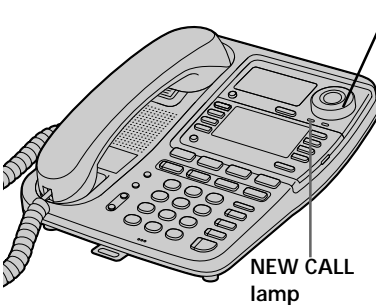

1 Turn Jog Dial.

Data for the newest call appears for 20 seconds.

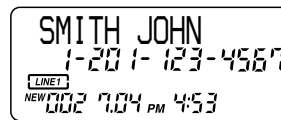

2 Turn Jog Dial up to display older data or down to display newer data.

Notes

- “NEW” data will not be changed to “OLD” data unless all “NEW” data is viewed at one time. If only some “NEW” data is viewed, that data will not be counted as “OLD” data if there is “NEW” data that has not yet been viewed.
- When you have checked all data by turning Jog Dial up or down, “END OF LIST” appears.

Tip

When there is “NEW” data, the NEW CALL lamp flashes.

Looking at the Caller ID list (continued)

About the "REPEAT" and "SAVE" display

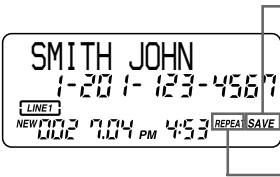

"SAVE" appears if the call is "saved" (see below).

"REPEAT" appears if there are more than two calls from the same caller. The older data will be replaced by the new data, so the calls are counted as only one call (for "NEW" calls only). When all "NEW" data is viewed, "REPEAT" goes off.

Saving the phone numbers in the Caller ID list

As the phone stores data for up to 200 calls, if a 201st call comes in, the oldest data is erased automatically.

To prevent important data from being erased, you can "save" them. The "saved" data will not be erased until you erase them manually (see page 53). If you receive a call from the number saved in the Caller ID list, the ringer sound will change to higher tone from the second ring. You can save up to 50 phone numbers.

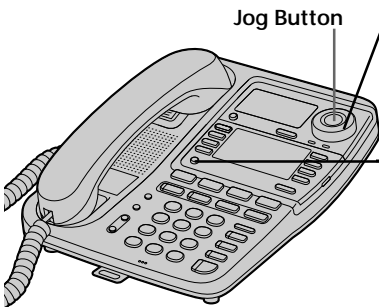

1 Display the phone number you want to save from the Caller ID list by turning Jog Dial.

2 Press **PROGRAM** while the number is displayed.



3 Turn Jog Dial to choose "SAVE", and then press Jog Button.

You will hear a long confirmation beep and "SAVE" appears.

Note

If you try to save a 51st phone number, you will hear five short error beeps and you cannot save the phone number. To save the phone number, erase one of the saved phone numbers (see page 53).

Erasing data from the Caller ID list

To erase phone numbers one by one

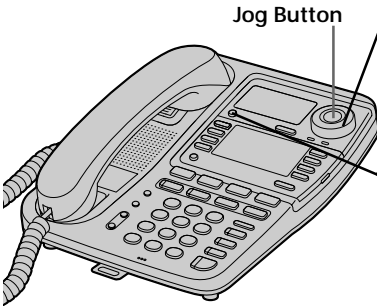

1 Display the phone number you want to erase by turning Jog Dial.

2 Press **ERASE/CLEAR** while the number is displayed.

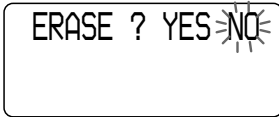

3 Turn Jog Dial to choose "YES", and then press Jog Button.

You will hear a long confirmation beep and the data is erased.

The selected phone number is erased and the phone number prior to the phone number that has been erased on the Caller ID list appears on the display.

Looking at the Caller ID list (continued)

To erase the entire list at once

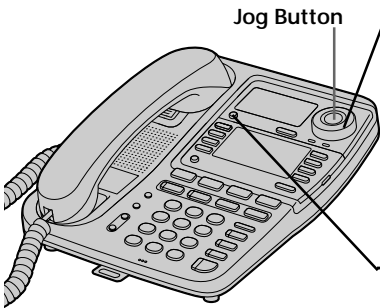

- 1** Display “END OF LIST” by turning Jog Dial.

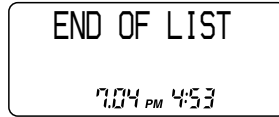

- 2** Press **ERASE/CLEAR**.

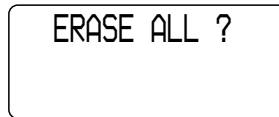

“ERASE ALL?” is displayed, and “YES NO” appears after about two seconds.

- 3** Turn Jog Dial to choose “YES”, and then press Jog Button.

You will hear a long confirmation beep and the entire list is erased.

Notes

- If you intend to erase the entire list with any new calls remaining, you will hear five short error beeps and you cannot erase the list.
- The “saved” numbers (see page 52) are not erased even if you erase the entire list. To erase the “saved” numbers in the Caller ID list, follow the procedure in “To erase phone numbers one by one”.

Using the Caller ID list

Using the Caller ID list, you can call back a phone number from the Caller ID list easily, or store numbers from the Caller ID list into one-touch dial buttons or Phone Directory.

Calling back a number from the Caller ID list

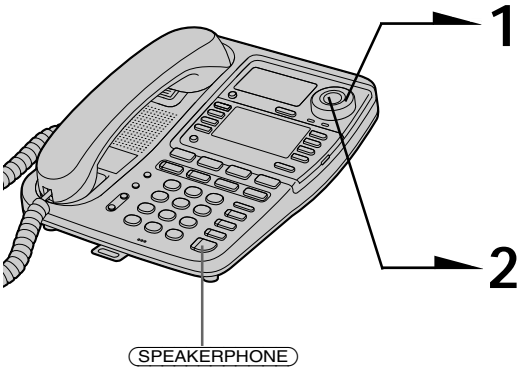

1 Display the phone number you want to call by turning Jog Dial.

2 Confirm the number and press Jog Button, pick up the handset or press **(SPEAKERPHONE)** while the number is displayed. The phone automatically dials the displayed number.

The call log display shows: SMITH JOHN, 1-201-123-4567, LINE 1, NEW YORK, 002 004 PM 4:53.

SPEAKERPHONE

Note

If the number displayed in step 1 is not the one you should call back, you can change the number of digits of the phone number as described on page 58.

Tip

You can search the Caller ID list even while receiving calls. When you want to make a call from the Caller ID list while receiving a call, either press Jog Button, or press a line button that is not being used in step 2.

Using the Caller ID list (continued)

Storing a number of the Caller ID list into one-touch dial buttons

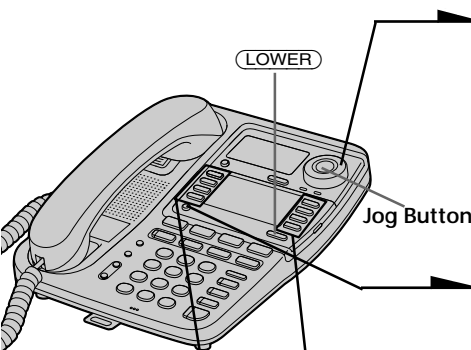

1 Display the phone number you want to store by turning Jog Dial.

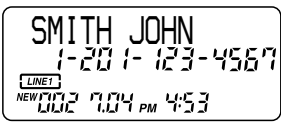

2 Press **PROGRAM** while the number is displayed.



3 Press Jog Button.

When you store the phone number in the second memory of a one-touch dial button, press **LOWER**.

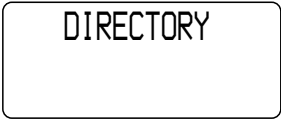

4 Press one of the one-touch dial buttons.

You will hear a long confirmation beep and the phone stores the number.

Notes

- If the home area code has not been entered, you will hear five short error beeps and the storing will be canceled in step 2.
- Do not allow more than 20 seconds to elapse between steps 2 to 4 of the procedure.
- If the number displayed in step 1 is not the one you should store, you can change the number of digits of the phone number as described on page 58. However, once you store a number into one-touch dial button, you cannot alter the phone number as described on page 58.

Storing a number of the Caller ID list into Phone Directory

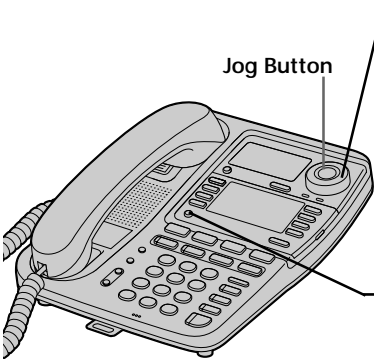

1 Display the phone number you want to store by turning Jog Dial.

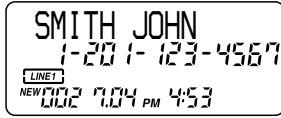

2 Press **PROGRAM** while the number is displayed.



3 Press Jog Button.



4 Press Jog Button again.
You will hear a long confirmation beep and the phone stores the number.

Notes

- If the home area code has not been entered, you will hear five short error beeps and the storing will be canceled in step 2.
- Do not allow more than 20 seconds to elapse between steps 2 to 4 of the procedure.
- If the number displayed in step 1 is not the one you should store, you can change the number of digits of the phone number as described on page 58. However, once you store a number into Phone Directory, you cannot alter the phone number as described on page 58.
- A total of 200 names and phone numbers can be stored into the Caller ID list and the Phone Directory combined, see page 42 for details.

continued

Using the Caller ID list (continued)

To change the number of digits of the phone number

If the number of digits of the phone number in the Caller ID list is different from the actual phone number, you need to adjust the number of digits of the phone number to call back, store into the one-touch dialing or Phone Directory number.

- 1 While the phone number from the Caller ID list is displayed, press **(#)** repeatedly until the phone number with the correct number of digits appears on the display.

Each time you press **(#)**, the number of digits changes as follows:

When the home area code and the local area code do not match

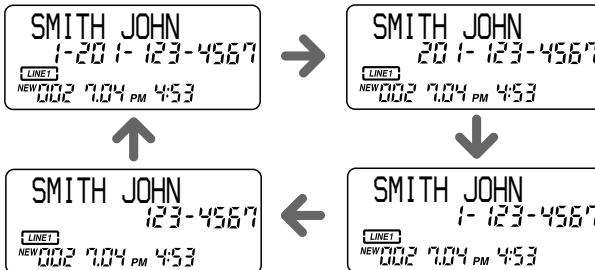

When the home area code matches

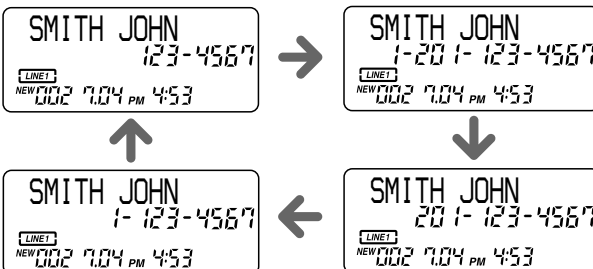

When the local area code matches

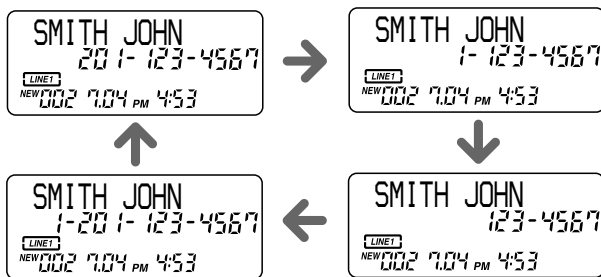

2 Continue the operation to call or store the phone number with the correct number of digits (pages 55, 56 and 57).

Notes

- You need to adjust the number of digits each time you call back from the Caller ID list as the changes to the Caller ID data is not stored in memory.
- You may not be able to change the number of digits depending on the Caller ID data.

Using “Caller ID with call waiting” service

This telephone is compatible with the “Caller ID with call waiting” service. Make sure that your telephone company offers this service.

Like the basic Caller ID service, you need to subscribe to “Caller ID with call waiting” in order to use this service.

Even though you may have already subscribed to “Caller ID” and “call waiting” as two separate services, you need to request a subscription to “Caller ID with call waiting” as a single service.

This is a new service that combines the two services.

Even though you now have a “Caller ID with call waiting” compatible phone, unless you subscribe to the combined “Caller ID with call waiting” service, you will not be able to see the name and number of the second caller.

When a new call comes in while you are talking, the caller’s name and/or phone number of the new call appears on the display for about 20 seconds.

To switch to another caller

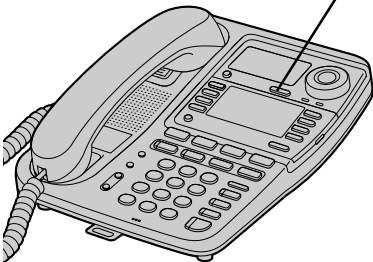

1 To switch to the new caller, press **(CALL WAITING/FLASH)**.

2 To switch back to the first caller, press **(CALL WAITING/FLASH)** again.

Using visual message waiting service

If you subscribe to your telephone company's message service which includes this feature, the display will show that you have messages waiting to be retrieved.

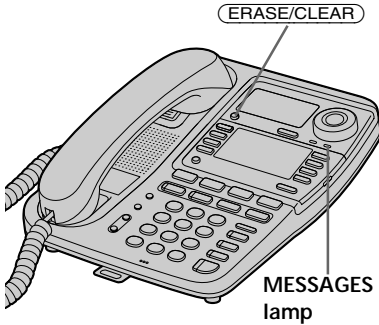

If you have messages

Example: When there are messages on line 1.

“LINE 1” and “MESSAGES” appear on the display of all phones connected to LINE 1 jack and the MESSAGES lamp of all phones flashes.

The display and the MESSAGES lamp of all phones will go off when one phone retrieves messages.

Note

You cannot use this feature, if you have not subscribed to your telephone company's message service.

For details on the availability of this service, please ask your telephone company.

If the display and the MESSAGES lamp remain flashing

If the display and MESSAGES lamp do not go off (e.g. When you retrieve your messages with other phones), you can go off the display and MESSAGES lamp manually by pressing (ERASE/CLEAR).

Note

When there are messages on two or more lines, you can turn off the message display and MESSAGES lamp on all the lines by pressing (ERASE/CLEAR). However, the display and MESSAGES lamp on other connected phones are not turned off.

Using visual message waiting service (continued)

If you move or change your telephone company

Message waiting signals are sent in one of two ways: FSK signaling or “stutter” signaling (Your telephone company can provide you with more information about your service).

The first time this phone receives a voice mail message, it will set itself to the FSK service and will lock out the stutter service if your telephone company is in FSK service.

When you move or change your telephone company, you need to do the following: Unplug the AC power adaptor, and plug it into an AC outlet. If the battery is still inserted in the phone, take it out. The phone will return to the ready state for either FSK or stutter dial tone voice mail recognition.

Talking between the phones (Intercom)

You can converse with the other phone connected to the LINE 1 jack.

Example: Making an intercom call from station number 02 to 03.

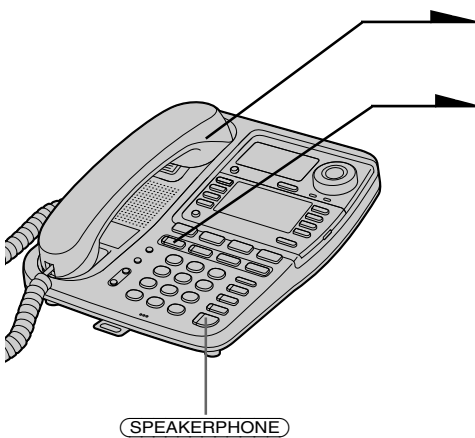

1 Pick up the handset.

2 Press **INTERCOM**.
“INTERCOM ??” appears on the display.

3 Enter the two digits station number (01 to 16) by pressing the dialing keys.

The phone makes a call immediately after the number is entered.

“INTERCOM TO 03” appears on the display of the phone making a call.

The phone rings and “INTERCOM FROM 02” appears on the display of the phone receiving a call.

When a person at the phone receiving a call picks up the handset or presses **SPEAKERPHONE** or **INTERCOM**, you can talk with each other.

4 When you’re done talking, replace the handset in the cradle.

continued

Talking between the phones (Intercom) (continued)

Notes

- An intercom call is available between two phones only. If the other phone are busy with intercom, page, or all page, you will hear a busy tone and "BUSY" will be displayed.
- If the other phone is in Do Not Disturb mode, you will hear a short busy tone and "DO NOT DISTURB" will be displayed.
- While conversing with an outside caller via the phone receiving an intercom call, you cannot make an intercom call. If you press **(INTERCOM)**, you will hear a busy tone.
- If you enter your station number mistakenly in step 3, you will hear five short error beeps. If you enter a station number which has not been assigned, "NO ANSWER" will be displayed.

Tips

- When you receive an intercom call, the phone will ring at a low level even when the "RING VOLUME" is set to "OFF".
- While on an intercom call, the INTERCOM lamp on the connected two phones lights up and on other phones flashes.
- If you press **(INTERCOM)** in step 2 without performing step 1 on page 63, the speakerphone will automatically turn on. When you're done talking, press **(SPEAKERPHONE)** in this case.
- If you pick up the handset during speakerphone conversation, it will change to handset conversation, and conversely when you press **(SPEAKERPHONE)** during handset conversation, it becomes speakerphone conversation.

Voice paging (PAGE)

You can page the other phone connected to the LINE 1 jack without any operation on the other phone. The phone being called rings once and the speakerphone automatically turns on.

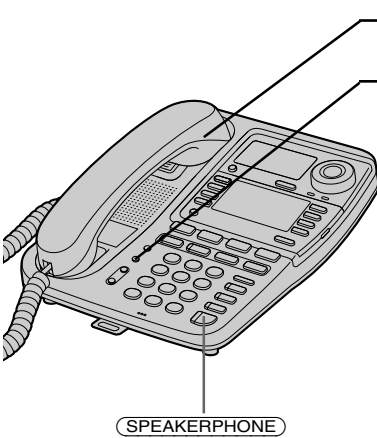

Example: Page from station number 02 to 03.

- 1** Pick up the handset.
- 2** Press **(PAGE)**.
“PAGE ??” appears on the display.
- 3** Enter the two digits station number (01 to 16) by pressing the dialing keys.
The phone pages immediately after the number is entered.
“PAGE TO 03” appears on the display of the phone making a call.
The phone rings and “PAGE FROM 02” appears on the display of the phone receiving a call.
You can begin talking.
- 4** When you’re done talking, replace the handset in the cradle.

Notes

- Paging is available between two phones only. If the other phone are busy with intercom, page, or all page, you will hear a busy tone and “BUSY” will be displayed.
- If the other phone is in Do Not Disturb mode, you will hear a short busy tone and “DO NOT DISTURB” will be displayed.
- While conversing with an outside caller via the phone to be paged, you cannot page that phone. If you press **(PAGE)**, you will hear a busy tone.
- If you enter your station number mistakenly in step 3, you will hear five short error beeps. If you enter a station number which has not been assigned, “NO ANSWER” will be displayed.

Tips

- If you press **(PAGE)** in step 2 without performing step 1, the speakerphone will automatically turn on. To disconnect the speakerphone conversation, press **(SPEAKERPHONE)**.
- A person can also answer a page by picking up the handset in step 3.

Paging all phones (ALL PAGE)

You can page all phones connected to the LINE 1 jack through the speakerphone.

Example: Page all phones from station number 02.

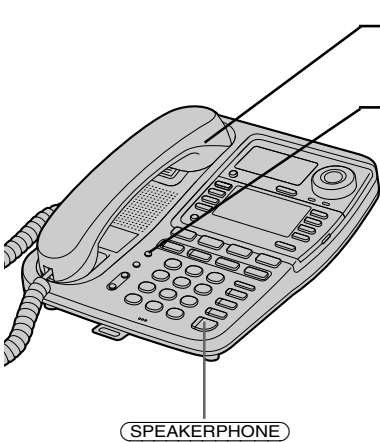

1 Pick up the handset.

2 Press **ALL PAGE**.

“ALL PAGE” appears on the display of the phone making the page.

The other phones being called ring once and “ALL PAGE 02” appears on the display.

You can page all phones through the speakerphone.

3 When you're done talking, replace the handset in the cradle.

Notes

- When the other phone are busy with intercom, page, or all page, you cannot execute all page.
- You cannot use All Page for the phone which is on an outside call or in Do Not Disturb mode.
- Answering or finishing an all page is not available from the paged phone.

Tips

- If you press **ALL PAGE** in step 2 without performing step 1, the speakerphone will automatically turn on. To disconnect the speakerphone conversation, press **SPEAKERPHONE**.
- When being called with all page, press **SPEAKERPHONE** to cancel the calling and operate the phone.

Having an intercom conference call

While on an outside call, connecting an intercom call allows you to talk with two parties at the same time (Intercom conference call).

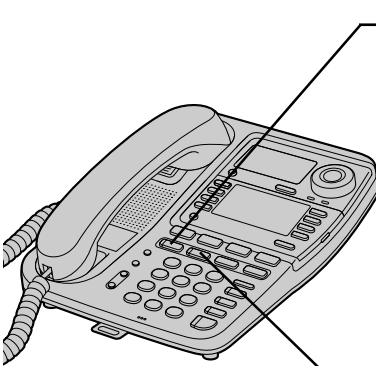

1 While conversing with an outside caller, press **INTERCOM**.
The line in use is put on hold and “INTERCOM ??” appears on the display.

2 Enter the two digits station number (01 to 16) by pressing the dialing keys.

3 Press **CONF** (conference) after you’re connected to the second party.

The CONF lamp lights up. Now you can talk to both parties.

When you want to return to a normal outside call, disconnect from one of the internal lines.

Notes

- Even if **CONF** is pressed on the phone receiving an intercom call, “intercom conference call” cannot be performed.
- If two or more lines are put on hold, select the line to be included into the conversation by pressing the line button, and then perform the procedure above.

Tip

You can conduct an intercom conference if you press a line button during an outside call, with other phones also pressing the same line button.

Transferring a call

You can transfer a call to the other phone connected to the LINE 1 jack.

Example: When transferring the call on line 1 to station number 03.

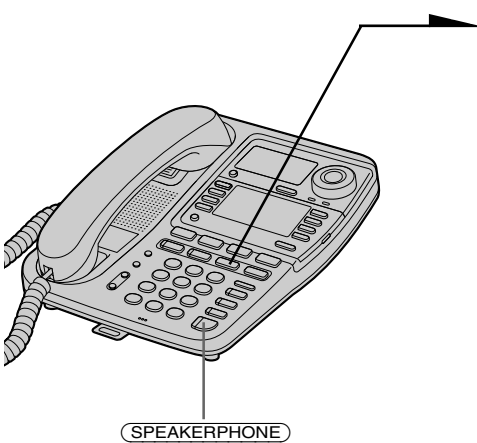

1 While conversing with an outside caller, press **TRANSFER**.

The line in use is put on hold and “TRANSFER ??” appears on the display.

2 Enter two digits station number (01 to 16) of the phone receiving the transfer by pressing the dialing keys.

The phone makes a call immediately after the number is entered.

“TRANSFER TO 03” appears on the display of the phone making a call.

The phone rings and “LINE1 TRANSFER” appears on the display of the phone receiving a call.

3 When a person picks up the handset (or presses **SPEAKERPHONE**) or presses **LINE 1**, **LINE 2**, **LINE 3** or **LINE 4** whichever button is flashing on the phone receiving a transferred call, an outside call is connected.

Notes

- If there is another call from outside while transferring a call, you cannot speak to the outside caller in step 3. Press the line button you want to answer and talk.
- After step 2, if the phone receiving the transferred call does not perform step 3 within about one minute after the handset has been replaced or **(SPEAKERPHONE)** pressed on the phone transferring the call, an alarm will be heard from the phone transferring the call.
- If the other phone is in Do Not Disturb mode, you will hear a short busy tone and “DO NOT DISTURB” will be displayed.
- If the phone receiving the transfer is on an outside call or intercom call, an outside call will not be transferred, you will hear a busy tone and “BUSY” or “NO ANSWER” will be displayed.
- If two or more lines are put on hold, select the line to be transferred by pressing the line button, and then perform the procedure on page 68.
- If you enter your station number mistakenly in step 2, you will hear five short error beeps. If you enter a station number which has not been assigned, “NO ANSWER” will be displayed.

Tips

- Transferring is available even while any of phones are on an intercom call other than the phone receiving the transfer.
- When you receiving a transferred call, the phone will ring at a low level even when the “RING VOLUME” is set to “OFF”.
- You can replace the handset in the cradle or press **(SPEAKERPHONE)** after you have entered the station number in step 2.
- To cancel transferring a call, press the line button which is flashing. The conversation with an outside caller is resumed.

To transfer during an intercom call

While on an outside call, make an intercom call (see page 63). The outside call is put on hold. When the line button which is flashing is pressed on the phone called, the outside call is connected.

To transfer during a page

While on an outside call, make a Page (see page 65). The outside call is put on hold. When the line button which is flashing is pressed on the phone paged, the outside call is connected.

To transfer during an all page

While on an outside call, make an All Page (see page 66). The outside call is put on hold. The outside call is connected by pressing the line button which is flashing on every phone.

When you do not know the phone to which an outside call should be transferred, use this function.

Tip

To cancel the transfer during an intercom call, Page or All Page, press the line button which is flashing. The conversation with an outside caller is resumed.

Mounting the phone on a wall

1

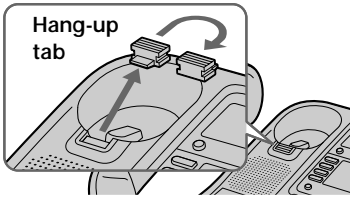

1

Remove the hang-up tab and replace it upside down.

2

Attach the wall bracket to the phone. Insert the upper tabs first, then press the phone so that the lower tabs on the wall bracket go into the phone.

2

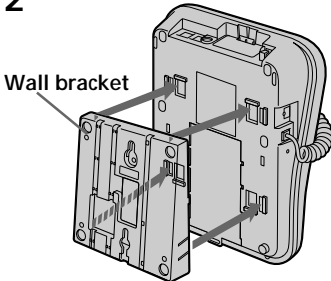

3

Attach the AC power adaptor cord and the telephone line cords to the wall bracket.

3, 4

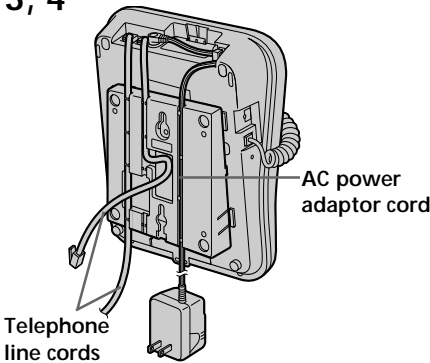

4

Plug the other end of the telephone line cords into the LINE 1/LINE 1+2, LINE 3/LINE 3+4 jacks, and plug the telephone line cord into the DATA jack if necessary.

5

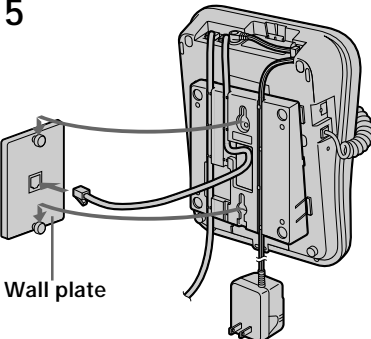

5

Hook the wall bracket to the wall plate, and plug the telephone line cords into the telephone outlets. Plug the telephone line cord into the input jack on the computer or FAX, etc., if necessary.

Using the phone during a power failure

During a power failure, you cannot make or receive calls. When power returns, reset the date and time. Other settings and memory will return as they were before the power failure.

We recommend that you install the 6F22/6LR61 9V battery (not supplied) into the phone.

When you install the 6F22/6LR61 9V battery (not supplied) into the phone

During a power failure, you can make or receive calls. However, the speakerphone does not function. To make a call, you must press the line button after picking up the handset, and to receive a call, press the line button which is flashing after picking up the handset.

The phone can be used for about 30 minutes continuously.

When making a call, you can only use the dialing keys.

During a power failure, "POWER FAILURE" appears on the display.

In the following cases, the battery has been exhausted so it needs to be replaced.

- When calls cut out during a conversation.
- When the line button does not light up or goes off quickly even if the line button is pressed after picking up the handset.
- When the display of "POWER FAILURE" becomes weak.
- A clicking noise may be heard from the phone.

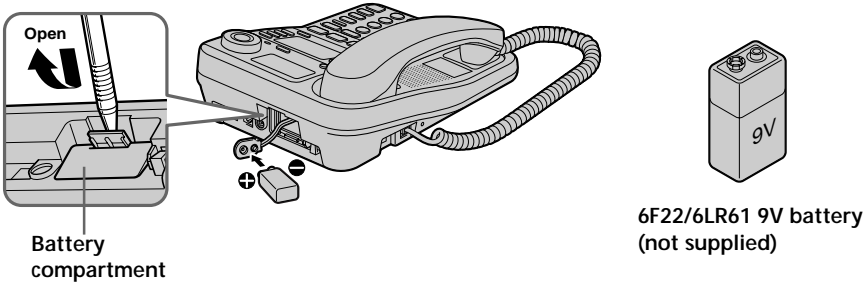

Notes

- You cannot operate the phone other than for making or receiving calls.
- If the AC adaptor is pulled out from the AC outlet when the battery is still inside the phone, the battery will discharge even if the phone is not being used. Remove the battery when unplugging the phone for a long time in order to avoid battery discharge and damage to the phone from battery leakage.
- If there is a power failure during a call with intercom, page, and all page, the call will be disconnected. When transferring a call, outside call will remain on hold even in the case of a power failure, so you can return to the outside call.

Tip

If there is a power failure during an outside call, the call may be continued, but the handset volume and speakerphone volume can not be adjusted.

Maintenance

- Clean the cabinets with a soft cloth slightly moistened with water or a mild detergent solution. Do not use any type of abrasive pad, scouring powder or solvent such as alcohol or benzine as they may damage the finish of the cabinet.
- If you have any questions or problems concerning your phone, please consult your nearest Sony dealer.

Troubleshooting

If you've experienced any of the following difficulties while using your phone, use this troubleshooting guide to help you remedy the problem. Should any problem persist, consult your nearest Sony dealer.

| | Symptom | Remedy |
|------------------------------------|---|--|
| Making/receiving calls | You hear no dial tone. | <ul style="list-style-type: none"> Make sure the telephone line cord is securely connected to the telephone outlet. |
| | The telephone does not connect at all, even though the number you dial is correct. | <ul style="list-style-type: none"> Make sure the dial mode is set correctly (page 17). |
| | The phone does not redial correctly. | <ul style="list-style-type: none"> Make sure the last dialed number is really the one you want to dial. |
| | You cannot hear anything from the speaker. | <ul style="list-style-type: none"> Press (VOLUME) (+) to increase the speaker volume (page 29). |
| | The phone does not ring. | <ul style="list-style-type: none"> "RING VOLUME" set to "HIGH", "MID" or "LOW" (page 34). Make sure the phone is not in Do Not Disturb mode (page 35). |
| | The line button of the unused line flashes. | <ul style="list-style-type: none"> Make sure the unused line is set to "DISABLE" (page 18). |
| | You hear five short error beeps when you press the line button. | <ul style="list-style-type: none"> Make sure the line is set to "DISABLE" (page 18). |
| One-touch dialing /Phone Directory | A click will sound from the phone after call completion or when the connection of the call has been unsuccessful. | <ul style="list-style-type: none"> This sound is an automatic confirmation of whether or not there have been any voice messages, and not a malfunction. |
| | You hear five short error beeps and cannot store a number on a one-touch dial or in the Phone Directory. | <ul style="list-style-type: none"> Make sure your home area code is entered (page 19). Make sure you follow the procedure for storing the number correctly (page 37, 41). Make sure the number (including the tone and pause digits) does not exceed 20 digits. |
| | One-touch dialing or Phone Directory dialing is incorrect. | <ul style="list-style-type: none"> Store the correct number (page 37, 41). |
| | You forget your security code. | <ul style="list-style-type: none"> Contact your local Sony authorized dealer or service center. |

Troubleshooting (continued)

| | Symptom | Remedy |
|-----------|---|---|
| Caller ID | The caller's name and/or phone numbers does not appear on the display. | <ul style="list-style-type: none"> • Make sure you have subscribed to Caller ID service. • The call is made through company which does not offer Caller ID service. "OUT OF AREA" will appear on the display. • The call was "blocked." "PRIVATE" will appear on the display. • You have answered the call while "** RINGING **" was displayed. Be sure to answer after the Caller ID data is displayed. • Make sure your home area code is entered (page 19). |
| | The caller's name and/or phone numbers does not appear on the display during call waiting. | <ul style="list-style-type: none"> • Make sure you have subscribed to "Caller ID with call waiting" service (see page 60). |
| | You cannot dial the number from the Caller ID list. | <ul style="list-style-type: none"> • Make sure your home area code is entered (page 19). • You may need to change the number of digits of the phone number (page 58). |
| | The memory match function does not work. | <ul style="list-style-type: none"> • If the call is from an office which uses multiple lines, the phone number may not match the number you put in the memory. |
| Intercom | You cannot use visual message waiting service. | <ul style="list-style-type: none"> • Make sure you have subscribed to visual message waiting service (see page 61). • If you move or change your telephone company, reset this phone (page 62). |
| | When pressing (INTERCOM), you hear a busy tone and cannot make an intercom call. | <ul style="list-style-type: none"> • The other phone is on an intercom call. |
| | When pressing (INTERCOM) or (PAGE), you hear a short busy tone and cannot make an intercom call or make a paging. | <ul style="list-style-type: none"> • Make sure that the other phone (IT-M804 or IT-M704) is connected to the LINE 1 jack correctly. • Make sure a phone other than the IT-M804 and IT-M704 phone is not connected to the LINE 1 jack. • Make sure that all phones are appropriately connected according to the indoor wiring (page 11). • Make sure the phone is not in Do Not Disturb mode (page 35). |
| | The dialing mode, area codes, date and time and station number is incorrect. | <ul style="list-style-type: none"> • The data of these settings were not sent to the phones correctly. Set these settings up again. |
| | | |

To reset the phone

If any of these remedies do not work, unplug the AC power adaptor. If the battery is still inserted in the phone, take it out. When the phone won't be reset yet, press RESET button on the left side of the phone with a ball-point pen, etc.

The day and time setting and last phone number dialed will be erased.

Note

When you reset the phone by pressing RESET button, the whole contents Phone Directory, area codes, Caller ID data, messages, the dialing mode and Do Not Disturb settings may be erased.

To return the phone to the factory setting

When you lost the security code or need to erase the home area code, etc., reset the phone by following the procedure below.

Note

If you return the phone to the factory setting, the whole contents of one-touch dial, Phone Directory, Caller ID data and all settings will be erased.

To return the phone to the factory setting, unplug the AC power adaptor, and then plug it while pressing (ERASE/CLEAR). If the battery is still inserted in the phone, take it out first.

Specifications

Power source

DC 12V from AC power adaptor AC-T71

Dial signal

Tone, 10 PPS (pulse) selectable

Dimensions

Approx. 7 ⁷/₈ x 2 ⁵/₈ x 9 ¹/₄ inches
(w/h/d)
(approx. 199 x 68.2 x 235.5 mm)

Mass

Approx. 2 lb 2 oz
(approx. 1010 g)

Supplied accessories

See page 9.

Design and specifications are subject to change without notice.

Index

A

- Assigning station number 16
- Adjusting the volume
 - handset 29, 34
 - headset 29, 34
 - ringer 34
 - speaker 29, 34
- Area code 19

B

- Busy redialing 32

C

- Call waiting service 34, 60
- Caller ID 50
 - Caller ID list 51
 - calling back 55
 - date and time 50
 - saving Caller ID data 52
 - storing into one-touch dial buttons 56
 - storing into Phone Directory 57
- Caller ID with call waiting 60
- Conference 48, 67
- Connection 10
- D, E, F, G**
 - Dialing mode
 - choosing 17
 - switching to tone dialing temporarily 29
 - Directory
 - Phone Directory 41
 - Disable the line 18
 - Display language 24
 - Do Not Disturb 35

H

- Headset 29, 34
- Hold 29, 34
- Home area code 19

I, J, K

- Identifying the parts 25
- Intercom 63
- Intercom conference 67

L

- Lamp indications 27
- Local area code 20

M, N

- Making calls 28
- Memory match function 50
- Mounting the phone on a wall 70

O

- One-touch dialing 37
- OUT OF AREA 50

P, Q

- Package contents 9
- Paging all phones 66
- Phone Directory 41
- Power failure 71
- PRIVATE 50
- Pulse dialing 17

R

- Receiving calls 33
- Redialing 31
- REPEAT 52
- Reset the phone 74
- Return to the factory setting 75

S

- SAVE 52
- Saving Caller ID data 52
- Security code 46
- Setting up
 - dialing mode 17
 - phone 10
- Speakerphone
 - performance 30
 - Specifications 76
- Storing Caller ID data into one-touch dial buttons 56
- Storing Caller ID data into Phone Directory 57

T, U

- Talking between the phones 63
- Three-way conference 48
- Tone
 - dialing 17
 - switching to 29
- Troubleshooting 73
- Transferring a call 68

V, W, X, Y, Z

- Visual message waiting service 61
- Voice paging 65
- Volume
 - handset 29, 34
 - headset 29, 34
 - ringer 34
 - speaker 29, 34

For the customers in the USA

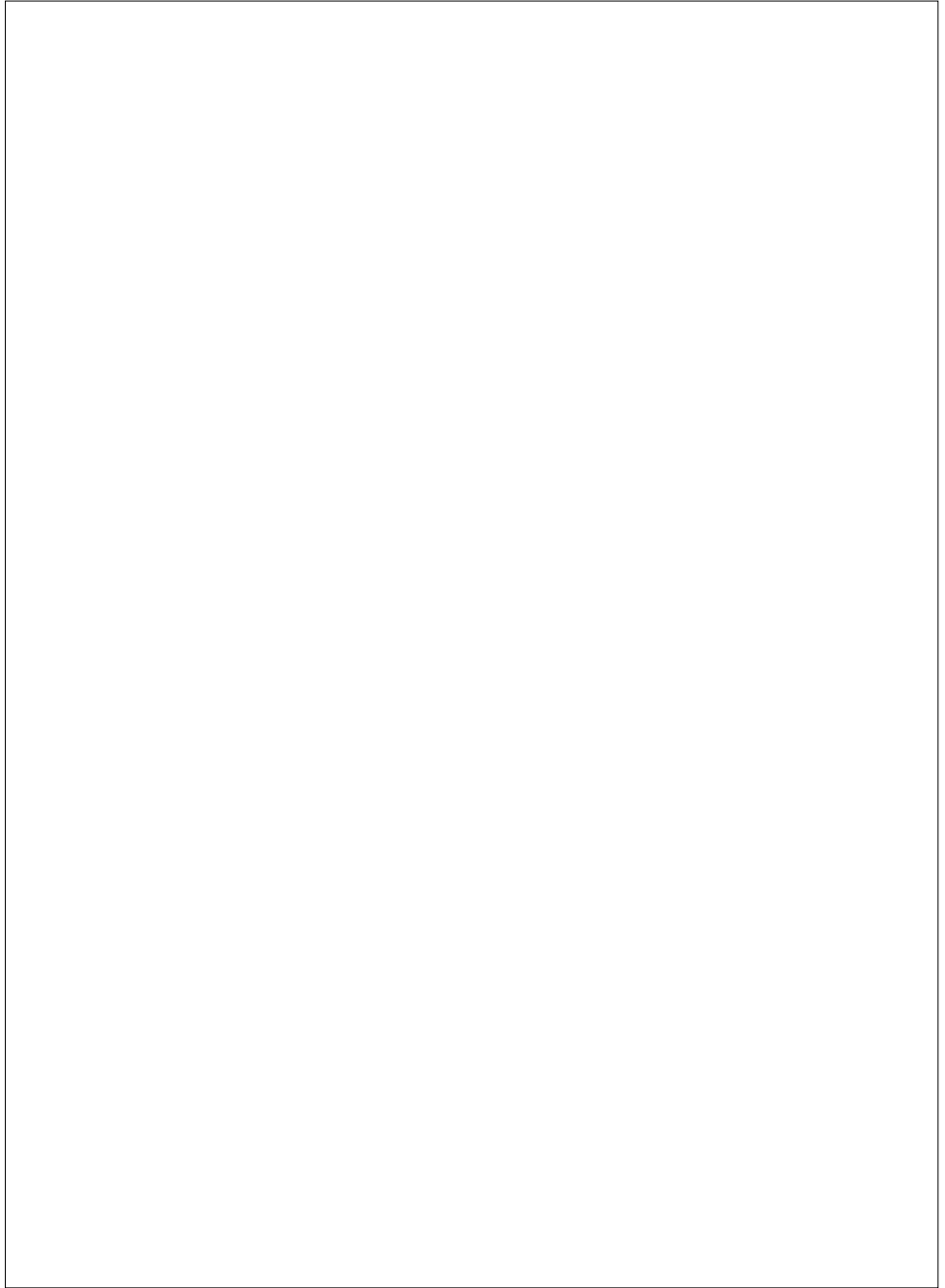

Be sure to save the receipt and attach it to your WARRANTY card when having your equipment repaired at an authorized Sony service station.

Sony Corporation Printed in China

Download from [Www.Somanuals.com](http://www.Somanuals.com). All Manuals Search And Download.

Free Manuals Download Website

<http://myh66.com>

<http://usermanuals.us>

<http://www.somanuals.com>

<http://www.4manuals.cc>

<http://www.manual-lib.com>

<http://www.404manual.com>

<http://www.luxmanual.com>

<http://aubethermostatmanual.com>

Golf course search by state

<http://golfingnear.com>

Email search by domain

<http://emailbydomain.com>

Auto manuals search

<http://auto.somanuals.com>

TV manuals search

<http://tv.somanuals.com>