

Cordless Telephone ***with Answering System***

Operating Instructions

US

*High
Power* **900** MHz

CALLER ID
with call waiting

SPP-A9171

©2000 Sony Corporation

Download from www.Somanuals.com. All Manuals Search And Download.

Owner's Record

The model and the serial numbers are located at the bottom of the unit. Record the serial number in the space provided below. Refer to these numbers whenever you call upon your Sony dealer regarding this product.

Model No. SPP-A9171

Serial No. _____

IMPORTANT SAFETY INSTRUCTIONS

When using your telephone equipment, basic safety precautions should always be followed to reduce the risk of fire, electric shock and injury to persons, including the following:

1. Read and understand all instructions.
2. Follow all warnings and instructions marked on the product.
3. Unplug this product from the wall outlet before cleaning. Do not use liquid cleaners or aerosol cleaners. Use a damp cloth for cleaning.
4. Do not use this product near water, for example, near a bath tub, wash bowl, kitchen sink, or laundry tub, in a wet basement, or near a swimming pool.
5. Do not place this product on an unstable cart, stand, or table. The product may fall, causing serious damage to the product.
6. Slots and openings in the cabinet and the back or bottom are provided for ventilation. To protect it from overheating, these openings must not be blocked or covered. The openings should never be blocked by placing the product on the bed, sofa, rug, or other similar surface. This product should never be placed near or over a radiator or heat register. This product should not be placed in a built-in installation unless proper ventilation is provided.
7. This product should be operated only from the type of power source indicated on the marking label. If you are not sure of the type of power supply to your home, consult your dealer or local power company.
8. Do not allow anything to rest on the power cord. Do not locate this product where the cord will be abused by persons walking on it.
9. Do not overload wall outlets and extension cords as this can result in the risk of fire or electric shock.
10. Never push objects of any kind into this product through cabinet slots as they may touch dangerous voltage points or short out parts that could result in a risk of fire or electric shock. Never spill liquid of any kind on the product.
11. To reduce the risk of electric shock, do not disassemble this product, but take it to a qualified service personnel when some service or repair work is required. Opening or removing covers may expose you to dangerous voltages or other risks. Incorrect reassembly can cause electric shock when the appliance is subsequently used.

12. Unplug this product from the wall outlet and refer servicing to qualified service personnel under the following conditions:

- A. When the power cord or plug is damaged or frayed.
- B. If liquid has been spilled into the product.
- C. If the product has been exposed to rain or water.
- D. If the product does not operate normally by following the operating instructions. Adjust only those controls that are covered by the operating instructions because improper adjustment of other controls may result in damage and will often require extensive work by a qualified technician to restore the product to normal operation.
- E. If the product has been dropped or the cabinet has been damaged.
- F. If the product exhibits a distinct change in performance.

13. Avoid using a telephone (other than a cordless type) during an electrical storm. There may be a remote risk of electric shock from lightning.

14. Do not use the telephone to report a gas leak in the vicinity of the leak.

SAVE THESE INSTRUCTIONS

CAUTION:

To reduce the risk of fire or injury to persons by battery, read and follow these instructions.

- 1. Use only the following type and size battery pack: Sony BP-T31.
- 2. Do not dispose of the battery pack in a fire. The cell may explode. Check with local codes for possible special disposal instructions.
- 3. Do not open or mutilate the battery pack. Released electrolyte is corrosive and may cause damage to the eyes or skin. It may be

toxic if swallowed.

- 4. Exercise care in handling battery pack in order not to short the battery with conducting materials such as rings, bracelets, and keys. The battery or conductor may overheat and cause burns.
- 5. Charge the battery pack provided with or identified for use with this product only in accordance with the instructions and limitations specified in the instruction manual provided for this product.
- 6. Observe proper polarity orientation between the battery pack and battery charger.

INFORMATION FOR GENERAL TELEPHONES

- 1. This equipment complies with Part 68 of the FCC rules. On the bottom of this equipment is a label that contains, among other information, the FCC certification number and ringer equivalence number (REN) for this equipment. If requested, this information must be provided to the telephone company.
- 2. The applicable certification jack (connector) USOC-RJ11C is used for this equipment.
- 3. This equipment is designed to be connected to the telephone network or premises wiring using a compatible modular jack that is Part 68 compliant.

The FCC compliant telephone cord and modular plug is provided with this equipment.

- 4. The REN is used to determine the quantity of devices that may be connected to the telephone line. Excessive RENs on the telephone line may result in the devices not ringing in response to an incoming call. Typically, the sum of the RENs should not exceed five (5.0). To be certain of the number of devices that may be connected to a line, as determined by the total RENs, contact the local telephone company.
- 5. If this equipment (SPP-A9171) causes harm to the telephone network, the telephone company will notify you in advance that temporary discontinuance of service may be required. But if advance notice isn't practical, the telephone company will notify the customer as soon as possible. Also, you will be advised of your right to file a complaint with the FCC if you believe it is necessary.

6. The telephone company may make changes in its facilities, equipment, operations or procedures that could affect the operation of the equipment. If this happens the telephone company will provide advance notice so you can make necessary modifications to maintain uninterrupted service.
7. If trouble is experienced with this equipment (SPP-A9171), for repair or warranty information, please contact Sony Direct Response Center: Tel 1-800-222-7669. If the equipment is causing harm to the telephone network, the telephone company may request that you disconnect the equipment until the problem is resolved.
8. All repairs will be performed in an authorized Sony service station.
9. This equipment cannot be used to party lines or coin lines.
10. This equipment is hearing aid compatible.

If your telephone is equipped with automatic dialers

When programming emergency numbers and (or) making test calls to emergency numbers:

1. Remain on the line and briefly explain to the dispatcher the reason for the call.
2. Perform such activities in the off-peak hours, such as early morning or late evenings.

Caution

You are cautioned that any changes or modifications not expressly approved in this manual could void your authority to operate this equipment.

Note

This equipment has been tested and found to comply with the limits for a Class B digital device, pursuant to Part 15 of the FCC Rules. These limits are designed to provide reasonable protection against harmful interference in a residential installation. This equipment generates, uses and can radiate radio frequency energy and, if not installed and used in accordance with the instructions, may cause harmful interference to radio communications. However, there is no guarantee that interference will not occur in a particular installation. If this equipment does cause harmful interference to radio or television reception, which can be determined by turning the equipment off and on, the user is encouraged to try to correct the interference by one or more of the following measures:

- Reorient or relocate the receiving antenna.
- Increase the separation between the equipment and receiver.
- Connect the equipment into an outlet on a circuit different from that to which the receiver is connected.
- Consult the dealer or an experienced radio/TV technician for help.

Table of contents

Getting Started

- 6 Read this first
 - 7 Step 1: Checking the package contents
 - 8 Step 2: Setting up the base unit
 - 11 Step 3: Preparing the battery pack
 - 14 Step 4: Entering the area code
 - 17 Changing the language of the display and the voice guidance
 - 18 Identifying the parts
-

Basics

- 22 Making calls
 - 24 Redialing
 - 25 Receiving calls
-

Telephone Features

- 26 One-touch dialing
- 26 Storing phone numbers
- 27 Making calls with one-touch dialing
- 28 Phone Directory
- 28 Storing phone numbers and names
- 29 Changing a stored name and/or phone number
- 30 Erasing a memory location
- 31 Making calls from the Phone Directory
- 32 Paging

Answering Machine Features

- 33 Preparing the answering machine
- 33 Setting the day and time
- 35 Recording the greeting
- 38 Selecting the ring time
- 39 Selecting the recording quality
- 40 Selecting the answering mode

- 41 Turning on the answering function
- 43 Playing back messages
- 45 Erasing messages
- 46 Screening incoming calls
- 47 Recording a memo
- 49 Operating from an outside phone
- 49 Setting the remote ID code (security code)
- 50 Picking up new messages

Caller ID Features

- 51 Understanding the Caller ID service
- 51 When you receive a call
- 52 Looking at the Caller ID list
- 52 Viewing the Caller ID list
- 53 Erasing data from the Caller ID list
- 55 Using the Caller ID list
- 55 Calling back a number from the Caller ID list
- 56 Storing a number of the Caller ID list into the Phone Directory
- 57 To change the number of digits of the phone number
- 59 Using "Caller ID with call waiting" service

Additional Information

- 60 Mounting the base unit on a wall
 - 61 Notes on power sources
 - 62 Maintenance
 - 63 Troubleshooting
 - 68 Specifications
 - 69 Index
-

Back cover LIMITED WARRANTY

Read this first

Before you use your phone, you must set it up. Here's a quick way to set up your phone: Steps 1, 2, 3 and 4.

Step 1 (page 7)

First, unpack the phone and the supplied accessories.

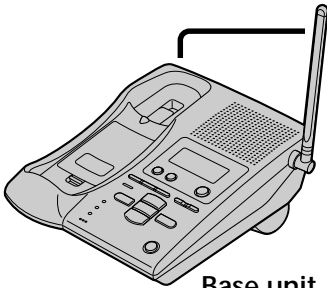

Base unit

Step 2 (pages 8 to 10)

Next, you need to do three things to set up the base unit, including finding the best location for the base unit.



Handset

Step 3 (pages 11 to 12)

Then, you need to insert the battery pack into the handset and charge it for more than 12 hours.

Step 4 (pages 14 to 16)

Finally, you need to enter the area code to use the Caller ID service.

That's it!

If you want to change the language of the display and the voice guidance, follow the procedure in "Changing the language of the display and the voice guidance" on page 17.

Step 1

Checking the package contents

Make sure you have received the following items in the package.
If anything is missing, contact your local Sony dealer.

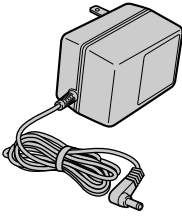

AC power adaptor (AC-T46)

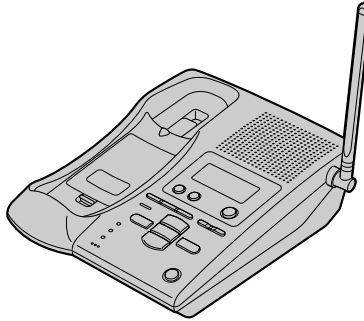

Base unit

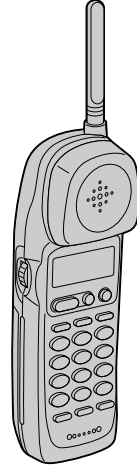

Handset

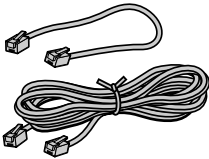

Telephone line cords (2)



Wall bracket/stand
for base unit

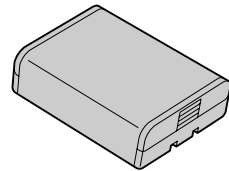

Rechargeable battery
pack (BP-T31)

Step 2

Setting up the base unit

Do the following steps:

- Choose the best location
- Connect the base unit
- Choose the dialing mode

Choose the best location

Where you place the base unit affects the reception quality of the handset.

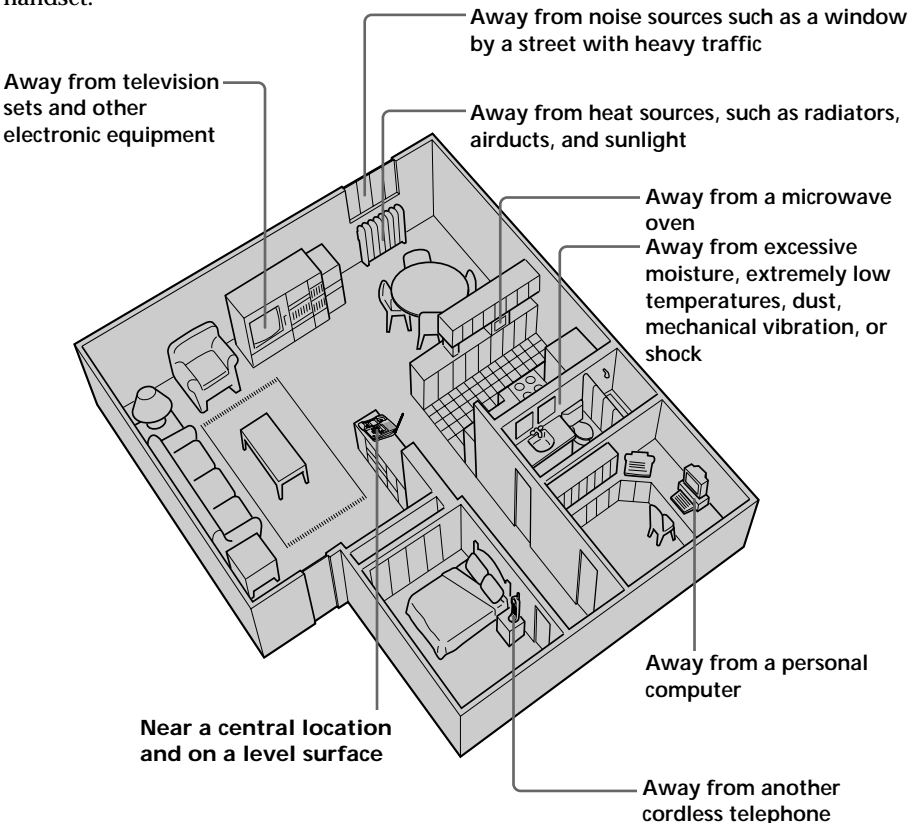

- CAUTION:**
- Should you experience intermittent loss of audio during a conversation, try moving closer to the base or move base unit away from other noise sources.
 - The cordless telephone operates at a frequency that may cause interference to nearby TVs and VCRs; the base unit should not be placed near or on the top of a TV or VCR; and, if interference is experienced, moving the cordless telephone farther away from the TV or VCR will often reduce or eliminate the interference.

Connect the base unit

If you want to hang the base unit on the wall, see page 60.

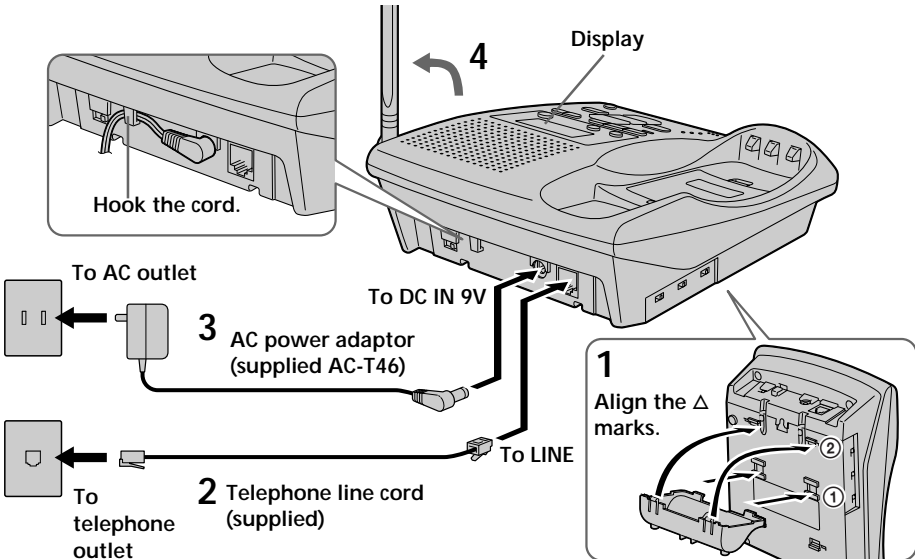

- 1** Attach the wall bracket to the bottom of the base unit as illustrated to use it as a stand.
- 2** Connect the telephone line cord to the LINE jack and to a telephone outlet.
- 3** Connect the AC power adaptor to the DC IN 9V jack and to an AC outlet.
“P” flashes on the display.
- 4** Raise the antenna. Make sure it points toward the ceiling.

continued

Step 2: Setting up the base unit (continued)

Notes

- Use only the supplied AC-T46 AC power adaptor. Do not use any other AC power adaptor.
- Connect the AC power adaptor to a continuous power supply.
- Place the base unit close to the AC outlet so that you can unplug the AC power adaptor easily.

Polarity of the plug



Tip

If your telephone outlet is not modular, contact your telephone service company for assistance.

Modular



Choose the dialing mode

For the telephone to work properly, select an appropriate dialing mode (tone or pulse).

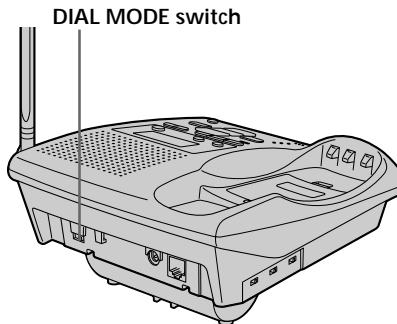

Depending on your dialing system, set the DIAL MODE switch as follows:

If your dialing system is	Set the switch to
Tone	T
Pulse	P

If you aren't sure of your dialing system

Make a trial call with the DIAL MODE switch set to T. If the call connects, leave the switch as is; otherwise, set to P.

Step 3

Preparing the battery pack

Charge the battery pack for more than 12 hours before you start using your phone.

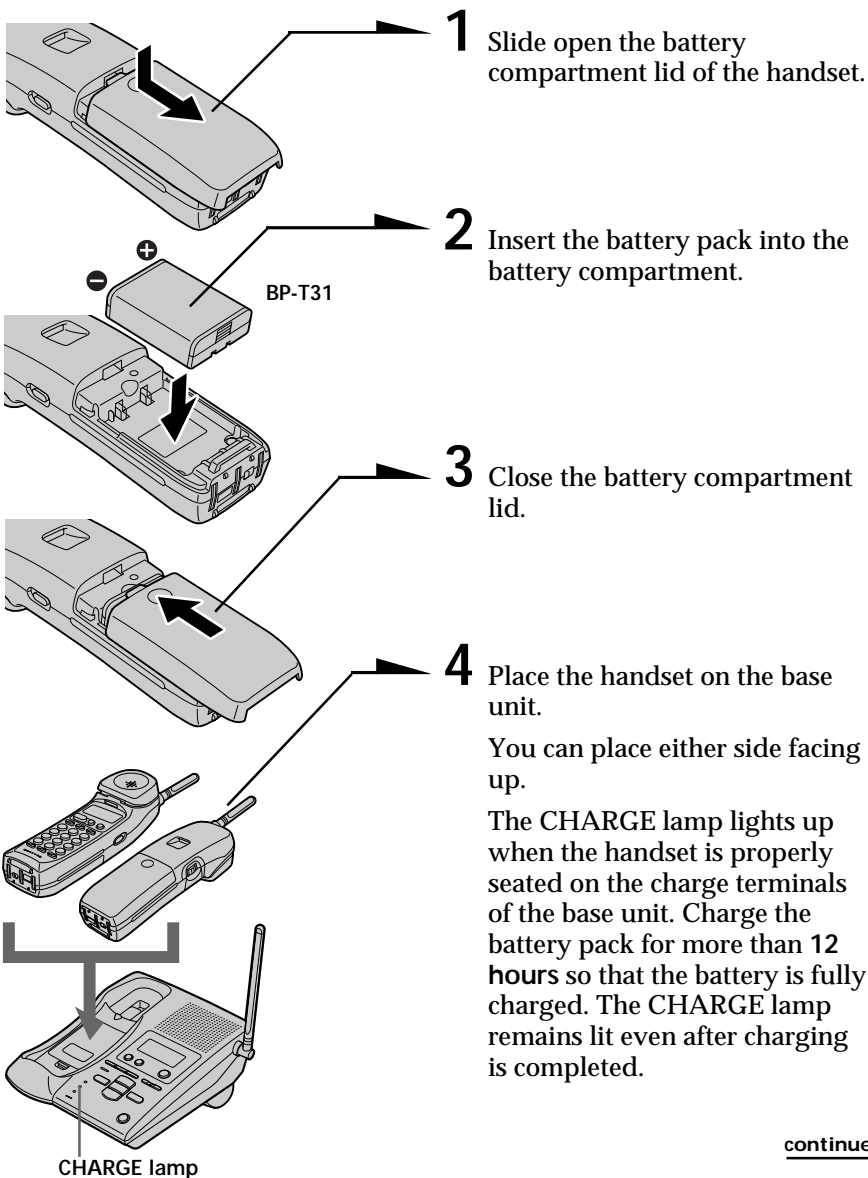

continued

Step 3: Preparing the battery pack (continued)

Battery duration

A fully charged battery pack lasts for about:

- Approx. 6 hours when you use the handset continuously
- Approx. 7 days when the handset is in standby mode.

Notes

- The battery pack will gradually discharge over a long period of time, even if not in use.
- If you leave the battery pack in the handset without charging it, the battery pack will be completely discharged.
It may require several times of charging to recover to its full capacity.
- While charging, the battery pack warms up. This is not a malfunction.

To obtain the best performance from the battery

Do not place the handset on the base unit after each call. The battery works best if the handset is returned to the base unit after two or three calls. However, do not leave the handset off the base unit for a long period of time as this will completely discharge the battery pack.

When to purchase a new battery pack

If the battery lasts only a few minutes even after **12 hours** of charging, the usable life of the battery has expired and needs replacement. Contact your local Sony authorized dealer or service center, and ask for Sony **BP-T31** rechargeable battery pack.

Note

Battery life may vary depending on usage condition and ambient temperature.

Handset spare battery usage

As only one battery pack is supplied with this unit, it is necessary to purchase an additional battery pack (optional) for use as a handset spare battery pack.

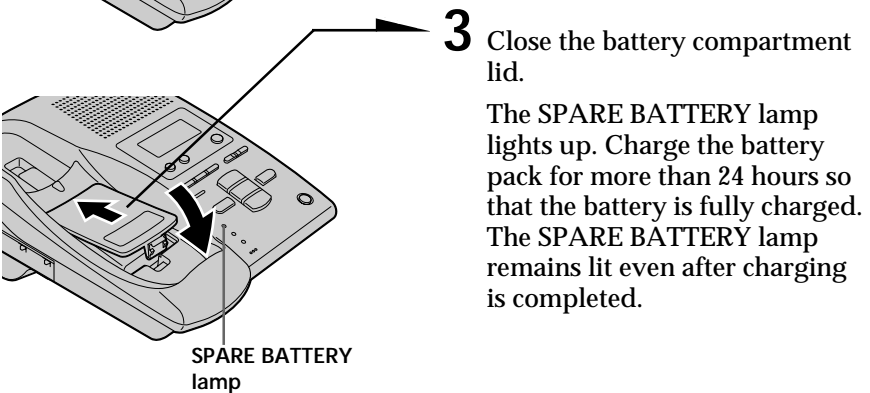
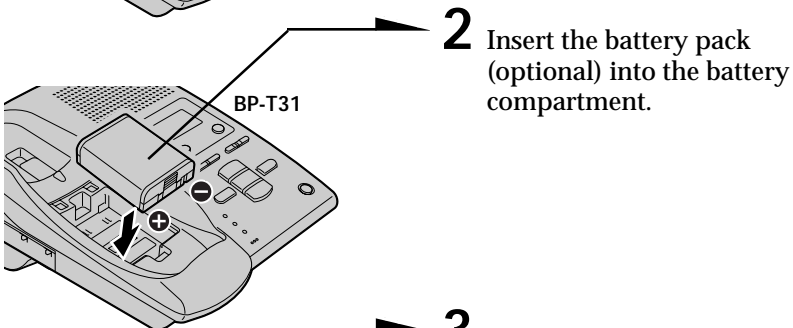
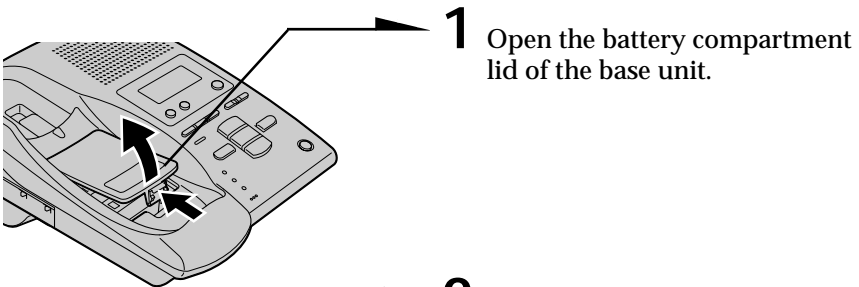

Step 4

Entering the area code

When you use this phone for the first time, or move to an area that has a different area code, you must enter the area code. Otherwise, you cannot use some functions of this phone and the Caller ID functions.

This is also necessary because the phone must be able to select an area code to properly dial call from the Caller ID list.

Depending on your region, enter 3-digit area code as follows:

Case 1.

If 7-digit dialing (no area code) is accepted for local calls in your area, see "To enter your home area code" below.

If you live in an area where calls from or to other local areas can also be made by 10-digit dialing (area code + number), you can register up to 5 local area codes with this telephone to take advantage of this system. See "To enter the local area code (For 10 digits phone number users)" on page 15.

Case 2.

If 10-digit dialing (area code + number) is required for all local calls in your area, see "To enter the local area code (For 10 digits phone number users)" on page 15.

To enter your home area code

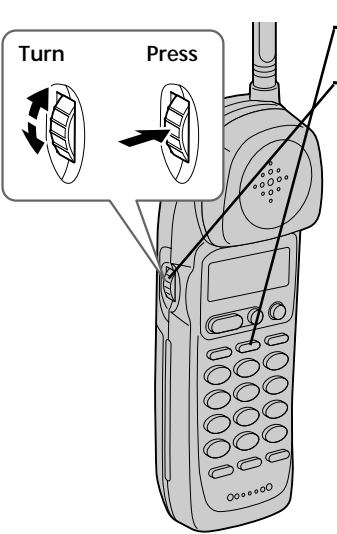

1 Press **PGM**.

2 Turn Jog Dial down to make "HOME AREA CODE" flash.

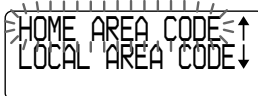

3 Press Jog Dial.
"ENTER AREA CODE" appears on the display.



4 Enter the three digits of your home area code using the dialing keys.

5 Press **PGM**.

You hear a long confirmation beep.

Notes

- If the home area code is already entered, it appears on the display in step 3. To enter a different home area code, see “To change the home area code” below.
- Do not allow more than 20 seconds to elapse during the operation procedure.
- If the area code has not been entered, calling back from the Caller ID list and storing the Caller ID data into the Phone Directory cannot be performed.

Tips

- You may press Jog Dial instead of (PGM) in step 5.
- To check the current home area code, perform steps 1 to 3. The home area code appears on the display for about 20 seconds.

To change the home area code

1 Perform steps 1 to 3 on page 14.

The current home area code appears on the display.

2 Turn Jog Dial down to erase the current home area code.

3 Enter a new home area code using the dialing keys.

4 Press (PGM).

You hear a long confirmation beep.

To erase the home area code

You can erase the home area code. Perform steps 1 and 2 above, then press (PGM).

The home area code will be erased, and you hear a long confirmation beep.

To enter the local area code (For 10 digits phone numbers users)

If a call matches one of the local area codes you entered, the phone number will be registered with 10 digits in the Caller ID list (area code + number). If a call does not match one of the local area codes you entered, the phone number will be registered with 11 digits in the Caller ID list (1 + area code + number). Some regions of the country allow you to have more than one local area code. (Up to five local area codes can be entered in this phone.)

1 Press (PGM).

2 Turn Jog Dial down to make “LOCAL AREA CODE” flash.



3 Press Jog Dial.

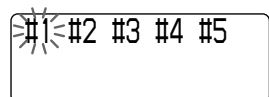

continued

Step 4: Entering the area code (continued)

- 4 Select the number ("#1" to "#5") to enter the local area code by turning Jog Dial.
- 5 Press Jog Dial.
"ENTER AREA CODE" appears on the display.
- 6 Enter the three digits of the local area code using the dialing keys.
- 7 Press (PGM).
You hear a long confirmation beep.

Notes

- If the local area code is already entered, it appears on the display in step 4. To enter a different local area code, see "To change the local area code" below.
- Do not allow more than 20 seconds to elapse during the operation procedure.

Tips

- You may press Jog Dial instead of (PGM) in step 7.
- To check the current local area code, perform steps 1 to 4. The local area code appears on the display for about 20 seconds.

To change the local area code

- 1 Perform steps 1 to 5 on pages 15 to 16.
The current local area code appears on the display.
- 2 Turn Jog Dial down to erase the current local area code.
- 3 Enter a new local area code using the dialing keys.
- 4 Press (PGM).
You hear a long confirmation beep.

To erase the local area code

You can erase the local area code. Perform steps 1 and 2 above, then press (PGM).

The local area code will be erased, and you hear a long confirmation beep.

Changing the language of the display and the voice guidance

You can choose English or Spanish as the display and the voice guidance language by following the procedure below.

To change the language from Spanish to English

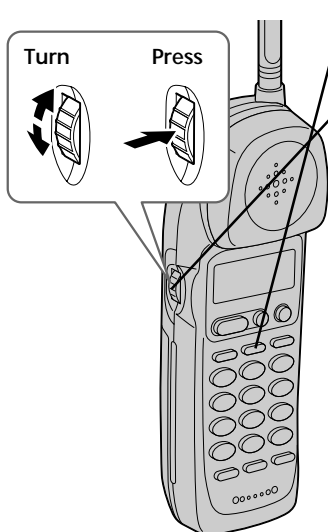

- 1 Press (PGM).
- 2 Turn Jog Dial down to make “ELEGIR IDIOMA” flash, and then press Jog Dial.

ENGLISH=ESPAÑOL
- 3 Press Jog Dial.

ENGLISH=NO=YES
- 4 Select “YES” by turning Jog Dial to change the language, and then press Jog Dial.
You will hear a long confirmation beep.
- 5 Replace the handset on the base unit.

To change the language from English to Spanish

- 1 Press (PGM).
- 2 Turn Jog Dial down to make “LANGUAGE SELECT” flash, and then press Jog Dial.
- 3 Select “ESPAÑOL” by turning Jog Dial, and then press Jog Dial.
- 4 Select “SÍ” by turning Jog Dial to change the language, and then press Jog Dial.
You will hear a long confirmation beep.
- 5 Replace the handset on the base unit.



Note

Do not allow more than 20 seconds to elapse during the operation procedure.

Getting Started

Identifying the parts

Refer to the pages indicated in parentheses for details.

Base Unit

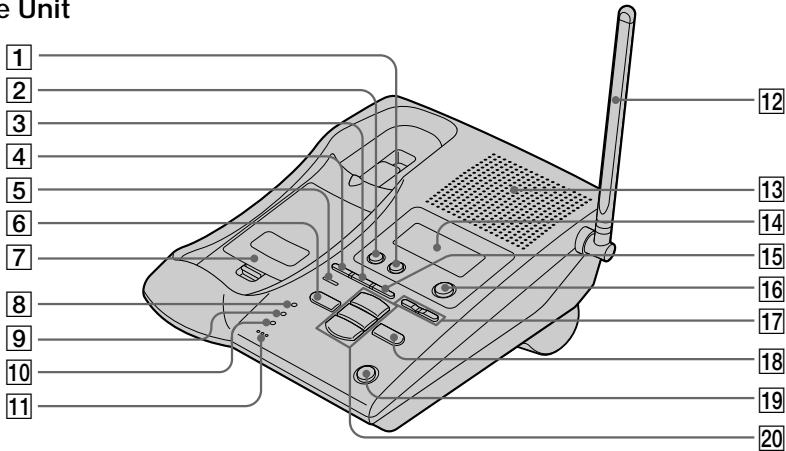

- 1 ERASE button** (p. 37, 45)
Erases the recorded greeting or messages.
- 2 MEMO button** (p. 47)
Records a memo message.
- 3 GREETING REC button** (p. 35)
Press to record a greeting.
- 4 GREETING PLAY button** (p. 37)
Plays back the greeting message.
- 5 NEW CALL lamp** (p. 52)
Flashes when there is a "NEW" data in the Caller ID list.
- 6 ◀◀ REPEAT/REVIEW button** (p. 44)
Press to repeat the current message or go back to the previous message. Keep the button pressed for a playback review of the current message.
- 7 Battery compartment** (p. 13)
- 8 SPARE BATTERY lamp** (p. 13)
Lights while the spare battery is being charged.
- 9 CHARGE lamp** (p. 11)
Lights while the battery is being charged.
- 10 IN USE lamp** (p. 22)
Lights when the handset is in use.
- 11 MIC (microphone)** (p. 35, 47)
- 12 Antenna** (p. 9, 60)
- 13 Speaker**
- 14 Display** (p. 19, 43)
- 15 TIME button** (p. 34)
Press to check the current time.
- 16 ANSWER ON/OFF button** (p. 41)
Turns the answering function on or off. Lights when the answering function is on, and flashes when a new message is recorded.
- 17 VOLUME +/- buttons** (p. 44)
Adjusts the speaker volume.
- 18 ▶▶ SKIP/QUICK button** (p. 44)
Press to skip to the next message. Keep the button pressed for quick playback of messages.

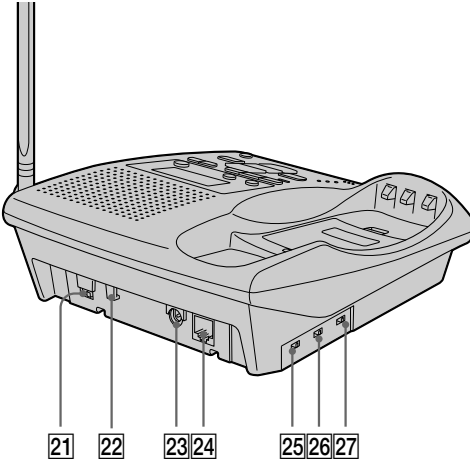

Display

The display on the base unit shows the answering machine operation.

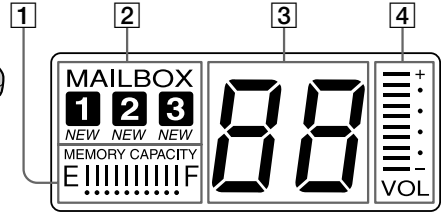

- 19 HANDSET LOCATOR button** (p. 32)
Allows you to page the handset.
- 20 PLAY/STOP (MAILBOX 1, 2, 3) buttons** (p. 43)
Plays back the messages in each mail box.
- 21 DIAL MODE switch** (p. 10)
Selects pulse or tone dialing.
- 22 Hook for AC power adaptor cord** (p. 9)
- 23 DC IN 9V jack** (p. 9)
- 24 LINE (telephone line) jack** (p. 9)
- 25 AUDIBLE INDICATOR switch** (p. 40)
Selects the answering mode.
- 26 REC. QUALITY switch** (p. 39)
Selects the recording quality.
- 27 RINGER SELECT switch** (p. 38)
Selects the ring time.

- 1 Memory capacity indicator** (p. 40)
Indicates the available memory capacity, from E (Empty) to F (Full), for recording. The bars increase as the available memory capacity decreases.
- 2 MAILBOX indicator** (p. 43)
Displayed when there are messages recorded and when the messages are being played back.
“NEW” flashes when there are new messages recorded.
- 3 Message counter** (p. 43)
Indicates the number of new messages recorded. “A” appears in the announcement only mode. “F” appears when there is no space to record messages. “P” appears when the power is turned on.
- 4 VOL (volume) indicator**
Indicates the speaker volume. The bars increase as the volume is turned up.

continued

Identifying the parts (continued)

Handset

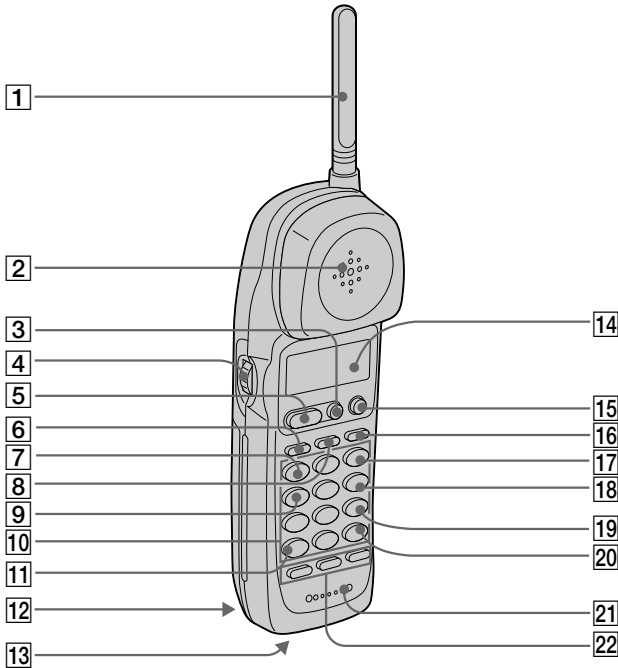

- 1** **Antenna**
- 2** **Speaker [EZfit]** (p. 23)
- 3** **OFF button** (p. 22)
Allows you to disconnect the call.
- 4** **Jog Dial** (p. 14, 26, 52)
- 5** **TALK button** (p. 22)
Lets you make or receive a call.
- 6** **REMOTE button** (p. 33)
Used to display the answering machine function menu.
- 7** **◀◀ REPEAT button** (p. 44)
Press to repeat the current message or go back to the previous message.
- 8** **PGM (Program) button** (p. 14, 26, 28)
Used to store numbers for one-touch dialing or in Phone Directory.
- 9** **REVIEW button** (p. 44)
Keep the button pressed for a playback review of the current message.
- 10** **Dialing keys** (p. 22)
- 11** **✳ TONE button** (p. 22)
Allows you to switch temporarily to tone dialing.
- 12** **Battery compartment** (p. 11)
- 13** **RING switch** (p. 25)
Switches the ringer to on/off.
- 14** **Display** (p. 51)

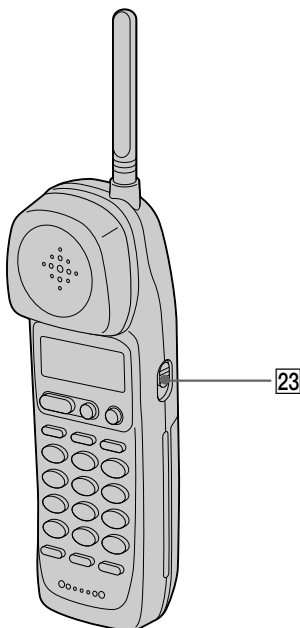

- 15 CALL WAITING/FLASH button** (p. 22, 25, 59)
Switches to a second call if you have “call waiting” service, or lets you make a new call.
- 16 REDIAL/PAUSE button** (p. 24, 27)
Redials the last number called/ inserts a pause in the dialing sequence.
- 17 ►► SKIP button** (p. 44)
Press to skip to the next message.
- 18 QUICK button** (p. 44)
Keep the button pressed for quick playback of messages.
- 19 ERASE button** (p. 37, 45)
Erases the recorded greeting or messages.
- 20 # button** (p. 57)
Used to change the number of digits of the phone number in the Caller ID list.
- 21 Microphone**
- 22 ONE-TOUCH DIAL (A, B, C) buttons** (p. 27)
- 23 VOL (volume) switch** (p. 25)
Adjust the handset volume.

Making calls

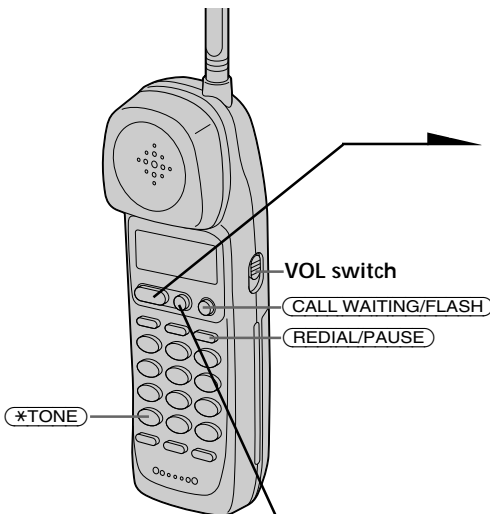

- 1** Pick up the handset from the base unit.
- 2** Press **TALK** and wait until “TALK” appears on the display. The display also shows the talk time in hours, minutes and seconds.

The dialing keys light up.

The IN USE lamp on the base unit lights up.

You then hear a dial tone. If you hear five short error beeps and “OUT OF RANGE” appears on the display, move closer to the base unit.
- 3** Dial the phone number.
- 4** When you’re done talking, press **OFF** or replace the handset on the base unit.

The display turns off.

Additional tasks

To	Do this
Adjust the handset volume	Set the VOL switch to H (high), M (middle) or L (low).
Switch to tone dialing temporarily	Press *TONE after you’re connected. The line will remain in tone dialing until disconnected.
Switch to another call (“call waiting” service*)	Press CALL WAITING/FLASH . Press CALL WAITING/FLASH again to return to the first caller.

* You need to subscribe to this service from your telephone company.

Notes

- When you increase the sound volume, in some cases the background noise may be increased as well. You should adjust the volume accordingly.
- If the handset beeps every second during conversation and “OUT OF RANGE” appears on the display, move closer to the base unit; otherwise, the call will be disconnected after one minute.
- While the base unit is in use, you cannot make a call with the handset. If you press (TALK), “BASE UNIT IN USE” appears on the display and you will hear a busy tone.

EZfit

The “EZfit” adjusts to fit any shape ear, thereby ensure clear voice reception.

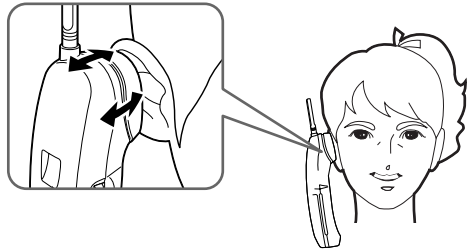

If the battery becomes weak during a call

The handset will beep twice per second,  and “BATTERY LOW” appear on the display. Finish your call and charge the battery pack.

For optimum performance, charge the battery for a full 12 hours.

Note that during the initial charge time (approx. 10 minutes),  and “BATTERY LOW” appear on the display and the phone cannot be used.

After  and “BATTERY LOW” go off, you **may** be able to use the phone, but the battery duration will be **very short**; thus it is recommended that you **fully charge** the battery before next use.

continued

Redialing

- 1 Press **TALK** and wait until “TALK” appears on the display.
- 2 Press **REDIAL/PAUSE** to redial the number last dialed.

Note

If the number exceeds 32 digits, five short error beeps will alert you that the number cannot be dialed.

To check the phone number before redialing

While the handset is not in use, press **REDIAL/PAUSE**.

The number last dialed is displayed for 20 seconds.

To dial the number, press **TALK** while the number is displayed.

Note

The number will not be displayed if the last dialed number exceeds 32 digits or if it is erased.

To erase the last phone number dialed

While the handset is not in use, press **REDIAL/PAUSE** twice.

The number will be erased from the memory, and you will hear a long confirmation beep.

Receiving calls

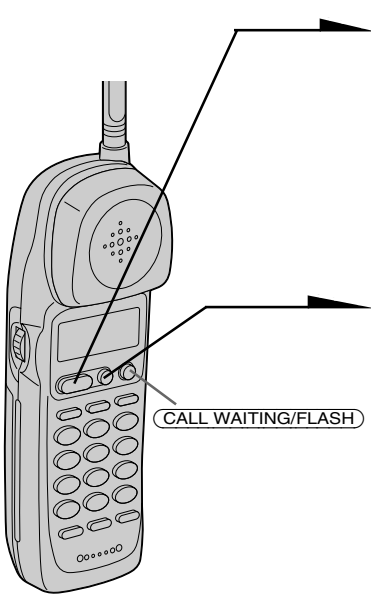

1 When you hear the phone ring, pick up the handset from the base unit, and press **(TALK)** .
“TALK” appears on the display and the display also shows the talk time in hours, minutes and seconds.

2 When you're done talking, press **(OFF)** or replace the handset on the base unit.

The display turns off.

Tip

If you have subscribed to the Caller ID service;

- the caller's number and/or name appears on the display when you receive a call (see page 51)
- the ringer sound changes to a higher tone if the call matches the number stored on ONE-TOUCH DIAL buttons or in the Phone Directory (memory match function; see page 51).

To switch to another call (“call waiting” service*)

Press **(CALL WAITING/FLASH)** .

Press the button again to get back to the first caller.

* You need to subscribe to the service from your telephone company.

To turn the ringer off

Set the RING switch on the bottom to OFF.

The handset won't ring. You can still make calls, and also receive calls if another telephone connected to the same line rings to inform you on incoming calls. You can also page the handset from the base unit.

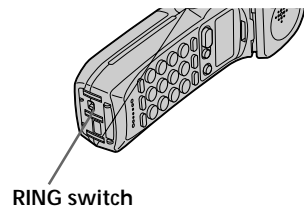

One-touch dialing

You can dial with one touch of a key by storing a phone number on a one-touch dialing button.

Storing phone numbers

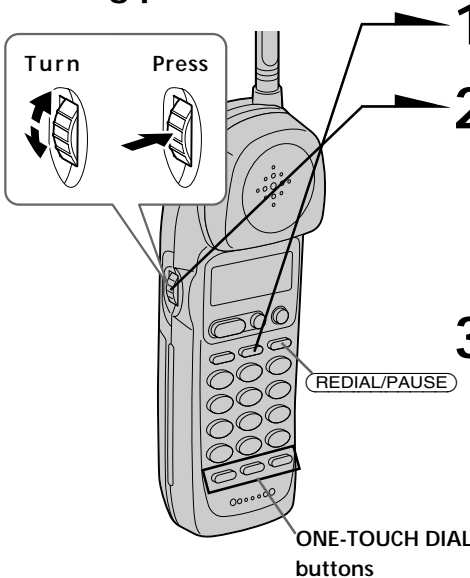

1 Press **PGM**.

2 Turn Jog Dial down to make “ONE-TOUCH A” to “ONE-TOUCH C” flash.



3 Press Jog Dial.

You hear a confirmation beep.



If a number is stored, it appears on the display. To store a new number, turn Jog Dial down to erase it.

4 Enter the phone number you want to store.

You can enter up to 20 digits, including a tone and a pause, each of which is counted as one digit.

When the phone number of 17 digits or more has been entered, the phone number appears in two lines.

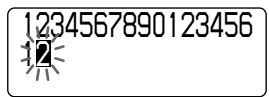

5 Press **PGM**.

You hear a long confirmation beep, and the number is stored.

The display turns off.

Note

Do not allow more than 20 seconds to elapse during the operation procedure.

Tips

- When the phone number of 17 digits or more has been entered, “-” is displayed next to 15th digit in step 5.
- If you have entered a wrong number in step 4 and have not pressed **(PGM)** (step 5) yet, just turn Jog Dial down to erase it. Then enter the correct number.
- You may press Jog Dial instead of **(PGM)** in step 5.

To store a number to be dialed via Private Branch Exchange (PBX)

Before entering a phone number in step 4 on page 26, do as follows:

- 1 Enter the outside line access digit (e.g., 9).
- 2 Press **(REDIAL/PAUSE)**.

To change a stored number

- 1 Perform steps 1 to 3 on page 26.
The current number appears on the display.
- 2 Turn Jog Dial down to erase the current number.
- 3 Enter a new number.
- 4 Press **(PGM)**.

Note

You can replace the stored number with a new number, but you cannot just erase it.

Making calls with one-touch dialing

- 1 Press **(TALK)** and wait until “TALK” appears on the display.
- 2 Press one of the ONE-TOUCH DIAL buttons (**(A)** to **(C)**).

The phone number stored on the one-touch dialing button will appear on the display and will be dialed.

To check the phone number before one-touch dialing

While the handset is not in use, press one of the ONE-TOUCH DIAL buttons (**(A)** to **(C)**).

The number stored on the button appears on the display for 20 seconds. To dial the number, press **(TALK)** while the number is displayed.

Tip

When the phone number of 17 digits or more has been entered, “-” is displayed next to 15th digit and then the all digits are displayed in two lines after about two seconds.

Phone Directory

You can dial a number by scrolling through the Phone Directory.
You can store up to 100 numbers.

Storing phone numbers and names

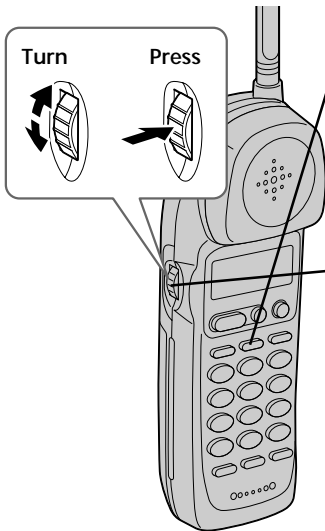

Example: to store “SONY” “123-4567”.

1 Press **PGM**.

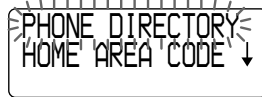

2 Press Jog Dial.
“ENTER NAME” appears.

3 Enter the name using the dialing keys. You can enter up to 15 characters.

Press a dialing key until the desired character appears. (See the character table for details.)

Enter successive characters in the same way.

To enter two characters assigned to the same key, or to enter a “space”, turn Jog Dial up to move the cursor to the right.

Example: to enter “SONY”, press **7** four times (S), press **6** three times (O), turn Jog Dial up to move the cursor, press **6** twice (N), and press **9** three times (Y).

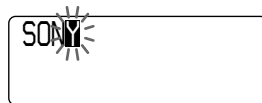

Character table

Key	Character
①	1
②	A → B → C → 2
③	D → E → F → 3
④	G → H → I → 4
⑤	J → K → L → 5
⑥	M → N → O → 6
⑦	P → Q → R → S → 7
⑧	T → U → V → 8
⑨	W → X → Y → Z → 9
⑩	0
*	*
#	& → ' → , → - → . → #

4 Press **(PGM)**.

“ENTER NUMBER” appears.

5 Enter the phone number.

You can enter up to 20 digits, including a tone and a pause, each of which is counted as one digit.

When the phone number of 17 digits or more has been entered, the phone number appears in two lines.

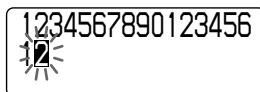

6 Press **(PGM)**.

You hear a long confirmation beep, and the name and the number are stored. The display turns off.

Notes

- If you try to save a 101st phone number, you will hear five short error beeps and “MEMORY FULL” will be displayed. You cannot store the phone number. To store another phone number, erase one of the stored phone numbers (see page 30).
- Do not allow more than 20 seconds to elapse during the operation procedure.

Tips

- When the phone number of 17 digits or more has been entered, “-” is displayed next to 15th digit in step 6.
- If you have entered a wrong name or number in step 3 or 5, turn Jog Dial down to erase it. Then enter the correct name or number.
- You may press Jog Dial instead of **(PGM)** in steps 4 and 6.
- To store a number to be dialed via PBX, follow the steps on page 27 when entering a phone number.

Changing a stored name and/or phone number

1 Display the name and phone number you want to change by doing steps 1 and 2 on page 31.

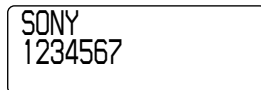

2 Press Jog Dial.



continued

Phone Directory (continued)

- 3** Turn Jog Dial up to make “EDIT” flash and press Jog Dial.

The cursor flashes at the last character of the name.

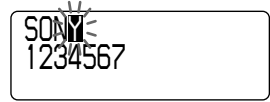

- 4** Turn Jog Dial down to erase the characters and enter the new name.

If you want to change only the number, skip this step.

- 5** Press Jog Dial.

The cursor flashes at the last digit of the phone number.



- 6** Turn Jog Dial down to erase the number and enter the new number.

If you don't want to change the number, skip this step.

- 7** Press Jog Dial.

You hear a long confirmation beep and the name and/or the number is changed.

Tip

When the phone number of 17 digits or more has been entered, “-” is displayed next to 15th digit and then the all digits are displayed in two lines after about two seconds.

Erasing a memory location

- 1** Display the name and phone number you want to erase by doing steps 1 and 2 on page 31.

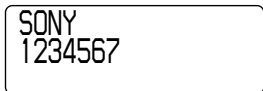

- 2** Press Jog Dial.



- 3** Turn Jog Dial up to make “ERASE” flash and press Jog Dial.



- 4** Turn Jog Dial up to make “YES” flash, then press Jog Dial.

You hear a long confirmation beep and the memory location is erased.

Making calls from the Phone Directory

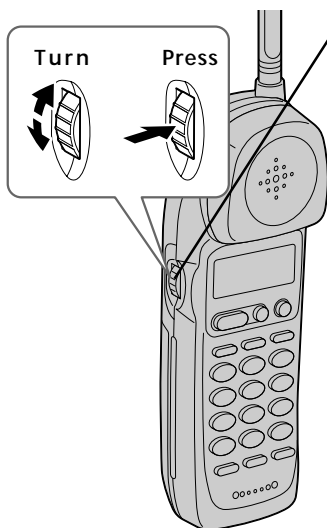

1 Press Jog Dial.
“PHONE DIRECTORY” appears on the display.

2 Display the name and phone number you want to call.
To search in alphabetical order: Turn Jog Dial up or down.
To search by entering the initial character: Press the dialing key of the desired character, then turn Jog Dial.

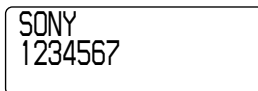

3 Press Jog Dial.



4 Press Jog Dial again.
The phone number will be dialed.

Tips

- You may press **TALK** to make a call instead of doing steps 3 and 4.
- When the phone number of 17 digits or more has been entered, “-” is displayed next to 15th digit and then the all digits are displayed in two lines after about two seconds.

About the search order

The names appear in the following order when you turn Jog Dial up or down.

- Alphabetical order: ABC...XYZ ↔ symbols ↔ * ↔ # ↔ 0 - 9
- Initial character: To search for “SONY” for example, press **7** and then turn Jog Dial to search through the names starting with P, Q, R, S or 7.

Paging

You can page the handset from the base unit.

Note that you cannot page if the handset is in use.

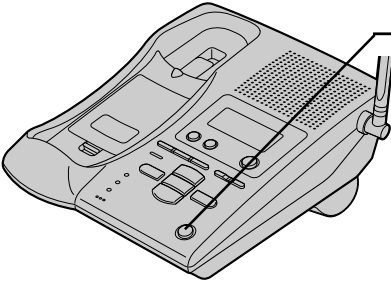

To Page

Press **HANDSET LOCATOR**.

The handset rings for about one minute.

To stop ringing, press **TALK** or **OFF** on the handset.

Tip

You can page the handset even when its RING switch is set to OFF.

Preparing the answering machine

Setting the day and time

Set the day and time so that you can stamp day and time for the incoming messages. You'll hear the recorded day and time when you play back messages.

Setting the day and time is only possible on the handset.

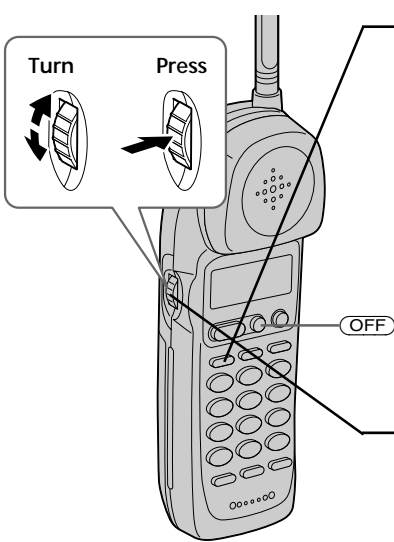

- 1 Press **REMOTE** and wait until the answering machine function menu appears on the display.

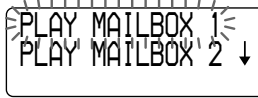

If you hear five short error beeps and "OUT OF RANGE" appears on the display, move closer to the base unit.

- 2 Turn Jog Dial down to make "SET DAY & TIME" flash, and then press Jog Dial.

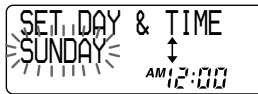

- 3 Set the correct day of the week by turning Jog Dial, and then press Jog Dial.



continued

Preparing the answering machine (continued)

- 4** Set the hour (1 to 12) and choose “AM” or “PM” by turning Jog Dial, and then press Jog Dial.

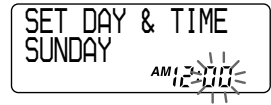

- 5** Set the minute (00 to 59) by turning Jog Dial, and then press Jog Dial.

You hear a long confirmation beep. Then the phone starts counting time.

- 6** Press **OFF**.

Notes

- Do not allow more than 20 seconds (or 60 seconds when setting the minute) to elapse during the operation procedure.
- If a power interruption occurs, the day and time will be erased.

To check the current time

Press **TIME** on the base unit. You hear the current day and time.

If you want to check the current time with the handset, perform steps 1 and 2 on page 33. The current day and time appear on the display.

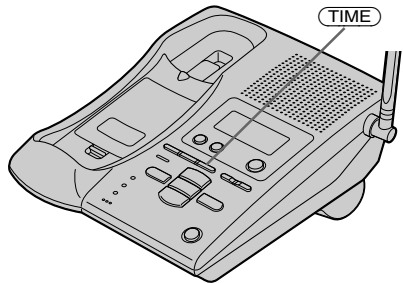

Note

If the current day and time are not set, you will not hear a time stamp when you play back recorded messages. If you try to check the current time with the base unit, you will hear five short error beeps.

Recording the greeting

This answering machine has prerecorded greetings (see page 37). However, you can record your own greeting.

The greeting must be between two seconds and four minutes long.

You can record only one greeting, and it is used regardless of the answering mode (“normal” and “announcement only” modes. See page 40). Therefore, if you decide to change the mode, make sure that you record a new greeting to match the answering mode.

You can record the greeting on both the base unit and the handset.

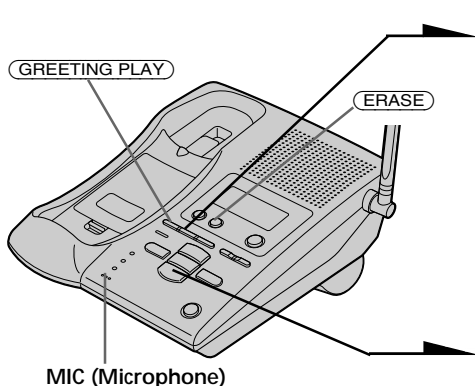

- 1** Press **GREETING REC**.
 You hear a voice guidance and a long confirmation beep.
- 2** After the tone, start recording.
 Speak about 12 inches (30 cm) away from the microphone.
- 3** Press **PLAY/STOP** to stop recording.
 The phone automatically replays the recorded greeting.

Notes

- If recording did not succeed, you hear five short error beeps. Start over the procedure.
- If a call comes in while recording a greeting, recording is cancelled. Start over the procedure.
- If you hear five short error beeps while recording, the recording area may be full. In this case, erase unnecessary messages (see page 45).
- You cannot operate the base unit while the handset is in use.
- This answering machine begins to record the greeting when it detects voice. Note that recording does not begin if the voice is extremely low or there is no sound.

Tips

- If four minutes have passed in step 3, recording stops automatically.
- To record the greeting from a touch-tone phone, see page 50.

continued

Preparing the answering machine (continued)

To record the greeting from the handset

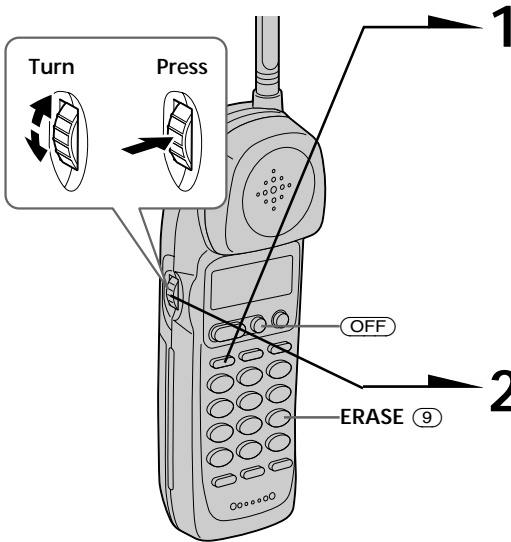

- 1** Press **REMOTE** and wait until the answering machine function menu appears on the display.

If you hear five short error beeps and “OUT OF RANGE” appears on the display, move closer to the base unit.



- 2** Turn Jog Dial down to make “REC GREETING” flash, and then press Jog Dial.



- 3** Press Jog Dial.

You hear a long confirmation beep.

- 4** After the tone, start recording.
Speak into the handset.



- 5** Press Jog Dial to stop recording.

You hear a long confirmation beep and the phone automatically replays the recorded greeting.

- 6** Press **OFF**.

Notes

- Do not allow more than 20 seconds to elapse between steps 1 and 2 of the procedure.
- If recording did not succeed, you hear five short error beeps. Start over the procedure.
- If a call comes in while recording a greeting, recording is cancelled. Start over the procedure.
- If you hear five short error beeps while recording, the recording area may be full. In this case, erase unnecessary messages (see page 45).

Tips

- If four minutes have passed in step 4, recording stops automatically.
- If you want to cancel recording, turn Jog Dial up to make "CANCEL" flash, then press Jog Dial in step 4.
- To record the greeting from a touch-tone phone, see page 50.

Prerecorded greeting

Normal mode: "Hello, I'm unable to answer your call right now. Please leave your name, number and message after the tone."

Announcement only mode: "Hello, I'm unable to answer your call right now. Please call again. Thank you."

Tips

- If you wish to record your own "announcement only" greeting, follow the above sequence after setting the AUDIBLE INDICATOR switch to ANN ONLY (page 40). Otherwise, the "normal" greeting will be recorded.
- You have to change the message each time you change the mode.

To check the greeting

Press **(GREETING PLAY)** to play back the greeting.

If you want to check the greeting with the handset, turn Jog Dial down to make "PLAY GREETING" flash in step 2 on page 36, then press Jog Dial.

To change the greeting

Record a new greeting. The new greeting replaces the old one.

To erase the greeting

Press **(ERASE)** on the base unit while playing back the greeting with the base unit, or press ERASE **(9)** on the handset while playing back it with the handset.

The answering machine will answer a call with the prerecorded greeting.

To go back to the factory preset greeting

Press **(ERASE)** on the base unit while playing back the greeting with the base unit, or press ERASE **(9)** on the handset while playing back it with the handset. This will bring back the original greeting.

continued

Preparing the answering machine (continued)

Selecting the ring time

You can select the number of rings before the answering machine starts to play back the greeting and records incoming messages. There are three options of ring time. Select the ring time by setting the RINGER SELECT switch.

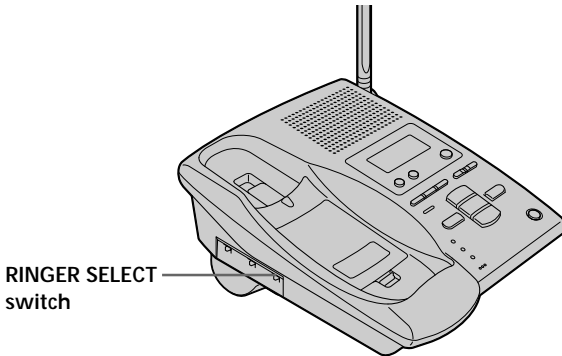

Set RINGER SELECT to	Mode
TS (Toll Saver)	If new messages have been recorded, the phone answers at the second ring and records incoming messages; if no new messages are recorded, it answers at the fifth ring. When you call from an outside phone and hear three rings, you know that there are no new messages. If you hang up at this point before the phone answers, you can save the toll for the call.
5	The phone always answers at the fifth ring and records incoming messages.
2	The phone always answers at the second ring and records incoming messages.

Selecting the recording quality

For the user who does not utilize the maximum recording capacity (about 18 minutes), you can select a higher recording grade and enjoy superior sound quality and clarity compared to the standard (NORM) grade. As higher sound quality uses up more memory capacity, the maximum recording time changes accordingly.

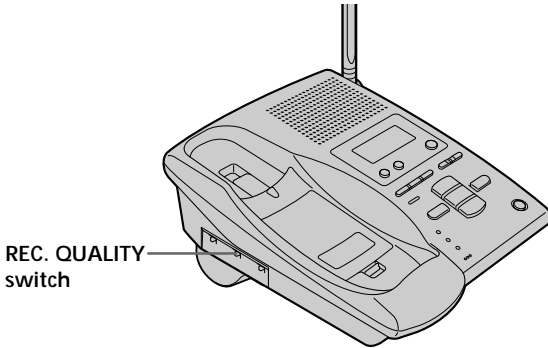

Note

The approx. length of the three recording grades are:

HIGH (Short) – 8 minutes

MID – 11 minutes

NORM (Long) – 18 minutes

Actual recording time may vary.

Preparing the answering machine (continued)

Selecting the answering mode

You can set the answering machine to record incoming messages (normal mode), or just make an announcement without recording messages (announcement only mode).

You can record your own greeting, or use the factory pre-recorded greetings.

In the normal mode, you also have the option of having a beep to tell you if you have received any new messages.

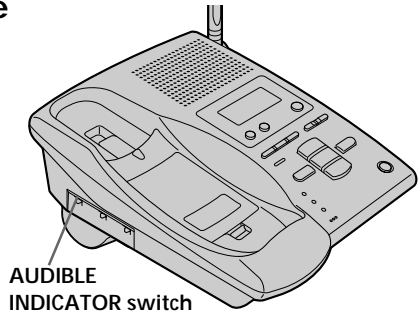

Set AUDIBLE INDICATOR to	When you wish to	Pre-recorded greeting
ON (normal mode)	play a greeting to ask the caller to leave a message and have the phone beep to alert you of recorded incoming messages.	"Hello, I'm unable to answer your call right now. Please leave your name, number and message after the tone."
OFF (normal mode)	play a greeting to ask the caller to leave a message but you do not wish to sound a beep.	
ANN ONLY (announcement only mode)	make an announcement to the caller without accepting incoming messages when, for example, you are away on a long vacation.	"Hello, I'm unable to answer your call right now. Please call again. Thank you."

Note

The same greeting is used regardless of the answering mode. Therefore, if you decide to change the mode, make sure that you record a new greeting to match the answering mode.

When the memory is full

The maximum recording area of this phone's memory is about 18 minutes* (including the greeting, messages, and memo). If the remaining recording area becomes less than one minute, "F" flashes on the display, and the phone automatically switches to announcement only mode, which does not record messages, and the greeting will be switched to the pre-recorded greeting.

* Available time for recording at NORM (Long) sound quality.

If you wish to record more messages, erase the existing messages (see page 45). You can also erase the messages from an outside phone (see page 50).

Note

The time for the memory to become full depends on the REC. QUALITY switch setting. "F" flashes on the display at the time which corresponds to the recording sound quality for the latter setting, if the switch setting is changed during the operation.

Turning on the answering function

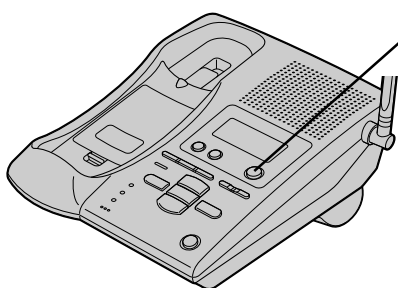

Press **ANSWER ON/OFF** so that it lights up in red.

To turn on the answering function from the handset

- 1 Press **REMOTE** and wait until the answering machine function menu appears on the display.



If you hear five short error beeps and “OUT OF RANGE” appears on the display, move closer to the base unit.

- 2 Turn Jog Dial down to make “ANSWERING ON” flash, and then press Jog Dial.

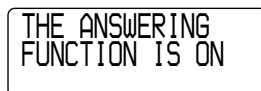

You hear a voice guidance and the ANSWER ON/OFF button lights up in red.

- 3 Press **OFF**.

Notes

- Do not allow more than 20 seconds to elapse during the operation procedure when you turn on the answering function from the handset.
- When the memory is full, you hear five short error beeps and you cannot turn on the answering function. Erase unnecessary messages (see page 45).

Tips

- The answering machine will automatically answer a call after 10 rings even if the answering function is off. The answering function will remain on for all subsequent calls.
- You can also turn on or off the answering function from an outside phone (see page 50).

continued

Preparing the answering machine (continued)

Mailbox usage

This phone offers you three voice mailboxes, providing a convenient way to share the mailbox feature with other members of your household or business.

When a caller calls

The caller can choose one of the two ways to leave a message:

- If calling from a touch-tone phone, the caller select a mailbox by pressing *** 1** (MAILBOX 1), *** 2** (MAILBOX 2) or *** 3** (MAILBOX 3) while the caller hears the greeting. The greeting stops and a beep will sound, then the caller can start recording a message.
- Wait until the greeting finishes, then start recording a message. When the caller does not select a mailbox, the message is automatically recorded to MAILBOX 1.

Notes

- If four minutes have passed while recording the incoming message, the line is automatically disconnected.
- If the message is shorter than two seconds, it will not be recorded.

To turn off the answering function

Press **ANSWER ON/OFF** so that the red light turns off.

If you want to turn off the answering function from the handset, turn Jog Dial down to make "ANSWERING OFF" flash in step 2 on page 41, then press Jog Dial.

Playing back messages

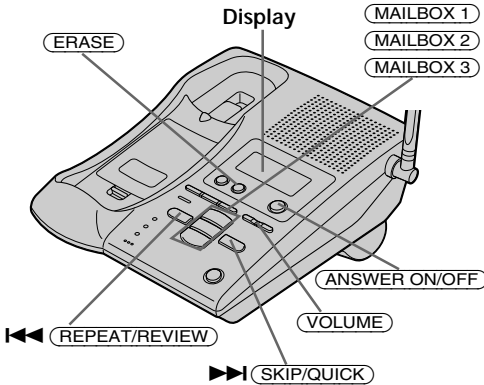

When you come home

If **ANSWER ON/OFF** flashes in red, or the message counter shows the number of new messages and “NEW” in the MAILBOX indicator on the display flashes, press the mailbox button (**MAILBOX 1**), (**MAILBOX 2**) or (**MAILBOX 3**).

The machine plays back from the newest message received.

To play back messages from the handset

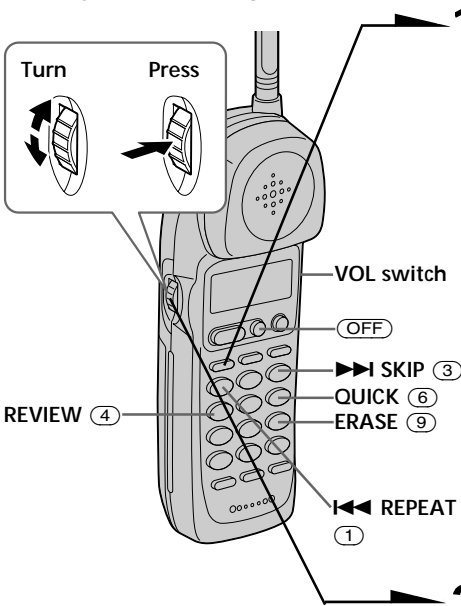

1 Press **REMOTE** and wait until the answering machine function menu appears on the display.

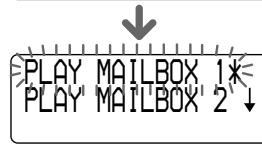

“*” is displayed at the right of a MAILBOX number which contains new messages.

If you hear five short error beeps and “OUT OF RANGE” appears on the display, move closer to the base unit.

2 Turn Jog Dial down to make “PLAY MAILBOX 1” to “PLAY MAILBOX 3” flash, and then press Jog Dial.

The machine plays back from the newest message received.

3 Press **OFF**.

continued

Playing back messages (continued)

Note

Do not allow more than 20 seconds to elapse during the operation procedure.

Additional tasks when playing back messages

To	Do this
Adjust the speaker volume	Press VOLUME (+) or (-).
Adjust the handset volume	Set the VOL switch on the handset to H (high), M (middle) or L (low).
Stop playback	Press the mailbox button on the base unit again or press Jog Dial on the handset.
Replay the messages	Press the mailbox button on the base unit again.
Skip to the next message	Press ▶▶ SKIP/QUICK (3) on the base unit or ▶▶ SKIP (3) on the handset while the current message is playing.
Repeat the current message	Press ◀◀ REPEAT/REVIEW (1) on the base unit or ◀◀ REPEAT (1) on the handset while the current message is playing.
Go back to previous messages	Press ◀◀ REPEAT/REVIEW (1) on the base unit or ◀◀ REPEAT (1) on the handset within the first three seconds of the current message.
Review playback	Keep ◀◀ REPEAT/REVIEW (1) on the base unit or REVIEW (4) on the handset pressed during playback.
Play back quickly	Keep ▶▶ SKIP/QUICK (3) on the base unit or QUICK (6) on the handset pressed during playback.

Erasing messages

To erase the message one by one

Press **ERASE** on the base unit while playing back the message with the base unit, or press **ERASE** **9** on the handset while playing back it with the handset.

To erase all messages in a mailbox from the base unit

Press **ERASE** on the base unit, and a mailbox button (**MAILBOX 1**), (**MAILBOX 2**) or (**MAILBOX 3**).

You hear a long confirmation beep and all messages in the selected mailbox are erased.

To erase all messages in a mailbox from the handset

1 Press **REMOTE** and wait until the answering machine function menu appears on the display.

If you hear five short error beeps and “OUT OF RANGE” appears on the display, move closer to the base unit.

2 Turn Jog Dial down to make “ERASE MAILBOX 1” to “ERASE MAILBOX 3” flash, and then press Jog Dial.

3 Turn Jog Dial up to make “YES” flash, and then press Jog Dial.

You hear a long confirmation beep and all messages in the selected mailbox are erased.

Notes

- The display shows the total number of “new” messages. Therefore, it is reset to “0” (on the base unit) or “00” (on the handset) when you play back all new messages, even they are not erased yet. Be sure to erase unnecessary messages before the memory becomes full.
- When the number of new messages exceeds 99, “99” flashes on the display of the base unit and “99” appears on the display of the handset.
- If a call comes in during playback, the playback stops.
- If a power interruption occurs or the AC power adaptor is disconnected while erasing a message, all recorded message may be erased.
- Do not allow more than 20 seconds to elapse during the operation procedure when you erase messages from the handset.

Tip

You can also listen to the messages or erase the messages from a outside phone (page 50).

Screening incoming calls

You can screen calls by leaving the answering function on (see page 41) while you are at home. When a call is answered, you can hear the message being recorded through the base unit or handset but the caller cannot hear you. Then, you can decide whether to answer the call or not. This function is available both the base unit and the handset. However, the following procedures are required in order to screen incoming calls on the handset.

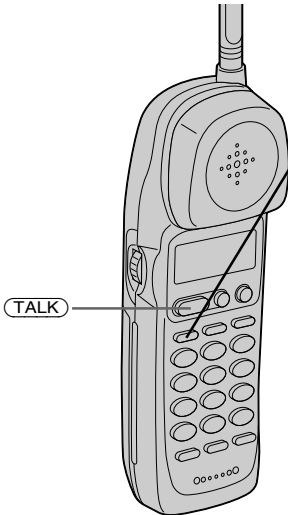

To screen incoming calls on the handset

Press **REMOTE** while “** ANSWERING **” is displayed.

“CALL SCREENING” appears on the display of the handset.

To answer the call

Press **TALK** on the handset.

Recording is stopped and you can speak to the caller.

Note

If the answering volume is set to minimum, you cannot screen the calls on the base unit.

Tips

- You can conclude call screening by pressing **OFF** on the handset.
- You can also answer the call by picking up the handset on another phone if it is connected to the same line.

Recording a memo

You can record a “memo” (up to four minutes) as a personal reminder or as a message for other people. You can play back the recorded memo like any incoming messages (see page 43).

You can record a memo on both the base unit and the handset.

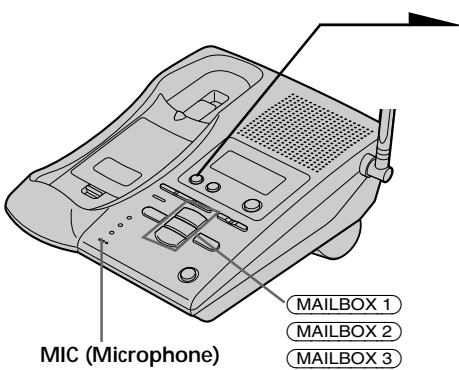

- 1** Press **MEMO**.
You hear a voice guidance.
- 2** Select a mailbox by pressing **MAILBOX 1**, **MAILBOX 2** or **MAILBOX 3**. You will hear a voice guidance, then a long confirmation beep.
- 3** After the tone, start recording. Speak about 12 inches (30 cm) away from the microphone.
- 4** Press **MEMO** to stop recording.
The message number in the display increases by one.

Notes

- If you press **MEMO** when the memory is full (“F” flashing on the display), you hear five short error beeps and you cannot record a memo.
- If a call comes in while recording a memo, recording is canceled. Start over the procedure.
- If the remaining memory becomes full while recording, recording stops automatically and “F” flashes on the display.
- You cannot operate the base unit while the handset is in use.
- This answering machine begins to record a memo when it detects voice. Note that recording does not begin if the voice is extremely low or there is no sound.

Tip

If four minutes have passed in step 3, recording stops automatically, and the recorded memo is counted as a new message.

Recording a memo (continued)

To record a memo from the handset

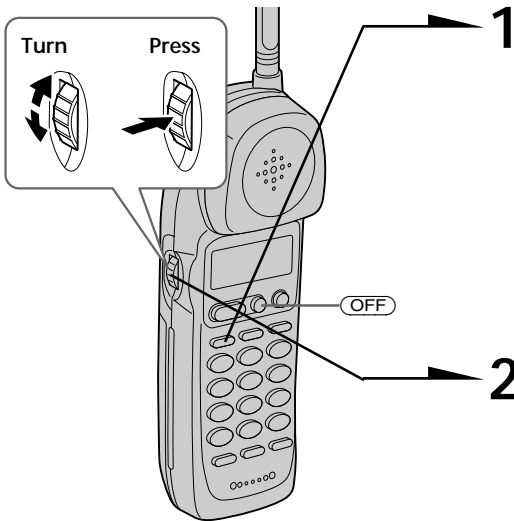

1 Press **REMOTE** and wait until the answering machine function menu appears on the display.

If you hear five short error beeps and “OUT OF RANGE” appears on the display, move closer to the base unit.

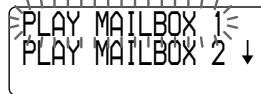

2 Turn Jog Dial down to make “REC MEMO BOX 1” to “REC MEMO BOX 3” flash, and then press Jog Dial.



3 Press Jog Dial.

You hear a long confirmation beep.

4 After the tone, start recording.

Speak into the handset.



5 Press Jog Dial to stop recording.

You hear a long confirmation beep.

6 Press **OFF**.

Notes

- Do not allow more than 20 seconds to elapse between steps 1 and 2 of the procedure.
- When the memory is full (“F” flashing on the display of the base unit), you hear five short error beeps in step 2 and you cannot record a memo.
- If a call comes in while recording a memo, recording is canceled. Start over the procedure.
- If the remaining memory becomes full while recording, recording stops automatically and “F” flashes on the display of the base unit.

Tip

If four minutes have passed in step 4, recording stops automatically, and the recorded memo is counted as a new message.

Operating from an outside phone

You can call from a touch-tone phone and pick up new messages recorded on the phone. First, you just set the remote ID code (security code) and turn on the answering function before going out. Setting the remote ID code (security code) is only possible on the handset.

Setting the remote ID code (security code)

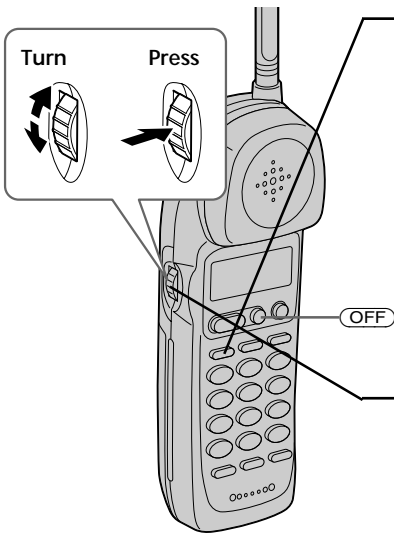

- 1 Press **REMOTE** and wait until the answering machine function menu appears on the display.



If you hear five short error beeps and "OUT OF RANGE" appears on the display, move closer to the base unit.

- 2 Turn Jog Dial down to make "SET SECURITY No" flash, and then press Jog Dial.

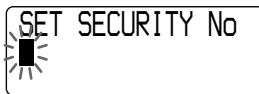

- 3 Enter the four digits of the remote ID code (security code) using the dialing keys.
- 4 Press Jog Dial.
The remote ID code (security code) is set, and you hear a long confirmation beep.

- 5 Press **OFF**.

Note

Do not allow more than 20 seconds to elapse during the operation procedure.

To change the remote ID code (security code)

Enter a new remote ID code (security code). The new code will replace the old one.

continued

Operating from an outside phone (continued)

Picking up new messages

- 1 Call your phone from a touch-tone phone.
- 2 While you hear your greeting play, press **(#)**. The greeting stops.
After confirming the greeting stops, enter your remote ID code (security code). You hear a long confirmation beep.
Following the voice guidance informing you of the number of messages recorded, the phone stands by for you to enter a control code.
- 3 To do other operations, enter the control code within 20 seconds (see the table below). To quit, hang up the phone.

Control codes for remote operations

To	Press
Play back messages in MAILBOX 1	(#) (1)
Play back messages in MAILBOX 2	(#) (2)
Play back messages in MAILBOX 3	(#) (3)
Repeat the current message	(#) (4) while the message is being played back
Skip the current message	(#) (6) while the message is being played back
Erase the current message	(#) (9) while the message is being played back
Erase all messages in MAILBOX 1	(#) (9) (#) (1)
Erase all messages in MAILBOX 2	(#) (9) (#) (2)
Erase all messages in MAILBOX 3	(#) (9) (#) (3)
Record a new greeting (up to one minute)	(*) (7) . When you hear a long beep, start recording your greeting. Press (*) (*) to stop recording.
Turn on the answering function	(*) (0)
Turn off the answering function	(#) (0)
Stop the current operation	(*) (*)

If you forgot to turn the answering function on

Call your phone and let it ring 10 times until it answers. Then the answering function automatically turns on.

Notes

- If you enter a wrong remote security code three times, the line will be disconnected.
- If the greeting does not stop, press and hold **(#)** again.

To use the toll-saver feature

Set RINGER SELECT to TS. See page 38 for details.

Understanding the Caller ID service

Caller ID allows the caller's phone number to be shown on the display before you answer the call. In order to use this feature, you must first subscribe to Caller ID service. The name of this service may vary depending on your telephone company.

To use this feature, be sure to enter the area code (see page 14).

When you receive a call

The phone number appears on the display with the date and time as shown in the following example.

If your Caller ID service includes the caller name service, the caller's name also appears on the display (up to 15 letters).

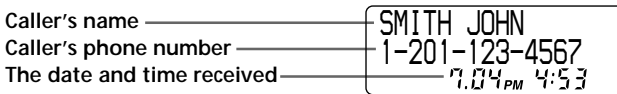

When you answer the call, the Caller ID display changes to the "TALK" display.

Notes

- The caller's phone number and/or name will not appear in the following cases:
 - "OUT OF AREA": when the call is made through a telephone company which does not offer Caller ID service (including international calls).
 - "PRIVATE": when the call is "blocked". For privacy reasons, many states allow callers the option to prevent his or her telephone data from being displayed on the other party's Caller ID display.
- If the call is from an office which uses multiple lines, the displayed phone number may not match the number you use to call the extension.

About the memory match function

If you receive a call from a phone number which is stored on one of the ONE-TOUCH DIAL buttons (see page 26) or in the Phone Directory (see page 28), the ringer sound will change to a higher tone from the second ring.

Note

The memory match function does not work with "OUT OF AREA" or "PRIVATE" calls; and it may not work with calls made from an office which uses multiple lines because the number does not always match the one you stored in this phone.

Looking at the Caller ID list

The phone stores the data of the last 20 calls received including “OUT OF AREA” and “PRIVATE” calls. It keeps track of all calls received; even if they were not answered.

Viewing the Caller ID list

You can look through the Caller ID list to check the phone number and/or name of the calls received.

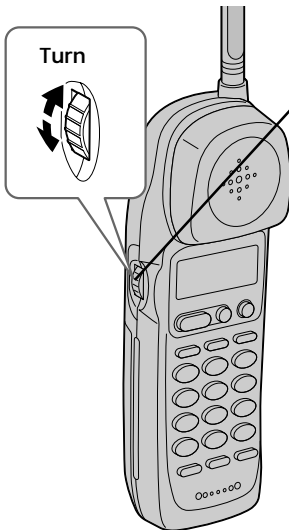

1 Turn Jog Dial.

The display shows the number of “NEW” (calls which you have not viewed) and “OLD” (calls which you have viewed) calls.

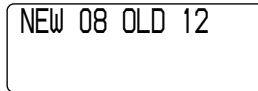

2 Turn Jog Dial down to display older data or up to display newer data.

Notes

- If a 21st call is received, the oldest data is automatically erased.
- When you have checked all data , “END OF LIST” appears.

Tip

If there is a “NEW” data, the NEW CALL lamp of the base unit flashes.

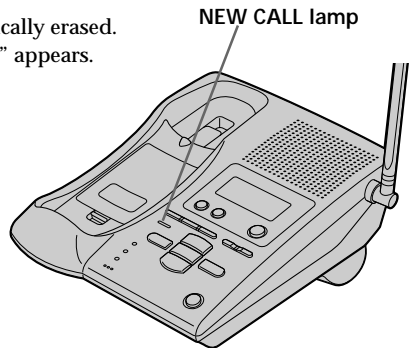

About the “*” mark



“*” appears if there are more than two calls from the same phone number. The older data will be replaced by the new data, so the calls are counted as only one call.

Erasing data from the Caller ID list

Old data will be erased automatically when a 21st call comes in, but you can also manually erase unnecessary data one by one or erase the entire list.

To erase the phone number one by one

- 1 Display the phone number you want to erase from the Caller ID list (see page 52).
- 2 Press Jog Dial.
- 3 Turn Jog Dial up to make “ERASE” flash and press Jog Dial.
- 4 Turn Jog Dial up to make “YES” flash, then press Jog Dial.
You hear a long confirmation beep and the data is erased.

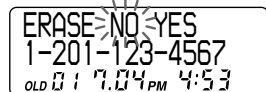
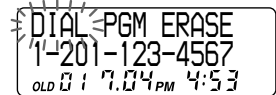
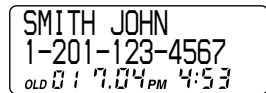

Looking at the Caller ID list (continued)

To erase the entire list at once

1 Display any Caller ID data.



2 Press Jog Dial.

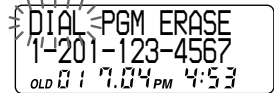

3 Turn Jog Dial up to make “ERASE” flash and press Jog Dial.

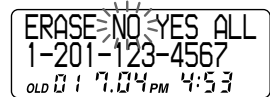

4 Turn Jog Dial up to make “ALL” flash, then press Jog Dial.

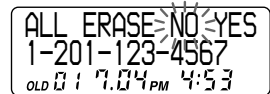

5 Turn Jog Dial up to make “YES” flash, then press Jog Dial.

You hear a long confirmation beep and the entire list is erased.

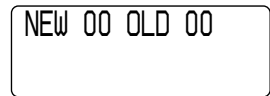

Note

“ALL” appears only when all the data had become “OLD” data. If there is any “NEW” data, you cannot erase the entire list.

Using the Caller ID list

By using the Caller ID list, you can call back a phone number from the Caller ID list easily, or store numbers from the Caller ID list into the Phone Directory.

Calling back a number from the Caller ID list

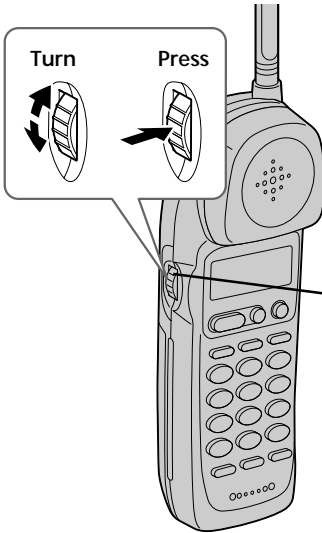

- 1** Display the phone number you want to call from the Caller ID list (see page 52).



- 2** Press Jog Dial.

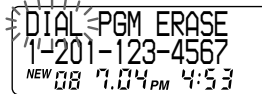

- 3** Press Jog Dial again.
The phone automatically dials the displayed number.

Notes

- If the number displayed in step 1 is not the one you should call back, you can change the number of digits of the phone number as described on page 57.
- If the phone is connected to a Private Branch Exchange (PBX), you may not be able to call back from the Caller ID list because an outside line access digit is necessary.

Tip

You may press **TALK** to make a call instead of doing steps 2 and 3.

Using the Caller ID list (continued)

Storing a number of the Caller ID list into the Phone Directory

- 1 Display the name and phone number you want to store from the Caller ID list (see page 52).



- 2 Confirm the number and press Jog Dial.

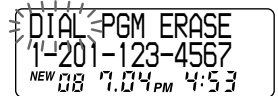

- 3 Turn Jog Dial up to make "PGM" flash and press Jog Dial.

The cursor flashes at the end of the name.

Enter or change the name, if necessary (see page 29).



- 4 Press Jog Dial.

The cursor flashes at the end of the phone number.

Enter or change the phone number, if necessary (see page 29).



- 5 Press Jog Dial again.

You hear a long confirmation beep and the name and number are stored.

Notes

- Do not allow more than 20 seconds to elapse during the operation procedure.
- If the number displayed in step 1 is not the one you should store, you can change the number of digits of the phone number as described on page 57.
- If the phone is connected to a Private Branch Exchange (PBX), you may need to add an outside line access digit.

To change the number of digits of the phone number

If the number of digits of the phone number in the Caller ID list is different from the actual phone number, you need to adjust the number of digits of the phone number to call back or store into the Phone Directory.

- 1 While the phone number from the Caller ID list is displayed, press **(#)** repeatedly until the phone number with the correct number of digits appears on the display.

Each time you press **(#)**, the number of digits changes as follows:

When the home area code and the local area code do not match

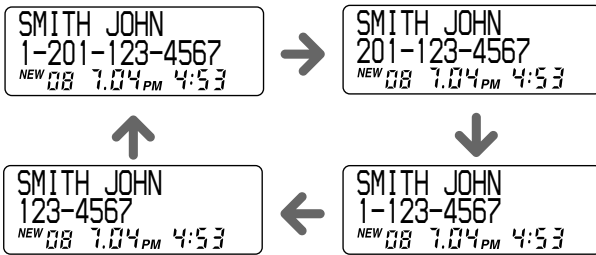

When the home area code matches

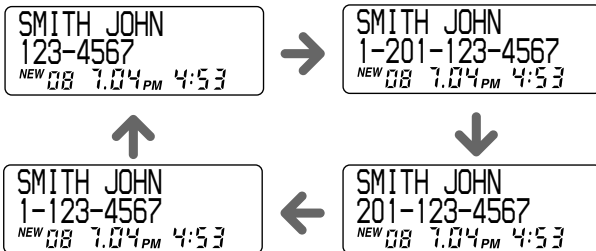

continued

Using the Caller ID list (continued)

When the local area code matches

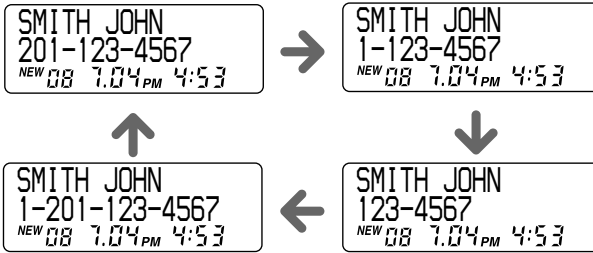

2 Continue the operation to call or store the phone number with the correct number of digits (pages 55 and 56).

Notes

- You need to adjust the number of digits each time you call back from the Caller ID list as the changes to the Caller ID data is not stored in memory.
- You may not be able to change the number of digits depending on the Caller ID data.

Using “Caller ID with call waiting” service

This telephone is compatible with the “Caller ID with call waiting” service. Make sure that your telephone company offers this service.

Like the basic Caller ID service, you need to subscribe to “Caller ID with call waiting” in order to use this service.

Even though you may have already subscribed to “Caller ID” and “call waiting” as two separate services, you need to request a subscription to “Caller ID with call waiting” as a single service.

This is a new service that combines the two services.

Even though you now have a “Caller ID with call waiting” compatible phone, unless you subscribe to the combined “Caller ID with call waiting” service, you will not be able to see the name and number of the second caller.

When a new call comes in while you are talking, the caller’s name and/or phone number of the new call appears on the display for about 20 seconds.

To switch to another caller

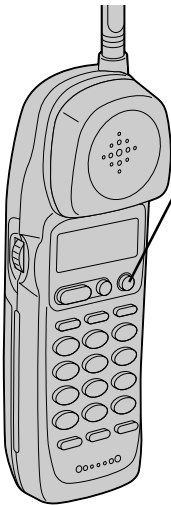

- 1 To switch to the new caller, press **CALL WAITING/FLASH**.
- 2 To switch back to the first caller, press **CALL WAITING/FLASH** again.

Mounting the base unit on a wall

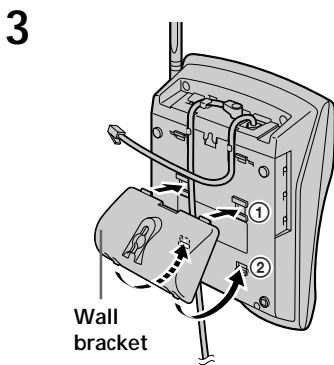
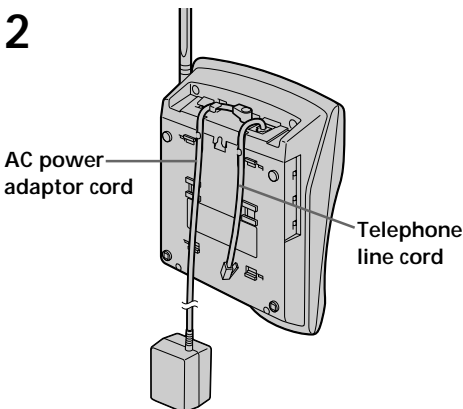
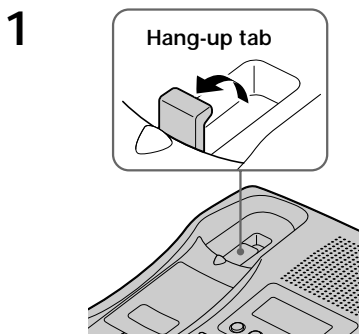

- 1 Raise the hang up tab.
- 2 Plug the telephone line cord to the LINE jack and the AC power adaptor to the DC IN 9V jack, and hook the cords. Use the shorter cord for mounting.

- 3 Attach the wall bracket to the center of the base unit.
Align the Δ marks of the wall bracket with those of the base unit.

- 4 Plug the telephone line cord to the telephone outlet, and hook the base unit to the wall plate.

- 5 Plug the AC power adaptor to an AC outlet. Then raise the antenna so that it points towards the ceiling.

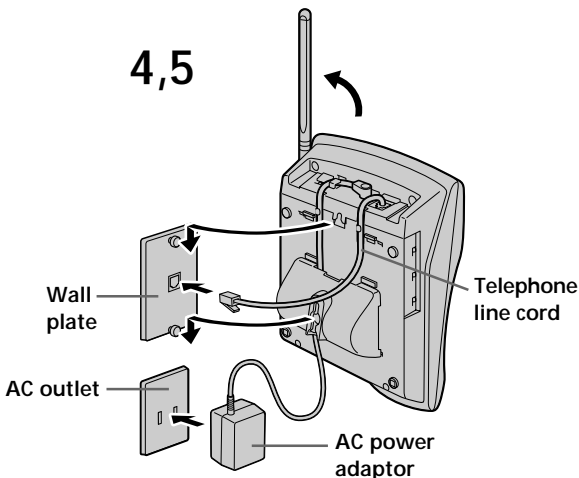

Tip
To remove the wall bracket, press the lower tabs.

Notes on power sources

On battery pack

- Store the battery pack at a temperature between 41°F (5°C) and 95°F (35°C) for best performance.
- If you do not use the handset for a long period of time, remove the battery pack from the handset after charging for more than 12 hours, and base unit after charging for more than 24 hours when you have a spare battery. This maintains battery life.

On power failure

During a power interruption, you **cannot** make or receive calls, and you **cannot** use the answering machine.

For the customers in the USA

RECYCLING NICKEL-CADMIUM BATTERIES

Nickel-Cadmium batteries are recyclable. You can help preserve our environment by returning your unwanted batteries to your nearest point for collection, recycling or proper disposal.



Note: In some areas the disposal of nickel-cadmium batteries in household or business trash may be prohibited.

RBRC (Rechargeable Battery Recycling Corporation) advises you about spent battery collection by the following phone number.

Call toll free number: 1-800-822-8837
(United States and Canada only)

Caution: Do not handle damaged or leaking nickel-cadmium batteries.

Maintenance

- Clean the cabinets with a soft cloth slightly moistened with water or a mild detergent solution. Do not use any type of abrasive pad, scouring powder or solvent such as alcohol or benzine as they may damage the finish of the cabinet.
- If the charge terminals of the base unit and handset are soiled, wipe them with a soft cloth.

If you have any questions or problems concerning your phone, please consult your nearest Sony dealer.

Troubleshooting

If you've experienced any of the following difficulties while using your phone, use this troubleshooting to help you remedy the problem. Should any problem persist, consult your nearest Sony dealer.

	Symptom	Remedy
Making calls	You hear five short error beeps when you press TALK .	<ul style="list-style-type: none"> • Make sure you set up the base unit correctly (page 8). • Move the handset closer to the base unit.
	You hear no dial tone.	<ul style="list-style-type: none"> • Make sure the telephone line cord is securely connected to the telephone outlet. • Make sure the battery is fully charged (page 11).
	The phone does not connect at all, even though the number you dial is correct.	<ul style="list-style-type: none"> • Make sure the dialing mode is set correctly (page 10).
	The phone does not redial correctly.	<ul style="list-style-type: none"> • Make sure the last dialed number is really the one you want to dial.
	You hear five short error beeps when you try to redial.	<ul style="list-style-type: none"> • The number you last dialed exceeds 32 digits (including the tone and pause digits if used). • The number you last dialed is erased.
Receiving calls	The handset does not ring.	<ul style="list-style-type: none"> • Set the RING switch on the handset to ON. • The battery may be weak. Charge the battery for more than 12 hours (page 11). • Make sure you set up the base unit correctly (page 8). • Move the handset closer to the base unit.
	You hear interference during conversation.	<ul style="list-style-type: none"> • Move the handset closer to the base unit. • Place the base unit away from noise sources (page 8).
During conversation	You hear a beep every second during conversation and "OUT OF RANGE" appear on the display.	<ul style="list-style-type: none"> • It is an out-of-range alarm. Move the handset closer to the base unit within one minute.
	You hear a beep twice per second and  and "BATTERY LOW" appear on the display.	<ul style="list-style-type: none"> • The battery is weak. Charge the battery for more than 12 hours (page 11).
Display and the voice guidance language	An incorrect language is set for the display and the voice guidance.	<ul style="list-style-type: none"> • Follow the procedure for changing the language (page 17).

continued

Troubleshooting (continued)

	Symptom	Remedy
One-touch dialing/ Phone Directory	You hear five short error beeps and cannot store a number on a one-touch dial or in the Phone Directory.	<ul style="list-style-type: none"> Make sure you follow the procedure in storing the number correctly (pages 26 and 28).
	You hear five short error beeps when you try to make a one-touch dial call.	<ul style="list-style-type: none"> You entered a one-touch dialing button to which no phone number has been stored.
	One-touch dialing or Phone Directory dialing is incorrect.	<ul style="list-style-type: none"> Store a correct number (pages 26 and 28).
Answering machine	You cannot hear anything from the speaker.	<ul style="list-style-type: none"> Use the VOLUME control on the base unit to increase the speaker volume.
	No time stamp is heard.	<ul style="list-style-type: none"> Make sure the day and time are set (page 33). The day and time may have been cleared due to a power interruption. Set them again (page 33).
	You cannot record the greeting properly.	<ul style="list-style-type: none"> Keep your message between two seconds and four minutes. Make sure you speak about 12 inches (30 cm) away from the microphone when recording.
	The phone does not record messages	<ul style="list-style-type: none"> Check the answering mode. The phone cannot record messages in announcement only mode (page 40). Make sure that the memory is not full. When the remaining recording area is less than one minute, the phone switches to announcement only mode automatically. The phone does not record a message that is shorter than two seconds. Even if the message is longer than four minutes, the phone only records up to four minutes.
	The recordable time is short.	<ul style="list-style-type: none"> Make sure the position of the REC. QUALITY switch (page 39).
Operating from an outside phone	The phone does not accept your remote ID code (security code).	<ul style="list-style-type: none"> Make sure you call from a touch-tone phone. Make sure you entered your remote ID code (security code) within two seconds after you have entered (#).
	You hear error beeps when you enter your remote ID code (security code).	<ul style="list-style-type: none"> Make sure the remote ID code (security code) is correct.
	A long confirmation beep does not sound when you enter your remote ID code (security code).	<ul style="list-style-type: none"> Enter your remote ID code (security code) while the greeting is being played back. Make sure you are calling from a touch-tone phone.

	Symptom	Remedy
Operating from the handset	You cannot operate with the handset.	<ul style="list-style-type: none"> • Move the handset closer to the base unit. • Make sure the battery is fully charged (page 11).
	The caller's name and/or phone number does not appear on the display.	<ul style="list-style-type: none"> • Make sure you have subscribed to Caller ID service. • Caller ID service may not work when the phone is connected to a Private Branch Exchange (PBX). • The call is made through company which does not offer Caller ID service. "OUT OF AREA" will appear on the display. • The call was "blocked". "PRIVATE" will appear on the display. • You answered the call while "** RINGING **" is displayed. Be sure to answer after the Caller ID data is displayed.
Caller ID	The caller's name and/or phone number does not appear on the display during call waiting.	<ul style="list-style-type: none"> • Make sure you have subscribed to "Caller ID with call waiting" service (page 59). • Make sure nobody is talking on another phone on the same telephone line.
	You cannot dial the number from the Caller ID list.	<ul style="list-style-type: none"> • Make sure you entered your home area code correctly (page 14). • You may need to change the number of digits of the phone number (page 57). • This function may not work when the phone is connected to a Private Branch Exchange (PBX).
	The memory match function does not work.	<ul style="list-style-type: none"> • If the call is from an office which uses multiple lines, the phone number may not match the number you put in the memory. • If you stored the phone number with an outside line access digit in the Phone Directory because the phone is connected to a Private Branch Exchange (PBX), the phone number will not match the Caller ID data.

Troubleshooting (continued)

	Symptom	Remedy
Power source/battery	The CHARGE lamp does not light up when you place the handset to charge.	<ul style="list-style-type: none">• Wipe the charge terminals of the base unit and the handset with a soft cloth for better contact of the charge terminals.• Make sure the handset is placed on the base unit properly.
	The battery duration is short.	<ul style="list-style-type: none">• The battery pack was charged less than 12 hours (due to power failure, etc.).• The usable life of the battery has expired and needs replacement.
	The handset does not work.	<ul style="list-style-type: none">• The battery may be weak. Charge the battery for more than 12 hours (page 11).

Note

If any of the remedy did not work, there may be something wrong with the handset.

Replace the handset on the base unit, then pick it up and try again. If the handset is on the base unit, pick up the handset and replace it again.

Message counter

The message counter on the base unit shows the following information.

When the counter shows	It means
Number (0-99)	Number of messages not yet played back. The counter shows up to 99 messages. After that, "99" flashes to tell you that there are 100 or more messages.
P	Flashes when the day and time is cleared due to a power interruption, or when you connect the base unit to the AC outlet for the first time (pages 9 and 34).
A	The announcement only mode is selected (page 40).
F	The recording area is full. Erase unnecessary messages (page 45).

Specifications

General

Spread method

Direct-Sequence Spread-Spectrum

Access method

FDMA-TDD

Operation frequency

902 - 928 MHz

Operating channel

14 channels

Dial signal

Tone, 10 PPS (pulse) selectable

Supplied accessories

See page 7.

Handset

Power source

Rechargeable battery pack BP-T31

Battery charging time

Approx. 12 hours

Battery life

Standby: Approx. 7 days

Talk: Approx. 6 hours

Dimensions

Approx. $2\frac{1}{4} \times 7\frac{1}{4} \times 2\frac{1}{4}$ inches (w/h/d),
antenna excluded

(approx. 56 x 183 x 55 mm)

Antenna: Approx. 3 inches

(approx. 75 mm)

Mass

Approx. 9.5 oz (approx. 270 g), battery
included

Base unit

Power source

DC 9V from AC power adaptor AC-T46

Battery charging time

Approx. 24 hours

Dimensions

Approx. $6\frac{3}{8} \times 2\frac{7}{8} \times 8\frac{3}{4}$ inches (w/h/d),
antenna excluded

(approx. 160 x 71 x 222 mm)

Antenna: Approx. $4\frac{1}{2}$ inches

(approx. 113 mm)

Mass

Approx. 1 lb 3 oz (approx. 540 g), wall
bracket excluded

Answering machine

Maximum recording time

About 18 minutes (at NORM (Long)
recording quality), using incorporated IC

Greeting message

Up to 4 minutes

Incoming message

Up to 4 minutes/message

Memo

Up to 4 minutes/message

Design and specifications are subject to
change without notice.

Index

A

- Adjusting volume
 - handset 22
 - speaker 44
- Announcement only 40
- Answering machine
 - turning on 41
- Area code 14
- Audible indicate 40

B

- Battery pack
 - charging 11
 - duration 12

C

- Call waiting service 22, 25
- Caller ID 51
 - Caller ID list 52
 - calling back 55
 - memory match function 51
 - storing in Phone Directory 56
- Caller ID with call waiting 59
- Connection 9
- Control codes for remote operations 50

D

- Day and time stamp 33
- Dialing mode
 - choosing 10
 - switching to the tone temporarily 22
- Directroy
 - Phone Directory 28

E, F

- Erasing
 - Caller ID data 53
 - last phone number dialed 24
 - messages 45
 - Phone Directory 30

G

- Greeting 35

H

- Home area code 14

I, J, K

- Identifying the parts 18

L

- Language of the display and the voice guidance 17
- Local area code 15
- Location, base unit 8

M, N

- Mailbox 42, 43
- Making calls 22
- Memo 47
- Memory match function 51
- Messages 43
- Mounting the base unit on a wall 60

O

- One-touch dialing 26
- Operating from an outside phone 49
- OUT OF AREA 51

P, Q

- Package contents 7
- Paging 32
- Phone Directory 28

Playing

- announcement only 40
- messages 43
- PRIVATE 51
- Pulse dialing 10

R

- Recording
 - greeting 35
 - memo 47
- Recording quality 39
- Receiving calls 25
- Redialing 24
- Remote ID code (security code) 49
- Ringer
 - RING switch 25

S

- Screening calls 46
- Setting up
 - base unit 8
 - handset 11
- Speaker 44
- Stamping messages with day and time 33
- Storing Caller ID data in Phone Directory 56

T, U

- Toll-saver feature 38
- Tone dialing
 - dialing mode 10
 - switching to 22
- Troubleshooting 63

V, W, X, Y, Z

- Volume
 - handset 22
 - speaker 44

For the customers in the USA

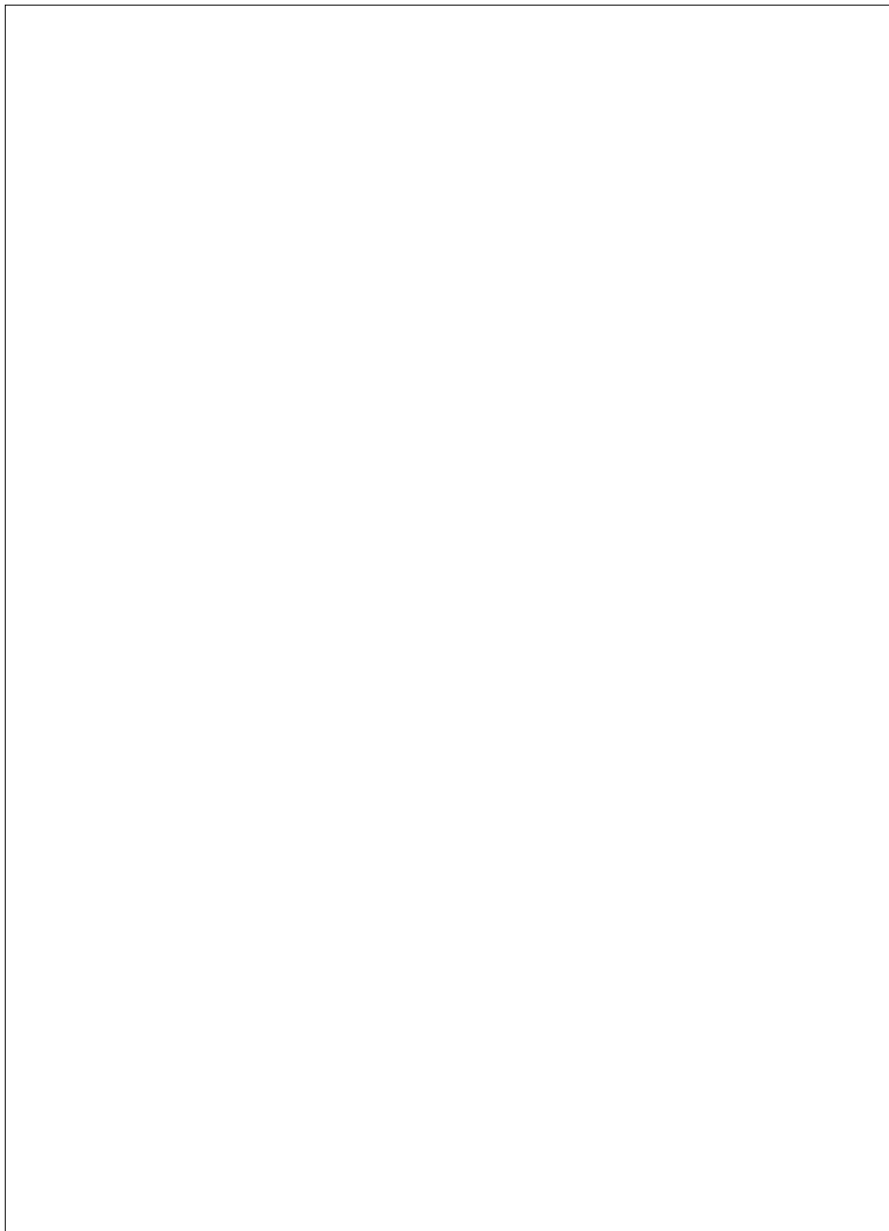

Be sure to save the receipt and attach it to your WARRANTY card when having your equipment repaired at an authorized Sony service station.

www.sony.com/productregistration

Sony Corporation Printed in Taiwan, R.O.C.

Download from Www.Somanuals.com. All Manuals Search And Download.

Free Manuals Download Website

<http://myh66.com>

<http://usermanuals.us>

<http://www.somanuals.com>

<http://www.4manuals.cc>

<http://www.manual-lib.com>

<http://www.404manual.com>

<http://www.luxmanual.com>

<http://aubethermostatmanual.com>

Golf course search by state

<http://golfingnear.com>

Email search by domain

<http://emailbydomain.com>

Auto manuals search

<http://auto.somanuals.com>

TV manuals search

<http://tv.somanuals.com>