

Cordless Telephone ***with Answering System***

Operating Instructions

US

*High
Power* **900** MHz

CALLER ID
with call waiting

SPP-A9276

Owner's Record

The model and the serial numbers are located at the bottom of the unit. Record the serial number in the space provided below. Refer to these numbers whenever you call upon your Sony dealer regarding this product.

Model No. SPP-A9276

Serial No. _____

IMPORTANT SAFETY INSTRUCTIONS

When using your telephone equipment, basic safety precautions should always be followed to reduce the risk of fire, electric shock and injury to persons, including the following:

1. Read and understand all instructions.
2. Follow all warnings and instructions marked on the product.
3. Unplug this product from the wall outlet before cleaning. Do not use liquid cleaners or aerosol cleaners. Use a damp cloth for cleaning.
4. Do not use this product near water, for example, near a bath tub, wash bowl, kitchen sink, or laundry tub, in a wet basement, or near a swimming pool.
5. Do not place this product on an unstable cart, stand, or table. The product may fall, causing serious damage to the product.
6. Slots and openings in the cabinet and the back or bottom are provided for ventilation. To protect it from overheating, these openings must not be blocked or covered. The openings should never be blocked by placing the product on the bed, sofa, rug, or other similar surface. This product should never be placed near or over a radiator or heat register. This product should not be placed in a built-in installation unless proper ventilation is provided.
7. This product should be operated only from the type of power source indicated on the marking label. If you are not sure of the type of power supply to your home, consult your dealer or local power company.
8. Do not allow anything to rest on the power cord. Do not locate this product where the cord will be abused by persons walking on it.
9. Do not overload wall outlets and extension cords as this can result in the risk of fire or electric shock.
10. Never push objects of any kind into this product through cabinet slots as they may touch dangerous voltage points or short out parts that could result in a risk of fire or electric shock. Never spill liquid of any kind on the product.
11. To reduce the risk of electric shock, do not disassemble this product, but take it to a qualified service personnel when some service or repair work is required. Opening or removing covers may expose you to dangerous voltages or other risks. Incorrect reassembly can cause electric shock when the appliance is subsequently used.
12. Unplug this product from the wall outlet and refer servicing to qualified service personnel under the following conditions:
 - A. When the power cord or plug is damaged or frayed.
 - B. If liquid has been spilled into the product.
 - C. If the product has been exposed to rain or water.
 - D. If the product does not operate normally by following the operating instructions. Adjust only those controls that are covered by the operating instructions because improper adjustment of other controls may result in damage and will often require extensive work by a qualified technician to restore the product to normal operation.
 - E. If the product has been dropped or the cabinet has been damaged.
 - F. If the product exhibits a distinct change in performance.

13. Avoid using a telephone (other than a cordless type) during an electrical storm. There may be a remote risk of electric shock from lightning.
14. Do not use the telephone to report a gas leak in the vicinity of the leak.

SAVE THESE INSTRUCTIONS

CAUTION:

To reduce the risk of fire or injury to persons by battery, read and follow these instructions.

1. Use only the following type and size battery pack: Sony BP-T24.
2. Do not dispose of the battery pack in a fire. The cell may explode. Check with local codes for possible special disposal instructions.
3. Do not open or mutilate the battery pack. Released electrolyte is corrosive and may cause damage to the eyes or skin. It may be toxic if swallowed.
4. Exercise care in handling battery pack in order not to short the battery with conducting materials such as rings, bracelets, and keys. The battery or conductor may overheat and cause burns.
5. Charge the battery pack provided with or identified for use with this product only in accordance with the instructions and limitations specified in the instruction manual provided for this product.
6. Observe proper polarity orientation between the battery pack and battery charger.

INFORMATION FOR GENERAL TELEPHONES

1. This equipment complies with Part 68 of the FCC rules. On the bottom of this equipment is a label that contains, among other information, the FCC certification number and ringer equivalence number (REN) for this equipment. If requested, this information must be provided to the telephone company.
2. The applicable certification jack (connector) USOC-RJ11C is used for this equipment.

3. This equipment is designed to be connected to the telephone network or premises wiring using a compatible modular jack that is Part 68 compliant.

The FCC compliant telephone cord and modular plug is provided with this equipment.

4. The REN is used to determine the quantity of devices that may be connected to the telephone line. Excessive RENs on the telephone line may result in the devices not ringing in response to an incoming call. Typically, the sum of the RENs should not exceed five (5.0). To be certain of the number of devices that may be connected to a line, as determined by the total RENs, contact the local telephone company.
5. If this equipment (SPP-A9276) causes harm to the telephone network, the telephone company will notify you in advance that temporary discontinuance of service may be required. But if advance notice isn't practical, the telephone company will notify the customer as soon as possible. Also, you will be advised of your right to file a complaint with the FCC if you believe it is necessary.
6. The telephone company may make changes in its facilities, equipment, operations or procedures that could affect the operation of the equipment. If this happens the telephone company will provide advance notice so you can make necessary modifications to maintain uninterrupted service.
7. If trouble is experienced with this equipment (SPP-A9276), for repair or warranty information, please contact Sony Direct Response Center: Tel 1-800-222-7669. If the equipment is causing harm to the telephone network, the telephone company may request that you disconnect the equipment until the problem is resolved.
8. All repairs will be performed in an authorized Sony service station.
9. This equipment cannot be used to party lines or coin lines.
10. This equipment is hearing aid compatible.

If your telephone is equipped with automatic dialers

When programming emergency numbers and (or) making test calls to emergency numbers:

1. Remain on the line and briefly explain to the dispatcher the reason for the call.
2. Perform such activities in the off-peak hours, such as early morning or late evenings.

Caution

You are cautioned that any changes or modifications not expressly approved in this manual could void your authority to operate this equipment.

Note

This equipment has been tested and found to comply with the limits for a Class B digital device, pursuant to Part 15 of the FCC Rules. These limits are designed to provide reasonable protection against harmful interference in a residential installation. This equipment generates, uses and can radiate radio frequency energy and, if not installed and used in accordance with the instructions, may cause harmful interference to radio communications. However, there is no guarantee that interference will not occur in a particular installation. If this equipment does cause harmful interference to radio or television reception, which can be determined by turning the equipment off and on, the user is encouraged to try to correct the interference by one or more of the following measures:

- Reorient or relocate the receiving antenna.
- Increase the separation between the equipment and receiver.
- Connect the equipment into an outlet on a circuit different from that to which the receiver is connected.
- Consult the dealer or an experienced radio/TV technician for help.

Table of contents

Getting Started

- 8 Read this first
- 9 Step 1: Checking the package contents
- 10 Step 2: Setting up the base phone
- 13 Step 3: Preparing the battery pack
- 15 Step 4: Entering the area code
- 19 Step 5: Setting up the phone services
- 22 Step 6: Setting the day and time
- 24 Identifying the parts

Basics

- 28 Making calls
- 33 Redialing
- 35 Receiving calls

Telephone Features

- 39 One-touch dialing
 - 39 Storing phone numbers and names
 - 41 Changing a stored name and/or phone number
 - 42 Making calls with one-touch dialing
- 43 Phone Directory
 - 43 Storing phone numbers and names
 - 44 Changing a stored name and/or phone number
 - 45 Erasing a memory location
 - 46 Making calls from the Phone Directory

- 48 Transferring the Phone Directory memory
- 50 Switching the phones during a call
 - 50 To switch from the base phone to the cordless handset
 - 50 To switch from the cordless handset to the base phone
- 51 Talking between the phones (Intercom)
 - 51 To talk from the cordless handset to the base phone
 - 52 To talk from the base phone to the cordless handset
- 53 Transferring a call
 - 53 To transfer from the base phone to the cordless handset
 - 54 To transfer from the cordless handset to the base phone

Answering Machine Features

- 55 Preparing the answering machine
 - 55 Adjusting the answering volume of the base phone
 - 56 Recording the greeting
 - 58 Selecting the ring time
 - 59 Selecting the recording quality
 - 60 Selecting the answering mode
 - 61 Setting the audible message indicator
 - 62 Turning on the answering function

- 63 Playing back messages
- 65 Erasing messages
- 66 Screening incoming calls
- 66 To screen incoming calls on the cordless handset
- 66 To answer the call
- 67 Recording a memo
- 68 Operating from an outside phone
- 68 Setting the remote ID code (security code)
- 69 Picking up new messages

Caller ID Features

- 70 Understanding the Caller ID service
- 70 When you receive a call
- 71 Looking at the Caller ID list
- 71 Viewing the Caller ID list
- 72 Erasing data from the Caller ID list
- 74 Using the Caller ID list
- 74 Calling back a number from the Caller ID list
- 76 Playing back a message from the Caller ID list
- 77 Storing a number of the Caller ID list into the Phone Directory
- 78 To change the number of digits of the phone number
- 80 Using “Caller ID with call waiting” service

Additional Information

- 81 Mounting the base phone on a wall
- 82 Carrying the cordless handset by the belt clip
- 84 Notes on power sources
- 85 Maintenance
- 86 Troubleshooting
- 91 Specifications
- 92 **Index**

Back cover LIMITED WARRANTY

Read this first

Before you use your phone, you must first set it up. Here's a quick way to set up your phone: Steps 1 to 6.

Step 1 (page 9)

First, unpack the phone and the supplied accessories.



Base phone

Step 2 (pages 10 to 12)

You need to do three things to set up the base phone, including finding the best location for the base phone.

Step 3 (pages 13 to 14)

Insert the battery pack into the cordless handset and charge it for more than 12 hours.

Step 4 (pages 15 to 18)

Enter the area code to use the Caller ID service.

Step 5 (pages 19 to 21)

Set up the “Caller ID with call waiting” service and the Long Distance Saver function.

Step 6 (pages 22 to 23)

Finally, set the day and time to stamp day and time for the incoming messages.



Cordless handset

That's it!

Step 1

Checking the package contents

Make sure you have received the following items in the package.
If anything is missing, contact your local Sony dealer.

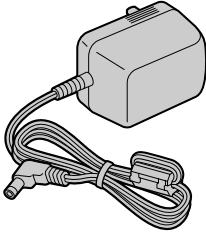

AC power adaptor (AC-T107)



Base phone



Cordless handset

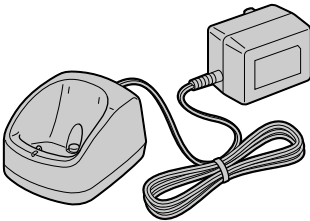

Charger

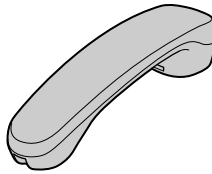

Handset

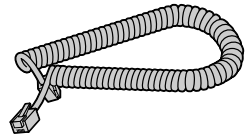

Handset cord

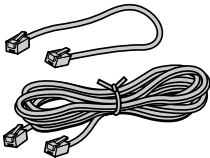

Telephone line cords (2)

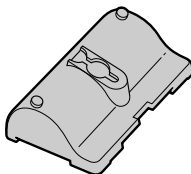

Wall bracket/
stand for base
phone

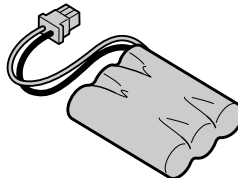

Rechargeable
battery pack
(BP-T24)

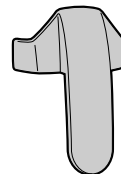

Belt clip

Step 2

Setting up the base phone

Do the following steps:

- Choose the best location
- Connect the base phone
- Choose the dialing mode

Choose the best location

Where you place the base phone affects the reception quality of the cordless handset.

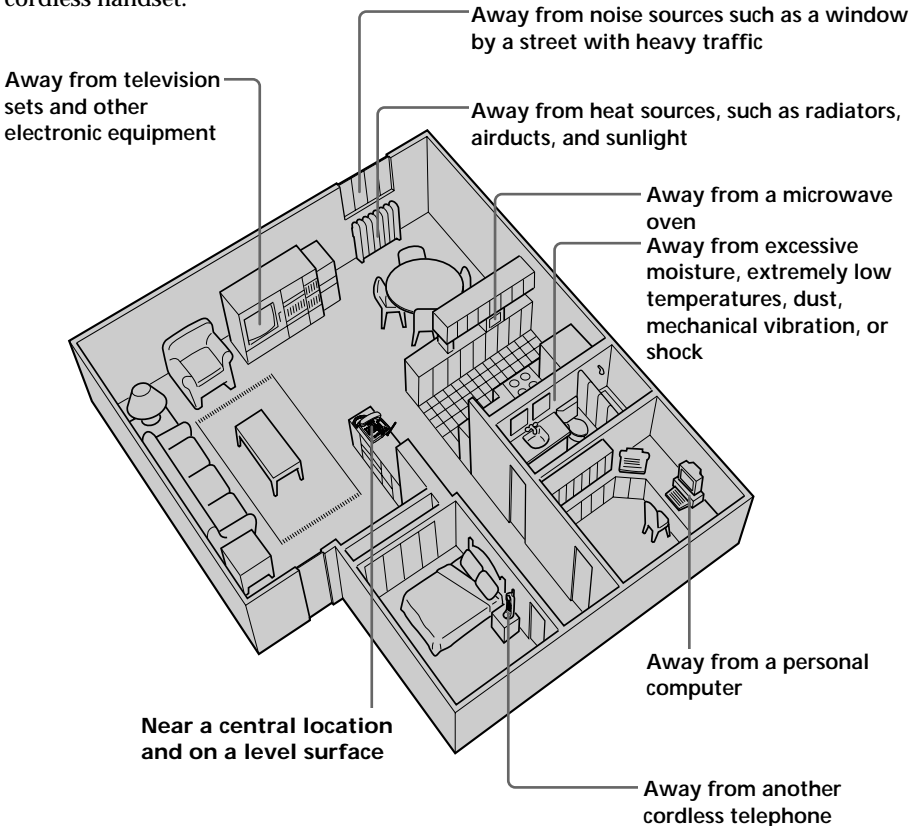

CAUTION:

- Should you experience intermittent loss of audio during a conversation, try moving closer to the base or move base phone away from other noise sources.
- The cordless telephone operates at a frequency that may cause interference to nearby TVs and VCRs; the base phone should not be placed near or on the top of a TV or VCR; and, if interference is experienced, moving the cordless telephone farther away from the TV or VCR will often reduce or eliminate the interference.

Connect the base phone

If you want to hang the base phone on the wall, see page 81.

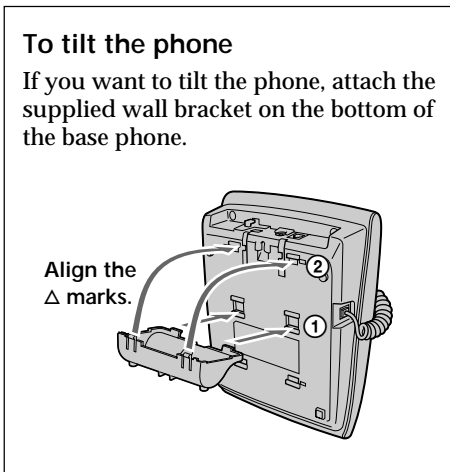
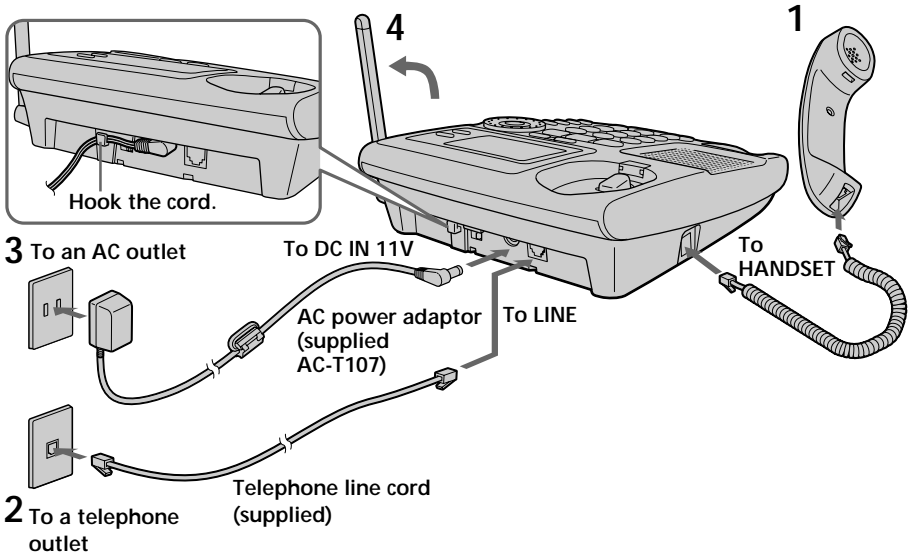

To tilt the phone

If you want to tilt the phone, attach the supplied wall bracket on the bottom of the base phone.

- 1** Connect the handset cord to the HANDSET jack and to the handset.
- 2** Connect the telephone line cord to the LINE jack and to a telephone outlet.
- 3** Connect the AC power adaptor to the DC IN 11V jack and to an AC outlet.
- 4** Raise the antenna. Make sure it points towards the ceiling.

continued

Step 2: Setting up the base phone (continued)

Notes

- Use only the supplied AC-T107 AC power adaptor. Do not use any other AC power adaptor.
- Connect the AC power adaptor to a continuous power supply.
- Place the base phone close to the AC outlet so that you can unplug the AC power adaptor easily.

Polarity of the plug

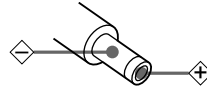

Tip

If your telephone outlet is not modular, contact your telephone service company for assistance.

Modular



Choose the dialing mode

For the telephone to work properly, select an appropriate dialing mode (tone or pulse).

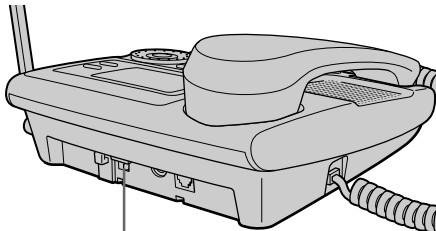

DIAL MODE switch

Depending on your dialing system, set the DIAL MODE switch as follows:

If your dialing system is	Set the switch to
Tone	T
Pulse	P

If you aren't sure of your dialing system

Make a trial call with the DIAL MODE switch set to T. If the call connects, leave the switch as is; otherwise, set to P.

Step 3

Preparing the battery pack

Charge the battery pack for more than 12 hours before you start using your cordless handset.

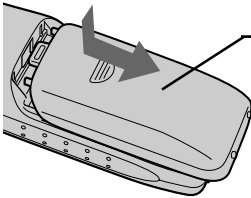

- 1** Slide open the battery compartment lid of the cordless handset.

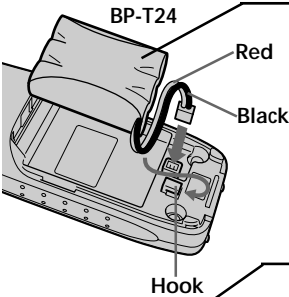

- 2** Connect the battery connector with correct polarity (black wire goes on lower side and red wire goes on upper side).

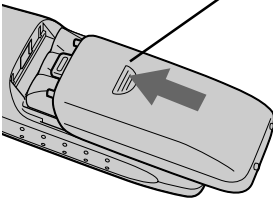

- 3** Hook the cords and insert the battery pack. Then close the lid.

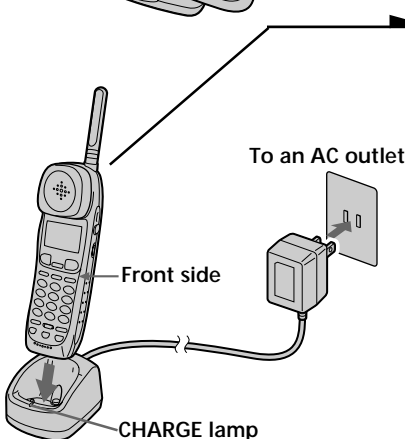

- 4** Connect the AC power adaptor to an AC outlet and place the cordless handset on the charger. The CHARGE lamp on the charger lights up when the cordless handset is properly seated on the charge terminals of the charger. Charge the battery pack for more than 12 hours so that the battery is fully charged. The CHARGE lamp remains lit even after charging is completed.

continued

Step 3: Preparing the battery pack (continued)

Battery duration

A fully charged battery pack lasts for about:

- Approx. 5 hours when you use the cordless handset continuously
- Approx. 6 days when the cordless handset is in standby mode.

Notes

- The battery pack will gradually discharge over a long period of time, even when not in use.
- If you leave the battery pack in the cordless handset without charging it, the battery pack will be completely discharged.
It may require several times of charging to recover to its full capacity.
- While charging, the battery pack warms up. This is not a malfunction.

To obtain the best performance from the battery

Do not place the cordless handset on the charger after each call. The battery works best if the cordless handset is returned to the charger after two or three calls. However, do not leave the cordless handset off the charger for a long period of time as this will completely discharge the battery pack.

When to purchase a new battery pack

If the battery lasts only a few minutes even after **12 hours** of charging, the usable life of the battery has expired and needs replacement. Contact your local Sony authorized dealer or service center, and ask for a Sony **BP-T24** rechargeable battery pack.

Note

Battery life may vary depending on usage condition and ambient temperature.

Step 4

Entering the area code

When you use this phone for the first time, or move to an area that has a different area code, you must enter the area code. Otherwise, you cannot use some functions of this phone and the Caller ID functions.

This is also necessary because the phone must be able to select an area code to properly dial a call from the Caller ID list.

Depending on your region, enter the 3-digit area code as follows:

Case 1.

If 7-digit dialing (no area code) is accepted for local calls in your area, see "To enter your home area code" below.

If you live in an area where calls from or to other local areas can also be made by 10-digit dialing (area code + number), you can register up to 5 local area codes with this telephone to take advantage of this system. See "To enter the local area code (For 10 digits phone number users)" on page 17.

Case 2.

If 10-digit dialing (area code + number) is required for all local calls in your area, see "To enter the local area code (For 10 digits phone number users)" on page 17.

Entering the area code is only possible on the base phone.

To enter your home area code

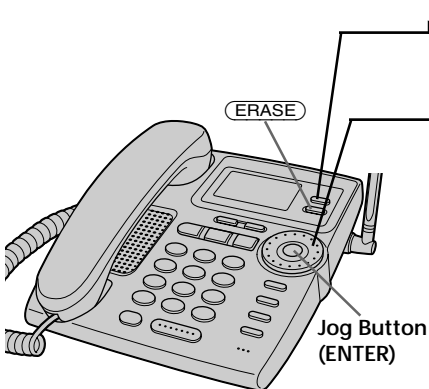

1 Press **PROGRAM**.

2 Turn Jog Dial to choose "BASE SETTINGS", and then press Jog Button (ENTER).

```

BASE SETTINGS
【GO BACK】
▶ AREA CODE
PHONE SERVICES
CLOCK
  
```

3 Press Jog Button (ENTER).

```

AREA CODE
【GO BACK】
▶ HOME :
LOCAL 1:
↓ LOCAL 2:
  
```

continued

Step 4: Entering the area code (continued)

4 Press Jog Button (ENTER) again.
“ENTER HOME AREA CODE.” appears on the display.

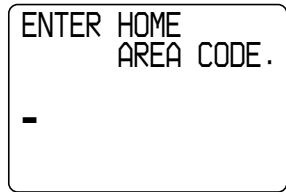

5 Enter the three digits of your home area code using the dialing keys.

6 Press (PROGRAM).

You hear a long confirmation beep.

Notes

- If the home area code is already entered, it appears on the display in step 3. To enter a different home area code, see “To change the home area code” below.
- Do not allow more than 20 seconds to elapse during the operation procedure.
- If the area code has not been entered, calling back from the Caller ID list and storing the Caller ID data into the Phone Directory cannot be performed.
- If the home area code is not correctly entered, “SEND TO CORDLESS HANDSET FAILED.” will appear on the display and five short error beeps will be heard after (PROGRAM) is pressed in step 6. Move the cordless handset closer to the base phone, and then start over the procedure.

Tips

- When you select “[GO BACK]”, you can return to the previous set display by pressing Jog Button (ENTER).
- You may press Jog Button (ENTER) instead of (PROGRAM) in step 6.
- To check the current home area code, perform steps 1 to 3. The home area code appears on the display for about 20 seconds.

To change the home area code

1 Perform steps 1 to 4 on pages 15 to 16.

The current home area code appears on the display.

2 Press (ERASE) to erase the current home area code.

3 Enter a new home area code using the dialing keys.

4 Press (PROGRAM).

You hear a long confirmation beep.

To erase the home area code

You can erase the home area code. Perform steps 1 and 2 above, then press (PROGRAM).

The home area code will be erased, and you hear a long confirmation beep.

To enter the local area code (For 10 digits phone numbers users)

If a call matches one of the local area codes you entered, the phone number will be registered with 10 digits in the Caller ID list (area code + number). If a call does not match one of the local area codes you entered, the phone number will be registered with 11 digits in the Caller ID list (1 + area code + number). Some regions of the country allow you to have more than one local area code. (Up to five local area codes can be entered in this phone.)

- 1 Perform steps 1 to 3 on page 15.
- 2 Select the number (“LOCAL 1” to “LOCAL 5”) to enter the local area code by turning Jog Dial.

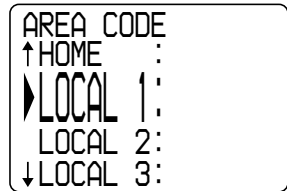

- 3 Press Jog Button (ENTER).

“ENTER LOCAL AREA CODE 1.” appears on the display when you select “LOCAL 1” in step 2.

- 4 Enter the three digits of the local area code using the dialing keys.
- 5 Press **(PROGRAM)**.

You hear a long confirmation beep.

Notes

- If the local area code is already entered, it appears on the display in step 2. To enter a different local area code, see “To change the local area code” on page 18.
- Do not allow more than 20 seconds to elapse during the operation procedure.
- If the local area code is not correctly entered, “SEND TO CORDLESS HANDSET FAILED.” will appear on the display and five short error beeps will be heard after **(PROGRAM)** is pressed in step 5. Move the cordless handset closer to the base phone, and then start over the procedure.

Tips

- When you select “[GO BACK]”, you can return to the previous set display by pressing Jog Button (ENTER).
- You may press Jog Button (ENTER) instead of **(PROGRAM)** in step 5.
- To check the current local area code, perform steps 1 and 2. The local area code appears on the display for about 20 seconds.

continued

Step 4: Entering the area code (continued)

To change the local area code

1 Perform steps 1 to 3 on page 17.

The current local area code appears on the display.

2 Press **(ERASE)** to erase the current local area code.

3 Enter a new local area code using the dialing keys.

4 Press **(PROGRAM)**.

You hear a long confirmation beep.

To erase the local area code

You can erase the local area code. Perform steps 1 and 2 on page 17, then press **(PROGRAM)**. The local area code will be erased, and you hear a long confirmation beep.

Step 5

Setting up the phone services

Set up the “Caller ID with call waiting” service and the Long Distance Saver function before use. Setting up the phone services is only possible on the base phone.

To set up the “Caller ID with call waiting” service

In order to use this service, you must first subscribe to “Caller ID with call waiting” service (see page 80). The “Caller ID with call waiting” service is preset to “ACTIVE”.

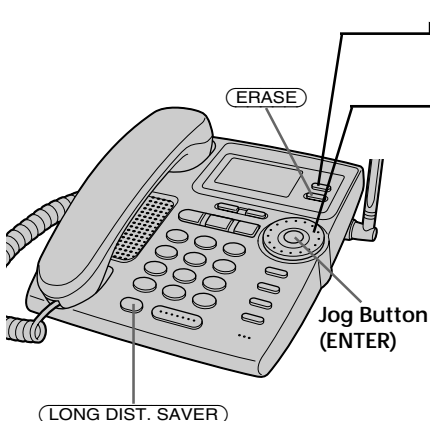

- 1 Press **PROGRAM**.
- 2 Turn Jog Dial to choose “BASE SETTINGS”, and then press Jog Button (ENTER).
- 3 Turn Jog Dial to choose “PHONE SERVICES”, and then press Jog Button (ENTER).

```
PHONE SERVICES
【GO BACK】
▶CALL WAITING ID
LONG DISTANCE
```

- 4 Press Jog Button (ENTER).

```
CALL WAITING ID
【GO BACK】
▶ACTIVE
INACTIVE
```

- 5 Turn Jog Dial to choose “ACTIVE” or “INACTIVE”, and then press Jog Button (ENTER). You hear a long confirmation beep.

continued

Step 5: Setting up the phone services (continued)

Note

Do not allow more than 20 seconds to elapse during the operation procedure.

Tip

When you select “[GO BACK]”, you can return to the previous set display by pressing Jog Button (ENTER).

To set up the Long Distance Saver function

Many telephone companies and service providers nowadays offer low-rate long distance calls separate from your standard long distance provider. Such services are usually initiated by dialing an access number prior to the long distance call itself.

The Long Distance Saver function enables you to dial the access number of these special long distance service companies by pressing just (LONG DIST. SAVER). After setting up the access number and activating the button function in the menu, you only need to press (LONG DIST. SAVER) for dialing the access number of your special long distance carrier.

In order to use this function, you must first activate the button function by memorizing the access number of your choice in the menu and by setting the long distance menu function to “ACTIVE”

The long distance menu is preset to “INACTIVE”, no preset access number is registered.

To set up the access number

- 1 Perform steps 1 and 3 on page 19.
- 2 Turn Jog Dial to choose “LONG DISTANCE”, and then press Jog Button (ENTER).
- 3 Turn Jog Dial to choose “ACCESS NUMBER”, and then press Jog Button (ENTER).
- 4 Enter the access number using the dialing keys.
- 5 Press (PROGRAM).
- 6 Turn Jog Dial to choose “YES” to activate (LONG DIST. SAVER), and then press Jog Button (ENTER).

You hear a long confirmation beep.

Notes

- DO NOT USE (LONG DIST. SAVER) to dial EMERGENCY services, customer service numbers, your local telephone company, local numbers or toll free numbers.
- If you press (LONG DIST. SAVER) twice, the dialing of the registered access number is cancelled and “[LONG DISTANCE]” disappears from the display.
- If the access number is not correctly set, “SEND TO CORDLESS HANDSET FAILED.” will appear on the display and five short error beeps will be heard after Jog Button (ENTER) is pressed in step 6. Move the cordless handset closer to the base phone, and then start over the procedure.
- You can register up to 24 digits as an access number.

To change the access number

- 1 Perform steps 1 and 3 on page 20.

The current access number appears on the display.

- 2 Press (ERASE) to erase the current access number.
- 3 Enter a new access number using the dialing keys.
- 4 Press (PROGRAM).
- 5 Turn Jog Dial to choose “YES” to activate (LONG DIST. SAVER), and then press Jog Button (ENTER).
You hear a long confirmation beep.

To activate/deactivate the Long Distance Saver function

- 1 Perform steps 1 to 3 on page 19.
- 2 Turn Jog Dial to choose “LONG DISTANCE”, and then press Jog Button (ENTER).
- 3 Turn Jog Dial to choose “ACTIVE” or “INACTIVE” (to deactivate), and then press Jog Button (ENTER).
You hear a long confirmation beep.

Notes

- If you choose “INACTIVE” in step 3, (LONG DIST. SAVER) will be deactivated and you cannot use (LONG DIST. SAVER) even with a registered access number until the function is activated again.
- Some Long Distance services may not be available in your state. Prices and conditions may vary. For details, contact your telephone company or your long distance provider. Some long distance call programs require a subscription with the carrier company before usage.
- If it is not correctly set in “ACTIVE” or “INACTIVE”, “SEND TO CORDLESS HANDSET FAILED.” will appear on the display and five short error beeps will be heard after Jog Button (ENTER) is pressed in step 3. Move the cordless handset closer to the base phone, and then start over the procedure.

Step 6

Setting the day and time

Set the day and time so that you can stamp day and time for the incoming messages. You will hear the recorded day and time when you play back messages.

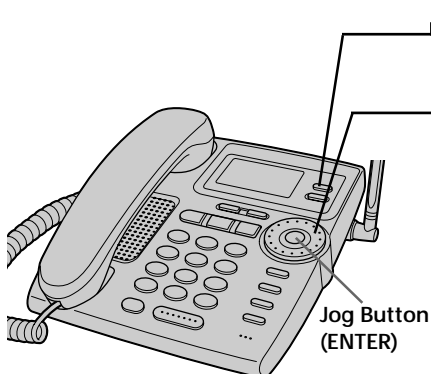

1 Press (PROGRAM).

2 Turn Jog Dial to choose “BASE SETTINGS”, and then press Jog Button (ENTER).

3 Turn Jog Dial to choose “CLOCK”, and then press Jog Button (ENTER).

CLOCK
【 GO BACK 】
▶ SUNDAY
MONDAY
↓ TUESDAY

4 Set the correct day of the week by turning Jog Dial, and then press Jog Button (ENTER).

ENTER HOUR AND
PRESS JOG BUTTON
12:00AM

- 5** Set the hour (1 to 12) by turning Jog Dial, and then press Jog Button (ENTER).

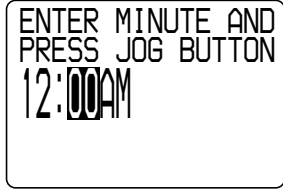

- 6** Set the minute (00 to 59) by turning Jog Dial, and then press Jog Button (ENTER).

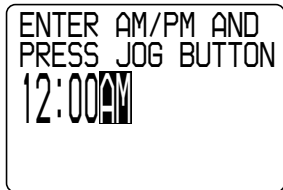

- 7** Choose “AM” or “PM” by turning Jog Dial, and then press Jog Button (ENTER).

You hear a long confirmation beep and the day and time you just entered is announced. Then the phone starts counting time.

Notes

- Do not allow more than 60 seconds to elapse during the operation procedure.
- “SUN 12:00AM” on the display of the base phone flashes when the day and time is cleared due to a power interruption, or when you connect the base phone to the AC outlet for the first time.
- If the current day and time are not set, you will not hear a time stamp when you play back recorded messages.

Tip

When you select “[GO BACK]”, you can return to the previous set display by pressing Jog Button (ENTER).

Identifying the parts

Refer to the pages indicated in parentheses for details.

Base phone

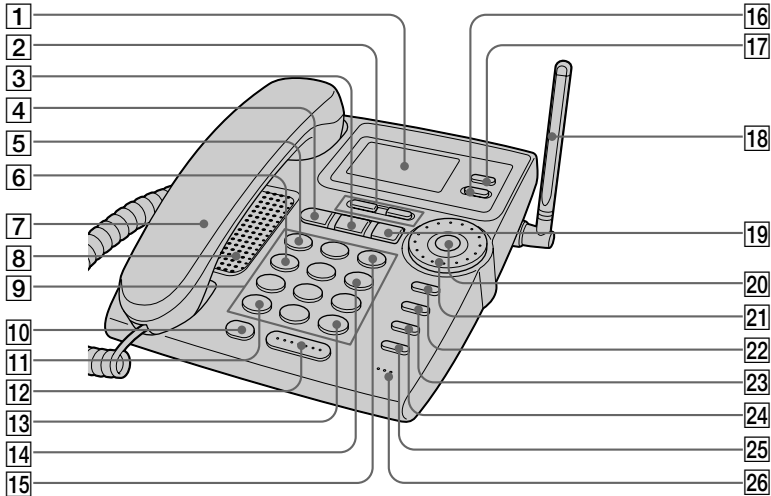

1 Display window (p. 31, 63, 70)

2 VOLUME +/- buttons
(p. 32, 64)

Adjusts the handset or speaker volume.

3 PLAY/STOP button (p. 63)
Plays back recorded messages.

4 ANSWER ON/OFF button
(p. 62, 63)
Turns the answering function on or off. Lights when the answering function is on, and flashes when a new message is recorded.

5 ◀◀ REPEAT button (p. 64)
Press once to repeat the current message or twice to go back to the previous message.

6 REVIEW button (p. 64)
Keep the button pressed for a playback review of the current message.

7 Handset (p. 11, 31, 37)

8 Speaker

9 Dialing keys (p. 31)

10 LONG DIST. SAVER button
(p. 20, 31)

Lets you make a long distance call with the registered access number.

11 * TONE button (p. 32)

Allows you to switch temporarily to tone dialing.

12 SPEAKERPHONE button
(p. 31)

Lets you make or receive a call.

13 # button (p. 78)

Used to change the number of digits of the phone number in the Caller ID list.

14 QUICK button (p. 64)

Keep the button pressed for quick playback of messages.

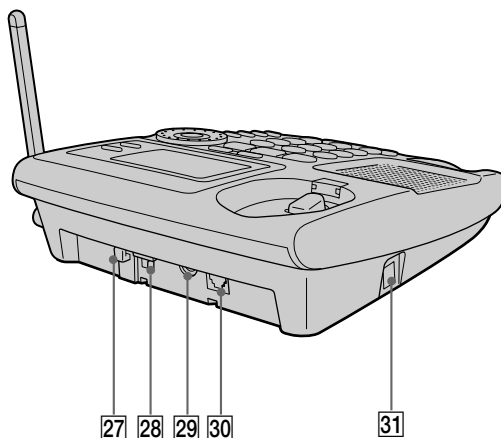

- | | |
|--|--|
| <p>15 ►► SKIP button (p. 64)
Press to skip to the next message.</p> <p>16 ERASE button (p. 16, 21, 65)</p> <p>17 PROGRAM button (p. 15)</p> <p>18 Antenna (p. 11, 81)</p> <p>19 MEMO button (p. 67)
Records a memo message.</p> <p>20 Jog Button (ENTER) (p. 15)</p> <p>21 Jog Dial (p. 15, 71)</p> <p>22 REDIAL/PAUSE button (p. 33)
Redials one of the last five numbers called/inserts a pause in the dialing sequence.</p> <p>23 INTERCOM button (p. 52)
Lets you talk between the base phone and cordless handset.</p> | <p>24 CALL WAITING/FLASH button (p. 32, 80)
Switches to a second call if you have “call waiting” service, or lets you make a new call.</p> <p>25 HOLD button (p. 32)
Puts a call on hold.</p> <p>26 MIC (microphone) (p. 56, 67)</p> <p>27 Hook for AC power adaptor cord (p. 11, 81)</p> <p>28 DIAL MODE switch (p. 12)
Selects pulse or tone dialing.</p> <p>29 DC IN 11V jack (p. 11, 81)</p> <p>30 LINE (telephone line) jack (p. 11, 81)</p> <p>31 HANDSET jack (p. 11)</p> |
|--|--|

continued

Identifying the parts (continued)

Cordless handset

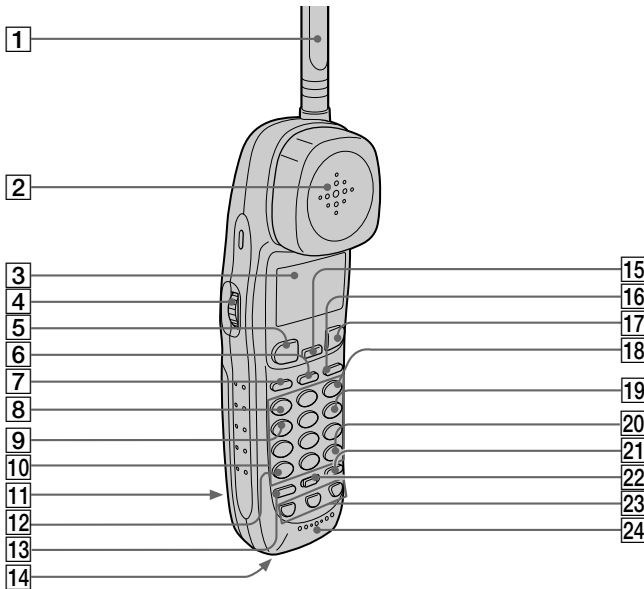

- | | |
|--|--|
| <p>1 Antenna</p> <p>2 Speaker [EZfit] (p. 30)</p> <p>3 Display window (p. 28, 70)</p> <p>4 Jog Dial (p. 39, 71)</p> <p>5 TALK button (p. 28)
Lets you make or receive a call.</p> <p>6 INTERCOM button (p. 51)
Lets you talk between the base phone and the cordless handset.</p> <p>7 LONG DIST. SAVER button (p. 20, 29)
Lets you make a long distance call with the registered access number.</p> <p>8 ◀◀ REPEAT button (p. 64)
Press once to repeat the current message or twice to go back to the previous message.</p> | <p>9 REVIEW button (p. 64)
Keep the button pressed for a playback review of the current message.</p> <p>10 Dialing keys (p. 28)</p> <p>11 Battery compartment (p. 13)</p> <p>12 * TONE button (p. 29)
Allows you to switch temporarily to tone dialing.</p> <p>13 HOLD/PLAY BACK button (p. 29, 63, 66)
Puts a call on hold/plays back recorded messages.</p> <p>14 RING switch (p. 36)
Switches the ringer to on/off.</p> |
|--|--|

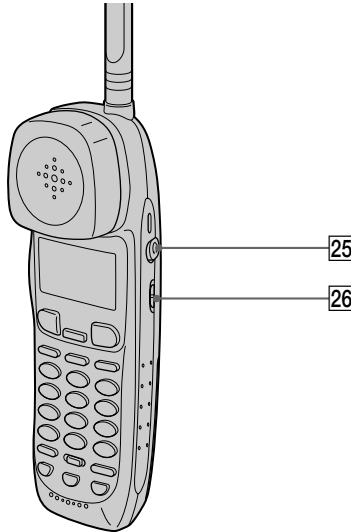

15 CALL WAITING/FLASH button
(p. 29, 80)

Switches to a second call if you have “call waiting” service, or lets you make a new call.

16 REDIAL/PAUSE button
(p. 33, 41)

Redials one of the last five numbers called/inserts a pause in the dialing sequence.

17 OFF button (p. 28)

Allows you to disconnect the call.

18 ►► SKIP button (p. 64)

Press to skip to the next message.

19 QUICK button (p. 64)

Keep the button pressed for quick playback of messages.

20 # button (p. 78)

Used to change the number of digits of the phone number in the Caller ID list.

21 PROGRAM button (p. 39)

22 ERASE button (p. 41, 65)

23 ONE-TOUCH DIAL (A, B, C) buttons (p. 42)

24 Microphone

25  (HEADSET) jack (p. 28, 35, 83)

26 VOL (volume) switch (p. 29)

Adjust the cordless handset volume.

Making calls

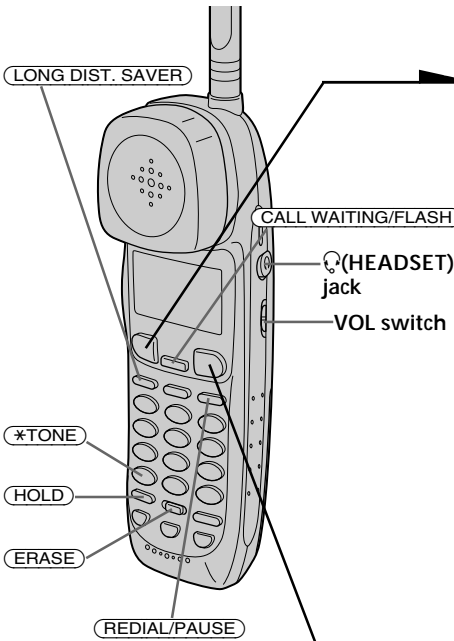

1 Pick up the cordless handset from the charger.

2 Press **TALK** and wait until “TALK” appears on the display and the display also shows the talk time in hours, minutes and seconds.

The dialing keys light up.

You then hear a dial tone.

“CORDLESS HANDSET IN USE” appears on the display of the base phone.

If you hear five short error beeps and “OUT OF RANGE” appears on the display, move closer to the base phone.

3 Dial the phone number.

4 When you’re done talking, press **OFF** or replace the cordless handset on the charger.

The display turns off.

To make a call after checking the phone number

You can dial the phone number before pressing **TALK** or **LONG DIST. SAVER**. If you make a mistake when dialing the phone number, press **ERASE** to erase the number.

Making calls when the headset is connected

When a headset (optional) is connected to the  (HEADSET) jack on the cordless handset, you can talk through the headset.

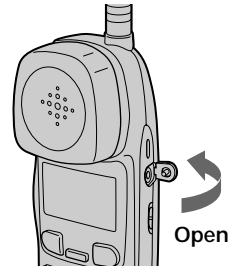

Making calls using the Long Distance Saver function

Set the menu for the Long Distance Saver function to “ACTIVE”. See “To set up the Long Distance Saver function” on page 21.

- 1 Pick up the cordless handset from the charger.
- 2 Press **(LONG DIST. SAVER)**.
 “[LONG DISTANCE]” appears on the display.
 To cancel this function, press **(LONG DIST. SAVER)** again or press **(TALK)**.
- 3 Dial the long distance phone number (e.g., 1-201-123-4567, or 011-...).
- 4 When you’re done talking, press **(OFF)** or replace the cordless handset on the charger.

To make a call via Private Branch Exchange (PBX)

Before pressing **(LONG DIST. SAVER)** in step 2 above, enter the outside line access digit (e.g., 9).



Additional tasks

To	Do this
Adjust the cordless handset volume	Set the VOL switch to H (high), M (middle) or L (low).
Put a call on hold	Press (HOLD) . “HOLD” appears on the display. Press (HOLD) again or pick up the cordless handset from the charger (When Quick talk is set to “USE”; see page 36) to resume the conversation.
Switch to tone dialing temporarily	Press (*TONE) after you’re connected. The line will remain in tone dialing until disconnected.
Switch to another call (“call waiting” service*)	Press (CALL WAITING/FLASH) . Press (CALL WAITING/FLASH) again to return to the first caller.

* You need to subscribe to this service from your telephone company.

Making calls (continued)

Notes

- When making a call on the cordless handset, “” appears on the display indicating the receiver sensitivity with the base phone. Three bars indicate a good reception, no bar indicates a bad reception. When calling from an area with poor reception, you may experience interference or the call may be disconnected, so try to use the cordless handset in areas that have a good reception.
- When you increase the sound volume, in some cases the back ground noise may be increased as well. You should adjust the volume accordingly.
- If the cordless handset beeps every second during a conversation and “” appears on the display, move closer to the base phone; otherwise, you will hear five short error beeps and “OUT OF RANGE” will appear on the display, and the call will be disconnected after 30 seconds.
- While talking with an outside caller via the base phone, you cannot make a call with the cordless handset. If you press **(TALK)**, “BASEPHONE IN USE” appears on the display and you will hear a busy tone.
- When the talk time exceeds 9:59:59, the display counts from 0:00:00 again.

EZfit

The “EZfit” adjusts to fit any shape ear, thereby ensuring clear voice reception.

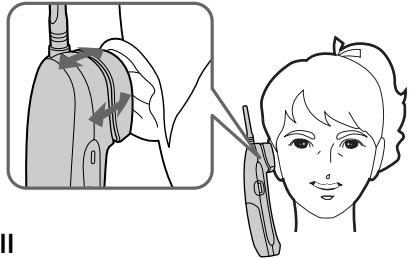

If the battery becomes weak during a call

The cordless handset will beep twice per second, “BATTERY LOW” appears on the display. Finish your call and replace the cordless handset on the charger to charge the battery pack. Or, to continue your phone conversation with the base phone, press **(HOLD)** on the cordless handset to hold the line, and then pick up the handset or press **(SPEAKERPHONE)** on the base phone.

For optimum performance, charge the battery for a full 12 hours.

Note that during the initial charge time (approx. 10 minutes), “PLEASE WAIT...” and “BATTERY LOW” appear on the display and the cordless handset cannot be used.

After “BATTERY LOW” turns off, you may be able to use the cordless handset, but the battery duration will be very short; thus it is recommended that you **fully charge** the battery before next use.

Making calls with the base phone

Pick up the handset or press **(SPEAKERPHONE)** on the base phone. "TALK" or "SPEAKERPHONE" appears on the display and the display also shows the talk time in hours, minutes and seconds.

Dial the phone number.

When you're done talking, replace the handset in the cradle or press **(SPEAKERPHONE)** again.

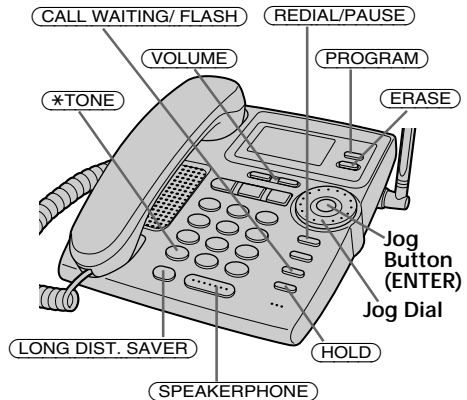

To make a call after checking the phone number

You can dial the phone number before picking up the handset or before pressing **(SPEAKERPHONE)**. If you make a mistake when dialing the phone number, press **(ERASE)** to erase the number.

Making calls using the Long Distance Saver function

Set the menu for the Long Distance Saver function to "ACTIVE". See "To set up the Long Distance Saver function" on page 21.

- 1 Pick up the handset or press **(SPEAKERPHONE)** on the base phone.
- 2 Press **(LONG DIST. SAVER)**.
 "[LONG DISTANCE]" appears on the display.
 To cancel this function, press **(LONG DIST. SAVER)** again.
- 3 Dial the long distance phone number (e.g., 1-201-123-4567, or 011-...).
- 4 When you're done talking, replace the handset in the cradle or press **(SPEAKERPHONE)** again.

To make a call via Private Branch Exchange (PBX)

Before pressing **(LONG DIST. SAVER)** in step 2 above, enter the outside line access digit (e.g., 9).

continued

Making calls (continued)

Additional tasks

To	Do this
Adjust the handset or speakerphone volume	During phone conversation, press (VOLUME) (+) or (-) . There are 3 steps for the handset volume level, and 7 steps for the speakerphone volume level.
Put a call on hold	Press (HOLD) . "HOLD" appears on the display. Press (HOLD) , (SPEAKERPHONE) , or pick up the handset from the base phone to resume the conversation.
Switch to tone dialing temporarily	Press (*TONE) after you're connected. The line will remain in tone dialing until disconnected.
Switch to another call ("call waiting" service*)	Press (CALL WAITING/ FLASH) . Press (CALL WAITING/ FLASH) again to return to the first caller.

* You need to subscribe to the service from your telephone company.

Notes

- While talking with an outside caller via the cordless handset, the display on the base phone shows "CORDLESS HANDSET IN USE" and you cannot make a call with the base phone.
- When the talk time exceeds 9:59:59, the display counts from 0:00:00 again.

Tip

You can switch between phone conversations via the handset and those via the speakerphone, simply by picking up the handset while talking over the speakerphone, or by pressing **(SPEAKERPHONE)** while talking over the handset.

To obtain the best speakerphone performance

- You may not be able to hear the other party's voice in a noisy place. Therefore, use the speakerphone in a quiet room.
- Do not bring your hand or other object too close to the microphone or you will hear a shrill noise ("feedback").
- When the speaker volume is loud, or the base phone has been placed close to a wall, you may find that the volume drops suddenly. This is due to a circuit in the telephone designed to protect against feedback. In such cases, lower the speaker volume slightly.

Redialing

Both the base phone and the cordless handset can each individually store five dialed phone numbers.

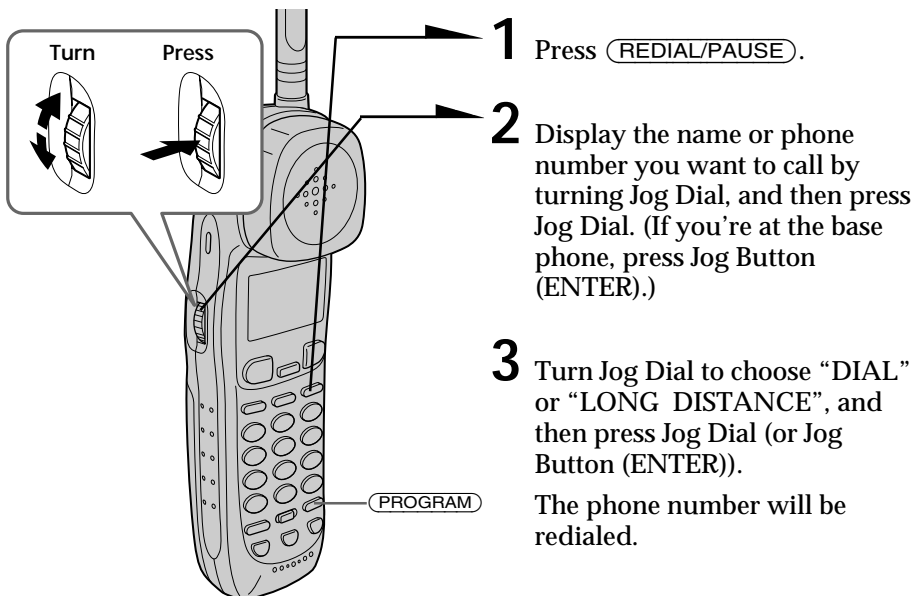

Notes

- When the Long Distance Saver function is set to "ACTIVE", "LONG DISTANCE" call can be made (see page 21).
- The redial memory only registers up to 30 digits. Exceeding numbers will not be redialed.
- In the case of a power failure, only the redial on the base phone will be erased.
- The redial button does not store the access number of the Long Distance Saver. To redial a long distance call, press **LONG DIST. SAVER**, then **REDIAL/PAUSE**.

Tips

- When "→" is displayed on the right end of the phone number on the redial list in step 2, it means that some number follows the displayed phone number. Moreover, when the phone number is selected by turning Jog Dial, all of the phone number is displayed in two lines.
- If you redial the same number repeatedly, this number will only be counted as one number of the total five registered numbers that can be redialed.
- When dialing from a phone number with a registered name, that name will be displayed in the list in step 2.

continued

Making calls (continued)

To store the dialed phone number into the Phone Directory

- 1 Display the name or phone number you want to store by doing steps 1 and 2 on page 33.
- 2 Turn Jog Dial to choose “PROGRAM”, and then press Jog Dial. (If you’re at the base phone, press Jog Button (ENTER).)
- 3 Enter the name by doing steps 4 and 5 on page 40.
- 4 Turn Jog Dial to choose “[PGM]”, and then press Jog Dial (or Jog Button (ENTER)).

You hear a long confirmation beep, and the name and the number are stored.

Note

The dialed phone numbers of up to 20 digits can be stored in the Phone Directory.

To erase the dialed phone number one by one

- 1 Display the name or phone number you want to erase by doing steps 1 and 2 on page 33.
- 2 Turn Jog Dial to choose “ERASE REDIAL”, and then press Jog Dial. (If you’re at the base phone, press Jog Button (ENTER).)
- 3 Turn Jog Dial to choose “YES”, and then press Jog Dial (or Jog Button (ENTER)).

You hear a long confirmation beep, and the number is erased.

To erase the entire dialed phone numbers at once

- 1 Press (PROGRAM).
- 2 Turn Jog Dial to choose “MEMORY MANAGE”, and then press Jog Dial. (If you’re at the base phone, press Jog Button (ENTER).)
- 3 Turn Jog Dial to choose “ERASE ALL RDL”, and then press Jog Dial (or Jog Button (ENTER)).
- 4 Turn Jog Dial to choose “ERASE REDIAL”, and then press Jog Dial (or Jog Button (ENTER)).

You hear a long confirmation beep, and the entire number are erased.

Receiving calls

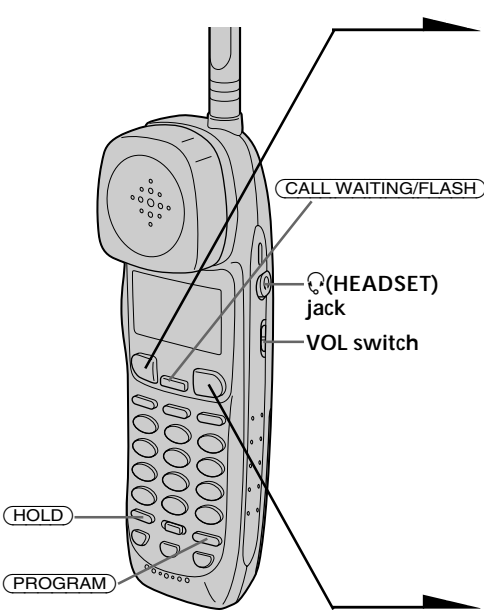

- 1** When you hear the phone ring:
- Press **TALK**.
- or
- Pick up the cordless handset from the charger when the cordless handset is placed on the charger. (When Quick talk is set to "USE"; see page 36)
- "TALK" appears on the display and the display also shows the talk time in hours, minutes and seconds.

"CORDLESS HANDSET IN USE" appears on the display of the base phone.

- 2** When you're done talking, press **OFF** or replace the cordless handset on the charger. The display turns off.

Receiving calls when the headset is connected

When a headset (optional) is connected to the (HEADSET) jack on the cordless handset, you can talk through the headset.

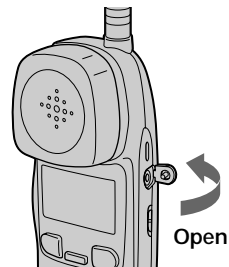

continued

Basics

35^{US}

Receiving calls (continued)

Additional tasks

To	Do this
Adjust the cordless handset volume	Set the VOL switch to H (high), M (middle) or L (low).
Put a call on hold	Press (HOLD) . "HOLD" appears on the display. Press (HOLD) again or pick up the cordless handset from the charger (When Quick talk is set to "USE"; see below) to resume the conversation.
Switch to another call ("call waiting" service*)	Press (CALL WAITING/FLASH) . Press (CALL WAITING/FLASH) again to return to the first caller.
Receive a call by only picking up the cordless handset from the charger, without pressing (TALK) (Quick talk)	Press (PROGRAM) . Turn Jog Dial to choose "QUICK TALK", then press Jog Dial. Turn Jog Dial to choose "USE", then press Jog Dial.

* You need to subscribe to this service from your telephone company.

Note

If there is an incoming call during intercom conversation, intercom call will be disconnected, and both the base phone and the cordless handset will ring.

Tip

To inform you of an incoming call, the display shows "** RINGING **" even when you set the RING switch on the cordless handset to OFF.

If you have subscribed to the Caller ID service;

- the caller's number and/or name appears on the display when you receive a call (see page 70) or when another call comes in by "call waiting" service.
- the name stored in the one-touch dialing or Phone Directory appears on the display if the call matches the number stored on ONE-TOUCH DIAL buttons or in the Phone Directory (memory match function; see page 70).
- the ringer sound changes to a higher tone if the call matches the number VIP stored on ONE-TOUCH DIAL buttons or in the Phone Directory (memory match function; see page 70).

To turn the ringer off

Set the RING switch on the bottom to OFF.

"[RINGER OFF]" appears on the display.

The cordless handset won't ring. You can still make calls, and also receive calls if another telephone connected to the same line rings to inform you on incoming calls. You can also receive an intercom call.

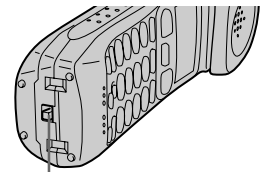

RING switch

Receiving calls with the base phone

When you hear the phone ring, pick up the handset or press **(SPEAKERPHONE)** on the base phone.

“TALK” or “SPEAKERPHONE” appears on the display and the display also shows the talk time in hours, minutes and seconds.

When you're done talking, replace the handset in the cradle or press **(SPEAKERPHONE)** again.

To obtain the best speakerphone performance, see page 32.

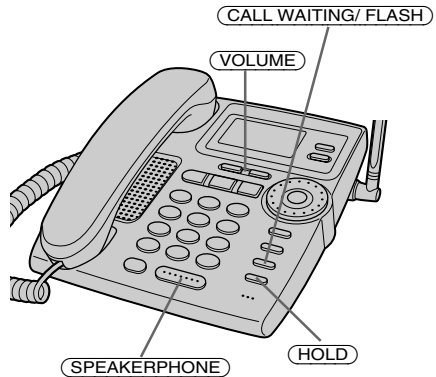

Additional tasks

To	Do this
Adjust the handset or speakerphone volume	During phone conversation, press (VOLUME) (+) or (-) . There are 3 steps for the handset volume level, and 7 steps for the speakerphone volume level.
Put a call on hold	Press (HOLD) . “HOLD” appears on the display. Press (HOLD) , (SPEAKERPHONE) , or pick up the handset from the base phone to resume the conversation.
Switch to another call (“call waiting” service*)	Press (CALL WAITING/ FLASH) . Press (CALL WAITING/ FLASH) again to return to the first caller.
Adjust the ringer volume of the base phone	Press (VOLUME) (+) or (-) . The ringer volume can be adjusted to three different levels: high, low, and “OFF”. If the ringer is set to “OFF”, “[RINGER OFF]” will appear on the display.

* You need to subscribe to the service from your telephone company.

continued

Receiving calls (continued)

Notes

- Even when you set “RINGER VOL” on the base phone to “OFF”, the cordless handset will ring when the RING switch on the cordless handset is set to ON.
- If there is an incoming call during intercom conversation, intercom call will be disconnected, and both the base phone and the cordless handset will ring.

Tips

- To inform you of an incoming call, the display shows “** RINGING **” even when you set “RINGER VOL” on the base phone to “OFF”.
- You can switch between phone conversations via the handset and those via the speakerphone, simply by picking up the handset while talking over the speakerphone, or by pressing **(SPEAKERPHONE)** while talking over the handset.

One-touch dialing

You can dial with one touch of a key by storing a phone number on a one-touch dialing button.

Storing phone numbers and names

Example: to store "SONY" "123-4567".

1 Press **PROGRAM**.

2 Turn Jog Dial to choose "ONE-TOUCH DIAL", and then press Jog Dial.

3 Turn Jog Dial to choose "ONE-TOUCH A" to "ONE-TOUCH C", and then press Jog Dial.

Labels on the phone: TALK, REDIAL/PAUSE, LONG DIST. SAVER, ERASE, ONE-TOUCH DIAL buttons.

Screen displays:
Step 1: HANDSET MENU, [GO BACK], PHONE DIRECTORY, ONE-TOUCH DIAL, [QUICK TALK]
Step 2: ONE-TOUCH DIAL, [GO BACK], ONE-TOUCH A, ONE-TOUCH B, ONE-TOUCH C

One-touch dialing (continued)

4 Enter the name by turning Jog Dial.

You can enter up to 15 characters.

Turn Jog Dial until the desired character is selected, and then press Jog Dial.

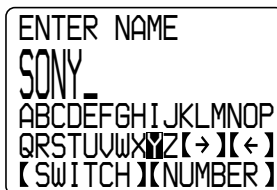

Each press of Jog Dial after choosing “[SWITCH]” switches the characters from upper case letters → lower case letters → numbers and symbols.

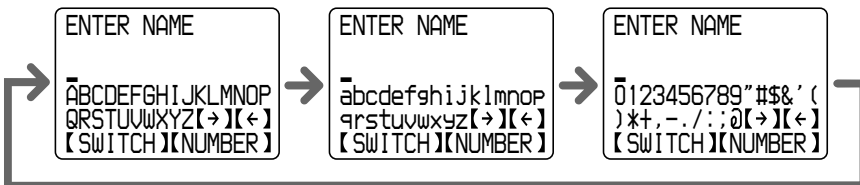

Enter successive characters in the same way.

To enter a “space”, turn Jog Dial to choose “[→]”, and then press Jog Dial.

5 Turn Jog Dial to choose “[NUMBER]”, and then press Jog Dial.

“ENTER NUMBERS” appears on the display.

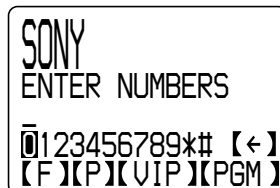

6 Enter the phone number by turning Jog Dial.

You can enter up to 20 digits, including a tone and a pause, each of which is counted as one digit.

Turn Jog Dial until the desired number is selected, and then press Jog Dial.

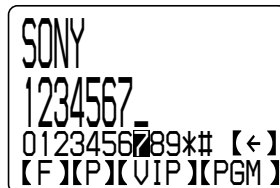

Icon	Meaning
[F]	Flash can be entered.
[P]	Pause can be entered.
[VIP]	If [VIP] has been selected, “♪” will appear to the right of the displayed name. The ring type will change when calls are received from VIP registered numbers, and the number of calls from VIP numbers are listed separately from other messages.

Enter successive numbers in the same way.
When the phone number of 16 digits or more has been entered, the phone number appears in two lines.

- 7** Turn Jog Dial to choose “[PGM]”, and then press Jog Dial.

You hear a long confirmation beep, and the name and the number are stored.

The display goes off.

Notes

- Names cannot be entered using the dialing keys.
- Do not allow more than 20 seconds to elapse during the operation procedure.

Tips

- When you select “[GO BACK]”, you can return to the previous set display by pressing Jog Dial.
- If you have entered a wrong name or number in step 4 or 6, turn Jog Dial to choose “[←]” then press Jog Dial or press (ERASE) to erase it. Then enter the correct name or number.
- You may press (PROGRAM) instead of doing steps 5 and 7.
- Phone numbers can be entered using the dialing keys in step 6.

To store a number to be dialed via Private Branch Exchange (PBX)

Before entering a phone number in step 6 on page 40, do as follows:

- 1 Enter the outside line access digit (e.g., 9).
- 2 Turn Jog Dial to choose “[P]” and then press Jog Dial, or press (REDIAL/PAUSE).

Changing a stored name and/or phone number

- 1 Display the name you want to change by doing steps 1 to 3 on page 39.

The cursor is at the right of the name.

- 2 Turn Jog Dial to choose “[←]”, then press Jog Dial to erase the characters, and enter the new name.

If you want to change only the number, skip this step.

continued

One-touch dialing (continued)

- Turn Jog Dial to choose “[NUMBER]”, and then press Jog Dial.

The cursor is at the right of the phone number.

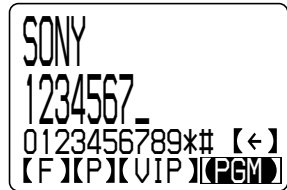

- Turn Jog Dial to choose “[←]”, then press Jog Dial to erase the number, and enter the new number.

If you don't want to change the number, skip this step.

- Turn Jog Dial to choose “[PGM]”, and then press Jog Dial.

You hear a long confirmation beep and the name and/or the number is changed.

Note

The stored record with name and number can be replaced with a new name and number but it is not possible to erase the whole entry at one time.

Tips

- Single character and number can be erased by pressing (ERASE) in steps 2 and 4.
- You may press (PROGRAM) instead of doing steps 3 and 5.

Making calls with one-touch dialing

- Press (TALK) or (LONG DIST. SAVER) and wait until “TALK” appears on the display.

- Press one of the ONE-TOUCH DIAL buttons ((A) to (C)).

The phone number stored on the one-touch dialing button will appear on the display and will be dialed.

To check the phone number before one-touch dialing

While the cordless handset is not in use, press one of the ONE-TOUCH DIAL buttons ((A) to (C)).

The number stored on the button appears on the display for 20 seconds. To dial the number, press (TALK) while the number is displayed.

Phone Directory

You can dial a number by scrolling through the Phone Directory. Both the base phone and the cordless handset can each store up to 50 separate numbers.

Storing phone numbers and names

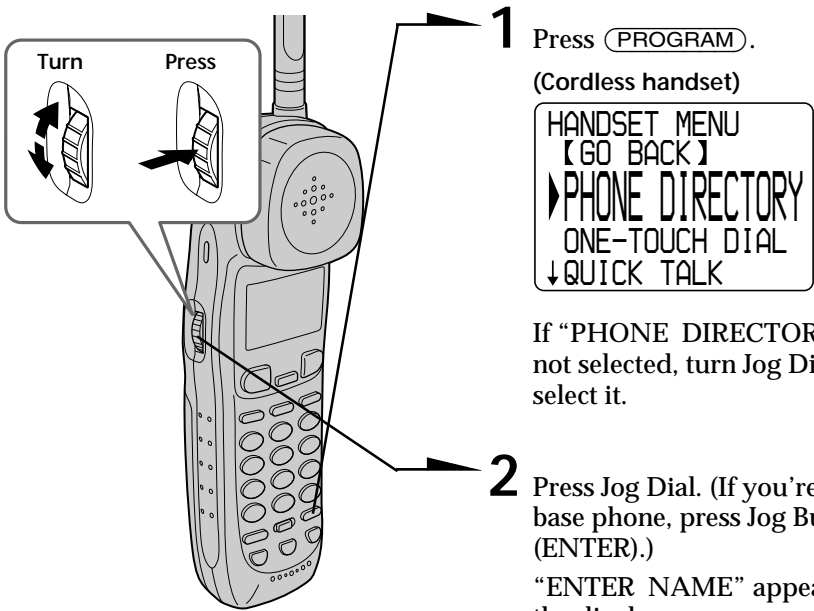

1 Press **PROGRAM**.
(Cordless handset)



If "PHONE DIRECTORY" is not selected, turn Jog Dial to select it.

2 Press Jog Dial. (If you're at the base phone, press Jog Button (ENTER).)

"ENTER NAME" appears on the display.

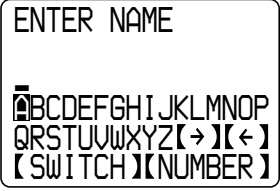

3 Enter the name and the phone number by doing steps 4 to 7 on pages 40 to 41.

Note

If you try to save a 51st phone number, you will hear five short error beeps and "THE MEMORY IS FULL." will be displayed. You cannot store the phone number. To store another phone number, erase one of the stored phone numbers (see page 45).

continued

Changing a stored name and/or phone number

- 1 Display the name you want to change by doing steps 1 to 3 on pages 46 to 47.

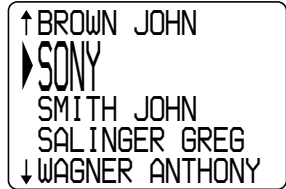

- 2 Press Jog Dial. (If you're at the base phone, press Jog Button (ENTER).)

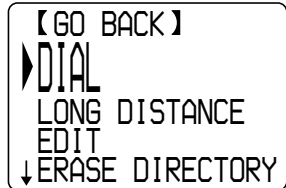

- 3 Turn Jog Dial to choose "EDIT", and then press Jog Dial (or Jog Button (ENTER)).
The cursor is at the right of the name.

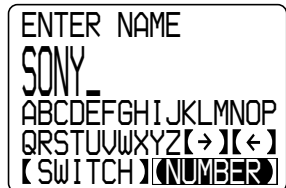

- 4 Change the name and/or the phone number by doing steps 2 to 5 on pages 41 to 42.

Erasing a memory location

To erase the phone number one by one

- 1 Display the name you want to erase by doing steps 1 to 3 on pages 46 to 47.
- 2 Press Jog Dial. (If you're at the base phone, press Jog Button (ENTER).)
- 3 Turn Jog Dial to choose "ERASE DIRECTORY", and then press Jog Dial (or Jog Button (ENTER)).
- 4 Turn Jog Dial to choose "YES", and then press Jog Dial (or Jog Button (ENTER)).
You hear a long confirmation beep and the memory location is erased.

```

↑ BROWN JOHN
▶ SONY
  SMITH JOHN
  SALINGER GREG
↓ WAGNER ANTHONY
  
```

```

【 GO BACK 】
▶ DIAL
  LONG DISTANCE
  EDIT
↓ ERASE DIRECTORY
  
```

```

ERASE DIRECTORY
【 GO BACK 】
▶ NO
  YES
  
```

continued

Phone Directory (continued)

To erase the entire memory at once

- 1 Press **PROGRAM**.
- 2 Turn Jog Dial to choose “MEMORY MANAGE”, and then press Jog Dial. (If you’re at the base phone, press Jog Button (ENTER).)
- 3 Turn Jog Dial to choose “ERASE ALL DIR”, and then press Jog Dial (or Jog Button (ENTER)).
- 4 Turn Jog Dial to choose “ERASE DIRECTORY”, and then press Jog Dial (or Jog Button (ENTER)).
You hear a long confirmation beep and the entire memory is erased.

```
MEMORY MANAGE
【GO BACK】
▶SEND ALL DIR
  ERASE ALL CID
↓ERASE ALL MSG
```

```
ERASE ALL DIR?
【GO BACK】
▶NO
  ERASE DIRECTORY
```

Making calls from the Phone Directory

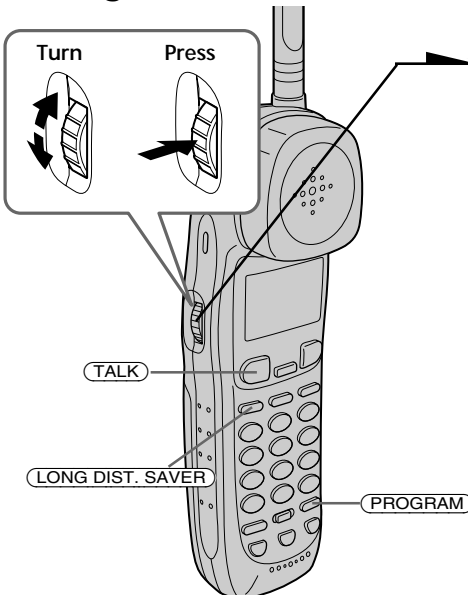

- 1 Press Jog Dial. (If you’re at the base phone, press Jog Button (ENTER).)
“PHONE DIRECTORY” appears on the display.

```
PHONE DIRECTORY
【CALLER ID】
▶【ABC】
  【DEF】
↓【GHI】
```

- 2** Turn Jog Dial to select an alphabet group ([ABC], [DEF]...) which includes the initial character of the name you want to search for, and then press Jog Dial (or Jog Button (ENTER)).

If a numbers or a symbol is the initial character, select the “[etc]” group.

```
PHONE DIRECTORY
↑【PQRS】
▶【TUV】
【WXYZ】
【etc】
```

- 3** Select the name you want to call by turning Jog Dial.

```
↑BROWN JOHN
▶SONY
SMITH JOHN
SALINGER GREG
↓WAGNER ANTHONY
```

- 4** Press Jog Dial (or Jog Button (ENTER)).

```
【GO BACK】
▶DIAL
LONG DISTANCE
EDIT
↓ERASE DIRECTORY
```

- 5** Turn Jog Dial to choose “DIAL” or “LONG DISTANCE”, and then press Jog Dial (or Jog Button (ENTER)).

The phone number will be dialed.

Note

When the Long Distance Saver function is set to “ACTIVE”, “LONG DISTANCE” can be selected in step 4 (see page 21).

Tips

- When you select “[GO BACK]”, you can return to the previous set display by pressing Jog Dial. (If you’re at the base phone, press Jog Button (ENTER).)
- When you select “[CALLER ID]” in step 1, you can switch to display the Caller ID list (see page 71).
- If there is no data recorded in the selected alphabet group in step 2, the data memory of the next following group will be displayed.
- You may press (TALK) or (LONG DIST. SAVER) on the cordless handset (If you’re at the base phone, pick up the handset from the base phone or press (SPEAKERPHONE) or (LONG DIST. SAVER) to make a call instead of doing steps 4 and 5.

continued

Phone Directory (continued)

Transferring the Phone Directory memory

The Phone Directory memory can be transferred one by one or all at once (with a maximum of 50 numbers) from the cordless handset to the base phone and from the base phone to the cordless handset.

To transfer one phone number from the Phone Directory

- 1 Display the name you want to transfer by doing steps 1 to 3 on pages 46 to 47.

```
↑ BROWN JOHN
▶ SONY
  SMITH JOHN
  SALINGER GREG
↓ WAGNER ANTHONY
```

- 2 Press Jog Dial. (If you're at the base phone, press Jog Button (ENTER).)

```
【 GO BACK 】
▶ DIAL
  LONG DISTANCE
  EDIT
↓ ERASE DIRECTORY
```

- 3 Turn Jog Dial to choose "SEND DIRECTORY", and then press Jog Dial (or Jog Button (ENTER)).

You hear a long confirmation beep and the memory is transferred.

To transfer all phone numbers from the Phone Directory

The Phone Directory receiving the transfer will be totally overwritten.

- 1 Press **PROGRAM**.
- 2 Turn Jog Dial to choose "MEMORY MANAGE", and then press Jog Dial. (If you're at the base phone, press Jog Button (ENTER).)

```
MEMORY MANAGE
【 GO BACK 】
▶ SEND ALL DIR
  ERASE ALL CID
↓ ERASE ALL MSG
```

3 Press Jog Dial again (or Jog Button (ENTER)).

(Cordless handset)

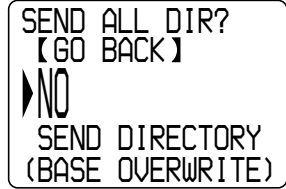

SEND ALL DIR?
【GO BACK】
▶NO
SEND DIRECTORY
(BASE OVERWRITE)

4 Turn Jog Dial to choose “SEND DIRECTORY”, and then press Jog Dial (or Jog Button (ENTER)).

“SENDING...” appears on the display during the transfer.

You hear a long confirmation beep and the entire memory is transferred.

Notes

- If there are already 50 numbers stored in the Phone Directory receiving the transferred number one by one from the other Phone Directory, “CORDLESS HANDSET MEMORY IS FULL.” or “BASEPHONE MEMORY IS FULL.” will appear on the display and five short error beeps will be heard to indicate that the transfer was unsuccessful. To make the transfer possible, erase one of the stored phone numbers existing in the Phone Directory (see page 45).
- If the transfer is unsuccessful, “SEND TO CORDLESS HANDSET FAILED.” or “SEND TO BASEPHONE FAILED.” will appear on the display, and five short error beeps will be heard. Move the cordless handset closer to the base phone, and then start over the procedure.

Switching the phones during a call

You can easily switch between the cordless handset and the base phone without disconnecting the call.

To switch from the base phone to the cordless handset



- 1** Press **(HOLD)** on the base phone.
The call is on hold and “HOLD” appears on the display.
- 2** Pick up the cordless handset from the charger (When Quick talk is set to “USE”; see page 36) or press **(TALK)** or **(HOLD)** on the cordless handset.
You can continue talking to the caller through the cordless handset.

To switch from the cordless handset to the base phone

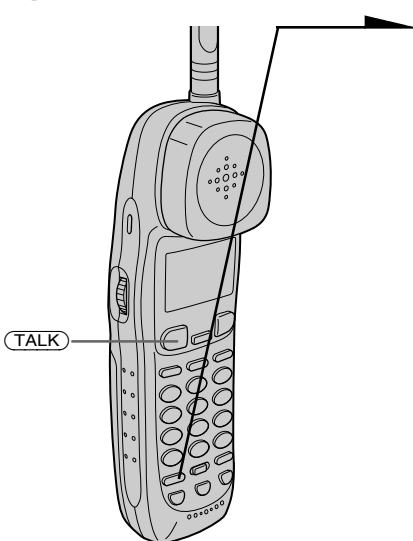

- 1** Press **(HOLD)** on the cordless handset.
The call is on hold and “HOLD” appears on the display.
- 2** Pick up the handset from the base phone or press **(SPEAKERPHONE)** or **(HOLD)** on the base phone.
You can continue talking to the caller through the base phone.

Talking between the phones (Intercom)

You can talk between the base phone and the cordless handset. You can start the intercom from either phone.

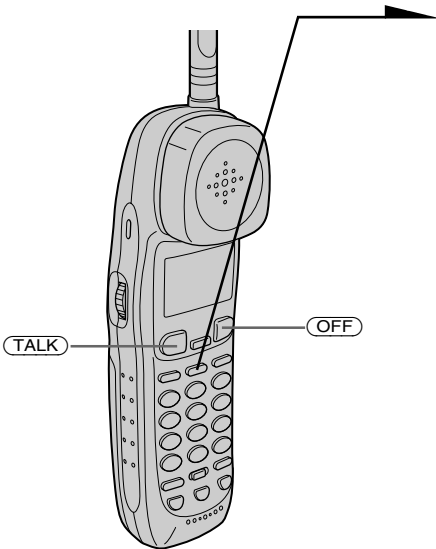

To talk from the cordless handset to the base phone

Press **INTERCOM**.

The base phone and cordless handset ring and “** PAGING **” appears on the display.

When a person at the base phone picks up the handset from the base phone or presses **SPEAKERPHONE** or **INTERCOM**, you can talk with each other.

“INTERCOM” appears on the display.

When you are done talking

Replace the cordless handset on the charger or press **OFF** on the cordless handset.

If no one answers the phone

Press **INTERCOM** again.

Talking between the phones (Intercom) (continued)

To talk from the base phone to the cordless handset



Press **INTERCOM**.

The base phone and cordless handset ring and “** PAGING **” appears on the display.

When a person at the cordless handset picks up the cordless handset from the charger (When Quick talk is set to “USE”; see page 36) or presses **TALK** or **INTERCOM**, you can talk with each other.

“INTERCOM” appears on the display.

When you are done talking

Replace the handset in the cradle or press **SPEAKERPHONE** on the base phone.

If no one answers the phone

Press **INTERCOM** again.

Notes

- If there is an incoming call during intercom conversation, intercom call will be disconnected, and both the base phone and the cordless handset will ring.
- While talking with an outside caller via the base phone or cordless handset, you cannot make an intercom call. If you press **INTERCOM** on the cordless handset, “BASEPHONE IN USE” appears on the display and you will hear a busy tone.

Tip

You can receive an intercom call on the base phone or the cordless handset even when “RINGER VOL” on the base phone is set to “OFF”, or the RING switch on the cordless handset is set to OFF. The phone will ring at a low level.

Transferring a call

You can transfer a call between the cordless handset and base phone without disconnecting the call.

To transfer from the base phone to the cordless handset



1 Press **INTERCOM** to page the cordless handset.

The call is put on hold on the base phone and the cordless handset rings. “** PAGING **” appears on the display of both the base phone and cordless handset.

SPEAKERPHONE

2 Pick up the cordless handset from the charger (When Quick talk is set to “USE”; see page 36) or press **TALK** or **INTERCOM** on the cordless handset.

“INTERCOM” appears on the display of both the cordless handset and base phone.

You can talk between the base phone and the cordless handset.

TALK

3 To talk to the caller with the cordless handset, replace the handset in the cradle or press **SPEAKERPHONE** on the base phone.

“TALK” appears on the display of the cordless handset.

If no one answers the phone

Press **INTERCOM** again.

Tips

- You can receive an intercom call on the cordless handset even when the RING switch is set to OFF. The cordless handset will ring at a low level.
- If you have accidentally pressed **HOLD** in step 1, just press **INTERCOM** and you will get the same result as by pressing **INTERCOM** only.

continued

Transferring a call (continued)

To transfer from the cordless handset to the base phone

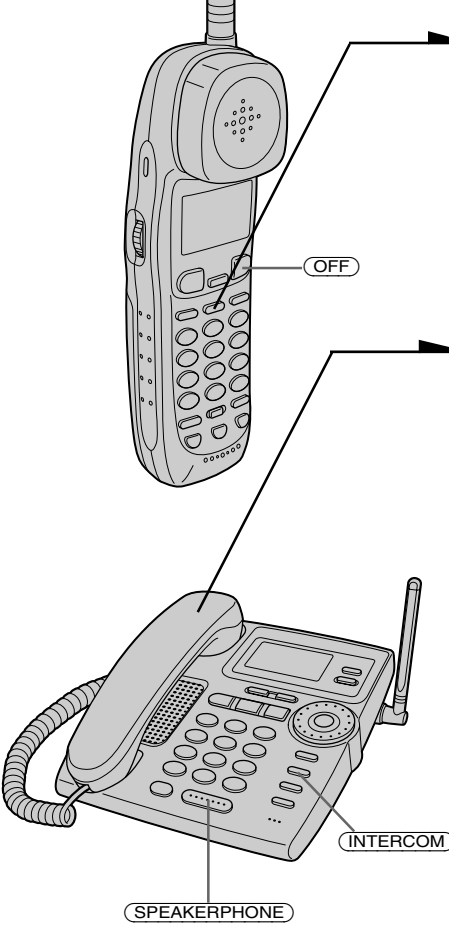

1 Press **INTERCOM** to page the base phone.

The call is put on hold on the cordless handset and the base phone rings. “** PAGING **” appears on the display of both the cordless handset and base phone.

2 Pick up the handset from the base phone or press **SPEAKERPHONE** or **INTERCOM** on the base phone.

“INTERCOM” appears on the display of both the base phone and cordless handset.

You can talk between the cordless handset and the base phone.

3 To talk to the caller with the base phone, replace the cordless handset on the charger or press **OFF** on the cordless handset.

“TALK” or “SPEAKERPHONE” appears on the display of the base phone.

If no one answers the phone

Press **INTERCOM** again.

Tip

You can receive an intercom call on the base phone even when “RINGER VOL” on the base phone is set to “OFF”. The base phone will ring at a low level.

Preparing the answering machine

Answer settings can only be made on the base phone.

Note that you cannot operate the base phone while the cordless handset is in use.

Adjusting the answering volume of the base phone

There are 7 steps for the answering volume level. The answering volume level is preset to 7 (MAX).

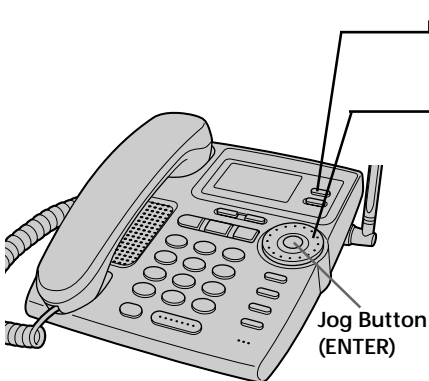

1 Press **PROGRAM**.

2 Turn Jog Dial to choose "ANSWER SETTINGS", and then press Jog Button (ENTER).

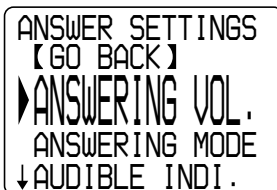

3 Press Jog Button (ENTER) again.

4 Turn Jog Dial to adjust the answering volume, and then press Jog Button (ENTER).
You hear a long confirmation beep.

Notes

- Do not allow more than 20 seconds to elapse during the operation procedure.
- If the answering volume is set to minimum, you cannot screen the calls on the base phone.

Tip

When you select "[GO BACK]", you can return to the previous set display by pressing Jog Button (ENTER).

Preparing the answering machine (continued)

Recording the greeting

This answering machine has prerecorded greetings (see page 57). However, you can record your own greeting.

The greeting must be between two seconds and one minute long.

You can record only one greeting, and it is used regardless of the answering mode (“normal” and “announcement only” modes. See page 61). Therefore, if you decide to change the mode, make sure that you record a new greeting to match the answering mode.

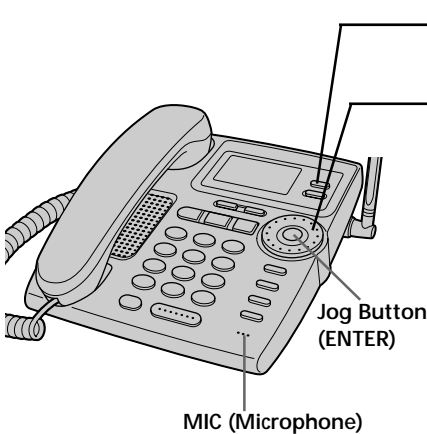

- 1 Press **PROGRAM**.
- 2 Turn Jog Dial to choose “ANSWER SETTINGS”, and then press Jog Button (ENTER).
- 3 Turn Jog Dial to choose “GREETING”, and then press Jog Button (ENTER).

```
GREETING
【GO BACK】
▶PLAY BACK
RECORD
ERASE GREETING
```

- 4 Turn Jog Dial to choose “RECORD”, and then press Jog Button (ENTER).

You hear a voice guidance and a long confirmation beep.

- 5 After the tone, start recording. Speak about 12 inches (30 cm) away from the microphone.

```
RECORD
【GO BACK】
▶COMPLETE
CANCEL (STOP)
```

6 Press Jog Button (ENTER) to stop recording.

The phone automatically replays the recorded greeting.

Notes

- Do not allow more than 20 seconds to elapse during the operation procedure.
- If recording did not succeed, you hear five short error beeps. Start over the procedure.
- If a call comes in while recording a greeting, recording is cancelled. Start over the procedure.
- If you hear five short error beeps while recording, the recording area may be full. In this case, erase unnecessary messages (see page 65).
- If you want to cancel recording, turn Jog Dial to choose "CANCEL (STOP)", then press Jog Button (ENTER) in step 5.

Tips

- When you select "[GO BACK]", you can return to the previous set display by pressing Jog Button (ENTER).
- If one minute have passed in step 5, recording stops automatically.
- To record the greeting from a touch-tone phone, see page 69.

Prerecorded greeting

Normal mode: "Hello, I'm unable to answer your call right now. Please leave your name, number and message after the tone."

Announcement only mode: "Hello, I'm unable to answer your call right now. Please call again. Thank you."

Tips

- If you wish to record your own "announcement only" greeting, follow the above sequence after setting "ANSWERING MODE" to "ANNOUNCE ONLY" (page 60). Otherwise, the "normal" greeting will be recorded.
- You have to change the message each time you change the mode.

To check the greeting

Perform steps 1 to 3 on page 56, then press Jog Button (ENTER).

To change the greeting

Record a new greeting. The new greeting replaces the old one.

To erase the greeting

Perform steps 1 to 3 on page 56, and turn Jog Dial to choose "ERASE GREETING" then press Jog Button (ENTER).

To go back to the factory preset greeting

Erase your own greeting by doing step above. This will bring back the original greeting.

continued

Preparing the answering machine (continued)

Selecting the ring time

You can select the number of rings before the answering machine starts to play back the greeting and records incoming messages. There are 5 options of ring time. The ring time is preset to "TOLL SAVER".

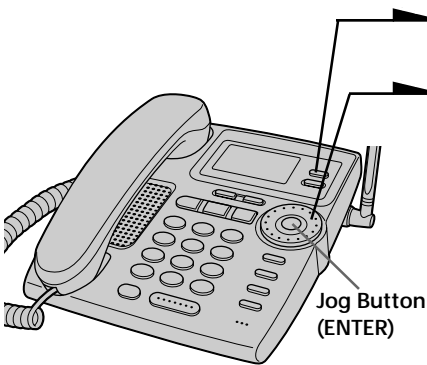

- 1 Press **PROGRAM**.
- 2 Turn Jog Dial to choose "ANSWER SETTINGS", and then press Jog Button (ENTER).

- 3 Turn Jog Dial to choose "RINGER TIMES", and then press Jog Button (ENTER).

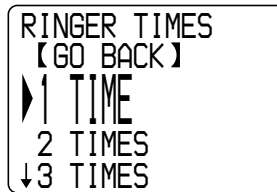

- 4 Turn Jog Dial to select a ring duration, and then press Jog Button (ENTER). (See the table for details.)
You hear a long confirmation beep.

Set "RINGER TIMES" to	Mode
"TOLL SAVER"	If new messages have been recorded, the phone answers at the second ring and records incoming messages; if no new messages are recorded, it answers at the fifth ring. When you call from an outside phone and hear three rings, you know that there are no new messages. If you hang up at this point before the phone answers, you can save the toll for the call.
"1 TIME" to "4 TIMES"	The phone always answers at the set ring times and records incoming messages.

Note

Do not allow more than 20 seconds to elapse during the operation procedure.

Tip

When you select "[GO BACK]", you can return to the previous set display by pressing Jog Button (ENTER).

Selecting the recording quality

For the user who does not utilize the maximum recording capacity (about 20 minutes), you can select a higher recording grade and enjoy superior sound quality and clarity compared to the standard (NORM) grade. As higher sound quality uses up more memory capacity, the maximum recording time changes accordingly.

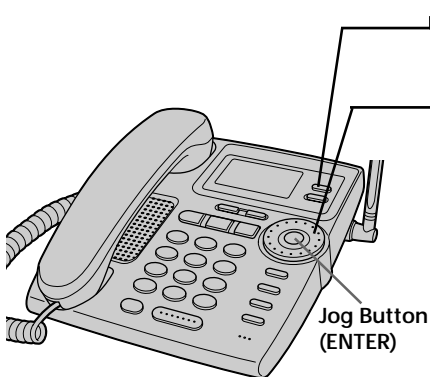

1 Press **PROGRAM**.

2 Turn Jog Dial to choose “ANSWER SETTINGS”, and then press Jog Button (ENTER).

3 Turn Jog Dial to choose “RECORD QUALITY”, and then press Jog Button (ENTER).

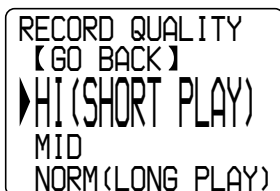

4 Turn Jog Dial to choose “HI (SHORT PLAY)”, “MID” or “NORM (LONG PLAY)”, and then press Jog Button (ENTER).

You hear a long confirmation beep.

Notes

- Do not allow more than 20 seconds to elapse during the operation procedure.
- The approx. length of the three recording grades are:
 - “HI (SHORT PLAY)” – 8 minutes
 - “MID” – 15 minutes
 - “NORM (LONG PLAY)” – 20 minutes
 Actual recording time may vary.

Tip

When you select “[GO BACK]”, you can return to the previous set display by pressing Jog Button (ENTER).

continued

Preparing the answering machine (continued)

Selecting the answering mode

You can set the answering machine to record incoming messages (normal mode), or just make an announcement without recording messages (announcement only mode). You can record your own greeting, or use the factory pre-recorded greetings.

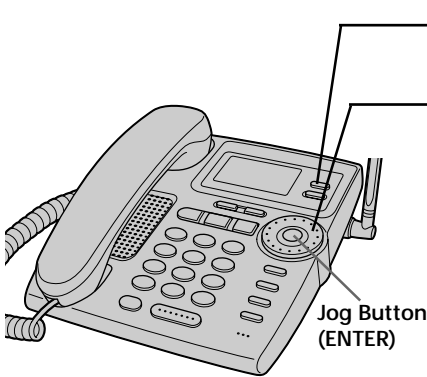

1 Press **PROGRAM**.

2 Turn Jog Dial to choose “ANSWER SETTINGS”, and then press Jog Button (ENTER).

```
ANSWER SETTINGS
【GO BACK】
▶ANSWERING VOL.
ANSWERING MODE
↓AUDIBLE INDI.
```

3 Turn Jog Dial to choose “ANSWERING MODE”, and then press Jog Button (ENTER).

4 Turn Jog Dial to choose “ANNOUNCE ONLY” or “NORMAL”, and then press Jog Button (ENTER).

You hear a long confirmation beep.

Answering mode	When you wish to	Pre-recorded greeting
“ANSWERING MODE” is set to “NORMAL” (normal mode)	play a greeting to ask the caller to leave a message.	“Hello, I’m unable to answer your call right now. Please leave your name, number and message after the tone.”
“ANSWERING MODE” is set to “ANNOUNCE ONLY” (announcement only mode)	make an announcement to the caller without accepting incoming messages when, for example, you are away on a long vacation.	“Hello, I’m unable to answer your call right now. Please call again. Thank you.”

Notes

- Do not allow more than 20 seconds to elapse during the operation procedure.
- The same greeting is used regardless of the answering mode. Therefore, if you decide to change the mode, make sure that you record a new greeting to match the answering mode.

Tips

- When the phone is in announcement only mode, “ANNOUNCE ONLY” will appear on the standby mode display.
- When you select “[GO BACK]”, you can return to the previous set display by pressing Jog Button (ENTER).

When the memory is full

The recording area of this phone's memory is about 20 minutes* (including the greeting, messages, and memo). If the remaining recording area becomes less than one minute, the phone automatically switches to announcement only mode, which does not record messages, and the greeting will be switched to the pre-recorded greeting. Confirm the available time left for recording in the standby mode display.

* Available time for recording at “NORM (LONG PLAY)” sound quality.

If you wish to record more messages, erase the existing messages (see page 65). You can also erase the messages from an outside phone (see page 69).

Setting the audible message indicator

You have the option of having a beep to tell you if you have received any new messages. The audible message indicator is preset to “ON”.

- 1 Press **(PROGRAM)**.
- 2 Turn Jog Dial to choose “ANSWER SETTINGS”, and then press Jog Button (ENTER).
- 3 Turn Jog Dial to choose “AUDIBLE INDI.”, and then press Jog Button (ENTER).
- 4 Turn Jog Dial to choose “ON” or “OFF”, and then press Jog Button (ENTER).

You hear a long confirmation beep.

continued

Preparing the answering machine (continued)

Turning on the answering function



Press **ANSWER ON/OFF** so that it lights up in red.

Notes

- When the memory is full, you hear five short error beeps and you cannot turn on the answering function. Erase unnecessary messages (see page 65).
- If four minutes have passed while recording the incoming message, the line is automatically disconnected.
- If the message is shorter than two seconds, it will not be recorded.

Tips

- The answering machine will automatically answer a call after 10 rings even if the answering function is off. The answering function will remain on for all subsequent calls.
- You can also turn on or off the answering function from an outside phone (see page 69).

To turn off the answering function

Press **ANSWER ON/OFF** so that the red light goes off.

Playing back messages

You can play back messages on both the base phone and the cordless handset.

When the phone is not in use and not in announcement only mode, the display of the base phone shows the following.

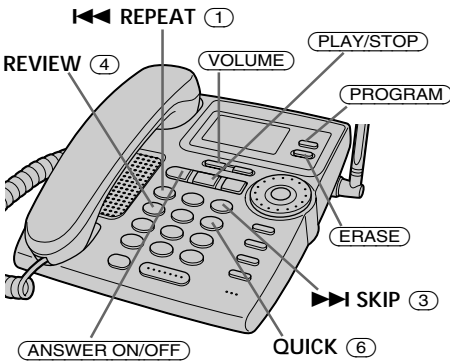
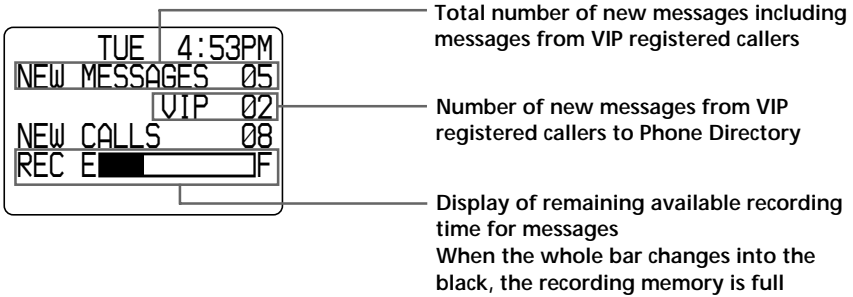

When you come home

If **ANSWER ON/OFF** flashes in red and display on the base phone shows the number of new messages, press **PLAY/STOP** on the base phone or **HOLD/PLAY BACK** on the cordless handset.

The machine plays back from the newest message received.

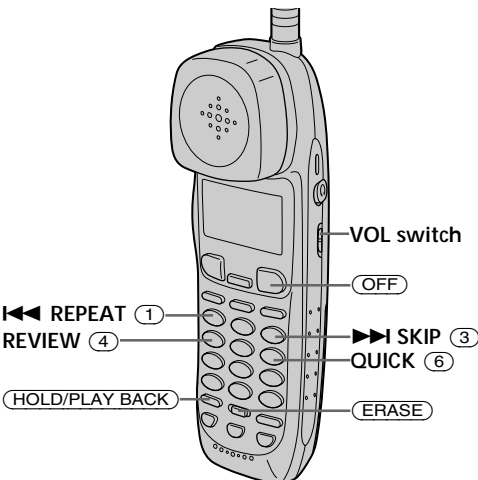

continued

Playing back messages (continued)

Additional tasks when playing back messages

To	Do this
Adjust the answering volume	During playback, press (VOLUME) (+) or (-) on the base phone.
Adjust the cordless handset volume	Set the VOL switch on the cordless handset to H (high), M (middle) or L (low).
Stop playback	Press (PLAY/STOP) on the base phone or (OFF) on the cordless handset.
Skip to the next message	Press ▶▶ SKIP (3) while the current message is playing.
Repeat the current message	Press ◀◀ REPEAT (1) while the current message is playing.
Go back to previous messages	Press ◀◀ REPEAT (1) within the first three seconds of the current message.
Review playback	Keep REVIEW (4) pressed during playback.
Play back quickly	Keep QUICK (6) pressed during playback.

Notes

- The display shows the total number of “new” messages. Therefore, it is reset to “00” when you play back all new messages, even they are not erased yet. Be sure to erase unnecessary messages before the memory becomes full. Confirm the available time left for recording in the standby mode display.
- The phone can record up to 128 messages including the greeting and memo.
- If a call comes in during playback, the playback stops.

Tips

- You can also listen to the messages or erase the messages from a outside phone (page 69).
- During playback of messages with Caller ID data, the name and phone number will appear on the display. If there is no name and phone number data, “NO CALLER ID” will appear on the display. During playback of memo, “MEMO MESSAGE” will appear on the display.

Erasing messages

To erase the message one by one

Press (ERASE) while the message is being played back.

You hear a voice guidance and the message is erased.

To erase the entire messages at once

Entire message deletion can only be made on the base phone.

Note that new messages that have not as yet been played back will also be erased.

- 1 Press (PROGRAM).
- 2 Turn Jog Dial to choose "MEMORY MANAGE", and then press Jog Button (ENTER).
- 3 Turn Jog Dial to choose "ERASE ALL MSG", and then press Jog Button (ENTER).
- 4 Turn Jog Dial to choose "ERASE MESSAGES", and then press Jog Button (ENTER).

You hear a long confirmation beep, and the entire messages are erased.

Note

If a power interruption occurs or the AC power adaptor is disconnected while erasing a message, all recorded message may be erased.

Screening incoming calls

You can screen calls by leaving the answering function on (see page 62) while you are at home. When a call is answered, you can hear the message being recorded through the base phone or cordless handset but the caller cannot hear you. Then, you can decide whether to answer the call or not. This function is available both the base phone and the cordless handset. However, the following procedures are required in order to screen incoming calls on the cordless handset.

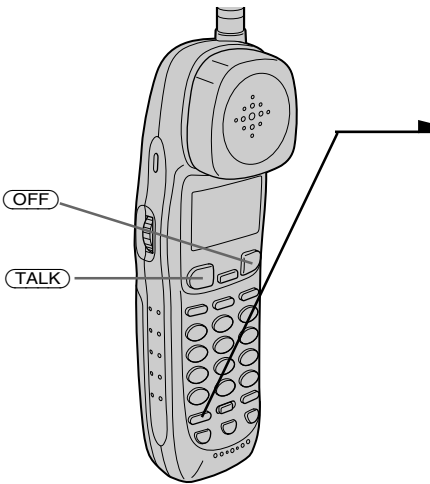

To screen incoming calls on the cordless handset

Press **(HOLD/PLAY BACK)** while “ANSWERING” is displayed.

“CALL SCREENING” appears on the display of the cordless handset.

To answer the call

Pick up the handset from the base phone or press **(SPEAKERPHONE)** on the base phone, or press **(TALK)** on the cordless handset.

Recording is stopped and you can speak to the caller.



Notes

- If you press **(HOLD/PLAY BACK)** while the greeting is running, “PLEASE WAIT...” will appear on the display, then once the message recording commences it will change to call screening status.
- If the answering volume is set to minimum, you cannot screen the calls on the base phone.

Tips

- You can conclude call screening by pressing **(OFF)** on the cordless handset.
- You can also answer the call by picking up the handset on another phone if it is connected to the same line.

Recording a memo

You can record a “memo” (up to four minutes) as a personal reminder or as a message for other people. You can play back the recorded memo like any incoming messages (see page 63).

Memo recording is only available on the base phone.



- 1** Press **MEMO**.
You hear a voice guidance and a long confirmation beep.
- 2** After the tone, start recording.
Speak about 12 inches (30 cm) away from the microphone.
- 3** Press **MEMO** to stop recording.
The message number in the display increases by one.

Notes

- If you press **MEMO** when the memory is full (available time for recording is displayed as running short), you hear five short error beeps and you cannot record a memo.
- If a call comes in while recording a memo, recording is canceled. Start over the procedure.
- If the remaining memory becomes full while recording, recording stops automatically.

Tip

If four minutes have passed in step 2, recording stops automatically, and the recorded memo is counted as a new message.

Operating from an outside phone

You can call from a touch-tone phone and pick up new messages recorded on the phone. First, you just set the remote ID code (security code) and turn on the answering function before going out.

The remote ID code (security code) setting can only be made on the base phone.

Setting the remote ID code (security code)

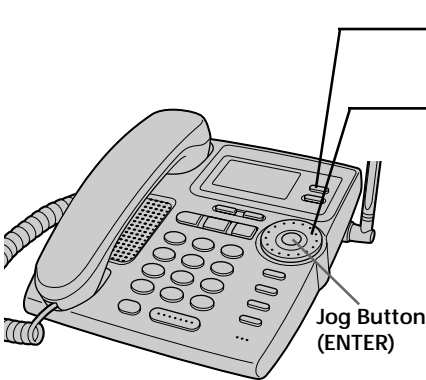

- 1 Press **PROGRAM**.
- 2 Turn Jog Dial to choose “ANSWER SETTINGS”, and then press Jog Button (ENTER).
- 3 Turn Jog Dial to choose “SECURITY CODE”, and then press Jog Button (ENTER).
- 4 Enter four digits of remote ID code (security code) between 0000 and 9999 using the dialing keys.
- 5 Press **PROGRAM**.
The remote ID code (security code) is set, and you hear a long confirmation beep.

Note

Do not allow more than 20 seconds to elapse during the operation procedure.

Tips

- When you select “[GO BACK]”, you can return to the previous set display by pressing Jog Button (ENTER).
- You may press Jog Button (ENTER) instead of **PROGRAM** in step 5.

To change the remote ID code (security code)

Enter a new remote ID code (security code). The new code will replace the old one.

Picking up new messages

- 1 Call your phone from a touch-tone phone.
- 2 While you hear your greeting play, press **(#)**, and your remote ID code (security code).
 You hear a long confirmation beep and the greeting stops. Following the voice guidance informing you of the number of messages recorded, the phone stands by for you to enter a control code.
- 3 To do other operations, enter the control code within 20 seconds (see the table below). To quit, hang up the phone.

Control codes for remote operations

To	Press
Play back messages	(#) (2)
Repeat the current message	(#) (1) while the message is being played back
Skip the current message	(#) (3) while the message is being played back
Erase the current message	(#) (9) while the message is being played back
Erase all messages	(#) (9)
Record a new greeting (up to one minute)	(*) (7) . When you hear a long beep, start recording your greeting. Press (*) (*) to stop recording.
Turn on the answering function	(*) (0)
Turn off the answering function	(#) (0)
Stop the current operation	(*) (*)

If you forgot to turn the answering function on

Call your phone and let it ring 10 times until it answers. Then the answering function automatically turns on.

Note

If you enter a wrong remote security code three times, the line will be disconnected.

To use the toll-saver feature

Set "RINGER TIMES" to "TOLL SAVER". See page 58 for details.

Understanding the Caller ID service

Caller ID allows the caller's phone number to be shown on the display before you answer the call. In order to use this feature, you must first subscribe to Caller ID service. The name of this service may vary depending on your telephone company. To use this feature, be sure to enter the area code (see page 15).

When you receive a call

The phone number appears on the display with the date and time as shown in the following example.

If your Caller ID service includes the caller name service or if the phone number stored in the one-touch dialing, or the Phone Directory matches with the Caller ID data phone number, the caller's name also appears on the display (up to 15 letters). The caller's name will appear by the name stored in the one-touch dialing or Phone Directory if you receive a call from a phone number which is stored on one of the ONE-TOUCH DIAL buttons or in the Phone Directory.

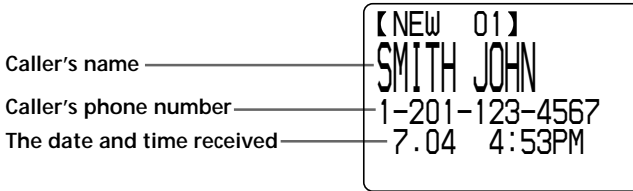

When you answer the call, the Caller ID display changes to the "TALK" or "SPEAKERPHONE" display.

Notes

- The caller's phone number and/or name will not appear in the following cases:
 - "OUT OF AREA": when the call is made through a telephone company which does not offer Caller ID service (including international calls).
 - "PRIVATE": when the call is "blocked". For privacy reasons, many states allow callers the option to prevent his or her telephone data from being displayed on the other party's Caller ID display.
- If the call is from an office which uses multiple lines, the displayed phone number may not match the number you use to call the extension.

About the memory match function

The name stored in the one-touch dialing or Phone Directory will appear on the display if you receive a call from a phone number which is stored on one of the ONE-TOUCH DIAL buttons (see page 39) or in the Phone Directory (see page 43).

In addition, the ringer sound will change to a higher tone from the second ring and "♪" will appear to the right of the displayed name if you receive a call from a VIP registered phone number on the base phone or the cordless handset.

Note

The memory match function does not work with "OUT OF AREA" or "PRIVATE" calls; and it may not work with calls made from an office which uses multiple lines because the number does not always match the one you stored in this phone.

Looking at the Caller ID list

The phone stores the data of the last 100 calls received including “OUT OF AREA” and “PRIVATE” calls. It keeps track of all calls received; even if they were not answered.

Viewing the Caller ID list

You can look through the Caller ID list on both the base phone and the cordless handset to check the phone number and/or name of the calls received.

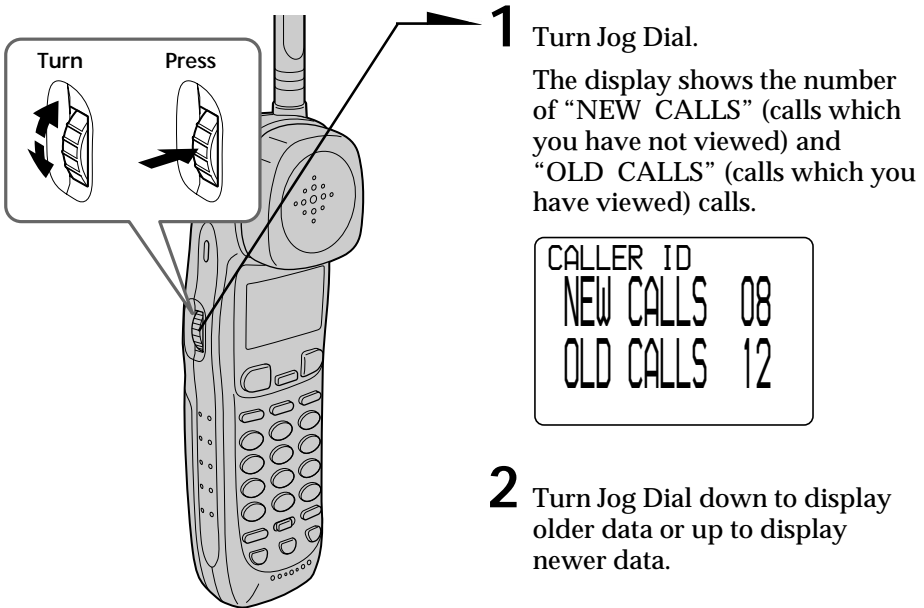

Notes

- If a 101st call is received, the oldest data is automatically erased.
- When you have checked all data, “END OF LIST” appears.

Tips

- The number of “NEW CALLS” can be confirmed with the standby mode display of the base phone. In addition, after playing back messages, a voice guidance will provide notice in regards to new calls.
- When there are messages in the displayed Caller ID data, “[MESSAGE]” will appear at the very bottom of the display. See “Playing back a message from the Caller ID list” on page 76.

Looking at the Caller ID list (continued)

Erasing data from the Caller ID list

Old data will be erased automatically when a 101st call comes in, but you can also manually erase unnecessary data one by one or erase the entire list.

To erase the phone number one by one

- 1 Display the phone number you want to erase from the Caller ID list (see page 71).

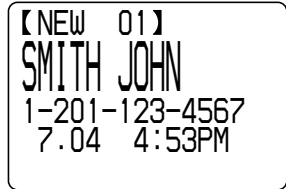

```
【NEW 01】  
SMITH JOHN  
1-201-123-4567  
7:04 4:53PM
```

- 2 Press Jog Dial. (If you're at the base phone, press Jog Button (ENTER).)

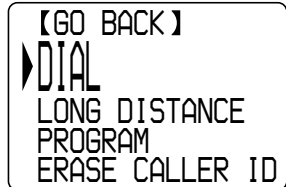

```
【GO BACK】  
▶DIAL  
LONG DISTANCE  
PROGRAM  
ERASE CALLER ID
```

- 3 Turn Jog Dial to choose "ERASE CALLER ID", and then press Jog Dial (or Jog Button (ENTER)).

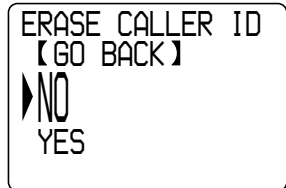

```
ERASE CALLER ID  
【GO BACK】  
▶NO  
YES
```

- 4 Turn Jog Dial to choose "YES", and then press Jog Dial (or Jog Button (ENTER)).

You hear a long confirmation beep and the data is erased.

Note

Do not allow more than 20 seconds to elapse during the operation procedure.

Tip

When you select "[GO BACK]", you can return to the previous set display by pressing Jog Dial. (If you're at the base phone, press Jog Button (ENTER).)

To erase the entire list at once

Entire Caller ID list deletion can only be made on the base phone.

Note that Caller ID data in the list that has not been viewed will also be erased.

1 Press **(PROGRAM)**.

2 Turn Jog Dial to choose “MEMORY MANAGE”, and then press Jog Button (ENTER).



3 Turn Jog Dial to choose “ERASE ALL CID”, and then press Jog Button (ENTER).

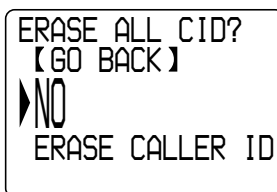

4 Turn Jog Dial to choose “ERASE CALLER ID”, and then press Jog Button (ENTER).

You hear a long confirmation beep and the entire list is erased.

Note

Do not allow more than 20 seconds to elapse during the operation procedure.

Tip

When you select “[GO BACK]”, you can return to the previous set display by pressing Jog Button (ENTER).

Using the Caller ID list

By using the Caller ID list, you can call back a phone number from the Caller ID list easily, play back messages, or store numbers from the Caller ID list into the Phone Directory.

Calling back a number from the Caller ID list

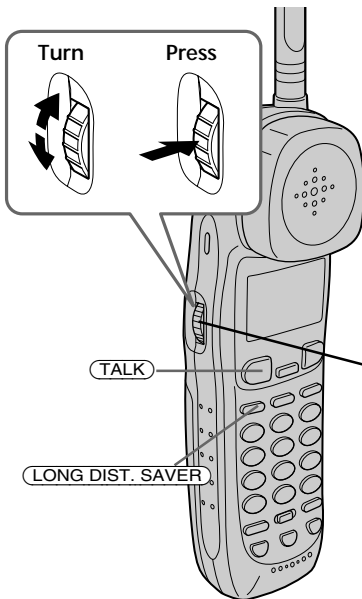

- 1 Display the phone number you want to call from the Caller ID list (see page 71).

```
【NEW 01】  
SMITH JOHN  
1-201-123-4567  
7.04 4:53PM
```

- 2 Press Jog Dial. (If you're at the base phone, press Jog Button (ENTER).)

```
【GO BACK】  
▶DIAL  
LONG DISTANCE  
PROGRAM  
ERASE CALLER ID
```

- 3 Turn Jog Dial to choose "DIAL" or "LONG DISTANCE", and then press Jog Dial (or Jog Button (ENTER)).

The phone automatically dials the displayed number.

Notes

- When the Long Distance Saver function is set to "ACTIVE", "LONG DISTANCE" can be selected in step 2 (see page 21).
- If the area code is not entered, "PLEASE ENTER AREA CODE" will appear on the display, and you will not be able to call back. Enter the area code (see page 15).
- Do not allow more than 20 seconds to elapse during the operation procedure.
- If the number displayed in step 1 is not the one you should call back, you can change the number of digits of the phone number as described on page 78.
- If the phone is connected to a Private Branch Exchange (PBX), you may not be able to call back from the Caller ID list because an outside line access digit is necessary.

Tips

- You may press **(TALK)** or **(LONG DIST. SAVER)** on the cordless handset (If you're at the base phone, pick up the handset from the base phone or press **(SPEAKERPHONE)** or **(LONG DIST. SAVER)**) to make a call instead of doing steps 2 and 3.
- When you select "[GO BACK]", you can return to the previous set display by pressing Jog Dial. (If you're at the base phone, press Jog Button (ENTER).)

continued

Using the Caller ID list (continued)

Playing back a message from the Caller ID list

When there is a message in the received Caller ID data, you can play back the message while continuing to display the Caller ID list.

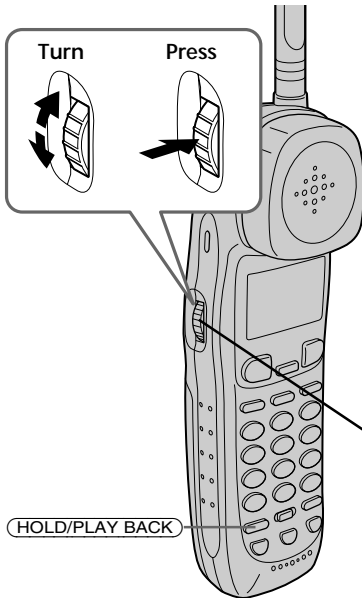

- 1 Display the phone number you want to play back a message from the Caller ID list (see page 71).

```
【NEW 01】
SMITH JOHN
1-201-123-4567
7.04 4:53PM
【MESSAGE】
```

“【MESSAGE】” appears on the display.

- 2 Press Jog Dial. (If you're at the base phone, press Jog Button (ENTER).)

```
【GO BACK】
▶DIAL
LONG DISTANCE
PLAY BACK
↓PROGRAM
```

- 3 Turn Jog Dial to choose “PLAY BACK”, and then press Jog Dial (or Jog Button (ENTER)).

The message is played back.

Note

Do not allow more than 20 seconds to elapse during the operation procedure.

Tips

- When you select “【GO BACK】”, you can return to the previous set display by pressing Jog Dial. (If you're at the base phone, press Jog Button (ENTER).)
- Messages can be played back by pressing **PLAY/STOP** on the base phone or **HOLD/PLAY BACK** on the cordless handset in step 1.

Storing a number of the Caller ID list into the Phone Directory

- 1 Display the name and phone number you want to store from the Caller ID list (see page 71).

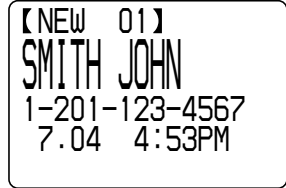

- 2 Confirm the number and press Jog Dial. (If you're at the base phone, press Jog Button (ENTER).)

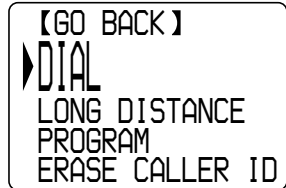

- 3 Turn Jog Dial to choose "PROGRAM", and then press Jog Dial (or Jog Button (ENTER)).

The cursor is at the right of the name.

Enter or change the name, if necessary (see page 41).

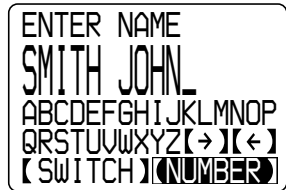

- 4 Turn Jog Dial to choose "[NUMBER]", and then press Jog Dial (or Jog Button (ENTER)).

The cursor is at the right of the phone number.

Enter or change the phone number, if necessary (see page 42).

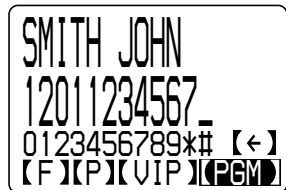

- 5 Turn Jog Dial to choose "[PGM]", and then press Jog Dial (or Jog Button (ENTER)).

You hear a long confirmation beep and the name and number are stored.

continued

Using the Caller ID list (continued)

Notes

- If the area code is not entered, "PLEASE ENTER AREA CODE" will appear on the display, and you will not be able to store into the Phone Directory. Enter the area code (see page 15).
- Do not allow more than 20 seconds to elapse during the operation procedure.
- If the number displayed in step 1 is not the one you should store, you can change the number of digits of the phone number as described below.
- If the phone is connected to a Private Branch Exchange (PBX), you may need to add an outside line access digit.

Tips

- When you select "[GO BACK]", you can return to the previous set display by pressing Jog Dial. (If you're at the base phone, press Jog Button (ENTER).)
- You may press (PROGRAM) instead of doing steps 4 and 5.

To change the number of digits of the phone number

If the number of digits of the phone number in the Caller ID list is different from the actual phone number, you need to adjust the number of digits of the phone number to call back or store into the Phone Directory.

- 1 While the phone number from the Caller ID list is displayed, press (#) repeatedly until the phone number with the correct number of digits appears on the display.

Each time you press (#), the number of digits changes as follows:

When the home area code and the local area code do not match

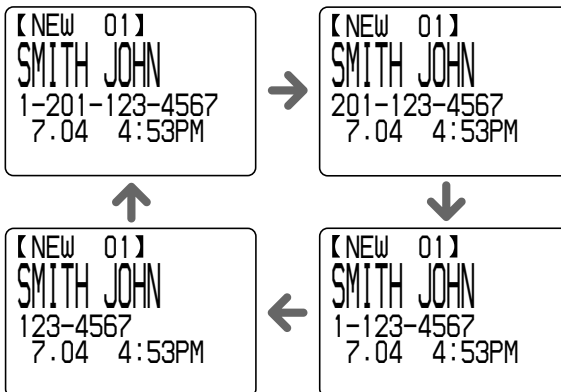

When the home area code matches

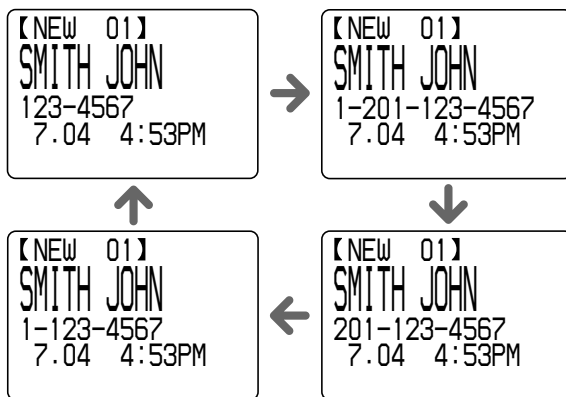

When the local area code matches

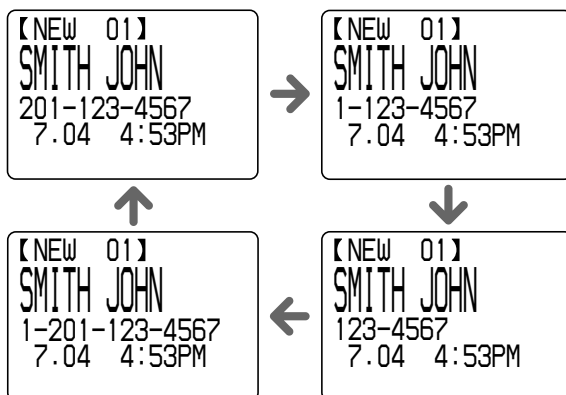

2 Continue the operation to call or store the phone number with the correct number of digits (pages 74 and 77).

Notes

- You need to adjust the number of digits each time you call back from the Caller ID list as the changes to the Caller ID data is not stored in memory.
- You may not be able to change the number of digits depending on the Caller ID data.

Using “Caller ID with call waiting” service

This telephone is compatible with the “Caller ID with call waiting” service. Make sure that your telephone company offers this service.

Like the basic Caller ID service, you need to subscribe to “Caller ID with call waiting” in order to use this service.

Even though you may have already subscribed to “Caller ID” and “call waiting” as two separate services, you need to request a subscription to “Caller ID with call waiting” as a single service.

This is a new service that combines the two services.

Even though you now have a “Caller ID with call waiting” compatible phone, unless you subscribe to the combined “Caller ID with call waiting” service, you will not be able to see the name and number of the second caller.

When a new call comes in while you are talking, the caller’s name and/or phone number of the new call appears on the display for about 20 seconds.

To switch to another caller

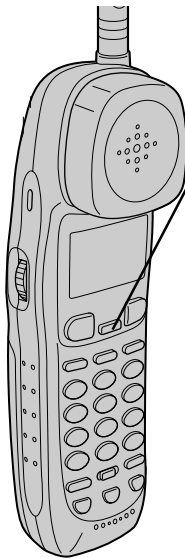

1 To switch to the new caller, press **CALL WAITING/FLASH**.

2 To switch back to the first caller, press **CALL WAITING/FLASH** again.

Tip

When the “Caller ID with call waiting” service is set to “INACTIVE”, you cannot use this service even if you have subscribed to “Caller ID with call waiting” service (see page 19).

Mounting the base phone on a wall

1

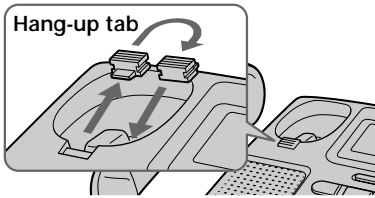

1

Reverse the hang-up tab.

2

Plug the telephone line cord to the LINE jack and the AC power adaptor to the DC IN 11V jack, and hook the cords. Use the shorter cord for mounting.

2

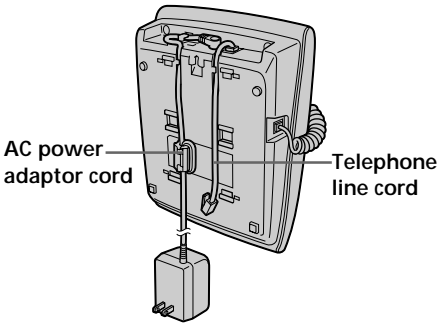

3

Attach the wall bracket to the center of the base phone. Align the Δ marks of the wall bracket with those of the base phone.

3

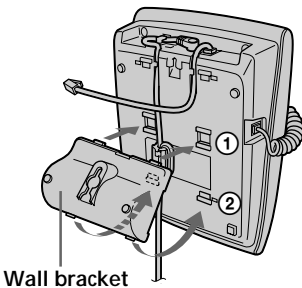

4

Plug the telephone line cord to the telephone outlet, and hook the base phone to the wall plate.

5

Plug the AC power adaptor to an AC outlet. Then raise the antenna so that it points towards the ceiling.

4, 5

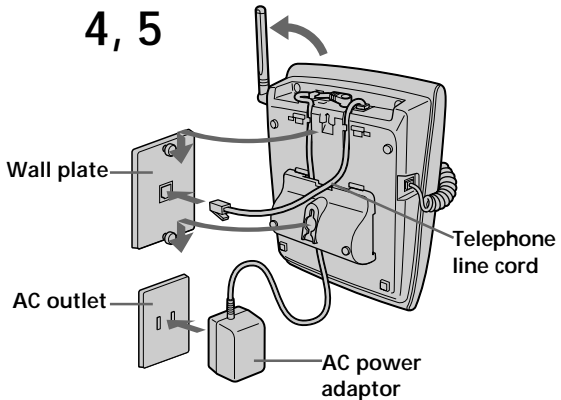

Tip

To remove the wall bracket, press the lower tabs.

Carrying the cordless handset by the belt clip

You can hang the cordless handset on the belt by attaching the belt clip to the cordless handset.

Attaching the belt clip

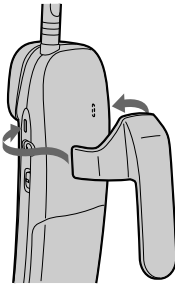

Press the belt clip to the cordless handset. Make sure that the side tabs click and go into the holes on the sides of the cordless handset.

Note

To prevent the cordless handset from dropping, make sure that each tab is completely inserted.

Detaching the belt clip

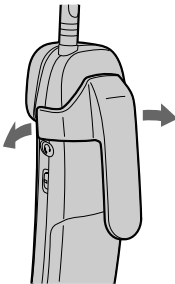

While pressing the back of the belt clip, pull the sides one by one until the tabs come off from the holes.

Note

Remove the belt clip carefully to avoid breaking your fingernails.

Using the headset

You can talk on the cordless handset without using your hands by connecting a headset (optional) to the  (HEADSET) jack on the cordless handset.

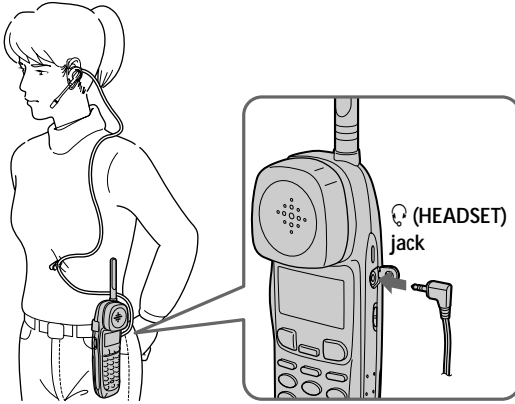

Notes on power sources

On battery pack

- Store the battery pack at a temperature between 41°F (5°C) and 95°F (35°C) for best performance.
- If you do not use the cordless handset for a long period of time, remove the battery pack after charging for more than 12 hours.

On power failure

During a power interruption, you cannot make or receive calls, and you cannot use the answering machine.

For the customers in the USA

RECYCLING NICKEL-CADMIUM BATTERIES

Nickel-Cadmium batteries are recyclable. You can help preserve our environment by returning your unwanted batteries to your nearest point for collection, recycling or proper disposal.



Note: In some areas the disposal of nickel-cadmium batteries in household or business trash may be prohibited.

RBRC (Rechargeable Battery Recycling Corporation) advises you about spent battery collection by the following phone number.

Call toll free number: 1-800-822-8837
(United States and Canada only)

Caution: Do not handle damaged or leaking nickel-cadmium batteries.

Maintenance

- Clean the cabinets with a soft cloth slightly moistened with water or a mild detergent solution. Do not use any type of abrasive pad, scouring powder or solvent such as alcohol or benzine as they may damage the finish of the cabinet.
- If the charge terminals of the charger and cordless handset are soiled, wipe them with a soft cloth.

If you have any questions or problems concerning your phone, please consult your nearest Sony dealer.

Troubleshooting

If you've experienced any of the following difficulties while using your phone, use this troubleshooting guide to help you remedy the problem. Should any problem persist, consult your nearest Sony dealer.

	Symptom	Remedy
Making calls	You hear five short error beeps when you press (TALK) .	<ul style="list-style-type: none"> • Make sure you have set up the base phone correctly (page 10). • Move the cordless handset closer to the base phone.
	You hear no dial tone.	<ul style="list-style-type: none"> • Make sure the telephone line cord is securely connected to the telephone outlet. • Make sure the battery is fully charged (page 13).
	The phone does not connect at all, even though the number you dial is correct.	<ul style="list-style-type: none"> • Make sure the dialing mode is set correctly (page 12).
	The phone does not redial correctly.	<ul style="list-style-type: none"> • Make sure the dialed number is really the one you want to dial.
	You cannot hear anything from the speakerphone.	<ul style="list-style-type: none"> • During phone conversation, press (VOLUME) (+) on the base phone to increase the speakerphone volume.
Long Distance Saver function	(LONG DIST. SAVER) does not function.	<ul style="list-style-type: none"> • Make sure that the Long Distance Saver function is set to "ACTIVE" (page 21).
	Even by pressing (LONG DIST. SAVER) , the long distance call is not being made.	<ul style="list-style-type: none"> • Make sure that the registered access number is correct and if the service provider needs any registration beforehand.
Receiving calls	The cordless handset does not ring.	<ul style="list-style-type: none"> • Set the RING switch on the cordless handset to ON. • The battery may be weak. Charge the battery for more than 12 hours (page 13). • Make sure you have set up the base phone correctly (page 10). • Move the cordless handset closer to the base phone.
	The base phone does not ring.	<ul style="list-style-type: none"> • Press (VOLUME) (+) on the base phone to increase the ringer volume. • Make sure the telephone line cord is securely connected to the telephone outlet.

	Symptom	Remedy
During conversation	You hear interference during conversation.	<ul style="list-style-type: none"> • Move the cordless handset closer to the base phone. • Place the base phone away from noise sources (page 10).
	You hear a beep every second during a conversation and “F” appears on the display.	<ul style="list-style-type: none"> • This is the out-of-range alarm. Move the cordless handset closer to the base phone within 30 seconds.
	You hear a beep twice per second and “BATTERY LOW” appears on the display.	<ul style="list-style-type: none"> • The battery is weak. Charge the battery for more than 12 hours (page 13).
One-touch dialing/ Phone Directory	You hear five short error beeps and cannot store a number on a one-touch dial or in the Phone Directory.	<ul style="list-style-type: none"> • Make sure you follow the procedure for storing the number correctly (pages 39, 43).
	You hear five short error beeps when you try to make a one-touch dial call.	<ul style="list-style-type: none"> • You have pressed a one-touch dialing button on which no phone number has been stored.
	One-touch dialing or Phone Directory dialing is incorrect.	<ul style="list-style-type: none"> • Store the correct number (pages 39, 43).
Intercom	The cordless handset does not ring when you use the intercom from the base phone, and the base phone does not ring when you use the intercom from the cordless handset.	<ul style="list-style-type: none"> • The battery may be weak. Charge the battery for more than 12 hours (page 13). • Move the cordless handset closer to the base phone. • Place the base phone away from noise sources (page 10).
	When pressing (INTERCOM) on the cordless handset, you hear a busy tone and cannot make an intercom call.	<ul style="list-style-type: none"> • The base phone is being used to converse with an outside caller.

Troubleshooting (continued)

	Symptom	Remedy
Answering machine	You cannot hear anything from the speaker.	<ul style="list-style-type: none"> During playback, press VOLUME (+) on the base phone to increase the answering volume.
	No time stamp is heard.	<ul style="list-style-type: none"> Make sure the day and time are set (page 22). The day and time may have been cleared due to a power interruption. Set them again (page 22).
	You cannot record the greeting properly.	<ul style="list-style-type: none"> Keep your message between two seconds and one minute. Make sure you speak about 12 inches (30 cm) away from the microphone when recording.
	The phone does not record messages.	<ul style="list-style-type: none"> Check the answering mode. The phone cannot record messages in announcement only mode (page 60). Make sure that the memory is not full. When the remaining recording area is less than one minute, the phone switches to announcement only mode automatically. The phone does not record a message that is shorter than two seconds. Even if the message is longer than four minutes, the phone only records up to four minutes.
Operating from an outside phone	The phone does not accept your remote ID code (security code).	<ul style="list-style-type: none"> Make sure you call from a touch-tone phone. Make sure you entered your remote ID code (security code) within two seconds after you have entered (#).
	You hear error beeps when you enter your remote ID code (security code).	<ul style="list-style-type: none"> Make sure the remote ID code (security code) is correct.
	A long confirmation beep does not sound when you enter your remote ID code (security code).	<ul style="list-style-type: none"> Enter your remote ID code (security code) while the greeting is being played back. Make sure you are calling from a touch-tone phone.

Symptom	Remedy
The caller's name and/or phone number does not appear on the display.	<ul style="list-style-type: none"> • Make sure you have subscribed to Caller ID service. • Caller ID service may not work when the phone is connected to a Private Branch Exchange (PBX). • The call is made through company which does not offer Caller ID service. "OUT OF AREA" will appear on the display. • The call was "blocked." "PRIVATE" will appear on the display. • You have answered the call while "** RINGING **" was displayed. Please answer the call after the second ringer sound.
The caller's name and/or phone number does not appear on the display during call waiting.	<ul style="list-style-type: none"> • Make sure you have subscribed to "Caller ID with call waiting" service (page 80). • Make sure the "Caller ID with call waiting" service is set to "ACTIVE" (page 19). • Make sure nobody is talking with another phone on the same telephone line.
You cannot dial the number from the Caller ID list.	<ul style="list-style-type: none"> • Make sure you entered your area code correctly (page 15). • You may need to change the number of digits of the phone number (page 78). • This function may not work when the phone is connected to a Private Branch Exchange (PBX).
The memory match function does not work.	<ul style="list-style-type: none"> • If the call is from an office which uses multiple lines, the phone number may not match the number you put in the memory. • If you have stored phone number with an outside line access digit on a one-touch dial or in the Phone Directory because the phone is connected to a Private Branch Exchange (PBX), the phone number will not match the Caller ID data. • If you have stored phone number of less than 7 digits on a one-touch dial or in the Phone Directory, the phone number will not match the Caller ID data.

Caller ID

continued

Troubleshooting (continued)

	Symptom	Remedy
Power source/battery	The CHARGE lamp on the charger does not light up when you place the cordless handset to charge.	<ul style="list-style-type: none">• Wipe the charge terminals of the charger and the cordless handset with a soft cloth for better contact of the charge terminals.• Make sure the cordless handset is placed on the charger properly.• Make sure the cordless handset is placed on the charger with front side facing forward.
	The battery duration is short.	<ul style="list-style-type: none">• The battery pack was charged less than 12 hours (due to power failure, etc.).• The usage life of the battery has expired and needs replacement.

Specifications

General

- Spread method
 - Direct-Sequence Spread-Spectrum
- Access method
 - FDMA-TDD
- Frequency band
 - 902 - 928 MHz
- Operating channel
 - 23 channels
- Dial signal
 - Tone, 10 PPS (pulse) selectable
- Supplied accessories
 - See page 9.

Cordless handset

- Power source
 - Rechargeable battery pack BP-T24
- Battery life
 - Standby: Approx. 6 days
 - Talk: Approx. 5 hours
- Battery charging time
 - Approx. 12 hours
- Dimensions
 - Approx. 58 x 185.4 x 48 mm (w/h/d), antenna excluded (approx. 2 ³/₈ x 7 ³/₈ x 1 ¹⁵/₁₆ inches)
 - Antenna: Approx. 72 mm (approx. 2 ⁷/₈ inches)
- Mass
 - Approx. 260 g (approx. 9.2 oz), battery included

Base phone

- Power source
 - DC 11V from AC power adaptor AC-T107
- Dimensions
 - Approx. 175 x 60 x 214 mm (w/h/d), antenna excluded (approx. 7 x 2 ³/₈ x 8 ¹/₂ inches)
 - Antenna: Approx. 112 mm (approx. 4 ¹/₂ inches)
- Mass
 - Approx. 580 g (approx. 1 lb 4 oz), wall bracket excluded

Charger

- Power source
 - DC 6V from AC power adaptor
- Dimensions
 - Approx. 72.5 x 60 x 85 mm (w/h/d) (approx. 2 ⁷/₈ x 2 ³/₈ x 3 ³/₈ inches)
- Mass
 - Approx. 204 g (approx. 7.2 oz)

Answering machine

- Maximum recording time
 - About 20 minutes (at "NORM (LONG PLAY)" recording quality), using incorporated IC
- Greeting message
 - Up to one minute
- Incoming message
 - Up to 4 minutes/message
- Memo
 - Up to 4 minutes/message

Design and specifications are subject to change without notice.

Index

A

Adjusting volume
 answering 55, 64
 cordless handset volume 29, 36
 handset volume 32, 37
 speakerphone volume 32, 37

Answering machine
 turning on 62

Answering mode 60

Area code 15

Audible indicate 61

B

Battery pack
 charging 13
 duration 14

C

Call waiting service 29, 36

Caller ID 70

 Caller ID list 71

 calling back 74

 memory match function 70

 playing back a message from the Caller ID list 76

 storing in Phone Directory 77

Caller ID with call waiting 19, 80

Carrying the cordless handset by the belt clip 82

Connection 11

Control codes for remote operations 69

D

Day and time stamp 22

Dialing mode

 choosing 12

 switching to the tone temporarily 29

Directory

 Phone Directory 43

E, F

Erasing

 Caller ID data 72

 phone numbers dialed 34

 messages 65

 Phone Directory 45

G

Greeting 56

H

Headset 29, 35, 83

Hold 29, 36

Home area code 15

I, J, K

Identifying the parts 24

Intercom 51

L

Local area code 17

Location, base phone 10

Long Distance Saver function 20, 29

M, N

Making calls 28

Memo 67

Memory match function 70

Messages 63

Mounting the base phone on a wall 81

O

One-touch dialing 39

Operating from an outside phone 68

OUT OF AREA 70

P, Q

Package contents 9

Playing back a message from the Caller ID list 76

Phone Directory 43

Playing

 announcement only 60

 messages 63, 76

PRIVATE 70

Pulse dialing 12

R

Receiving calls 35

Recording

 greeting 56

 memo 67

Recording quality 59

Redialing 33

Remote ID code (security code) 68

Ringer

 RING switch 36

S

Screening calls 66

Setting up

base phone 10

cordless handset 13

Setting up the phone
services 19

Speakerphone 32

Stamping messages with
day and time 22

Storing Caller ID data in
Phone Directory 77

Switching phones during a
call 50

T, U

Toll-saver feature 58

Talking between the
phones 51

Tone dialing

dialing mode 12

switching to 29

Transferring a call 53

Troubleshooting 86

V, W, X, Y, Z

Volume

answering 55, 64

cordless handset 29, 36

handset 32, 37

speakerphone 32, 37

For the customers in the USA

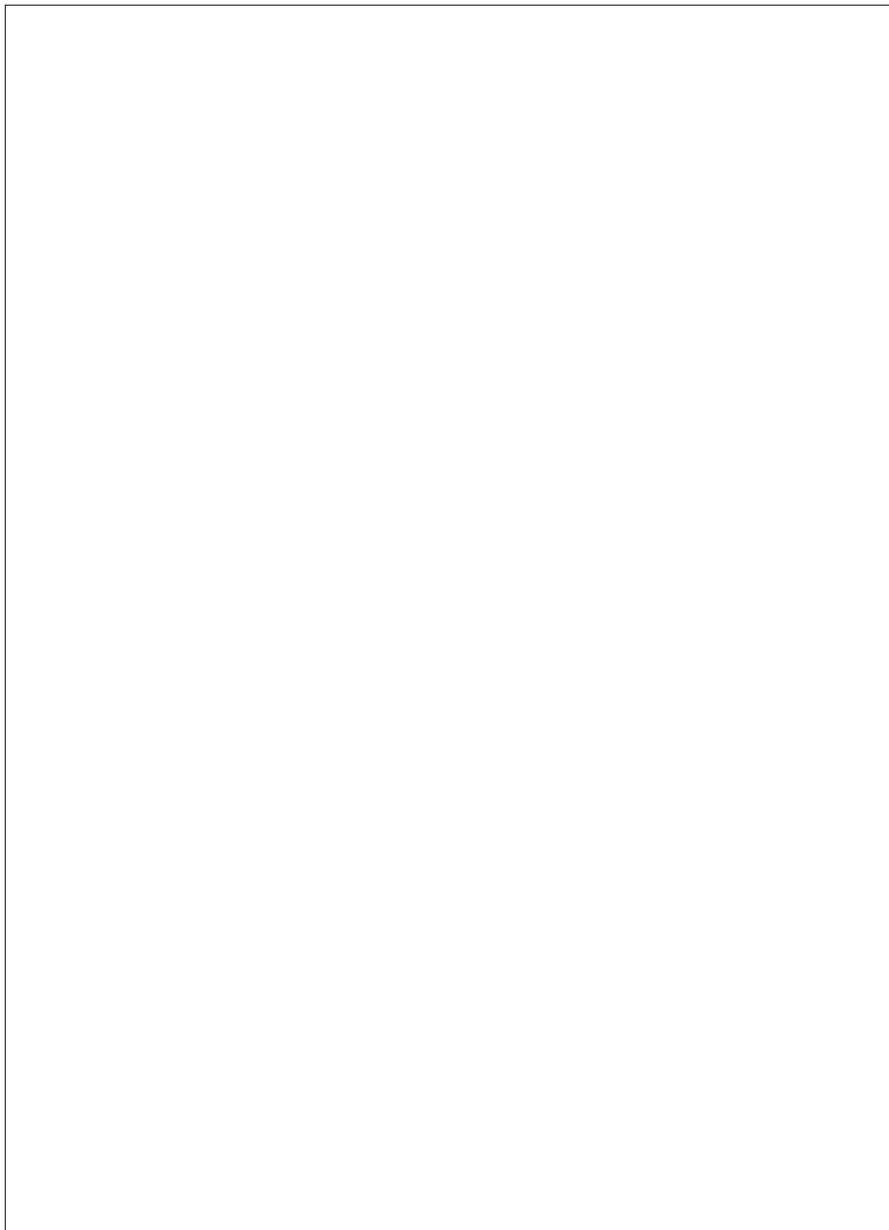

Be sure to save the receipt and attach it to your WARRANTY card when having your equipment repaired at an authorized Sony service station.

For online product registration, please contact
www.sony.com/productregistration.

Free Manuals Download Website

<http://myh66.com>

<http://usermanuals.us>

<http://www.somanuals.com>

<http://www.4manuals.cc>

<http://www.manual-lib.com>

<http://www.404manual.com>

<http://www.luxmanual.com>

<http://aubethermostatmanual.com>

Golf course search by state

<http://golfingnear.com>

Email search by domain

<http://emailbydomain.com>

Auto manuals search

<http://auto.somanuals.com>

TV manuals search

<http://tv.somanuals.com>