

Cordless Telephone

Operating Instructions

US

QuadraStation 2.4

CALLER ID
with call waiting

Hearing-Aid Compatible

SPP-S2730

©2001 Sony Corporation

Download from [Www.Somanuals.com](http://www.Somanuals.com). All Manuals Search And Download.

IMPORTANT SAFETY INSTRUCTIONS

When using your telephone equipment, basic safety precautions should always be followed to reduce the risk of fire, electric shock and injury to persons, including the following:

1. Do not use this product near water, for example, near a bath tub, wash bowl, kitchen sink, or laundry tub, in a wet basement, or near a swimming pool.
2. Avoid using a telephone (other than a cordless type) during an electrical storm. There may be a remote risk of electric shock from lightning.
3. Do not use the telephone to report a gas leak in the vicinity of the leak.
4. Use only the power cord and batteries indicated in this manual. Do not dispose of batteries in a fire. They may explode. Check with local codes for possible special disposal instructions.

SAVE THESE INSTRUCTIONS

Owner's Record

The model and the serial numbers are located at the bottom of the unit. Record the serial number in the space provided below. Refer to these numbers whenever you call upon your Sony dealer regarding this product.

Model No. SPP-S2730

Serial No. _____

Caution

You are cautioned that any changes or modifications not expressly approved in this manual could void your authority to operate this equipment.

Privacy of communications may not be ensured when using this phone.

Note

This equipment has been tested and found to comply with the limits for a Class B digital device, pursuant to Part 15 of the FCC Rules. These limits are designed to provide reasonable protection against harmful interference in a residential installation. This equipment generates, uses and can radiate radio frequency energy and, if not installed and used in accordance with the instructions, may cause harmful interference to radio communications. However, there is no guarantee that interference will not occur in a particular installation. If this equipment does cause harmful interference to radio or television reception, which can be determined by turning the equipment off and on, the user is encouraged to try to correct the interference by one or more of the following measures:

- Reorient or relocate the receiving antenna.
- Increase the separation between the equipment and receiver.
- Connect the equipment into an outlet on a circuit different from that to which the receiver is connected.
- Consult the dealer or an experienced radio/TV technician for help.

Operation is subject to the following two conditions: (1) This device may not cause interference, and (2) This device must accept any interference, including interference that may cause undesired operation.

IMPORTANT NOTE

To comply with FCC RF exposure compliance requirements, please follow the following guidelines in order to protect body from exposure to RF electromagnetic energy.

1. Avoid direct body contact with transmitting antenna during telephone conversation.
2. Do not replace or modify the transmitting antenna in any way.

INFORMATION FOR FCC REGURATION CLAIM

1. This equipment complies with Part 15 and Part 68 of the FCC rules for the United States. On the bottom of this equipment is a label that contains, among other information, the FCC certification number and ringer equivalence number (REN) for this equipment. If requested, this information must be provided to the telephone company.
2. This equipment connect to nationwide telephone network through a modular telephone jack which applicable certification jack (connector) is USOC-RJ11C.
3. The FCC compliant telephone cord and modular plug is provided with this equipment. This equipment is designed to be connected to the telephone network or premises wiring using a compatible modular jack that is part 68 compliant.
4. The REN is used to determine the quantity of devices that may be connected to the telephone line. Excessive RENs on the telephone line may result in the devices not ringing in response to an incoming call. Typically, the sum of the RENs should not exceed five (5.0). To be certain of the number of devices that may be connected to a line, as determined by the total RENs, contact the local telephone company.
5. If this equipment (SPP-S2730) causes harm to the telephone network, the telephone company will notify you in advance that temporary discontinuance of service may be required. But if advance notice isn't practical, the telephone company will notify the customer as soon as possible. Also, you will be advised of your right to file a complaint with the FCC if you believe it is necessary.
6. The telephone company may make changes to it's facilities, equipment, operations or procedures that could affect the operation of the equipment. If this happens the telephone company will provide advance notice so you can make the necessary modifications to maintain uninterrupted service.
7. If trouble is experienced with this equipment (SPP-S2730), for repair or warranty information, please contact Sony Direct Response Center: Tel 1-800-222-7669. If the equipment is causing harm to the telephone network, the telephone company may request that you disconnect the equipment until the problem is resolved.
8. All repairs will be performed in an authorized Sony service station.
9. This equipment may not be used on coin service provided by the Phone Company or Party Lines.
10. This equipment is hearing aid compatible.

When programming emergency numbers and (or) making test calls to emergency numbers:

1. Remain on the line and briefly explain to the dispatcher the reason for the call.
2. Perform such activities in the off-peak hours, such as early morning or late evenings.

IMPORTANTES INSTRUCCIONES DE SEGURIDAD

A fin de reducir el riesgo de incendio, descarga eléctrica y lesiones a las personas cuando usted use su equipo telefónico, siempre debe observar precauciones básicas de seguridad, entre ellas:

1. No use este producto cerca del agua, por ejemplo, cerca de una bañera, lavabo, fregadero de cocina o lavadora, en un sótano mojado o cerca de una piscina.
2. Evite usar un teléfono (que no sea del tipo inalámbricos) durante una tormenta eléctrica. Existe la remota posibilidad de shock eléctrico debido a rayos.
3. Para notificar una fuga de gas, no utilice el teléfono en la vecindad de dicha fuga.
4. Utilice solamente el cable de alimentación y las pilas indicados en este manual. No tire las pilas al fuego. Podrían explotar. Compruebe los códigos locales con respecto a las instrucciones especiales sobre cómo deshacerse de ellas.

GUARDE ESTAS INSTRUCCIONES

Precaución

Se le advierte que cualquier cambio o modificación no aprobado expresamente en el presente manual podría anular su autorización para operar este equipo.

El secreto de las comunicaciones puede no asegurarse cuando utilice este teléfono.

Nota

Este equipo se ha sometido a pruebas y se ha determinado que cumple los límites para un aparato digital Clase B de conformidad con la Parte 15 de las Reglas FCC. Dichos límites están diseñados para brindar protección razonable contra interferencia dañina en una instalación residencial. Este equipo genera, utiliza y puede radiar energía de radiofrecuencia y, si no se instala y se usa de acuerdo con las instrucciones, puede ocasionar interferencia dañina en las radiocomunicaciones. Sin embargo, no hay garantía de que no ocurra interferencia en una instalación específica. En caso de que este equipo ocasione interferencia dañina en la recepción de radio o televisión, que se puede determinar apagando y encendiendo el equipo, se le insta al usuario a que trate de corregir la interferencia mediante una o más de las siguientes medidas:

- Reorientar o reubicar la antena de recepción.
- Aumentar la separación entre el equipo y el receptor.
- Conectar el equipo en un enchufe de un circuito distinto al circuito al cual está conectado el receptor.
- Consultar con el distribuidor o con un técnico experimentado de radio / televisión para ayuda.

La operación está sometida a las dos condiciones siguientes: (1) Este dispositivo puede no causar interferencia, y (2) Este dispositivo deberá aceptar cualquier interferencia, incluyendo la que pueda causar una operación indeseada.

NOTA IMPORTANTE

Para cumplir los requisitos de exposición a RF de la FCC, siga las guías indicadas a continuación a fin de proteger el cuerpo contra la exposición a la energía electromagnética de RF.

1. Evite el contacto directo con la antena de transmisión durante la conversación telefónica.
2. No reemplace ni modifique de ninguna manera la antena.

INFORMACIÓN PARA LA DEMANDA DE LA REGLAMENTACIÓN DE LA FCC

1. Este equipo cumple con la Parte 15 y la Parte 68 de las reglas de la FCC para EE.UU. En la base de este equipo hay una etiqueta que contiene, entre otra información, el número de certificado de la FCC y el número de equivalencia de timbre de llamada (REN) para este equipo. Cuando se solicite, esta información deberá ofrecerse a la compañía telefónica.
2. Este equipo se conecta a la red telefónica nacional a través de una toma telefónica modular cuya toma (conector) de certificado aplicable es USOC-RJ11C.
3. Con este equipo se suministran un cable telefónico y una clavija modular que cumplen las normas de la FCC. Este equipo ha sido diseñado para conectarse a la red telefónica o la instalación de un usuario utilizando una toma modular compatible que esté de acuerdo con la Parte 68.
4. El REN se utiliza para determinar la cantidad de dispositivos que podrán conectarse a la línea telefónica. El exceso de REN conectados a la línea telefónica puede resultar en que los dispositivos no contesten a llamadas entrantes. Normalmente, la suma de REN no deberá ser superior a cinco (5,0). Para enterarse del número total de REN que puede conectarse a una línea, póngase en contacto con la compañía telefónica.
5. Si este equipo (SPP-S2730) produce daños en la red telefónica, la compañía telefónica le notificará con antelación que es posible que se requiera la interrupción temporal del servicio. Pero si la notificación con antelación no es práctica, la compañía telefónica lo notificará al cliente lo antes posible. Además, se le notificará el derecho a realizar una reclamación a la FCC si usted lo considera necesario.

6. La compañía telefónica puede realizar cambios en sus instalaciones, equipos, operaciones, o procedimientos que pueden afectar la operación del equipo. Cuando suceda esto, la compañía telefónica le avisará con antelación para que pueda realizar las modificaciones necesarias a fin de mantener ininterrumpido el servicio.
7. Si experimenta algún problema con este equipo (SPP-S2730), con respecto a la reparación o a la información sobre la garantía, póngase en contacto con Sony Direct Response Center: Tel 1-800-222-7669 (EE. UU. solamente). Si el equipo causa problemas en la línea, la compañía telefónica puede solicitarle que desconecte el equipo hasta que se resuelva el problema.
8. Todas las reparaciones deberá realizarlas un centro de reparaciones Sony.
9. Este equipo puede no utilizarse en el servicio de pago previo proporcionado por la compañía telefónica o la línea compartida.
10. Este equipo es compatible con dispositivos para ayuda a la audición.

Cuando programe números de emergencia y (o) realice llamadas de prueba a los mismos:

1. Permanezca poco tiempo en la línea y explique a la otra parte la razón de la llamada.
2. Realice tales actividades en horas no punta, como por la mañana temprano o a últimas horas de la tarde.

Table of contents

Getting Started

- 8 Welcome
- 9 **Read this first**
- 10 Step 1: Checking the package contents
- 11 Step 2: Setting up the base phone
- 14 Step 3: Preparing the battery pack
- 16 Step 4: Choosing the dialing mode
- 17 Step 5: Entering the area code
- 21 Step 6: Setting the day and time
- 23 Setting up the EZ Access function
- 25 Registering additional cordless handsets
- 27 Changing the language of the display
- 28 Identifying the parts

Basics

- 32 **Making calls**
- 32 Making calls with the cordless handset
- 35 Making call with the base phone
- 37 Redialing
- 39 **Receiving calls**
- 39 Receiving calls with the cordless handset
- 41 Receiving calls with the base phone

Telephone Features

- 43 **Phone Directory**
- 43 Storing phone numbers and names
- 46 Making calls from the Phone Directory
- 48 Changing a stored name and/or phone number
- 49 Erasing a memory location
- 50 Transferring the Phone Directory memory
- 52 **Switching the phones during a call**
- 52 Switching from the base phone to the cordless handset
- 52 Switching from the cordless handset to the base phone
- 53 Switching from the cordless handset to another cordless handset

Intercom Operation

- 54 **Talking between the phones – Intercom**
- 54 Talking from the cordless handset to the base phone
- 55 Talking from the base phone to the cordless handset
- 56 Talking between the cordless handsets – Walkie-Talkie function

- 57 Transferring a call
- 57 Transferring from the cordless handset to the base phone
- 58 Transferring from the base phone to the cordless handset
- 59 Transferring between the cordless handsets

Caller ID Features

- 60 Understanding the Caller ID service
 - 60 When you receive a call
- 61 Looking at the Caller ID list
 - 61 Viewing the Caller ID list
 - 62 Erasing data from the Caller ID list
- 64 Using the Caller ID list
 - 64 Calling back a number from the Caller ID list
 - 65 Storing a number of the Caller ID list into the Phone Directory
 - 66 To change the number of digits of the phone number
- 68 Using "Caller ID with call waiting" service
- 69 Using voice mail service
 - 69 If you have messages

Additional Information

- 71 Mounting the base phone on a wall
- 72 Carrying the cordless handset by the belt clip
- 73 Notes on power sources
- 74 Maintenance
- 75 Troubleshooting
- 79 Specifications
- 80 **Index**

Back cover LIMITED WARRANTY

Welcome

Thank you for purchasing Sony QuadraStation 2.4!

The phone systems can be expanded to a total of four cordless handsets and realizes the Intercom conversation* between a couple of cordless handsets (Walkie-Talkie function).

* Also includes a communication between the base phone and the cordless handset.

First, read the followings.

- The system includes a cordless handset. If you utilize the walkie-talkie feature, it is necessary to purchase the SPP-H273 Sony cordless handset used for the QuadraStation 2.4 exclusively.
- Be sure to register the additional cordless handset(s) to the base phone before use. (See "Registering additional cordless handsets" on page 25.)
- Some procedures may vary according to the number of the cordless handset assigned to the system. The distinctions are explicitly explained in this manual. In such a case, see the appropriate procedure.

Other convenient features are as follows:

- Walkie-Talkie function — enables you to make an intercom conversation between a couple of cordless handsets of the same phone system far from the base phone (e.g. use out of doors) (page 56).
- EZ Access function — enables you to access to any set of numbers up to 32 digits long by simple one-touch (page 23).

Read this first

Before you use your phone, you must first set it up. Here's a quick way to set up your phone: Steps 1 to 6.

Step 1 (page 10)

First, unpack the phone and the supplied accessories.

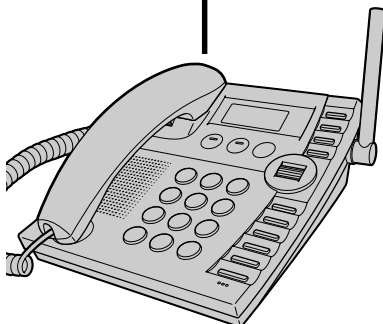

Base phone



Cordless handset

Step 2 (pages 11 to 13)

You need to do two things to set up the base phone, including finding the best location for the base phone.

Step 3 (pages 14 to 15)

Insert the battery pack into the cordless handset and charge it for more than 12 hours.

Step 4 (page 16)

Choose an appropriate dialing mode.

Step 5 (pages 17 to 20)

Enter the area code to use the Caller ID service.

Step 6 (pages 21 to 22)

Set the day and time to stamp day and time for the incoming messages.

That's it!

For using the EZ Access function, follow the procedure in "Setting up the EZ Access function" on page 23.

For using optional cordless handsets, follow the procedure in "Registering additional cordless handsets" on page 25.

For changing the language of the display, follow the procedure in "Changing the language of the display" on page 27.

Step 1

Checking the package contents

Make sure you have received the following items in the package. If anything is missing, contact your local Sony dealer.

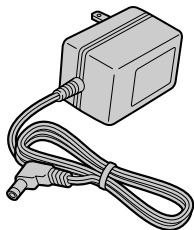

AC power adaptor for the base phone (AC-T46)

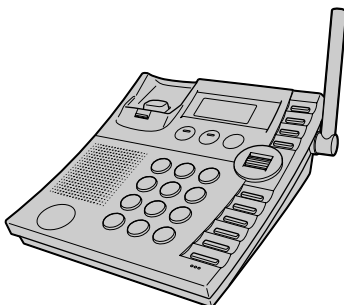

Base phone



Cordless handset

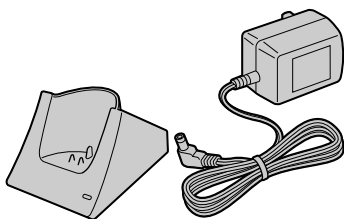

Charger/AC power adaptor for the charger (AC-T127)

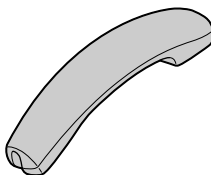

Handset

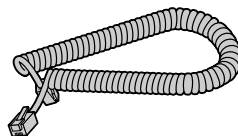

Handset cord

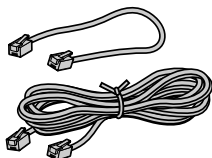

Telephone line cords (2)

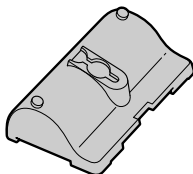

Wall bracket/stand for base phone

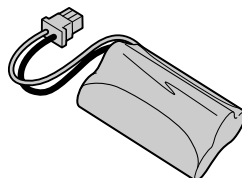

Rechargeable battery pack (BP-T38)

Step 2

Setting up the base phone

Do the following steps:

- Choose the best location
- Connect the base phone

Choose the best location

Where you place the base phone affects the reception quality of the cordless handset.

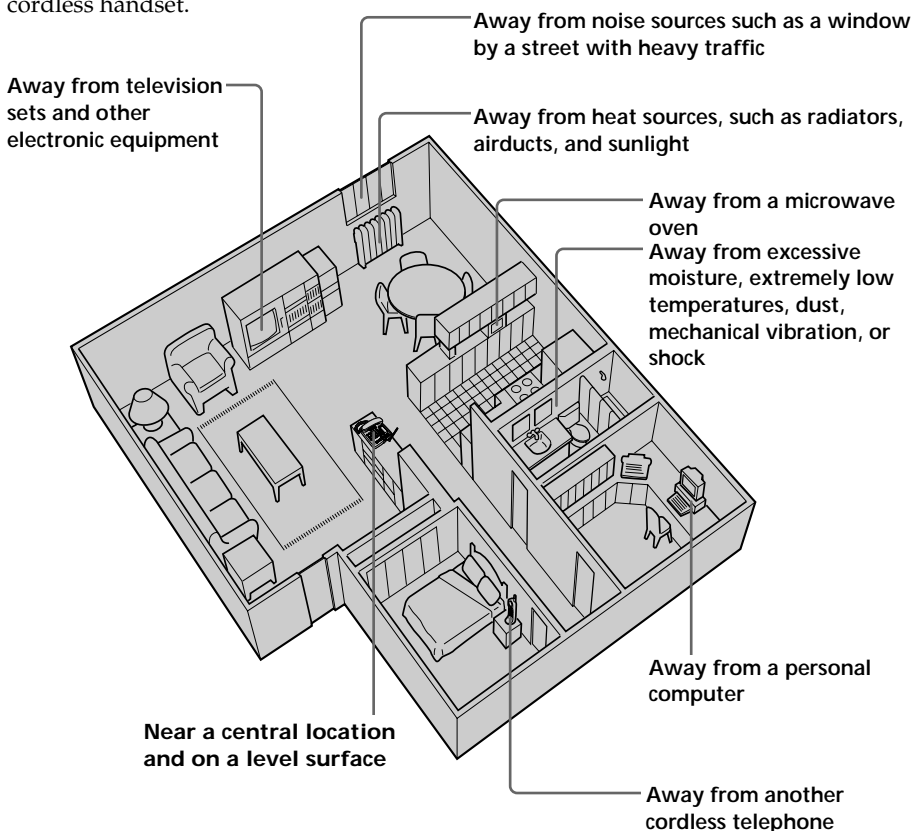

- CAUTION:**
- Should you experience intermittent loss of audio during a conversation, try moving closer to the base or move base phone away from other noise sources.
 - The cordless telephone operates at a frequency that may cause interference to nearby TVs, VCRs, and microwave oven; the base phone should not be placed near or on the top of a TV or VCR; and, if interference is experienced, moving the cordless telephone farther away from the TV, VCR, or microwave oven will often reduce or eliminate the interference.

continued

Step 2: Setting up the base phone (continued)

Connect the base phone

If you want to hang the base phone on the wall, see page 71.

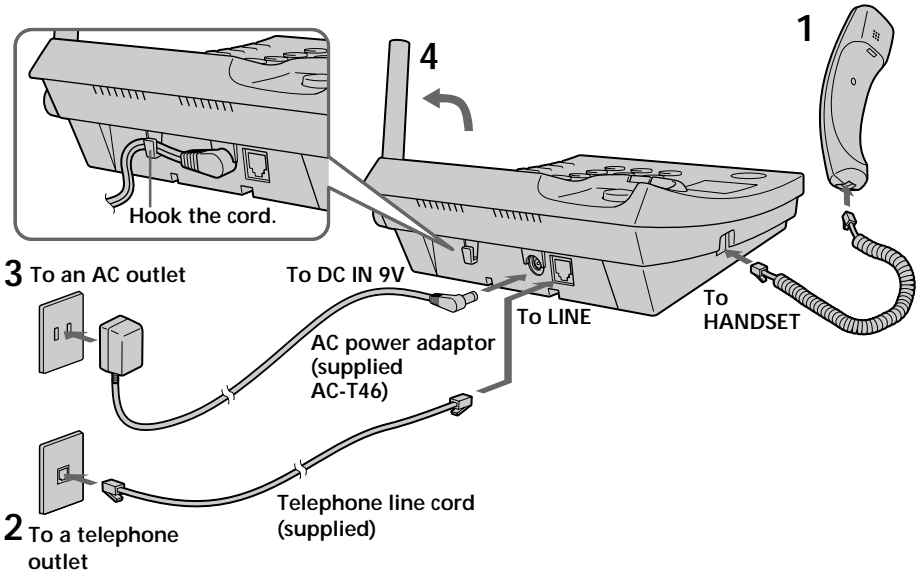

To tilt the phone

If you want to tilt the phone, attach the supplied wall bracket on the bottom of the base phone.

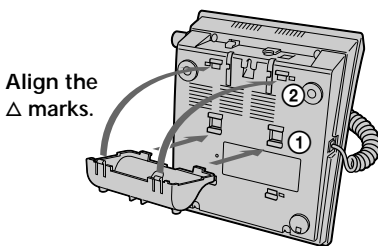

- 1** Connect the handset cord to the HANDSET jack and to the handset.
- 2** Connect the telephone line cord to the LINE jack and to a telephone outlet.
- 3** Connect the AC power adaptor to the DC IN 9V jack and to an AC outlet.
- 4** Raise the antenna. Make sure it points towards the ceiling.

Notes

- Use only the supplied AC-T46 AC power adaptor. Do not use any other AC power adaptor.
- Connect the AC power adaptor to a continuous power supply.
- Place the base phone close to the AC outlet so that you can unplug the AC power adaptor easily.

Tip

If your telephone outlet is not modular, contact your telephone service company for assistance.

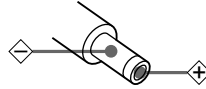
Polarity of the plug**Modular**

Step 3

Preparing the battery pack

Charge the battery pack for more than **12 hours** before you start using your cordless handset.

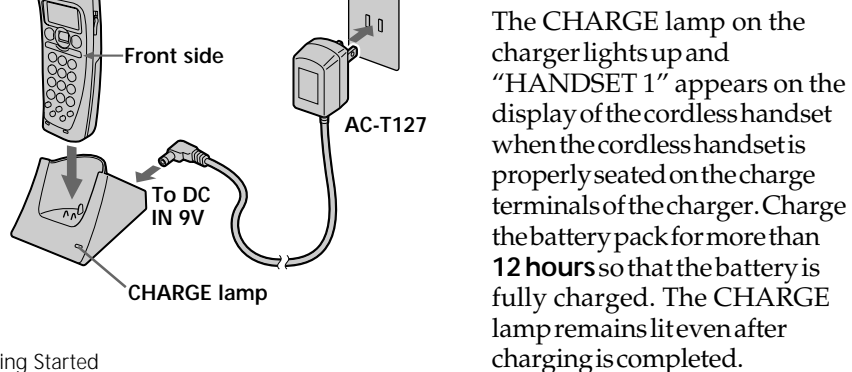
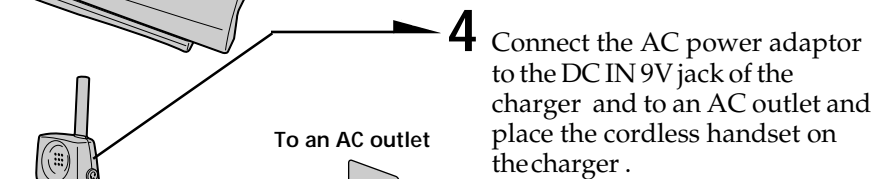
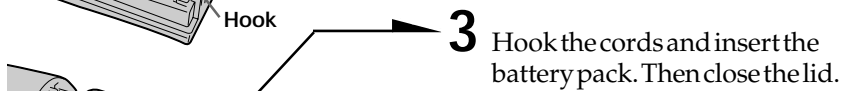
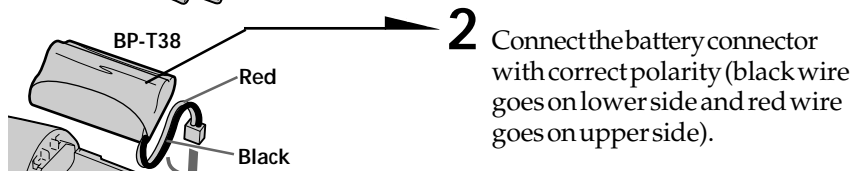
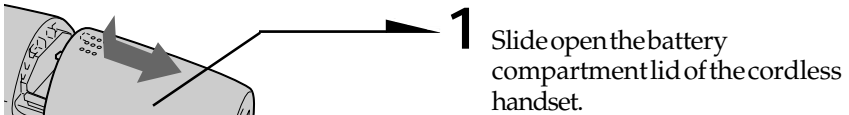

About the station number

When you start charging the battery, "HANDSET 1" appears on the display of the cordless handset. This shows the ID number for each cordless handset and base phone of the system, called "station number." The station number of the base phone is set to 0 and that of the cordless handset (supplied with the base phone) is set to 1 at the factory. The station number of the cordless handset newly added to the system will be one of the number 2 through 4 in the order of registration. (See "Registering additional cordless handsets" on page 25.)



HANDSET 1

Battery duration

A fully charged battery pack lasts for about:

- Approx. 5 hours when you use the cordless handset continuously
- Approx. 6 days when the cordless handset is in standby mode.

Notes

- The battery pack will gradually discharge over a long period of time, even when not in use.
- If you leave the battery pack in the cordless handset without charging it, the battery pack will be completely discharged.
It may require several times of charging to recover to its full capacity.
- While charging, the battery pack warms up. This is not a malfunction.

To obtain the best performance from the battery

Do not place the cordless handset on the charger after each call. The battery works best if the cordless handset is returned to the charger after two or three calls. However, do not leave the cordless handset off the charger for a long period of time as this will completely discharge the battery pack.

When to purchase a new battery pack

If the battery lasts only a few minutes even after **12 hours** of charging, the usable life of the battery has expired and needs replacement. Contact your local Sony authorized dealer or service center, and ask for a Sony **BP-T38** rechargeable battery pack.

Note

Battery life may vary depending on usage condition and ambient temperature.

Step 4

Choosing the dialing mode

For the telephone to work properly, select an appropriate dialing mode (tone or pulse).

You can select the dialing mode on both the base phone and cordless handset. The dialing mode that has been last set either with the base phone or cordless handset is selected.

When you set the dialing mode with the cordless handset, make sure the base phone* is not in use before you start the setting. You cannot set the dialing mode while the system is in use.

* If the system includes additional cordless handsets, it is necessary to stop using them before you start the setting as well.

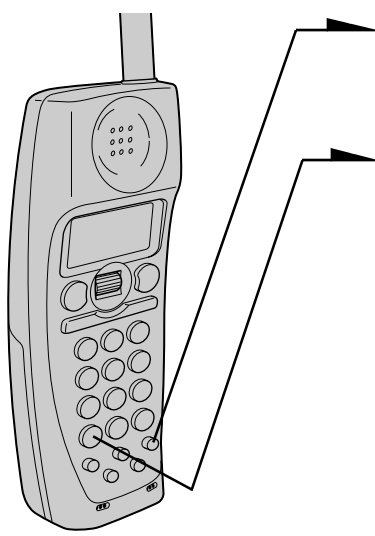

1 Press **PGM**. (Press **PROGRAM** on the base phone.)

2 Press ***TONE**.
You hear a confirmation beep.

DIAL MODE
1: TONE
2: PULSE

3 Press **①** for tone dialing or **②** for pulse dialing.
You hear a long confirmation beep.

If you aren't sure of your dialing system

Make a trial call with the dialing mode set to TONE.

If the call connects, leave the setting as is; otherwise, set to PULSE.

Note

Do not allow more than 60 seconds to elapse during the operation procedure.

Step 5

Entering the area code

When you use this phone for the first time, or move to an area that has a different area code, you must enter the area code. Otherwise, you cannot use some functions of this phone and the Caller ID functions.

This is also necessary because the phone must be able to select an area code to properly dial a call from the Caller ID list.

Depending on your region, enter the 3-digit area code as follows:

Case 1.

If 7-digit dialing (no area code) is accepted for local calls in your area, see "To enter your home area code" below.

If you live in an area where calls from or to other local areas can also be made by 10-digit dialing (area code + number), you can register up to 5 local area codes with this telephone to take advantage of this system. See "To enter the local area code (For 10 digits phone number users)" on page 19.

Case 2.

If 10-digit dialing (area code + number) is required for **all** local calls in your area, see "To enter the local area code (For 10 digits phone number users)" on page 19.

Entering the area code is only possible on the cordless handset. Make sure the base phone* is not in use before you start the setting. You cannot enter the area code while the system is in use.

* If the system includes additional cordless handsets, it is necessary to stop using them before you start the setting as well.

To enter your home area code

1 Press **PGM**.

2 Turn Jog Dial to choose "AREA CODE", and then press Jog Dial.

3 Press Jog Dial again.
"ENTER HOME AREA CODE" appears on the display.

ERASE

Turn Press

(GO BACK)
▶HOME
: :
↓LOCAL 1:

ENTER
HOME AREA CODE
-

continued

Step 5: Entering the area code (continued)

4 Enter the three digits of your home area code using the dialing keys.

5 Press **(PGM)**.

You hear a long confirmation beep.

Notes

- If the home area code is already entered, it appears on the display in step 2. To enter a different home area code, see "To change the home area code" below.
- Do not allow more than 60 seconds to elapse during the operation procedure.
- If the area code has not been entered, calling back from the Caller ID list and storing the Caller ID data into the Phone Directory cannot be performed.
- If the home area code is not correctly entered, "ERROR" will appear on the display and five short error beeps will be heard after **(PGM)** is pressed in step 5. Move the cordless handset closer to the base phone, make sure the base phone* is not in use before you start the setting.
- * If the system includes additional cordless handsets, it is necessary to stop using them before you start the setting as well.

Tips

- When you select "(GO BACK)", you can return to the previous set display by pressing Jog Dial.
- To check the current home area code, perform steps 1 and 2. The home area code appears on the display for about 60 seconds.

To change the home area code

1 Perform steps 1 to 3 on page 17.

The current home area code appears on the display.

2 Press **(ERASE)** to erase the current home area code.

3 Enter a new home area code using the dialing keys.

4 Press **(PGM)**.

You hear a long confirmation beep.

To erase the home area code

You can erase the home area code. Perform steps 1 and 2 above, then press **(PGM)**.

The home area code will be erased, and you hear a long confirmation beep.

To enter the local area code (For 10 digits phone numbers users)

If a call matches one of the local area codes you entered, the phone number will be registered with 10 digits in the Caller ID list (area code + number). If a call does not match one of the local area codes you entered, the phone number will be registered with 11 digits in the Caller ID list (1 + area code + number). Some regions of the country allow you to have more than one local area code. (Up to five local area codes can be entered in this phone.)

- 1 Perform steps 1 and 2 on page 17.
- 2 Select the number ("LOCAL 1" to "LOCAL 5") to enter the local area code by turning Jog Dial.



```

↑HOME   :
▶LOCAL 1:
↓LOCAL 2:
  
```

- 3 Press Jog Dial.

"ENTER LOCAL AREA CODE 1" appears on the display when you select "LOCAL 1" in step 2.

- 4 Enter the three digits of the local area code using the dialing keys.
- 5 Press **(PGM)**.

You hear a long confirmation beep.

Notes

- If the local area code is already entered, it appears on the display in step 2. To enter a different local area code, see "To change the local area code" on page 20.
- Do not allow more than 60 seconds to elapse during the operation procedure.
- If the local area code is not correctly entered, "ERROR" will appear on the display and five short error beeps will be heard after **(PGM)** is pressed in step 5. Move the cordless handset closer to the base phone, make sure the base phone* is not in use before you start the setting.
- * If the system includes additional cordless handsets, it is necessary to stop using them before you start the setting as well.

Tips

- When you select "(GO BACK)", you can return to the previous set display by pressing Jog Dial.
- To check the current local area code, perform steps 1 and 2. The local area code appears on the display for about 60 seconds.

continued

Step 5: Entering the area code (continued)

To change the local area code

- 1 Perform steps 1 to 3 on page 19.
The current local area code appears on the display.
- 2 Press **(ERASE)** to erase the current local area code.
- 3 Enter a new local area code using the dialing keys.
- 4 Press **(PGM)**.
You hear a long confirmation beep.

To erase the local area code

You can erase the local area code. Perform steps 1 and 2 above, then press **(PGM)**. The local area code will be erased, and you hear a long confirmation beep.

Step 6

Setting the day and time

You can set the day and time only with the cordless handset. Make sure the base phone* is not in use before you start the setting.

* If the system includes additional cordless handsets, it is necessary to stop using them before you start the setting as well.

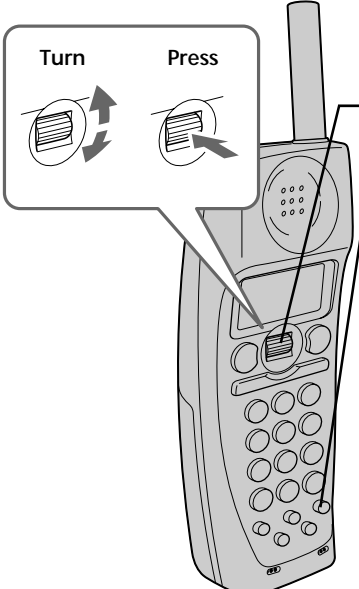

1 Press **PGM**.

2 Turn Jog Dial to choose "DAY/TIME", and then press Jog Dial.

(GO BACK)
 ► SUNDAY
 ▼ MONDAY

3 Set the correct day of the week by turning Jog Dial, and then press Jog Dial. The time that has been last set appears on the display.

ENTER HOUR AND
 PRESS JOG DIAL
 12:00AM

4 Set the hour (1 to 12) by turning Jog Dial

ENTER HOUR AND
 PRESS JOG DIAL
 11:

continued

Step 6: Setting the day and time (continued)

5 Press Jog Dial.

ENTER MINUTE AND
PRESS JOG DIAL
11:00

6 Set the minute (00 to 59) by turning Jog Dial.

ENTER MINUTE AND
PRESS JOG DIAL
11:01

7 Press Jog Dial.

SELECT AM/PM AND
PRESS JOG DIAL
11:01AM

8 Select “AM” or “PM” by turning Jog Dial, and then press Jog Dial.

You hear a long confirmation beep. Then the phone starts counting time.

Notes

- Do not allow more than 60 seconds to elapse during the operation procedure.
- “SUN 12:00AM” on the display of the base phone flashes when the day and time is cleared due to a power interruption, or when you connect the base phone to the AC outlet for the first time.
- When “ERROR” appears on the display and five short error beeps are heard after Jog Dial is pressed in step 8, move the cordless handset closer to the base phone, make sure the base phone* is not in use before you start the setting.
- * If the system includes additional cordless handsets, it is necessary to stop using them before you start the setting as well.

Tip

When you select “(GO BACK)”, you can return to the previous set display by pressing Jog Dial.

Setting up the EZ Access function

The EZ Access function enables you to access to any set of numbers up to 32 digits long by simple one-touch. Use for calling cards plus PIN, voice mail, long distance provider, or any other set of frequently used number.

After setting up the access number, you only need to press (EZ ACCESS) for dialing the access number of your special services e.g. long distance provider.

Also, you can set up just a phone number with the function for one-touch dialing.

You can set up the EZ Access function on both the base phone and the cordless handset, further more, you can assign a different access number to each unit (base phone and cordless handset).

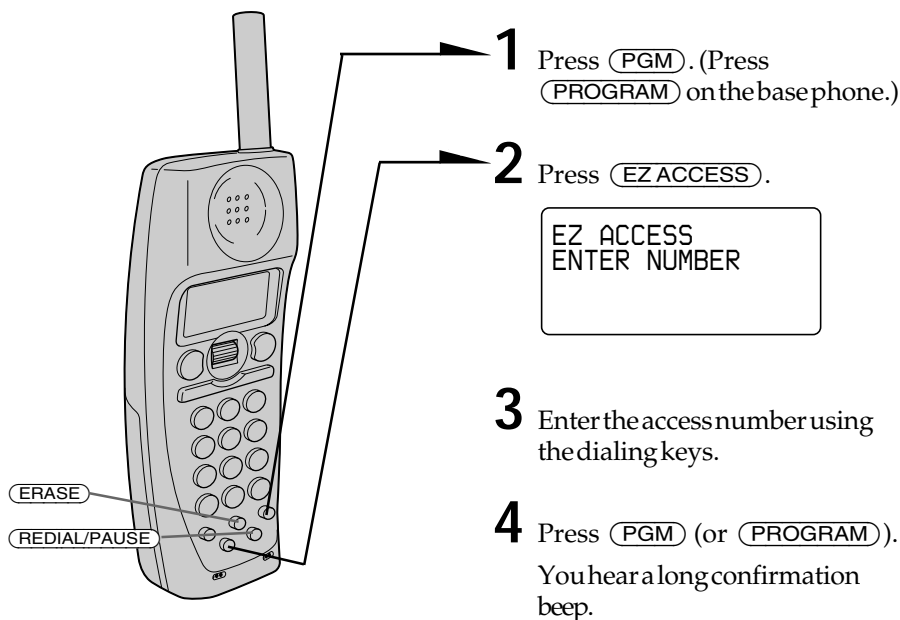

Notes

- Do not allow more than 60 seconds to elapse during the operation procedure.
- You can register up to 32 digits as an access number.

Tip

When you select "(GO BACK)", you can return to the previous set display by pressing Jog Dial.

continued

Setting up the EZ Access function (continued)

To use the EZ Access

- for making calls, see page 33, 35.
- for redialing, see page 37.
- for making calls from the Phone Directory, see page 47.
- for making calls from Caller ID list, see page 64.

To change the access number

- 1 Perform steps 1 and 2 on page 23.
The current access number appears on the display.
- 2 Press **(ERASE)** to erase the current access number.
- 3 Enter a new access number using the dialing keys.
- 4 Press **(PGM)**. (Press **(PROGRAM)** on the base phone.)
You hear a long confirmation beep.

To store a number to be dialed via Private Branch Exchange (PBX)

Before entering a phone number in step 3 on page 23, do as follows:

- 1 Enter the outside line access digit (e.g., 9).
- 2 Press **(REDIAL/PAUSE)**.

Registering additional cordless handsets

The phone system includes a cordless handset. You can expand the system including a total of four cordless handsets. Be sure to register the ID number of the additional cordless handset called "station number" to the base phone before using the additional cordless handset. The station number of the base phone is set to 0 and that of the cordless handset (supplied with the base phone) is set to 1 at the factory. The station number of the cordless handset newly added to the system will be one of the number 2 through 4 in the order of registration.

Before you start registering, set all the unit of the system in standby mode and place them close to each other (within a distance of 12 inches). Then do the following procedure only on the additional cordless handsets one by one.

Caution

Do not register two or three cordless handsets at the same time. Doing so may result in more than one cordless handsets having an identical station number.

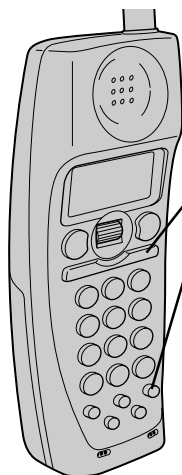
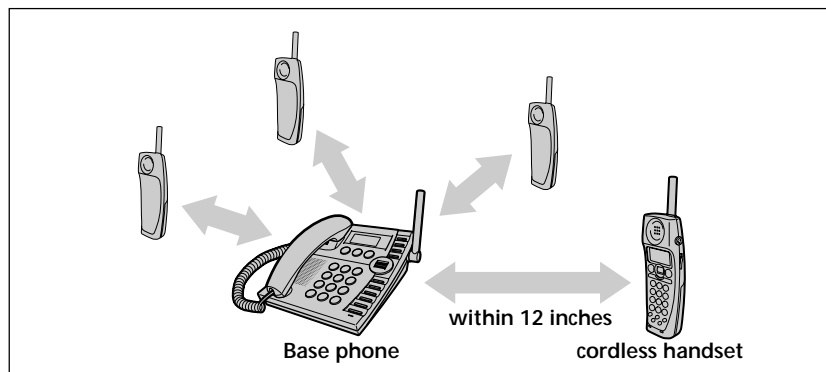

1 Press **PGM**.

2 Press **INTERCOM**.

You hear a confirmation beep.

ENTER SYSTEM ID

-

continued

Registering additional cordless handsets (continued)

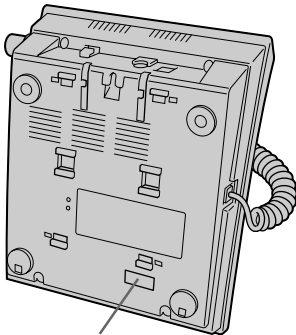

System ID

- 3** Enter the 8 digits system ID by pressing the dialing keys.
The system ID is shown on a sticker affixed to the bottom of the base phone.
- 4** Press **(PGM)**.
You hear a long confirmation beep and the assigned station number is displayed.

Notes

- Do not allow more than 60 seconds to elapse during the operation procedure.
- Once you add a cordless handset to the base phone system, you cannot change the station numbers, or cancel the additional registrations.
- When you press any button other than **(PGM)** to use an unregistered cordless handset, the message “PLEASE REGISTER THIS HANDSET” will appear on the display, and five short error beeps will be heard. You must first register the cordless handset you want to add to the system.
- If you try to register a cordless handset which you have already added to the system, the five short error beeps will be heard and the registration will be canceled.
- If the registration is unsuccessful, “ERROR” will appear on the display, and five short error beeps will be heard after **(PGM)** is pressed in step 4. Move all the cordless handsets closer to the base phone, and then start over the procedure.

To check the station number assigned to the additional cordless handset

The station number of the cordless handset appears on the display of the cordless handset while it is seated on the charger. You can also utilize the supplied sticker of the station number and attaching on the cordless handset. (For details, see Operating Instructions of SPP-H273.)

HANDSET 2

Changing the language of the display

You can choose English or Spanish as the display language by following the procedure below.

You can select the display language both the base phone and the cordless handset, further more, you can select the display language on each unit (base phone and cordless handset).

To change the language from English to Spanish

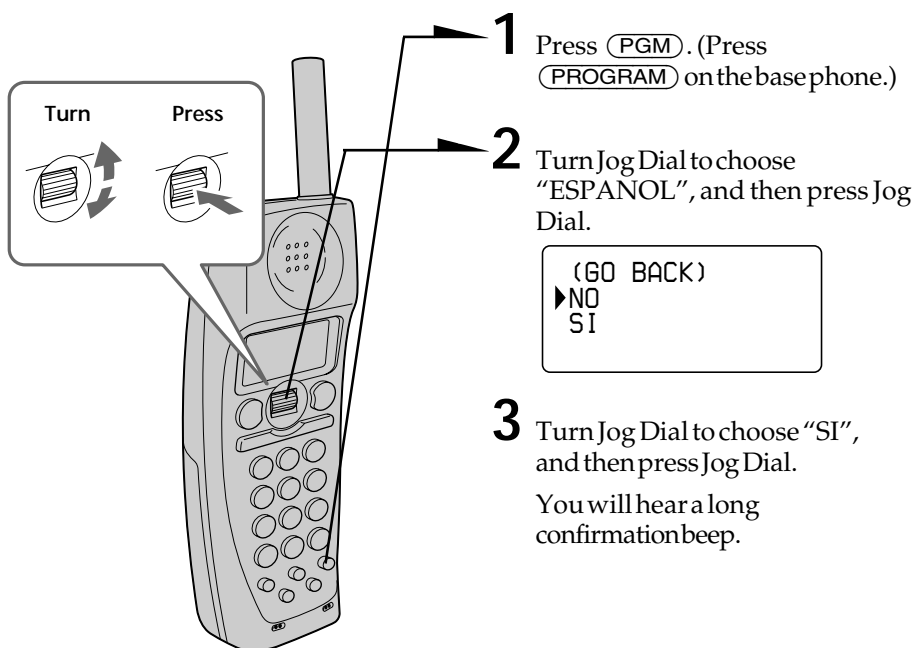

- 1 Press **PGM**. (Press **PROGRAM** on the base phone.)
- 2 Turn Jog Dial to choose "ESPANOL", and then press Jog Dial.

(GO BACK)
 ▶ NO
 SI
- 3 Turn Jog Dial to choose "SI", and then press Jog Dial.
You will hear a long confirmation beep.

Note

Do not allow more than 60 seconds to elapse during the operation procedure.

To change the language from Spanish to English

- 1 Press **PGM**. (Press **PROGRAM** on the base phone.)
- 2 Turn Jog Dial to choose "ENGLISH", and then press Jog Dial.
- 3 Turn Jog Dial to choose "YES", and then press Jog Dial.

You will hear a long confirmation beep.

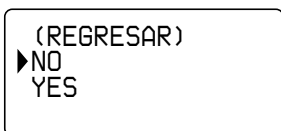

Identifying the parts

Refer to the pages indicated in parentheses for details.

Base phone

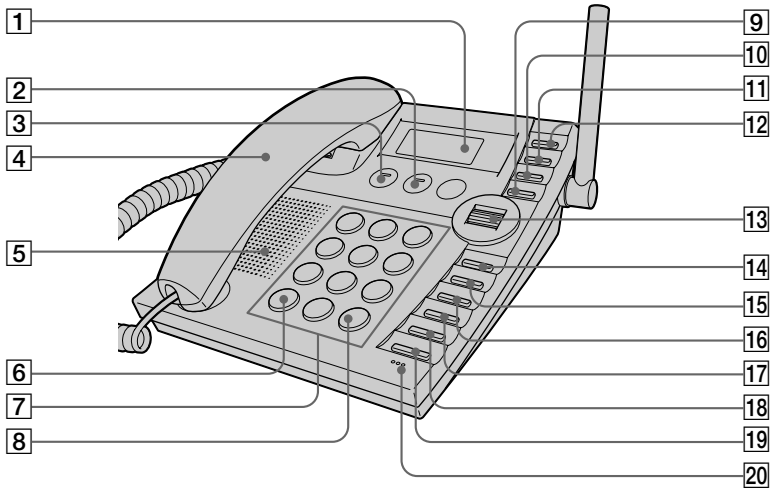

1 Display window (p. 35, 60)

2 VOICE MAIL lamp (p. 70)
Flashes when you have messages.

3 NEW CALL lamp (p. 61)
Flashes when there is a "NEW"
data in the Caller ID list.

4 Handset (p. 12, 35, 41)

5 Speaker

6 * TONE button (p. 33)
Allows you to switch temporarily to
tone dialing.

7 Dialing keys (p. 35)

8 # button (p. 66)
Used to change the number of
digits of the phone number in the
Caller ID list.

9 ERASE button (p. 24)

10 PROGRAM button (p. 23)

11 VOL - button (p. 35)

Adjusts the handset or speaker
volume.

12 VOL + button (p. 35)

Adjusts the handset or speaker
volume.

13 Jog Dial (p. 21, 61)

14 EZ ACCESS button (p. 23, 35)

Lets you make a call with the
registered access number.

15 REDIAL/PAUSE button (p. 37)

Redials one of the last five numbers
called/inserts a pause in the
sequence.

16 CALL WAITING/FLASH button
(p. 36, 68)

Switches to a second call if you
have "call waiting" service, or lets
you make a new call.

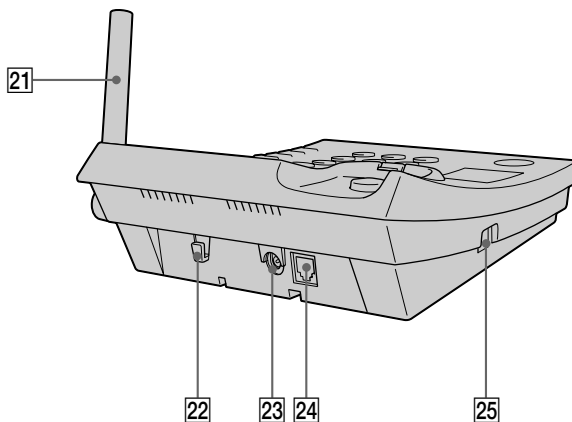

- 17 INTERCOM button** (p. 55)
Lets you talk between the base phone and cordless handset.
- 18 HOLD button** (p. 36)
Puts a call on hold.
- 19 SPEAKERPHONE button**
(p. 35)
Lets you make or receive a call.
- 20 MIC (microphone)**

- 21 Antenna** (p. 12, 71)
- 22 Hook for AC power adaptor cord** (p. 12, 71)
- 23 DC IN 9V jack** (p. 12, 71)
- 24 LINE (telephone line) jack**
(p. 12, 71)
- 25 HANDSET jack** (p. 12)

continued

Identifying the parts (continued)

Cordless handset

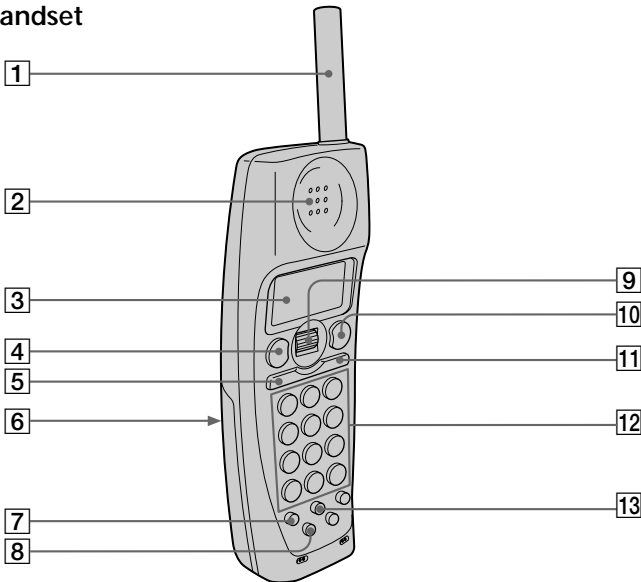

1 Antenna

2 Speaker

3 Display window (p. 32, 60)

4 TALK button (p. 32)

Lets you make or receive a call.

5 HOLD button (p. 33)

Puts a call on hold.

6 Battery compartment (p. 14)

7 CALL WAITING/FLASH button
(p. 33, 68)

Switches to a second call if you have "call waiting" service, or lets you make a new call.

8 EZ ACCESS button (p. 23, 33)

Lets you make a call with the registered access number.

9 Jog Dial (p. 17, 43, 61)

10 OFF button (p. 32, 40)

Allows you to disconnect the call.

11 INTERCOM button (p. 54, 56)

Lets you talk between the base phone and the cordless handset.

12 Dialing keys (p. 32)

13 ERASE button (p. 18, 45)

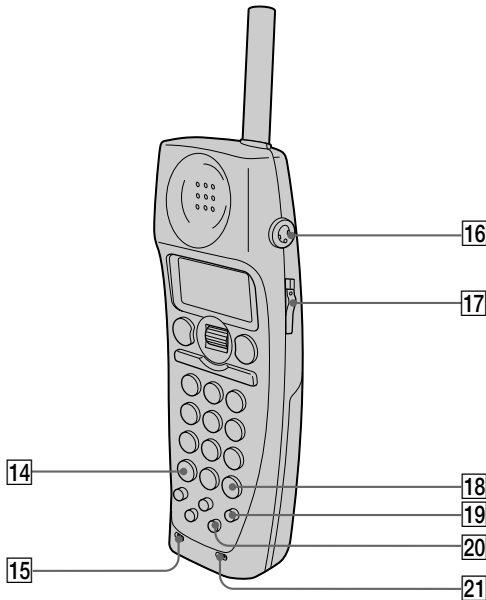

14 * **TONE button** (p. 33)

Allows you to switch temporarily to tone dialing.

15 **RINGER**

16 (HEADSET) **jack** (p. 33, 39, 72)

17 **VOL (volume) switch** (p. 33)

Adjust the cordless handset volume.

18 **# button** (p. 66)

Used to change the number of digits of the phone number in the Caller ID list.

19 **PGM (program) button**
(p. 17, 43)

20 **REDIAL/PAUSE button**
(p. 24, 37)

Redials one of the last five numbers called/inserts a pause in the dialing sequence.

21 **MIC (Microphone)**

Making calls

Making calls with the cordless handset

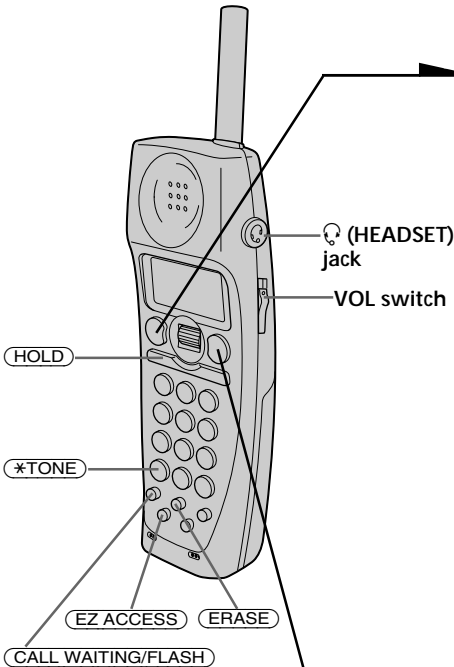

1 Pick up the cordless handset from the charger.

2 Press **TALK** and wait until “TALK” appears on the display and the display also shows the talk time in hours, minutes and seconds.

The dialing keys light up.

You then hear a dial tone.

“HANDSET 1 IN USE” appears on the display of the base phone when the cordless handset with the station number “1” is in use.

If you hear five short error beeps and “NO CONNECTION” appears on the display, move closer to the base phone.

3 Dial the phone number.

4 When you’re done talking, press **OFF** or replace the cordless handset on the charger.

The display turns off.

To make a call after checking the phone number

You can dial the phone number before pressing **TALK** or **EZ ACCESS**. If you make a mistake when dialing the phone number, press **ERASE** to erase the number.

Making calls when the headset is connected

When a headset (optional) is connected to the  (HEADSET) jack on the cordless handset, you can talk through the headset.

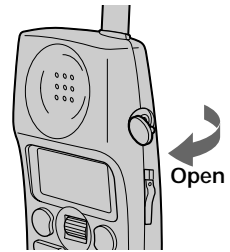

Making calls using the EZ Access function

To set up the access number, see “Setting up the EZ Access function” on page 23.

- 1 Pick up the cordless handset from the charger.
- 2 Dial the phone number (e.g., 1-201-123-4567, or 011-...).
- 3 Press **(EZ ACCESS)**.

The system dials first, the access number set up with the EZ access function, and then the phone number you dialed in step 2. “TALK” appears on the display.



- 4 When you're done talking, press **(OFF)** or replace the cordless handset on the charger.

Note

If you have set up a phone number with the EZ access function, just press **(EZ ACCESS)** to dial the phone number (i.e. skip step 2).



Additional tasks

To	Do this
Adjust the cordless handset volume	Set the VOL switch to H (high), M (middle) or L (low).
Put a call on hold	Press (HOLD) . “HOLD” appears on the display. Press (HOLD) again or pick up the cordless handset from the charger (When Quick talk is set to “ON”; see page 40) to resume the conversation.
Switch to tone dialing temporarily	Press (*TONE) after you're connected. The line will remain in tone dialing until disconnected.
Switch to another call (“call waiting” service*)	Press (CALL WAITING/FLASH) . Press (CALL WAITING/FLASH) again to return to the first caller.

* You need to subscribe to this service from your telephone company.

Making calls (continued)

Notes

- When making a call on the cordless handset, “” appears on the display indicating the receiver sensitivity with the base phone. Three bars indicate a good reception, no bar indicates a bad reception. When calling from an area with poor reception, you may experience interference or the call may be disconnected, so try to use the cordless handset in areas that have a good reception.
- When you increase the sound volume, in some cases the back ground noise may be increased as well. You should adjust the volume accordingly.
- If the cordless handset beeps every second during a conversation and “” appears on the display, move closer to the base phone; otherwise, you will hear five short error beeps and “NO CONNECTION” will appear on the display, and the call will be disconnected after 30 seconds.
- While talking with an outside caller via the base phone, you cannot make a call with the cordless handset. If you press **(TALK)**, “NO CONNECTION” appears on the display and you will hear five short error beeps.
- When the talk time exceeds 9:59:59, the display counts from 0:00:00 again.

If the battery becomes weak during a call

The cordless handset will beep twice per second, “BATTERY LOW” appears on the display. Finish your call and replace the cordless handset on the charger to charge the battery pack.

For optimum performance, charge the battery for a full 12 hours.

Note that during the initial charge time (approx. 10 minutes), “PLEASE WAIT...” and “BATTERY LOW” appear on the display and the cordless handset cannot be used.

After “BATTERY LOW” turns off, you may be able to use the cordless handset, but the battery duration will be very short; thus it is recommended that you fully charge the battery before next use.

Making calls with the base phone

- 1 Pick up the handset or press **(SPEAKERPHONE)** on the base phone. "TALK" or "SPEAKERPHONE" appears on the display and the display also shows the talk time in hours, minutes and seconds.
- 2 Dial the phone number.
- 3 When you're done talking, replace the handset in the cradle or press **(SPEAKERPHONE)** again.

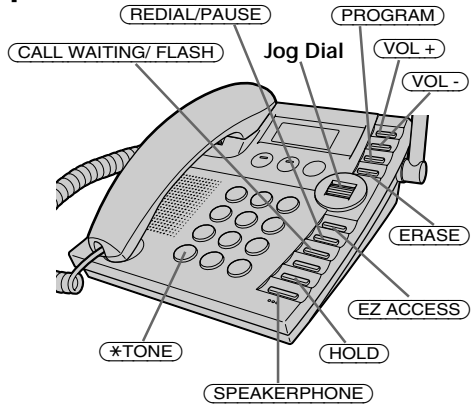

To make a call after checking the phone number

You can dial the phone number before picking up the handset or before pressing **(SPEAKERPHONE)**. If you make a mistake when dialing the phone number, press **(ERASE)** to erase the number.

Making calls using the EZ Access function

To set up the access number, see "Setting up the EZ Access function" on page 23.

- 1 Dial the phone number (e.g., 1-201-123-4567, or 011-...).
- 2 Press **(EZ ACCESS)**.

The system dials first, the access number set up with the EZ access function, and then the phone number you dialed in step 1. "SPEAKERPHONE" appears on the display.



- 3 When you're done talking, or press **(SPEAKERPHONE)** again.

Note

If you have set up a phone number with the EZ access function, just press **(EZ ACCESS)** to dial the phone number (i.e. skip step 1).

Making calls (continued)

Additional tasks

To	Do this
Adjust the handset or speakerphone volume	During phone conversation, press (VOL-) or (VOL+). There are 3 steps for the handset volume level, and 7 steps for the speakerphone volume level.
Put a call on hold	Press (HOLD). "HOLD" appears on the display. Press (HOLD), (SPEAKERPHONE), or pick up the handset from the base phone to resume the conversation.
Switch to tone dialing temporarily	Press (*TONE) after you're connected. The line will remain in tone dialing until disconnected.
Switch to another call ("call waiting" service*)	Press (CALL WAITING/FLASH). Press (CALL WAITING/FLASH) again to return to the first caller.

* You need to subscribe to the service from your telephone company.

Notes

- While talking with an outside caller via the cordless handset, the display on the base phone shows "HANDSET 1 IN USE" when the cordless handset with the station number "1" is in use, and you cannot make a call with the base phone.
- When the talk time exceeds 9:59:59, the display counts from 0:00:00 again.

Tip

You can switch between phone conversations via the handset and those via the speakerphone, simply by picking up the handset while talking over the speakerphone, or by pressing (SPEAKERPHONE) while talking over the handset.

To obtain the best speakerphone performance

- You may not be able to hear the other party's voice in a noisy place. Therefore, use the speakerphone in a quiet room.
- Do not bring your hand or other object too close to the microphone or you will hear a shrill noise ("feedback").
- When the speaker volume is loud, or the base phone has been placed close to a wall, you may find that the volume drops suddenly. This is due to a circuit in the telephone designed to protect against feedback. In such cases, lower the speaker volume slightly.

Redialing

Both the base phone and the cordless handset can each individually store five dialed phone numbers.

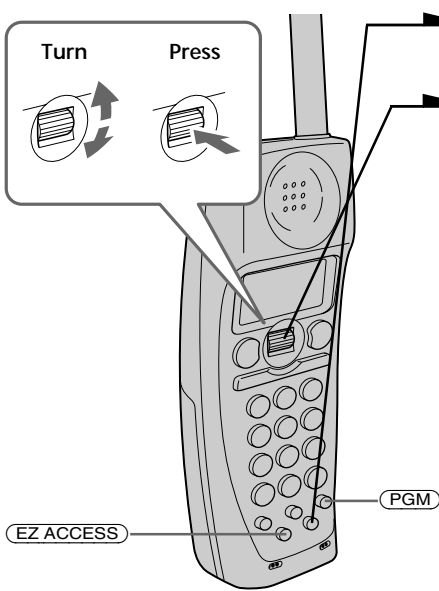

- 1 Press **REDIAL/PAUSE**.
- 2 Display the name or phone number you want to call by turning Jog Dial.
- 3 Press Jog Dial.
- 4 Turn Jog Dial to choose "DIAL", and then press Jog Dial.
The phone number will be redialed.

Notes

- The redial memory only registers up to 32 digits. Exceeding numbers will not be redialed.
- If an access number of the long distance call is registered in **EZ ACCESS**, the number cannot be stored for the redial button use. To redial long distance calls with **EZ ACCESS**, press **EZ ACCESS** instead of above steps 3 and 4.

Tips

- Although the phone number displayed on the redial list is up to 15 digit, the redialing will be successful.
- If you redial the same number repeatedly, this number will only be counted as one number of the total five registered numbers that can be redialed.
- When dialing from a phone number with a registered name, that name will be displayed in the list in step 2.

continued

Making calls (continued)

To erase the dialed phone number one by one

- 1 Display the name or phone number you want to erase by doing steps 1 to 3 on page 37.
- 2 Turn Jog Dial to choose “ERASE REDIAL”, and then press Jog Dial.
- 3 Turn Jog Dial to choose “YES”, and then press Jog Dial.
You hear a long confirmation beep, and the number is erased.

To erase the entire dialed phone numbers at once

- 1 Press **(PGM)**. (Press **(PROGRAM)** on the base phone.)
- 2 Turn Jog Dial to choose “MEMORY MANAGE”, and then press Jog Dial.
- 3 Turn Jog Dial to choose “ERASE ALL RDL”, and then press Jog Dial.
- 4 Turn Jog Dial to choose “ERASE REDIAL”, and then press Jog Dial.
You hear a long confirmation beep, and the entire number are erased.

To store the dialed phone number into the Phone Directory

See page 45.

Receiving calls

Receiving calls with the cordless handset

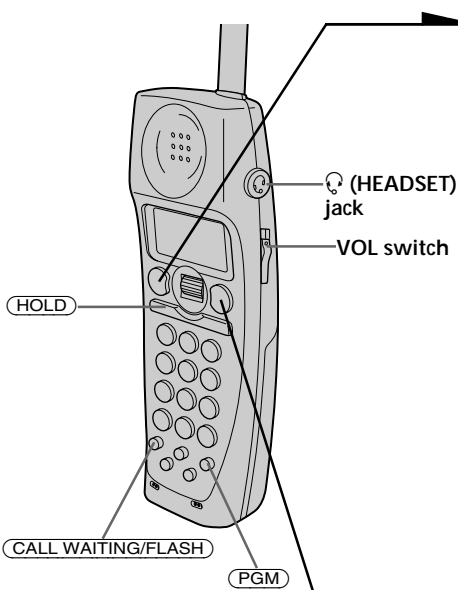

1 When you hear the phone ring:

- Press **TALK**.

or

- Pick up the cordless handset from the charger when the cordless handset is placed on the charger. (When Quick talk is set to "ON"; see page 40)

"TALK" appears on the display and the display also shows the talk time in hours, minutes and seconds.

"HANDSET 1 IN USE" appears on the display of the base phone when the cordless handset with the station number "1" is in use.

2 When you're done talking, press

- OFF** or replace the cordless handset on the charger.

The display turns off.

Receiving calls when the headset is connected

When a headset (optional) is connected to the (HEADSET) jack on the cordless handset, you can talk through the headset.

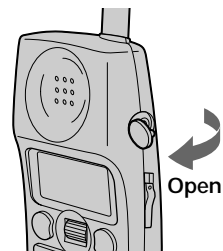

continued

Basics

39^{US}

Receiving calls (continued)

Additional tasks

To	Do this
Adjust the cordless handset volume	Set the VOL switch to H (high), M (middle) or L (low).
Put a call on hold	Press (HOLD) . "HOLD" appears on the display. Press (HOLD) again or pick up the cordless handset from the charger (When Quick talk is set to "ON"; see below) to resume the conversation.
Switch to another call ("call waiting" service*)	Press (CALL WAITING/FLASH) . Press (CALL WAITING/FLASH) again to return to the first caller.
Receive a call by only picking up the cordless handset from the charger, without pressing (TALK) (Quick talk)	Press (PGM) . Turn Jog Dial to choose "QUICK TALK", then press Jog Dial. Turn Jog Dial to choose "ON", then press Jog Dial.
Adjust the ringer volume of the cordless handset	While the cordless handset is ringing: Turn Jog Dial to adjust the volume. While the cordless handset is not in use: Press (PGM) . Turn Jog Dial to choose "RINGER VOLUME" then press Jog Dial to adjust the volume. Press (OFF) . The ringer volume can be adjusted to three different levels: high, low and off. If the ringer is set off, "RING OFF" will appear on the display.

* You need to subscribe to this service from your telephone company.

Tip

To inform you of an incoming call, the display shows "** RINGING **" even when you set the ringer volume on the cordless handset to off. You can still make calls, and also receive calls if another telephone connected to the same line rings to inform you of incoming calls. You can also receive an intercom call.

If you have subscribed to the Caller ID service;

- the caller's number and/or name appears on the display when you receive a call (see page 60) or when another call comes in by "call waiting" service.
- the name stored in the Phone Directory appears on the display if the call matches the number stored in the Phone Directory (memory match function; see page 60).
- the ringer sound changes to a higher tone if the call matches the number stored in the Phone Directory (memory match function; see page 60).

Receiving calls with the base phone

- 1 When you hear the phone ring, pick up the handset or press **(SPEAKERPHONE)** on the base phone.
“TALK” or “SPEAKERPHONE” appears on the display and the display also shows the talk time in hours, minutes and seconds.
- 2 When you're done talking, replace the handset in the cradle or press **(SPEAKERPHONE)** again.

To obtain the best speakerphone performance, see page 36.

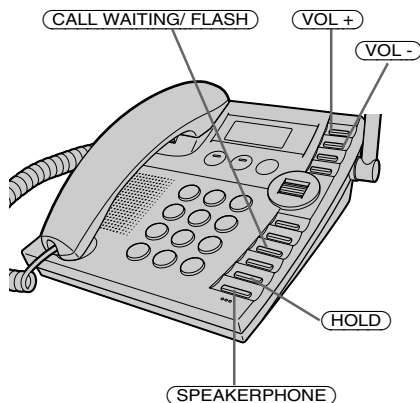

Additional tasks

To	Do this
Adjust the handset or speakerphone volume	During phone conversation, press (VOL +) or (VOL -) . There are 3 steps for the handset volume level, and 7 steps for the speakerphone volume level.
Put a call on hold	Press (HOLD) . “HOLD” appears on the display. Press (HOLD) , (SPEAKERPHONE) , or pick up the handset from the base phone to resume the conversation.
Switch to another call (“call waiting” service*)	Press (CALL WAITING/ FLASH) . Press (CALL WAITING/ FLASH) again to return to the first caller.
Adjust the ringer volume of the base phone	Press (VOL +) or (VOL -) . The ringer volume can be adjusted to three different levels: high, low, and off. If the ringer is set to off, “RING OFF” will appear on the display.

* You need to subscribe to the service from your telephone company.

continued

Receiving calls (continued)

Note

Even when you set the ringer volume on the base phone to off, the cordless handset will ring when the ringer volume on the cordless handset is set to high or low.

Tips

- To inform you of an incoming call, the display shows “** RINGING **” even when you set the ringer volume on the base phone to off.
- You can switch between phone conversations via the handset and those via the speakerphone, simply by picking up the handset while talking over the speakerphone, or by pressing **(SPEAKERPHONE)** while talking over the handset.

Phone Directory

You can dial a number by scrolling through the Phone Directory. Both the base phone and the cordless handset can each store up to 50 separate numbers.

Storing phone numbers and names

Example: to store "SONY" "123-4567".

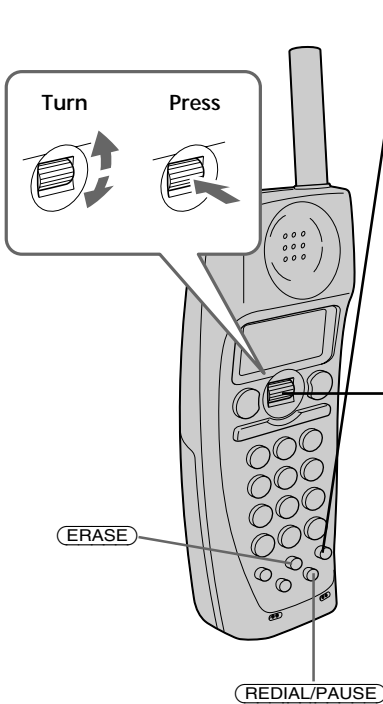

- 1** Press **PGM**. (Press **PROGRAM** on the base phone.)

```
(GO BACK)
▶PHONE DIRECTORY
↓MEMORY MANAGE
```

If "PHONE DIRECTORY" is not selected, turn Jog Dial to select it.

- 2** Press Jog Dial. "ENTER NAME" appears on the display.

```
ENTER NAME
↑ABCDEFGHIJKLMN↑
↓OPQRSTUVWXYZL←↓
```

- 3** Enter the name by turning Jog Dial.

You can enter up to 15 characters.

Turn Jog Dial until the desired character is selected, and then press Jog Dial.

continued

Phone Directory (continued)

Each press of Jog Dial after choosing “↑” or “↓” switches the characters from upper case letters → lower case letters → numbers and symbols.

Enter successive characters in the same way. To enter a “space”, turn Jog Dial to choose “ ” (space), and then press Jog Dial.

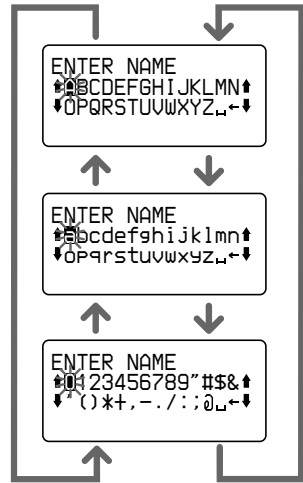

- 4** Press (PGM) (or (PROGRAM)).
“ENTER NUMBER” appears on the display.

```
SONY  
ENTER NUMBER
```

- 5** Enter the phone number by pressing the dialing keys.

You can enter up to 20 digits, including a tone and a pause, each of which is counted as one digit.

When the phone number of 16 digits or more has been entered, the phone number appears in two lines.

```
SONY  
1234567_
```

```
SONY  
1234567890123456  
78_
```

- 6** Press (PGM) (or (PROGRAM)).
You hear a long confirmation beep, and the name and the number are stored.
The display goes off.

Notes

- If you try to save a 51st phone number, you will hear five short error beeps and “THE MEMORY IS FULL” will be displayed. You cannot store the phone number. To store another phone number, erase one of the stored phone numbers (see page 49).
- Names cannot be entered using the dialing keys.
- Do not allow more than 60 seconds to elapse during the operation procedure.

Tips

- When you select “(GO BACK)”, you can return to the previous set display by pressing Jog Dial.
- If you have entered a wrong name or number in step 3 or 5, turn Jog Dial to choose “←” then press Jog Dial or press (ERASE) to erase it. Then enter the correct name or number.

To store a number to be dialed via Private Branch Exchange (PBX)

Before entering a phone number in step 5 on page 44, do as follows:

- 1 Enter the outside line access digit (e.g., 9).
- 2 Press (REDIAL/PAUSE).

To store the dialed phone number into the Phone Directory

The dialed phone numbers of up to 20 digits can be stored in the Phone Directory.

- 1 Press (REDIAL/PAUSE).
- 2 Display the name or phone number you want to call by turning Jog Dial, and then press Jog Dial.
- 3 Turn Jog Dial to choose “PROGRAM”, and then press Jog Dial.
- 4 Enter the name by doing steps 3 and 4 on pages 43 to 44.
- 5 Press (PGM). (Press (PROGRAM) on the base phone.)

You hear a long confirmation beep, and the name and the number are stored.

continued

Making calls from the Phone Directory

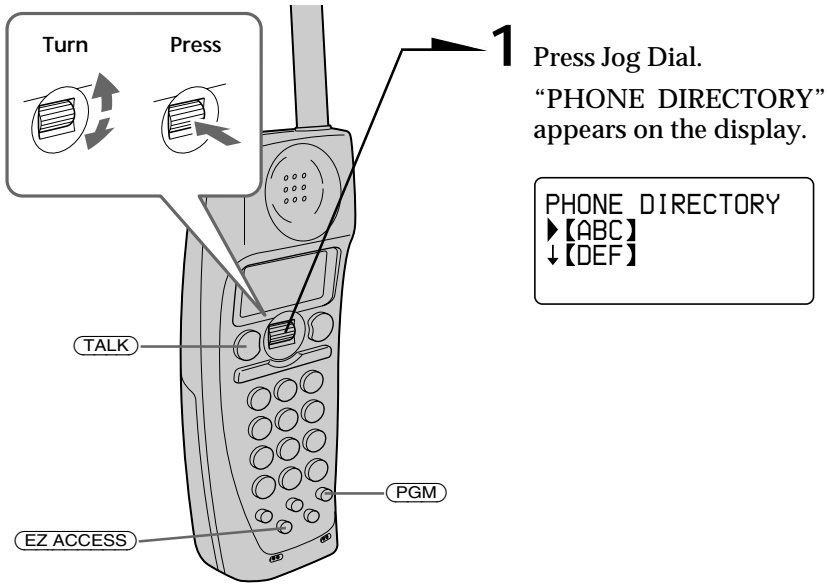

2 Turn Jog Dial to select an alphabet group ([ABC], [DEF]...) which includes the initial character of the name you want to search for, and then press Jog Dial.

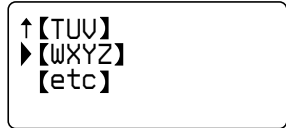

If a numbers or a symbol is the initial character, select the "[etc]" group.

3 Select the name you want to call by turning Jog Dial.

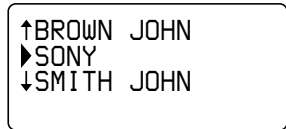

4 Press Jog Dial.

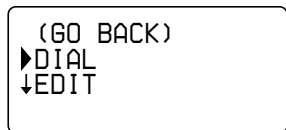

5 Turn Jog Dial to choose “DIAL”, and then press Jog Dial.

The phone number will be dialed.

Tips

- When you select “(GO BACK)”, you can return to the previous set display by pressing Jog Dial.
- If there is no data recorded in the selected alphabet group in step 2, the data memory of the next following group will be displayed.
- You may press (TALK) on the cordless handset (on the base phone, pick up the handset or press (SPEAKERPHONE)) to make a call instead of doing steps 4 and 5.
- If an access number of the long distance call is set up with the EZ access function, you can add the access number to the phone number and make a call by pressing (EZ ACCESS) after step 3. For setting up the EZ access function, see page 23.

Phone Directory (continued)

Changing a stored name and/or phone number

- 1 Display the name you want to change by doing steps 1 to 3 on page 46.

```
↑BROWN JOHN
▶SONY
↓SMITH JOHN
```

- 2 Press Jog Dial.

```
(GO BACK)
▶DIAL
↓EDIT
```

- 3 Turn Jog Dial to choose “EDIT”, and then press Jog Dial.
The cursor “_” is at the right of the name.

```
SONY_
▶BCDEFGHI JKLMN▶
↓OPQRSTUVWXYZ_←↔
```

- 4 Turn Jog Dial to choose “←”, then press Jog Dial or press (ERASE) to erase the characters, and enter the new name.
If you want to change only the number, skip this step.

- 5 Press (PGM). (Press (PROGRAM) on the base phone.)
The cursor is at the right of the phone number.

```
SONY
1234567_
```

- 6 Press (ERASE) to erase the number, and enter the new number.
If you don't want to change the number, skip this step.

- 7 Press (PGM) (or (PROGRAM)).
You hear a long confirmation beep and the name and/or the number is changed.

Erasing a memory location

To erase the phone number one by one

- 1 Display the name you want to erase by doing steps 1 to 3 on page 46.

```

↑BROWN JOHN
▶SONY
↓SMITH JOHN
  
```

- 2 Press Jog Dial.

```

(GO BACK)
▶DIAL
↓EDIT
  
```

- 3 Turn Jog Dial to choose “ERASE DIRECTORY”, and then press Jog Dial.

```

(GO BACK)
▶NO
  YES
  
```

- 4 Turn Jog Dial to choose “YES”, and then press Jog Dial.

You hear a long confirmation beep and the memory location is erased.

To erase the entire memory at once

- 1 Press **(PGM)**. (Press **(PROGRAM)** on the base phone.)

- 2 Turn Jog Dial to choose “MEMORY MANAGE”, and then press Jog Dial.

```

(GO BACK)
▶PHONE DIRECTORY
↓MEMORY MANAGE
  
```

- 3 Turn Jog Dial to choose “ERASE ALL DIR”, and then press Jog Dial.

```

(GO BACK)
▶NO
  ERASE DIRECTORY
  
```

- 4 Turn Jog Dial to choose “ERASE DIRECTORY”, and then press Jog Dial.

You hear a long confirmation beep and the entire memory is erased.

continued

Phone Directory (continued)

Transferring the Phone Directory memory

The Phone Directory memory can be transferred one by one or all at once (with a maximum of 50 numbers) from a cordless handset to the base phone or to an additional cordless handset, or from a base phone to one of the cordless handsets.

Make sure the base phone* is not in use before you start the setting.

* If the system includes additional cordless handsets, it is necessary to stop using them before you start the setting as well.

To transfer one phone number from the Phone Directory

1 Display the name you want to transfer by doing steps 1 to 3 on page 46.



```
↑BROWN JOHN
▶SONY
↓SMITH JOHN
```

2 Press Jog Dial.



```
(GO BACK)
▶DIAL
↓EDIT
```

3 Turn Jog Dial to choose “SEND DIRECTORY”, and then press Jog Dial.

4 When the system has one cordless handset

You hear a long confirmation beep and the memory is transferred.

When the system has an additional cordless handset

Turn Jog Dial to choose “TO BASE” or station number of the cordless handset to which you are forwarding the memory, and then press Jog Dial.

You hear a long confirmation beep and the memory is transferred.

(Cordless handset)



```
(GO BACK)
▶TO BASE
↓TO HANDSET 2
```

To transfer all phone numbers from the Phone Directory

The Phone Directory receiving the transfer will be totally overwritten.

1 Press **(PGM)**. (Press **(PROGRAM)** on the base phone.)

2 Turn Jog Dial to choose “MEMORY MANAGE”, and then press Jog Dial.

(GO BACK)
▶SEND ALL DIR
↓ERASE ALL CID

3 Press Jog Dial.

4 When the system has one cordless handset

Skip this step.

When the system has an additional cordless handset

(Cordless handset)

Turn Jog Dial to choose “TO BASE” or station number of the cordless handset to which you are forwarding the memory, and then press Jog Dial.

(GO BACK)
▶TO BASE
↓TO HANDSET 2

5 Turn Jog Dial to choose “SEND DIRECTORY”, and then press Jog Dial.

“SENDING...” appears on the display during the transfer.

You hear a long confirmation beep and the entire memory is transferred.

(GO BACK)
▶NO
SEND DIRECTORY

Notes

- If there are already 50 numbers stored in the Phone Directory receiving the transferred number one by one from the other Phone Directory, “RECEIVER’S MEMORY IS FULL” will appear on the display and five short error beeps will be heard to indicate that the transfer was unsuccessful. To make the transfer possible, erase one of the stored phone numbers existing in the Phone Directory (see page 49).
- If the transfer is unsuccessful, “ERROR” will appear on the display, and five short error beeps will be heard. Move the sending unit closer to the receiving unit, make sure the receiving unit is not in use, and then start over the procedure.
- To check the station number assigned to the cordless handset, see page 26.

Switching the phones during a call

You can easily switch between the cordless handset and the base phone, or between the cordless handsets without disconnecting the call.

Switching from the base phone to the cordless handset

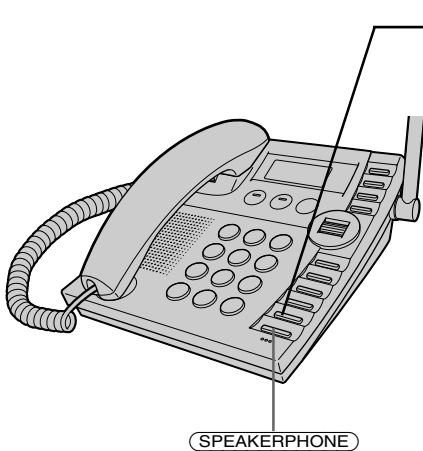

- 1** Press **(HOLD)** on the base phone.
The call is on hold and “HOLD” appears on the display.
- 2** Pick up the cordless handset from the charger (When Quick talk is set to “ON”; see page 40), or press **(TALK)** or **(HOLD)** on the cordless handset.
You can continue talking to the caller through the cordless handset.

Switching from the cordless handset to the base phone

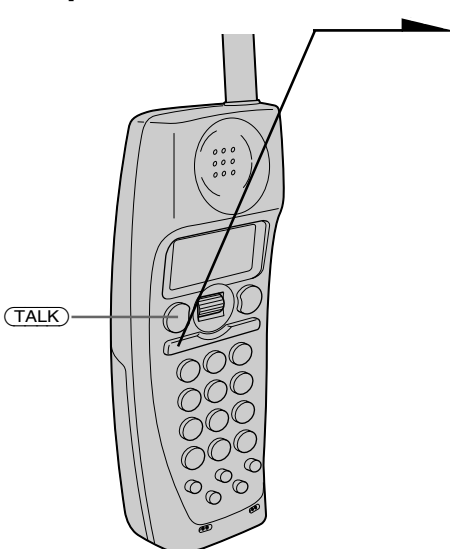

- 1** Press **(HOLD)** on the cordless handset.
The call is on hold and “HOLD” appears on the display.
- 2** Pick up the handset from the base phone, or press **(SPEAKERPHONE)** or **(HOLD)** on the base phone.
You can continue talking to the caller through the base phone.

Switching from the cordless handset to another cordless handset (When the system has an additional cordless handset)

- 1** Press **HOLD** on the cordless handset.
The call is on hold and “HOLD” appears on the display.
- 2** Pick up another cordless handset from the charger (When Quick talk is set to “ON”; see page 40), or press **TALK** or **HOLD** on the cordless handset.
You can continue talking to the caller through the cordless handset.

Talking between the phones – Intercom

You can make an intercom call between the cordless handset and base phone, or between the cordless handsets. You can start the intercom from any phone.

Talking from the cordless handset to the base phone

Example: Making intercom call from the cordless handset whose station number is 1 to the base phone.

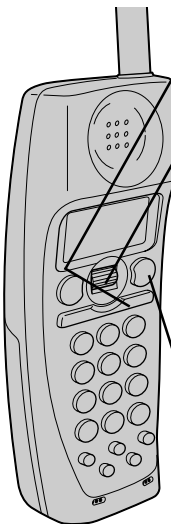

- 1** Press **INTERCOM**.
- 2** When the system has one cordless handset Skip this step.
When the system has an additional cordless handset Turn Jog Dial to choose “TO BASE”, and then press Jog Dial.
- 3** The cordless handset and base phone ring and “** INTERCOM 0 **” appears on the display of the cordless handset and “** INTERCOM 1 **” appears on the display of the base phone.
When a person at the base phone picks up the handset from the base phone, or presses **SPEAKERPHONE** or **INTERCOM**, you can talk with each other.
- 4** When you are done talking, replace the cordless handset on the charger or press **OFF** on the cordless handset.

If no one answers the phone

Press **INTERCOM** again.

Notes

- If there is an incoming call during intercom conversation between the base phone and the cordless handset, intercom call will be disconnected, and both the base phone and the cordless handset will ring.
- While talking with an outside caller via the base phone, you cannot make an intercom call. If you press **INTERCOM** on the cordless handset, “NO CONNECTION” appears on the display and you will hear five short error beeps.

Tip

You can receive an intercom call on the base phone even when the ringer volume on the base phone is set to off. The phone will ring at a low level.

Talking from the base phone to the cordless handset

Example: Making intercom call from the base phone to the cordless handset whose station number is 1.

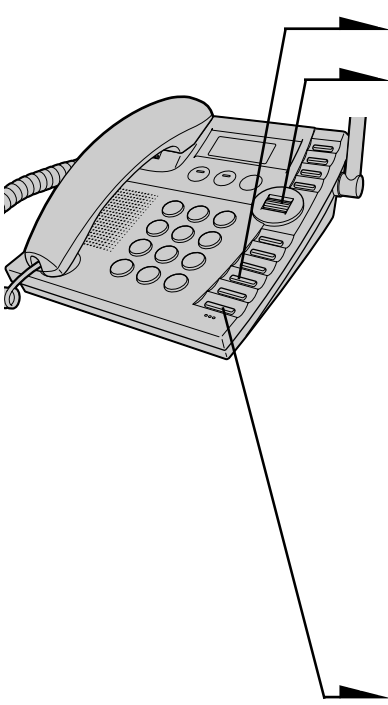

1 Press **INTERCOM**.

2 When the system has one cordless handset skip this step.

When the system has an additional cordless handset

Turn Jog Dial to choose “TO HANDSET 1”, and then press Jog Dial.

3 The base phone and cordless handset ring and “** INTERCOM 1 **” appears on the display of the base phone and “** INTERCOM 0 **” appears on the display of the cordless handset.

When a person at the cordless handset picks up the cordless handset from the charger (When Quick talk is set to “ON”; see page 40), or presses **TALK** or **INTERCOM**, you can talk with each other.

4 When you are done talking, replace the handset in the cradle or press **SPEAKERPHONE** on the base phone.

If no one answers the phone

Press **INTERCOM** again.

Notes

- If there is an incoming call during intercom conversation between the base phone and the cordless handset, intercom call will be disconnected, and both the base phone and the cordless handset will ring.
- While talking with an outside caller via the cordless handset, you cannot make an intercom call. If you press **INTERCOM** on the cordless handset, “NO CONNECTION” appears on the display and you will hear five short error beeps.

Tip

You can receive an intercom call on the cordless handset even when the ringer volume on the cordless handset is set to off. The phone will ring at a low level.

continued

Talking between the phones – Intercom (continued)

Talking between the cordless handsets – Walkie-Talkie function (When the system has an additional cordless handset)

You can make an intercom conversation between a couple of cordless handsets (Walkie-Talkie function) of the same phone system far from the base phone (e.g. use out of doors).

Example: Making intercom call from station number 1 to station number 2.

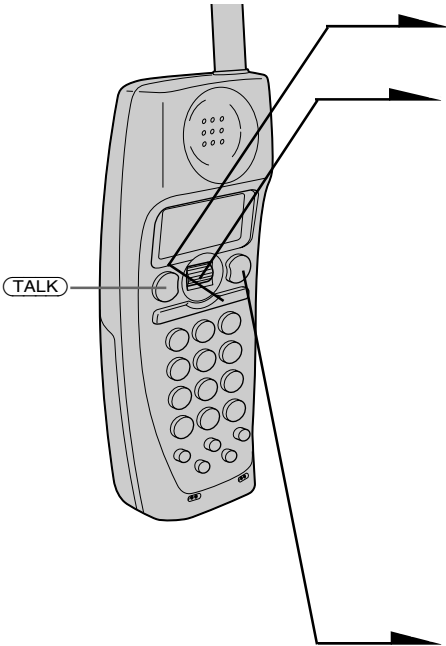

1 Press **INTERCOM**.

2 Turn Jog Dial to choose “TO HANDSET 2”, and then press Jog Dial.

Both cordless handsets ring and “** INTERCOM 2 **” appears on the display of the cordless handset whose station number is 1 and “** INTERCOM 1 **” appears on the display of the cordless handset whose station number is 2.

When a person at the cordless handset whose station number is 2 picks up the cordless handset from the charger (When Quick talk is set to “ON”; see page 40), or presses **TALK** or **INTERCOM**, you can talk with each other.

3 When you are done talking, replace the cordless handset on the charger or press **OFF**.

If no one answers the phone
Press **INTERCOM** again.

Notes

- If there is an incoming outer line call during the intercom conversation between a couple of cordless handsets (Walkie-Talkie function), intercom call will not be disconnected. When you answer the outer line call, press **OFF** to end the intercom conversation.
- To check the station number assigned to the cordless handset, see page 26.

Tip

You can receive an intercom call on the cordless handset even when the ringer volume is set to off. The cordless handset will ring at a low level.

Transferring a call

You can transfer a call between the cordless handset and base phone, or between the cordless handsets without disconnecting the call.

Transferring from the cordless handset to the base phone

Example: Transferring a call from the cordless handset whose station number is 1 to the base phone.

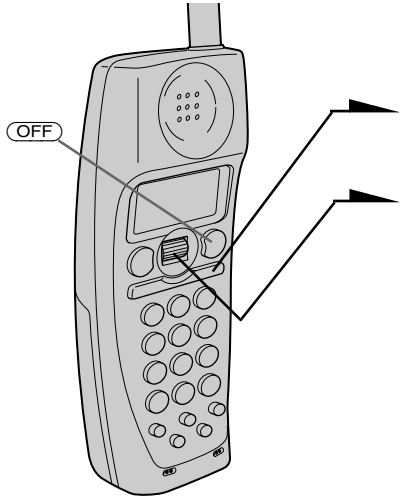

- 1** Press **INTERCOM**.
The call is put on hold.
- 2** When the system has one cordless handset
Skip this step.
When the system has an additional cordless handset
Turn Jog Dial to choose "TO BASE", and then press Jog Dial.

- 3** The cordless handset and base phone ring and "** INTERCOM 0 **" appears on the display of the cordless handset and "** INTERCOM 1 **" appears on the display of the base phone.

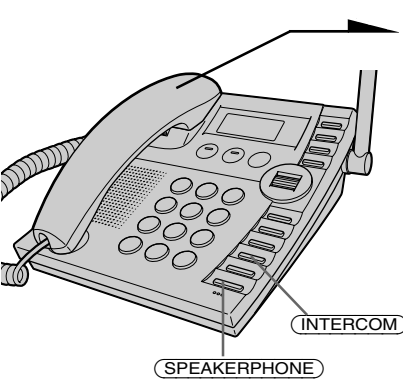

- 4** Pick up the handset from the base phone, or press **SPEAKERPHONE** or **INTERCOM** on the base phone.
You can talk between the cordless handset and the base phone.
- 5** To talk to the caller with the base phone, replace the cordless handset on the charger or press **OFF** on the cordless handset.
"TALK" or "SPEAKERPHONE" appears on the display of the base phone.

If no one answers the phone

Press **INTERCOM** again.

Tip

You can receive an intercom call on the base phone even when the ringer volume on the base phone is set to off. The base phone will ring at a low level.

Transferring a call (continued)

Transferring from the base phone to the cordless handset

Example: Transferring a call from the base phone to the cordless handset whose station number is 1.

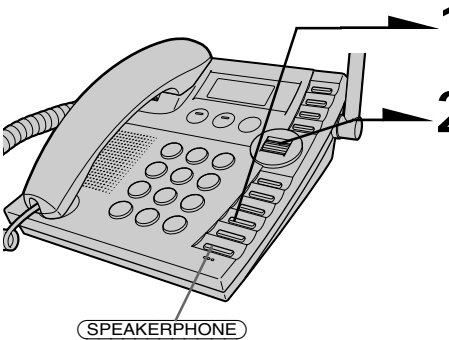

- 1** Press **INTERCOM**.
The call is put on hold.
- 2** When the system has one cordless handset
Skip this step.

When the system has an additional cordless handset
Turn Jog Dial to choose "TO HANDSET 1", and then press Jog Dial.

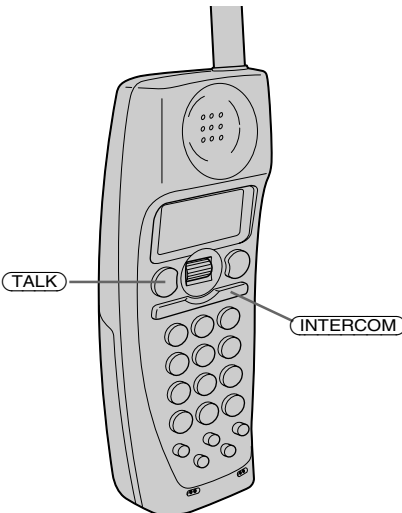

- 3** The base phone and cordless handset ring and
" ** INTERCOM 1 ** " appears on the display of the base phone and
" ** INTERCOM 0 ** " appears on the display of the cordless handset.
- 4** Pick up the cordless handset from the charger (When Quick talk is set to "ON"; see page 40), or press **TALK** or **INTERCOM** on the cordless handset.
You can talk between the base phone and the cordless handset.
- 5** To talk to the caller with the cordless handset, replace the handset in the cradle or press **SPEAKERPHONE** on the base phone.
"TALK" appears on the display of the cordless handset.

If no one answers the phone

Press **INTERCOM** again.

Tip

You can receive an intercom call on the cordless handset even when the ringer volume is set to off. The phone will ring at a low level.

Transferring between the cordless handsets (When the system has an additional cordless handset)

Example: Transferring a call from station number 1 to station number 2.

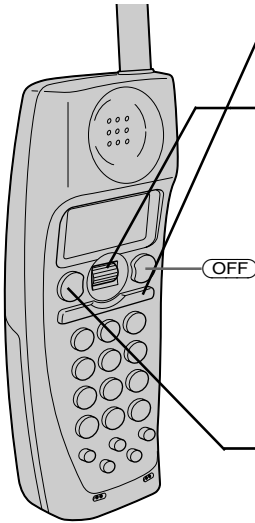

- 1 Press **INTERCOM**.
The call is put on hold.
- 2 Turn Jog Dial to choose "TO HANDSET 2", and then press Jog Dial.

Both cordless handsets ring and "** INTERCOM 2 **" appears on the display of the cordless handset whose station number is 1 and "** INTERCOM 1 **" appears on the display of the cordless handset whose station number is 2.

- 3 Pick up the cordless handset whose station number is 2 from the charger (When Quick talk is set to "ON"; see page 40), or press **TALK** or **INTERCOM** on the cordless handset.
You can talk with each other.

- 4 To talk to the caller with the cordless handset whose station number is 2, replace the cordless handset on the charger or press **OFF** on the cordless handset whose station number is 1.
"TALK" appears on the display of the cordless handset whose station number is 2.

If no one answers the phone

Press **INTERCOM** again.

Tip

You can receive an intercom call on the cordless handset even when the ringer volume is set to off. The cordless handset will ring at a low level.

Understanding the Caller ID service

Caller ID allows the caller's phone number to be shown on the display before you answer the call. In order to use this feature, you must first subscribe to Caller ID service. The name of this service may vary depending on your telephone company.

To use this feature, be sure to enter the area code (see page 17).

When you receive a call

The phone number appears on the display as shown in the following example.

If your Caller ID service includes the caller name service or if the phone number stored in the Phone Directory matches with the Caller ID data phone number, the caller's name also appears on the display (up to 15 letters).

The caller's name will appear by the name stored in the Phone Directory if you receive a call from a phone number which is stored in the Phone Directory.

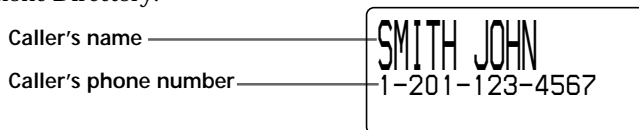

When you answer the call, the Caller ID display changes to the "TALK" or "SPEAKERPHONE" display.

Notes

- The caller's phone number and/or name will not appear in the following cases:
 - "UNKNOWN NUMBER/NAME/CALLER" (out of area) : when the call is made through a telephone company which does not offer Caller ID service (including international calls).
 - "BLOCKED NUMBER/NAME/CALL" (private) : when the call is "blocked". For privacy reasons, many states allow callers the option to prevent his or her telephone data from being displayed on the other party's Caller ID display.
- If the call is from an office which uses multiple lines, the displayed phone number may not match the number you use to call the extension.

About the memory match function

The name stored in the Phone Directory will appear on the display and the ringer sound will change to a higher tone from the second ring if you receive a call from a phone number which is stored in the Phone Directory on the base phone or the cordless handset (see page 43).

Note

The memory match function does not work with "UNKNOWN NUMBER/NAME/CALLER" or "BLOCKED NUMBER/NAME/CALL" calls; and it may not work with calls made from an office which uses multiple lines because the number does not always match the one you stored in this phone.

Looking at the Caller ID list

The phone stores the data of the last 70 calls received including “UNKNOWN NUMBER/NAME/CALLER” and “BLOCKED NUMBER/NAME/CALL” calls. It keeps track of all calls received; even if they were not answered.

Viewing the Caller ID list

You can look through the Caller ID list on both the base phone and the cordless handset to check the phone number and/or name of the calls received. If there is a “NEW” data, the NEW CALL lamp of the base phone flashes.

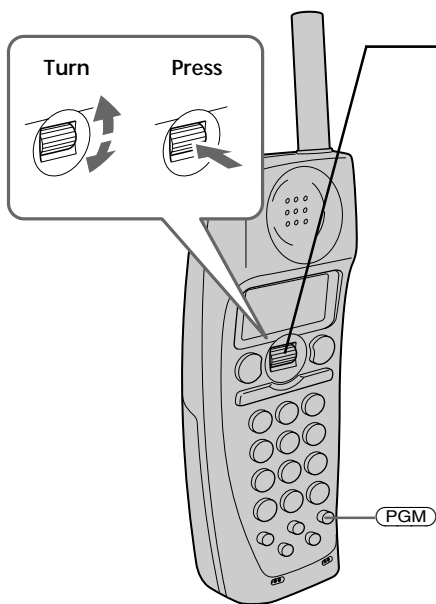

1 Turn Jog Dial.

The display shows the number of “NEW CALL” (calls which you have not viewed) and “OLD CALL” (calls which you have viewed) calls.

CALLER ID	
NEW CALL	08
OLD CALL	12

2 Turn Jog Dial down to display older data or up to display newer data.

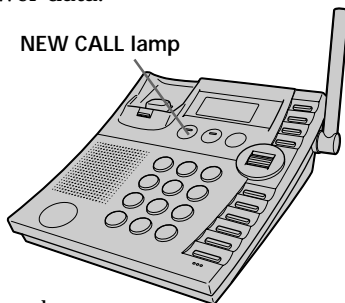

Notes

- If a 71st call is received, the oldest data is automatically erased.
- When you have checked all data, “END OF LIST” appears.

Tip

The number of “NEW CALL” can be confirmed with the standby mode display of the base phone.

continued

Looking at the Caller ID list (continued)

Erasing data from the Caller ID list

Old data will be erased automatically when a 71st call comes in, but you can also manually erase unnecessary data one by one or erase the entire list.

To erase the phone number one by one

- 1 Display the phone number you want to erase from the Caller ID list (see page 61).

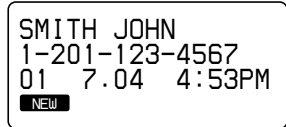

SMITH JOHN
1-201-123-4567
01 7.04 4:53PM
NEW

- 2 Press Jog Dial.

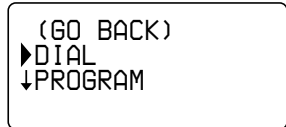

(GO BACK)
▶ DIAL
↓ PROGRAM

- 3 Turn Jog Dial to choose “ERASE CALLER ID”, and then press Jog Dial.

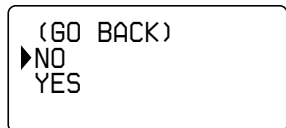

(GO BACK)
▶ NO
YES

- 4 Turn Jog Dial to choose “YES”, and then press Jog Dial.

You hear a long confirmation beep and the data is erased.

Note

Do not allow more than 60 seconds to elapse during the operation procedure.

Tip

When you select “(GO BACK)”, you can return to the previous set display by pressing Jog Dial.

To erase the entire list at once

Entire Caller ID list deletion can only be made on the cordless handset.

Note that Caller ID data in the list that has not been viewed will also be erased.

1 Press **(PGM)**.

2 Turn Jog Dial to choose “MEMORY MANAGE”, and then press Jog Dial.

```
(GO BACK)
▶SEND ALL DIR
↓ERASE ALL CID
```

3 Turn Jog Dial to choose “ERASE ALL CID”, and then press Jog Dial.

```
(GO BACK)
▶NO
ERASE CALLER ID
```

4 Turn Jog Dial to choose “ERASE CALLER ID”, and then press Jog Dial.

You hear a long confirmation beep and the entire list is erased.

Notes

- Do not allow more than 60 seconds to elapse during the operation procedure.
- When “ERROR” appears on the display and five short error beeps are heard after Jog Dial is pressed in step 4, move the cordless handset closer to the base phone, make sure the base phone is not in use, and then start over the procedure.

Tip

When you select “(GO BACK)”, you can return to the previous set display by pressing Jog Dial.

Using the Caller ID list

By using the Caller ID list, you can call back a phone number from the Caller ID list easily or store numbers from the Caller ID list into the Phone Directory.

Calling back a number from the Caller ID list

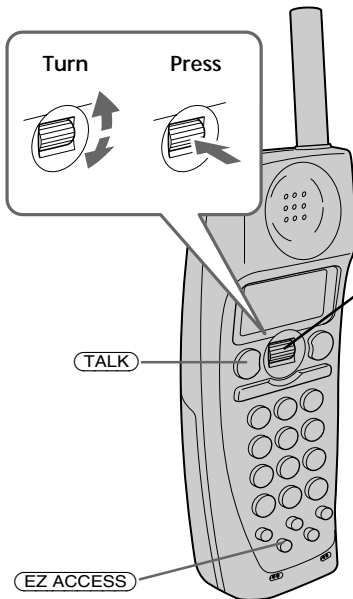

- 1 Display the phone number you want to call from the Caller ID list (see page 61).

```
SMITH JOHN
1-201-123-4567
01 7.04 4:53PM
NEW
```

- 2 Press Jog Dial.

```
(GO BACK)
▶DIAL
↓PROGRAM
```

- 3 Turn Jog Dial to choose "DIAL", and then press Jog Dial.

The phone automatically dials the displayed number.

Notes

- If the area code is not entered, "ENTER AREA CODE" will appear on the display, and you will not be able to call back. Enter the area code (see page 17).
- Do not allow more than 60 seconds to elapse during the operation procedure.
- If the number displayed in step 1 is not the one you should call back, you can change the number of digits of the phone number as described on page 66.
- If the phone is connected to a Private Branch Exchange (PBX), you may not be able to call back from the Caller ID list because an outside line access digit is necessary.

Tips

- You may press **(TALK)** on the cordless handset (on the base phone, pick up the handset or press **(SPEAKERPHONE)**) to make a call instead of doing steps 2 and 3.
- If an access number of the long distance call is set up with the EZ access function, you can add the access number to the phone number and make a call by pressing **(EZ ACCESS)** after step 3. For setting up the EZ access function, see page 23.
- When you select "(GO BACK)", you can return to the previous set display by pressing Jog Dial.

Storing a number of the Caller ID list into the Phone Directory

- 1** Display the name and phone number you want to store from the Caller ID list (see page 61).

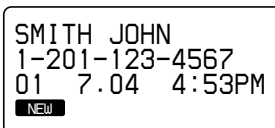

- 2** Confirm the number and press Jog Dial.

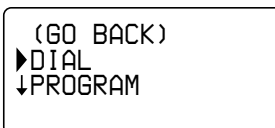

- 3** Turn Jog Dial to choose “PROGRAM”, and then press Jog Dial.

The cursor “_” is at the right of the name.

Enter or change the name, if necessary (see page 48).

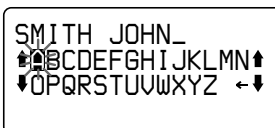

- 4** Press **PGM**. (Press **PROGRAM** on the base phone.)

The cursor is at the right of the phone number.

Enter or change the phone number, if necessary (see page 48).

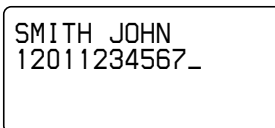

- 5** Press **PGM** (or **PROGRAM**).

You hear a long confirmation beep and the name and number are stored.

continued

Using the Caller ID list (continued)

Notes

- If the area code is not entered, "ENTER AREA CODE" will appear on the display, and you will not be able to store into the Phone Directory. Enter the area code (see page 17).
- Do not allow more than 60 seconds to elapse during the operation procedure.
- If the number displayed in step 1 is not the one you should store, you can change the number of digits of the phone number as described below.
- If the phone is connected to a Private Branch Exchange (PBX), you may need to add an outside line access digit.

Tip

When you select "(GO BACK)", you can return to the previous set display by pressing Jog Dial.

To change the number of digits of the phone number

If the number of digits of the phone number in the Caller ID list is different from the actual phone number, you need to adjust the number of digits of the phone number to call back or store into the Phone Directory.

- 1 While the phone number from the Caller ID list is displayed, press (#) repeatedly until the phone number with the correct number of digits appears on the display.

Each time you press (#), the number of digits changes as follows:

When the home area code and the local area code do not match

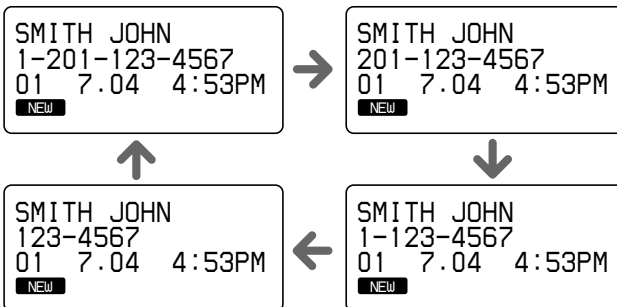

When the home area code matches

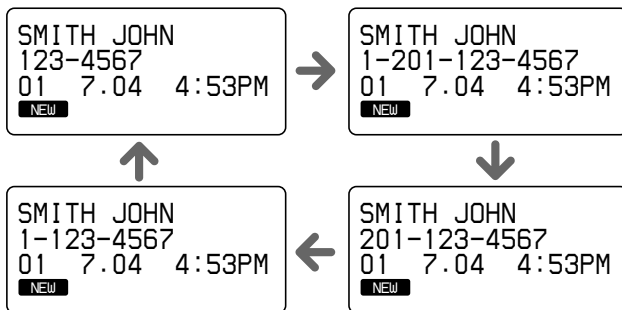

When the local area code matches

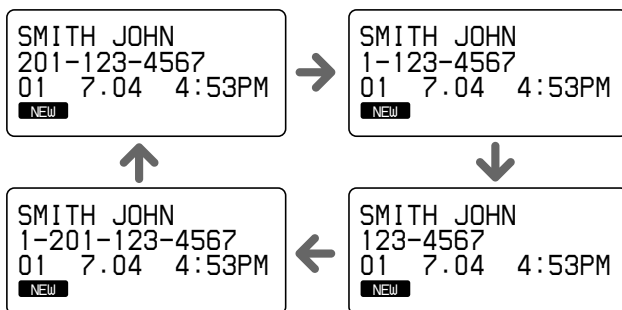

2 Continue the operation to call or store the phone number with the correct number of digits (pages 64 and 65).

Notes

- You need to adjust the number of digits each time you call back from the Caller ID list as the changes to the Caller ID data is not stored in memory.
- You may not be able to change the number of digits depending on the Caller ID data.

Using “Caller ID with call waiting” service

This telephone is compatible with the “Caller ID with call waiting” service. Make sure that your telephone company offers this service.

Like the basic Caller ID service, you need to subscribe to “Caller ID with call waiting” in order to use this service.

Even though you may have already subscribed to “Caller ID” and “call waiting” as two separate services, you need to request a subscription to “Caller ID with call waiting” as a single service.

This is a new service that combines the two services.

Even though you now have a “Caller ID with call waiting” compatible phone, unless you subscribe to the combined “Caller ID with call waiting” service, you will not be able to see the name and number of the second caller.

When a new call comes in while you are talking, the caller’s name and/or phone number of the new call appears on the display for about 20 seconds.

To switch to another caller

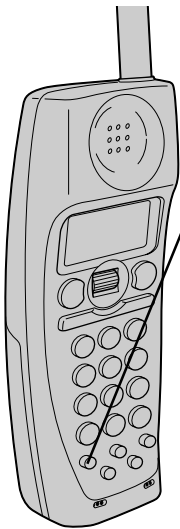

1 To switch to the new caller, press **CALL WAITING/FLASH**.

2 To switch back to the first caller, press **CALL WAITING/FLASH** again.

Using voice mail service

If you subscribe to your telephone company's message service which includes this feature, the display will show that you have messages waiting to be retrieved.

If you have messages



“MESSAGES WAITING” appears on the display on the cordless handset, and the VOICE MAIL lamp on the base phone flashes.

The display and the VOICE MAIL lamp go off when you retrieve your messages.

Note

You cannot use this feature, if you have not subscribed to your telephone company's message service. For details on the availability of this service, please ask your telephone company.

If the VOICE MAIL lamp remains flashing

If this lamp does not go off (e.g. When you retrieve your messages with other phones), you can go off the lamp manually.

To go off the VOICE MAIL lamp

- 1 Press **(PGM)** on the cordless handset.
- 2 Turn Jog Dial to choose “MESSAGE INDIC.”, and then press Jog Dial.
- 3 Press Jog Dial.

The VOICE MAIL lamp on the base phone goes off, and you hear a long confirmation beep.

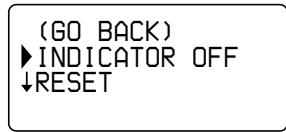

Using voice mail service (continued)

If you move or change your telephone company

Message waiting signals are sent in one of two ways: FSK signaling or “stutter” signaling (Your telephone company can provide you with more information about your service).

The first time this phone receives a voice mail message, it will set itself to the FSK service and will lock out the stutter service if your telephone company is in FSK service.

When you move or change your telephone company, you need to perform the following procedure. The phone will return to ready state for either FSK or stutter dial tone voice mail recognition.

To reset this phone

- 1 Perform step 1 and 2 on page 69.
- 2 Turn Jog Dial to choose “RESET”, and then press Jog Dial.

You hear a long confirmation beep and the phone is reset.



↑ INDICATOR OFF
▶ RESET

Mounting the base phone on a wall

1

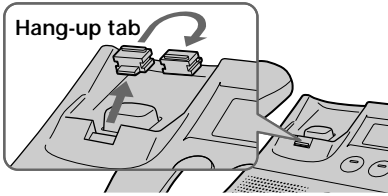

1

Reverse the hang-up tab.

2

Plug the telephone line cord to the LINE jack and the AC power adaptor to the DC IN 9V jack, and hook the cords. Use the shorter cord for mounting.

2

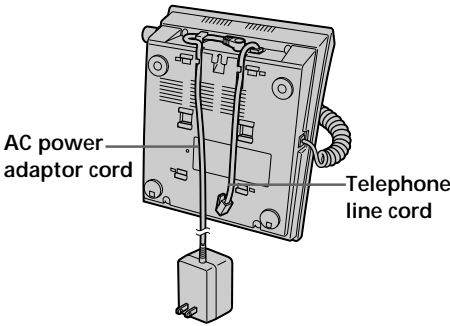

3

Attach the wall bracket to the center of the base phone.

Align the Δ marks of the wall bracket with those of the base phone.

3

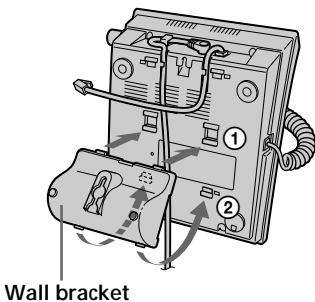

4

Plug the telephone line cord to the telephone outlet, and hook the base phone to the wall plate.

5

Plug the AC power adaptor to an AC outlet. Then raise the antenna so that it points towards the ceiling.

4, 5

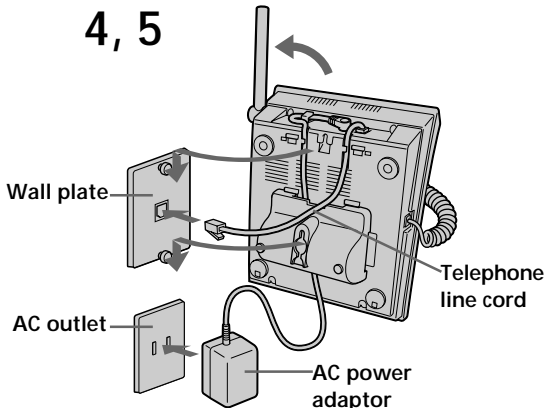

Tip

To remove the wall bracket, press the lower tabs.

Carrying the cordless handset by the belt clip

You can hang the cordless handset on the belt using the belt clip.

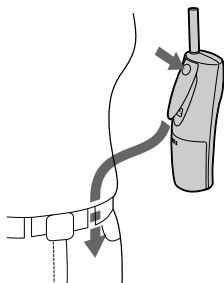

Open the belt clip of the cordless handset by pressing the top of it, and then attach the cordless handset to the belt.

Using the headset

You can talk on the cordless handset without using your hands by connecting a headset (optional) to the  (HEADSET) jack on the cordless handset.

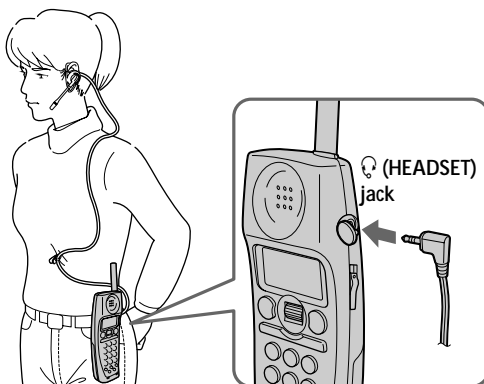

Notes on power sources

On battery pack

- Store the battery pack at a temperature between 41°F (5°C) and 95°F (35°C) for best performance.
- If you do not use the cordless handset for a long period of time, remove the battery pack after charging for more than 12 hours.

On power failure

During a power interruption, you cannot make or receive calls.

For the customers in the USA

RECYCLING NICKEL-CADMIUM BATTERIES

Nickel-Cadmium batteries are recyclable. You can help preserve our environment by returning your unwanted batteries to your nearest point for collection, recycling or proper disposal.



Note: In some areas the disposal of nickel-cadmium batteries in household or business trash may be prohibited.

RBRC (Rechargeable Battery Recycling Corporation) advises you about spent battery collection by the following phone number.

Call toll free number: 1-800-822-8837
(United States and Canada only)

Caution: Do not handle damaged or leaking nickel-cadmium batteries.

Maintenance

- Clean the cabinets with a soft cloth slightly moistened with water or a mild detergent solution. Do not use any type of abrasive pad, scouring powder or solvent such as alcohol or benzine as they may damage the finish of the cabinet.
- If the charge terminals of the charger and cordless handset are soiled, wipe them with a soft cloth.

If you have any questions or problems concerning your phone, please consult your nearest Sony dealer.

Troubleshooting

If you've experienced any of the following difficulties while using your phone, use this troubleshooting guide to help you remedy the problem. Should any problem persist, consult your nearest Sony dealer.

	Symptom	Remedy
General	The base phone does not operate properly.	<ul style="list-style-type: none"> Make sure the AC-T46 Sony AC power adaptor is connected to the base phone and an AC outlet. Do not use the AC-T127 Sony AC power adaptor with the base phone.
	You hear five short error beeps when you press (TALK) .	<ul style="list-style-type: none"> Make sure you have set up the base phone correctly (page 11). Move the cordless handset closer to the base phone. Make sure the base phone or another cordless handset is not making intercom call or outside call. Make sure another cordless handset is not checking the Caller ID list, etc.
Making calls	You hear no dial tone.	<ul style="list-style-type: none"> Make sure the telephone line cord is securely connected to the telephone outlet. Make sure the battery is fully charged (page 14).
	The phone does not connect at all, even though the number you dial is correct.	<ul style="list-style-type: none"> Make sure the dialing mode is set correctly (page 16).
	The phone does not redial correctly.	<ul style="list-style-type: none"> Make sure the dialed number is really the one you want to dial.
	You cannot hear anything from the speakerphone.	<ul style="list-style-type: none"> During phone conversation, press (VOL +) on the base phone to increase the speakerphone volume.
	Even by pressing (EZ ACCESS) , the desired call is not being made.	<ul style="list-style-type: none"> Make sure that the registered call number is correct.
Receiving calls	The cordless handset does not ring.	<ul style="list-style-type: none"> Set the ringer volume on the cordless handset to high or low. (page 40, 41) The battery may be weak. Charge the battery for more than 12 hours (page 14). Make sure you have set up the base phone correctly (page 11). Move the cordless handset closer to the base phone, and confirm a dial tone is heard by pressing (TALK) on the cordless handset.
	The base phone does not ring.	<ul style="list-style-type: none"> Press (VOL +) on the base phone to increase the ringer volume. Make sure the telephone line cord is securely connected to the telephone outlet.

Troubleshooting (continued)

	Symptom	Remedy
During conversation	You hear interference during conversation.	<ul style="list-style-type: none"> • Move the cordless handset closer to the base phone. • Place the base phone away from noise sources (page 11). • Place the base phone so that the antenna keeps away from metal products.
	You hear a beep every second during a conversation and “F” appears on the display.	<ul style="list-style-type: none"> • This is the out-of-range alarm. Move the cordless handset closer to the base phone within 30 seconds.
	You hear a beep twice per second and “BATTERY LOW” appears on the display.	<ul style="list-style-type: none"> • The battery is weak. Charge the battery for more than 12 hours (page 14).
Intercom	The cordless handset does not ring when you use the intercom from the base phone or an additional cordless handset, and the base phone does not ring when you use the intercom from the cordless handset.	<ul style="list-style-type: none"> • The battery may be weak. Charge the battery for more than 12 hours (page 14). • Move the cordless handset closer to the base phone. • Place the base phone away from noise sources (page 11). • Make sure a station number is assigned on the additional cordless handset. • Make sure another cordless handset or base phone is not in use.
	When pressing INTERCOM on the cordless handset, you hear five short error beeps and cannot make an intercom call.	<ul style="list-style-type: none"> • The base phone is being used to converse with an outside caller. • Move the cordless handset close to the base phone.
	You cannot make an Intercom conversation between a couple of cordless handsets (Walkie-Talkie function).	<ul style="list-style-type: none"> • Register the additional cordless handset to the base phone (page 25). • Move the cordless handsets closer to each other. • Check the battery. If the battery becomes weak, charge it.
Additional cordless handset	You cannot assign a station number on the additional cordless handset.	<ul style="list-style-type: none"> • Make sure the system ID is correct. • Make sure the cordless handset is fully charged (page 14). • Make sure all the cordless handset is placed close to the base phone. • Make sure the handset is placed in the cradle of the base phone.
	You do not know the station number of the cordless handset.	<ul style="list-style-type: none"> • Place the cordless handset on the charger. The station number of the cordless handset appears on the display. • Attach the supplied station number sticker on the cordless handset for remembrance' sake.

	Symptom	Remedy
Caller ID	The caller's name and/or phone number does not appear on the display.	<ul style="list-style-type: none"> • Make sure you have subscribed to Caller ID service. • Caller ID service may not work when the phone is connected to a Private Branch Exchange (PBX). • The call is made through company which does not offer Caller ID service. "UNKNOWN NUMBER/NAME/CALLER" will appear on the display. • The call was "blocked." "BLOCKED NUMBER/NAME/CALL" will appear on the display. • You have answered the call while "** RINGING **" was displayed. Please answer the call after the second ringer sound.
	The caller's name and/or phone number does not appear on the display during call waiting.	<ul style="list-style-type: none"> • Make sure you have subscribed to "Caller ID with call waiting" service (page 68). • Make sure nobody is talking with another phone on the same telephone line.
	You cannot dial the number from the Caller ID list.	<ul style="list-style-type: none"> • Make sure you entered your area code correctly (page 17). • You may need to change the number of digits of the phone number (page 66). • This function may not work when the phone is connected to a Private Branch Exchange (PBX).
	The memory match function does not work.	<ul style="list-style-type: none"> • If the call is from an office which uses multiple lines, the phone number may not match the number you put in the memory. • If you have stored phone number with an outside line access digit in the Phone Directory because the phone is connected to a Private Branch Exchange (PBX), the phone number will not match the Caller ID data. • If you have stored phone number of less than 7 digits in the Phone Directory, the phone number will not match the Caller ID data.
Voice mail	You cannot use voice mail service.	<ul style="list-style-type: none"> • Make sure you have subscribed to voice mail service. • If you move or change your telephone company, reset this phone.

Troubleshooting (continued)

	Symptom	Remedy
Power source/battery	The CHARGE lamp on the charger does not light up when you place the cordless handset to charge.	<ul style="list-style-type: none">• Wipe the charge terminals of the charger and the cordless handset with a soft cloth for better contact of the charge terminals.• Make sure the cordless handset is placed on the charger properly.• Make sure the cordless handset is placed on the charger with front side facing forward.• Use only the supplied AC-T127 AC power adaptor.
	The battery duration is short.	<ul style="list-style-type: none">• The battery pack was charged less than 12 hours (due to power failure, etc.).• The usage life of the battery has expired and needs replacement.• Use only the supplied AC-T127 AC power adaptor.

Note

Should any problems persist, press RESET on the bottom of the base phone with the tip of a toothpick or some other sharp instrument. This has no effect on the memory in the base phone and handset.

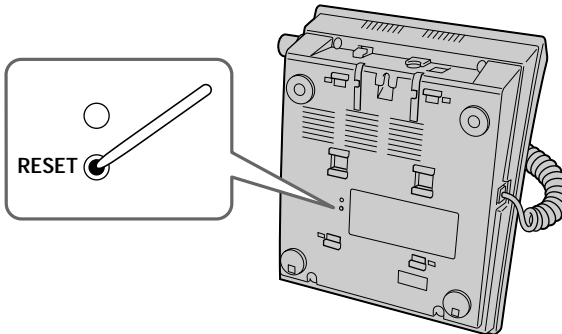

Specifications

General

- Spread method
 - Direct-Sequence Spread-Spectrum
- Access method
 - FDMA-TDD
- Frequency band
 - 2.4075 - 2.4720 GHz
- Operating channel
 - 40 channels
- Dial signal
 - Tone, 10 PPS (pulse) selectable
- Supplied accessories
 - See page 10.

Cordless handset

- Power source
 - Rechargeable battery pack BP-T38
- Battery life
 - Standby: Approx. 6 days
 - Talk: Approx. 5 hours
- Battery charging time
 - Approx. 12 hours
- Dimensions
 - Approx. 2 $\frac{3}{8}$ x 6 $\frac{5}{8}$ x 1 $\frac{15}{16}$ inches (w/h/d), antenna excluded (approx. 58 x 166 x 48 mm)
 - Antenna: Approx. 2 $\frac{7}{8}$ inches (approx. 72 mm)
- Mass
 - Approx. 8.1 oz (approx. 230 g), battery included

Base phone

- Power source
 - DC 9V from AC power adaptor AC-T46
- Dimensions
 - Approx. 7 $\frac{3}{8}$ x 3 $\frac{3}{4}$ x 8 $\frac{1}{8}$ inches (w/h/d), antenna excluded (approx. 187 x 93 x 206 mm)
 - Antenna: Approx. 4 $\frac{3}{8}$ inches (approx. 108 mm)
- Mass
 - Approx. 1 lb 8 oz (approx. 680 g), wall bracket excluded

Charger

- Power source
 - DC 9V from AC power adaptor AC-T127
- Dimensions
 - Approx. 3 $\frac{1}{4}$ x 2 $\frac{5}{8}$ x 4 $\frac{1}{8}$ inches (w/h/d) (approx. 80 x 64 x 102 mm)
- Mass
 - Approx. 2.7 oz (approx. 75 g)

Design and specifications are subject to change without notice.

Index

A

- Adjusting volume
 - cordless handset volume 33, 40
 - handset volume 36, 41
 - ringer volume 40, 41
 - speakerphone volume 36, 41
- Area code 17

B

- Battery pack
 - charging 14
 - duration 15
- BLOCKED NUMBER/
NAME/CALL 60

C

- Call waiting service 33, 40
- Caller ID 60
 - Caller ID list 61
 - calling back 64
 - memory match function 60
 - storing in Phone Directory 65
- Caller ID with call waiting 68
- Carrying the cordless handset by the belt clip 72
- Connection 12

D

- Day and time 21
- Dialing mode
 - choosing 16
 - switching to the tone temporarily 33
- Directory
 - Phone Directory 43

E, F, G

- Erasing
 - Caller ID data 62
 - phone numbers dialed 38
 - Phone Directory 49
- EZ Access function 23, 33

H

- Headset 33, 39, 72
- Hold 33, 40
- Home area code 17

I, J, K

- Identifying the parts 28
- Intercom 54

L

- Language of the display 27
- Local area code 19
- Location, base phone 11

M

- Making calls 32
- Memory match function 60
- Mounting the base phone on a wall 71

N, O

- NEW CALL 61
- NO CONNECTION 32

P, Q

- Package contents 10
- Phone Directory 43
- Pulse dialing 16

R

- Receiving calls 39
- Redialing 37
- Registering additional cordless handsets 25

S

- Setting up
 - base phone 11
 - cordless handset 14
- Speakerphone 36
- Storing Caller ID list into Phone Directory 65
- Switching phones during a call 52

T

Talking between the phones 54

Tone dialing
dialing mode 16
switching to 33

Transferring a call 57

Troubleshooting 75

U

UNKNOWN NUMBER/
NAME/CALLER 60

V

VOICE MAIL 69

Volume

cordless handset 33, 40

handset 36, 41

ringer 40, 41

speakerphone 36, 41

W, X, Y, Z

Walkie-Talkie function 56

For the customers in the USA

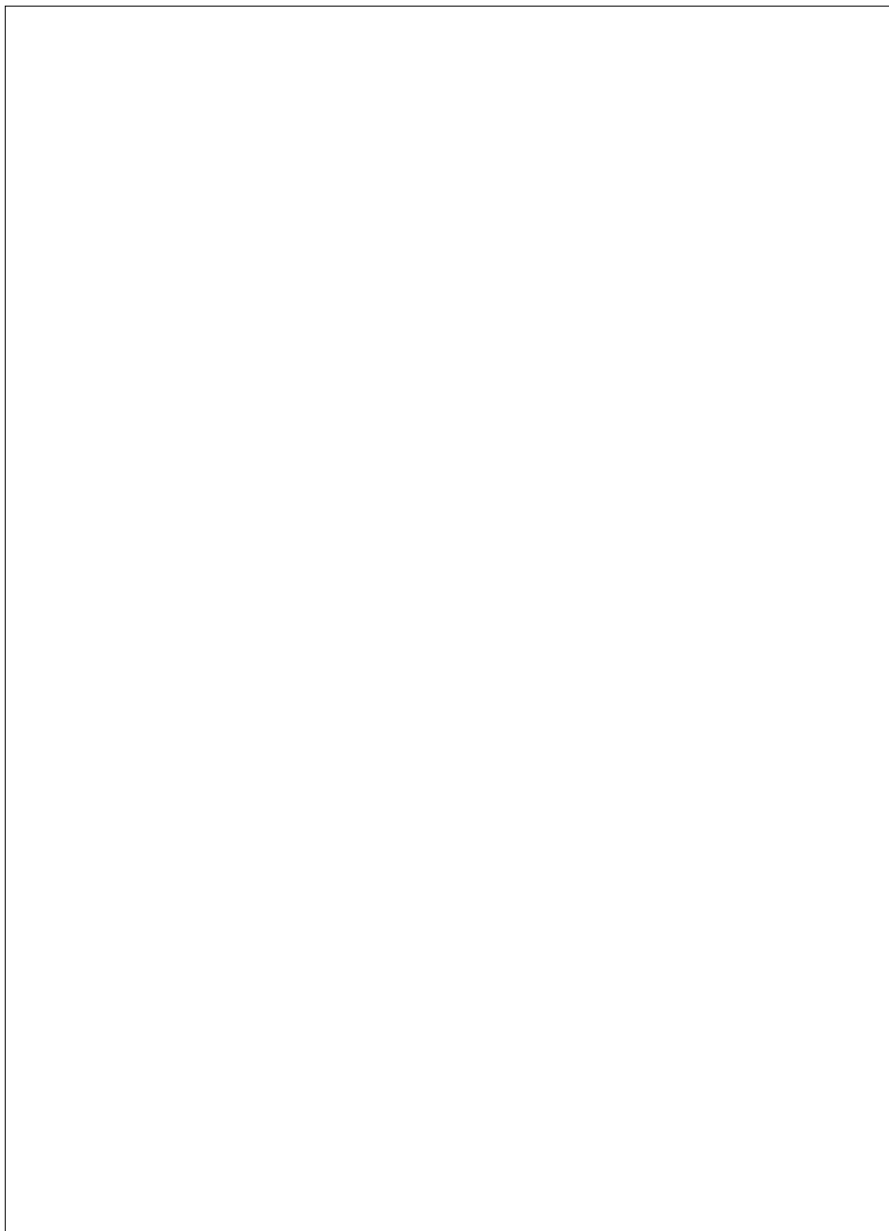

Be sure to save the receipt and attach it to your WARRANTY card when having your equipment repaired at an authorized Sony service center.

For online product registration, please contact
www.sony.com/productregistration

Sony Corporation Printed in Taiwan, R.O.C.

Download from Www.Somanuals.com. All Manuals Search And Download.

Free Manuals Download Website

<http://myh66.com>

<http://usermanuals.us>

<http://www.somanuals.com>

<http://www.4manuals.cc>

<http://www.manual-lib.com>

<http://www.404manual.com>

<http://www.luxmanual.com>

<http://aubethermostatmanual.com>

Golf course search by state

<http://golfingnear.com>

Email search by domain

<http://emailbydomain.com>

Auto manuals search

<http://auto.somanuals.com>

TV manuals search

<http://tv.somanuals.com>