

# *up to* **DVD**ate?

**MANUAL – DVD ROM & DVD VIDEO** 



**PRESS HERE!**

**Sony DADC**

*The objective of this manual is to facilitate the correct preparation of input components for DVD productions with Sony DADC. Similar manuals are available for our other products including CD-Audio, CD-ROM, MiniDisc and PlayStation Disc. These manuals can also be downloaded from our website at [www.sonydadc.com](http://www.sonydadc.com).*

*Keeping in compliance with the specifications in this manual will avoid confusion and unnecessary modifications.*

*Rework may extend production time causing considerable delays. Therefore, we kindly ask you to provide these specifications to the staff in charge with the preparation work, in particular external video, sound, graphics and other premastering studios.*

*As the final product will depend on the quality of the input components supplied, the adherence to the manual specifications represents an essential contribution to the total quality of the product and service that we provide to you as our customer.*



## **Introduction**

*Generally, all Sony DADC prices and schedules given, are based on the assumption that the input components provided by the customer meet the manual specifications.*

*If components do not meet the outlined specifications, they will be either returned or improved based on the customer's request.*

*Consequently additional expenses and charges will apply.*

*Prices for DVDs and special services (e.g. carrier, editing, film exposure, film generation etc.) are provided in our current price list.*

***For further information please contact us directly at:***

***+43/(0)6246/880-504***

***or visit our homepage –***

***[www.sonydvd.biz](http://www.sonydvd.biz)***

***[www.press-here.net](http://www.press-here.net)***

## ***Introduction***



**PRESS HERE!**



# Table of Contents

From CD to DVD	06
<b>1. General and Technology</b>	08
1.1 General and Technology	08
1.2 DVD 5	09
1.3 DVD 9	09
1.4 DVD 10	10
1.5 DVD 18	11
1.6 Mini DVD	11
1.7 ColourDVD	12
1.8 SniffleDVD	12
<b>2. DVD-Video</b>	13
2.1 General	13
2.2 Input media for DVD-Video	13
2.3 Details on DVD Authoring Possibilities	13
2.3.1 Video	13
2.3.2 Audio	13
2.3.3 Subpictures	13
2.3.4 Subtitles	14
2.3.5 Still Pictures	14
2.3.6 Regional Coding	14
2.3.7 Multibranching	14
2.3.8 Parental Lock	14
2.3.9 Multiangle	14
2.3.10 Aspect Ratio	14
2.3.12 Seperate audio masters, digital multichannel audio program	15
2.3.12.1 General	15
2.3.12.2 Backgrounds	15
2.3.12.3 Image Size	15
2.3.13 Safe Area	16
2.3.14 Colour Depth	16
2.3.15 Interlacing (Flicker/Jitter)	17
2.3.16 File Format	17
2.3.17 Naming Convention	17
2.3.18 Registration and Alignment	17
2.3.19 Image Size	17
2.3.20 Colour Depth	18
2.3.21 User interface and Delivery	18
2.3.21.1 Printouts	18
2.3.21.2 Navigation	18
2.3.21.3 Media	18
<b>3. DVD-Rom</b>	19
3.1 Data Preparation	19
3.2 Formatting	19
3.3 Input Media	19
<b>4. Labelprinting</b>	21
4.1 Printing Process	21
4.2 Printing Areas	21
4.3 Label Film Dimensions	21
4.4 Film Specifications for Label Print	26
4.4.1 Line widths and letter sizes	26
4.4.2 Registration marks for screen printing	26
4.4.3 Density	27
4.4.4 Print	27
4.4.4.1 Duplex/Triplex print (half-tone print) with Pantone Colours	27
4.4.4.2 Four-colour print – Picture Disc	27
4.4.4.3 Four-colour print – High Definition Picture Disc	27
4.5 Standard Contents	28
4.5.1 Catalogue number	28
4.5.2 DVD logo	28
4.5.3 "Made in EU"	28
4.5.4 Side Indication	28
4.5.5 Company address, label address	28
4.5 Colours	28
4.7 Label Film Data via Electronic Storage Media	29
4.8 Label Film Data via Electronic Data Transfer	29
4.9 Production of Label Film	30
4.10 Disc Serialisation	31
<b>5. Services</b>	32
5.1 Printing Process	32
5.2 Physical Films	32
5.3 Digital Films	32
5.3.1 Data Sources	32
5.3.2 Customer Input Server	33
5.3.3 FTP Software Tools	33
5.3.4 ISDN	33
5.3.5 Regular Post	33
5.4 Important Points	33
5.4.1 Software	33
5.4.2 Files	34
5.4.3 Fonts	34
5.4.4 Images/Illustrations	34
5.4.5 Colours	35
5.4.6 Templates	35
5.4.7 Overview of the most common problems	35
5.4.8 Tipp	36
5.5 Packaching Specifications	36
Digipak Index	44
Stickers	45
Packaging of supplied printwork	48
Packaging of supplied printwork	48
<b>6. Order Forms</b>	50

# WHAT'S NEW

## From CD to DVD

DVD, which stands for Digital Versatile Disc, is the next generation of optical disc storage technology. It is essentially an optical disc that can hold video as well as audio and computer data. This new optical disc can reach a capacity of up to 24 times the capacity of a CD-ROM and encompasses pre-recorded read only discs like DVD-Video, DVD-ROM, DVD-Audio, SACD as well as recordable formats like DVD-R, DVD-RAM, DVD+RW and DVD-R/W.

For movie applications, a DVD can store full length movies in a high-quality digital video with surround sound in several languages and a wide range of interactivity as well as subtitles. All DVD players and DVD-ROM drives are equipped with an additional laser diode or a special lens for playback capability of existing Audio CDs and CD-ROMs.

### Format and Specifications

The DVD standard defines a disc that maintains the overall dimensions of the current Compact Disc. Therefore the backwards compatibility with existing Audio CDs and CD-ROMs was easier to realize. The table on the right demonstrates similarities and differences of CD and DVD.

## DVD Types and Formats

A DVD consists of two halves, where each half disc is 0.6 mm thick, holding one or two layers of information. The DVD format provides multiple configurations of data layers. Each layer provides additional data capacity.

Disc Type		Capacity 12 cm
DVD-5	single sided, single layer	4.7 GB
DVD-9	single sided, dual layer	8.5 GB
DVD-10	double sided, single layer	9.4 GB
DVD-18	double sided, dual layer	17.1 GB



	Mini DVD	DVD
Disc diameter	80 mm	120 mm
Disc thickness	1.2 mm	1.2 mm
Disc structure	two bonded 0.6 mm substrates	two bonded 0.6 mm substrates
Laser wavelength	650/635 nm	650/635 nm
Numerical aperture	0.6	0.6
Track pitch	0.74 $\mu$ m	0.74 $\mu$ m
Shortest pit/land length	0.4 $\mu$ m	0.4 $\mu$ m
Data layers	up to 2	up to 4
Data capacity	1.46 GB–2.66 GB	4.7 GB–17.1 GB



# Services

*Statistical process controls and in-line inspection systems form a key part of our production process. Full 100% checks by means of automatic test systems of label print and read-out sides are implemented with the strictest error criteria. A team of highly qualified staff as well as auxiliary means such as optoelectronic test devices, an electron microscope with X-ray spectroscopy, an atomic force microscope and climatic chambers are available for permanent process control and improvement, systematic error analysis and also for maintaining the durability of our products.*

*The processes and procedures are certified according to ISO-9002. Sony DADC has qualified for this certification after successfully proving a 6-sigma quality.*

*We will be pleased to assist you in finding the solution for your technical problems. If you are interested in an electronic link for transmitting your master data and other components to Sony DADC, we can offer our know-how and our expertise and will reserve storage capacity for your data on our servers. If you need further services, please inform our Customer Service department so that we can assist you in the realisation of your project.*

## **Our services comprise the following:**

- Personal assistance by a member of our Customer Service staff
- Authoring of DVD Video/Audio within Sony Group (by Sony DVD Center Europe)
- Premastering / formatting of DVD-ROM
- Premastering / formatting of all common DVD formats
- On-line data transfer via 2Mbit ISDN
- Disc prototyping on DVD-R
- Mastering of all DVD formats
- DVD 5 / 9 / 10 disc production in shortest turnaround times
- Offset label printing on discs
- Support in artwork creation
- Disc serialisation
- Packaging / dispatching
- Drop shipment

# 1. General and Technology

## 1.1 General and Technology

The Digital Versatile Disc (DVD) is the logical successor of the Compact Disc (CD). Moreover, due to the high data storage capacity this disc has also become the data medium for the film-industry. It has been developed throughout the nineties, but is only now coming into prominence. In spite of the DVD having a much higher data storage capacity (between 7 and 24 times) than the CD, both look the same. The main difference between DVD and CD consists of the shorter wavelength of the laser light, which reads the information.

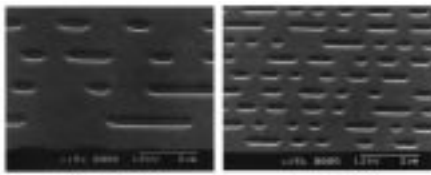

The picture above clearly shows the difference in the structure of CDs (left) and DVDs (right). (Pictures were taken by microscope)

Based on the well proven experience in the world of CD Production, Sony DADC Austria AG has played a very important role in the field of the development for the right process of DVD-production.

Because of the fine structure the DVD is able to store huge amount of data, much more than CDs. Moreover, the DVD can also be produced with up to four layers (shown on the following pictures).

There are four main sizes of DVDs:

- DVD 5 (4,7 GigaByte)
- DVD 9 (8,5 GigaByte)
- DVD 10 (9,4 GigaByte)
- DVD 18 (17,1 GigaByte)

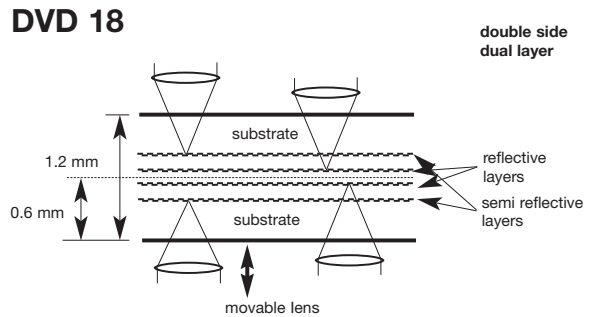
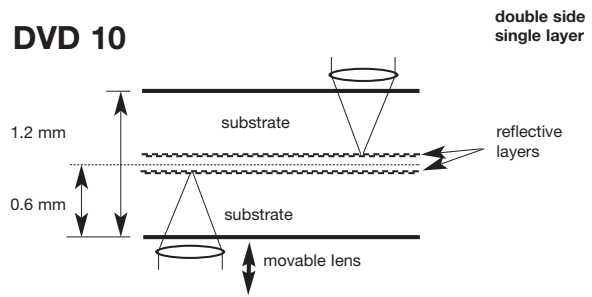
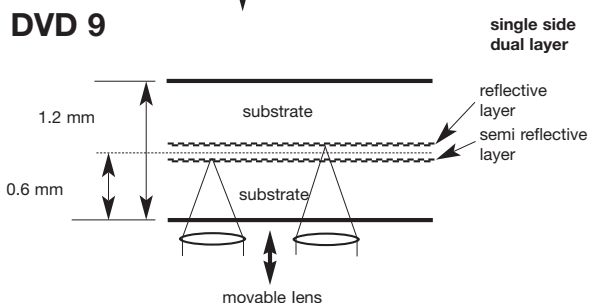
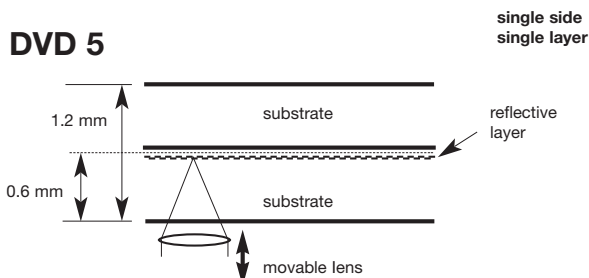

From the production point of view there is a big difference between CD and DVD due to the multi-layer technology. DVDs consist of two polycarbonate discs (each 0,6 mm thick), which are bonded together. This adhering process is one of the critical production steps since the laser has to "read through" the adhesive. Sony DADC Austria AG have developed their own process throughout years of trial and step-by-step improvement to its final high reliable and very fast production route.

The DVD 5 is big enough to accommodate 130 min of movie with one audio stream. To add special features like interviews of actors, special scenes such as "The Making Of" or more than one audio stream, it is recommended to use a DVD 9.

The DVD 9 is big enough to store one film of about 130 min playtime with up to eight languages and an additional 35 mm approximately of bonus material. Alternatively, one film with one language, but a playtime of about 5 hours can be stored.

However if you have generated your content Sony DADC Austria AG will be happy to find the right DVD for you.

For capacities smaller than 4,7 GigaByte or some special promotion Sony DADC Austria AG is pleased to offer the MiniDVD, which is a DVD with a diameter of 8 cm. The MiniDVD can accommodate up to 1,46 GigaByte on a single layer or up to 2,66 GigaByte using the dual layer technology.



However, the two most commonly used DVDs are the DVD 5 and DVD 9. These single sided discs bring a maximum of comfort to the home-cineast combined with high data storage capacity.

Single Side DVDs	Single Layer	Dual Layer
Data Capacity		
<b>DVD</b>	<b>4.7 GB</b>	<b>8.54 GB</b>
<b>MiniDVD</b>	<b>1.46 GB</b>	<b>2.66 GB</b>
Wavelength of laser diode	<b>650 nm</b>	<b>same</b>
Minimum pit length	<b>0.5 <math>\mu\text{m}</math></b>	<b>0.44 <math>\mu\text{m}</math></b>
Track pitch	<b>0.75 <math>\mu\text{m}</math></b>	<b>same</b>
Disc thickness	<b>2x 0.6 mm</b>	<b>same</b>
Disc center hole	<b>15.0 mm</b>	<b>same</b>
Reflectivity	<b>45-85%</b>	<b>18-30%</b>
Reference scanning velocity	<b>3.49 m/sec</b>	<b>3.84 m/sec</b>
Maximum user bit rate	<b>11.08 Mbps</b>	<b>same</b>

Since DVD10 and DVD 18 are read from both sides, there is the disadvantage of having to turn these DVDs in most of the players. Additionally, there must not be large prints on the top or bottom side (due to legibility). Only small printing areas are allowed (please find detailed information in chapter 4 of this manual).

## 1.2 DVD 5

The DVD 5 is a **"Single Layer Single Side"** Digital Versatile Disk (DVD), with a storage capability of 4,7 GigaByte. This capacity is sufficient to record a 130 minute long movie with one audio stream.

The picture below shows the principal structure of a DVD 5. As it can be seen, there is just one layer, which is read from one side.

DVD 5 • 4,7 GigaByte • Single Side/Single Layer

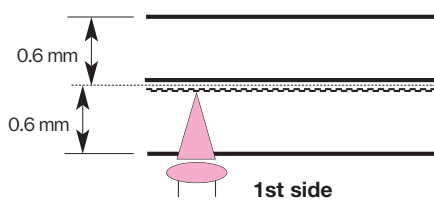

The DVD 5 is to be named **"The entrance of the World of DVD"**. Its capacity is clearly higher (approximately seven times) than that of a Compact Disc (CD) but still far behind in the real DVD-possibilities (accommodating up to seventeen GigaByte).

Yet this DVD 5 – Video is the right product for "classic" titles without features, like different languages, scenes of "The Making Of", actor interviews, various camera positions or interactive movies.

In the field of movie business, the purpose of DVD 5 is more or less to substitute VHS – formats and to increase the comfort of watching movies at home, combined with high durability.

From the production's point of view, there are several procedures necessary. Firstly, the so-called "glass master" has to be produced. After a special developer (photo-lacquer) has been applied onto a glass-plate, the microstructure for the DVD has to be burned by a special laser writer. Subsequently this glass master is coated by nickel to get a nickel foil with the micro-structure.

The removed nickel-layer (called father) could already be used as a stamper in the replication machines. But for trough-put reasons, copies (stamper) have to be made with the help of a negative-print of the father (which is called mother). Afterwards these few stampers are used in die-casting machines to produce 0,6 mm thick polycarbonate discs, which have the final structure of the DVD. To be readable by a laser light, these polycarbonate discs have to be coated by reflective layers. Consequently aluminum is sputtered onto the polycarbonate substrate containing the right information.

Within the next production step two discs are bonded together to get the final thickness of 1,2 mm. But because of the one layer data structure of the DVD 5, only the bottom disc contains information. The top disc is just a plain disc with no information.

Finally there is one disc with one readable layer and a thickness of 1,2 mm with a data-volume of max. 4.7 GigaByte.

## 1.3 DVD 9

The DVD 9 is a **"Dual Layer Single Side"** Digital Versatile Disc (DVD), with a storage capability of 8,5 GigaByte. In fact, both layers are read from one side. Due to the "Through-Reading-Process" the data-structure of the second layer is a little bigger, which causes less capacity than on the first layer. Therefore the total ability is given with 8,5 GigaByte and not twice the capacity of a DVD 5 (which is 4,7 GigaByte x2 and would be equal to 9,5 GigaByte).

DVD 9 • 8,5 GigaByte • Single Side/Dual Layer

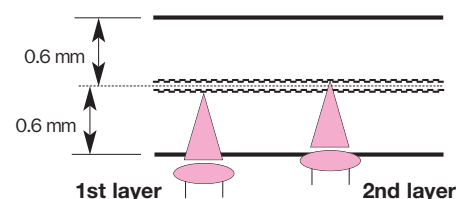

# 1. General and Technology

However, this capability is sufficient to record a 130 min long movie with more languages using "Dolby, Surround System" plus special features like different camera positions, "The Making Of" scenes, interviews and other fascinating benefits with a length of about 35 minutes. If only just one audio stream is applied, about 5 hours movie playtime could be accommodated on the DVD 9. Nevertheless, if you have not decided which DVD fits your demands, Sony DADC Austria AG is very happy to choose the right size for you. The choice will be based on the data you are submitting.

As it is clearly drawn on the picture below, the DVD 9 is employing the dual layer technology. The first reflection layer is a semi reflection layer made of Silicon (~20% of the light is reflected), whereas Aluminum is used for the second and fully reflective layer.

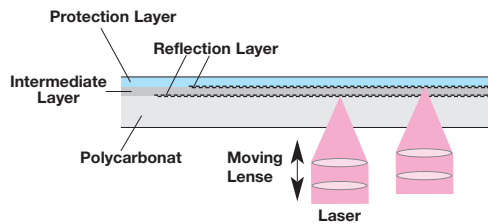

The player self-focuses the right layer automatically, which cannot be realized by the home-cineast or computer-freak. From the consumer's point of view, it is hard to tell if a DVD 9 or a DVD 5 is employed because they look very similar. The DVD 9 (dual-layer-DVD) can be read by every DVD-Player and is state of the art technology.

From the technology's point of view, two different reading processes can be employed. Sony DADC Austria AG uses the Dual Layer **Opposite Track Path** (OTP) for DVD-Video to ensure a smooth running movie.

## Dual Layer Opposite Track Path (OTP)

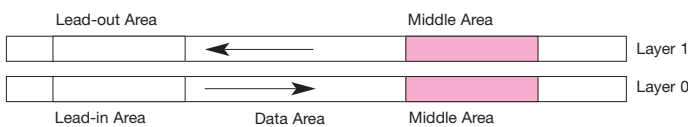

## Dual Layer Parallel Track Path (PTP)

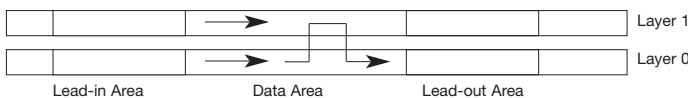

The DVD-ROM could differ from the DVD-VIDEO by using the Dual Layer **Parallel Track Path** (PTP).

This is acceptable due to the fact that the data is not stored within one constant stream, but in sectors and segments.

From the production's point of view, the DVD 9 production route is quite similar to the DVD 5 production route. The differences are that one disc is sputtered with silicon instead of aluminum and that the second disc has a data-structure as well as being sputtered with aluminum. Afterwards these two "half"-discs are adhered to each other. The highly sophisticated adhering process itself is critical, since the laser beam has to read through the first layer. However, Sony DADC Austria AG is pleased to guarantee the highest quality of DVD 9 by using proven technology and best practice to avoid production defects. Since Sony DADC Austria AG is one of the first replication centers in Europe, they employ highly trained workmanship. Processes are often tested to assure the best quality within the shortest delivery times.

DVD 9 has become the standard for DVD-Video applications, which is more than just a VHS substitute.

## 1.4 DVD 10

The DVD 10 is a "Single Layer Dual Side" Digital Versatile Disk (DVD), with a storage capability of 9,4 GigaByte. This capacity corresponds to twice the data-volume on a DVD 5. A disadvantage of the DVD 10 is that it is read from both sides.

### DVD 10 • 9,4 GigaByte • Double Side/Single Layer

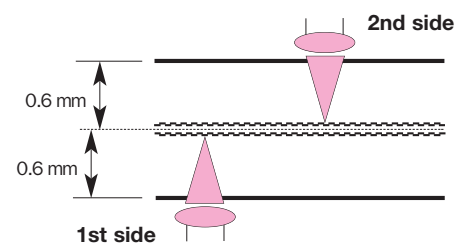

The picture above shows the principal structure of a DVD 10. As it can be seen, there is just one full reflective layer per side, which is read from each side.

Due to the fact that only few players in the market have the capability to read from both sides, it is very inconvenient for users to turn the DVD over while the movie or program is running. Additionally, it is also not possible to use any side of the DVD for large prints either, since the laser reads from both sides (for further information please see chapter 4 of this document).

Compared to the DVD 9, the additional capacity of the DVD 10 is about 900 MegaByte (just a little more than the capacity of one CD) but the disadvantages may increase, depending on your application.

One reasonable application may have the same content on Side A and on Side B but in different formats, like one in PAL (**P**hase **A**lteration **L**ine) and one in NTSC (**N**ational **T**elevision **S**ystems **C**ommittee).

From the production's point of view, the DVD 10 is very similar to the DVD 5, with the only difference being that both discs do contain data and they are adhered back to back. Both reflective layers are made of aluminum.

## 1.5 DVD 18

This "**Dual Layer Dual Side**" Digital Versatile Disc (DVD) has a maximum data capacity of about 17,1 GigaByte. This is exactly twice the capacity of a DVD 9.

DVD 18 • 17 GigaByte • Double Side/Dual Layer

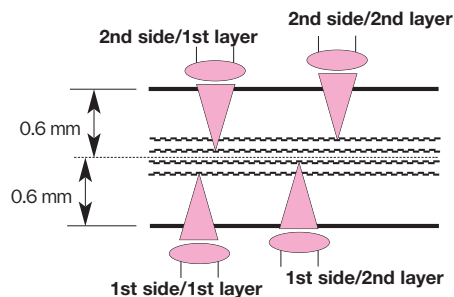

The picture above shows the principal structure of a DVD 18. As it can be seen, there are two layers per side, one semi-reflective and one fully reflective similar to the DVD 9.

In terms of handling, this kind of DVD does have the same disadvantages as the DVD 10. Due to the fact that only a few players in the market have the capability to read from both sides, it is very inconvenient for users to turn the DVD over while the movie or program is running. In addition to this inconvenience it is also not possible to use any side of the DVD for large prints since the laser reads from both sides (for further information please see chapter 4 of this document).

From the production point of view, the DVD 18 is the most complicated disc.

The stampers are made during the same process as the DVD 5. After the polycarbonate discs have been produced in the die-casting machines, the first layer has been built up by the polycarbonate. This layer is sputtered with silicon (like it was with the DVD 9 for the first layer with approximately 20% reflection). Then a special developed liquid UV resin is applied onto the silicon layer. Then another stamper containing the pit pattern (information) for the second layer is pressed onto the applied liquid. After the liquid resin has dried, Aluminum is sputtered onto this information-layer and a special adhesive is applied, which glues two similar fabricated discs together. Finally, there are four layers of information and roughly 17,1 GigaByte of data. Since the DVD 18 has little application, Sony DADC does not offer this niche-product.

## 1.6 MiniDVD

The MiniDVD is the small DVD for the big ideas. Compared to normal DVDs (diameter of 12 cm), this DVD has a diameter of only 8 cm. There are two different kinds of MiniDVD: The "Single Layer Single Side" DVD which holds approximately 40 minutes of film (1.46 GigaByte) and the "Dual Layer Single Side" DVD with approximately 75 minutes of film-material (2.66 Giga-Byte).



This MiniDVD is the "little sister" of the conventional DVD. With the main difference being its smaller size, it is much more convenient to send via the post and therefore the ideal "transport-media" for promotion material such as corporate videos, multimedia presentations, film trailers and more. It has roughly twice the capacity of a CD-Rom but being much lighter and more attractive through the special appearance.

Therefore the MiniDVD is the real product for Promotions and Company Presentations.

From the production point of view, there is not a big difference to the 12 cm DVDs apart from the different diameter.

# 1. General and Technology

## 1.7 ColourDVD

The ColourDVD by Sony DADC Austria AG is available in six different colours. The bright red, yellow and violet are real eye catchers, whereas the three discrete colours (orange, pink and gold) are designed for subtle applications. Regardless of the specific colour used, the real thrill of the ColourDVD is the special appearance of the former silver disc. Sony DADC Austria AG is proud to have developed this special look, which brings out different moods. Apart from different emotions, the ColourDVDs are well suited to resemble various themes.

Technically speaking, the secret behind the ColourDVD is coloured polycarbonate. Throughout many trials Sony DADC Austria AG found the right colours with the right tint, which can be used without losing application-quality.



## 1.8 SniffleDVD

Since Sony DADC Austria AG has already been producing the SniffleCD, there was no major development step necessary in applying this to the SniffleDVD.

The aroma can be placed on all or parts of the label print of the DVD 5 and DVD 9. Technically speaking, the unique scents are mixed to the colour of the prints and are released by rubbing the label. The duration of the scent of the SniffleDVD lasts for about one year. Sony DADC Austria AG is pleased to be able to offer the five most popular aromas from stock, which are rose, strawberry, green apple, lemon and mint. In addition to these standard scents, a further 95 aromas are available (like chocolate, coffee, vanilla, different fruits, or technical scents, etc).



Moreover, since the perfume is mixed with the label-print, it is also possible to get your own aroma onto the disc.

Of course the perfume has to fulfill certain requirements, such as

- It must not be water soluble
- Minimum 20 ml of perfume oil is needed for capsule-check (which takes about 3 to 4 days within Sony DADC Austria AG).
- For the production a minimum of 1 litre (1 kg) of perfume oil is needed (even if a DVD sample production is ordered), which will be sufficient to produce approximately 30,000 discs if 100% of the DVD-top-surface is covered.

In case you supply your own scent, please keep in mind that, Sony DADC Austria AG needs about 3 to 4 weeks to produce the scent-capsules needed to mix the aroma with the colours. For the standard order turn-around time you can assume that it takes an additional 3 to 4 days (depending on the order size).

## 2. DVD-Video

### 2.1 General

DVD-Video is a new media for the distribution of home videos. The digital nature of this new media offers several new features to the consumer.

Amongst these features are:

- High video quality based on MPEG2 compression and the ability to playback both aspect ratios of 4:3 and 16:9.
- A DVD-Video can hold up to 8 different audio tracks (streams). Each track can be used for a different language. It can also be utilized for high quality stereo audio with a resolution of 16 bit and 48 kHz, or for theatre quality surround audio, like Dolby Digital AC-3 or multichannel 5.1.
- Up to 32 different streams of subtitles can be placed on a DVD-Video, used as language subtitles, as menu highlights or as instructions for interactive functions.
- Digital copy protection via CSS and analogue copy protection via Macrovision.
- Multibranching is another feature of DVD-Video that simply offers the possibility to playback one title with different parts of this title, which can be interactively selected by the viewer. In addition, the multiangle option allows a scene of a movie title to be viewed in different angles.
- Most of the DVD-Video players imply a region code corresponding to one of the six regions in the world where it is sold. This regional coding optionally enables playback of a DVD-Video title in certain regions only.
- DVD-Video discs can be prepared with a "Parental Lock" in order to restrict the playback only by usage of a correct password.



### 2.2 Input media for DVD-Video

Sony DADC prefers a DLT4000 or (DLT7000/DLT8000) format as standard input source. The tape should be recorded in DDP 2.0. If different systems are applied (such as e.g. "DLT 1" or "HP V80"), reading problems will occur. If you have no adequate DLT-recorder please send the content on DVD-R (Remark: a DVD-R can only be used if a DVD 5 is replicated; if a DVD 9 is to be pressed, there is no other way than a DLT.)

However, for complete authoring services Sony DVD Center Europe will be happy to assist you further. (please contact us at +43/(0)6246/880-1610 or visit our Web-Page "www.sonydvdcenter.com").

### 2.3 Details on DVD Authoring Possibilities

#### 2.3.1 Video

DVDs can be produced for both PAL and NTSC video standards. The aspect ratio of the source material can either be 4:3 or 16:9. The viewer has the choice of several output options on most players, according to the monitor. For example, in the case of a widescreen source the viewer can select between letterboxed and – if encoded during authoring – pan/scan playback on a 4:3 screen.

#### 2.3.2 Audio

A DVD may contain up to eight different soundtracks, for example a feature film in different languages, each of which can be in one of the following formats:

- Linear PCM mono or stereo (equivalent to the CD format)
- DTS (Digital Television Standard)
- MPEG1 mono or stereo
- MPEG2 multichannel
- Dolby Digital AC-3 mono, stereo or multichannel 5.1

Any stereo track can be encoded Dolby Pro Logic Surround, to extend the compatibility with existing home entertainment equipment.

Please note that this encoding is not implemented during DVD premastering, but has to be completed during preparation of the mastertape.

The sampling frequency on a DVD is 48 kHz.

#### 2.3.3 Subpictures

Subpictures can be keyed into the videosignal and are used for several applications on the disc, for example:

- as menu highlights
- as logo
- as instructions for an interactive function
- for language subtitling, display of karaoke lyrics etc.

## 2. DVD-Video

### 2.3.4 Subtitles

Subtitle companies are usually capable of handling subtitles in almost any language. They usually require a VHS copy of the program master with VITC or LTC time code and preferably with a visual TC at the top of the picture as well as a script of the dialog or lyrics.

### 2.3.5 Still Pictures

Still pictures can be utilized as a background for menus in full colour and full resolution, or as a still/slide show.

### 2.3.6 Regional Coding

Most DVD players imply a certain code, which corresponds to one of the six defined regions where they are sold. Such a code, or several codes, can be applied to the discs. However, the number of both the player and the disc must match in order to enable disc playback.

If regional code "0" is applied, this DVD can be played on every DVD-Player – no matter which regional code is adjusted.



### 2.3.7 Multibranching

The DVD offers the function of playing alternative blocks with different contents within one title. Using this feature, different versions of a movie can be created.

For example, it would be possible to create a movie which consists of an identical main block and an end block with two alternatives, enabling the user to choose between a happy or perhaps a tearful end. In general, it will be useful to set the changeover of such blocks matching chapter points, if chapter points exist.

Please note that there are technical restrictions for seamless playback in the creation of multiple alternatives. For example, the playtime variation of the different alternatives within one block is limited. Due to the complexity of these features, please contact us at +43/(0)6246/880-1610 or visit our Web-Page: "www.sonydvdcenter.com"

### 2.3.8 Parental Lock

DVD Video Discs can be coded with a number from 1-5. DVD Players can only playback DVDs with a code number lower than the password protected code set on the player.

### 2.3.9 Multiangle

Multiangle allows the creation of different viewing alternatives within the same contents of a title. Using this feature the user can select between different camera views "on the fly".

### 2.3.10 Aspect Ratio

The video source material may be either of 4:3 or 16:9 anamorphic aspect ratio. Please define the corresponding parameter on the Mastertape Info.

To maintain the maximum vertical resolution, 16:9 anamorphic is preferred for widescreen sources. However, the aspect ratio must be constant within one title of a DVD, otherwise different titles will have to be created on the disc.

### 2.3.11 Audio Masters

All audio masters must be recorded with 48kHz sampling rate, Linear PCM according to AES/EBU standard. The use of emphasis is not recommended. For Mono-, Stereo- or encoded Dolby ProLogic programs the audio tracks of the video mastertape should be used. As these mastertapes contain four audio tracks, a maximum of four different versions in mono or two stereo soundtracks can be provided with the videotape. The video and audio parts of the mastertape must be synchronised.

## 2.3.12 Separate audio masters, digital multichannel audio programs

For DVDs with digital multichannel sound, a separate audio mastertape is required for each soundtrack. These should be of either Sony PCM-3324 format, Sony PCM-800 format or equivalent and must contain the final mix of the 5.1 channels – front left, front right, left surround, right surround, centre low frequency channel – as discrete tracks. The encoding of these tracks to the specified digital multichannel datastream is carried out during the DVD premastering process.

### 2.3.12.1 General

Menus are the key to navigation on a DVD disc. They allow the user to locate any chapter point on the disc, change the language for the movie or display subtitles in any of the languages provided.

#### Basic menu structure:

Sony DCE has all the equipment and skills required to prepare menu screens from scratch or by using references such as existing artwork (e.g. LD or VHS packaging) for graphics, movie captures for animations, 3D modelling, Internet convergence, eCommerce integration and other multimedia applications for DVD. We therefore will readily accept your order to design the menu screens for you.

Mastertape Channel Content	
1	Front left
2	Front right
3	Left Surround
4	Right Surround
5	Center
6	Low frequency channel

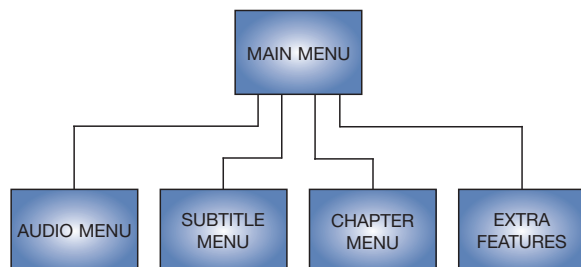

## 2.3.12.2 Backgrounds

When designing backgrounds, six major issues need to be addressed. These are Image Size, Safe Area, Colour Depth, Interlacing, File Format and Naming Convention.

### 2.3.12.3 Image Size

Computer pixels have an aspect ratio of 1:1. However, NTSC pixels are 0.9:1 and PAL pixels are 1.0667:1. This discrepancy causes the menu background to look distorted when exported to D-1 video; NTSC D-1 menus are compressed horizontally and PAL D-1 menus are compressed vertically. The menus should be distorted at design time to counter the effects of TV distortion. For NTSC the menus should be pre-compressed vertically and for PAL, the menus should be pre-compressed horizontally. To accommodate PAL and NTSC requirements and to compensate for these known distortions, the menus for NTSC should be designed at 720x540 pixels and for PAL at 768x576 pixels. For NTSC, resize the image to a height of 480 pixels, keeping the width at 720 and for PAL, resize the image to a width of 720, keeping the height at 576. At this point the menu will look distorted on a computer screen, but this will be compensated for when they are exported to D-1 or DigiBeta.

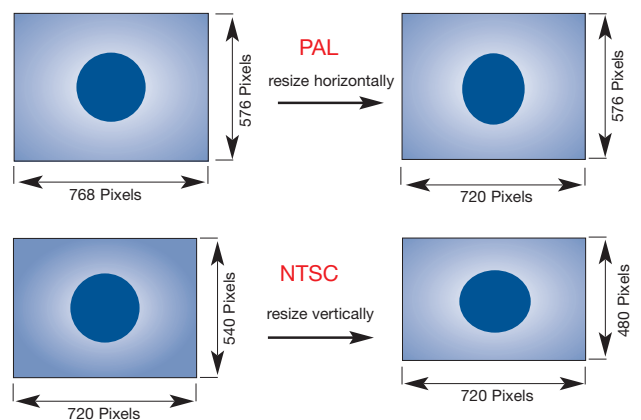

## 2. DVD-Video

### 2.3.13 Safe Area

DVD Menus should be designed in accordance to standard Title Safe and TV Safe areas. All graphic elements of significance should be within TV Safe and all text should be within Title Safe. TV Safe is a 5% margin from the edges of the video image and Title Safe is 10% from the edges.

These areas should be applicable in the last stage shown above. This translates to the following margins for PAL and NTSC:

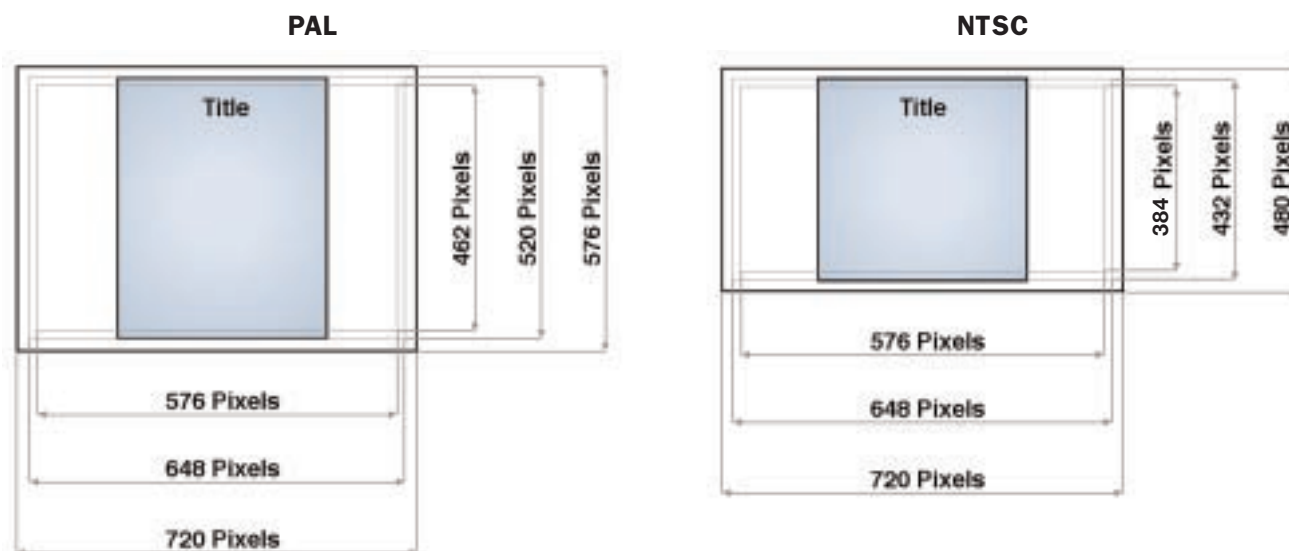

Margins in Pixels for TV and Title Safe areas:

	Edge	TV Safe Margin	Title Safe Margin
PAL	Left / Right Each	36 Pixels	72 Pixels
	Top / Bottom Each	28 Pixels	57 Pixels
NTSC	Left / Right Each	36 Pixels	72 Pixels
	Top / Bottom Each	24 Pixels	48 Pixels

For Menus in 16:9 format please contact Sony DVD Center Europe

### 2.3.14 Colour Depth

A 24bit colour palette can be used, as long as NTSC/PAL colour limits are not exceeded. CCIR-601 (or ITU-R 601 as it is known now) recommends that the nominal range for RGB signals should be 16-235 on a scale of 0-255. The extra headroom from 0-15 and 236-255 is occasionally needed to accommodate overshoot and other out of bounds signals that can be generated by analog video processing.

A good reference for colours that work well with NTSC and PAL colour systems are their 75% Colour Bar test signals. For conservative design, the RGB values of these Colour Bars can be used as the upper/lower limits for their respective colours.

PAL / NTSC 75 % colour bar RGB values (Gamma Corrected) :

Range		White	Yellow	Cyan	Green	Magenta	Red	Blue	Black
		PAL / NTSC							
R	0-255								
G	0-255	255 / 191	191	0	0	191	191	0	0
B	0-255	255 / 191	191	191	191	0	0	191	0
		255 / 191	0	191	191	191	0	0	0



### 2.3.15 Interlacing (Flicker/Jitter)

A video frame is made up of two video fields. These two fields are interlaced and each contains half of the information required to display the frame. Due to timing drifts in video equipment, the two fields do not interlace perfectly causing the flicker/jitter commonly seen on sharp edges and fine lines.

This is more evident in horizontal lines than vertical. This problem is not evident on computer displays because they are usually non-interlaced.

To avoid these flicker/jitter problems, thin (e.g. single pixel) horizontal lines should be avoided and the overall image should be blurred, using either gaussian or other suitable methods.

### 2.3.16 File Format

The preferred file formats for menu background delivery are uncompressed TIFF or as video on a separate tape. If the artwork is made in Adobe Photoshop, it must be saved in PC format with no compression. Some graphics packages save an alpha channel with a 24bit file. DO NOT save the alpha channel.

### 2.3.17 Naming Convention

For efficient and clear processing of the menu items, the following naming convention should be applied:

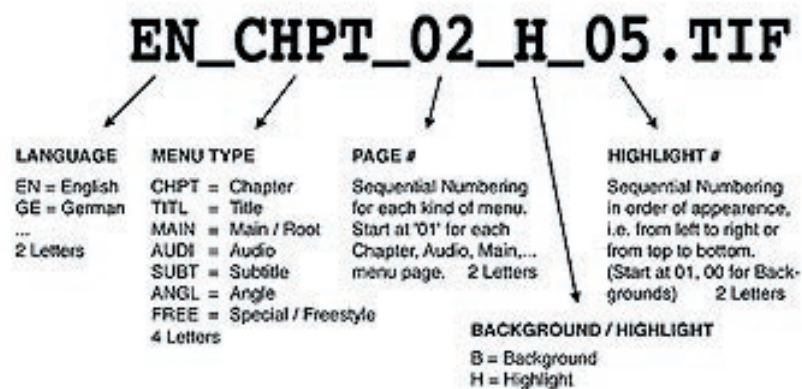

### 2.3.18 Registration and Alignment

To facilitate positioning and alignment of highlights/overlays on the backgrounds at Sony DADC, a file with registration marks should also be supplied with the main background file. This file should contain clearly visible registration marks in addition to artwork in the menu background file.

The registration marks can be of any type as long as they are accurate to one pixel width and height. They should also be of a colour that makes them stand out from the background.

The accompanying highlights/overlays should have a matching registration mark in a colour of the palette, which has not yet been used. This is discussed in detail later.

### 2.3.19 Image Size

Each highlight on any page should be contained in its own separate TIFF file. Each image should only be as big as the text or graphic itself and should not have any white space around the graphic. It should also be big enough to include the registration mark. Please make sure to always supply two images of the same dimensions per highlight, one with and one without registration mark. This allows closer placement of highlights on the page, as highlight files cannot overlap in a DVD menu.

One file that contains all the highlights for a page should also be provided. The colour depth and file format for this file should be the same as the other highlight files. Sample below.

Menu background without...



...and with registration marks



## 2. DVD-Video

### 2.3.20 Colour Depth

The highlight must be an indexed, 8 bit, 256 color TIFF file. Since DVD specifications allow 4 colours in a highlight at any given time, even though this file has 256 colors in its palette, the actual graphic can only have 4 colours. One of these colours is keyed out to show transparency. The remaining can be any three colours in the spectrum. The figure below is a screen shot of the palette of a highlight file. If you can't access this option in your graphic program, the file is probably not indexed or has the wrong colour depth. Note that only the first 4 colours of the palette are in use and the remaining are blank. This is the only acceptable format of the highlight palette.

The DVD specification also allows any menu page to have a palette of 16 colours. This allows for different "not highlighted state", "highlighted state" and "activated state" colours. The figure below shows two images, a "highlighted state" and an "activated state".

Please note that the total number of colours (including black and the registration mark) is more than four. However, at any given time the image has only four colours.

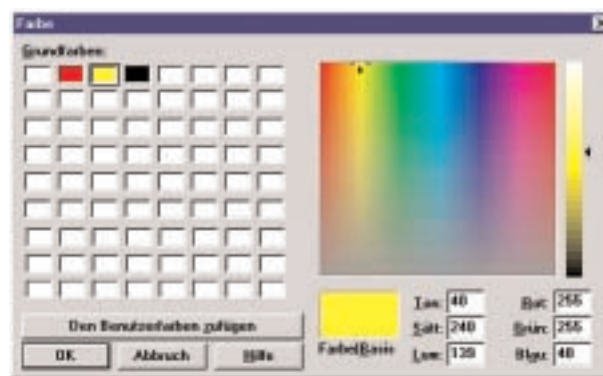

### 2.3.21 User Interface and Delivery

#### 2.3.21.1 Printouts

Colour printouts of all backgrounds must be provided for reference. One printout should be provided to demonstrate the effect of the highlighted state and one to demonstrate the activated state. If these are different for the Main Menu, Audio Menu, Subtitle Menu, Scene Selection Menus and Special Menus, then two printouts must be provided for every unique colour combination demonstrating both highlight and active colours.

A hard copy of the text or PDF files should also be provided along with a printout of the disc contents.

#### 2.3.21.2 Navigation

Non-standard navigation must be explained on paper and a text or PDF file. For complex navigation, it will be necessary to contact Sony SDCE.

#### 2.3.21.3 Media

PC Formatted ZIP or CD-R

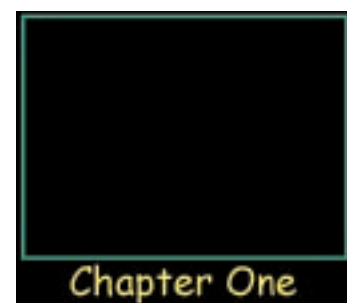
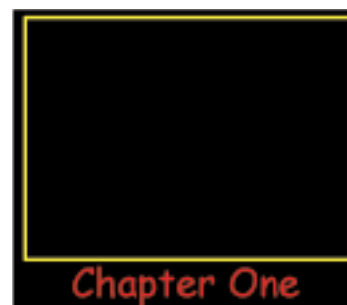

## 3. DVD-Rom

### 3.1 Data Preparation

The first step in formatting is the collection and preparation of the input materials. You can submit already formatted data as an image on tape or leave the formatting of your data to us. Unformatted data on storage media, as well as backup formats on tape or unformatted data transmitted via ISDN, first have to be converted into a DVD-ROM compatible format. Please note that these additional process steps take more time and are more expensive. In order to arrange the data in a required sequence, please provide a detailed listing of the file and directory structure of the final DVD-ROM.

If you submit a tape, please inform us whether there is a DVD image or a backup format on this tape. According to chapter 3.3. (image on tape) we are able to achieve shorter turnaround times for your orders and limit mastering costs as long as there is an already formatted DVD image on tape.

When sending hard disks or exchange discs please let us know the number of files and the data quantity. Pack your data carrier carefully to avoid damage during transportation. Moreover, we ask you to mark your input carriers. Please be sure to use adequate fibre pens which do not damage the surface of the disc, particularly with DVD-R.

### 3.2 Formatting

Sony DADC formats data according to the UDF-Bridge (UDF + ISO 9660) standard:

#### UDF-Bridge Format:

Is a new logical format for volume and file structure on DVD-ROM discs to support the interchange of information between a computer system and dedicated DVD drives or players.

UDF-Bridge also stands for a combination between the Universal Disc Format (ISO/IEC 13346) and the ISO 9660 standard.

Through the naming and file structure of UDF, the UDF file system is much more powerful than the file structure of ISO 9660.

However, the UDF-Bridge combines both the UDF and ISO 9660 formats. Therefore the file structure has to meet the ISO-9660 designation agreement.  
ISO 9660:

The ISO 9660 (level 1) file structure is limited to the characters "A-Z", "0-9" and "\_" (underscore) with a maximum of 8 characters in length and 3 characters extension and a maximum of 8 directory levels (including the root directory).

To avoid the restrictions of ISO 9660 level 1 and to use longer file names, level 2/3 can also be used. These levels restrict filenames to 30 characters and directory names to 31 characters.

#### Joliet extension:

To meet the demand for Windows 95 file names, there was an extension designed called Joliet format. This file system allows longer file and directory names than ISO 9660 level 1 as well as level 2/3, where file or directory identifiers may be up to 64 characters.

#### Apple Macintosh formatting

Apple Mac data are accepted for DVD-ROM formatting. However, all data should be provided on a Mac formatted media.

### 3.3 Input Media

DVD-ROM images on tape

Sony DADC will accept ANSI labelled DVD-ROM images either on DLT or SDX tape. We strongly recommend that any tape compression is turned off. The DVD Data Sector size can be 2048, 2054 or 2064 Bytes/Sector.

The DDP (level 2.00) is either to be placed at the front of the tape followed by the DVD Leading-data and the DVD Image or on a separate Floppy Disk.

The image is subjected to a logical incoming UDF-check and can be used for direct mastering.

## 3. DVD-Rom

### DVD-ROM, DVD-R

An already replicated DVD-ROM or a DVD-R (Authoring, General) is a preferred input media, and can be used for direct mastering.

### DVD-RAM, DVD-RW, DVD+RW

Data provided on DVD-RW, +RW or DVD-RAM can not be used for direct mastering. They need to be formatted according to the 'UDF-bridge format' which can be done by Sony DADC. Please understand that this additional formatting job will be charged to customers.

### Apple Macintosh/DOS SCSI Harddisk Drive

Please send us only a DOS or Apple Macintosh formatted hard disk drive.

A description of the file and directory structure of the final DVD-ROM, as well a Volume id/name should be included.

### Electronic data transmission:

For a shorter transmission of components to Sony DADC, we offer efficient data links via:

- ISDN primary rate interface – E1/T1
- WAM!NET managed or tracked services ([www.wamnet.com](http://www.wamnet.com))

The data can be sent either as a DVD-ROM image or as single files and directories.

If you are interested in using this kind of component transmission for your CD/DVD contents or the graphic data for label printing and packaging artwork, please get in touch with us. We will be pleased to assist you in establishing an electronic connection with us.



## 4. Labelprinting

*The following pages contain important specifications for DVD printing and the film material required.*

*Please transmit this information to your graphics artist or designer.*

We recommend to put the product specification logo (DVD, DVD-ROM, DVD-VIDEO) on every piece of packaging and labels. This ensures your customer using a product which complies with the DVD-Specifications. Sony DADC requires the customer to place the product catalogue number on the DVD and on every piece of the packaging.

### 4.1 Printing Processes

Sony DADC uses offset printing processes for DVDs as the standard print. On special request, simple screen prints can be done as well.

The following types of print can be processed:

- line prints with up to 4 colours  
(3 colours for DVD-10)
- half-tone prints
- duplex and triplex prints
- Four-colour prints  
(picture disc: offset/screen printing)

For particular requirements with respect to printing quality in four-colour print, we offer the High Definition Picture Disc. This is to be recommended particularly for applications including photographs, faces, landscapes or designs which are similar to photographs.

A specific offset process is used.

### 4.2 Printing Areas

The following pages illustrate the three possible printing areas on a DVD label (specifications F, G and H).

Please bear in mind that there may be colour deviations between the print on the aluminium coated part and the non-aluminium coated interior parts. Therefore, we advise to preprint an entire white base to minimize colour deviations with specifications F, G, H.

### 4.3 Label Film Dimensions

Please ensure that your label films comply with the required specifications F to H. Any necessary label film corrections are charged according to our price list.



# 4. Labelprinting

## Specification F - Label Print

DVD 5 / DVD 9

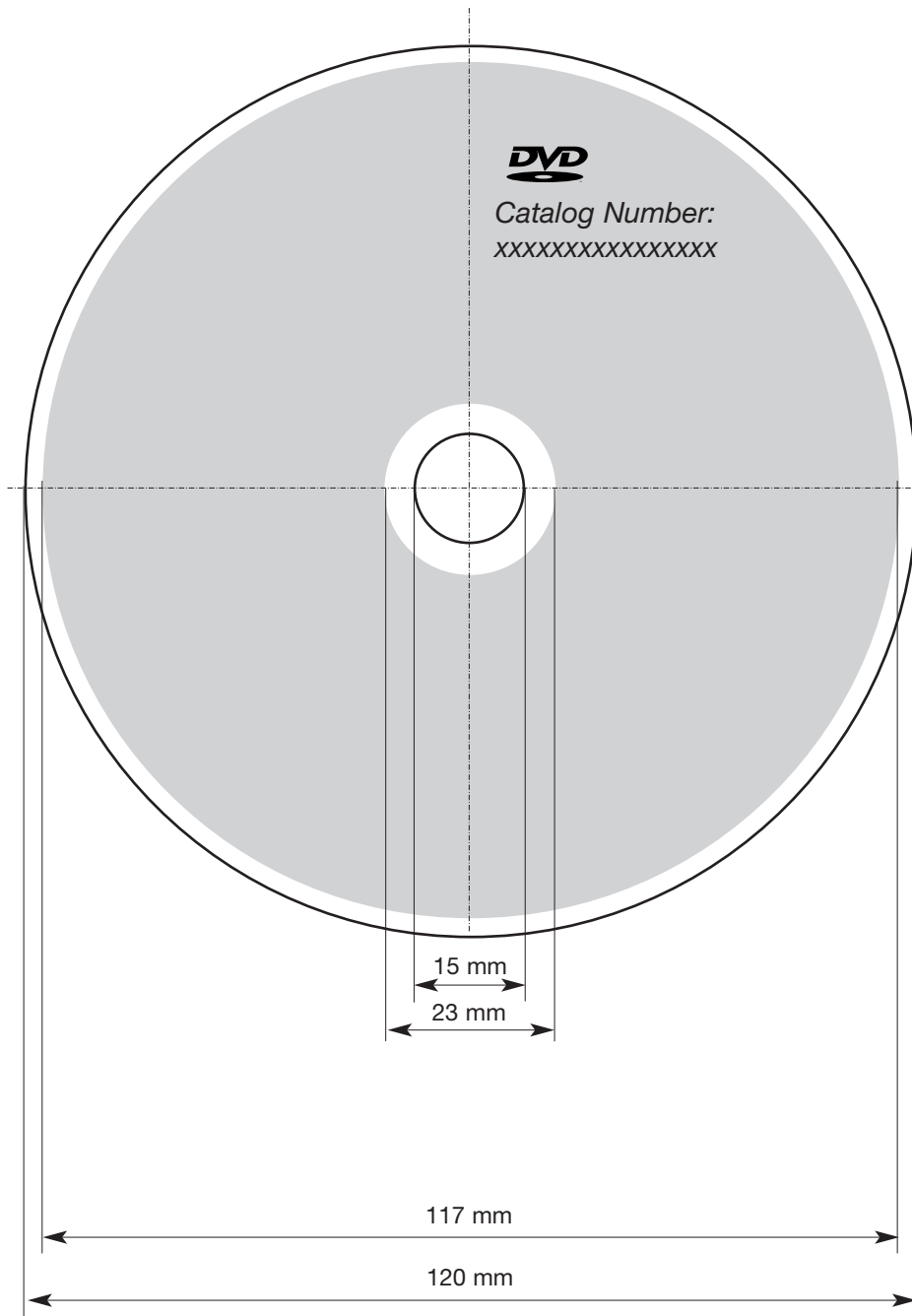

 Printing area on the DVD

# Specification G - Label Print

# DVD 10 Side A and B

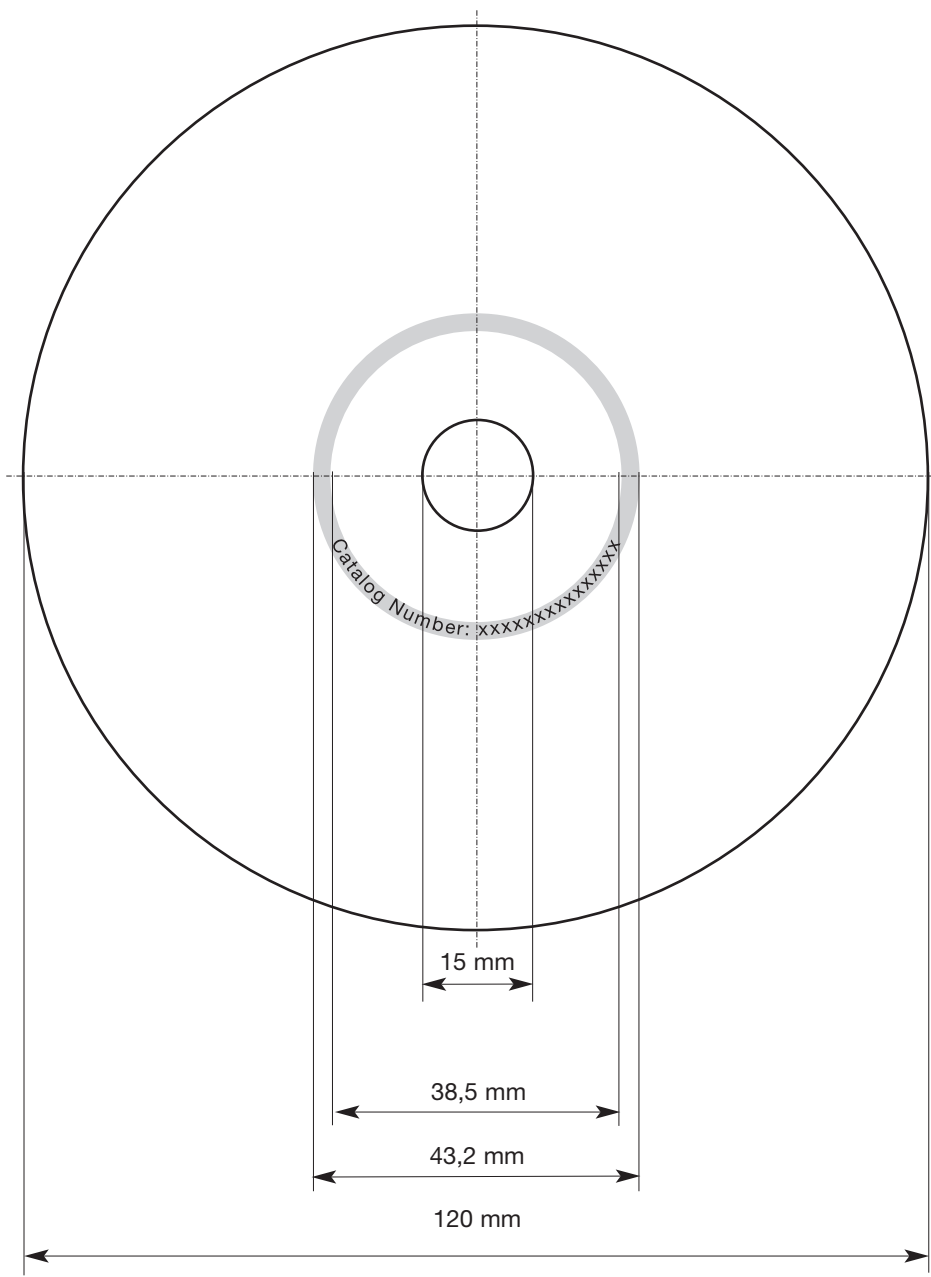

 Printing area on the DVD

## 4. Labelprinting

### Specification H - Label Print

### DVD 10 Labelside A

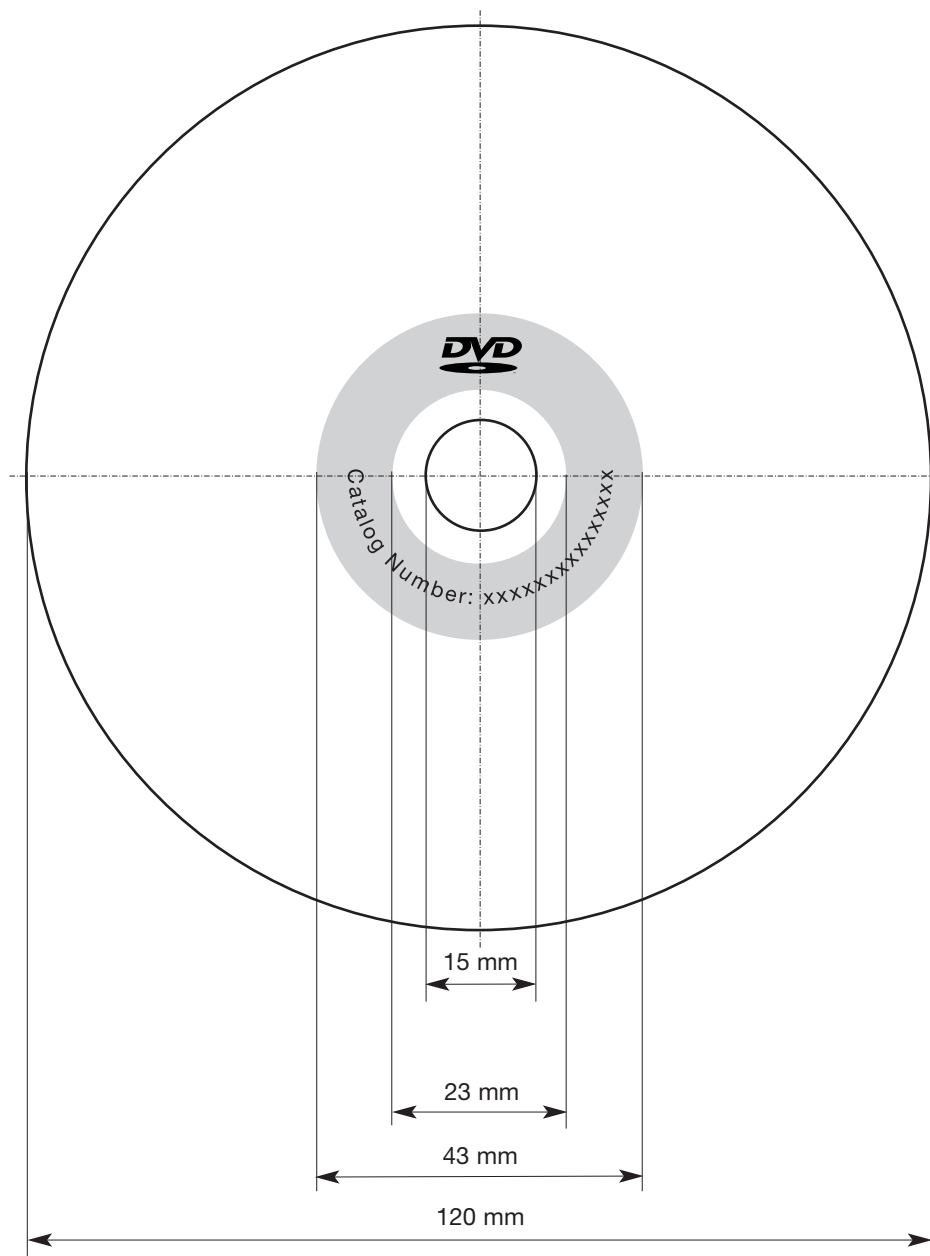

Alternatively, Sony DADC offers an extended printing area for DVD 10. Please note that Labelside A and Labelside B of specification H hold different printing areas. This is required in order to be able to machine-read the barcode of the product.

 Printing area on the DVD



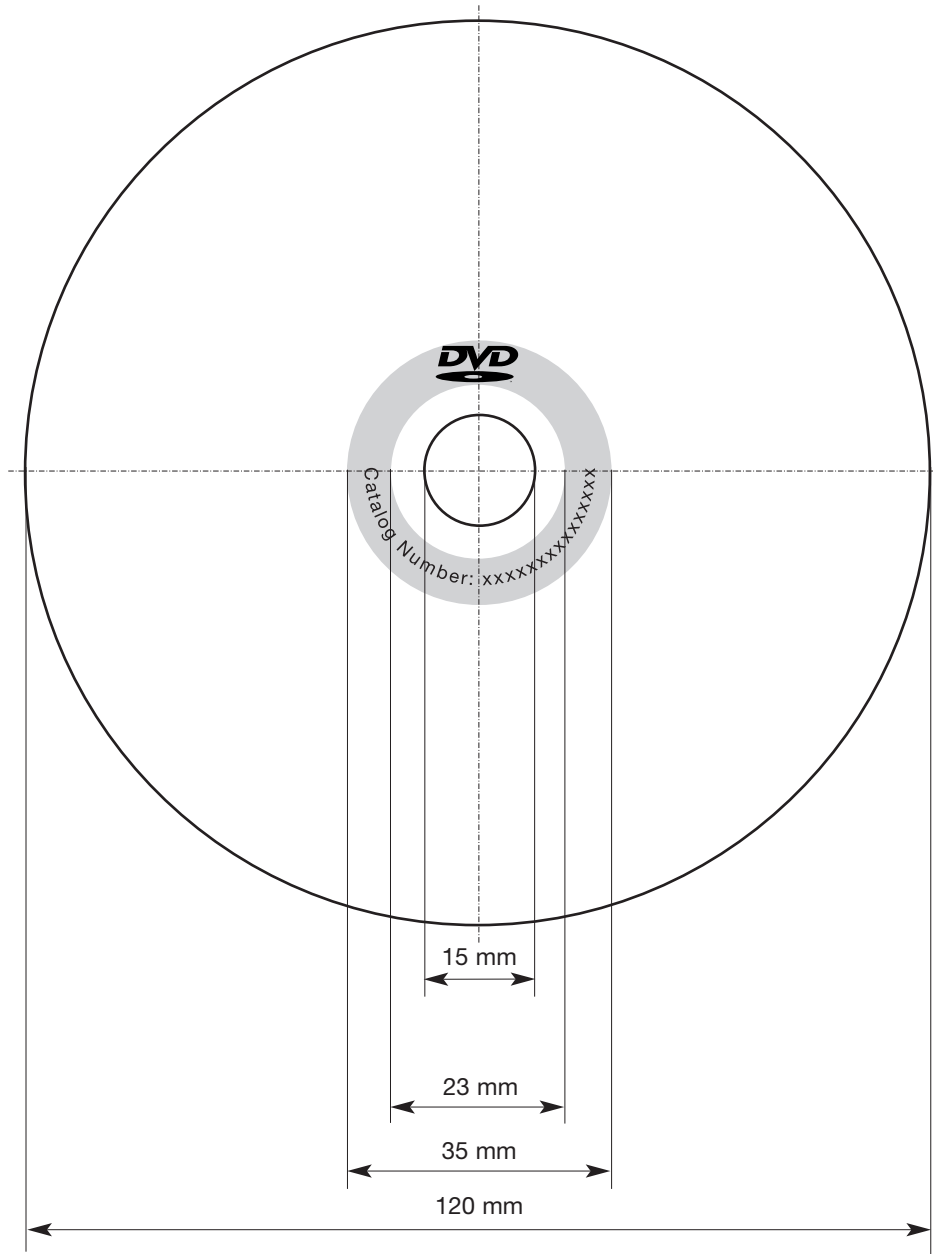

 Printing area on the DVD

# 4. Labelprinting

## 4.4 Film Specifications for Label Print

Unless otherwise indicated in one of the special printing processes below, we require smooth, full-page screen printing films (positive, right side reading, emulsion up).

### 4.4.1 Line widths and letter sizes

- The line width has to be at least 0.10 mm in positive print.
- The line width has to be at least 0.15 mm in negative print.
- The letter size has to be at least 4 pt. (1.50mm) in positive print.
- The letter size has to be at least 5 pt. (1.88mm) in negative print.

Please note that with serif type fonts (e.g. Times) and with type faces such as "light" with letter sizes of 4 and/or 5 pt. the minimum line width of 0.10 and 0.15 mm is not achieved and thus an adequately larger letter size has to be selected.

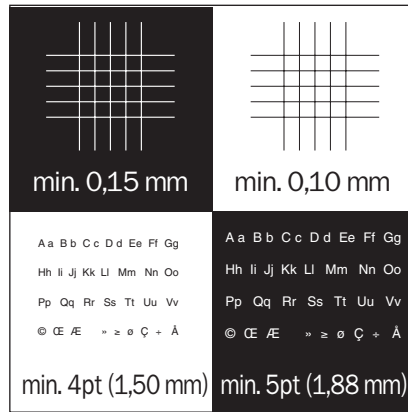

### 4.4.2 Registration marks for screen printing

The registration marks have to be arranged in the centre of the label film.

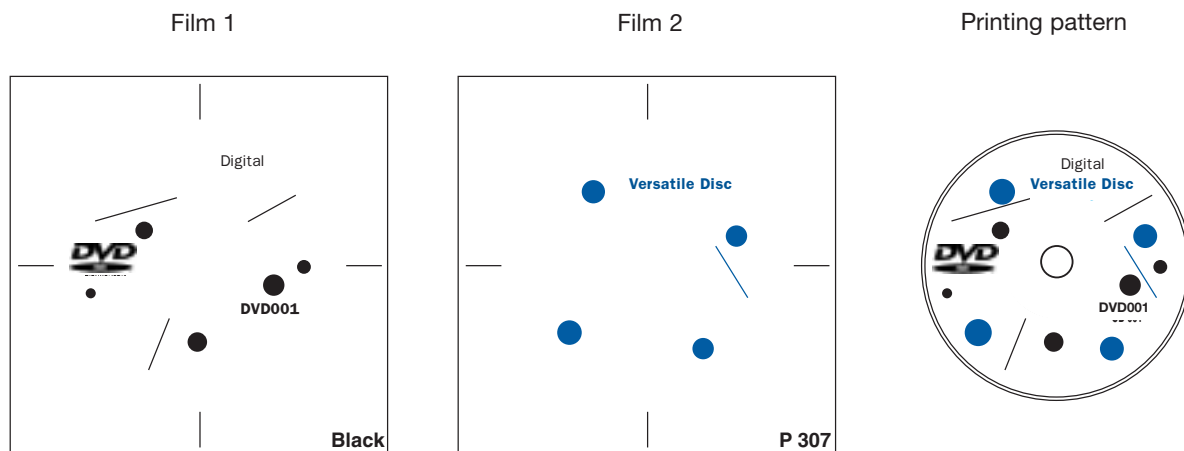
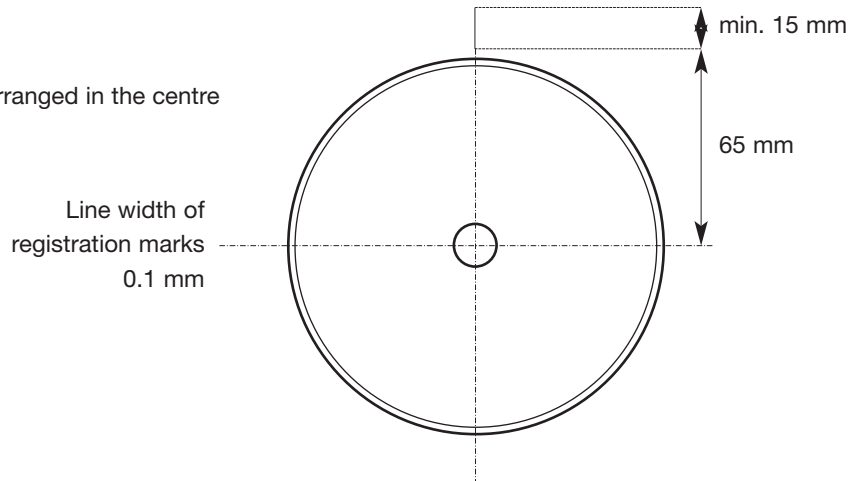

### 4.4.3 Density

To be able to process your label films optimally the minimum film density has to be 3.0 in full tone.

### 4.4.4 Print

Sony DADC requires smooth, full-page screen printing films (positive, right side reading, emulsion up) prepared as follows:

#### 4.4.4.1 Duplex/Triplex print (half-tone print) with Pantone colours

- Line width 34 l/cm
- Angle code 45°
- Max. density 15–85%
- Elliptic dot shape

For duplex and triplex prints please use the following angle codes: 0°, 15°, 45° or 75°. With other angle codes a 'moiré-free print' is not provided.

#### 4.4.4.2 Four-colour print – Picture Disc

- Line width 54 l/cm
- Angle codes:
  - cyan 75°
  - magenta 45°
  - yellow 0°
  - black 15°or angle codes similar to the Hell and Crossfield system.
- Density 15–85%
- Elliptic dot shape

In order to achieve favourable printing results, we need a compulsory colour copy such as Cromalin, Match-print, Pressmatch or test print.

Please take into account that there may be colour deviations from the original copies due to the different consistency of the base.

#### 4.4.4.3 Four-colour print – High Definition Picture Disc

- Line width 80 l/cm
- Angle codes:
  - cyan 75°
  - magenta 45°
  - yellow 0°
  - black 15°or angle codes similar to the Hell and Crossfield system.
- Registration marks to be centered only as shown in diagram page 18/chapter 4.5.

In order to achieve favourable printing results, we need a compulsory colour copy such as Cromalin, Match-print, Pressmatch or test print.

However, for all colour prints, please bear in mind that the base of the DVD consists of polycarbonate with a reflective aluminium coating and therefore there may be colour differences compared to the printwork (paper/carton). If you need absolute confirmity of colours of printed matter (printwork) and the DVD label print, we advise you to preprint a full white base on the DVD.

For Picture and/or High Definition Picture Disc printing, Sony DADC can prepare four-colour separation/litho production of the label films for you.

## 4. Labelprinting

### 4.5 Standard Contents

#### 4.5.1 Catalogue number

A catalogue number has to be printed on the DVD.

#### 4.5.2 DVD logo

Generally speaking it is recommended to put the DVD logo onto the DVD. However, if the DVD logo is placed on the DVD, the disc must comply to the DVD-Specifications. In accordance to the specifications, the DVD logo should be seen clearly on the disc. Therefore, it has to be shown in the highest possible contrast, i.e. the contrast between the logo and the background colour must not be less than 50%.

#### 4.5.3 "Made in EU"

A designation of origin is not necessary on the DVD. However, if such designation is requested, it has to be "Made in EU".

#### 4.5.4. Side Indication

For DVD 10 Sony DADC recommends to indicate the Front and the Back Side of the DVD with "Side A" and "Side B". This simplifies the handling of the DVD for end consumers.

The generic DVD logo in accordance with the DVD specification



DVD-ROM logo



DVD-Video logo



*Deviations from the standardised DVD logo are not permitted. The DVD logo must not be distorted, squeezed, decomposed, framed or composed of parts with different colours.*

### 4.6 Colours

Sony DADC uses the Pantone Matching System (PMS).

Please mark each label film with the Pantone colour number requested by you. Please select your colour from the Pantone Colour Selector 1000, except for double impression (2x) colours.

When using Pantone colours 801 to 814, preprinting should be carried out with white colour in order to achieve the luminescent effect similar to the Pantone Colour Selector 1000.

#### 4.5.5 Company address, label address

To protect your product against piracy and to clearly state the copyright holder, we ask you to indicate the company name and address on the label film or on the printwork.

Contrast between DVD logo and background not admissible



Contrast between DVD logo and background admissible



## 4.7 Label Film Data via Electronic Storage Media

Sony DADC has its own Graphics Studio with the following standard DTP (Desktop Publishing) equipment:

### HARDWARE

- Apple MAC G3
- Laser imager AGFA AccuSet 1000 with Software Taipan RIP (resolutions up to 2400 dpi)
- Laser imager AGFA Avantra 25 with Software Taipan RIP (resolutions up to 3600 dpi)
- 3M Desktop Colour Proofing System
- Drum scanner "Chromagraph S3300" (resolution up to 14000 dpi)

### SOFTWARE

- |                      |                    |
|----------------------|--------------------|
| recommended software | accepted software  |
| • Quark X-Press      | • Aldus Pagemaker  |
| • Aldus Freehand I   | • Corel Draw (DOS) |
| • Adobe Illustrator  |                    |
| • Adobe Photoshop    |                    |

### Apple Macintosh Data

If your label films are produced on an Apple Macintosh system you may transmit your designs on electronic storage media for film burn-out.

### DOS Data (Corel Draw)

If you have edited your designs under DOS, please send us a placeable EPS file in which the text is converted into curves and the image identification set is switched on.

If you have used Corel Draw, please send us the CDR file.

### Other hardware and software

If you operate another software or hardware format please contact Sony DADC's Graphics Studio (Tel. +43/(0)6246/880-448).

### The following storage media can be accepted:

- ZIP disk, JAZ disk and CD-R
- 3.5" floppy disk in Mac or DOS format
- 44/88/200 MB cartridge (5.25") in Mac format
- 270 MB cartridge (3.5") in Mac format
- MO disk 230 MB (3.5") in Mac format

### Please do not forget:

- Laser printout: Attach a print-out of a laser printer to your documents.
- Fonts: Indicate manufacturer and all display settings, if necessary enclose screen and printer fonts.
- TIFF and EPS files: All graphic files (logos, company logos etc.) have to be supplied in all cases.
- Changes: Beware of the major resolution of the laser imager with fine lines, outlines and half tones. In general these become thinner.
- Marking: Your floppy or cartridge should be marked to provide clear identification.
- Liability: We do not assume liability for incomplete or defective files. Only submit copies you have checked and stored carefully.

### DTP-labelfilm template DISC

All labelfilm templates can be downloaded as QuarkXpress file from the website: [www.sonydadc.com](http://www.sonydadc.com).

Upon request we will provide a 3.5" disk with all DVD logos and the copies of all label film specifications and printwork specifications used by us as Tiff or EPS and/or QuarkXPress files, respectively. Please contact our Customer Service department for assistance (Tel.: +43/(0)6246/880-555).

## 4.8 Label Film Data via Electronic Data Transfer

You also have the possibility to send us your data (label film and printwork) via ISDN or Internet for exposure. If you want to transmit data in such a way we ask you to inform Customer Service before the transfer commences.

### ISDN DATA TRANSFER

Please note the following:

#### Our ISDN numbers are:

+43/(0)6246/73692      +43/(0)6246/75258  
+43/(0)6246/74965

#### Hardware requirements:

All ISDN adapters, preferably the current ISDN boards:  
• Leonardo    • Planet    • 4-Sight    • Easy Transfer

#### Software requirements:

- 4-Sight Manager Version 4.3.1 or
- 4-Sight Broadcast
- Leonardo Pro

# 4. Labelprinting

## Data preparation:

Our server is ready to receive 24 hours on workdays. Prior to the data transfer, please inform our Graphics Studio (Tel.: +43/(0)6246/880-448) in order to ensure that sufficient storage space is available. With ISDN, a laser print-out is not supplied compared to data delivery on storage media. Therefore, such a laser print-out must be faxed to our Graphics Studio (Fax: +43/(0)6246/880-392).

## Data compression:

All compression algorithms available for Apple Macintosh (e.g. Stuffit, ".sit", Self Extracting Archives for MAC ".sea", Disk-Doubler, ZIP, etc.) can be used. Files edited under DOS/Windows can be compressed using PkZip or WinZip.

## Data delivery:

Place all files (copy, fonts, Tiff/EPS, info file) in a directory and mark it with your name and the date (if necessary, use abbreviations such as "Release 11.4.99").

## Enclose a text document to the files containing the following data:

- With label films: number of colours used (4c or Pantone).
- With inlay card films: indication of front and rear side.
- With other printwork films: all data required for printing (e.g. 8-page Digipack).
- Fonts and Tiff/EPS files used
- Contact address for technical inquiries (Graphics Studio tel./fax)
- Name of Customer Contact at Sony DADC
- Order Information associated with the Catalogue Number.

## INTERNET DATA TRANSFER

Due to the high transmission time (100 KB per minute) data transfer via Internet is only suited for "emergencies" such as sending missing components (including fonts, logos, Tiff or EPS files).

## Our Internet address is:

**Graphics\_Studio\_DADC@sonydadc.com**

Please inform our Graphics Studio prior to transmission (Tel.: +43/(0)6246/880-448).

## Data compression:

All compression algorithms available for Apple Macintosh (e.g. Stuffit, ".sit", Self Extracting Archives for MAC ".sea", Disk-Doubler, ZIP, etc.) can be used. Files edited under DOS/Windows can be compressed using PkZip or WinZip.

## Data delivery:

Send us an e-mail with the following information:

- Contact address for technical inquiries (Graphics Studio tel./fax)
- Name of Customer Contact at Sony DADC
- Order Information associated with the Catalogue Number.

## 4.9 Production of the Label Film

We offer the production of finished printwork and of label film by our Graphics Studio.

Sony DADC requires a layout or a sketch of your desired design with all necessary information. After label film production, you will receive a fax copy from us for production release or for modifications to be carried out. We are also able to carry out the production of the colour separations required (lithos) for four-colour printing (Picture Disc or High Definition Picture Disc). Please contact our Customer Service department for film production prices.

Please note that 2 to 3 days are needed for the production of label films.

## Please provide:

- Slides, photos, drawings
- Layout (for positioning of texts, logos, graphics, etc.)
- Colour information (in cyan%, magenta%, yellow% and black%)
- Indication of print specifications (specification F, G or H)
- Indication of printing process (screen printing or offset printing)

## 4.10 Disc Serialisation

Sony DADC Austria offers the possibility to apply an individual code number to every disc of the DVD-ROM production, e.g. for identification purposes. Your pre-selected code number is printed on to the disc during the ink-jet process.

The code number is printed in arc form approximately 5 mm from the centre hole of the disc.

The number will be printed on the read-out side and can only be seen from the read-out side. (see drawing below)

Please note that this service may result in slightly longer turn around time of your DVD-ROM order.

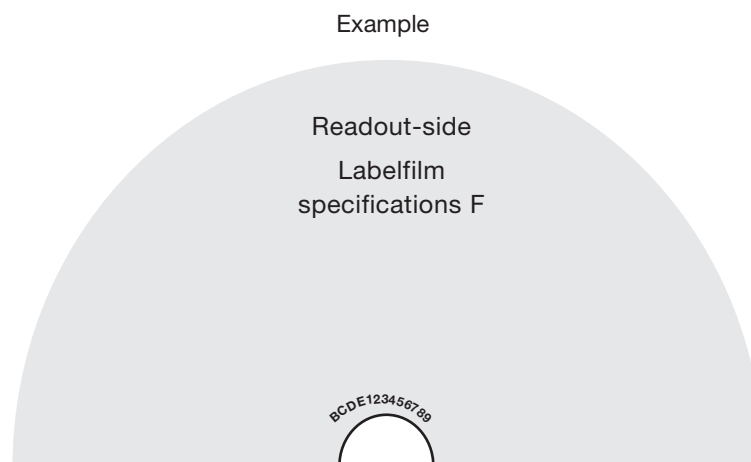

### Serialisation Specification:

- Print image: 6 x 9 dot matrix, 3 mm high, 5 characters per 10 mm.
- The series or code number may consist of a maximum of 28 characters using numbers, letters and symbols. Of the maximum 28 characters 9 characters can be changed automatically (e.g. increasing order of numbers).
- Admissible characters of the series or code number are: letters "a-z", "A-Z", numbers "0-9" and symbols (selected characters of the ISO 8859-1 set of characters). In case you need to use symbols, please get in touch with our Customer Service.
- It is not possible to underline characters
- A series or code number that changes can only be printed once on the same disc.
- Due to limitation of space on the disc surface, the series or code number can be applied in one line only.
- The selected numbers of a series or code number can be increased or reduced by any constant value. Other characters such as letters or symbols remain unchanged.
- A maximum of 9 characters can be increased or reduced.

Example:

BCDE123456789

ABC-123456789gh0m

123456789abcdef

00000-123456789-0000000

The numbers 123456789 are the characters that can be changed.

- Please do not use "bold" or "italic" characters.

Special requests (e.g. printing random numbers which can be supplied on a DOS compatible 3.5" floppy disk) should be addressed directly to our Customer Service department.

# 5. Services

As part of our full service philosophy, we can provide you with printwork and any special packaging request. Due to high yearly volumes we order with our qualified printwork suppliers, Sony DADC can offer competitive prices. If you wish to utilize this service, we request that your graphic studio provides components according to chapter 5.2., with chapter 5.3. being valid for the printwork carried out by us.

## 5.1 Printing Process

Generally, the printwork is manufactured by qualified printers in four-colour offset print and the use of additional special colours and varnishing is possible.

## 5.2 Physical Films

### Film specification

We need full-page films positive, wrong side reading, emulsion up for the offset print of packagings. Optimum screen width for these printwork films: 70 l/cm (180 lpi).

All printwork must have a catalogue number.

Page numbers on all films.

Please do not indicate origin details except "Made in EU". Other data with regard to origin are not admissible and will be removed.

Please mark each film with the correct colour specification (e.g. Black, P100C, etc).

Please arrange films in such a way that the booklet is closed at the left. With special products such as leporello, posters, etc. please enclose a confirmed folding sample.

Films must have a bleed of 3 mm. The cutting marks have to be positioned outside of the bleed.

To avoid mismatches, please supply a compulsory print target (like Cromalin, Matchprint or similar) with the films. However, please note that there may still be slight colour differences between your proof and the produced printwork.

The films should not be damaged and must be packed in a roll container or carton to prevent folding.

If you request a colour match between printwork and DVD label print, spot colours have to be specified in the same colour system (Pantone is preferred).

To protect your product against piracy and to clearly identify the copyright holder, we ask you to indicate the name and address of the music company on the label and on the printworks films.

When producing your films, please note that a base of polycarbonate with reflective aluminium coating is printed on and therefore colour differences between the printwork and the DVDs may occur.

To provide (as much as possible) a compliance of the printwork colours (e.g. booklet) with the DVD label print, we advise to preprint a full white base on the DVD.

Non-compliance with the specifications and any additional expenses caused shall be charged separately.

For artwork specifications please refer to our handbooks. You can download templates from the Sony DADC homepage or request a DTP-Service disc from our Customer Service department.

## 5.3 Digital Films

### 5.3.1 Data Sources

Sony DADC can handle the following sources for graphic data input:

- 3.5" Floppy Disk
- SyQuest Cartridge; 44, 88, 200 MB
- MO 3,5" – Magneto Optical Disc (up to 1.3 GB)
- ZIP – 100, 250 MB
- JAZ – 1 GB
- CD-R, CD-RW, DVD-R
- ISDN for large volume data transfer (more than 20 MB) with use of 4-Sight ISDN
- Manager, Leonardo Pro or EasyTransfer v3.2 software
- Internet FTP Transfer – ftp.sonydadc.com (username, password required – will be given to you on request)

Sony DADC will be happy to assist you in all kinds of data transfer. Please contact our Customer Service.

Please transmit all files in one folder with a distinct name (e.g. catalogue number) including an "info.txt" file. This file must contain the following information:

- Contact address
- Customer Service contact at Sony DADC
- Catalogue number
- Product, format
- Type of artwork, number of pages, colours
- Requested packaging



### **5.3.2 Customer Input Server**

Sony DADC is happy to be able to offer digital data transfer via internet and FTP-Server. For more information, please contact our Customer Service.

### **5.3.3 FTP Software Tools**

We highly recommend the use of (free) FTP Software Tools like WS\_FTP Pro (Win) and Fetch (Mac). You can also log on to the Sony DADC input server via an internet browser:

ftp://username:password@ftp.sonydadc.com

### **5.3.4 ISDN**

You also have the possibility to send us your data (label film and artwork) via ISDN, which is our preferred transmission method. If you wish to transmit data using this method, please ask Customer Service to get all important information, (ISDN with use of 4-Sight ISDN Manager, Wam!Net Transmission Manager, Leonardo Pro or EasyTransfer v3.2 software).

Please inform your Customer Service representative at Sony DADC after the successful transmission of all files.

Connection:

ISDN Numbers: +43/(0)6246/73692  
+43/(0)6246/75258  
+43/(0)6246/74965

All Apple/Macintosh files must be MacBinary II (.bin) or BinHex (.hqx) coded to avoid data loss.

WAM!NET tracked and managed service Transmissions for all production components graphic as well as master data are possible via our WAM!NET managed service. Please get in touch with us and we will assist you in establishing the link.

### **5.3.5 Regular Post**

Of course you may always send your input media via regular post:

Sony DADC  
Sonystrasse 20  
A-5081 Anif  
Austria

## **5.4 Important Points**

### **5.4.1 Software**

Sony DADC works on Macintosh platform with a default standard of

- QuarkXPress
- Macromedia Freehand
- Adobe Photoshop
- Adobe PageMaker
- Adobe Illustrator

CorelDraw on PC is also available. Be aware that additional costs are involved when sending CorelDraw files. We strongly recommend to use Macintosh based software only for all graphic data.

# 5. Services

## 5.4.2 Files

Besides the Quark layout, which has been used to create the artwork/CD label, you have to include all used fonts, scans, illustrations and logos. Additionally, please add a brief text file stating the most important information.

Put all files which are related to the same release in one folder. The folder must have a filename starting with the release/selection number or the name of your customer service representative.

All files must be clearly defined by their names for example:

- Booklet cover
- Booklet Innersection
- Inlaycard
- CD Label Spec A

So all components for one release are in one folder.

In this folder you will standard find the layout files, the information text file plus two other folders:

### 1. Fonts:

### 2. Images:

The folder will contain all the FINAL used images (scans, logo's, etc.)

**IMPORTANT:** Please make sure that all the images are linked to the used Quark document with the same names! This is necessary to avoid errors and extra time.

## 5.4.3 Fonts

Always include all fonts which you have used to create the job, even if you have used a font in an EPS which has been transferred to an outline.

Always send the screenfonts and the printerfonts, preferably using only PostScript Type1 fonts and not TrueType fonts.

Please do not make separate folders in this folder!

## 5.4.4 Images/Illustrations

Please make sure that you save your images (Photoshop) as a TIFF or EPS files.

Illustrations and logos should be made as EPS files. You must not use JPEG compression.

### WARNING!

EPS files are great, but they also cause the most problems when translating a piece of artwork to real printwork.

Some simple guidelines prevent a lot of problems and make production time much shorter and cheaper. Most software with an EPS as output (like Illustrator or Freehand) work with layers. The more layers you use, the higher the chance of meeting problems, especially when importing already made EPS files into another EPS file. When creating logo-like illustrations where fonts are used, always transform these fonts by creating an outline. This guarantees the exact positioning and form of all elements.

Files to be saved:

- One file with only the visible layers and the fonts transferred to outlines. Check if some layers are invisible but still in the artwork.
- Do not save 5th (fifth) or more channels to an image, rip's cannot handle these images.
- A second file with all layers and fonts still in it, this file can be used for corrections.
- Always put one illustration in an EPS
- Always put one image in a scan
- Always scan in 300 dpi (12 l/mm) for high res CMYK. Resolution is always related to the final dimensions of the image

### 5.4.5 Colours

Used colours must always be CMYK and/or Pantone colours.

You must not use RGB, Focoltone or even Pantone Process, Prosim, Uncoated, etc.

Data should always include a reference to compare with. When no laserprint, colour proof or digital soft proof in PDF format is forwarded, be aware that DADC has no tools to compare the final results to the delivered artwork.

Printer Descriptions or PDs

Several functions on scanners and DTP software are related to the characteristics of the final printing machine, these are called PDs.

For now the world makes use of films which are used to create printing plates for the printing machines.

All these PDs are related to the film, printing plate etc. Now all these technologies are changing, so all our work should be independent of these technologies.

What functions are in fact PDs?

Trapping

Trapping (Spread and Choke) is used because the now used printing technology has problems with getting all printing colours exactly in place.

UCR and PCR

UCR (Under Colour Removal) is used for getting brighter colours with less ink, PCR is a more sophisticated technology as UCR but has the same principle.

Black overprint

When putting a black text over a coloured background, especially small fonts should not be cut out of the background. This is called black overprint.

#### **WARNING:**

All these PDs should not be the concern of an Art Director, but of the one who is actually making the print work, so:

**DO NOT MAKE USE OF THESE FUNCTIONS**

Do not use trapping, unsharp masking, UCR or PCR, only black overprint of small texts is OK.

DADC will take care of the quality of your labels.

### 5.4.6 Templates

Always make use of the Sony DADC templates. These templates conform with the final measurements of all labels which are printed at DADC.

Templates for CD-labels as well as for packaging artwork can be downloaded from our internet homepage [www.sonydadc.com](http://www.sonydadc.com).

Packaging artwork must be printers pairs for saddle stitched booklets and single pages for perfect bound booklets.

Please make sure that you never change the measurements or the template descriptions, because this will generate major problems for the final product.

### 5.4.7 Overview of the most common problems

- Fonts are not delivered with the files.
- Not standard file format (see 'IMAGES')
- Images in the quark document. have other names than the original image
- Images are saved with JPEG compression
- Images with the wrong resolution (low)
- Images and logo's are not delivered
- Images are RGB instead of CMYK or Pantone
- There was no standard software used
- Wrong specifications used

### 5.4.8 Tipp

Please always check your outgoing files and documents, because errors often occur while copying files and documents from one digital carrier (desktop) to another!



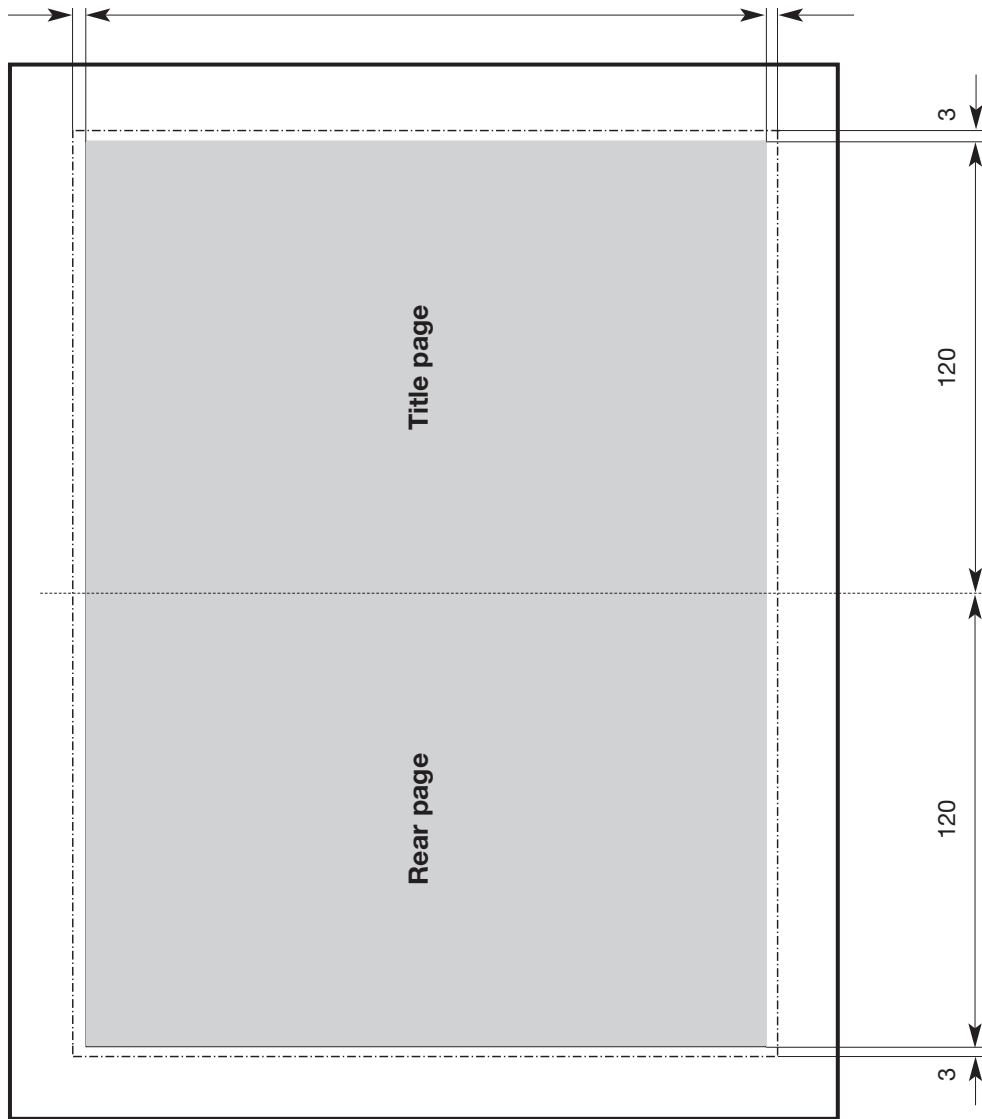

# 5. Services

## 5.5 Packaging Specifications

### Film Specifications: Booklet for DVD PLASTIC BOX



Explanation: All dimensions in mm





-  Area to be printed
-  Final dimension
-  Bleed
-  Minimum of blank film dimension (at least 20 mm distance to final dimension)

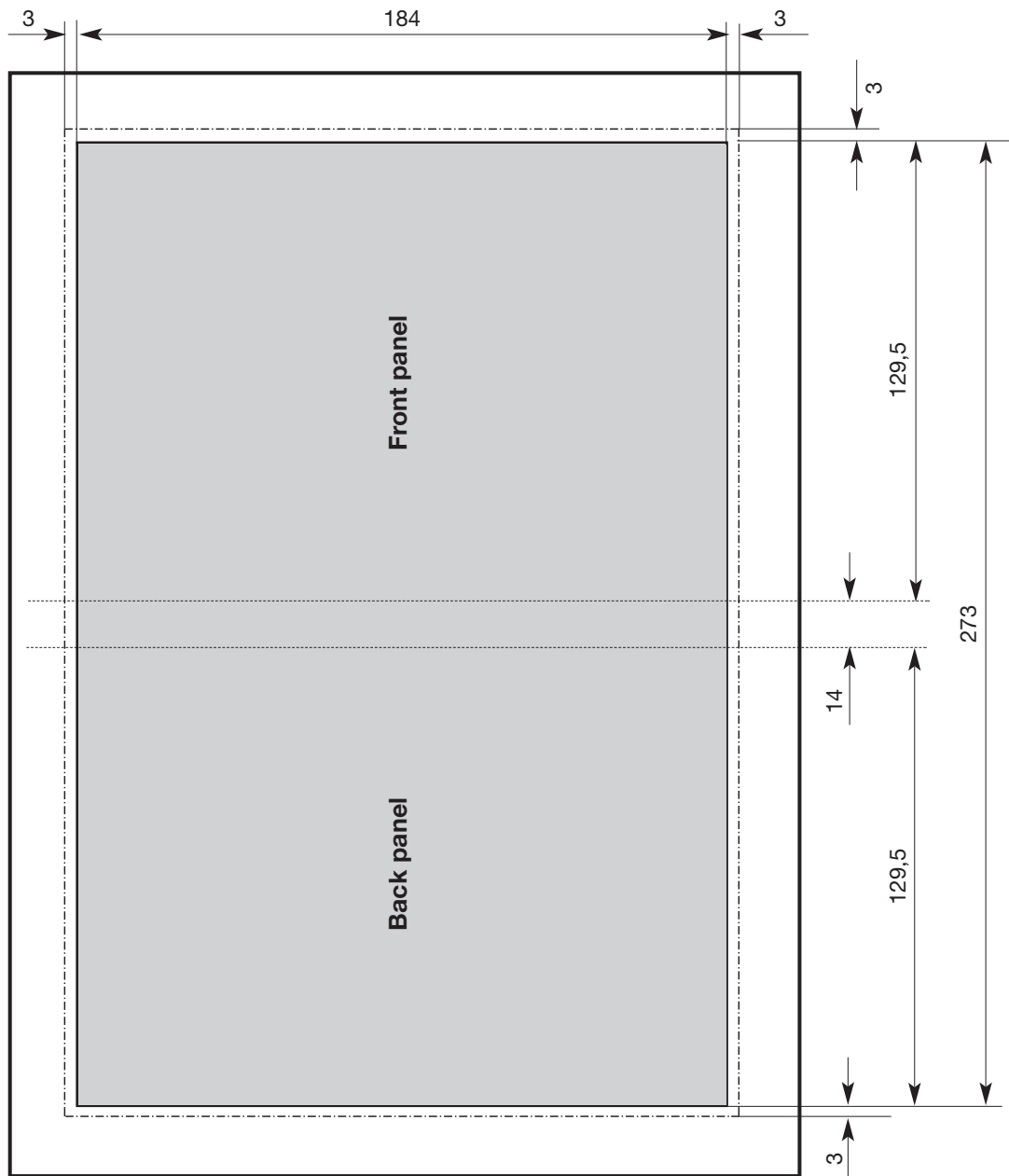

## Film Specifications: Cover Sheet for DVD PLASTIC BOX



Explanation: All dimensions in mm

-  Area to be printed
-  Final dimension
-  Bleed
-  Minimum of blank film dimension (at least 20 mm distance to final dimension)





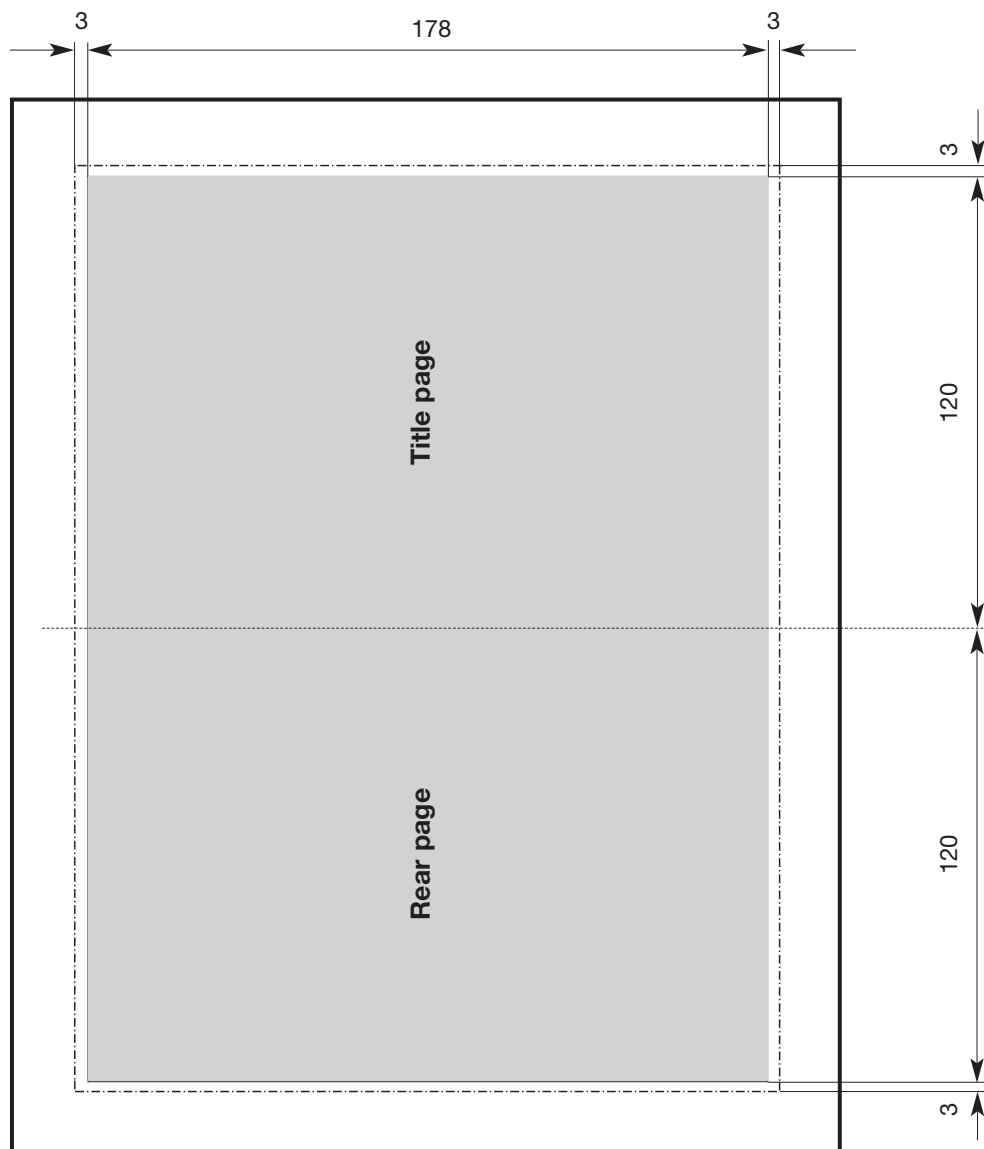

# 5. Services

## Film Specifications: Booklet for SUPER JEWEL BOX



Explanation: All dimensions in mm





-  Area to be printed
-  Final dimension
-  Bleed
-  Minimum of blank film dimension (at least 20 mm distance to final dimension)

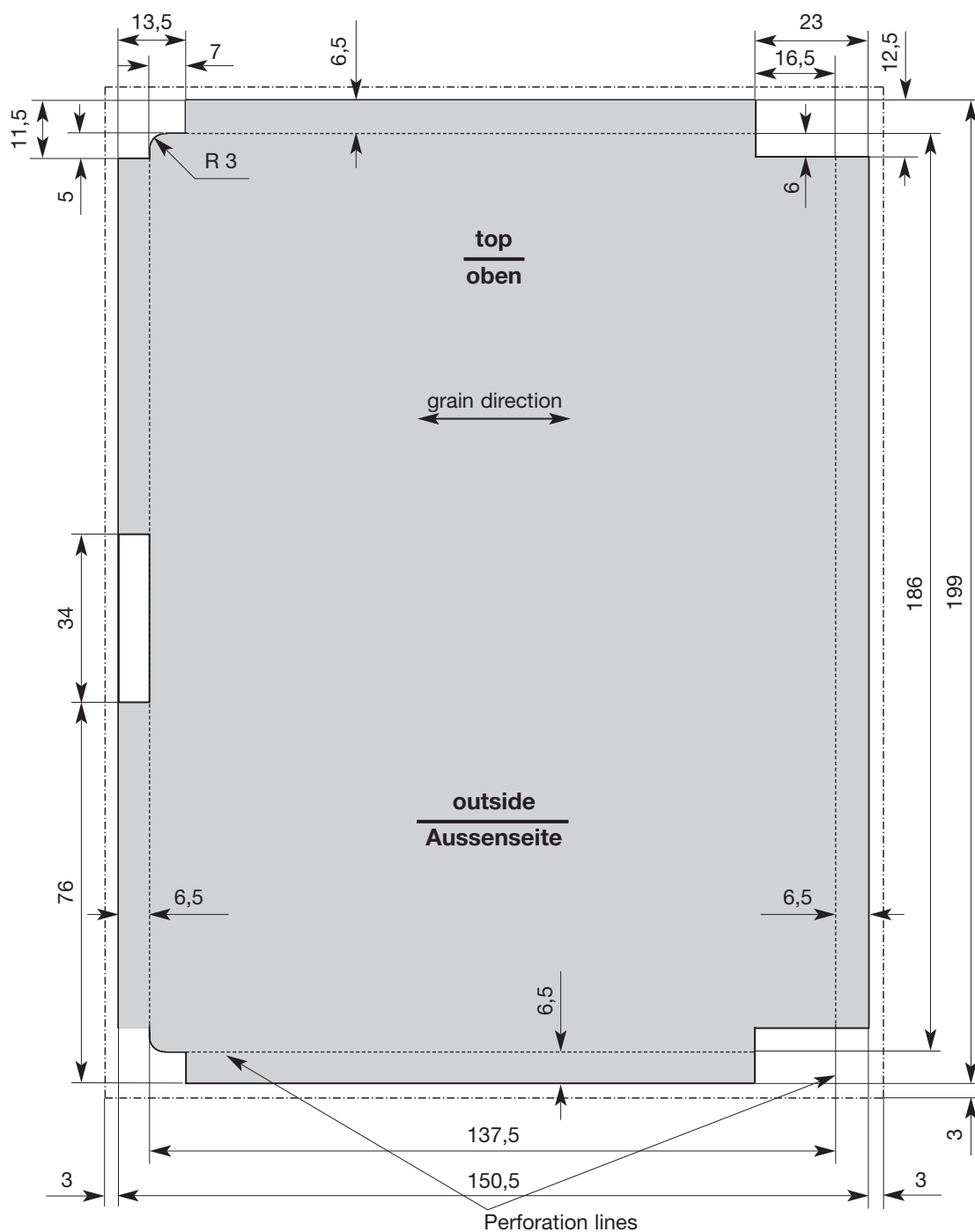

## Film Specifications: Inlay Card for SUPER JEWEL BOX



Explanation: All dimensions in mm

-  Area to be printed
-  Final dimension
-  Bleed
-  Minimum of blank film dimension (at least 20 mm distance to final dimension)



# 5. Services



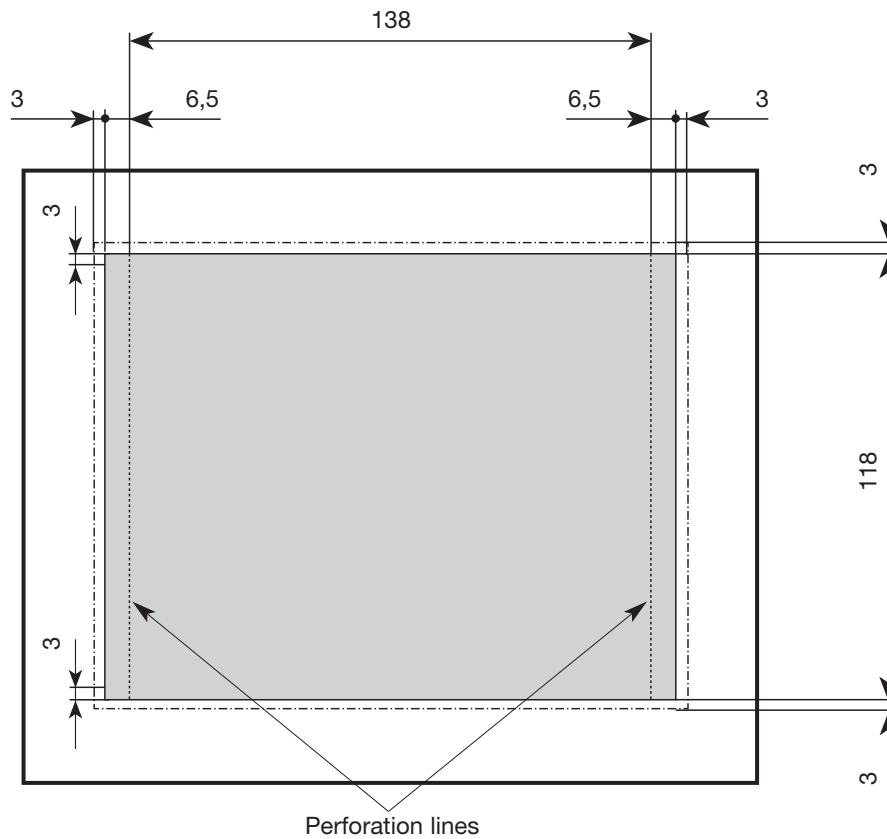

## Film Specifications: Inlay Card for JEWEL CASE

(also backliner, inlay card with perforations at the back)



Explanation:

All dimensions in mm

-  Area to be printed
-  Final dimension
-  Bleed
-  Minimum of blank film dimension (at least 20 mm distance to final dimension)





## Film Specifications: Booklet for JEWEL CASE

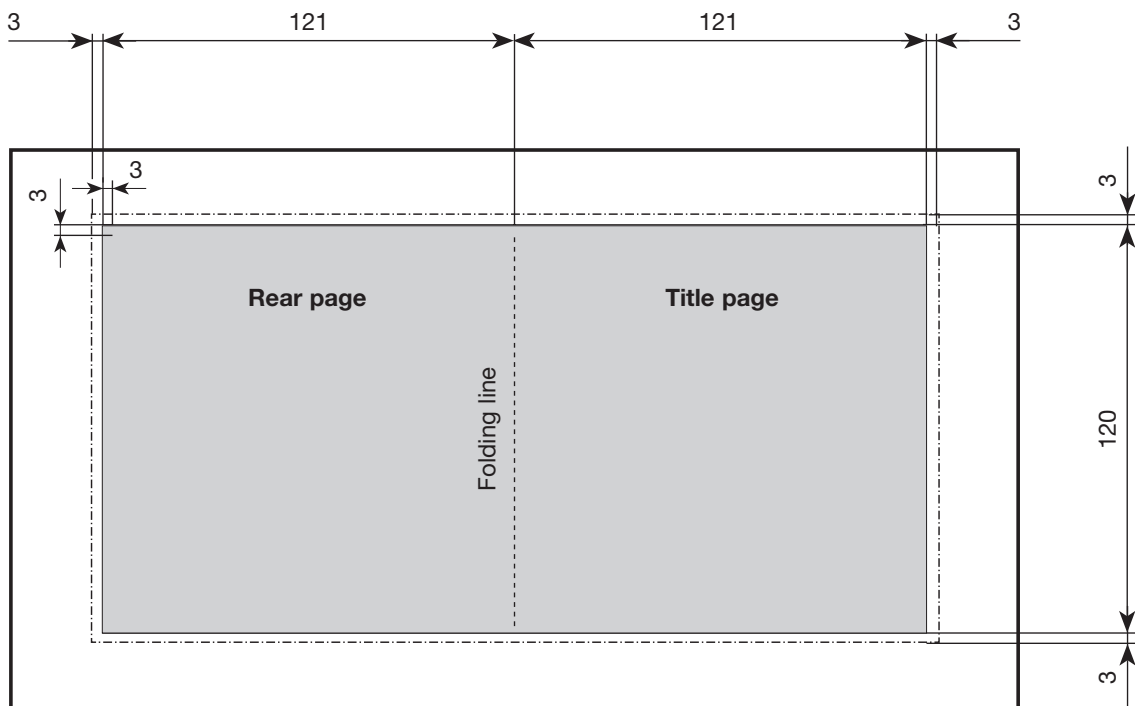

Explanation: All dimensions in mm

- Area to be printed
- Final dimension
- Bleed
- Minimum of blank film dimension (at least 20 mm distance to final dimension)



# 5. Services

## Film Specifications: ECOPAK

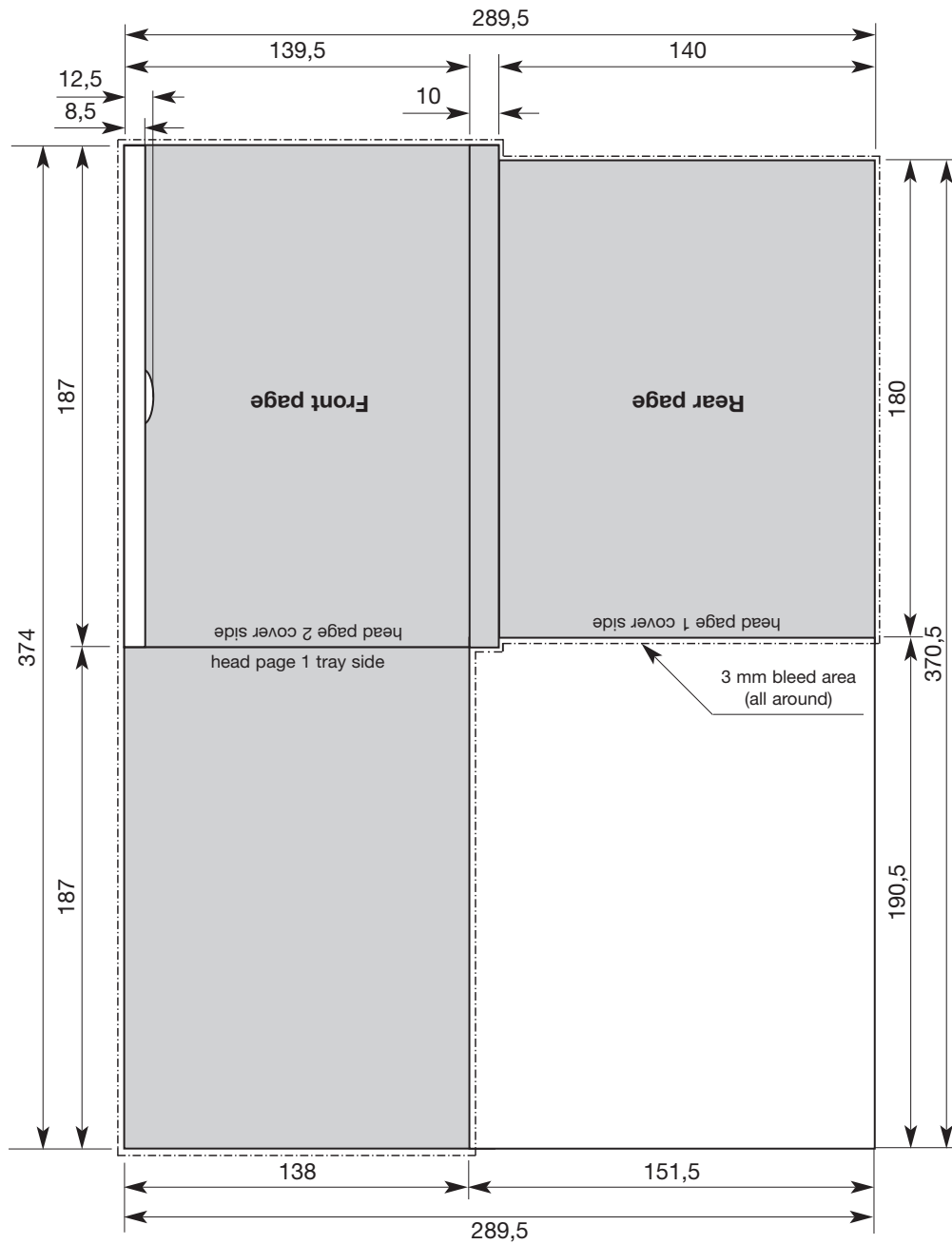

Explanation: All dimensions in mm





- Area to be printed
- Final dimension
- Bleed
- Minimum of blank film dimension (at least 20 mm distance to final dimension)

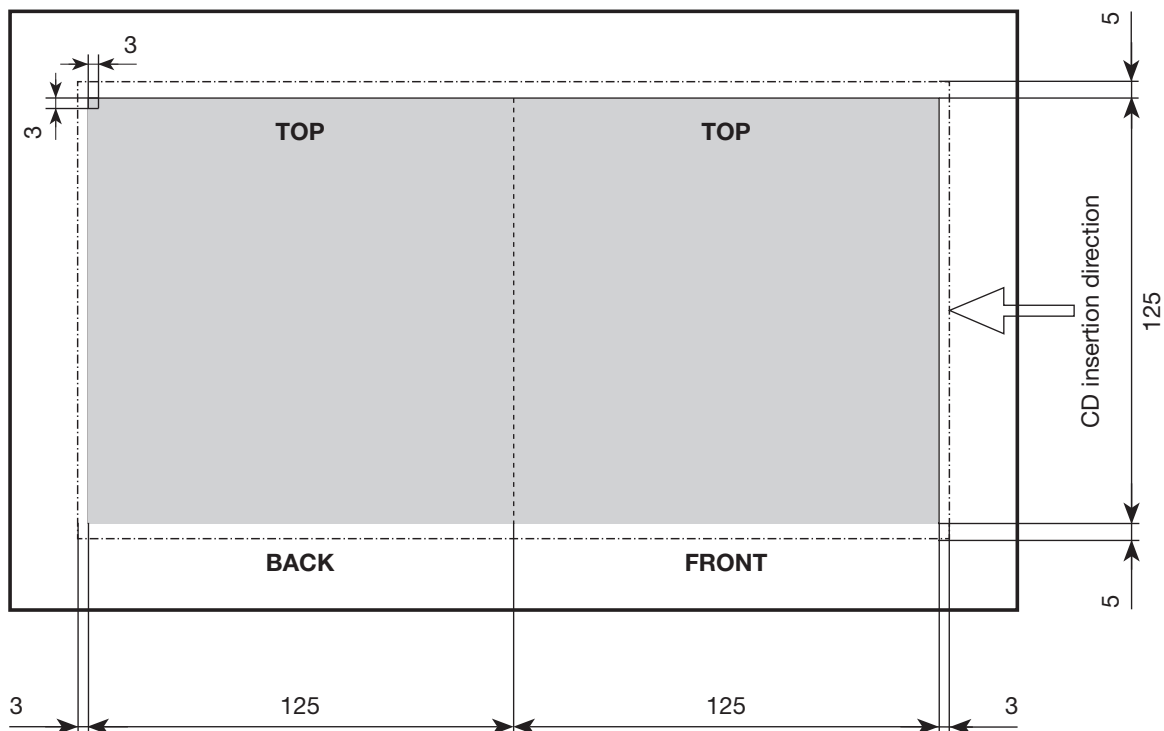

## Film Specifications: 12 cm CD CARTON SLEEVE



Explanation: All dimensions in mm

-  Area to be printed
-  Final dimension
-  Bleed
-  Minimum of blank film dimension (at least 20 mm distance to final dimension)



# 5. Services

## Digipak Index

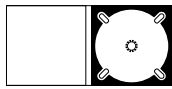

DAXXX2XX

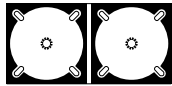

DAXXX12XX

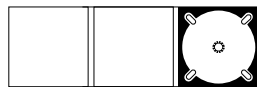

DBXXX3XX



DBXXX3XA

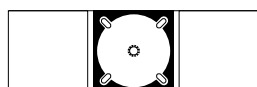

DBXXX2XX



DBXXX13X



DCXXX4XX

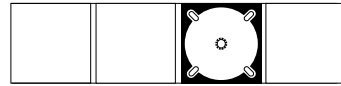

DCXXX3XX

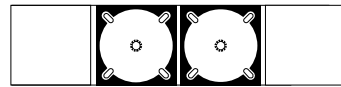

DCXXX23X

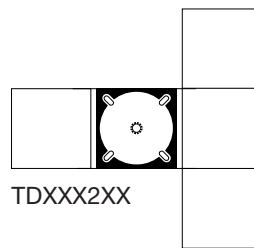

TDXXX2XX

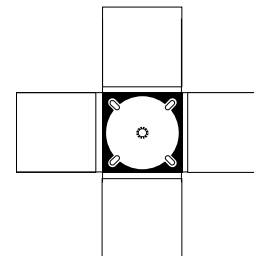

CDXXX2XX

The Digipak, which consists of a compound of plastics and carton, requires hand packaging.

### Note:

The DIGIPAK packing format is patented.

If you have any questions, please ask your Customer Service Contact, who will be pleased to provide information on the various special formats and their processing possibilities.

## DVD Digipak Index

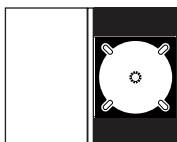

DVDAXXX2XX

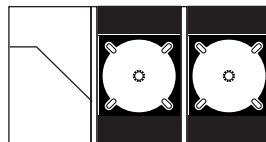

DVDB1X123X

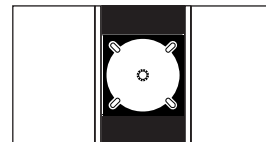

DVDBXXX2XX

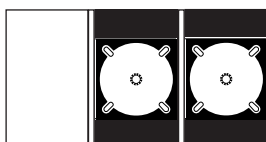

DVDBXXX23X

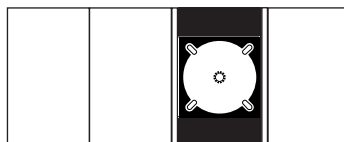

DVDCXXX3XX

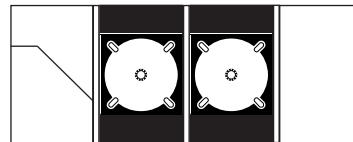

DVDC1X123X

## Stickers

Stickers are processed as self-adhesive labels supplied on rolls.

- Possible core diameter: 40 or 75 mm
- Max. possible roll diameter: 300 mm
- Eliminate punching grid (do not leave on the roll).

- Distance between the stickers: At least 3 mm.
- Position stickers with letters or various print in unwinding direction, if application is to the upper side of the box.
- Punched paper base cannot be processed further.
- Stickers not complying with the standard cannot be processed on the machine and will increase costs considerably.

### Sticker sizes to be processed on machine:

min. 10x10 or Ø 15  
max. 110x90 or Ø 90

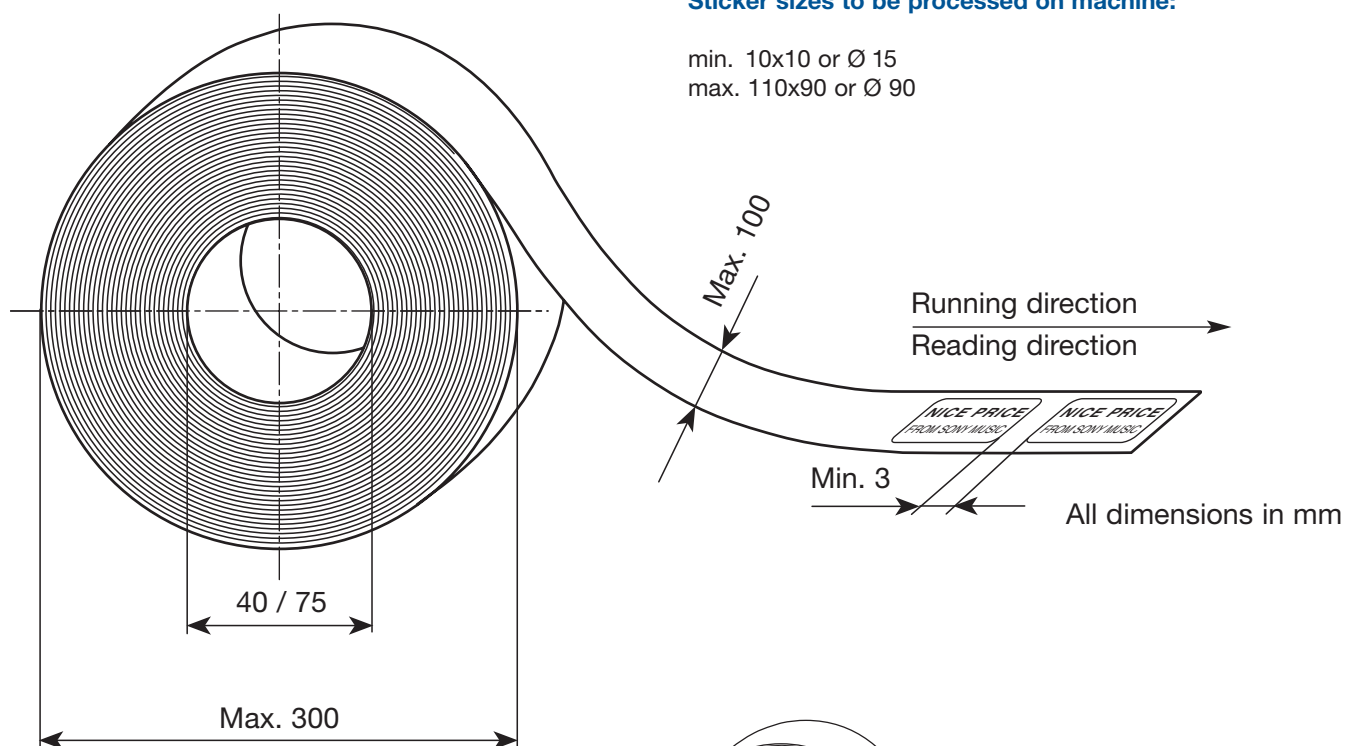

### Positioning of the sticker

V = position of the sticker on the front side (V/. /.)

H = position of the sticker on the rear side (H/. /.)

Example: V/A/1  
sticker on position A1/front side  
H/B/2  
sticker on position B2/rear side

Stickers can be processed automatically on the upper and lower side of the box. To indicate the desired position of the sticker on the box, please use the opposite diagram.

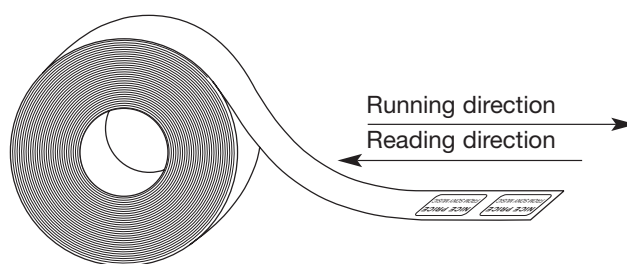

Arrangement of stickers on the roll for the lower side of the box.

# 5. Services

## Sticker - Packaging - Discription

Jewel Case		Front Side			4
		Back Side			3
				seat	2*
Carton Sleeve	open - at the right	Front Side			1
			shrink		2
		Back Side			2
			shrink		1
	open - at the top				3
		shrink			4
			seat	1/4*	
Amaray, Scanavo, Flexbox		Front Side			3
		Back Side			4
Papersleeve with flap					3
				seat	2
Manual packaging					1
Digipak		Front Side	shrink/ no shrink		3
		Back Side	shrink/ no shrink		4
Disc Box Slider					3
Super Jewel Box					1

\* The Orientation of the sticker depends on the desired text orientation.

### Sticker position Jewel Case

	A	B	C	D
1	A1	B1	C1	D1
2	A2	B2	C2	D2
3	A3	B3	C3	D3
4	A4	B4	C4	D4

### Sticker position Amaray Boxes

	A	B	C	D
1	A1	B1	C1	D1
2	A2	B2	C2	D2
3	A3	B3	C3	D3
4	A4	B4	C4	D4
5	A5	B5	C5	D5
6	A6	B6	C6	D6

**Winding Orientation**

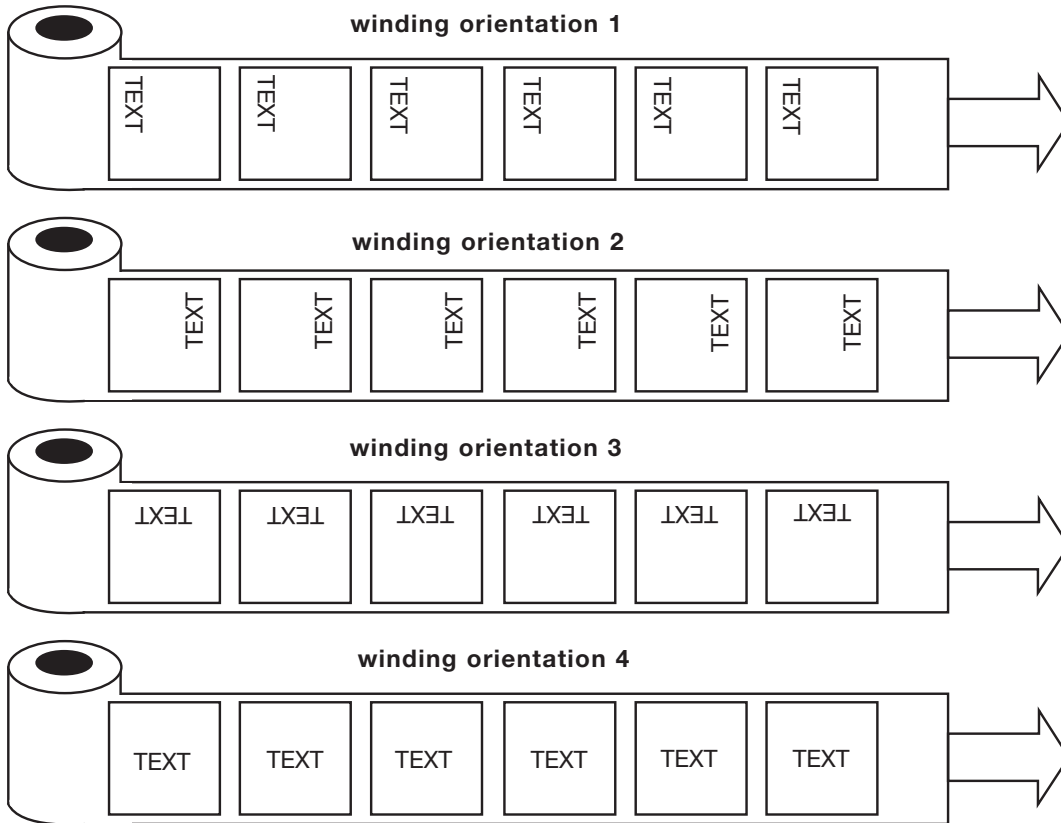

**Generell Information:**

**Standard Sticker:**

*width:* min. 10 mm, *length:* min. 15 mm  
 max. 90 mm, max. 110 mm

*round sticker:* dmin. 20 mm  
 dmax. 90 mm

**Seal on Sleeve:**

*width:* min. 15 mm, *length:* min. 15 mm  
 max. 80 mm, max. 100 mm

**Seal on Box:**

*width:* min. 20 mm, *length:* min. 20 mm  
 max. 80 mm, max. 40 mm

**Sticker on Shrink:**

*width:* min. 20 mm, *length:* min. 20 mm  
 max. 80 mm, max. 80 mm

**If you dimension your stickers, please provide the transversal length (=width) first and then the longitudinal length:**

**Example 1**

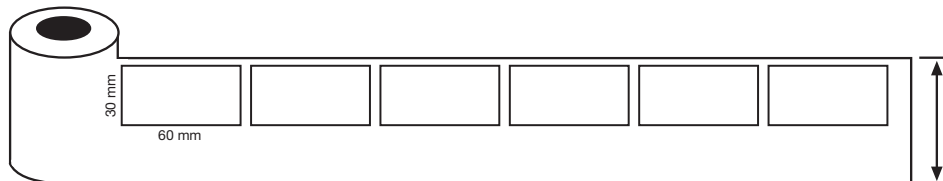

Stickerdimension: 30 x 60 mm

**Example 2**

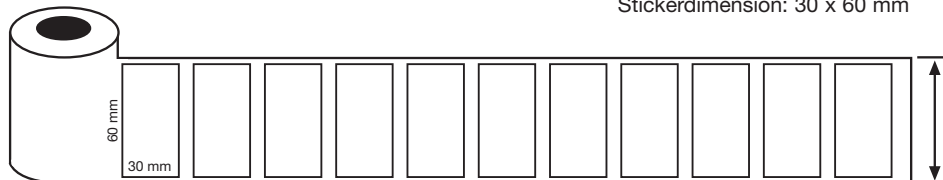

Stickerdimension: 30 x 60 mm

# 5. Services

## Packaging of supplied printwork

When supplying ready-made printwork, please note the following items:

- Delivery according to agreement

The delivery of ready-made printwork should be carried out only following previous agreement with the Sony DADC Customer Service staff.

- Printwork delivery

Your printwork delivery must comply with the Sony DADC specifications (dimensions, paper type and thickness, catalogue number, bar code, designation of origin, perforation). Since packaging is carried out automatically, please note that non compliance with the specifications causes unnecessary additional expenses and longer processing time.

Sony DADC reserve the right to charge additional costs caused by sorting, manual packaging or the return of the goods delivered.

- Minimum quantity

The minimum quantity is 300. Due to start-up losses as well as possible waste please add to your delivery an additional 10% of printwork over and above the number of DVDs ordered by you.

- Different printwork

Different printwork (such as inlay cards and booklets or various DVD titles) have to be delivered in separated cartons.

- Delivery in marked carton

If possible, delivery should be carried out in cartons (see drawing page 35) adequately marked (see label, sample carton).

- Delivery of stickers

Provide an adequate label on the carton (see sample). Furthermore, the general Sony DADC specifications for stickers shall apply.

- Storage

In the case that you deliver more printwork than your DVD order and request storage, we ask you to consult Customer Service. Storage expenses will be settled monthly according to the space required.

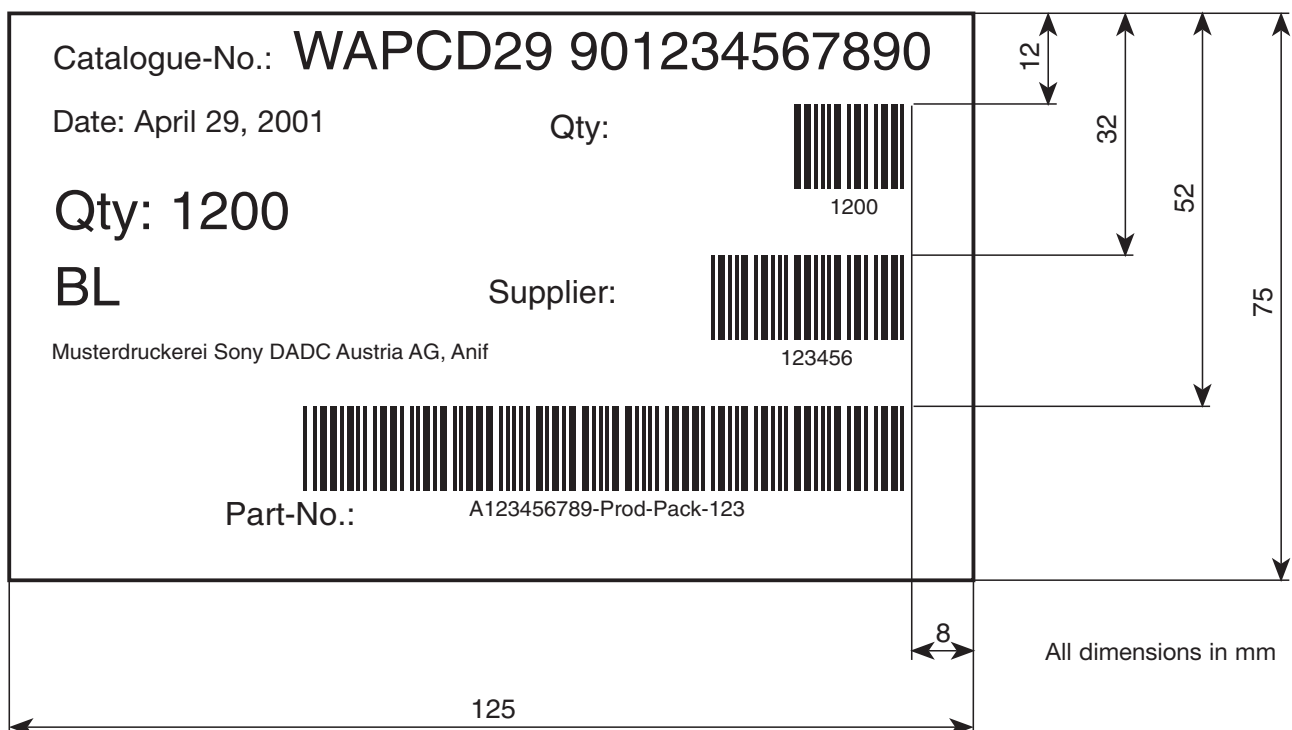



**The ready-made printwork for Booklets and Inlay-cards for Jewel Case should be delivered as follows:**

- upright (vertically or horizontally)
- uniform orientation (title sheet always in one direction)
- crash-proof multi-use carton (approx. 30 cm long)
- carton marked – catalogue number, title, company name, type of printwork, order number, number of pieces

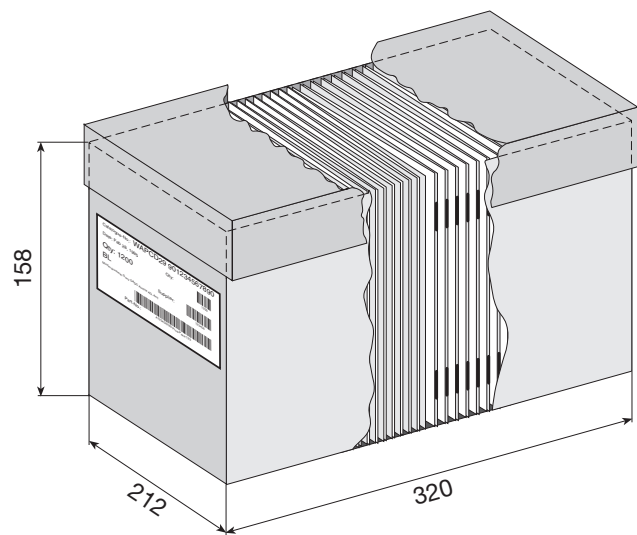

All dimensions in mm



Company: .....

Company Address: .....

Title/Catalognumber:.....

No. of Sequences/Title/Tracks: .....

.....  
Name of developing company/developer (in case data are owned by another company):

Name of the artist(s): .....

.....  
(Details see attached labelcopy or tracklist or inlaycard copy).

Herewith customer declares to possess all rights for the purpose of duplication, including the right of mechanical duplication of the software, music, video, film, data, which is on the master/data carrier input material, given to Sony DADC Austria AG. He guarantees that all copyright fees and other payable fees be paid to the owner of the rights or to the competent organisations representing the owners, and that no claims in this respect will be raised against DADC. Customer shall indemnify DADC in all respects, in particular for claims raised by third parties, including claims from Copyright Organisations or other Organisations, and for expenses arising from legal or court action for asserted or factual violation of such rights. Such indemnifications shall include production cost, if any, incurred by DADC. Customer also declares that he has read, understood and accepted Sony DADC's General Terms and Conditions.

In case of any objection by a third party upon request customer will provide Sony DADC with all necessary information concerning the rights on the original programme, data, video, music, etc., e.g. if necessary also the chain of contracts from original owner of this programme, data, video, music, etc., to the actual licensing contract. Customer confirms having an agreement with the above mentioned publishers, composers, authors, for the used data, video and music.

Sony DADC is entitled to refuse production and delivery if as a result of a circumstance become known or arising after the contract has been concluded that customers ownership or other license rights with regard to the above mentioned programmes, data, video, music, etc. are in doubt after the contract has been concluded. In such case customer will have no claim whatsoever against Sony DADC for performance or indemnification. If customers information regarding said ownership or license-rights is wrong, customer is liable to indemnify Sony DADC for any damages suffered by virtue of such wrong declaration.

The damages, which will have to be compensated by the customer, include in particular any claims raised by third parties, expenses arising from legal or court actions for asserted or actual violation of any rights to which third parties are entitled to.

Name: .....

Signature: .....

Date: .....

Sony DADC Austria AG, Customer Service, A-5081 Anif, Sonystrasse 20, Austria, Tel: +43/6246/880-555, Fax: +43/6246/880-510, e-mail: sales@sonydadc.com



# ***GENERAL TERMS & CONDITIONS***

Sony DADC Austria AG  
A-5081 Anif, Sonystrasse 20

[www.sonydvd.biz](http://www.sonydvd.biz)  
[www.press-here.net](http://www.press-here.net)

- (1) **Preamble**  
Unless otherwise agreed in writing, the General Terms and Conditions of Sony DADC Austria AG (hereinafter referred to as "DADC") shall form an integral part of all quotations and purchase contracts. Customer's purchasing conditions differing from these General Terms & Conditions shall be of no effect.
- (2) **Terms of Sale**
- (2.1.) **Quotation and Price**  
Unless otherwise agreed, the prices are understood net ex Supplier's domicile in A-5081 Anif, Sonystrasse 20, exclusive of freight and without any discount. The prices of the last quotation made by DADC shall apply.
- (2.2.) **Order and Order Acknowledgement**
- (2.2.1.) For each product-type minimum order quantities exist which are part of DADC's Customer Manual for the specific product.
- (2.2.2.) All orders from Customer to DADC must be in writing, and shall be considered accepted if confirmed in writing by DADC. Agreements, if any, with agents and/or representatives and other agreements with Customers including legally binding promises or deviations from the general terms and conditions will not be valid unless also accepted in writing by DADC.
- (2.3.) **Quantity to be delivered**  
The quantity to be delivered shall be determined by DADC's order acknowledgement in writing. Unless otherwise agreed the Customer agrees to accept production-related variations in the quantity to be delivered of more or less than 5% per title ordered. For orders of 1,000 units or less per title, the Customer shall accept production-related deviations of up to 100 units, which will be charged in the invoice.
- (3) **Delivery Time**
- (3.1.) The delivery period agreed shall commence as soon as DADC has received from the Customer all components required according to DADC's specification. Delivery shall be considered to have been made in time if the goods ordered have left the factory in A-5081 Anif or A-5303 Thalgau prior to expiration of the period of delivery.
- (3.2.) Delivery periods and delivery dates shall be understood to be without engagement.
- (3.3.) DADC shall have the right to make part deliveries and advance deliveries. A cancellation of orders by the Customer, although it might be legitimate and following an extension of the delivery period, shall not apply to part deliveries or advance deliveries made before.
- (4) **Place of Fulfilment and Passage of Risk**
- (4.1.) The place of fulfilment and passage of risk for all deliveries shall be the factory of DADC in A-5081 Anif or A-5303 Thalgau, or a distribution warehouse separately specified by DADC.
- (4.2.) The risk in respect to the goods delivered shall pass to Customer at the time they are delivered to the carrier. This also applies to part deliveries.
- (4.3.) Except as otherwise provided herein, shipment and method of shipment shall be exclusively determined by DADC. DADC shall arrange for the transport and shall pay the cost of transport packing as well as the cost of usual transport insurance for an insurance value up to the amount of the relevant DADC invoice. Other expenses, e.g. expenses for specific packing, extra cost for individual consignments, freight charges, etc. shall be for exclusive account of Customer. The Customer shall have to pay all customs duties, sales taxes, border expenses etc. even if the order for transport has been given by DADC.
- (4.4.) In the event of delay of shipment caused by circumstances within the responsibility of Customer, all risks including the risk of accidental loss shall pass to the Customer at the time DADC gives notice that the goods are ready for collection, i.e. at the time such notice is sent by DADC. In the event of delay caused by circumstances within the responsibility of Customer, the Customer will be charged storage cost of at least 5% per month of the gross invoice value, beginning at the time DADC has given notice that the goods are ready for shipment.
- (5) **Invoices and Terms of Payment**
- (5.1.) The prices agreed are understood ex DADC factory in A-5081 Anif/Austria, Sonystrasse 20, exclusive of sales tax (VAT). All payments shall have to be made in cash, free of charges and without deductions. Enforcement of counterclaims by setoff or by exercise of retention rights by the Customer shall be excluded, provided such exclusion is permitted by the laws in vigor.
- (5.2.) Payments shall not be considered to discharge the debtor unless made into DADC's banking account, except as otherwise agreed (e.g. payment by cheque).
- (5.3.) All payments shall be first counted against the expenses (dunning expenses, legal expense), then against interest accrued, and finally against the capital, i.e. against the oldest outstanding debt. Cheques and bills of exchange shall be accepted upon special agreement only, and merely on account of payment, not in lieu of payment. Cheques and bills of exchange shall be considered payment upon encashment, at the value date on which they have been credited to DADC by the bank. DADC shall have the right to refuse, without showing cause, any payment offered by cheques or bills of exchange.
- (5.4.) Unless otherwise agreed, all invoices issued by DADC shall become due for payment within 30 days from invoice date, without any deduction.
- (5.5.) The place of performance of all payments shall be A-5081 Anif/Austria, Sonystrasse 20.
- (6) **Consequences of Delayed or Refused Performance**
- (6.1.) Even after having accepted an order, DADC shall also have the right to refuse performance and/or delivery if, as a result of a circumstance become known or arising also after the contract has been concluded, there is fear that the Customer will be unable to fulfil his duties completely or in time or if the contents of the film, sound, data or other software recordings given to DADC for duplication violate laws or moral principles. Similarly, DADC shall be entitled to refuse the acceptance of the order and/or the delivery unless it is clear without doubt that the Customer disposes of all rights for duplication of the recordings concerned.
- (6.2.) Where the period allowed for payment has been exceeded, Customer shall be considered to be in default, without that any special notice has to be given by DADC. In such case DADC shall have the right to cancel all periods allowed for payment - including these for accepted bills - and to demand payment immediately. In all cases of agreements on payment in instalments, non-payment of any one instalment shall constitute default on the part of Customer, to the extent permitted by law.
- (6.3.) In the event of default of payment, the Customer shall have to pay interest on the sums due and unpaid, in the rate of the refinancing cost prevailing, but not less than 12% per annum. All extrajudicial dunning and collection expenses, including the cost of legal advisers and debt collectors, shall have to be paid by Customer.
- (7) **Delivery to Third Parties**  
Where a Customer specifies that an order given by him, or any part thereof, be shipped and invoiced to a third party (i.e. to an affiliate company of Customer or one of his distribution partners etc.), Customer shall continue to be liable towards DADC. DADC shall have the right to charge extra cost incurred for packing and transportation. If the delivery is to be carried out on behalf of a Customer by DADC directly to a third party in a non EU country, the Customer shall make available to DADC either the commercial invoice or the merchandise value which has to be paid by the third party for the assessment of the import taxes. If such delivery is carried out to a third party in an EU country, the Customer shall make available to DADC the VAT identification number of the third party prior to the delivery. If such information is not provided by the Customer or is incomplete or incorrect, he shall indemnify and hold harmless DADC in this respect, particularly with a view to any customs penalties and duties.
- (8) **Defects Liability Guarantee**
- (8.1.) In case of a complaint, the Customer shall have to provide for proper storage of the rejected goods, and to hold them at DADC's disposal until the complaint has been settled.
- (8.2.) DADC shall have the right to release itself from any claims for reasonable reduction of price by correcting defective goods and/or by supplying missing goods in a manner acceptable to Customer. Defects of a part of a shipment (order) do not give right to reject the complete shipment.
- (9) **Retention of Ownership**  
All goods delivered shall remain in DADC's property until all claims DADC may have under its relationship with Customer have been fully satisfied.
- (10) **Claims for Damages**  
Claims for damages raised by Customer for breach of contract by DADC e.g. for non-fulfilment or for default, shall be excluded unless Customer furnishes proof that the damage has been caused by gross negligence on the part of DADC.
- (11) **Rights of Mechanical Duplication, Copyrights, Author Rights, Other Rights**  
Customer declares to possess all rights for the purpose of duplication, including the right of mechanical duplication, the right to use certain film-, sound-, data- or other software recordings etc. and he guarantees that all copyright fees and other payable fees be paid to the owner of the rights or to the competent organizations representing the owners, and that no claims in this respect will be raised against DADC. Customer shall indemnify DADC in all respects, in particular for claims raised by third parties, including claims for copyright organizations or other organizations, and for expenses arising from legal or court action for asserted or factual violation of such rights. Such indemnifications shall include production cost, if any, incurred by DADC. The Customer agrees that DADC will disclose that information on individual orders to copyright utilization companies and other organizations dealing with the protection of copyrights of any kind, which is required by these companies for ensuring a proper licence settlement and/or for the control of safeguarding any copyrights.
- (12) **Miscellaneous**
- (12.1.) Customer shall furnish to DADC his specific production material, including master, label films, print films etc. corresponding to the specification given in DADC's customer manual in vigor. Where Customer furnishes production material which is not in line with applicable DADC specifications, DADC can complete, improve or return such production material at the expense of Customer.
- (12.2.) Print material delivered by the Customer can be used only if complying with DADC specifications. Except as otherwise agreed, DADC shall not be obliged to store print materials in excess of the disc-quantity ordered. Customer agrees that DADC shall not be liable for losses up to a maximum of 5% occurring during packaging, machine adjustment, disruptions etc.
- (12.3.) All material to be delivered to DADC by Customer or on Customer's behalf, shall be "delivered Anif duty paid" in accordance with INCOTERMS.
- (12.4.) After 3 months Mastertapes (CD-R, U-Matic, etc.) will either be scrapped or returned at customer's request and expense. Same procedure will apply for films (Artwork- and Labelfilms) without reorder for 2 years. The cost paid for by Customer for master and stamper production merely include the services rendered by DADC in connection therewith, while masters and stampers shall remain the property of DADC. If so requested by Customer, they will be destroyed upon completion of production. In case of a destruction, any repeat order shall be considered a new order, with all costs connected therewith.
- (12.5.) Customer guarantees that DADC will only receive duplicates of masters, label films and films for preparation of print materials. Should DADC be liable for loss or damage to such materials, such liability shall be limited to the value of material, but not exceeding a maximum value of € 1,000.
- (12.6.) In case the goods supplied by DADC are passed or sold to third parties, Customer shall have to inform such third party in regard to proper use and handling of the goods.
- (12.7.) Customer shall not have the right to use the company name of DADC or a component thereof, nor any reference to the company name of DADC on its products, notices, business or advertising materials, unless expressly agreed by DADC in writing.
- (12.8.) Austrian law shall exclusively apply to all quotations and purchase contracts, as well as to these General Terms and Conditions. DADC and Customer agree that all disputes arising out of these Terms and Conditions be referred to the courts having jurisdiction in the province capital of Salzburg, waiving any other venue of jurisdiction.
- (12.9.) Additional agreements, information and complaints shall have to be made in writing, and can be accepted only if sent to Sony DADC Austria AG, A-5081 Anif/Austria, Sonystrasse 20, for the attention of "Customer Service". Notices given to DADC shall not be legally effective unless sent to such address.

Sony DADC Austria AG  
A-5081 Anif, Sonystrasse 20  
Tel: +43/(0)6246/880-555  
Fax: +43/(0)6246/880-510  
e-mail: [sales@sonydadc.com](mailto:sales@sonydadc.com)  
[www.sonydvd.biz](http://www.sonydvd.biz), [www.press-here.net](http://www.press-here.net)

## Free Manuals Download Website

<http://myh66.com>

<http://usermanuals.us>

<http://www.somanuals.com>

<http://www.4manuals.cc>

<http://www.manual-lib.com>

<http://www.404manual.com>

<http://www.luxmanual.com>

<http://aubethermostatmanual.com>

Golf course search by state

<http://golfingnear.com>

Email search by domain

<http://emailbydomain.com>

Auto manuals search

<http://auto.somanuals.com>

TV manuals search

<http://tv.somanuals.com>