

# ***DVD Recorder***

---

Instructions For Use



DVD+ReWritable



**DVO-1000MD**

## Owner's Record

The model and serial numbers are located at the rear. Record these numbers in the space provided below. Refer to these numbers whenever you call upon your Sony dealer regarding this product.

Model No. \_\_\_\_\_

Serial No. \_\_\_\_\_



### WARNING

**To reduce the risk of fire or electric shock, do not expose this apparatus to rain or moisture.**

**To avoid electrical shock, do not open the cabinet. Refer servicing to qualified personnel only.**

**THIS APPARATUS MUST BE EARTHED.**

### Symbols on the products

	<p>This symbol indicates the equipotential terminal which brings the various parts of a system to the same potential.</p>
	<p>This symbol is intended to alert the user to the presence of important operating and maintenance (servicing) instructions in the literature accompanying the appliance.</p>

### Important safeguards/notices for use in the medical environments

1. All the equipments connected to this unit shall be certified according to Standard IEC60601-1, IEC60950, IEC60065 or other IEC/ISO Standards applicable to the equipments.
2. When this unit is used together with other equipment in the patient area\*, the equipment shall be either powered by an isolation transformer or connected via an additional protective earth terminal to system ground unless it is certified according to Standard IEC60601-1.

\* Patient Area

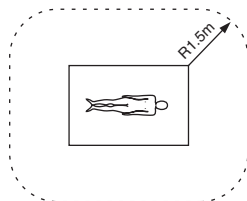

3. The leakage current could increase when connected to other equipment.
4. This equipment generates, uses, and can radiate radio frequency energy. If it is not installed and used in accordance with the instruction manual, it may cause interference to other equipment. If this unit causes interference (which can be determined by unplugging the power cord from the unit), try these measures: Relocate the unit with respect to the susceptible equipment. Plug this unit and the susceptible equipment into different branch circuit. Consult your dealer. (According to standard EN60601-1-2 and CISPR11, Class B, Group 1)

### Caution

When you dispose of the unit or accessories, you must obey the law in the relative area or country and the regulation in the relative hospital.

### WARNING on power connection

Use a proper power cord for your local power supply.

1. Use the approved Power Cord (3-core mains lead) / Appliance Connector / Plug with earthing-contacts that conforms to the safety regulations of each country if applicable.
2. Use the Power Cord (3-core main lead) / Appliance Connector / Plug conforming to the proper ratings (Voltage, Ampere).

If you have questions on the use of the above Power Cord / Appliance Connector / Plug, please consult a qualified service personnel.

### WARNING on power connection for medical use

Please use the following power supply cord.

With connectors (plug or female) and cord types other than those indicated in this table, use the power supply cord that is approved for use in your area.

	United States	Canada
Plug Type	HOSPITAL GRADE*	HOSPITAL GRADE*
Female end	E62405, E35708	LR53182, LL022442, LL088408
Cord type	E159216, E35496 Min.Type SJT Min.18 AWG	LL112007-1, LL20262, LL32121, LL84494 Min.Type SJT Min.18AWG
Minimum cord set rating	10A/125V	10A/125V
Safety approval	UL Listed	CSA

\*Note: Grounding reliability can only be achieved when the equipment is connected to an equivalent receptacle marked 'Hospital Only' or 'Hospital Grade'.

When installing the installation space must be secured in consideration of the ventilation and service operation.

- Do not block the ventilation slots at the rear, and vents of fans.
- Leave a space around the unit for ventilation.
- Leave more than 10 cm of space in the rear of the unit to secure the operation area.

## Caution

Use of controls or adjustments or performance of procedures other than those specified herein may result in hazardous radiation exposure.

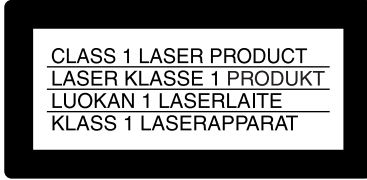

This DVD RECORDER is classified as a CLASS 1 LASER PRODUCT.

## Caution

The use of optical instruments with this product will increase eye hazard.

## Caution

The apparatus shall not be exposed to dripping or splashing and no objects filled with liquid, such as vases, shall be placed on the apparatus.

## Important

The nameplate is located on the bottom.

## For the customers in the U.S.A.

This equipment has been tested and found to comply with the limits for a Class B digital device, pursuant to Part 15 of the FCC Rules. These limits are designed to provide reasonable protection against harmful interference in a residential installation. This equipment generates, uses, and can radiate radio frequency energy and, if not installed and used in accordance with the instructions, may cause harmful interference to radio communications. However, there is no guarantee that interference will not occur in a particular installation. If this equipment does cause harmful interference to radio or television reception, which can be determined by turning the equipment off and on, the user is encouraged to try to correct the interference by one or more of the following measures:

- Reorient or relocate the receiving antenna.
- Increase the separation between the equipment and receiver.
- Connect the equipment into an outlet on a circuit different from that to which the receiver is connected.
- Consult the dealer or an experienced radio/TV technician for help.

You are cautioned that any changes or modifications not expressly approved in this manual could void your authority to operate this equipment.

All interface cables used to connect peripherals must be shielded in order to comply with the limits for a digital device pursuant to Subpart B of Part 15 of FCC Rules.

*If you have any questions about this product, you may call;*

*Sony Customer Information Service Center 1-800-222-7669 or <http://www.sony.com/>*

### Declaration of Conformity

Trade Name:	SONY
Model:	DVO-1000MD
Responsible Party:	Sony Electronics Inc.
Address:	16530 Via Esprillo, San Diego, CA 92127 U.S.A.
Telephone Number:	858-942-2230

This device complies with part 15 of the FCC Rules. Operation is subject to the following two conditions: (1) this device may not cause harmful interference, and (2) this device must accept any interference received, including interference that may cause undesired operation.

## For the customers in Canada

This unit has been certified according to Standard CSA C22.2 NO.60601.1.

---

# Table of Contents

Precautions .....	5
Copyrights .....	6

---

## Overview

Features .....	7
Location and Function of Parts .....	8
Front Panel .....	8
Rear Panel .....	11
Connection .....	13
Connecting External Equipment (1) .....	13
Connecting External Equipment (2) .....	14
Turning the Power On/Off .....	15
Setup Preparation .....	16
Selecting Either NTSC or PAL Video Signal	
System .....	16
Setting the Date and Time .....	18
Selecting the Remote Interface .....	20

---

## Recording

Handling Discs .....	22
Usable Discs .....	22
Notes on Handling .....	22
Loading and Unloading Discs .....	22
Preparations for Recording .....	24
Selecting Input Signals .....	24
Selecting the Recording Mode .....	25
Recording .....	26
Recording Titles .....	26
Marking Indexes During Recording .....	27
Using a Foot Switch .....	28
Adding Information to Titles .....	29
Pre Rec Function .....	29
When the Disc Becomes Full During Recording .	
30	
Finalizing a Disc .....	32
Formatting a Disc .....	33

---

## Playback

Playback .....	34
Usable Discs .....	34
Playback a Disc .....	34
Fast Forward or Reverse Playback .....	34
Adding Indexes During Playback .....	34
Searching for Desired Point .....	35
Jumping to a Desired Title .....	35
Jumping to a Desired Chapter .....	35
Repeat Playback .....	36
Repeat Playback Between Two Points (A-B	

Repeat) .....	36
Repeat Playback of a Chapter .....	38
Repeat Playback of a Title .....	38
Playing From the TITLE LIST Display .....	39
Verifying Information on a Disc .....	40
Viewing Frozen Pictures .....	41

---

## Editing

Editing Titles .....	42
Verifying/Editing Information About the Title .	42
Protecting a Title .....	43
Erasing a Title .....	44

---

## Menu

Menu Configuration and the Menu List .....	46
Menu Configuration .....	46
Menu List .....	46
Basic Menu Operations .....	50

---

## Miscellaneous

Messages .....	52
Error Messages .....	52
Alarm Messages .....	52
Troubleshooting .....	55
Specifications .....	56
General .....	56
Input/Output Connectors .....	56
Control Signals .....	56
Others .....	57
Using an SVRM-100A Remote Control Unit (Not	
Supplied) .....	57
Location and Function of Parts .....	57
Marking Indexes .....	58
Searching for a Particular Image - Index Scanning	
58	
Cuing a Particular Image by Specifying an Index	
Number - Index Search .....	58
Erasing an Index .....	58
Glossary .....	60
Index .....	61

---

# Precautions

## On safety

- Should any liquid or solid object fall into the cabinet, unplug the unit and have it checked by qualified personnel before operating it further.
- Unplug the unit from the wall outlet if it is not to be used for an extended period of time.
- To disconnect the cord, pull it out by the plug. Never pull the cord itself.

## On operation and storage location

Avoid operation or storage in any of the following places.

- Location subject to extremes of temperature (operating temperature range 5°C to 40°C (41°F to 104°F))
- Location subject to direct sunlight for long periods, or close to heating appliances.
- Damp or dusty places
- Location subject to severe vibrations
- Location near equipment generating electromagnetic emissions
- Location near transmitting stations generating strong radio waves
- Location exposed to dripping or splashing. Do not put objects filled with liquid, such as vases, on the unit. Splashing the unit with liquid may cause a malfunction.

## Operate the unit in a horizontal position

This unit is designed to be operated in a horizontal position. Do not operate it on its side, or tilted through an excessive angle.

## Avoid violent impacts

Dropping the unit, or otherwise imparting a violent shock to it, is likely to cause it to malfunction.

## Do not obstruct ventilation openings

To prevent the unit from overheating, do not obstruct ventilating openings, by for example wrapping the unit in a cloth while it is in operation.

## Condensation

If you move the unit from a very cold place to a warm place, or use it in a damp location, condensation may form on the optical pickup. Then, if the unit is operated in this state, the unit does not record or play correctly. When the power is turned on, the following message appears, wait until it disappears before loading a disc. On the monitor window: MOISTURE HAS BEEN DETECTED.

On the panel display: HUMID!

## When the disc is being loaded in the unit

If you give a violent shock to the unit or move it with a disc loaded because the unit is recording or playing back, the disc may be damaged. Be sure to remove a disc before moving the unit.

## On cleaning

If the casing or panel is dirty, wipe it gently with a soft dry cloth. In the event of extreme dirt, use a cloth steeped in a neutral detergent to remove the dirt, then wipe with a dry cloth. Applying alcohol, thinner, insecticides, or other volatile solvents may result in deforming the casing or damaging the finish.

## On repacking and shipping

Save the original shipping carton and packing material; they will come in handy if you ever have to ship your unit. For maximum protection, repack your unit as it was originally packed at the factory, and take care not to impact violent shocks in transit.

---

# Copyrights

- Materials played or recorded on this unit may be copyrighted. Unauthorized recording of such material may be contrary to the provisions of the copyright laws. You cannot use those materials without permission from the owners except for playing those materials for personal use.
- This unit incorporates copyright protection technology that is protected by U.S. patents and other intellectual property rights. Use of this copyright protection technology must be authorized by Macrovision, and is intended for home and other limited viewing uses only, unless otherwise authorized by Macrovision. Reverse engineering or disassembly is prohibited.
- Since this unit has a copy guard function, software and broadcasting programs that contain copy protection signals cannot be recorded on this unit.
- Since this unit has a function for prohibiting playback of not-permitted discs such as pirated discs, you cannot play such discs using this unit.

## **Exemption from responsibility for compensation for recorded data**

We will not take any responsibility for compensation for data that could not be recorded or played due to problems such as malfunction of the unit, corruption or loss of recorded or edited data, or any losses caused by such malfunctions or loss of data.

Please be aware of this policy beforehand.

Problems may occur if you perform the following operations:

- When you use a disc recorded or edited using the unit with another DVD recorder or the DVD drive of a personal computer.
- When you attempt to re-use a disc with this unit, after using it in the operations described above.
- When you use a disc recorded using another DVD recorder or DVD drive of a personal computer with this unit.

## Features

The DVO-1000MD is a DVD Recorder designed for use with video equipment such as external equipment. The DVO-1000MD compresses video signals sent from the external equipment with an MPEG-2 format and audio signals with Dolby Digital format (2CH), and records video and audio signals on a DVD+RW disc.

The following are the principal features of the unit.

### Rewritable DVD+RW <sup>1)</sup> disc as the recording media

Since rewritable DVD+RW disc is used as a removable disc, the disc is automatically finalized and discs recorded with this unit can be played on other DVD+RW players. Also, the unit searches for the first blank space automatically and starts recording from that point. Thus, it is not necessary to cue up and you can start recording right after you insert the disc.

1)  is a trademark.

### High-quality and long recording

The unit employs VBR (Variable Bit Rate) recording which varies the compressed rate of MPEG2 dynamically according to the images recorded, thereby high-quality recording relative to recording time can be realized. Also, you can select picture quality from among three recording modes: HQ (about 60 minutes: CBR (Constant Bit Rate)), SP (about 120 minutes: VBR) and LP (about 180 minutes: VBR).

### Recording indexes

You can mark indexes during recording or playback. This allows you to search for the desired points instantly during playback, and also to play a segment specified by two points repeatedly.

### High-quality audio recording

The Dolby Digital <sup>1)</sup> recording format allows you to record high-quality audio sound simultaneously with the video signals.

1) The unit is manufactured under license from Dolby Laboratories. "Dolby" and Double-D symbol are trademarks of Dolby Laboratories.

### Playback using the quick search function

- Jumping to desired titles
- Jumping to the desired indexes  
This allows you to search by indexes.

- Title list  
You can display the list of titles recorded on the disc, and using this list, you can search for the desired title from which you can start playback on the list.

### Variety of input/output interfaces

#### Digital interfaces

This unit is equipped with an i.LINK <sup>1)</sup> connector so that DV format digital video and audio signals can be input.

1) i.LINK and  are trademarks of Sony Corporation and indicate that this product is in agreement with IEEE1394-1995 specifications and their revisions.

#### Analog interfaces

This unit can also use the following analog interfaces.

- **Analog video**
  - Composite inputs (with loop-through)/output
  - S-video inputs (with loop-through)/output
- **Analog audio**
  - 2-channel inputs/outputs
  - Monitor output

#### Control interfaces

This unit is equipped with the following interfaces.

- **RS-232C interface/USB interface**  
This unit is equipped with 9-pin RS-232C which is compatible with the SVO-9500MD video cassette recorder protocol and a USB interface which is compatible with the RS-232C protocol. These interfaces provide the following new functions in addition to existing remote control functions of the unit:
  - Meta data input/output per title  
You can record meta data such as name, ID, production date from external equipment for each title.
  - Input/output of updated data in real time
- **i.LINK interface**  
Follows AV/C protocol  
You can select one from among an RS-232C interface, a USB interface, or an i.LINK interface from a menu.
- **Control using the remote control unit**  
You can use the following remote control units.
  - SVRM-100A remote control unit (not supplied)

#### Compact size

The compact size of the unit makes the unit suitable for use with medical instruments which are designed for use in limited spaces.

# Location and Function of Parts

## Front Panel

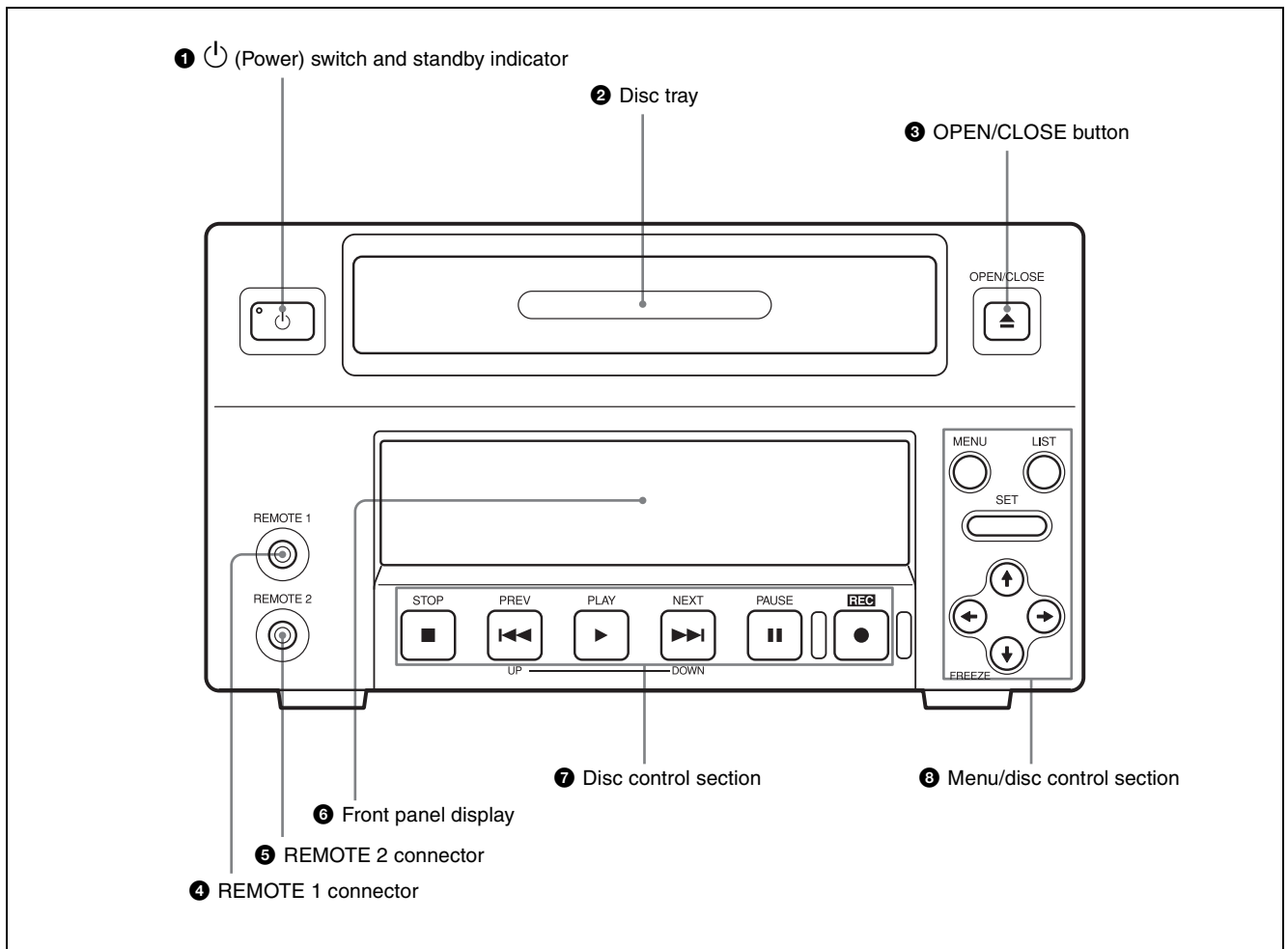

### 1 (power) switch and standby indicator

Press to power on the unit when the MAIN POWER switch (see page 11) on the rear panel is turned on. This causes the front panel display to light. Even if this switch is set to off, the indicator is lit in green when the MAIN POWER switch is set to on. To power off the unit, press this switch again.

#### Note

If the MAIN POWER switch on the rear panel is not set to on, the power is not on even if you press the (power) switch.

### 2 Disc tray

Used to insert or remove the disc.

### 3 OPEN/CLOSE button

Press to open or close the disc tray.

### 4 REMOTE 1 connector (stereo mini jack)

Connect a SVRM-100A remote control unit (not supplied) to this connector for remote control.

### 5 REMOTE 2 connector (mini jack)

Connect a foot switch (not supplied) to this connector. You can control recording and pausing using this foot switch.



## 6 Front panel display

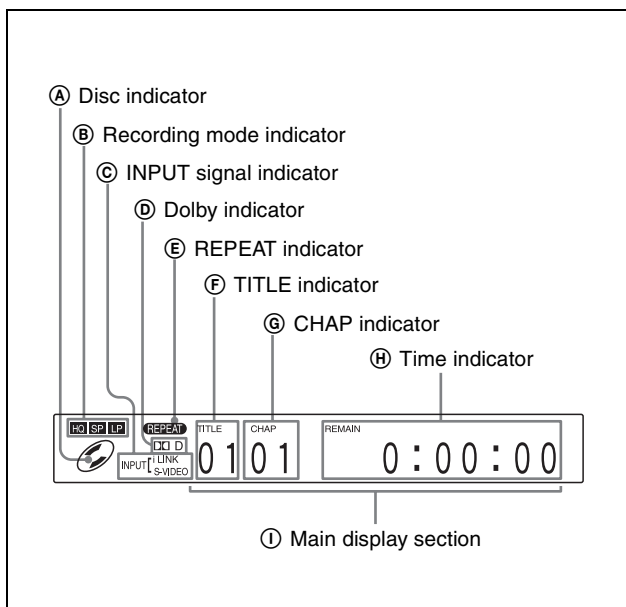

### A Disc indicator

Lights when a DVD+RW disc which can be recorded and played back with this unit is loaded in the tray. This indicator goes off when a disc tray opens.

This indicator does not light when the disc which cannot be used with this unit is loaded in the tray.

### B Recording mode indicator

Indicates the recording mode.

While a disc is being played back, the recording mode in which the disc was recorded is indicated. When recording, the selected recording mode is indicated. When a disc which has been recorded using another DVD recorder is played, none of the indicators light.

### C INPUT signal indicator

Indicates the input signal currently selected.

Input connector	Indicator
S-VIDEO IN	S-VIDEO
VIDEO IN	VIDEO
i.LINK IN (i.LINK)	i.LINK

### D Dolby indicator

Goes out when an audio signal recorded in a format other than in the Dolby Digital format is played back.

### E REPEAT indicator

Lights during repeat playback.

For detailed information on repeated playback, see "Repeat Playback" on page 36.

### F TITLE indicator

Indicates the number of the title which is being recorded or played back.

### G CHAP (chapter) indicator

Indicates the number of the chapter which is being recorded or played back.

### H Time indicator

In normal operation, the elapsed time is displayed. While recording, the elapsed time or the remaining time of the disc is displayed according to the menu setting of REC COUNTER (see page 49) of the SETUP MENU. When the remaining time of the disc is selected, "REMAIN" is lit.

### I Main display section

During menu operation or list operation, the selected item is displayed.

If an abnormal operation occurs, an error code or alarm message is displayed.

In this manual, menu operation is explained using the monitor display. On the main display section of the front panel display, the menu item currently selected on the monitor display is lit.

## 7 Disc control section

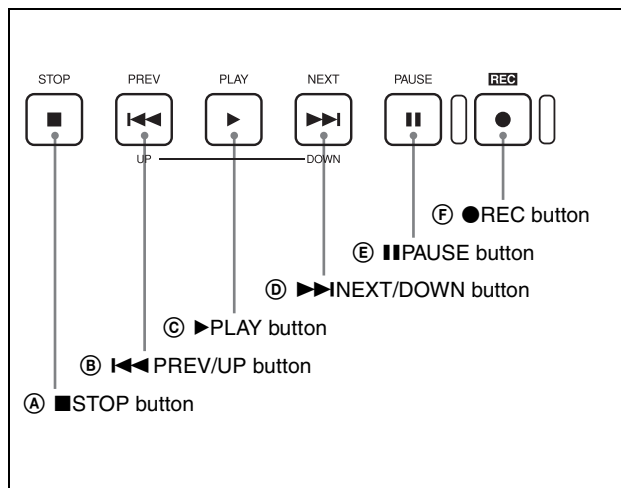

### A STOP button

Press this button to stop the recording or playback operation.

### B PREV/UP button

**PREV:** Used to jump to a chapter.

When pressed once, moves to the start point of the chapter currently being played back.

When pressed twice, moves to the start point of the previous chapter.

Pressing this button with the ►PLAY button held down allows you to view fast reverse playback at a speed three times the speed of the normal playback.

**UP:** Used to go back to the previous page during title operation in the TITLE LIST display.

- Ⓒ ▶PLAY button**  
When you press this button, it lights and playback begins.
- Ⓓ ►►INEXT/DOWN button**  
**NEXT:** Used to jump to a chapter. When pressed once, moves to the start point of the next chapter. Pressing this button with the ▶PLAY button held down allows you to view fast forward playback at a speed three times the speed of the normal playback.  
**DOWN:** Used to go to the next page during title operation in the TITLE LIST display.
- Ⓔ ■■PAUSE button**  
During playback, press this button to pause the playback operation. While paused, a still picture is displayed. Pressing this button again or pressing the ▶PLAY button allows you to restart the playback operation. During recording, press this button to pause the recording operation. Pressing this button again allows you to restart the recording operation.

**Note**

During recording, each time you press the ■■PAUSE button, indexes are automatically marked.

- Ⓕ ●REC button**  
When you press this button, this button lights and recording begins.

**Ⓖ Menu/disc control section**

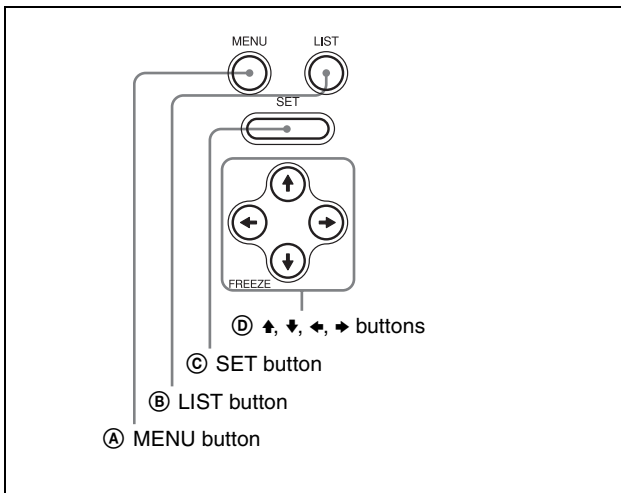

- Ⓐ MENU button**  
Used to enable the menu operation.

Press this button to display the menu on the monitor screen and the front panel display. Press it again to exit the menu display.

- Ⓑ LIST button**  
Press this button to display the TITLE LIST menu.
- Ⓒ SET button**  
Press this button to save new settings, such as selected menu items.
- Ⓓ ▲, ▼, ◀, ▶ (cursor operation) buttons**  
Used to perform menu operation. Press these buttons to select a menu item, to change numeric values, and so on.  
◀ and ▶ buttons are also used to jump to the proper point during playback operations.  
◀ button: When pressed once during playback, jumps to the start point of the title currently being played back. When pressed twice, jumps to the start point of the previous title. When pressed with the SET button during stopping, jumps to the beginning of the first title in the disc.  
▶ button: When pressed once during playback, jumps to the start point of the next title. When pressed with the SET button during stopping, jumps to the beginning of the last chapter in the disc. *For detailed information on titles, see page 26. For detailed information on chapters, see page 28.*  
▼ (FREEZE) button: When pressed the first time during playback, the picture becomes a frame frozen picture. When pressed the second time, the frame frozen picture is replaced with the frozen first field picture. When pressed the third time, the first field frozen picture is replaced with the second field frozen picture. Whenever you press the ▼ button, the frozen picture is replaced in this sequence. The FREEZE MODE item (*see page 48*) of the SETUP MENU allows you to decide whether the first frozen picture is a frame frozen or field frozen picture.

**Note**

The ▼ button does not function as a FREEZE button when the menu window or the TITLE LIST window is displayed. In those windows, this button functions only as a cursor operation button.

## Rear Panel

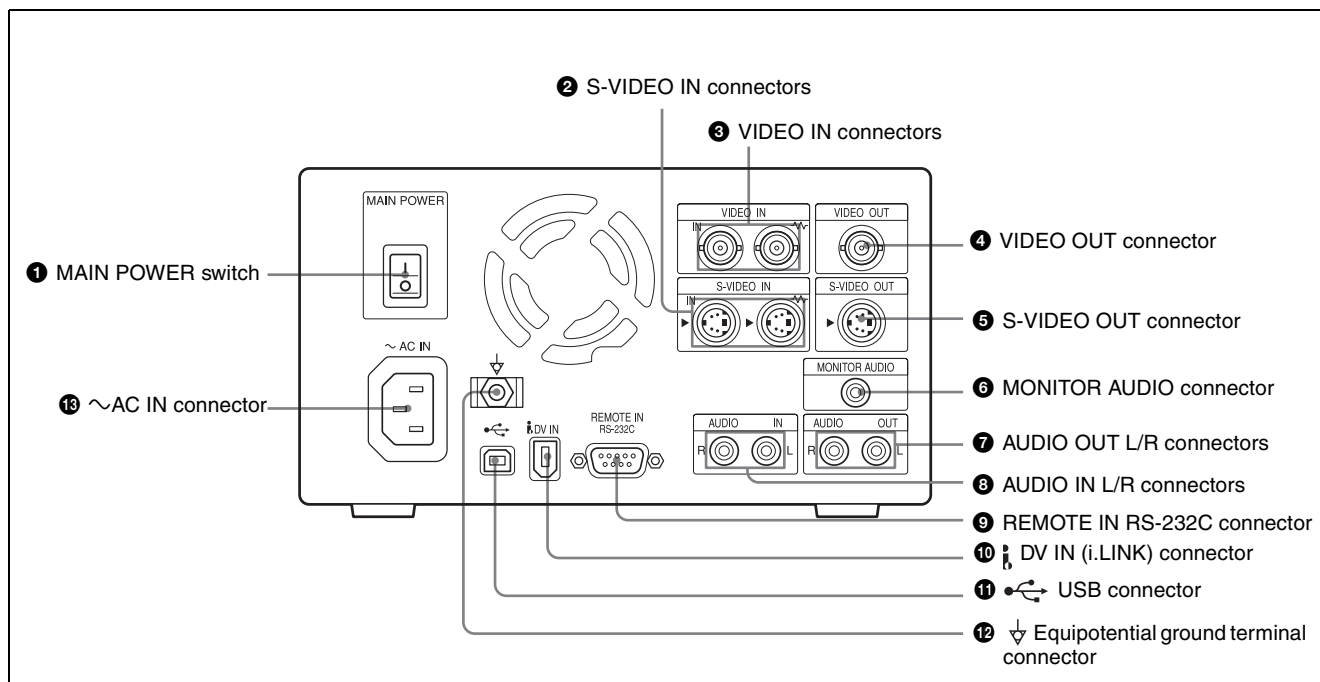

### 1 MAIN POWER switch

Switch to the **I** side to turn the power on. Switch to the **●** side to turn the power off. Normally you should leave this switch in the on position and power the unit on and off with the power switch on the front panel.

#### Note

If you need to turn the main power off when not using the unit for long periods and so on, always power the unit off with the **(power)** switch on the front panel before setting this switch to off.

### 2 S-VIDEO IN connectors (4-pin mini DIN)

The left S-VIDEO IN connector inputs analog S video signals.

The two connectors are loop-through connectors. If you connect S video input signals to the left connector, you can bridge-connect the signal to other equipment via the right connector (marked  $\sim\sqrt{r}$ ). Thus the same signals which are input to the left connector are output from the right connector to other equipment. When no connection is made to the right connector, the left connector is terminated automatically with an impedance of 75  $\Omega$ .

### 3 VIDEO IN connectors (BNC type)

The left VIDEO IN connector inputs analog composite video signals.

The two connectors are loop-through connectors. If you connect composite video signals to the left connector, you can bridge-connect the signal to other equipment via the right connector (marked

$\sim\sqrt{r}$ ). Thus the same signals which are input to the left connector are output from the right connector to other equipment. When no connection is made to the right connector, the left connector is terminated automatically with an impedance of 75  $\Omega$ .

### 4 VIDEO OUT connector (BNC type)

This connector outputs analog composite video signals.

### 5 S-VIDEO OUT connector (4-pin mini DIN)

This connector outputs the analog S video signals.

### 6 MONITOR AUDIO connector (phono jack)

This connector outputs monaural audio signals for monitoring.

The audio signals to be output from this connector can be selected among from audio channel 1, audio channel 2, or mixed audio signals, using AUDIO MON CH (see page 47) of the SETUP MENU.

### 7 AUDIO OUT L/R connectors (phono jack)

These connectors output analog audio signals.

### 8 AUDIO IN L/R connectors (phono jack)

These connectors input analog audio signals.

### 9 REMOTE IN RS-232C connector (9-pin)

This is a 9-pin RS-232C interface which is compatible with the SVO-9500MD video cassette recorder protocol.

Use this connector to control this unit by connecting it to equipment such as an external equipment which supports the RS-232C interface.

- ⑩ **Ⓜ DV IN (i.LINK) connector (6-pin)**  
This connector inputs digital video signals conforming to the i.LINK protocol.  
Also, this connector is used to control this unit by connecting it to equipment such as an external equipment which supports i.LINK.
- ⑪ **↔ USB connector**  
This connector is used to control this unit by connecting it to equipment such as an external equipment which supports a USB interface.  
This connector is USB 2.0 which supports Full-speed USB (12Mbps).
- ⑫ **⚡ Equipotential ground terminal connector**  
This connector is used to connect to the equipotential plug to bring the various parts of the system to the same potential.  
*See “Important safeguards/notices for use in the medical environments” on page 2.*
- ⑬ **~AC IN connector**  
Use power cord suitable for your local power supply (not supplied).  
*See “WARNING on power connection” and “WARNING on power connection for medical use” on page 2.*

# Connection

## Notes

- Before making connections, be sure to turn the power of any peripheral equipment off.

- Connect the AC power cord last.

## Connecting External Equipment (1)

This section gives a connection example to operate the unit connected to external equipment using a remote control unit (not supplied) and/or foot switch (not supplied).

### Settings required for using this connection example

Make the following settings before operating in this connection example using SETUP MENU.

For detailed information on menu operation, see “Basic Menu Operations” on page 50.

#### • Audio output selection

Select the audio output channel using the AUDIO MON CH sub menu of SETUP MENU (see page 47).

- LCH: Outputs the audio signal of audio channel 1.
- RCH: Outputs the audio signal of audio channel 2.
- MIX: Outputs a mixed audio signal from both channel 1 and channel 2. (factory setting)

#### • Input signal selection

Select the input signal “ANALOG” using the INPUT SELECT sub menu of SETUP MENU (see page 24).

#### • Foot switch mode selection

Select the operation mode of the foot switch from among LOW EDGE (factory setting), HIGH EDGE and LOW ACTIVE (see page 28).

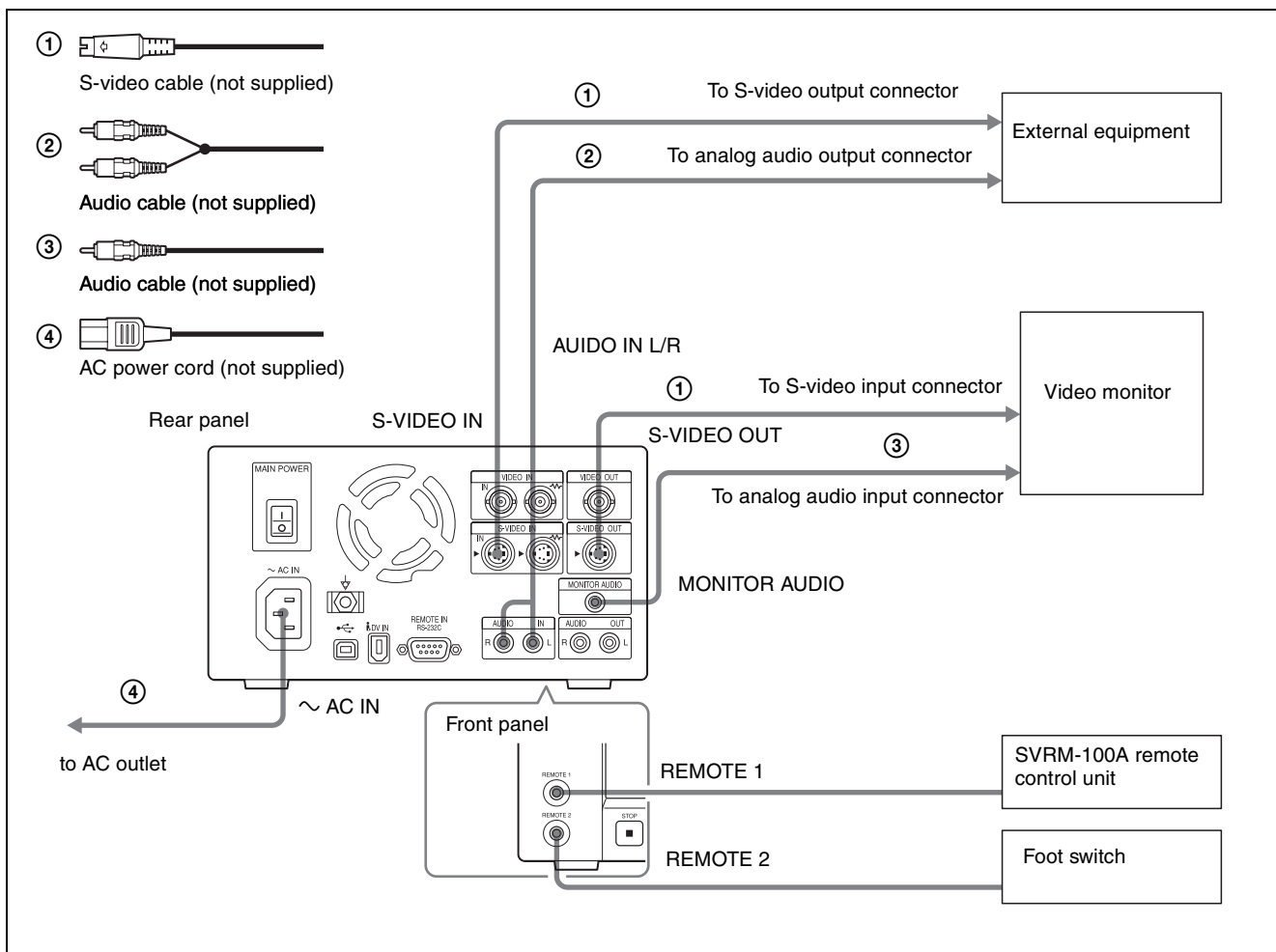

## Connecting External Equipment (2)

This section gives an example to connect external equipment for controlling the unit from connected external equipment

### Settings required for using this connection example

Make the following settings before operating in this connection example using SETUP MENU.

For detailed information on menu operation, see "Basic Menu Operations" on page 50.

#### • Audio output selection

Select the audio output channel using the AUDIO MON CH sub menu of SETUP MENU (see page 47).

– LCH: Outputs the audio signal of audio channel 1.

– RCH: Outputs the audio signal of audio channel 2.  
 – MIX: Outputs a mixed audio signal from both channel 1 and channel 2. (factory setting)

#### • Input signal selection

Select the input signal "ANALOG" using the INPUT SELECT sub menu of SETUP MENU (see page 24).

#### • Remote control mode selection

Select an interface to control the unit from among RS232C (factory setting), USB and iLINK (see page 20).

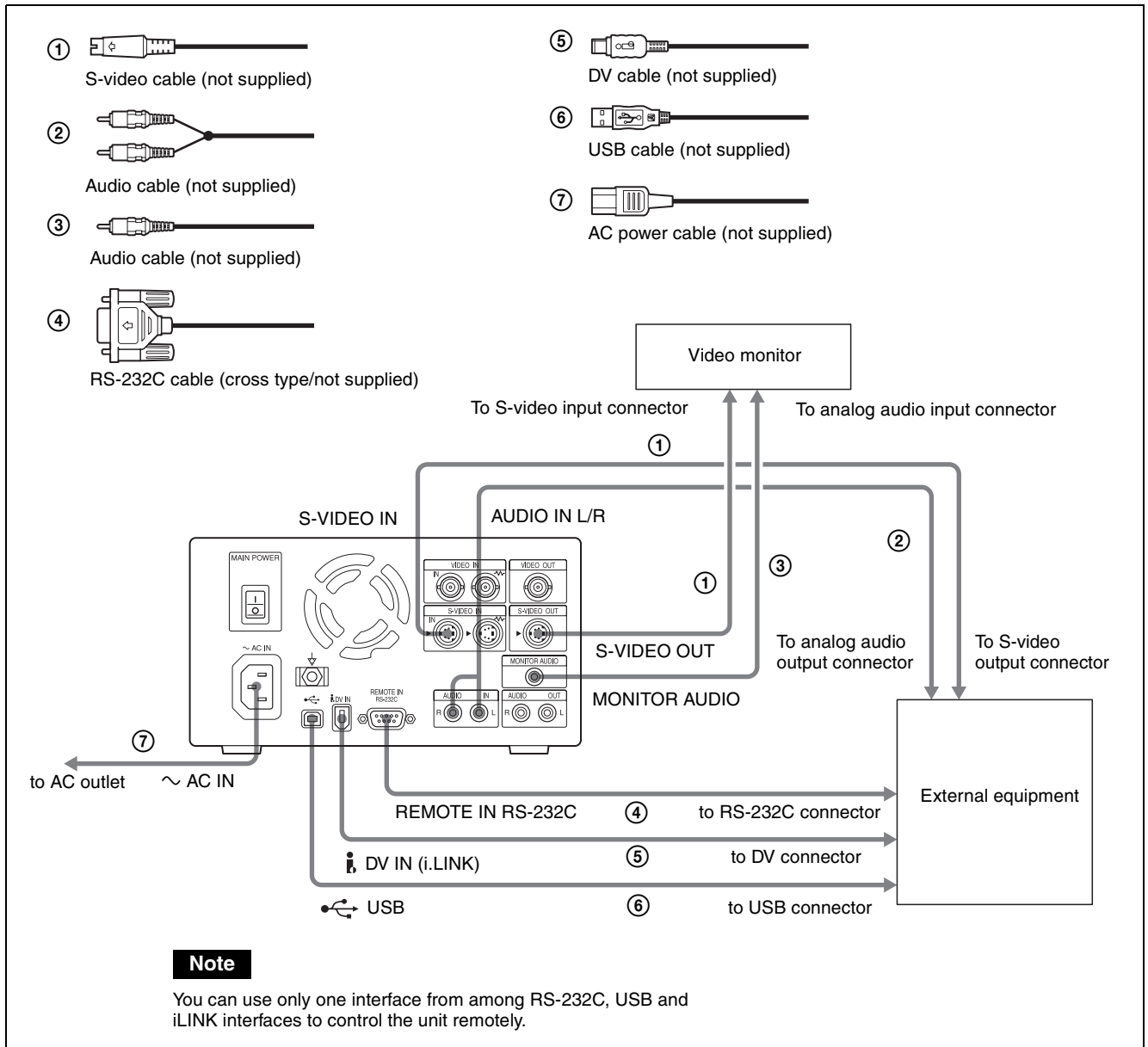

When controlling the unit, only one interface is available from among RS232C (factory setting), USB and iLINK.



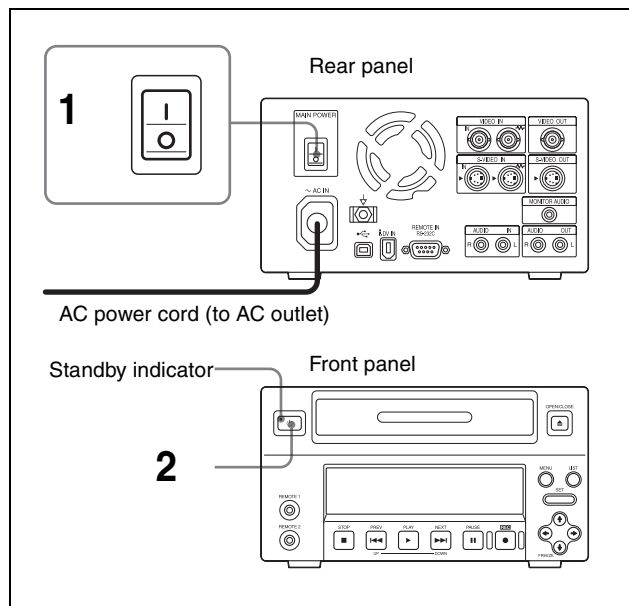

# Turning the Power On/Off

## Turning the Power On



- 1 Push the  (power) switch on the front panel to put the unit in the standby mode.
- 2 Set the MAIN POWER switch on the rear panel to the  (off) side.  
The standby indicator on the front panel goes off and the power is turned off.

- 1 Connect the AC power cord (not supplied) to the wall outlet, and then set the MAIN POWER switch located on the rear panel to the  (on) side.  
The standby indicator on the front panel lights in green.
- 2 Push the  (power) switch on the front panel.  
The power of the unit is turned on and the front panel display lights. The message “Welcome” appears on the front panel display. Then, the message changes to “Now loading...” When the message changes finally to “NO DISC!,” you can start the next operation.  
When a disc is loaded in the unit, “0101 0:00:00” is displayed instead of “NO DISC!.”

### To turn the power on or off during normal operations

Turn the power on or off using the  (power) switch on the front panel.

When you push the  (power) switch again, “Good Bye” appears on the front panel display and then the front panel display goes off and the power is turned off. Then, the unit turns to the standby mode.

### Turning the Power Off

If you do not intend to use the unit for a long period, turn the main power of the unit off.

# Setup Preparation

Before you start to use the unit after you have made the required connections, it is necessary to perform the following operations.

- Selecting either NTSC or PAL video signal system  
Select the video signal system used in your region.  
*For detailed information, see “Selecting Either NTSC or PAL Video Signal System” (page 16).*
- Setting the date and time  
You should set the date and time when you start the unit for the first time.  
*For detailed information, see “Setting the Date and Time” (page 18).*
- Selecting the remote interface  
Select the remote interface to be used to control the unit remotely. At the factory, RS232C is selected as the default. If you want to use either USB or i.LINK, change the remote interface setting.  
*For detailed information, see “Selecting the Remote Interface” (page 20).*

## Selecting Either NTSC or PAL Video Signal System

When you use the unit for the first time, you should select the video signal system. The TV SYSTEM sub menu of the ENHANCED MENU of the SETUP MENU allows you to select either the NTSC or PAL video signal system.

*For detailed information on menu operations, see “Basic Menu Operations” (page 50).*

### Note

At the factory setting, the NTSC video signal is selected as the default. Even if your monitor does not correspond to the video signal system currently selected, you can carry out the menu operations using the main display section of the front panel display.

Select the proper video signal system corresponding to the one used in your area.

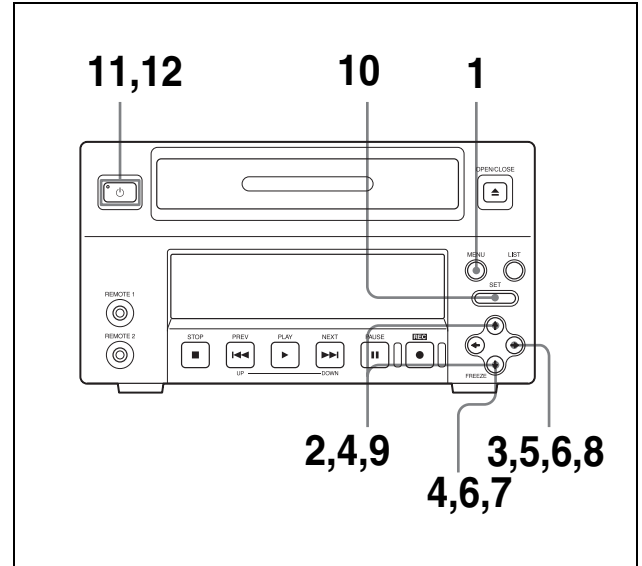

- 1 Press the MENU button.

The TOP menu appears.

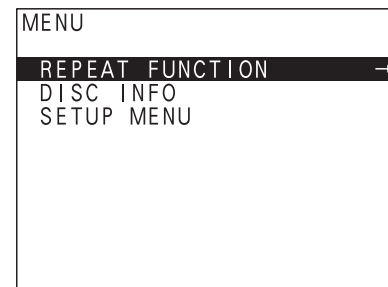

- 2 Select “SETUP MENU” by pressing the ↑ or ↓ button.

“SETUP MENU” is highlighted.

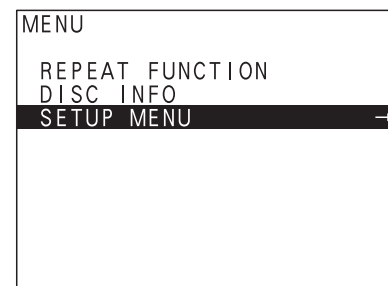

- 3 Press the → button.



The SETUP MENU appears.

```

SETUP MENU (1/2)
←REC MODE :SP →
AUDIO MON CH:MIX
INPUT SELECT:ANALOG
REMOTE I/F :RS232C
KEYBOARD :OFF
BAUDRATE :19200
FOOT SW :LOWEDGE
AUTO INDEX :OFF
AUTO TITLE :ON
KEY INHIBIT :OFF
    
```

- 4** Select “MENU GRADE” from the SETUP MENU display.

Each time you press the ↓ or ↑ button, the highlighted cursor moves down or up item by item. When the highlighted cursor reaches the last item “KEY INHIBIT,” press the ↓ button again. The next page of the SETUP MENU appears. Press the ↓ button several times until “MENU GRADE” is highlighted.

```

SETUP MENU (2/2)
FREEZE MODE :FRAME
DISC END :EJECT
REGION CODE :2
PRE REC :OFF
B/W MODE :OFF
DATE/TIME PRESET
←MENU GRADE :BASIC →
    
```

- 5** Press the → button. The following display appears.

```

SETUP MENU (2/2)
MENU GRADE
ENHANCED
←BASIC
    
```

- 6** Select “ENHANCED” by pressing the ↓ button. Then, with “ENHANCED” highlighted, press the ← button.

The following display appears when enhanced menu items have been added under the last item of the basic setup menu.

```

SETUP MENU (2/3)
FREEZE MODE :FRAME
DISC END :ENDSTOP
REGION CODE :2
PRE REC :OFF
B/W MODE :OFF
DATE/TIME PRESET
←MENU GRADE :ENHANCED →
TV SYSTEM :NTSC
232C STOP :REC PAUSE
232C FF/REW :NEXT/PREV
    
```

- 7** Select “TV SYSTEM” by pressing the ↓ button.

```

SETUP MENU (2/3)
FREEZE MODE :FRAME
DISC END :ENDSTOP
REGION CODE :2
PRE REC :OFF
B/W MODE :OFF
DATE/TIME PRESET
MENU GRADE :ENHANCED
←TV SYSTEM :NTSC →
232C STOP :REC PAUSE
232C FF/REW :NEXT/PREV
    
```

- 8** Press the → button. The TV SYSTEM sub menu appears.

```

SETUP MENU (2/3)
TV SYSTEM
←NTSC
PAL
    
```

- 9** Select the desired video signal system by pressing the ↑ or ↓ button.

The selected video signal system is highlighted.

TV SYSTEM	Content
NTSC	To record or play back with the NTSC video signal system. (Factory setting)
PAL	To record or play back with the PAL video signal system.

- 10** Press the SET button.

The message “NOW SAVING....” appears and the unit starts to save the setting.

When saving is completed, the message disappears. Then, “TV SYSTEM WAS CHANGED PLEASE POWER OFF!” appears on the monitor display, and “POWER OFF!” appears on the front panel display.

**Note**

The TV system is not changed even if you push the SET button. Be sure to turn the power of the unit off and on as described in steps 11 and 12 to change the system.

- 11** Press the  (power) switch on the front panel to turn the power off.

The message “Good Bye” appears on the front panel display. Then, the front panel display goes off, the power is turned off and the unit enters the standby mode.

- 12** Press the  (power) switch again to turn the power on.

## Setting the Date and Time

The DATE/TIME PRESET sub menu of the SETUP MENU allows you to set the date and time.

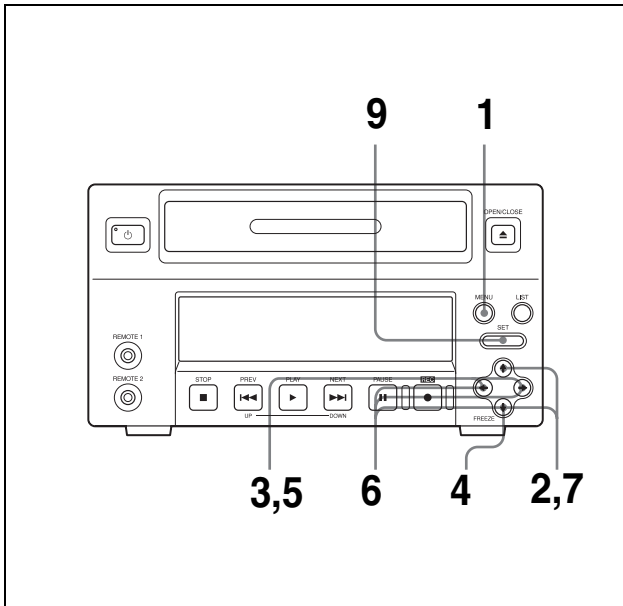

- 1** Press the MENU button.

The TOP menu appears.

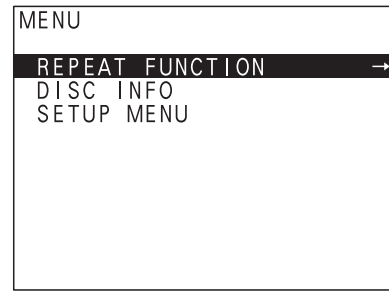

- 2** Select “SETUP MENU” by pressing the  or  button.

“SETUP MENU” is highlighted.

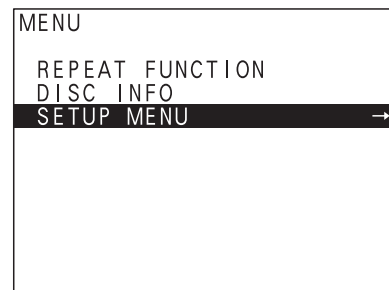



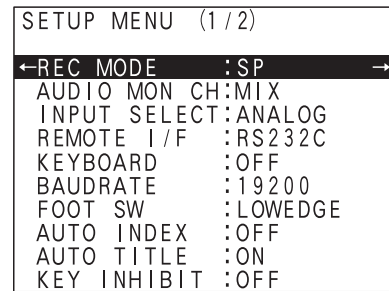

- 3** Press the  button.

The SETUP MENU appears.



- 4** Select “DATE/TIME PRESET” from the SETUP MENU display.

Each time you press the  or  button, the highlighted cursor moves down or up one by one. When the highlighted cursor reaches the last item pressing the  button, press the  button again. The next page of the SETUP MENU appears.

Press the **↓** button several times until “DATE/TIME PRESET” is highlighted.

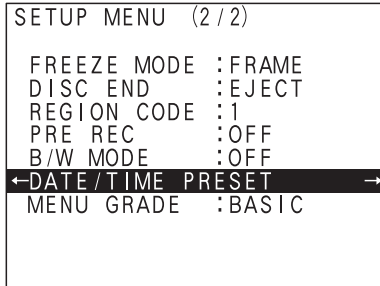

**5** Press the **→** button.

The DATE/TIME PRESET sub menu appears.

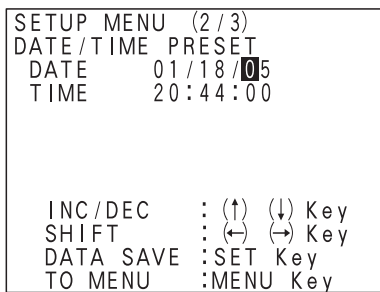

**6** Select the digit to be set by pressing the **←** or **→** button.

Press the **←** or **→** button until the digit you want to change is highlighted.

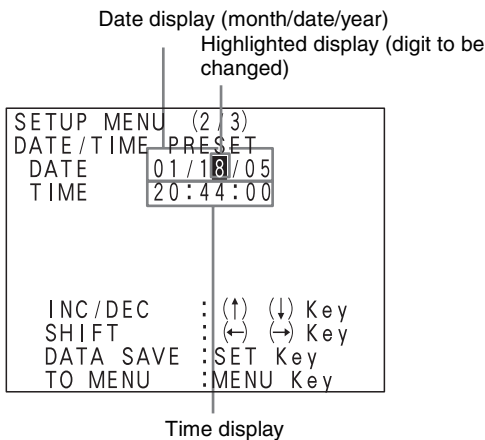

### To move the cursor between the date column and the time column

If you press the **→** button when the rightmost digit of the date column is highlighted, the leftmost digit of the time column is highlighted. When the leftmost digit of the time column is highlighted, if

you press the **←** button, the rightmost digit of the date column is highlighted.

### Front panel display during menu operation

The date column appears when you set the date in the date column on the DATE/TIME PRESET sub menu. And the time column appears when you set the time in the time column.

**7** Change the numeric value by pressing the **↑** or **↓** button.

Press the **↑** button to increase a value.  
Press the **↓** button to decrease a value.

**8** Set the remaining date and time values by repeating steps 6 and 7.

**9** Press the SET button when you have completed setting the date and time.

The date and time values set are executed. The message “NOW SAVING...” appears and the unit starts to save the setting. When the saving is completed, the message disappears and the unit returns to the normal display.

### To cancel the date/time setting without changing any values

Press the MENU button. The unit returns to the (2/2) or (2/3) SETUP MENU display one level higher than the current one. The setting is cancelled. Press the MENU button again. The unit exits the menu display and returns to the normal display.

#### Note

In this case, the message “ABORT!” will not appear.

## Selecting the Remote Interface

The REMOTE I/F sub menu of the SETUP MENU allows you to select the interface to be used to control the unit remotely.

The factory setting is RS-232C.

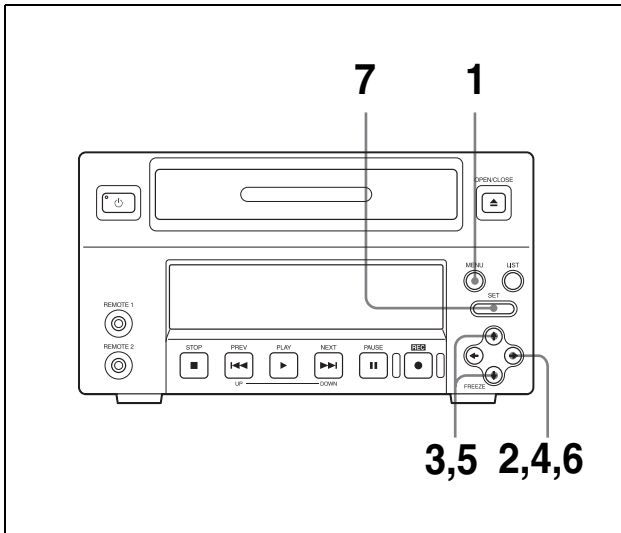

- 1 Press the MENU button.

The TOP menu appears.

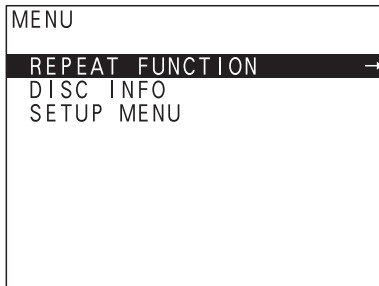

- 2 Select "SETUP MENU" by pressing the ▲ or ▼ button.

"SETUP MENU" is highlighted.

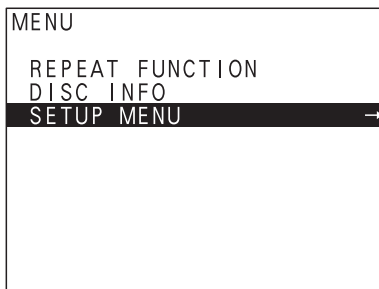

- 3 Press the ► button.

The SETUP MENU appears.

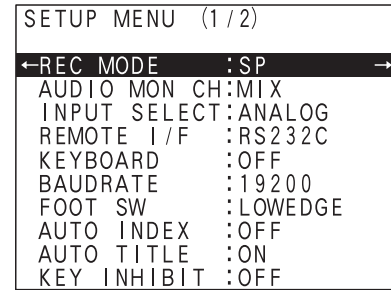

- 4 Select "REMOTE I/F" by pressing the ▼ button.

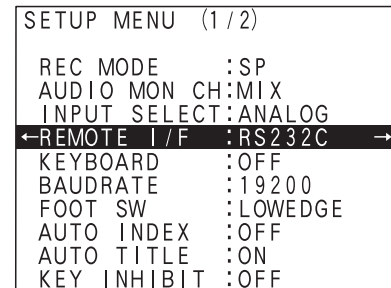

- 5 Press the ► button.

The REMOTE I/F sub menu appears.

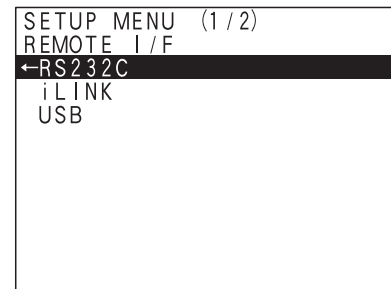

- 6 Select the desired remote interface by pressing the ▲ or ▼ button.

The selected remote interface is highlighted.

Item	Interface
RS232C	To control the unit from external equipment connected to the RS-232C connector. <sup>a)</sup> (Factory setting)
iLINK	To control the unit from external equipment connected to the i.LINK connector. <sup>b)</sup>
USB	To control the unit from external equipment connected to the USB connector. <sup>c)</sup>



- a) This protocol is compatible with the SVO-9500MD video cassette recorder protocol.
- b) This setting is not related to the setting for the input signal.
- c) This protocol is equivalent to the RS-232C protocol.

## **7** Press the SET button.

The message “NOW SAVING...” appears and the unit starts to save the setting.

When the saving is completed, the message disappears and the unit returns to the normal display.

The remote interface setting of the unit is set to the one selected in step 6.

## Handling Discs

### Usable Discs

You can use the DVD+RW discs corresponding to quad speed.

#### Note

You can use discs for both data and video.

### Formatting discs

An unused disc requires no formatting operation. The disc is automatically formatted when loaded into the unit.

When you use a disc formatted by a computer or recorded by using other DVD equipment, format the disc using the FORMAT sub menu of DISC INFO.

#### Note

When a recorded disc is formatted, all the data on the disc is erased.

For detailed information on how to format a disc, see "Formatting a Disc" on page 33.

## Notes on Handling

### Handling

- Do not touch the recording or playback surface of the disc. Handle the disc by its edge.

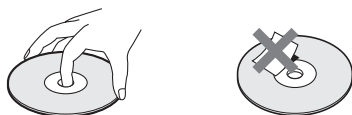

- Do not use the following types of disc. Doing so may cause the unit to malfunction.
  - A disc on which a paper label or a seal is attached
  - A disc on which the glue of cellophane tape or a label, or on which a portion of a label still remains
  - A cracked disc
  - A cracked disc which has been mended using glue (or a similar substance)

### Storage

- Do not store discs where they may be subjected to direct sunlight, or in other places where the temperature or humidity is high.
- Store discs in their cases.
- Finger prints or dust accumulated on the disc cause deterioration of picture quality. Keep the disc clean.

### Care of the discs

- Clean the disc with a soft cloth, wiping it from the center out. If the dust is heavy, wipe it with a soft cloth moistened with water, then wipe off the water with a dry cloth.

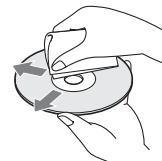

- Do not use solvents such as benzene, thinner, commercially available record cleaners, or anti-static spray. Using these products may damage discs.

## Loading and Unloading Discs

### Loading a disc

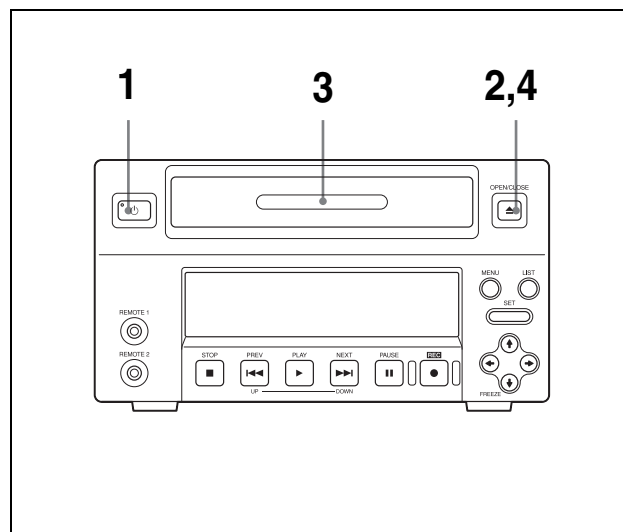

- Press the  (power) switch to turn the power on.

The message "Welcome" appears on the front panel display.

The message changes to "Now loading...," and then "NO DISC!" lights. Proceed to the next operation.

#### Note

If the  (power) is not turned on and the front panel display does not light even if you press the power

switch, check whether the MAIN POWER switch on the rear panel is set to the **I** (on) side.

*For detailed information on how to turn the power on or off, see "Turning the Power On/Off" on page 15.*

- 2 Press the OPEN/CLOSE button.

The disc tray opens.

The message changes to "OPEN" on the front panel display.

- 3 Place the disc on the tray.

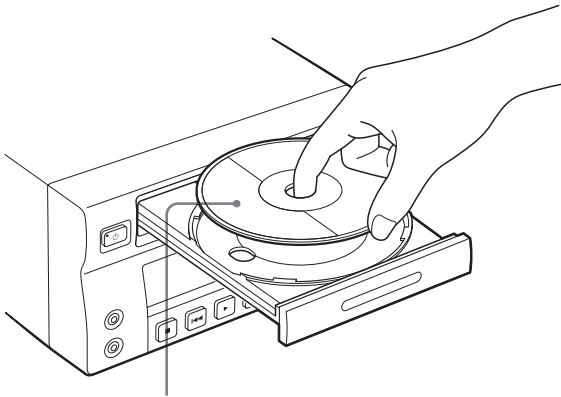

With the recording/playback surface facing down

- 4 Press the OPEN/CLOSE button. Or push the disc tray lightly.

The disc tray closes.

The DISC IN display blinks and the message "Now loading..." appears on the front panel display.



DISC IN display

Go to the next step, after the message "Now loading..." disappears and the DISC IN display stops blinking.

### **If you load discs which cannot be used with the unit**

The message "Not Supported!" appears.

In such a case, unload the disc and insert a disc that can be used with the unit.

## **Unloading a disc**

- 1 Press the OPEN/CLOSE button with the power turned on.  
The disc tray opens.
- 2 Remove the disc.
- 3 If you do not wish to load another disc, press the OPEN/CLOSE button to close the disc tray.

# Preparations for Recording

## Selecting Input Signals

The INPUT SELECT sub menu of SETUP MENU allows you to select the input signal to be recorded.

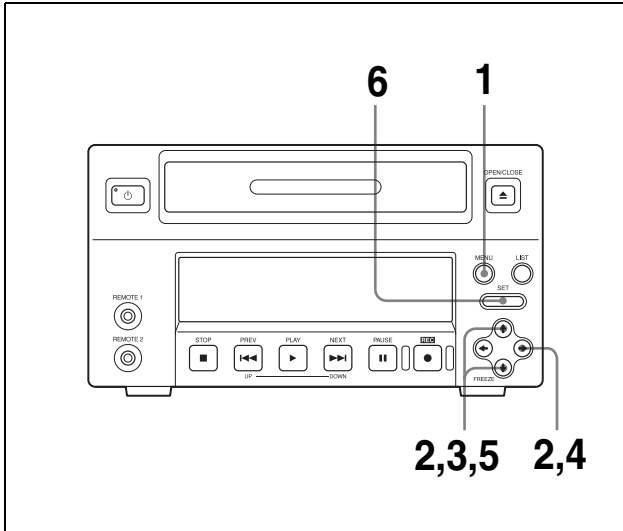

- 1 Press the MENU button.  
The TOP menu appears.

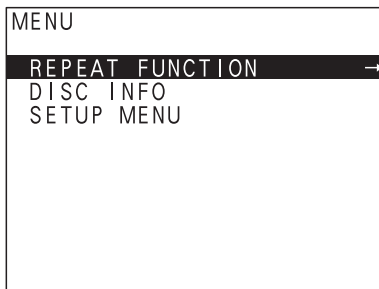

- 2 Select "SETUP MENU" by pressing the ↑ or ↓ button and press the → button with "SETUP MENU" highlighted.

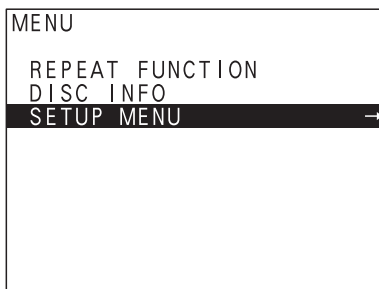

The SETUP MENU appears.

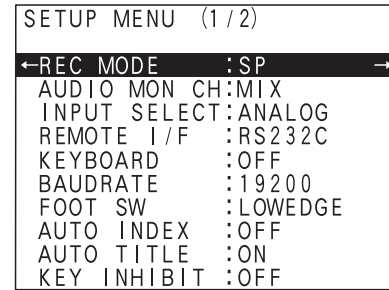

- 3 Select "INPUT SELECT" by pressing the ↑ or ↓ button.

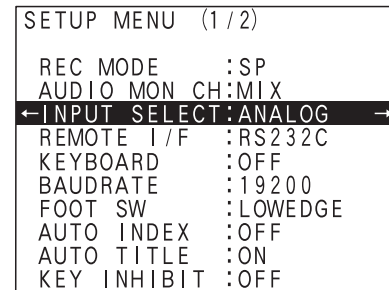

- 4 Press the → button.

The INPUT SELECT sub menu appears.

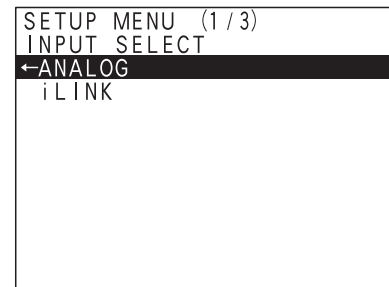

- 5 Select the desired input signal by pressing the ↑ or ↓ button.

Input signal	Setting
ANALOG	To record an analog signal input to the VIDEO IN or S-VIDEO IN connector. (Factory setting)
i.LINK	To record a standard DV digital signal input to the DV IN (i.LINK) connector.

**When an analog input signal is selected:**  
When an S video cable is connected to the S-VIDEO IN connector of the unit, the S video signal is selected regardless of whether an S video signal



is input or not, taking precedence over a composite video signal input to the VIDEO IN connector. "S-VIDEO" appears on the front panel display.

**6** Press the SET button.

The message "NOW SAVING..." appears and the unit starts to save the setting. When the saving is completed, the message disappears and the unit returns to the normal display. The input signal is executed.

## Selecting the Recording Mode

The unit employs three different recording modes. The REC MODE sub menu of SETUP MENU allows you to select the recording mode.

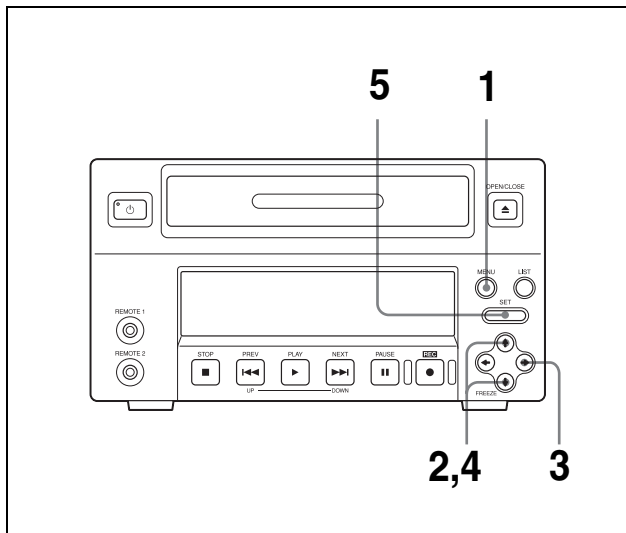

**1** Press the MENU button.

The TOP menu appears.

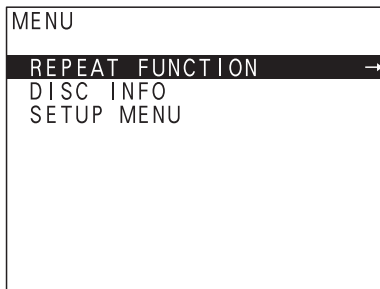

**2** Select "SETUP MENU" by pressing the  $\uparrow$  or  $\downarrow$  button and press the  $\rightarrow$  button with "SETUP MENU" highlighted.

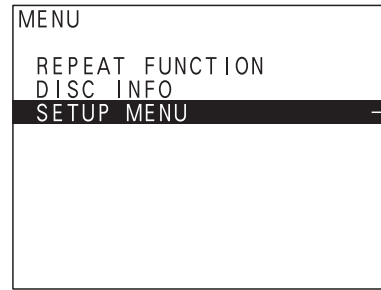

The SETUP MENU appears.

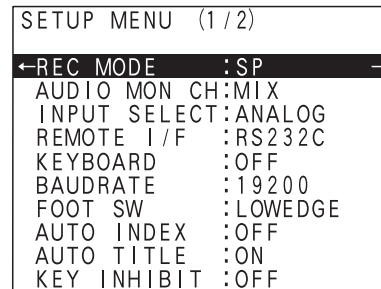

**3** Confirm that the REC MODE is highlighted and press the  $\rightarrow$  button.

The REC MODE sub menu appears.

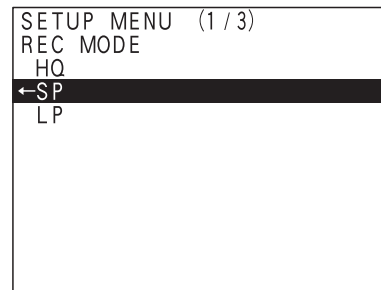

**4** Select the desired recording mode pressing the  $\uparrow$  or  $\downarrow$  button.

Recording mode	Setting	Maximum recording time
HQ	To record in high-quality recording mode.	About 1 hour
SP	To record in standard mode. (factory setting)	About 2 hours
LP	To record for long time.	About 3 hours

**5** Press the SET button.

The message “NOW SAVING...” appears and the unit starts to save the setting.

When the saving is completed, the message disappears and the unit returns to the normal display.

The recording mode is executed.

## Recording

The unit allows you to record up to 49 titles on one disc. Also, you can mark indexes at desired points during recording.

When you record additional data on an already recorded disc, the unit starts from the beginning of the blank portion of the disc.

### Notes

- If you load a disc which is full, a disc on which 49 titles have already been recorded, and so on, you cannot record any data. Be sure to confirm the disc before using it.
- When the remaining time of the disc becomes five minutes, the main display section of the front panel display (TITLE/CHAP/time indicator) blinks.
- Before performing the important recording, be sure to try to record whether or not the unit records correctly.

## Recording Titles

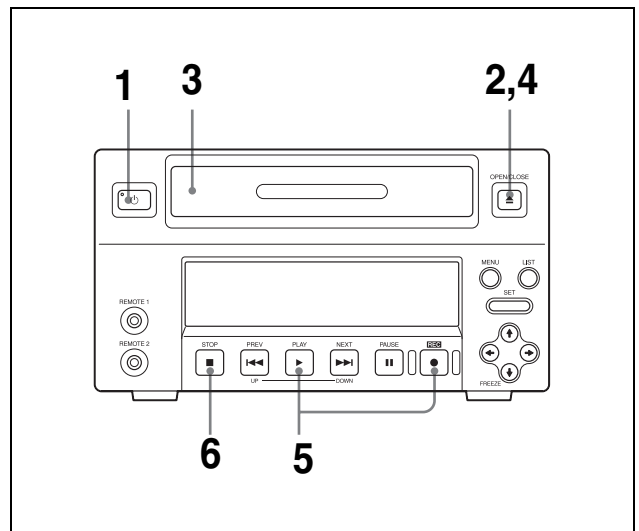



- 1 Press the  (power) switch to turn the power on.

The message “Welcome” appears on the front panel.

When the message changes to “Now loading...,” and then to “NO DISC!,” go to the next operation.

### Note

If the power is not turned on and the front panel display does not light even if you press the  (power) switch, check whether the MAIN POWER switch on the rear panel is set to the  (on) side.

For detailed information on how to turn the power on or off, see "Turning the Power On/Off" on page 15.

- 2 Press the OPEN/CLOSE button.

The disc tray opens.  
The message changes to "OPEN" on the front panel display.

- 3 Place the disc on the tray.

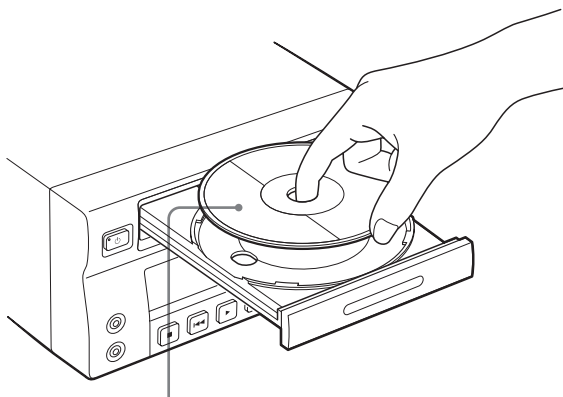

With the recording/playback surface facing down

- 4 Press the OPEN/CLOSE button. Or push the disc tray lightly.

The disc tray closes.  
The DISC IN display blinks and the message "Now loading..." appears on the front panel display.  
When the DISC IN display stops blinking, go to step 5.

- 5 Press the ●REC button.

The unit starts recording of one title.

- 6 To stop recording that title, press the ■STOP button.

- 7 Repeat recording of the remaining titles by repeating steps 5 and 6.

The titles are numbered in the sequence they are recorded.

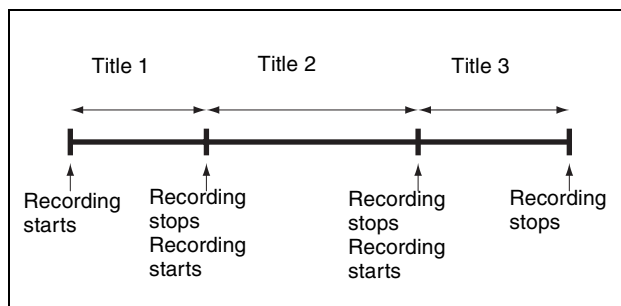

### To pause during recording

Press the ■PAUSE button.

To resume recording, press the ■PAUSE button again.

### Notes

- At the beginning of recording, an index is marked automatically. Also, indexes are marked whenever you press the ■PAUSE button.
- When the unit is remotely controlled with the RS-232C remote interface, the STOP command works as the pause task or stop recording task. Which task is effective depends on the setting of the 232C STOP item (see page 49) of the ENHANCED MENU of the SETUP MENU.

### If buttons on the front panel do not function even if you push them

The KEY INHIBIT item (see page 47) of the SETUP MENU is set to "ON."

Thus, the key-lock function is activated so that all buttons except the MENU button, the LIST button, the power switch, and the OPEN/CLOSE button are deactivated to prevent you from pressing buttons accidentally.

To re-activate the buttons, set the KEY INHIBIT item to "OFF."

However, when the unit is in menu operation status, you can use the ←, →, ↑, ↓, and SET buttons.

### Marking Indexes During Recording

You can mark indexes at desired points during recording. This allows you to search for the desired points instantly during playback, and also to play a segment specified by two points in succession. You can mark up to 254 indexes on one disc and up to 99 indexes within one title.

You can mark indexes using the following three methods.

#### To use the ■PAUSE button of the unit

Press the ■PAUSE button on the front panel of the unit.

### To use the SVRM-100A remote control unit

Press the MARK button on the SVRM-100A remote control unit (not supplied).

For detailed information on how to mark indexes, see "Marking Indexes" on page 58.

### To mark indexes automatically

Indexes are automatically marked every five minutes when the AUTO INDEX (see page 47) sub menu of the SETUP MENU is set to ON.

#### Note

You can mark up to 254 indexes on one disc and up to 99 indexes within one title.

When the number of indexes exceed the above limitation, an alarm message appears.

For detailed information on alarm messages, see "Alarm Messages" on page 52.

### To make new titles automatically

The AUTO TITLE sub menu of the SETUP MENU allows you to make a new title when the number of indexes in one title exceeds 99.

For details, see "AUTO TITLE" on page 47.

### Segment between the indexes

The segment between the indexes is called a chapter.

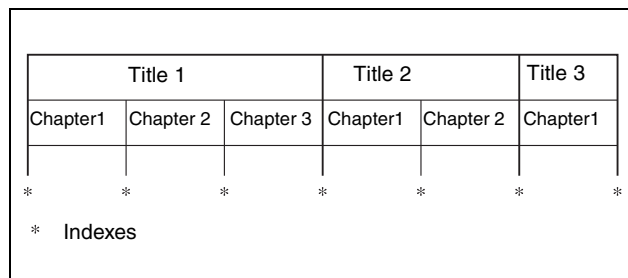

## Using a Foot Switch

A foot switch (not supplied) allows you to start or pause recording.

The operation required for starting or pausing the recording depends on the setting of the FOOT SW sub menu of the SETUP MENU.

#### Note

To stop recording when using a foot switch, press the ■ STOP button on the front panel of the unit.

- 1 Press the MENU button.

The TOP menu appears.

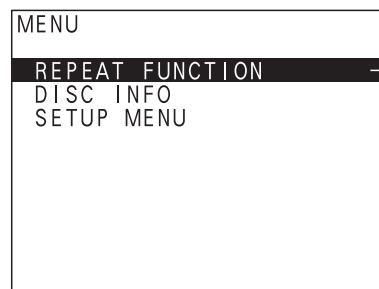

- 2 Select "SETUP MENU" by pressing the ▲ or ▼ button and press the ► button with "SETUP MENU" highlighted.

The SETUP MENU appears.

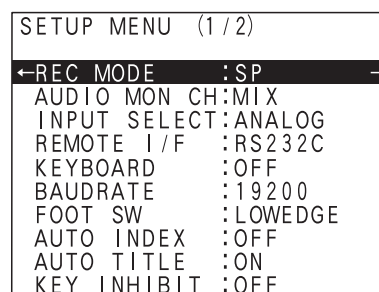

- 3 Select "FOOT SW" by pressing the ▲ or ▼ button.

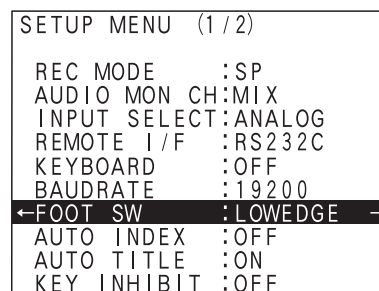

- 4 Press the ► button.

The FOOT SW sub menu appears.

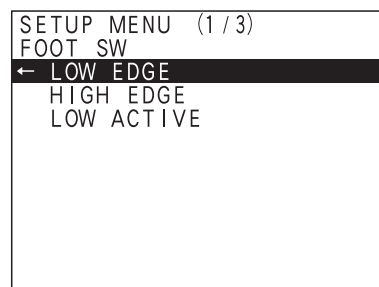

- 5 Select the desired mode by pressing the  $\uparrow$  or  $\downarrow$  button.

Mode	Setting
LOW EDGE	To start recording when you push the foot switch, or to pause recording during recording. Even if you release the foot switch, the recording or pause recording status remains in effective. (Factory setting)
HIGH EDGE	To start recording when you push the foot switch and release it, or to pause recording during recording. The unit does not change from one operation to another when you push the foot switch.
LOW ACTIVE	While you hold the foot switch down, the unit records. When you release the foot switch, the unit pauses.

- 6 Press the SET button.

The message “NOW SAVING...” appears and the unit starts to save the setting. When the saving is completed, the message disappears and the unit returns to the normal display.

## Adding Information to Titles

When you record data, the recording month/date/year/hour/minute/second (example: 01/06/04 17:25:19) is recorded automatically.

Also, the RM-P110 remote control unit (not supplied) allows you to change the title name and to record data of 2048 bytes every title using the keyboard of the RM-P110. Thus, you can record additional information for a title.

### To use an RM-P110 (not supplied) as a keyboard for editing/adding title name and information

You should carry out the following operation and menu settings:

- Connect the RM-P110 to the RS-232C connector of the unit.
- Set the REMOTE I/F sub menu (see page 47) of the SETUP MENU to RS232C.
- Set the KEYBOARD sub menu (see page 47) of the SETUP MENU to ON.

You can enter characters in overwrite mode. Use the ESC key for the backspace function.

### Notes

- Be sure to turn off the power of the unit by using the  $\text{\textcircled{P}}$  (power) switch on the front panel of the unit. For detailed information on how to turn off the power of the unit, see “Turning the Power Off” on page 15.
- When not using the RM-P110, be sure to set the KEYBOARD sub menu of the SETUP MENU to OFF (see page 47).

### To add information to the title or edit title information

The TITLE INFO display of the title menu allows you to edit title information.



For detailed information, see “Verifying/Editing Information About the Title” on page 42.

When you record using equipment such as external equipment, data is recorded via the communication protocol.

## Pre Rec Function

When the PRE REC sub menu of the SETUP is set to “ON,” the unit saves the last 5 seconds of video data in the internal memory. This function allows the unit to start recording the last 5 seconds of video data saved previously for continuity.

- 1 Press the MENU button.

The TOP menu appears.

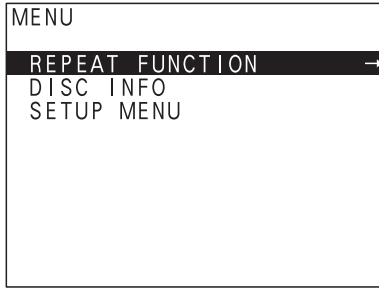

- 2** Select “SETUP MENU” by pressing the **▲** or **▼** button, and press the **▶** button with “SETUP MENU” highlighted.

The SETUP MENU appears.

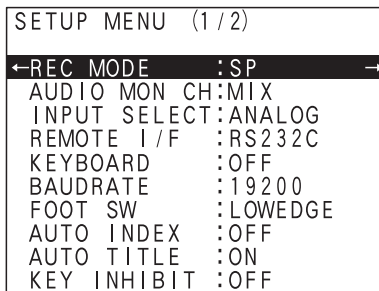

- 3** Select “PRE REC” by pressing the **▲** or **▼** button.

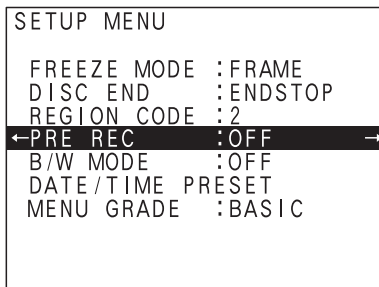

- 4** Press the **▶** button.

The PRE REC sub menu appears.

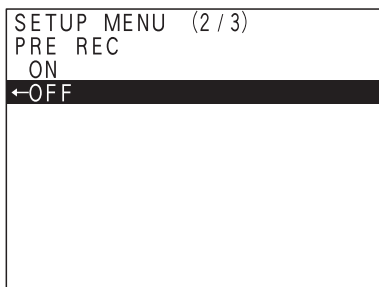

- 5** Select the desired mode by pressing the **▲** or **▼** button.

Mode	Setting
OFF	To record the video signal promptly after you start recording. (Factory setting)
ON	To start recording using the last 5 seconds of video data saved previously.

- 6** Press the SET button.

The message “NOW SAVING...” appears and the unit starts to save the setting.

When the saving is completed, the message disappears and the unit returns to the normal display.

The setting for the previous recording is executed.

## When the Disc Becomes Full During Recording

At the factory setting, the unit stops recording automatically and the disc tray opens.

The DISC END sub menu of the SETUP MENU allows you to change this setting.

- 1** Press the MENU button.  
The TOP menu appears.

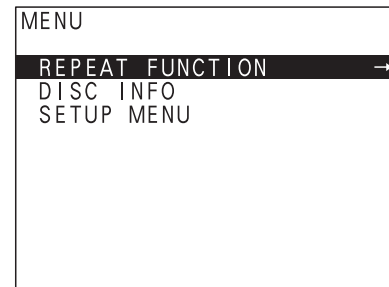

- 2** Select “SETUP MENU” by pressing the **▲** or **▼** button and press the **▶** button with “SETUP MENU” highlighted.

The SETUP MENU appears.

```

SETUP MENU (1/2)
←REC MODE :SP →
AUDIO MON CH:MIX
INPUT SELECT:ANALOG
REMOTE I/F :RS232C
KEYBOARD :OFF
BAUDRATE :19200
FOOT SW :LOWEDGE
AUTO INDEX :OFF
AUTO TITLE :ON
KEY INHIBIT :OFF
    
```

The message “NOW SAVING...” appears and the unit starts to save the setting.

When the saving is completed, the message disappears and the unit returns to the normal display.

The setting is executed.

**3** Select “DISC END” by pressing the **▲** or **▼** button.

```

SETUP MENU (2/3)
FREEZE MODE :FRAME
←DISC END :ENDSTOP →
REGION CODE :2
PRE REC :OFF
B/W MODE :OFF
DATE/TIME PRESET
MENU GRADE :ENHANCED
TV SYSTEM :NTSC
232C STOP :REC PAUSE
232C FF/REW :NEXT/PREV
    
```

**4** Press the **▶** button.

The DISC END sub menu appears.

```

SETUP MENU (2/3)
DISC END
GOTO TOP
←END STOP
EJECT
    
```

**5** Select the desired disc end mode by pressing the **▲** or **▼** button.

Mode	Setting
GOTO TOP	To return to the beginning of the disc.
END STOP	To return to the beginning of the last title, and end recording automatically. However, the disc is not ejected, and the disc remains in the tray.
EJECT	To stop recording and eject the disc automatically. (Factory setting)

**6** Press the SET button.

## Finalizing a Disc

There is a case where a disc recorded on this unit must be finalized to play it on other equipment compatible with DVD+RW equipment. Proceed as follows to finalize the disc.

Even if the disc is finalized, you can use that disc for recording again or you can edit data recorded on the disc.

- 1 Load the disc to be finalized into the unit.
- 2 Press the MENU button.

The TOP menu appears.

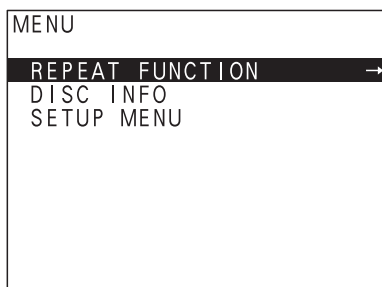

- 3 Select "DISC INFO" by pressing the ▲ or ▼ button, and press the ► button with "DISC INFO" highlighted.

The DISC INFORMATION sub menu appears.

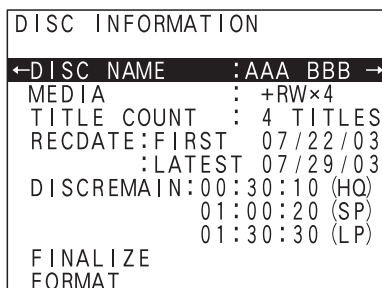

- 4 Press the ▲ or ▼ button to select "FINALIZE" and press the ► button with "FINALIZE" highlighted.

The FINALIZE display appears.

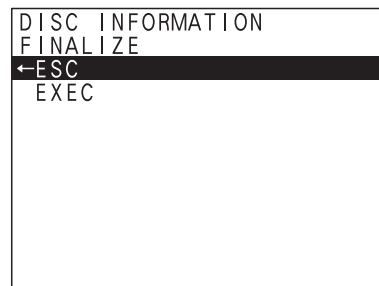

- 5 Select "EXEC" pressing the ▲ or ▼ button. Then, press the SET button.

The message "READY?" appears.

- 6 Press the SET button.

The message "FINALIZING THE DISC. PLEASE WAIT." appears, and finalization is started. When finalization is completed, the message changes to "COMPLETE!," and the unit exits the menu and returns to the normal display.

- 7 Remove the disc.



# Formatting a Disc

You can erase all the data recorded on the DVD+RW disc and format that disc so as to be able to use it with the unit.

## Note

When a recorded disc is formatted, all the data, such as title names is erased. You cannot resume it to the status before formatted.

- 1 Load the disc to be formatted in the unit.
- 2 Press the MENU button.

The TOP menu appears.

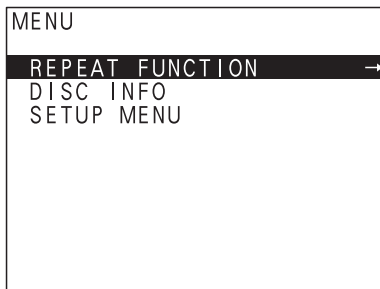

- 3 Select “DISC INFO” by pressing the ↑ or ↓ button, and press the → button with “DISC INFO” highlighted.

The DISC INFORMATION sub menu appears.

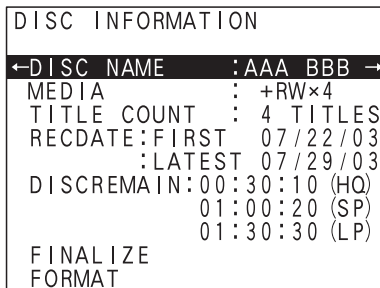

- 4 Select “FORMAT” by pressing the ↑ or ↓ button, and press the → button with “FORMAT” highlighted.

The FORMAT display appears.

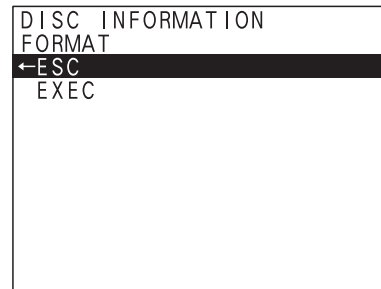

- 5 Select “EXEC” by pressing the ↑ or ↓ button, and then press the SET button.

The message “READY?” appears.

### To quit formatting a disc

Select “ESC,” and then press the SET button with ESC highlighted.  
Or press the MENU button.

- 6 Press the SET button.

The message “FORMATTING THE DISC. PLEASE WAIT.” appears and formatting is started. When formatting is completed, the message changes to “COMPLETE!,” and the unit exits the menu and returns to the normal display.

- 7 Remove the disc.

## Playback

### Usable Discs

You can use the 4 x DVD+RW discs.

#### Note

The recorded discs may not be able to be played back due to scratch on the disc, dust accumulated on the disc, conditions recorded or recording equipment.

### Playback a Disc

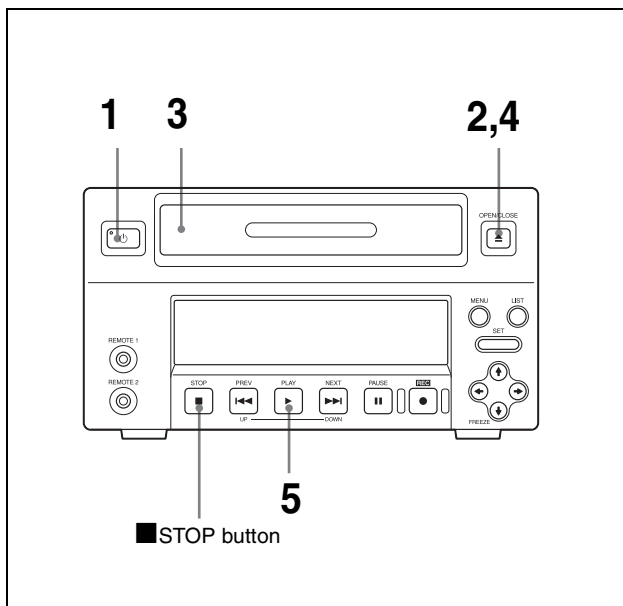

- 1 Press the  (power) switch to turn the power on.

The message “Welcome” appears on the front panel.  
When the message changes to “Now loading...”, and then to “NO DISC!”, go to the next operation.

#### Note

If the power is not turned on and the front panel display does not light even if you press the  (power) switch, check whether the MAIN POWER switch on the rear panel is set to the **I** (on) side.  
*For detailed information on how to turn the power on or off, see “Turning the Power On/Off” on page 15.*

- 2 Press the OPEN/CLOSE button.

The disc tray opens.  
The message changes to “OPEN” on the front panel display.

- 3 Place the disc to be played on the tray.

- 4 Press the OPEN/CLOSE button.

The disc tray closes.  
The DISC IN display blinks and the message “Now loading...” appears on the front panel display.  
Go to step 5, after the message “Now loading...” disappears and the DISC IN display lights up.

- 5 Press the  PLAY button.

Playback starts.

#### Note



For a moment, the picture is frozen and audio playback stops between titles.

#### To stop playback



Press the  STOP button.

### Fast Forward or Reverse Playback

#### To view fast forward playback

Press the  INEXT/DOWN button with the  PLAY button held down. This allows you to view fast forward playback at a speed three times the speed of normal playback.

#### To view reverse playback

Press the  PREV/UP button with the  PLAY button held down. This allows you to view fast reverse playback at a speed three times the speed of normal playback.

### Adding Indexes During Playback

You can add indexes using the SVRM-100A remote control unit.

*For detailed information on how to add indexes, see “Using an SVRM-100A Remote Control Unit (Not Supplied)” on page 57.*

# Searching for Desired Point

## Jumping to a Desired Title

The ◀ or ▶ button allows the unit to jump to the title before or after the title currently being played.

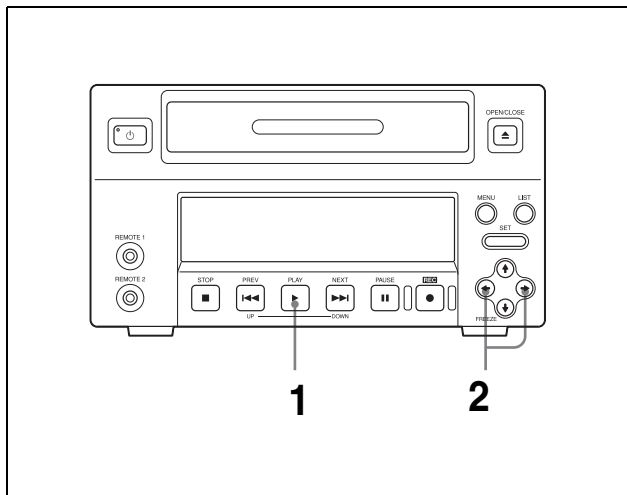

**1** Press the ▶PLAY button.

Playback starts.

**2** Press the ◀ or ▶ button to jump.

### When you press the ◀ button:

When you press this button once, the unit jumps to the start point of the title currently being played. When you press this button twice, the unit jumps to the start point of the previous title of the title currently being played.

### When you press the ▶ button:

When you press this button once, the unit jumps to the start point of the next title.

## Jumping to a Desired Chapter

The ◀◀PREV/UP or ▶▶INEXT/DOWN button allows the unit to jump to the chapter before or after the chapter currently being played.

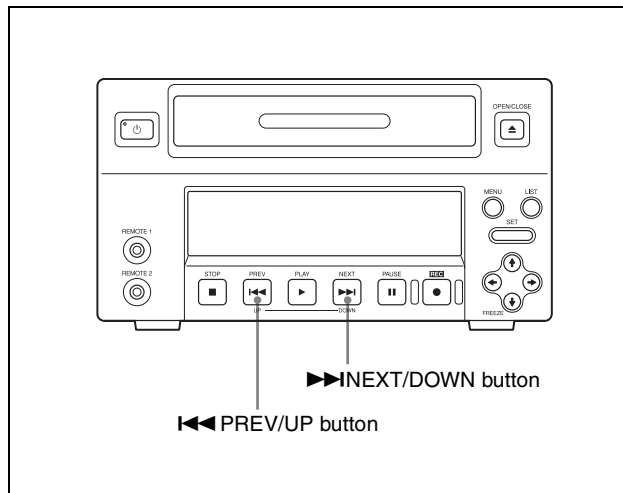

### When you use the ▶▶INEXT/DOWN button:

When you press this button once, the unit jumps to the start point of the next chapter.

### When you use the ◀◀PREV/UP button:

When you press this button once, the unit jumps to the start point of the chapter currently being played. When you press this button twice, the unit jumps to the start point of the previous chapter.

## Example

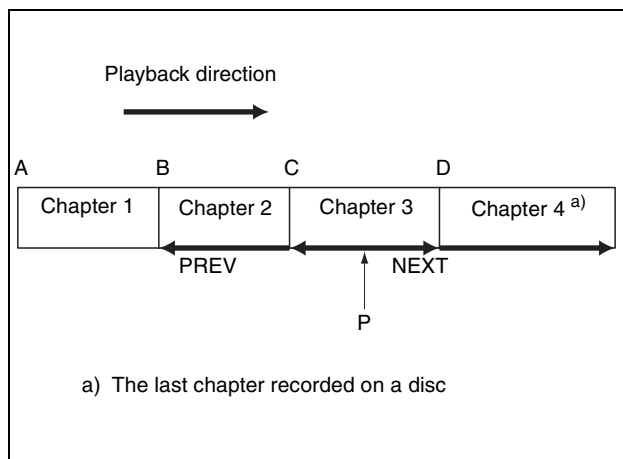

When you press the ◀◀PREV/UP button or the ▶▶INEXT/DOWN button at the current position (point P), the unit behaves as follows:

When the ◀◀PREV/UP button is pressed once: Jumps to point C.

When the ◀◀PREV/UP button is pressed twice: Jumps to point B.

When the ▶▶INEXT/DOWN button is pressed once: Jumps to point D.

When the ►►NEXT/DOWN button is pressed twice:  
When the target point is the end of the last chapter, the unit jumps to the beginning of the last chapter. Thus, in this case, the unit jumps to point D.

## Repeat Playback

You can conduct the following repeat playback operations using the menu.

- Repeat playback between two points (A-B repeat)
- Repeat playback of the chapter currently being played
- Repeat playback of the title currently being played

### Repeat Playback Between Two Points (A-B Repeat)

You can conduct repeat playback of a certain section specified by two points.

#### Setting points A and B

Proceed as follows to set points A and B and conduct repeat playback.

- 1 Load the disc to be played.
- 2 Press the MENU button during playback.

The TOP menu appears.

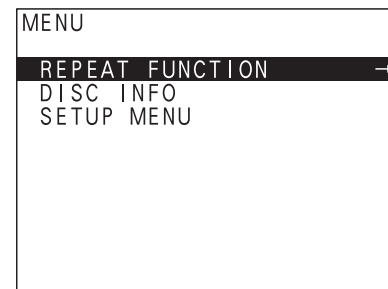

- 3 Select "REPEAT FUNCTION" by pressing the ▲ or ▼ button, and press the ► button with "REPEAT FUNCTION" highlighted.

The REPEAT FUNCTION display appears.

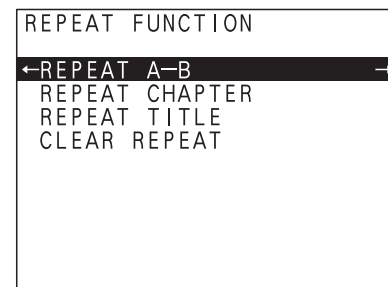

- 4 Select "REPEAT A-B" by pressing the ▲ or ▼ button, and press the ► button with "REPEAT A-B" highlighted.

The REPEAT A-B display appears.

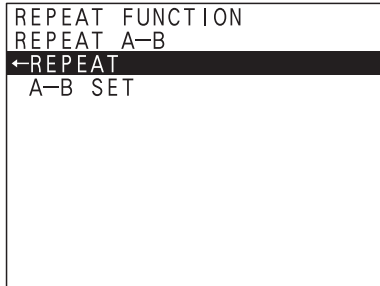

- 5 Select “A-B SET” by pressing the ↓ button.

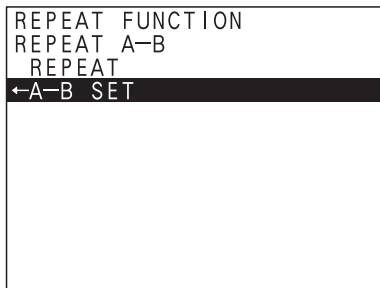

- 6 Press the SET button.

Playback starts, and “A” is displayed as a white letter at the bottom left of the screen.

“A” is highlighted in white.

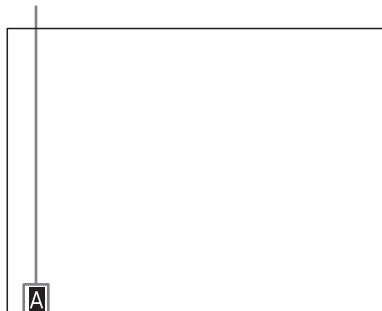

- 7 Press the SET button at the instant when the picture comes to the point you want to set that as point A.

Point A is set and “A” disappears. Then, “B” is displayed as a white letter.

“A” disappears, and “B” is highlighted in white.

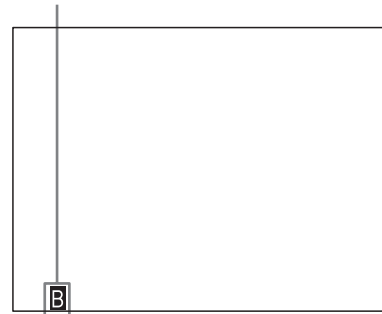

**If you return to the previous menu display by pressing the ← button after setting only point A**

The point A set is cancelled. The points A and B previously set are retained. If you press the → button again, you can start setting the point B.

- 8 Press the SET button at the instant when the picture comes to the point you want to set as point B.

The point B is set and “B” disappears. The repeat playback starts between the points A and B set. Those points A and B are stored until you set new points A and B or until the disc is unloaded.

**Note**

When erasing a title (see page 44) or formatting a disc (see page 33), points A and B set are cleared.

**Stopping repeat playback between points A and B**

The following two methods are available to stop repeat playback between two points.

- Using the ←, →, ⏪PREV/UP, or ⏩INEXT/DOWN button
- Using a menu operation

**To stop repeat playback using the ←, →, ⏪PREV/UP, or ⏩INEXT/DOWN button**

Jump to a title or a chapter located outside of the section specified by the A and B points using the ←, →, ⏪PREV/UP, or ⏩INEXT/DOWN button.

**To stop repeat playback by menu operations**

- 1 Follow the procedure in steps 1 to 2 described in “Repeat Playback Between Two Points (A-B Repeat)” on page 36 to display the REPEAT FUNCTION item.

- 2 With "CLEAR REPEAT" highlighted, press the SET button.

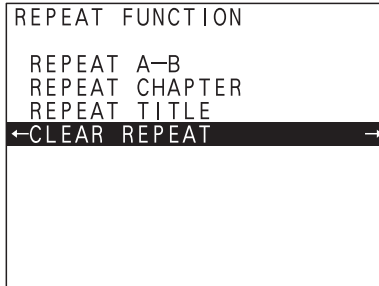

The unit exits the A-B repeat mode and stops playback

## Conducting repeat playback of the existing points A and B

- 1 Follow the procedure in steps 2 to 3 described in "Repeat Playback Between Two Points (A-B Repeat)" on page 36 to display the REPEAT A-B item.
- 2 With "REPEAT" highlighted, press the SET button.

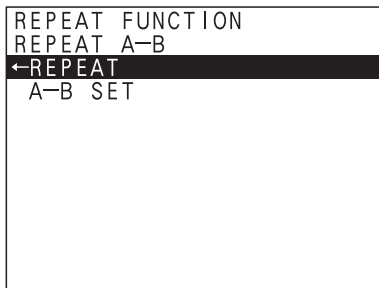

Repeat playback between points A and B starts.

### When either point A or B has not yet been set

The error message "NO AB POINT!" appears on the front panel display and "NO A.B POINT. SET THE A & B POINT" appears on the monitor display..

## Repeat Playback of a Chapter

You can conduct repeat playback of a desired chapter. Proceed as follows to specify a chapter and conduct repeat playback.

- 1 Press the MENU button.

The TOP menu appears.

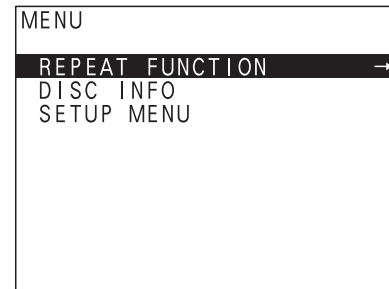

- 2 Select "REPEAT FUNCTION" by pressing the ↑ or ↓ button, and press the → button with "REPEAT FUNCTION" highlighted.

The REPEAT FUNCTION display appears.

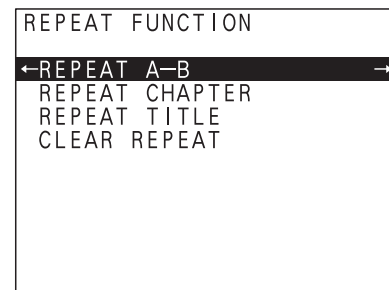

- 3 Select "REPEAT CHAPTER", by pressing the ↑ or ↓ button.

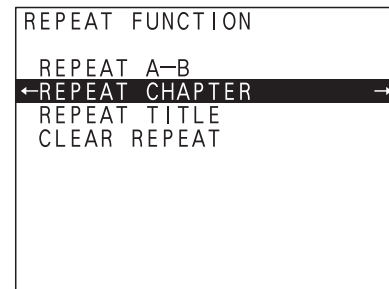

- 4 Press the SET button at the instant when the chapter that you want to repeat comes up.

Repeat playback of the current chapter starts.

### To stop repeat playback of the chapter

Perform the operation described in "Stopping repeat playback between points A and B" on page 37.

## Repeat Playback of a Title

You can conduct repeat playback of a desired title.

Proceed as follows to specify a title and conduct repeat playback.

- 1 Press the MENU button.

The TOP menu appears.

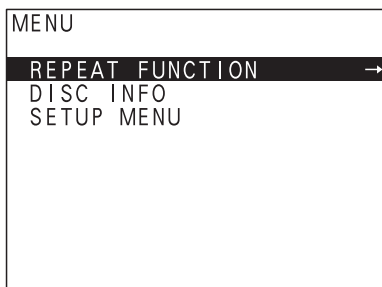

- 2 Select "REPEAT FUNCTION" by pressing the ↑ or ↓ button, and press the → button with "REPEAT FUNCTION" highlighted.

The REPEAT FUNCTION display appears.

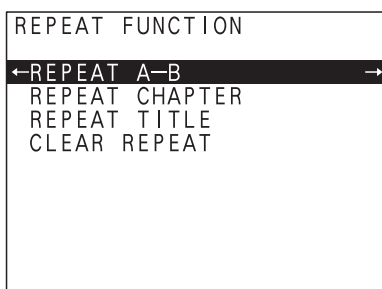

- 3 Select "REPEAT TITLE" by pressing the ↑ or ↓ button.

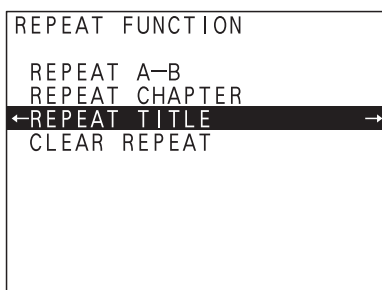

- 4 Press the SET button at the instant when the title that you want to repeat comes up.

Repeat playback of the current title starts.

### To stop repeat playback of the title

Perform the operation described in "Stopping repeat playback between points A and B" on page 37.

## Playing From the TITLE LIST Display

You can select the desired chapter and play it back using the title list.

- 1 Load the disc to be played.
- 2 Press the LIST button.

The TITLE LIST display appears.

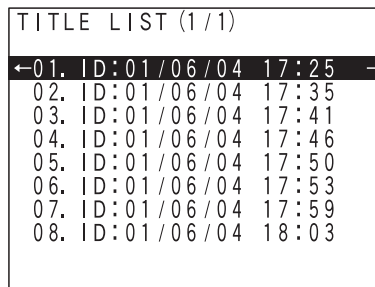

- 3 Select the title which has the chapter that you want to display, by pressing the ↑ or ↓ button.

The following display of the selected title appears.

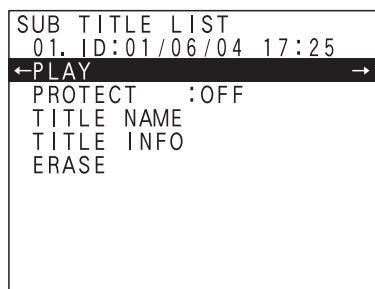

### When there are plural pages

There are two methods how to move to another page.

For details, see "Displaying the next page" on page 40.

- 4 Select "PLAY" by pressing the ↑ or ↓ button, and then press the → button.

The following display appears.

```
CHAPTER LIST (1 /1)
01. ID:01/06/04 17:25
←CHAPTER 01
CHAPTER 02
CHAPTER 03
CHAPTER 04
CHAPTER 05
CHAPTER 06
```

- 5 Select the chapter that you want to play, by pressing the **▲** or **▼** button, and then press the SET button.

Playback of the selected chapter starts.

### Displaying the next page

When there are plural pages of title list displayed in step 3 and chapter list displayed in step 4, the following two methods are available to display another pages.

#### Using the **▲** or **▼** button

- 1 Highlight the last title or chapter on the current page to go to the next page by pressing **▼** button.

Each time you press the **▲** or **▼** button, the display scrolls up or down by one line at a time.

- 2 Press the **▼** button.

The new page appears.

#### Using the **◀◀PREV/UP** or **▶▶NEXT/DOWN** button

**To go back to the previous page:** Press the **◀◀PREV/UP** button.

**To move to the next page:** Press the **▶▶NEXT/DOWN** button.

## Verifying Information on a Disc

You can verify information on a disc. Proceed as follows to display the DISC INFORMATION display.

- 1 Load a disc and press the MENU button.

The TOP menu appears.

```
MENU
REPEAT FUNCTION →
DISC INFO
SETUP MENU
```

- 2 Press the **▲** or **▼** button to select “DISC INFO” and press the **▶** button with “DISC INFO” highlighted.

The DISC INFORMATION display appears.

```
DISC INFORMATION
←DISC NAME :AAA BBB →
MEDIA : +RW×4
TITLE COUNT : 4 TITLES
RECDATE:FIRST 07/22/03
:LATEST 07/29/03
DISCREMAIN:00:30:10 (HQ)
01:00:20 (SP)
01:30:30 (LP)
FINALIZE
FORMAT
```

You can verify the following information on a disc.



Item	Function
DISC NAME	To display the disc name.
MEDIA	To display the media type (display only).
TITLE COUNT	To display the number of titles recorded on a disc (display only).
REC DATE	FIRST: Oldest recording date among titles recorded in one disc. LATEST: Latest recording date among titles recorded in one disc. (Both are only displayed)
DISC REMAIN	To display the remaining recording capacity in units of time for each recording mode (display only).
FINALIZE	To finalize a disc.
FORMAT	To format a disc.

### To display whole of the disc name

Press the **▲** or **▼** button to select "DISC NAME," and press the **▶** button.

```

DISC INFORMATION
←DISC NAME :AAA BBB →
MEDIA      : +RW×4
TITLE COUNT : 4 TITLES
RECDATE:FIRST  07/22/03
          :LATEST 07/29/03
DISCREMAIN:00:30:10 (HQ)
           01:00:20 (SP)
           01:30:30 (LP)
FINALIZE
FORMAT

```

↓ Press the **▶** button.

```

DISC NAME
AAA BBB CCC DDD EEE■

```

You can change the disc name on the above screen. However, you cannot edit the disc name on this unit. The RM-P110 (not supplied) is required. You can edit the disc name using the RM-P110 (not supplied) connected to the RS-232C connector. For detailed information on the RM-P110, see "To use an RM-P110 (not supplied) as a keyboard for editing/adding title name and information" on page 29.

### To return to the previous DISC INFORMATION display

Press the MENU button.

## Viewing Frozen Pictures

### Viewing frozen pictures using buttons on the unit

The following two methods are available to view a frozen picture during playback.

- Pressing the **II**PAUSE button during playback**  
 Playback stops and the picture at that point is frozen. In this case, the frozen picture is a field picture.  
**To cancel to freeze picture and to play again:**  
 Press the **II**PAUSE button again, or press the **▶**PLAY button.
- Pressing the **↓** (FREEZE) button during playback**  
 You can view frame frozen pictures and frozen field pictures in sequence. When you press the **↓** button the first time, the picture becomes a frame frozen picture. When you press the **↓** button the second time, the frame frozen picture is replaced with the first field frozen picture. When you press the **↓** button the third time, the first field frozen picture is replaced with the second field frozen picture. Whenever you press the **↓** button, the frozen picture is replaced in this sequence. The FREEZE MODE item (see page 48) of the SETUP MENU allows you to decide whether the first frozen picture is a frame frozen or field frozen picture.  
**To cancel to freeze picture and to play again:**  
 Press the **▶**PLAY button.

### When the unit is controlled using the SVRM-100A remote control unit

#### To freeze the playback picture

Press the FREEZE button during playback. When you press the FREEZE button the first time, the picture becomes a frame frozen picture. When you press the FREEZE button the second time, the frame frozen picture is replaced with the first field frozen picture. When you press the FREEZE button the third time, the first field frozen picture is replaced with the second field frozen picture. Whenever you press the FREEZE button, the frozen picture is replaced in this sequence.

The FREEZE MODE item (see page 48) of the SETUP MENU allows you to decide the first frozen picture to frame one or field one.

#### To cancel to freeze picture and to play again

Press the **▶**PLAY button.

For detailed information on the remote control unit, see "Using an SVRM-100A Remote Control Unit (Not Supplied)" on page 57.

## Editing Titles

The TITLE LIST menu allows you to carry out the following editing tasks on titles.

- **Verifying information about titles and editing titles**

You can verify information about titles and edit titles as required.

*For details, see “Verifying/Editing Information About the Title” on page 42.*

- **Protecting a title**

You can protect titles from accidental erasure or editing.

*For details, see “Protecting a Title” on page 43.*

- **Erasing a title**

You can erase unnecessary titles.

*For details, see “Erasing a Title” on page 44.*

### Verifying/Editing Information About the Title

The TITLE LIST menu allows you to verify information about the desired title. Also, you can edit the name and title information on the TITLE NAME and TITLE INFO displays.

#### Note

To edit information about titles, the RM-P110 remote control unit (not supplied) is required.

**1** Load the disc to be edited.

**2** Press the LIST button.

The TITLE LIST display appears.

The list of titles is displayed.

```
TITLE LIST (1/1)
←01. ID:01/06/04 17:25 →
02. ID:01/06/04 17:35
03. ID:01/06/04 17:41
04. ID:01/06/04 17:46
05. ID:01/06/04 17:50
06. ID:01/06/04 17:53
07. ID:01/06/04 17:59
08. ID:01/06/04 18:03
```

**3** Select the title with information you want to verify by pressing the ↑ or ↓ button, and press the → button.

The following display appears.

```
SUB TITLE LIST
01. ID:01/06/04 17:25
←PLAY →
PROTECT :OFF
TITLE NAME
TITLE INFO
ERASE
```

#### When there are plural pages in the title list

The following two methods are available to move to another pages.

- **Using the ↑ or ↓ button**

Each time you press the ↑ or ↓ button, the display scrolls up or down by one line at a time.

Highlight the last title on the current page by pressing ↓ button. When the last title is highlighted, press the ↓ button.

The new page appears.

- **Using the ◀◀PREV/UP or ▶▶INEXT/DOWN button**

**To go back to the previous page:** Press the ◀◀PREV/UP button.

**To move to the next page:** Press the ▶▶INEXT/DOWN button.

**4** Select “TITLE NAME” to verify or edit the title name, or select “TITLE INFO” to view or edit the title information by pressing the ↑ or ↓ button.

#### To verify or edit the title name

```
SUB TITLE LIST
01. ID:01/06/04 17:25
PLAY
PROTECT :OFF
←TITLE NAME →
TITLE INFO
ERASE
```

## To verify or edit the title information

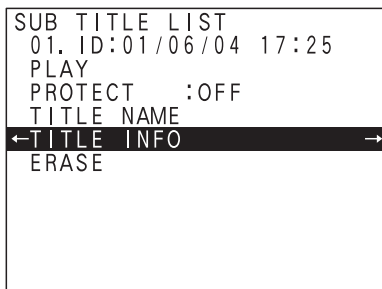

- 5 Press the **➔** button.

The name or information of the title selected in step 3 is displayed.

### When “TITLE NAME” is selected:

Title name currently displayed

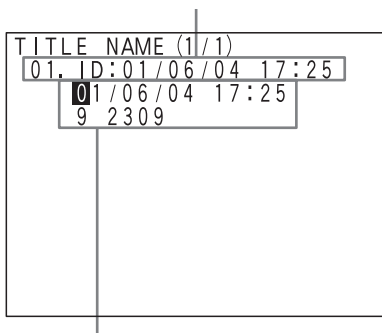

Title name automatically recorded on the disc

### When “TITLE INFO” is selected:

Title name

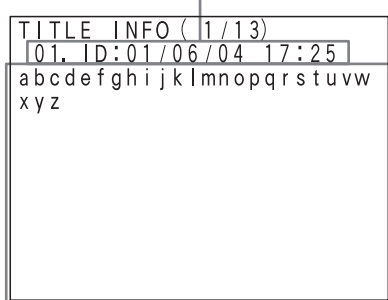

Title information

## To edit the title name and information

You cannot edit titles and information on this unit. To edit them, connect the RM-P110 remote control unit (not supplied) to the unit.

For detailed information on how to use the RM-P110, see “To use an RM-P110 (not supplied) as a

keyboard for editing/adding title name and information” on page 29.

### When you finish editing:

Press the SET button on the unit after carrying out editing task using the RM-P110.

The message “SAVING...” appears on the front panel display while the title name or title information is being saved. On the monitor display, “THIS TITLE IS CHANGING INFORMATION. PLEASE WAIT” appears while the title name or title information is being saved.

### To verify information from another title

Press the LIST button. The screen returns to the one in step 3.

Then, push the **◀** button so that the screen returns to the one in step 2.

Finally, repeat steps 2 and 3 to verify information from another title.

## Protecting a Title

The TITLE LIST display allows you to protect titles from accidental erasure or to prohibit indexes from being added to or erased from titles.

Proceed as follows.

- 1 Load the disc on which titles that you want to protect are recorded.
- 2 Press the LIST button.

TITLE LIST display appears.  
The list of titles is displayed.

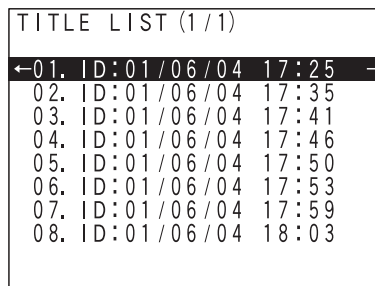

- 3 Select the title that you want to protect from the list by pressing the **▲** or **▼** button. Then, press the **➔** button.

The following display appears.

```

SUB TITLE LIST
01. ID:01/06/04 17:25
←PLAY →
PROTECT :OFF
TITLE NAME
TITLE INFO
ERASE
    
```

### When there are plural pages in the title list

The following two methods are available to move to another page.

- Using the **▲** or **▼** button
- Using the **◀◀PREV/UP** button or the **▶▶INEXT/DOWN** button

For details, see “When there are plural pages in the title list” on page 42.

- 4 Select “PROTECT” by pressing the **▲** or **▼** button.

The current status

```

TITLE
01. ID:01/06/04 17:25
PLAY
←PROTECT :OFF →
TITLE NAME
TITLE INFO
ERASE
    
```

- 5 Press the **▶** button.

The setting display appears.

- 6 Select the desired setting pressing the **▲** or **▼** button.

The name of the selected title

```

PROTECT
01. ID:01/06/04 17:25
TITLE PROTECT
ON
←OFF →
    
```

Setting	Content
ON	The title is protected.
OFF	The title is not protected. (factory setting)

- 7 Press the SET button.

## Erasing a Title

Proceed as follows.

- 1 Load the disc on which titles that you want to erase are recorded.
- 2 Press the LIST button.

The TITLE LIST display appears.  
The list of titles is displayed.

```

TITLE LIST (1/1)
←01. ID:01/06/04 17:25 →
02. ID:01/06/04 17:35
03. ID:01/06/04 17:41
04. ID:01/06/04 17:46
05. ID:01/06/04 17:50
06. ID:01/06/04 17:53
07. ID:01/06/04 17:59
08. ID:01/06/04 18:03
    
```

- 3 Select the title that you want to erase from the title list by pressing the **▲** or **▼** button, and press the **▶** button.

The following display appears.

```

SUB TITLE LIST
01. ID:01/06/04 17:25
←PLAY →
PROTECT :OFF
TITLE NAME
TITLE INFO
ERASE
    
```

### When there are plural pages in the title list

The following two methods are available to move to another page.

- Using the **▲** or **▼** button
- Using the **◀◀PREV/UP** button or the **▶▶INEXT/DOWN** button

For details, see “When there are plural pages in the title list” on page 42.

- 4 Select “ERASE” by pressing the  $\blacktriangle$  or  $\blacktriangledown$  button.

```
TITLE
01. ID:01/06/04 17:25
PLAY
PROTECT :OFF
TITLE NAME
TITLE INFO
←ERASE→
```

erase title 30 which is the last title currently recorded, the remaining titles are title 1 to title 29. When you record a title the next time, the new title number will be 30.

If you erase titles other than the last one, the capacity of the disc does not change. However, the title numbers are renumbered using the numbers of the titles which were erase.

- 5 Press the  $\blackrightarrow$  button.

The following display appears.

```
ERASE
01. ID:01/06/04 17:25
←ESC→
EXEC
```

- 6 Select “EXEC” by pressing the  $\blacktriangle$  or  $\blacktriangledown$  button.

```
ERASE
01. ID:01/06/04 17:25
ESC
←EXEC→
```

- 7 Press the SET button.

The message “READY?” appears.

- 8 Press the SET button.

The message “ERASING THIS TITLE. PLEASE WAIT” appears highlighted, and the unit starts erasing the title selected.

#### Note

The unit can record up to 49 titles on one disc. When the last title is erased, the capacity of the disc is increased by the size of that title. When you erase a title, adjustment is made to the title numbers based on where the erased title was in the list of titles. For example, you

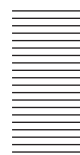

## Menu Configuration and the Menu List

The unit has two kinds of menus: one is the menu displayed by pressing the MENU button, and the other is the title list menu displayed by pressing the LIST button.

This section describes the configuration and the list of the menu displayed by pressing the MENU button.

For detailed information on menu operation, see "Basic Menu Operations" on page 50. For detailed information on the title list menu, see "Playing From the TITLE LIST Display" on page 39.

### About the front panel display during menu operation

This manual uses the monitor display for explaining the menu operation. The items currently highlighted on the monitor display are displayed on the main display section of the front panel display.

Whenever you push the ←, →, ↑ or ↓ button, the display changes.

## Menu Configuration

Press the MENU button. The TOP menu appears.

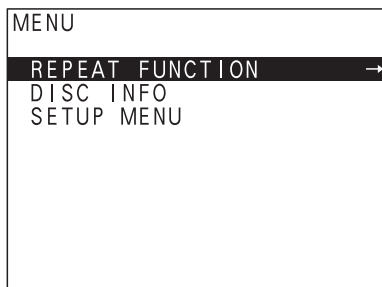

The TOP menu is configured as follows.

- REPEAT FUNCTION menu
- DISC INFO menu
- SETUP MENU

For detailed information on menus, see the following "Menu List" on page 46.

## Menu List

This section describes menus displayed by pressing the MENU button, using lists.

The setting surrounded with   indicates the factory setting.

## REPEAT FUNCTION menu

This menu allows you to repeat playback between two points (A-B repeat), playback of the chapter and the title.

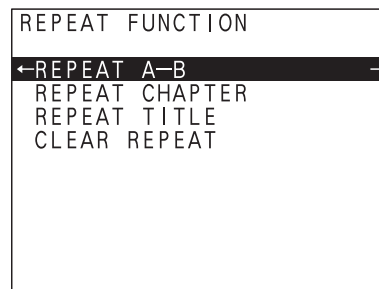

Item	Function
REPEAT A-B	To play a segment specified by two points (point A and point B) repeatedly
REPEAT CHAPTER	To play the chapter currently being played repeatedly
REPEAT TITLE	To play the title currently being played repeatedly
CLEAR REPEAT	To stop the current repeat playback

## DISC INFORMATION menu

The menu allows you to verify details of the disc, finalize and format the disc.

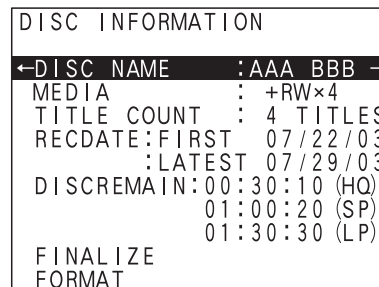

Item	Function
DISC NAME	To display the disc name
MEDIA	To display the media type (display only)
TITLE COUNT	To display the number of titles recorded on a disc (display only)
REC DATE	FIRST: Oldest recording date among titles recorded in one disc. LATEST: Latest recording date among titles recorded in one disc. (Both are only displayed)
DISC REMAIN	To display the remaining recording capacity in units of time for each recording mode (display only)
FINALIZE	To finalize a disc
FORMAT	To format a disc

## SETUP MENU

This menu allows you to perform various settings depending on your circumstances to use the unit.

SETUP MENU (1/2)	
←REC MODE	: SP →
AUDIO MON CH	: MIX
INPUT SELECT	: ANALOG
REMOTE I/F	: RS232C
KEYBOARD	: OFF
BAUDRATE	: 19200
FOOT SW	: LOWEDGE
AUTO INDEX	: OFF
AUTO TITLE	: ON
KEY INHIBIT	: OFF

Item	Function	Setting
REC MODE	To select a recording mode	HQ: Records a high-quality picture.
		[SP]: Records in standard mode.
		LP: Records for a longer time.
AUDIO MON CH	To select a signal to be output from the MONITOR AUDIO connector on the rear panel	LCH: Outputs the audio signal of audio channel 1.
		RCH: Outputs the audio signal of audio channel 2.
		[MIX]: Outputs a mixed audio signal from both channel 1 and channel 2.
INPUT SELECT	To select a video and audio input signals	[ANALOG]: Inputs the analog signal to the VIDEO IN or S-VIDEO IN connector.
		iLINK: Inputs the digital signal to the DV IN (i.LINK) connector.
REMOTE I/F	To select an interface to use to control the unit	[RS232C]: Controls the unit with equipment connected to the RS-232C connector (a protocol which is compatible with the SVO-9500MD Sony video cassette recorder protocol).
		i.LINK: Controls the unit with equipment connected to the DV IN (i.LINK) connector.
		USB: Controls the unit with equipment connected to the USB connector (a protocol which is compatible with the RS-232C protocol).
KEYBOARD	To select whether or not the keyboard of the RM-P110 remote control unit (not supplied) is to be activated	ON: Uses the keyboard.
		[OFF]: Does not use the keyboard.

Item	Function	Setting
BAUDRATE	To select a communication speed (baud rate) when controlling the unit by equipment connected to the RS-232C connector	9600 / [19200] / 38400 / 57600 / 115200
FOOT SW	To select the operation to be carried out when you press or release the foot switch (not supplied)	[LOW EDGE]: Starts recording, or pauses recording during recording, when you press the foot switch. Even if you release the foot switch, the recording or pause recording status remains in effective.
		HIGH EDGE: Starts recording or pausing during recording when you press and release the foot switch. The unit does not change from one operation to another when you press the foot switch.
AUTO INDEX	To select whether or not indexes are automatically marked during recording	ON <sup>a)</sup> : Marks indexes automatically every 5 minutes.
		[OFF]: Does not mark indexes automatically.
AUTO TITLE	To select whether or not a new title is automatically created when the number of indexes in one title exceeds 99.	[ON]: Creates a next title automatically. It is recommended to select this setting when connecting VHS equipment.
		OFF: Does not create a next title automatically.
KEY INHIBIT	To deactivate buttons to protect them from accidental operation except the MENU, LIST, ⏻ (power), and OPEN/CLOSE buttons	ON: Activates the key lock function.
		[OFF]: Deactivates the key lock function. All of the buttons are effective.



Item	Function	Setting
FREEZE MODE	To select the type of frozen picture displayed when playback is paused. (This is effective only when the $\blacktriangledown$ button on the front panel or the FREEZE button on the SVRM-100A remote control unit (not supplied) is used)	[FRAME]: Displays a frame frozen picture when you push the button, then the first field is frozen when you push the button next, and then the second field is frozen when you push the button a third time.
		1ST FIELD: Whenever you push the button, the frozen picture displayed changes in the sequence of the first field, then the 2nd field, and then the frame.
		2ND FIELD: Whenever you push the button, the frozen picture displayed changes in the sequence of the 2nd field, then the frame, and then the first field.
DISC END	To select the operation when the disc becomes full during recording	GOTO TOP: Returns to the beginning of the disc.
		END STOP: Returns to the beginning of the last tile, and end recording automatically. However, the disc is not ejected and remains in the tray.
		[EJECT]: Stops recording and the disc is automatically ejected.
REGION CODE	To select the region code for playback <sup>b)</sup>	[1]: Plays a disc recorded in North America. (This region code is not available for the PAL video signal system.)
		2: Plays a disc recorded in Western Europe (PAL), the Middle East (PAL), South Africa (PAL) and Japan (NTSC)
		3: Southeast Asia including Hong Kong <sup>c)</sup>
		4: Central and South America, and Australia (PAL)
		5: Africa (NTSC), Eastern Europe, Russia, Central Asia, including India (PAL)
		6: China (PAL)
PRE REC	To select whether or not the unit starts recording with data pre-stored for five seconds	ON Starts recording using the last five seconds of video data saved previously.
		[OFF]: Starts recording promptly after you start.

Item	Function	Setting
B/W MODE	To forcibly switch the signal process mode of the VIDEO IN, VIDEO OUT and S-VIDEO OUT connectors to the black and white signal	[OFF]: Processes the signal from the VIDEO IN, VIDEO OUT and S-VIDEO OUT connectors as normal color signals.
		ON: Records the signal input to the VIDEO IN connector as a black and white signal with a wide range, and forcibly cuts the output burst signal from the VIDEO OUT and S-VIDEO connectors. Select this setting when black and white signals are input to the VIDEO IN connector and output from the VIDEO OUT connector.
DATE/TIME PRESET	To set the date and time of the unit.	
MENU GRADE	To display the enhanced menu	[BASIC]: Displays only the basic menu.
		ENHANCED: Displays the enhanced menu under the basic menu. <sup>d)</sup>

a) Indexes recorded automatically cannot be erased.

b) If the video signal system does not match the one used in your area, the disc cannot be played back even if the correct region code is selected. Set the video signal system to either NTSC or PAL on the TV SYSTEM sub menu of the ENHANCED MENU.

c) In Southeast Asia area, the PAL TV system and the NTSC TV system are mixed. Check whether your TV system is NTSC or PAL before using this unit.

d) For detailed information on the enhanced menu, see the following "ENHANCED MENU - Enhanced Sub Menu".

## ENHANCED MENU - Enhanced Sub Menu

Proceed as follows to open the enhanced menu.

- Select "MENU GRADE" on the SETUP MENU by pressing the  $\blacktriangle$  or  $\blacktriangledown$  button.

SETUP MENU (2 / 2)	
FREEZE MODE	: FRAME
DISC END	: EJECT
REGION CODE	: 2
PRE REC	: OFF
B/W MODE	: OFF
DATE / TIME PRESET	
$\blacktriangle$ MENU GRADE	: BASIC $\blacktriangleright$

- Press the  $\blackrightarrow$  button.



The following display appears.

SETUP MENU (2 / 2)
MENU GRADE
ENHANCED
←BASIC

- 3** Select “ENHANCED” by pressing the ↓ button, and press the ← button.

The enhanced sub menu items appear under the last item of the basic menu.

SETUP MENU (2 / 3)
FREEZE MODE : FRAME
DISC END : ENDSTOP
REGION CODE : 2
PRE REC : OFF
B/W MODE : OFF
DATE/TIME PRESET
←MENU GRADE : ENHANCED →
TV SYSTEM : NTSC
232C STOP : REC PAUSE
232C FF/REW : NEXT/PREV

### ENHANCED MENU sub menu

Item	Function	Setting
TV SYSTEM	To select either the NTSC or PAL video signal system	[NTSC] /PAL
232C STOP <sup>a)</sup>	To select the operation when a STOP command is received from the RS-232C interface during recording	REC PAUSE: Pauses recording. [REC STOP]: Stops recording.
232C FF/REW <sup>a)</sup>	To select the search operation when a FF/REW command is received from the RS-232C interface	NEXT/PREV: Performs the same operation of the ►►NEXT/DOWN and ◀◀PREV/UP buttons of the unit when receiving the FF or PREV command. [FF/REW]: Jumps to the top of the disc when receiving the FF command or REW command.

Item	Function	Setting
REC COUNTER	To select the content of the time display on the front panel display during recording	REMAIN: Displays the remaining capacity of the disc. [COUNTER]: Displays the elapsed time of recording.
DEVICE TYPE <sup>a)</sup>	To select the device which sends back the response when a device type INQ command of RS-232C protocol is received	[DVO]: Select this when the unit is connected to video equipment such as external equipment. SVO9500: Select this when the unit is used to replace an existing Sony SVO-9500MD video cassette recorder.
HOUR METER	To display the total time of the use of hard disc drive and DVD drive, and the number of times the tray is opened and closed	Display only <sup>b)</sup>

a) This item is effective when “RS232C” or “USB” is selected for the “REMOTE I/F” item of the basic menu.

b) The following screen is displayed.

SETUP MENU (3 / 3)
HOUR METER
←HDD RUNNING HOURS
XX HOURS
DVD RUNNING HOURS
XX HOURS
DVD RECORDING HOURS
XX HOURS
TRAY OPEN/CLOSE
XX TIMES

Menu

# Basic Menu Operations

This section describes the basic menu operations which are common to each display.

This manual describes some menu operations elsewhere. Read those sections too.

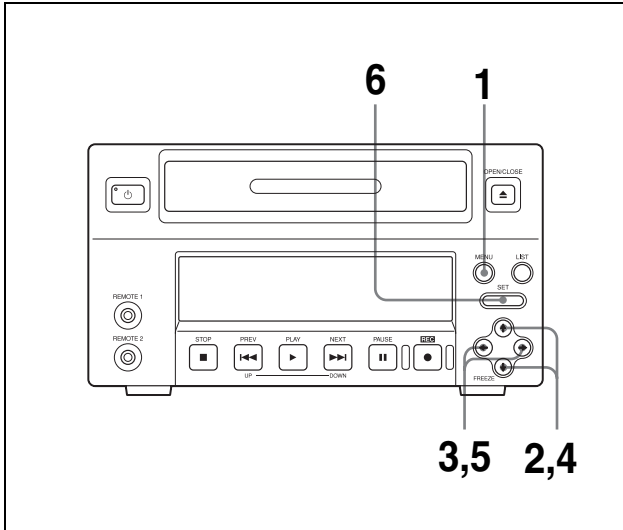

**1** Press the MENU button.

The TOP menu appears.

The item selected is highlighted.

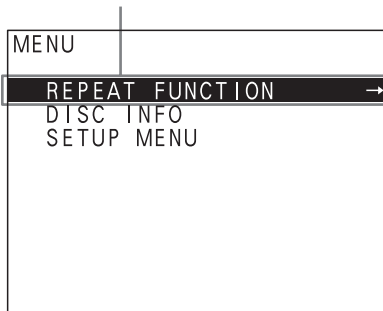

The item selected during the last menu operation using that screen is highlighted.

**2** Select the desired basic menu by pressing the  $\blacktriangle$  or  $\blacktriangledown$  button.

The selected sub menu is highlighted.

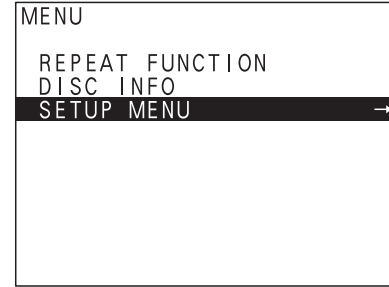

**3** Press the  $\blacktriangleright$  button.

The next lower sub menu display appears.

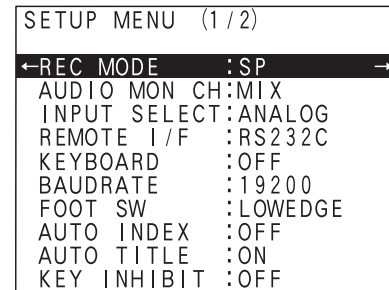

**When there are more sub menus under the currently displayed menu**

Access the desired menu display by repeating steps 2 and 3.

## Example

```
SETUP MENU (1/2)
REC MODE      :SP
AUDIO MON CH :MIX
←INPUT SELECT:ANALOG →
REMOTE I/F   :RS232C
KEYBOARD     :OFF
BAUDRATE     :19200
FOOT SW      :LOWEDGE
AUTO INDEX   :OFF
AUTO TITLE   :ON
KEY INHIBIT  :OFF
```



```
SETUP MENU (1/3)
INPUT SELECT
←ANALOG
iLINK
```

### To return to a higher level

Press the ◀ button. Whenever you press the ◀ button, the screen returns to the menu one level up.

- 4** When the screen with an item you want to set or change is displayed, select the desired setting by pressing the ▲ or ▼ button.

When you move the cursor to the setting, the setting is highlighted and selected.

**Example: “ANALOG” is selected as the input signal on the following screen.**

```
SETUP MENU (1/3)
INPUT SELECT
←ANALOG
iLINK
```

To continue the settings, go to step 5.  
To end the menu operation, go to step 6.

- 5** Access the desired sub menu by pressing the ◀, ▶, ▲ or ▼ buttons, and repeat step 4.

When you have completed all of settings using the menu, go to step 6.

- 6** Press the SET button.

The following screen appears, and the unit starts saving the settings made.

```
MENU
NOW SAVING...
```

When saving is completed, the message disappears, and the unit returns to the normal display.

**When the following screen appears during a menu operation**

```
DISC INFORMATION
FORMAT
←ESC
EXEC
```

**When you highlight “ESC” and press the SET button:**

The unit returns to the menu display one level higher than the current one without executing the setting.

**When you highlight “EXEC” and press the SET button:**

The confirmation message “READY?” appears.  
Press the SET button again.

The message related to the current operation appears, and the unit completes that operation. When saving is completed, the message disappears, and the unit returns to the normal display.

**To cancel the menu operation**

Push the MENU button in any menu layer before pushing the SET button.

The message “ABORT!” appears, and all of the changed settings are cancelled.

The unit returns to the normal screen.

## Messages

The following two types of messages are displayed on the monitor screen and front panel display.

- Error messages
- Alarm messages

### Error Messages

This unit is provided with a self-diagnostic function that detects internal abnormalities. When it detects an abnormality, it indicates an error code on the monitor

screen and on the main display section of the front panel display.

When the error code is displayed, contact your nearest Sony service facilities.

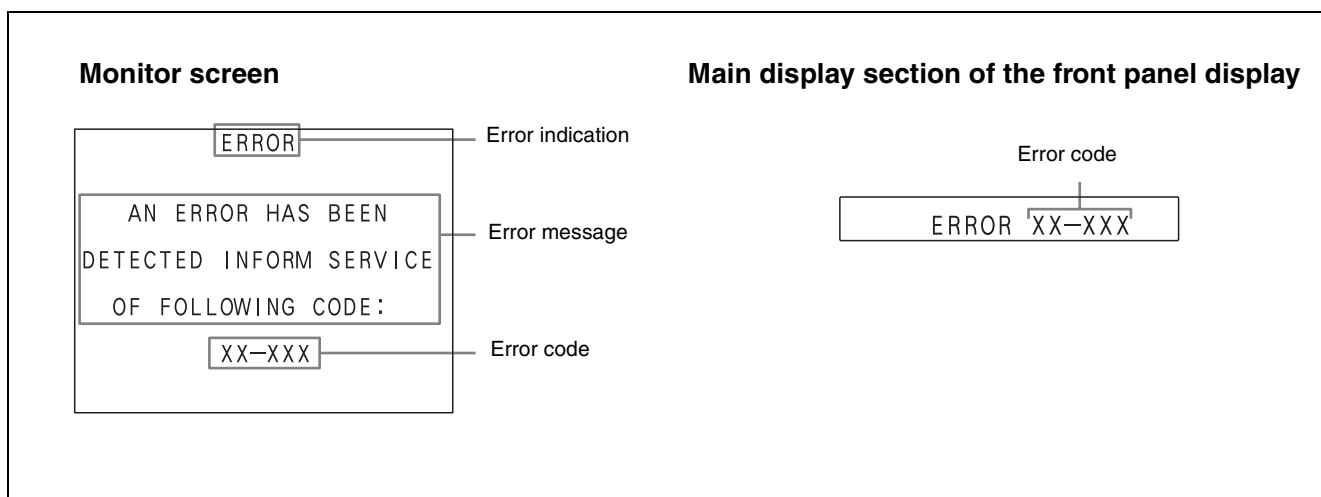

### Alarm Messages

When operating the unit, the unit may sometimes output alarm messages such as the one shown below to the monitor screen and the front panel display.

Take the remedies according to the message.

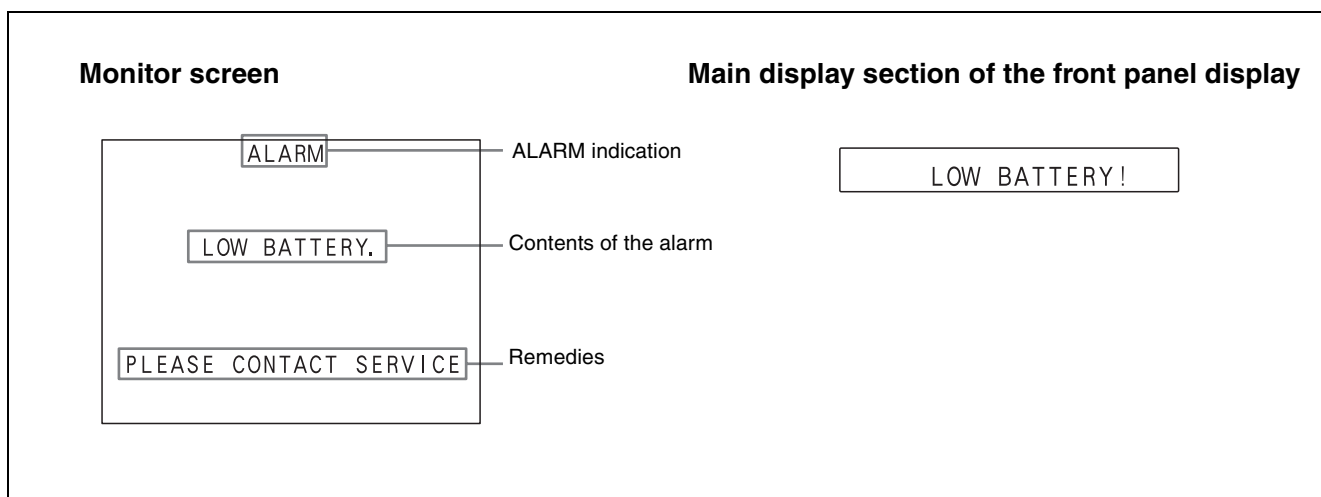

Message		Cause and remedies
Monitor screen	Front panel display	
LOW BATTERY. PLEASE CONTACT SERVICE.	LOW BATTERY!	The unit has detected that the battery is low when the power was turned on. It is required to replace the battery with new one. → Push any button to make the alarm message disappears. Contact your nearest Sony dealer to replace the battery with a new one.
MOISTURE HAS BEEN DETECTED. KEEP THE POWER ON AND WAIT UNTIL THIS INDICATION GOES OFF.	HUMID!	Condensation may form inside the unit. → Keep the power on, wait until the alarm message disappears, and then load the disc.
DISC FULL. CANNOT ADD NEW TITLES.	DISC FULL!	You loaded a disc which is almost full. This message is displayed for about five seconds, and then the display returns to normal.
DISC FULL. USE ANOTHER DISC.		You tried to record on a disc which was full. This message is displayed for about five seconds, and then the display returns to normal. → Replace the disc with one which has sufficient capacity for recording.
TITLE FULL. CANNOT ADD NEW TITLES.	Title FULL!	You loaded a disc on which 49 titles were recorded. This message is displayed for about five seconds, and then the display returns to normal.
TITLE FULL. USE ANOTHER DISC.		You tried to record in on a disc where 49 titles were already recorded. This message is displayed for about five seconds, and then the display returns to normal. → Delete unnecessary titles ( <i>see page 44</i> ), or replace the disc with one which has sufficient capacity for recording.
INDEX FULL. CANNOT ADD NEW TITLES.	Index FULL!	You loaded a disc on which 254 indexes were already recorded. This message is displayed for about five seconds, and then the display returns to normal.
INDEX FULL. CANNOT ADD NEW INDEXES.		You tried to mark an index on a disc where 254 indexes were already marked, during playback. This message is displayed for about five seconds, and then the display returns to normal. → Delete unnecessary indexes ( <i>see page 58</i> ), or replace the disc with one which has sufficient capacity for recording.
INDEX FULL. USE ANOTHER DISC.		254 indexes have already been recorded. This message is displayed for about five seconds, and the display returns to normal. → Delete unnecessary indexes ( <i>see page 58</i> ), or replace the disc with one which you can record.
99 INDEXES. CANNOT ADD NEW INDEXES.	99 indexes!	You tried to mark an index in a title on which 99 indexes were already marked, during playback. This message is displayed for about five seconds, and then the display returns to normal. → Delete unnecessary indexes ( <i>see page 58</i> ).
99 INDEXES. MAKE A NEW TITLE.		99 indexes have already been recorded in one title. This message is displayed for about five seconds, and the display returns to normal. → Create a new title.
NO A.B POINT. SET THE A & B POINT.	NO AB POINT!	Points A and/or B are not set. → Set the points that are not set yet, using the REPEAT A-B item of the REPEAT FUNCTION menu ( <i>see page 36</i> ).
THIS TITLE IS PROTECTED.	Protected!	You tried to delete a protected title. You cannot delete protected titles. This message is displayed for about five seconds, and then the display returns to normal.

Message		Cause and remedies
Monitor screen	Front panel display	
CANNOT RECORD THIS SIGNAL.	Can't REC!	You tried to record prohibited signals. This message is displayed for about five seconds, and then the display returns to normal. →Input compatible signals.
PLAYBACK PROHIBITED BY REGION CODE.	REGION CODE!	You tried to play a disc with a region code that is different from that of the unit. The message disappears when the disc tray is opened. →Set the region code of the unit to the same as that of the disc using the REGION CODE sub menu of the SETUP MENU.
KEY INHIBIT MODE IS SELECTED. SET KEY INHIBIT MODE TO OFF.	KEY INHIBIT!	The key lock function is set. This message is displayed for about five seconds, and then the display returns to normal. →Remove the key lock function by setting the KEY INHIBIT sub menu of the SETUP MENU to OFF.
ABNORMAL SETTINGS SELECTED IN SETUP MENU. SET ITEMS IN THE SETUP MENU TO THE APPROPRIATE VALUES. CONTACT SERVICE IF THIS ALARM APPEARS AGAIN AFTER ABOVE PROCEDURE.	ILL. SETUP!	The settings made using the SETUP MENU are wrong. Push any button to make the alarm message disappear, then perform the following operation. →Correct the SETUP MENU settings ( <i>see page 47</i> ). If the settings made are deactivated again or this message appears again, contact your nearest Sony dealer.
NO DISC. INSERT A DISC.	NO DISC!	There is no disc loaded. →Load a disc.
DISC CANNOT BE PLAYED BACK. USE DISC WITH NTSC RECORDING.	PAL DISC!	A disc recorded using the PAL video signal system has been loaded in the unit with the NTSC video signal system set as the default. →Load a disc recorded using the NTSC video signal system.
DISC CANNOT BE PLAYED BACK. USE DISC WITH PAL RECORDING.	NTSC DISC!	A disc recorded using the NTSC video signal system has been loaded in the unit with the PAL video signal system set as the default. →Load a disc recorded using the PAL video signal system.
NOT SUPPORTED DISC. USE DVD+RW DISC.	Not supported!	A disc that cannot be used with the unit has been loaded. The message disappears when the disc tray is opened. →Use a DVD+RW disc that can be used with the unit.
LOADING TIME OVER.	LOADING ERROR!	The unit cannot recognize the disc. →Check the disc or replace the disc with another one.
DISC ERROR.	DISC ERROR!	The unit failed in accessing the disc. →Check the disc or replace the disc with another one.
RECOVERING THE DISC. PLEASE WAIT.	Recovering...	The disc is being recovered. →Wait until the message disappears.
CANNOT RECOVER. CHANGE THE DISC.	Can't Recover!	The unit failed in recovering. →Replace the disc with another one.
FINALIZING THE DISC. PLEASE WAIT.	Finalizing...	The unit is finalizing the disc. →Wait until the message disappears.
CANNOT FINALIZE THIS DISC. CHECK THE DISC.	Fin. Failed!	The unit failed in finalizing. →Replace the disc with another one.
FORMATTING THE DISC. PLEASE WAIT.	Formatting...	The disc is being formatted. →Wait until the message disappears.
CANNOT FORMAT THIS DISC.	Init. Failed!	The unit failed in formatting. →Replace the disc with another one.

# Troubleshooting

If the unit appears to be malfunctioning, please check the following before contacting your Sony dealer.

Symptom	Cause and remedies
Even if you push the power switch on the front panel, the power is not turned on. (The standby indicator is not lit.)	<ul style="list-style-type: none"> <li>The MAIN POWER switch located on the rear panel is set to the ● (off) position. →Set the MAIN POWER switch to the I (on) position (see page 15).</li> <li>The AC power cord is disconnected. →Check whether or not the power cord is disconnected from the AC outlet, or that it is connected correctly (see page 13).</li> </ul>
The unit does not work correctly. For example, The buttons do not work. The unit cannot record or play back.	The unit may not work correctly due to the influence of static electricity. →Push the ⏻ (power) switch on the front panel to turn the power off, and then set the MAIN POWER switch on the rear panel to the ● (off) position (see page 15). Next, disconnect the AC power cord. After a while, re-connect the AC power cord and turn the power on again.
The disc tray does not open even if you push the OPEN/CLOSE button.	After you record or edit data on the disc, it may take several seconds for the disc tray to open. This is because the unit adds certain required information to the disc. It is not a malfunction.
The power is turned on, but, images are not displayed on the monitor. Or the image is distorted.	<ul style="list-style-type: none"> <li>The connecting cords have been removed from the input and output connectors on the rear panel. →Connect them correctly (see page 13).</li> <li>The connections of the input and output connectors are wrong. →Connect them correctly (see page 13).</li> <li>The connecting cable is broken. →Check the connecting cables used to connect the unit to other devices.</li> <li>A signal which is different from the one selected using the menu is currently being input. →Select the correct input signal using the INPUT SELECT sub menu of the SETUP MENU (see page 24).</li> <li>The disc is scratched or dirty. →Use a disc without scratches or a clean disc (see page 22).</li> </ul>
The image of the signal input to the VIDEO IN connector is not displayed even though the INPUT SELECT item is set to "ANALOG" in the SETUP MENU.	An S video cable is connected to the S-VIDEO connector. →Remove the S video cable from the S-VIDEO connector (see page 24).

Symptom	Cause and remedies
The sound is not heard. The sound is noisy.	<ul style="list-style-type: none"> <li>The connecting cables have been removed from the input and output connectors on the rear panel. →Re-connect them (see page 13).</li> <li>The connections of the input and output connectors are wrong. →Connect them correctly (see page 13).</li> <li>The connecting cable is broken. →Check the connecting cables used to connect the unit to other devices.</li> <li>The unit is in fast forward or fast reverse playback mode. →Press the ▶PLAY button (see page 34).</li> <li>The disc is scratched or dirty. →Use a disc without scratch or clean disc (see page 22).</li> </ul>
The unit cannot record.	<ul style="list-style-type: none"> <li>You tried to use a disc that is write-protected. →Replace that disc with one on which data can be recorded.</li> <li>The remaining capacity of the disc is insufficient. →Replace the disc.</li> <li>49 titles have been already recorded. In this case, you cannot record any more data, even if the disc has sufficient capacity remaining. →Erase unnecessary titles or replace the disc (see page 44).</li> <li>A disc that cannot be used with the unit has been loaded. →Use a DVD+RW disc (see page 22).</li> </ul>
The unit cannot play.	<ul style="list-style-type: none"> <li>A disc has not yet been loaded. →Load a disc (see page 22).</li> <li>A disc on which no data has been recorded has been loaded. →Load a recorded disc.</li> <li>The disc has been loaded cooked. →Load the disc correctly (see page 22).</li> <li>A disc that cannot be used with the unit has been loaded. →The unit cannot play a disc other than the one recorded with the DVD+RW format.</li> <li>A disc with a region code different from that of the unit has been loaded. →Play a disc with a region code that is the same as that of the unit (see page 48).</li> <li>When the unit plays a disc recorded using other equipment, a disc that has not been finalized cannot be played. →Finalize the disc (see page 32).</li> </ul>
During playback, the image is frozen for a moment (about one second) and the audio breaks up.	The unit stops playback between titles, and after about one second, starts playback of the next title. This is not a malfunction.
The data on the disc is damaged.	Contact your nearest Sony dealer.

# Specifications

## General

Recording /playback format	DVD +VR format Video: MPEG-2 @ML(CBR, VBR) Audio: Dolby digital 2 CH
Signal format system	NTSC/PAL (switchable using the menu)
Power requirements	100 to 240 V AC, 50/60 Hz
Input current	0.56 A to 0.28 A
Operating temperature	5°C to 40°C (41°F to 104°F)
Operating humidity	20% to 80% (no condensation allowed)
Storage and transport temperature	-20°C to +60°C (-4°F to 140°F)
Storage and transport humidity	75% or less (no condensation allowed)
Mass	Approx. 6 kg (13 lb 4 oz)
Dimensions	Approx. 212 × 128.5 × 382 mm (w/h/d) (8 3/8 × 5 1/8 × 15 1/8 inches) (including the maximum projecting parts)

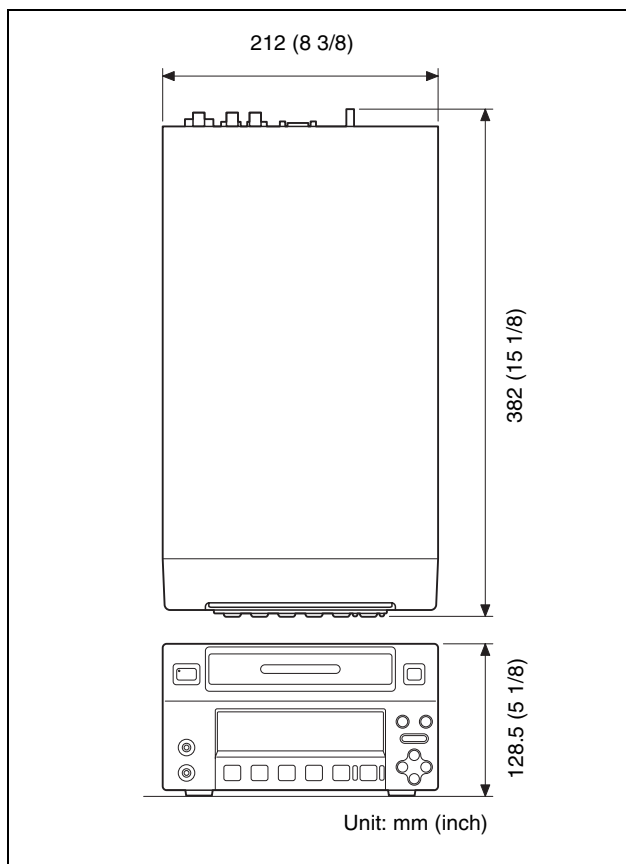

## Input/Output Connectors

### Analog video inputs

VIDEO IN (BNC type × 2, loop-through with 75 Ω automatic terminator), Composite, 1.0 Vp-p, 75 Ω, sync negative  
S-VIDEO IN (4-pin mini DIN × 2, loop-through with 75 Ω automatic terminator)  
Y: 1.0 Vp-p  
C: 0.286 Vp-p (NTSC), 0.3 Vp-p (PAL), color burst, 75 Ω, sync negative

### Analog video outputs

VIDEO OUT (BNC type × 1)  
Composite, 1.0 Vp-p, 75 Ω, sync negative  
S-VIDEO OUT (4-pin mini DIN × 1)  
Y: 1.0 Vp-p  
C: 0.286 Vp-p (NTSC), 0.3 Vp-p (PAL), color burst, 75 Ω, sync negative

### Analog audio inputs

AUDIO IN L/R (Phono jack × 1 for each channel), 2 Vrms (Full bit), input impedance 47 kΩ or more, unbalanced

### Analog audio outputs

AUDIO OUT L/R (Phono jack × 1 for each channel), 2 Vrms (Full bit), load impedance 47 kΩ, unbalanced  
MONITOR AUDIO (Phono jack × 1) 2 Vrms (Full bit), load impedance 47 kΩ, unbalanced

### Digital signal

• DV IN (i.LINK)  
6-pin, complying with IEEE1394

## Control Signals

- REMOTE 1 Stereo mini jack, for connection of an SVRM-100A remote control unit (not supplied)
- REMOTE 2 Mini jack, for connection of a foot switch (not supplied)
- REMOTE IN RS-232C  
D-sub 9-pin, asynchronous serial
- USB (Universal Serial Bus)  
Specification Revision 2.0 (up to Full Speed)



## Others

### Supplied accessories

- DPW120MD DVD+RW Disc (1)
- DVD InfoEditor Editing Software (1)
- Before Using This Unit (1)
- CD-ROM (1)
- Warranty booklet (1)

### Accessories not supplied

- SVRM-100A Remote Control Unit

## Medical Specifications

Protection against electric shock:

Class I

Protection against harmful ingress of water:

Ordinary

Degree of safety in the presence of a flammable anesthetic mixture with air or with oxygen or nitrous oxide:  
Not suitable for use in the presence of a flammable anesthetic mixture with air or with oxygen or nitrous oxide

Mode of operation:

Continuous

Design and specifications are subject to change without notice.

## Using an SVRM-100A Remote Control Unit (Not Supplied)

An SVRM-100A connected to the REMOTE 1 connector on the front panel allows you to control the unit remotely. You can mark indexes and search for the desired indexes using the jog/shuttle dial.

This section describes the location and function of parts and search operations that you can carry out using the SVRM-100A.

## Location and Function of Parts

This section describes the functions used for operating the unit. The buttons on the SVRM-100A corresponding to ones on the unit have the same function.

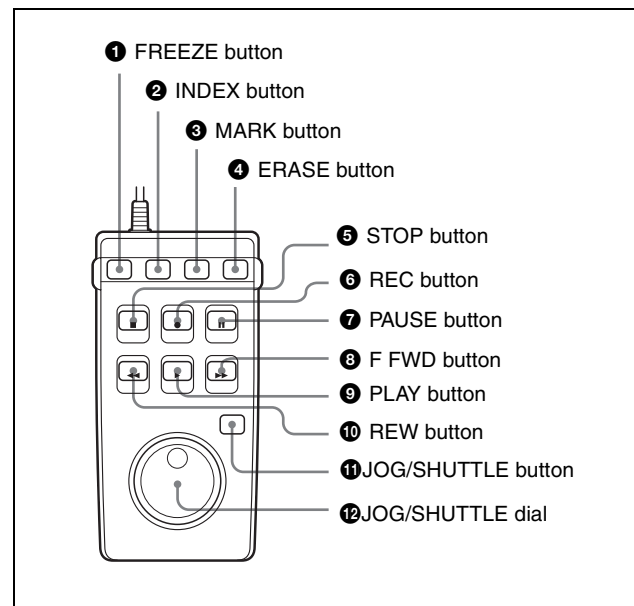

### 1 FREEZE button

Outputs the FREEZE command.

### 2 INDEX button

Outputs the INDEX command.

When you press this button once, the unit enters in the index scan mode. When you press this button twice, the unit enters in the index search mode.

### 3 MARK button

Outputs the MARK command.

### 4 ERASE button

Outputs the ERASE command.

### 5 STOP button

Outputs the STOP command.

- 6 REC button**  
Outputs the REC command.
- 7 PAUSE button**  
Outputs the PAUSE command.  
When the unit receives this command during playback, it pauses playback.  
When the unit receives this command during recording, it pauses recording.
- 8 F FWD button**  
Has the same function as the ►►NEXT/DOWN button of the unit.
- 9 PLAY button**  
Outputs the PLAY command.
- 10 REW button**  
Has the same function as the ◀◀PREV/UP button of the unit.
- 11 JOG/SHUTTLE button**  
To play back in jog/shuttle mode using the jog/shuttle dial, press this button. The indicator lights up.
- 12 JOG/SHUTTLE dial**  
The playback direction and speed are determined according to the position of the shuttle dial, and the search command is output.  
The jog dial becomes effective when the shuttle dial is set to the STILL position.  
The playback speed and direction are determined according to the direction in which the dial is turned and the speed, and the search command is output.

---

## Marking Indexes

You can mark indexes at the desired point during recording and playback.

- 1** Set the unit in the recording or playback mode.
- 2** Press the MARK button at the instant when the image to which the index is to be put is displayed.  
  
You can mark up to 99 indexes in one title and up to 254 indexes on one disc.

---

## Searching for a Particular Image - Index Scanning

- 1** Load a disc on which indexes are recorded.
- 2** Set the unit in stop mode or playback mode.

- 3** Press the INDEX button on the remote control unit one time.  
  
The INDEX command is sent and the unit is put in the index scan mode.

- 4** To search for an image located before the current position, press the REW button.

To search for an image located after the current position, press the F FWD button.

When the unit detects an index signal, the unit plays back the image recorded at that point for about 10 seconds, and then searches for the next index signal.

The unit searches for the index signals repeatedly up to the beginning or end of the disc.

### To cancel the index scan mode

The index scan mode is automatically cancelled when the unit searches as far as the beginning or end of the disc. To cancel the index scan mode before reaching the beginning or end of the disc, press any one among STOP button, PLAY button, ◀ and ▶ buttons of the unit and the SVRM-100.

---

## Cuing a Particular Image by Specifying an Index Number - Index Search

- 1** Load a disc on which indexes are recorded.
- 2** Set the unit in stop or playback mode.
- 3** Press the INDEX button on the remote control unit twice.  
The unit enters in the index search mode.
- 4** Specify the desired index number by pressing the INDEX button on the control unit the number of times that corresponds to the number of the desired index.
- 5** To search for an image located before the current position, press the REW button.  
To search for an image located after the current position, press the F FWD button.

---

## Erasing an Index

You can erase indexes marked by pressing the MARK button of the SVRM-100A remote control unit. Proceed as follows to erase an index.

**Note**

You cannot erase indexes created at the beginning of recording, ones created by pressing the **|||PAUSE** button of the unit during recording, or ones marked automatically by setting the AUTO INDEX sub menu to ON (*see page 47*).

- 1** Set the unit in the index scan mode.
- 2** Search for the index to be erased.
- 3** Press the ERASE button.

The index searched in step 2 is erased.  
In this case, the segment of that chapter is added to the previous chapter and they become one chapter.



---

# Glossary

## Bit rate

Bit rate is the value indicating amount of compressed information recorded on the DVD disc per one second. The unit is Mbps (Mega bits per second) for video signals.

1Mbps indicates that the amount of information per second is 1,000,000 bits. For audio signals, kbps (kilo bits per second) is used. The larger this value, the larger the amount of information involved. However, this value does not relate to the picture and sound quality.

## Chapter

A segment of an image divided by two indexes.

## Dolby Digital format

Dolby Digital is an audio data compression technology developed by Dolby Laboratories. This is known as "Dolby Surround." The output signals are composed of 1 channel of woofer for playback of the low sound, in addition to right and left of front, center, and right and left of rear. This is called 5.1 channel surround. 2-channel playback is available for the DVO-1000MD.

## Finalize

To arrange data on a recorded DVD disc so that it can be played back with another piece of DVD equipment.

A DVD+RW disc is finalized when it is unloaded after being recorded. However, finalization is required even when a disc is played back using equipment compatible with DVD+RW discs. The disc can be recorded on again even if it is finalized.

## Index

An index is a mark put at a desired point during playback or recording. The DVO-1000MD can place up to 99 indexes for one title and up to 256 indexes on one disc.

## Mbps

Mbps is the abbreviation of Mega bits per second.

Mbps is used to indicate the transmission speed of data. Bit is the unit used to indicate the size of data handled in computers. 1Mbps means that 1,000,000 digital signals can be handled for one second.

## Original title

Titles actually recorded on the DVD+RW (VR mode).

Once they are edited, they cannot be restored to their original state.

## Region code

A code to specify the region where the disc can be played back. DVD recorders and DVD players have their own region codes. A disc can be played back only when the region codes of both the player and the recorder are the same.

## Title

The largest unit of images or music recorded on a DVD. Normally, for image software, one film is one title, and for music software, one album (or a piece of music) is one title. With the DVO-1000MD, one title is the image recorded from the start of recording to the end of recording.

# Index

- A**
  - A-B repeat playback 36
- C**
  - Chapter
    - jumping to 35
    - repeat playback 38
  - Connection 13
  - Copyrights 6
- D**
  - Date and time setting 18
  - Disc
    - finalizing 32
    - formatting 33
    - loading and unloading 22
    - notes on handling 22
    - playing 34
    - usable discs for playback 34
    - usable discs for recording 22
    - verifying information 40
- F**
  - Features 7
  - Finalizing 32
  - Formatting a disc 33
- I**
  - Index
    - adding during playback 34
    - marking 58
    - marking during recording 27
  - Input signal setting 24
- L**
  - Locations and function of parts
    - front panel 8
    - rear panel 11
- M**
  - Menu
    - basic operation 50
    - configuration 46
    - DISC INFORMATION menu 46
    - ENHANCED MENU 48
    - list 46
    - REPEAT FUNCTION menu 46
    - SETUP MENU 47
  - Messages
    - alarm messages 52
    - error messages 52
- P**
  - Playback
    - A-B repeat playback 36
    - adding indexes during playback 34
    - disc 34
    - fast forward or reverse 34
    - from the TITLE LIST display 39
    - jumping to a desired chapter 35
    - jumping to a desired title 35
    - viewing frozen picture 41
  - Power on/off 15
  - Precautions 5
- R**
  - Recording
    - marking indexes 27
    - preparations 24
    - selecting the input signals 24
    - selecting the recording mode 25
    - titles 26
  - Recording mode setting 25
  - Remote interface setting 20
  - Repeat playback
    - playback of a chapter 38
    - playback of a title 38
  - RM-P110 (not supplied) 29
- S**
  - Setup
    - disc end setting when recording 30
    - previous recording function 29
    - selecting a video signal system 16
    - selecting the input signal 24
    - setting the remote interface 20
    - using a foot switch 28
  - Specifications 56
  - SVRM-100A remote control unit (not supplied)
    - index scanning 58
    - index search 58
    - location and function of parts 57
    - marking indexes 58
- T**
  - Title
    - adding information 29
    - erasing 44
    - jumping 35
    - protecting 43
    - repeat playback 38
    - verifying information 42
    - verifying/editing a title name 42
    - verifying/editing title information 42
  - Troubleshooting 55
- V**
  - Video signal system setting 16



## Free Manuals Download Website

<http://myh66.com>

<http://usermanuals.us>

<http://www.somanuals.com>

<http://www.4manuals.cc>

<http://www.manual-lib.com>

<http://www.404manual.com>

<http://www.luxmanual.com>

<http://aubethermostatmanual.com>

Golf course search by state

<http://golfingnear.com>

Email search by domain

<http://emailbydomain.com>

Auto manuals search

<http://auto.somanuals.com>

TV manuals search

<http://tv.somanuals.com>