

# *Professional Disc Recorder*

---

## **Operating Instructions**

Before operating the unit, please read this manual thoroughly and retain it for future reference.

**XDCAM HD**   
Professional Disc System Professional Disc

**MPEG HD**  **CINEALTA**

**CE**

**PDW-F70**

## Important Safety Instructions

- Read these instructions.
- Keep these instructions.
- Heed all warnings.
- Follow all instructions.
- Do not use this apparatus near water.
- Clean only with dry cloth.
- Do not block any ventilation openings. Install in accordance with the manufacturer's instructions.
- Do not install near any heat sources such as radiators, heat registers, stoves, or other apparatus (including amplifiers) that produce heat.
- Do not defeat the safety purpose of the polarized or grounding-type plug. A polarized plug has two blades with one wider than the other. A grounding-type plug has two blades and a third grounding prong. The wide blade or the third prong are provided for your safety. If the provided plug does not fit into your outlet, consult an electrician for replacement of the obsolete outlet.
- Protect the power cord from being walked on or pinched particularly at plugs, convenience receptacles, and the point where they exit from the apparatus.
- Only use attachments/accessories specified by the manufacturer.
- Use only with the cart, stand, tripod, bracket, or table specified by the manufacturer, or sold with the apparatus. When a cart is used, use caution when moving the cart/apparatus combination to avoid injury from tip-over.



- Unplug this apparatus during lightning storms or when unused for long periods of time.
- Refer all servicing to qualified service personnel. Servicing is required when the apparatus has been damaged in any way, such as power-supply cord or plug is damaged, liquid has been spilled or objects have fallen into the apparatus, the apparatus has been exposed to rain or moisture, does not operate normally, or has been dropped.

## WARNING

**To reduce the risk of fire or electric shock, do not expose this apparatus to rain or moisture.**

**To avoid electrical shock, do not open the cabinet. Refer servicing to qualified personnel only.**

**THIS APPARATUS MUST BE EARTHED.**

## CAUTION

The apparatus shall not be exposed to dripping or splashing and no objects filled with liquid, such as vases, shall be placed on the apparatus.

## CAUTION

The unit is not disconnected from the AC power source (mains) as long as it is connected to the wall outlet, even if the unit itself has been turned off.

## IMPORTANT

The nameplate is located on the bottom.

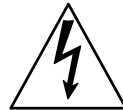
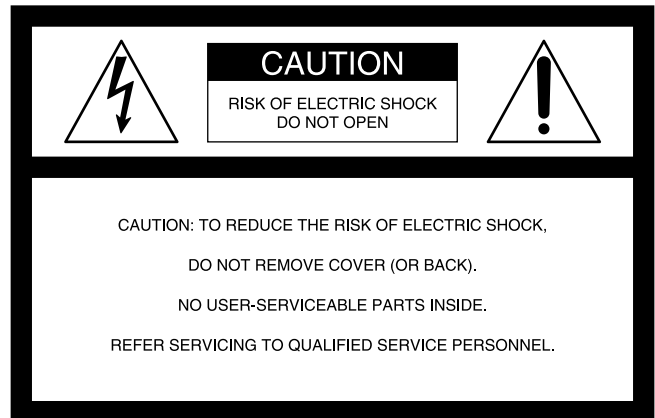

This symbol is intended to alert the user to the presence of uninsulated "dangerous voltage" within the product's enclosure that may be of sufficient magnitude to constitute a risk of electric shock to persons.



This symbol is intended to alert the user to the presence of important operating and maintenance (servicing) instructions in the literature accompanying the appliance.

**WARNING: THIS WARNING IS APPLICABLE FOR USA ONLY.**

If used in USA, use the UL LISTED power cord specified below.  
**DO NOT USE ANY OTHER POWER CORD.**

Plug Cap	Parallel blade with ground pin (NEMA 5-15P Configuration)
Cord	Type SJT, three 16 or 18 AWG wires
Length	Minimum 1.5 m, Less than 2.5 m (8 ft 3 in)
Rating	Minimum 10 A, 125 V

Using this unit at a voltage other than 120 V may require the use of a different line cord or attachment plug, or both. To reduce the risk of fire or electric shock, refer servicing to qualified service personnel.

**WARNING: THIS WARNING IS APPLICABLE FOR OTHER COUNTRIES.**

1. Use the approved Power Cord (3-core mains lead)/Appliance Connector/Plug with earthing-contacts that conforms to the safety regulations of each country if applicable.
2. Use the Power Cord (3-core mains lead)/Appliance Connector/Plug conforming to the proper ratings (Voltage, Ampere).

If you have questions on the use of the above Power Cord/ Appliance Connector/Plug, please consult a qualified service personnel.

When installing the installation space must be secured in consideration of the ventilation and service operation.

- Do not block the ventilation slots at the left side and right side panels, and vents of fans.
- Leave a space around the unit for ventilation.
- Leave more than 10 cm of space in the rear of the unit to secure the operation area.

When the unit is installed on the desk or the like, leave at least 5 cm of space in the left and right sides.



This Professional Disc Recorder is classified as a CLASS 1 LASER PRODUCT.

#### Laser diode properties

Wave length: 403 to 410 nm

Emission duration: Continuous

Laser output power: 65 mW (max. of pulse peak), 35 mW (max. of CW)

#### Tekniska data för laserdiod

Våglängd: 403 till 410 nm

Emissionslängd: Kontinuerlig

Laserut effekt: 65 mW (max. för pulstopp), 35 mW (max. för kontinuerlig våg)

#### Spesifikasjoner laserdiod

Bølgelengde: 403 til 410 nm

Strålingens varighet: Kontinuerlig

Laserens effekt: 65 mW (maks stråletoppunkt), 35 mW (maks ved kontinuerlig stråling)

#### Laserdiodin ominaisuudet

Aallon pituus: 403 - 410 nm

Välityksen kesto: Jatkuva

Laserlähdon teho: 65 mW (sykehuipun maks.), 35 mW (jatkuvan aallon maks.)

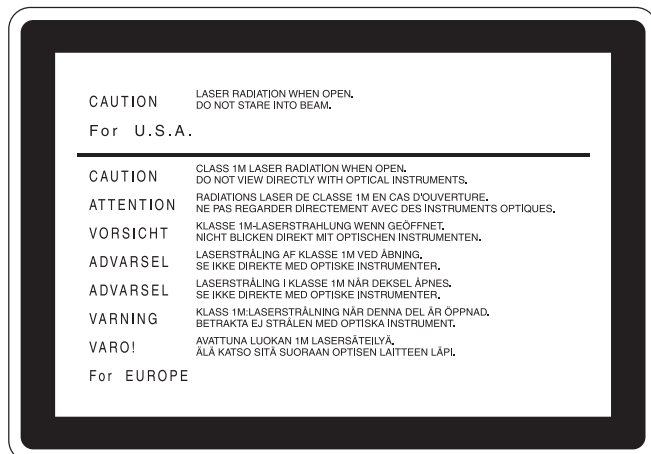

This label is located on the top panel of the drive unit.

Denna etikett finns på ovansidan av driftenheten.

Denne mærkat sidder på drevenhedens øverste panel.

Tämä kyltti sijaitsee ajurilaitteen yläpinnalla.

Dette merket er plassert på oversiden av driverenheten.

#### CAUTION

The use of optical instruments with this product will increase eye hazard.

#### CAUTION

Use of controls or adjustments or performance of procedures other than those specified herein may result in hazardous radiation exposure.

#### VAROITUS!

LAITTEEN KÄYTTÄMINEN MUULLA KUIN TÄSSÄ KÄYTTÖOHJEESSA MAINITULLA TAVALLA SAATTAA ALTISTAA KÄYTTÄJÄN TURVALLISUUSLUOKAN 1 YLITTÄVÄLLE NÄKYMÄTTÖMÄLLE LASERSÄTEILYLLE.

#### WARNING

OM APPARATEN ANVÄNDS PÅ ANNAT SÄTT ÄN I DENNA BRUKSANVISNING SPECIFICERATS, KAN ANVÄNDAREN UTSÄTTAS FÖR OSYNLIG LASERSTRÅLNING, SOM ÖVERSKRIDER GRÄNSEN FÖR LASERKLASS 1.

#### For the customers in the USA

This equipment has been tested and found to comply with the limits for a Class A digital device, pursuant to Part 15 of the FCC Rules. These limits are designed to provide reasonable protection against harmful interference when the equipment is operated in a commercial environment. This equipment generates, uses, and can radiate radio frequency energy and, if not installed and used in accordance with the instruction manual, may cause harmful interference to radio communications. Operation of this equipment in a residential area is likely to cause harmful interference in which case the user will be required to correct the interference at his own expense.

You are cautioned that any changes or modifications not expressly approved in this manual could void your authority to operate this equipment.

All interface cables used to connect peripherals must be shielded in order to comply with the limits for a digital device pursuant to Subpart B of Part 15 of FCC Rules.

This device complies with Part 15 of the FCC Rules. Operation is subject to the following two conditions: (1) this device may not cause harmful interference, and (2) this device must accept any interference received, including interference that may cause undesired operation.

#### For the State of California, USA only

Perchlorate Material - special handling may apply, See

[www.dtsc.ca.gov/hazardouswaste/perchlorate](http://www.dtsc.ca.gov/hazardouswaste/perchlorate)

Perchlorate Material : Lithium battery contains perchlorate.

#### For customers in Canada

This Class A digital apparatus complies with Canadian ICES-003.

### For the customers in Europe

This product with the CE marking complies with both the EMC Directive (89/336/EEC) and the Low Voltage Directive (73/23/EEC) issued by the Commission of the European Community. Compliance with these directives implies conformity to the following European standards:

- EN60065: Product Safety
- EN55103-1: Electromagnetic Interference (Emission)
- EN55103-2: Electromagnetic Susceptibility (Immunity)

This product is intended for use in the following

Electromagnetic Environment(s):

E1 (residential), E2 (commercial and light industrial), E3 (urban outdoors) and E4 (controlled EMC environment, ex. TV studio).

### For the customers in Taiwan only



廢電池請回收

### Voor de Klanten in Nederland



- Gooi de batterij niet weg maar lever deze in als klein chemisch afval (KCA).
- Dit apparaat bevat een vast ingebouwde batterij die niet vervangen hoeft te worden tijdens de levensduur van het apparaat.
- Raadpleeg uw leverancier indien de batterij toch vervangen moet worden. De batterij mag alleen vervangen worden door vakbekwaam servicepersoneel.
- Lever het apparaat aan het einde van de levensduur in voor recycling, de batterij zal dan op correcte wijze verwerkt worden.

---

# Table of Contents

---

## Chapter 1 Overview

<b>Features</b> .....	<b>9</b>
Features of This Unit.....	9
Features of the PDBK-101/102/103/104 Option Boards .....	11
<b>Names and Functions of Parts</b> .....	<b>12</b>
Front Panel .....	12
Rear Panel.....	18
Infrared Remote Commander .....	21

---

## Chapter 2 Preparations

<b>Setting the System Frequency</b> .....	<b>23</b>
<b>Connections and Settings</b> .....	<b>24</b>
Connecting an External Monitor .....	24
Using PDZ-1 Over an i.LINK Connection (FAM Connection).....	25
Connecting to a Nonlinear Editing System (AV/C Connection) .....	26
Connections for Cut Editing.....	26
Editing Control Unit Settings .....	29
Remote Control Unit Settings .....	29
Using XLR Cables (Audio Cables) .....	29
<b>External Synchronization</b> .....	<b>30</b>
<b>Setup</b> .....	<b>31</b>
Setting the Date and Time .....	31
Adjusting the Brightness of the LCD Panel .....	31
<b>24P (23.98P) Mode Settings</b> .....	<b>33</b>
Selecting the Playback Mode (23.98PsF or 2-3 Pulldown).....	33
Input and Output Signals in 24P (23.98P) Mode .....	34
Recording in 24P (23.98P) Mode.....	35
Playback in 24P (23.98P) 2-3 Pulldown Mode .....	35
<b>Superimposed Text Information</b> .....	<b>37</b>
Displaying Supplementary Status Information .....	38

---

## Chapter 3 Recording and Playback

<b>Handling Discs</b> .....	<b>40</b>
Discs Used for Recording and Playback .....	40

Notes on Handling.....	40
Write-Protecting Discs .....	40
Loading and Unloading a Disc .....	40
Formatting a Disc .....	41
Handling of Discs When Recording Does Not End Normally (Salvage Functions) .....	41
<b>Recording .....</b>	<b>43</b>
Recording Timecode and User Bit Values .....	43
Carrying Out Recording .....	45
<b>Playback .....</b>	<b>47</b>
Playback Operation .....	47
Searching for Clips With Thumbnails (Thumbnail Search).....	49
Searching With the Expand Function.....	50
Searching for Frames With Essence Marks .....	51
Searching With the Chapter Function .....	52
Clip List Playback .....	53
Repeat Playback .....	53
Locking (Write-protecting) Clips .....	54
Deleting Clips .....	55
Assigning Sequence Numbers to Thumbnails.....	56

---

## Chapter 4 Scene Selection

<b>Overview .....</b>	<b>57</b>
Assigning Clip Titles.....	60
Assigning User-Defined Clip and Clip List Names .....	60
<b>Creating Clip Lists .....</b>	<b>62</b>
Including Clips Selected in the Thumbnail Screen in the Clip List ...	62
Quick Scene Selection (Adding Sub Clips During Recording, Playback, or Search) .....	65
<b>Editing Clip Lists .....</b>	<b>67</b>
Basic Operations.....	67
Reordering Sub Clips .....	67
Modifying the In and Out Points of Sub Clips (Trimming) .....	68
Deleting Sub Clips.....	69
Setting the Start Timecode for the Current Clip List .....	69
Previewing the Edited Clip List .....	69
<b>Saving the Current Clip List to Disc .....</b>	<b>70</b>
<b>Managing Clip Lists .....</b>	<b>71</b>
Changing Displayed Items of Information on Sub Clips .....	72
Loading a Clip List From a Disc Into the Current Clip List .....	72
Deleting Clip Lists From a Disc.....	72

Sorting Clip Lists.....	72
<b>Using the PDZ-1 Proxy Browsing Software .....</b>	<b>74</b>

---

## Chapter 5 File Operations

<b>Overview .....</b>	<b>75</b>
Directory Structure .....	75
File Operation Restrictions.....	76
<b>File Operations in File Access Mode .....</b>	<b>78</b>
Making FAM Connections .....	78
Operating on Files .....	79

---

## Chapter 6 Menus

<b>Function Menu .....</b>	<b>81</b>
Function Menu Operations .....	81
Function Menu Settings.....	81
<b>System Menu.....</b>	<b>83</b>
Displaying the Setup and Disc Menus .....	83
Setup Menu.....	84
Setup Menu Items.....	86
Setup Menu Operations .....	96
Disc Menu .....	98
Disc Menu Operations.....	99

---

## Chapter 7 Using Option Boards

<b>Option Boards for Enhanced Functionality .....</b>	<b>101</b>
<b>Using the PDBK-101 Network Board (Gigabit Ethernet) .....</b>	<b>101</b>
Computer Connection Example (FTP Connection) .....	101
<b>Using the PDBK-102 MPEG-TS Input/Output Board.....</b>	<b>102</b>
HDV Connection Example.....	102
<b>Using the PDBK-103 Analog HD Input Board .....</b>	<b>103</b>
Camcorder Connection Example.....	103
<b>Using the PDBK-104 SD Input Upconverter Board.....</b>	<b>104</b>
Disc Recorder Connection Example .....	104

---

## Appendix

<b>Important Notes on Operation</b> .....	<b>105</b>
Condensation .....	105
<b>Periodic Maintenance</b> .....	<b>106</b>
Digital Hours Meter.....	106
<b>Troubleshooting</b> .....	<b>107</b>
Alarms .....	107
Error Messages .....	114
To Eject Discs With the Unit Powered Off.....	114
<b>About i.LINK</b> .....	<b>114</b>
<b>Specifications</b> .....	<b>115</b>
<b>Using UMID Data</b> .....	<b>118</b>
<b>MPEG-4 Visual Patent Portfolio License</b> .....	<b>120</b>
<b>Glossary</b> .....	<b>121</b>
<b>Index</b> .....	<b>123</b>



## Features

The PDW-F70 is a professional disc recorder supporting HD playback and recording with Professional Disc <sup>1)</sup> media.

When you use this unit in combination with a nonlinear editing system, the FAM <sup>2)</sup> function enables data file transfers between the unit and computers over the i.LINK interface, allowing the unit to be used like an external hard drive. Its compact design, which also permits vertical placement, saves installation space on the desktop. The unit can be used as a player for video editing and program output, and as a recorder for nonlinear editing. For these applications, it can be connected to Sony nonlinear editors, monitors, and video equipment with HDSDI interfaces via its standard HDSDI I/O connectors. It incorporates a color LCD display, allowing you to check video and use the menu system without connecting an external monitor.

1) Professional Disc is a trademark of Sony Corporation.

2) FAM: File access mode

## Features of This Unit

The principal features of this unit are as follows.

### MPEG HD <sup>1)</sup> codec

#### High-quality video and audio recording and playback

The MPEG HD codec provides video compression compliant with the MPEG-2 MP@HL standard. It enables HD 4:2:0 digital component file recording in the 1080i (1,080 effective scanning lines, interlaced) format currently in use by many broadcast facilities. Uncompressed PCM recording of 16-bit 48 kHz audio delivers a wide dynamic range with a high signal-to-noise ratio.

1) MPEG HD is a trademark of Sony Corporation.

#### Video bitrates and audio channels selectable according to application

You can select the appropriate video bitrate for your application from three video bitrate modes: 35 Mbps (HQ: high quality mode), 25 Mbps (SP: standard mode), and 18 Mbps (LP: long-play mode). You can select 2-channel or 4-channel audio, with the ability to record 120 minutes or more of audio. If the audio channel modes are the same, different video bitrates can be mixed on the same disc.

#### Rich selection of recording and playback functions

##### Support for multiple frame frequencies

The unit can record and play back five different frame frequencies: 1080/59.94i (displayed as 60I), 50i (displayed as 50I), 29.97PsF (displayed as 30P), 25PsF, and 23.98PsF. The unit features a standard 2-3 pulldown function, and can output 60I when playing back a disc recorded in 23.98PsF.

##### HD downconvert function

The unit is provided with a downconvert function. HD disc playback signals can be downconverted to SD signals and then output as SDDSI or composite signals, or output via the i.LINK (DV) interface. This allows you to shoot and record masters in an HD environment, and to use SD nonlinear editors and monitors for editing and program output.

##### DVCAM upconvert function

The unit features an upconvert function, with the ability to upconvert to HD and output HDSDI signals when playing back DVCAM discs.

i.LINK (DV) output is also supported <sup>1)</sup>, allowing you to use nonlinear editors in a standard i.LINK (DV) environment.

1) Input (recording) is not supported.

##### Recording of proxy AV data

Proxy AV data is a low-resolution (1.5 Mbps video, 64 kbps per audio channel), MPEG-4 based version of a full-

resolution data stream. Whenever this unit records full-resolution MPEG HD data, it simultaneously generates and records low-resolution proxy AV data. Because of its small size, proxy AV data can be transferred quickly over computer networks, easily edited in the field with laptop computers,<sup>1)</sup> and readily used in a wide variety of applications, such as content management on small-scale servers.

1) The supplied PDZ-1 Proxy Browsing Software can be used to create simple EDLs (Edit Decision Lists).

### Supports a variety of interfaces

This unit supports the following interfaces.

**HDSDI:** This enables input and output of HD digital video and embedded audio signals (4 channels).

**SDSDI:** This enables output of SD component digital video and embedded audio signals (4 channels).

**AES/EBU:** This enables input and output of AES/EBU serial digital audio signals (4 channels).

**i.LINK (AV/C):** This enables output of DV-format digital video and audio signals (4 channels).

**Analog video:** This enables output of HD analog component (RGB or YPbPr) and SD composite signals.

**Analog audio:** This enables input of 2 channels and output of 2 channels (1/2 or 3/4) of analog audio.

	Input	Output
HDSDI	Video / audio (4 channels)	Video / audio (4 channels)
	BNC connector	BNC connector x2
SDSDI	PDBK-104 (option board)	Video / audio (4 channels)
		BNC connector
Analog video (composite)	PDBK-104 (option board)	Video
		BNC connector, phono jack
AES/EBU	Audio (4 channels)	Audio (4 channels)
	BNC connector x2	BNC connector x2
i.LINK (AV/C)	-	Video / audio (4 channels)
		i.LINK 6-pin
i.LINK (TS)	PDBK-102 (option board)	
Analog video (component)	PDBK-103 (option board)	RGB/YPbPr/HD/VD
		D-sub 15-pin
Analog audio	Audio (2 channels)	Audio (2 channels)
	XLR connector x2	XLR connector x2, phono jack x2

## Convenient disc-based playback and search functions

### Thumbnail searches

An independent clip file is generated whenever recording starts and stops. The first frame of each clip is used as the thumbnail for that clip.

You can display a list of thumbnails on the color LCD or an external monitor, and cue up a desired scene by selecting the corresponding thumbnail.

### Essence mark searches

You can record essence marks at any scene during video recording, or at the recording stop position. You can display a list of essence mark scenes on the color LCD or an external monitor. Essence marks can also be added after recording with the supplied PDZ-1 Proxy Browsing Software.

### Thumbnail expansion

After selecting a clip in the thumbnail list, you can divide the clip into 12 parts and show a list of thumbnails for the first frame in each part. This makes it easy to find the scene you want within the clip. This expansion can be repeated up to 3 times (1728 divisions).

### Scene selection

You can create and play back clip lists of selected clips from the disc, arranged in any order. One disc can store up to 99 clip lists. Clip lists make it simple to perform offline editing in the field for later use with full-scale nonlinear editing systems.

### Repeat playback

You can repeatedly play back any clip or clip list. Unlike tape, discs can return to the first frame as soon as the last frame is played, making this function ideal for presentations with a need for looping content.

## IT friendly

### Computer access to files (file access mode)

Video and audio clip data are recorded as files. The FAM function enables quick random access by computers to the video, audio, and metadata<sup>1)</sup> files stored on Professional Discs, with the ability to display thumbnail lists on the computer screen and perform file-based reads and writes.

1) XDCAM allows you to record various kinds of information about the video and audio data, such as the date of shooting, the editor, the recording format, and comments. This data can be used in the following ways.

- The supplied PDZ-1 Proxy Browsing Software can add titles, comments, and other text data to discs and clips.
- The ability to search metadata for the required audio and video scenes brings greater efficiency to various stages of the video production process (editing, archiving).

## Other features

### High-speed searches by the jog and shuttle dials

Like conventional VTRs, this unit features jog and shuttle dials for searching for specific scenes within clips. The jog/variable mode supports -1 to +2 times normal speed searching in field units. The shuttle mode enables high-speed searching at up to  $\pm 20$  times normal speed.

### Variety of remote control units

- Infrared remote commander (supplied)
- RS-232C 9-pin remote control
- RS-422A 9-pin remote control
- Minijack 4-pole remote control

### Color LCD display

The unit is equipped with a 16:9, 3.5-inch color LCD which allows you to check the contents of the disc and use the menu system without connecting an external monitor.

---

## Features of the PDBK-101/102/103/104 Option Boards

The following option boards provide expanded functions and interfaces for the unit.

### Notes

- Contact your Sony service representative for more information about purchasing and installing option boards.
- Up to two option boards may be installed. Some combinations are not supported.
- Option slot 1: PDBK-101
- Option slot 2: One of the PDBK-102, PDBK-103, and PDBK-104 boards

### PDBK-101 Network Board (Gigabit Ethernet)

Installation of this board provides a gigabit Ethernet connector, which can be used to transfer disc files over LAN networks and to record MXF (Material eXchange Format) files from external devices to discs.

It also allows this unit to be controlled remotely by FTP commands.

### PDBK-102 MPEG-TS (Transport Stream) Input/Output Board

Installation of this board enhances the functionality of the standard i.LINK connector, allowing it to be used as an I/O interface for HDV <sup>1)</sup> 1080i <sup>2)</sup> format compatible TS <sup>3)</sup> signals.

HD files recorded on the disc can be converted to TS signals compatible with the HDV1080i format for transfer to HDV devices and HDV editors, and TS signals from

HDV devices and HDV editors can be converted to MPEG HD compatible files for recording by this unit.

- 1) HDV and **HDV** are trademarks of Sony Corporation and Victor Company of Japan, Limited.
- 2) HDV1080i: Refers to devices compliant with the "HDV1080i Standard" for recording HD signals on DV tape. There are 1080 effective lines.
- 3) TS: MPEG-2 transport streams containing MPEG video, MPEG audio, and control information. This is the standard interface for HDV equipment.

### PDBK-103 Analog HD Input Board

Installation of this board provides analog HD component input connectors, to enable recoding of analog HD component input signals (RGB and YPbPr, Sync) to discs.

### PDBK-104 SD Input Upconverter Board

Installation of this board provides SD input connectors, to allow SD input signals (SDSDI and composite) to be upconverted to HD signals for recording on discs.

### Note

This unit cannot record non-standard composite signals, for example the output of VTRs that are not equipped with time base correctors.

# Names and Functions of Parts

## Front Panel

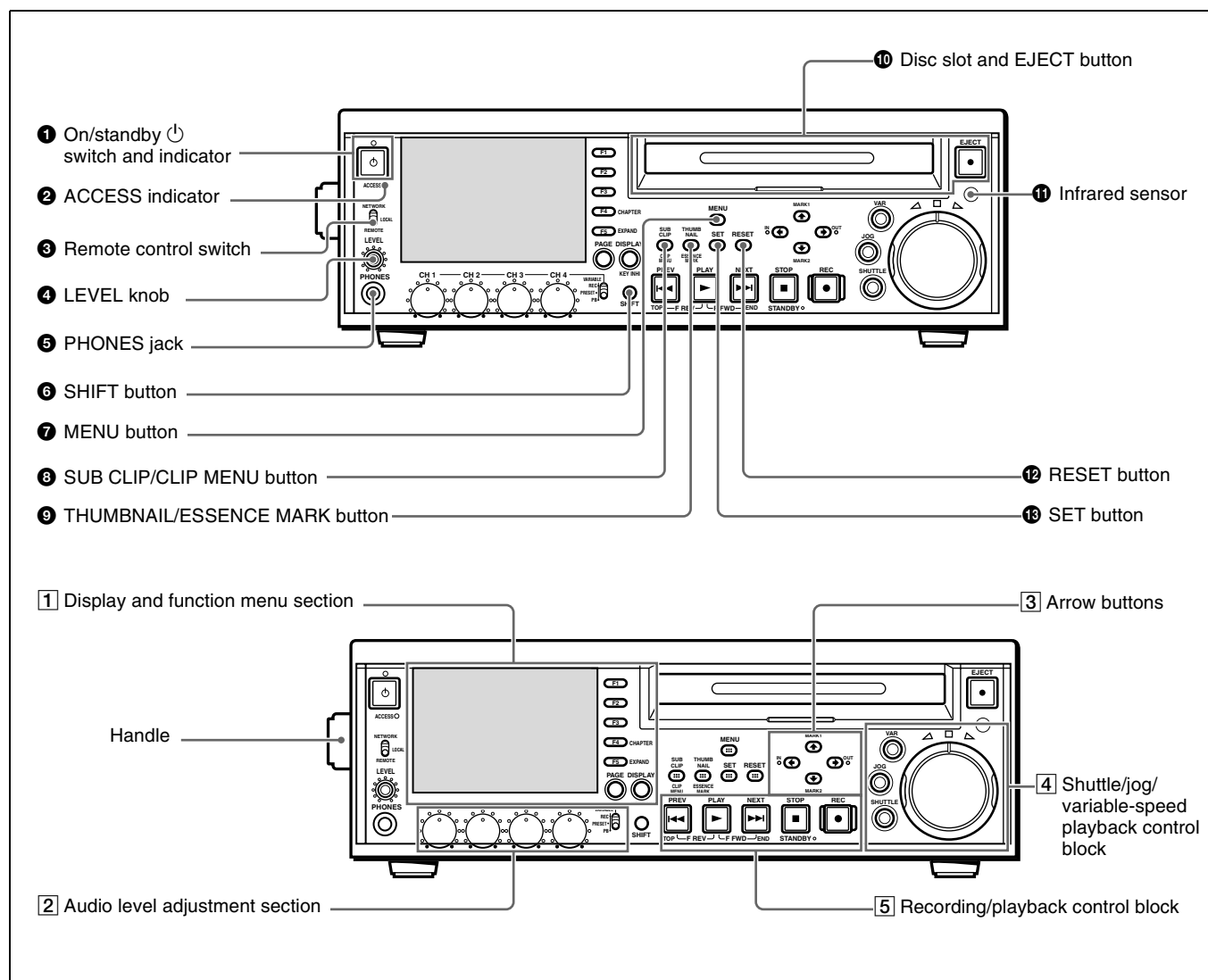

### 1 On/standby $\odot$ switch and indicator

When the POWER switch (*see page 20*) on the rear panel is in the **I** (on) position, this switches the unit between the operating state (the indicator is lit green) and the standby state (the indicator is lit red).

When the indicator is lit red, pressing this switch puts the unit into the operating state. The indicator initially flashes green and then lights green when the unit enters the operating state.

When the indicator is lit green, pressing this switch puts the unit into the standby state. The indicator initially flashes green, and then lights red when the unit enters the standby state.

When using the unit, normally leave the rear panel POWER switch in the **I** (on) position, and use this switch to switch the unit between the operating and standby states.

### 2 ACCESS indicator

This lights blue while a disc is being accessed and while a file is open by a FAM or FTP connection. If the on/standby switch is pressed while this indicator is lit, the unit waits until access to the disc is completed before switching to the standby state.

**Note**

Do not turn off the POWER switch on the rear panel or disconnect the power cord while the ACCESS indicator is lit. Doing so can result in a loss of data on the disc.

**③ Remote control switch**

Different positions of the switch allow different operations, as follows.

**NETWORK:** Enables access to the network. Operation from the front panel of the unit is disabled during access to a network device.

**LOCAL:** Enables operation from the front panel of the unit.

**REMOTE:** Enables remote control of this unit from a device connected to an external device connector on the rear of the unit or from a remote control panel (not supplied) connected to the unit.

Use the setup menu item INTERFACE SELECT >REMOTE I/F to select which of the connectors is used for remote control (see page 94).

**④ LEVEL (audio level adjustment) knob**

This adjusts the volume of the audio output from the PHONES jack. At the same time, it also adjusts the volume of the output from the AUDIO MONITOR connector on the rear panel.

**⑤ PHONES jack (stereo phone jack)**

Connect stereo headphones with an impedance of 8 ohms to monitor audio during recording, playback, and editing. The monitored channel is selected by the MONI CH and MONI SEL items on page P1 of the function menu (see page 82).

**⑥ SHIFT button**

When pressed together with a button having two functions, switches between the functions of the button.

Function button names are displayed in white when the buttons are pressed alone, and in yellow when they are pressed together with the SHIFT button.

**⑦ MENU button**

Use this for system menu operations. The system menu appears in the display when this button is pressed. The same information is also superimposed on the display of a monitor connected to the unit.

Press once more to exit the menu.

For more information about the system menu, see Chapter 6 “Menus” (page 81).

**⑧ SUB CLIP/CLIP MENU button**

This functions as a SUB CLIP button when pressed alone, and as a CLIP MENU button when pressed together with the SHIFT button.

**SUB CLIP button:** Press this button, turning it on, to perform playback of a clip list. A clip list selection

screen appears. To play back the clips in the order they were recorded, press this button again, turning it off. The clip list selection screen disappears.

**Note**

This button does not light, and pressing it has no effect, when no clip lists are registered.

**CLIP MENU button:** Press this button, turning it on, to load, save, or delete a clip list. A clip list menu appears. To erase the clip list screen from the display, press the button again, turning it off.

For details about clip lists, see Chapter 4 “Scene Selection” (page 57).

**⑨ THUMBNAIL/ESSENCE MARK button**

This functions as a THUMBNAIL button when pressed alone, and as an ESSENCE MARK button when pressed together with the SHIFT button.

**THUMBNAIL button:** Press this button, turning it on, to search for a frame by specifying a thumbnail (see page 49), and to create a clip list. A thumbnail selection screen appears on the display. To erase the selection screen from the display, press the button again, turning it off.

**ESSENCE MARK button:** Press this button, turning it on, to search for a frame by specifying an essence mark (see page 51), and to record an essence mark. An essence mark selection list appears. To erase the selection list from the display, press the button again, turning it off.

**⑩ Disc slot and EJECT button**

Insert discs into the disc slot. The indicator flashes in orange, and lights in blue when the disc is completely loaded.

Press the EJECT button to eject a disc. The indicator flashes in blue, and goes off when the disc is completely ejected.

**⑪ Infrared sensor**

This receives signals from the supplied remote commander.

**⑫ RESET button**

Press this button to reset counters. This button is also used to cancel setup menu settings and abandon scene selections (thumbnail search), and to cancel other operations.

**⑬ SET button**

Press this button to confirm menu and scene selection (thumbnail search) settings, and to execute operations.

For details about scene selection, see Chapter 4 “Scene Selection” (page 57).

## 1 Display and function menu section

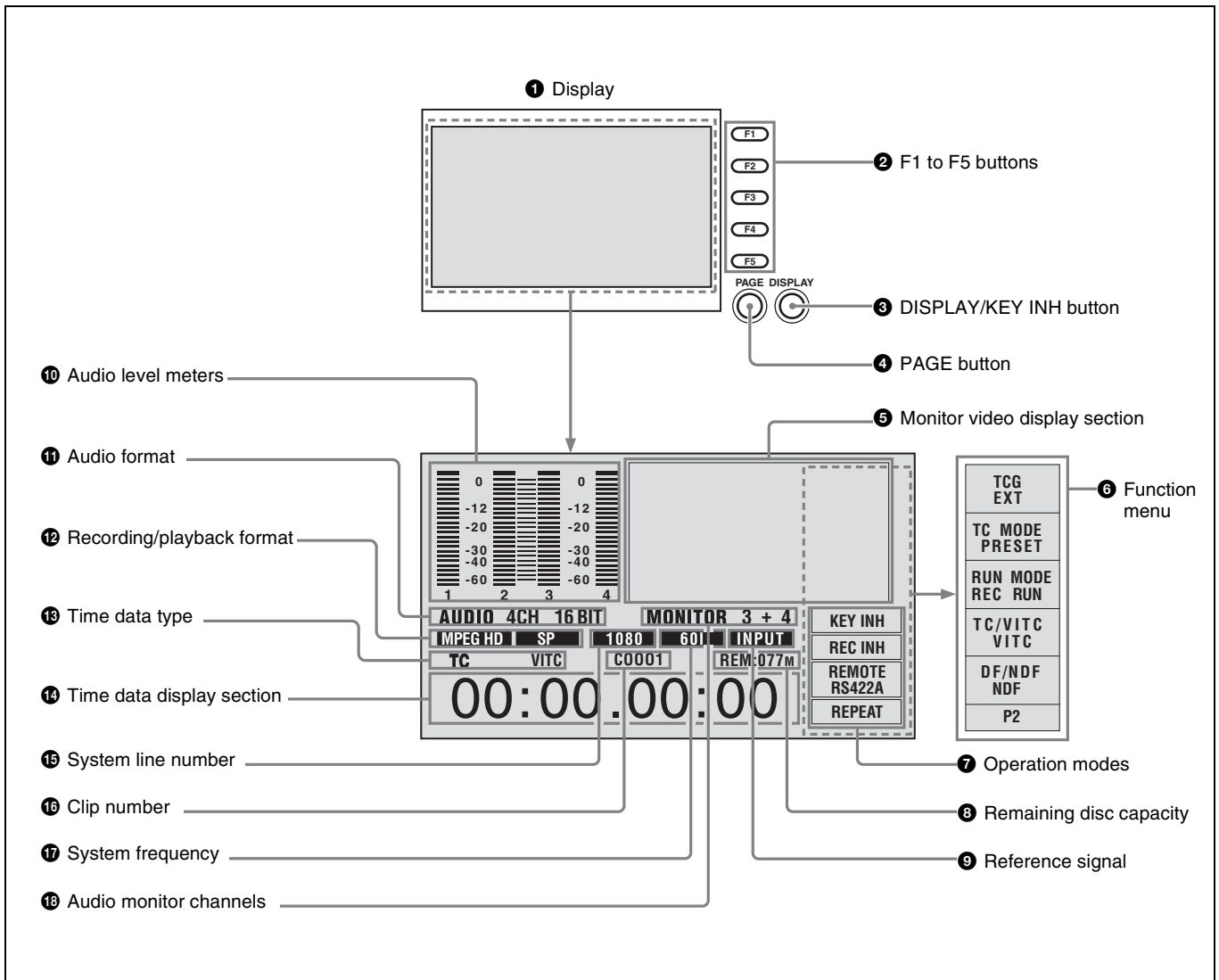

### 1 Display

Normally this displays the audio level meters, timecode, monitor pictures, and current settings. It also displays menus and scene selection (thumbnail search) setting screens.

### 2 F1 to F5 (Function 1 to Function 5) buttons

These buttons are enabled when the function menu (see page 81) is visible. Each press of a button changes the setting of the corresponding item in the menu. When the SUB CLIP and THUMBNAIL buttons are lit, the F4 button functions as a CHAPTER button, and the F5 button functions as an EXPAND button.

### 3 DISPLAY/KEY INH (key operation inhibit mode) button

This functions as a DISPLAY button when pressed alone, and as a KEY INH button when pressed together with the SHIFT button.

**DISPLAY button:** Each press of this button switches the monitor video display section between its three display sizes.

**KEY INH button:** Each press of this button turns key operation inhibit mode on or off.

### 4 PAGE button

This displays the function menu, if it is not already visible. (The most recently accessed page appears.) If the function menu is visible, this button switches between the function menu pages (HOME, P1, P2).

### 5 Monitor video display section

This displays monitor video and the system menu. You can press the DISPLAY button to switch the display of monitor video between three sizes. The largest size occupies the full display screen.

**Note**

Use the largest size to display the system menu and view superimposed information.

**6 Function menu**

Use the PAGE button to display this menu, and to switch between the pages (HOME, P1, P2) of the menu. Each page has five setting items, which correspond to the F1 to F5 buttons. Press the corresponding button to change a setting.

For details, see page 81 “Function Menu” in Chapter 6.

**7 Operation modes**

This displays the current operation modes.

**KEY INH (key operation inhibit mode):** Key operation inhibit mode has been turned on with the KEY INH button.

**REC INH (recording inhibit mode):** Recording inhibit mode has been turned on by setting REC INH on page P1 of the function menu to “ON” (see page 82), or the currently loaded disc is write protected.

**Note**

Recording inhibit mode is also turned on when the settings of the recorded part of the currently loaded disc do not match the current settings (number of recording audio channels, system frequency) of the unit.

**REMOTE/interface name (remote mode):** The remote control switch is set to “REMOTE”. (The interface name corresponds to the setting of INTERFACE SELECT >REMOTE I/F in the setup menu (see page 94).)

**REPEAT (repeat mode):** OPERATIONAL FUNCTION >REPEAT MODE in the setup menu is set to “ON” (see page 86).

**8 Remaining disc capacity**

This displays the remaining capacity on the currently loaded disc.

**9 Reference signal**

This displays the type of reference signal to which this unit is synchronizing.

When there is no display, the unit is synchronizing to the internal reference signal.

**INPUT:** Input video

**HD REF:** HD-format reference signal

**SD REF:** SD-format reference signal

**10 Audio level meters**

These display the audio recording levels (during recording) or audio playback levels (during playback) of channels 1 to 4. If an audio level exceeds 0 dB, the red indicator bar at the top lights.

**11 Audio format**

During playback, this displays the number of recording audio channels on the disc and the number of quantization bits. During recording, this displays the input signal format selected with A1 INPUT to A4 INPUT on the HOME page of the function menu (see page 81). During display of E-E<sup>1)</sup> video, this displays 2CH/16BIT (two channels, 16 bits) or 4CH/16BIT (four channels, 16 bits), according to the setting of AUDIO CONTROL >REC MODE in the setup menu (see page 93). Always displays 4CH/16BIT when the DVCAM format is being used.

1) E-E: Abbreviation of Electric to Electric. A mode in which input video and audio signals are output after passing through electric circuits only.

**12 Recording/playback format**

This displays the following.

**During playback:** Recording format of the loaded disc.

**During recording/E-E screen display/FAM connection:**

Signal format	Compression method (video bit rate) <sup>a)</sup>
MPEG HD	HQ
	SP
	LP
DVCAM	—

a) Selected with OPERATIONAL FUNCTION >REC FORMAT in the setup menu (see page 87).

**13 Time data type**

This displays the type of the time data that appears in the time data display section. The time data type is set with CNTR SEL on page P1 of the function menu (see page 82).

**COUNTER:** Elapsed recording/playback time

**TC/VITC:** Timecode

**UB/VIUB:** User bits

When TC or UB is selected, and VITC is selected under TC/VITC on page P2 of the function menu (see page 83), a VITC indicator appears, TC changes to VITC, and UB changes to VIUB.

**14 Time data display section**

Normally this displays the time data selected with CNTR SEL on page P1 of the function menu (see page 82).

Messages appear here when an error occurs and when the unit enters a different mode.

**15 System line number**

This displays 1080, 525, or 625 depending on the signal format during recording, playback, FAM connection.

**16 Clip number**

This displays the clip number of the clip being monitored.

**17 System frequency**

This displays the system frequency being used by this unit (60I, 50I, 30P, 25P, or 23.98P) (see page 23).

### 18 Audio monitor channels

This displays the audio monitor channels, as set with MONI CH and MONI SEL on page P1 of the function menu (see page 82).

When you are monitoring channels 1 and 2 (MONI CH is set to "CH 1/2"), the display changes as follows, depending on the setting of MONI SEL.

MONI SEL setting	Display
MONO L (monaural L)	1 1
MONO R (monaural R)	2 2
STEREO	1 / 2
MIX	1 + 2

### 2 Audio level adjustment section

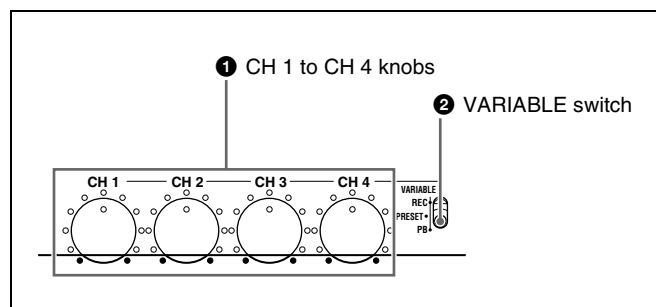

#### 1 CH 1 to CH 4 (audio level) knobs

Depending on the setting of the VARIABLE switch, these adjust the input audio or playback audio levels of CH 1 to CH 4.

#### 2 VARIABLE (audio level adjustment selector) switch

This selects whether the input audio or the playback audio has the levels adjusted by the CH 1 to CH 4 knobs.

**REC:** Adjust the input audio levels. The playback audio levels are fixed at their preset values.

**PRESET:** All of the audio levels are fixed at preset values.

**PB:** Adjust the playback audio levels. The input audio levels are fixed at their preset values.

### 3 Arrow buttons

The four arrow buttons are also used as the MARK1 button, MARK2 button, IN button, and OUT button, as follows.

**↑ button:** MARK1 button

**↓ button:** MARK2 button

**← button:** IN button

**→ button:** OUT button

You can use these buttons for menu setting operations, thumbnail selection, setting or deleting In/Out points, and so on.

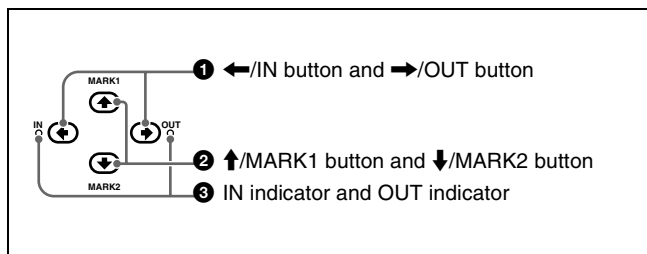

#### 1 ←/IN button and →/OUT button

When the setup or disc menu is visible, use these buttons to change menu settings. When the THUMBNAIL button is lit, you can use these for thumbnail selection.

An In or Out point is set when you press the SET button with the ←/IN or →/OUT button held down. The In or Out point setting is deleted when you press the RESET button with the ←/IN or →/OUT button held down.

#### 2 ↑/MARK1 button and ↓/MARK2 button

When the setup or disc menu is visible, use these buttons to change menu settings. When the THUMBNAIL button is lit, you can use these for thumbnail selection.

During recording and playback, the ↑/MARK1 or ↓/MARK2 button can be pressed with the SET button held down to record a SHOT MARK1 or SHOT MARK2 as an essence mark.

To delete or change essence marks, use the supplied PDZ-1 Proxy Browsing Software.

#### 3 IN indicator and OUT indicator

**IN indicator:** This lights when an In point exists. It flashes if an attempt is made to set an In point after a recorded Out point.

**OUT indicator:** This lights when an Out point exists. It flashes if an attempt is made to set an Out point before a recorded In point.

### 4 Shuttle/jog/variable-speed playback control block

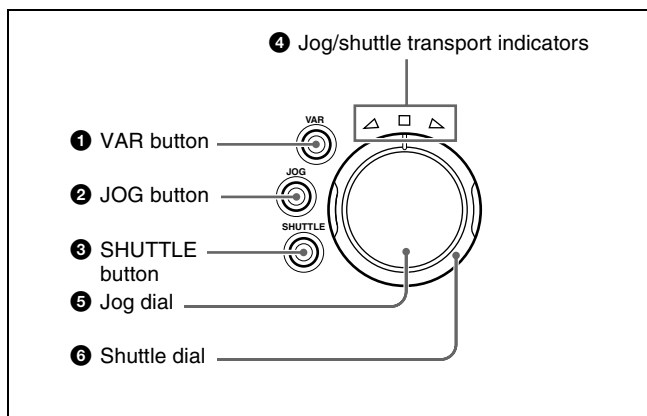

For details about playback operations with these buttons and dials, see page 47 "Playback" in Chapter 3.



**1 VAR (variable) button**

To play back in variable-speed mode using the shuttle dial, press this button, turning it on.

**2 JOG button**

To play back in jog mode using the jog dial, press this button, turning it on.

**3 SHUTTLE button**

To play back in shuttle mode using the shuttle dial, press this button, turning it on.

**4 Jog/shuttle transport indicators**

These show the playback direction in jog, shuttle, or variable-speed mode.

◀ **(green)**: Lights during playback in the reverse direction.

▶ **(green)**: Lights during playback in the forward direction.

■ **(red)**: Lights during still image display.

**5 Jog dial**

Turn this for playback in jog mode. Turn clockwise for forward direction playback, and counterclockwise for reverse direction playback. In jog mode, the playback speed varies in the range  $\pm 1$  times normal speed, according to the rotation rate of the jog dial. The dial has no detents.

**6 Shuttle dial**

Turn this for playback in shuttle mode or variable-speed mode. Turn clockwise for forward direction playback, and counterclockwise for reverse direction playback.

- In shuttle mode, the playback speed varies in the range  $\pm 20$  times normal speed (using MPEG HD/DVCAM), according to the angular position of the shuttle dial.
- In variable-speed mode, you can finely adjust the playback speed from  $-1$  to  $+2$  times normal speed, according to the angular position of the shuttle dial.

The shuttle dial has a detent at the center position, for still image playback.

**Note**

When OPERATIONAL FUNCTION >SEARCH ENABLE in the setup menu is set to "DIAL DIRECT" (see page 88), return the shuttle dial to the center position after using it.

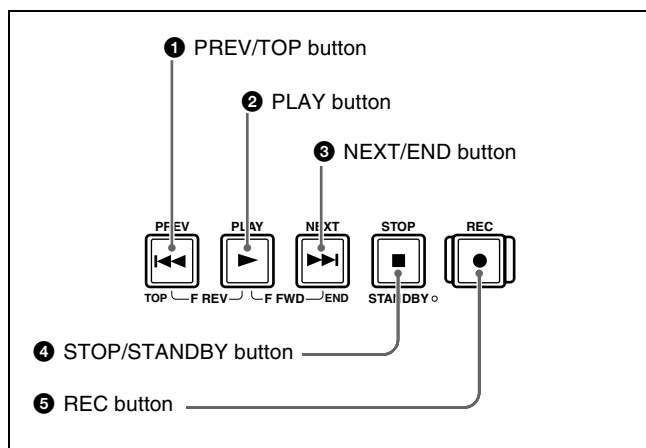
**5 Recording/playback control block****1 PREV (previous)/TOP button**

This functions as a PREV button when pressed alone, and as a TOP button when pressed together with the SHIFT button.

**PREV button:** Press this button, turning it on, to jump to the first frame of the current clip. When pressed at the first frame of the current clip, this button jumps to the first frame of the previous clip.

**TOP button:** Press this button to jump to the first frame of the first clip.

You can perform a high-speed search in the reverse direction by pressing the PREV button together with the PLAY button.

**2 PLAY button**

Press this button, turning it on, to start playback. Press the STOP button to stop playback.

You can perform a high-speed search in the forward or reverse direction by pressing this button together with the NEXT button or PREV button.

**3 NEXT/END button**

This functions as a NEXT button when pressed alone, and as an END button when pressed together with the SHIFT button.

**NEXT button:** Press this button, turning it on, to jump to the first frame of the next clip.

**END button:** Press this button to jump to the last frame of the last clip.

You can perform a high-speed search in the forward direction by pressing the NEXT button together with the PLAY button.

**4 STOP/STANDBY button**

This functions as a STOP button when pressed alone, and as a STANDBY button when pressed together with the SHIFT button.

**STOP button:** Press this button, turning it on, to stop recording or playback. The frame at the stop position is displayed.

**STANDBY button:** Press this button to put the unit into standby-off mode (the STOP button lights, and the STANDBY indicator lights). Press it again to return to the original state (STOP button lit, STANDBY indicator off).

*This unit has a function that can put it into standby-off mode automatically after a certain length of time passes in*

*disc stop mode. For details, see the explanation of STILL TIMER in the setup menu (page 91).*

### 5 REC (record) button

Press this button together with the PLAY button to start recording. Recording starts on the unrecorded part of the disc.

Press the STOP button to stop recording. A clip is created from the recorded section.

## Rear Panel

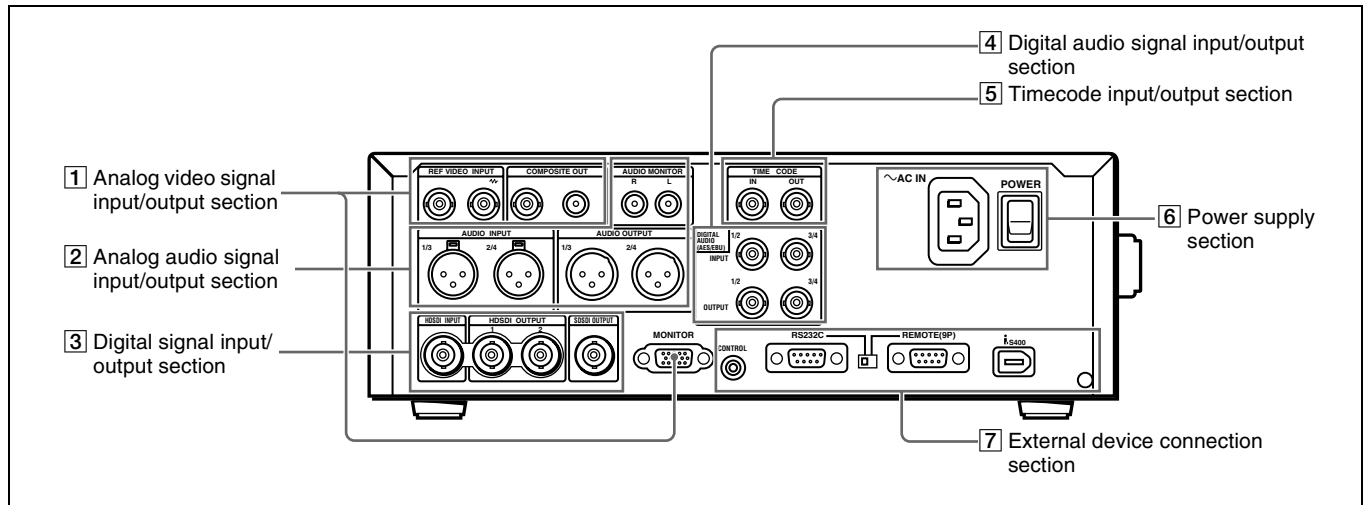

### 1 Analog video signal input/output section

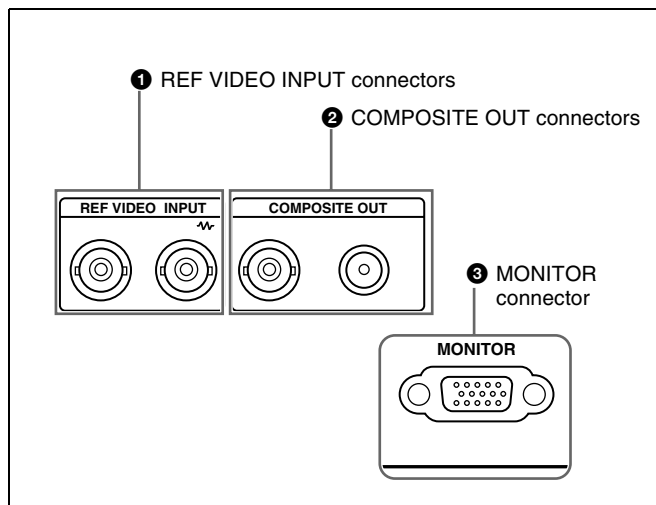

#### 1 REF VIDEO INPUT (reference video signal input) connectors (BNC type)

The two connectors form a loop-through connection; when a reference video signal is input to the left connector, the same signal is output from the right connector (with a waveform symbol) to a connected device. When no connection is made to the right

connector, the left connector is automatically terminated with an impedance of 75 ohms.

#### 2 COMPOSITE OUT connectors (phono jack, BNC type)

These output composite video signals.

When CHAR SEL on page P1 of the function menu is set to "ON" or "LCD" (see page 82), information such as timecode, menu settings, and error messages is superimposed on the output signals.

#### 3 MONITOR connector (D-sub 15-pin)

This outputs HD analog video signals. The output signals can be switched with INTERFACE SELECT > D-SUB OUTPUT in the setup menu (see page 93).

## 2 Analog audio signal input/output section

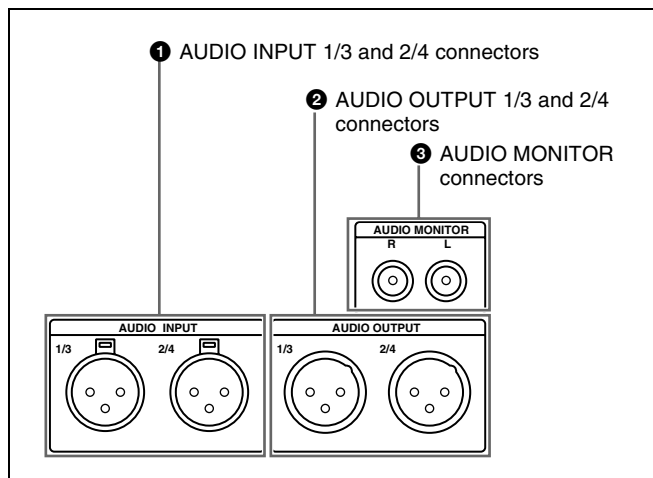

### 1 AUDIO INPUT (analog audio signal input) 1/3 and 2/4 connectors (XLR 3-pin, female)

These connectors input two channels of analog audio. You can use the A1 INPUT to A4 INPUT items on the HOME page of the function menu (*see page 81*) to assign the signals input to connectors 1/3 (ANALOG1) and connectors 2/4 (ANALOG2) to audio channels 1 to 4. You can set the reference input levels with the setup menu item AUDIO CONTROL >LEVEL SELECT (the factory default settings are INPUT: +4 dB, REF LEVEL: -20 dB).

### 2 AUDIO OUTPUT (analog audio signal output) 1/3 and 2/4 connectors (XLR 3-pin, male)

These output two channels of analog audio. For 4-channel audio, you can use the INTERFACE SELECT >AUDIO OUTPUT item of the setup menu (*see page 94*) to select whether to output channels 1 and 2, or channels 3 and 4 (factory default setting: channels 1 and 2).

You can set the output level with the setup menu item AUDIO CONTROL >LEVEL SELECT (factory default setting: +4 dB) (*see page 93*).

### 3 AUDIO MONITOR connectors (phono jack)

These output audio signals for monitoring. You can select the channels to monitor with MONI CH and MONI SEL on page P1 of the function menu (*see page 82*).

## 3 Digital signal input/output section

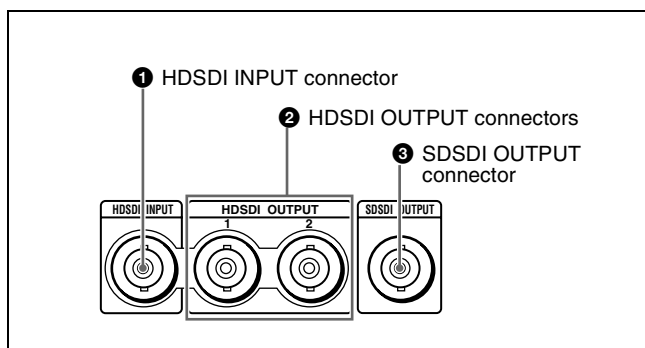

### 1 HDSDI (HD serial digital interface) INPUT connector (BNC type)

This inputs HD format video and audio signals.

### 2 HDSDI (HD serial digital interface) OUTPUT connectors (BNC type)

These output HD format video and audio signals. When CHAR SEL on page P1 of the function menu is set to "ON" (*see page 82*), information such as timecode, menu settings, and error messages is superimposed on the output signals.

### 3 SDSDI OUTPUT connector (BNC type)

This outputs SDSDI signals downconverted from HD video input signals, or the SDSDI signals being played back or being recorded.

When CHAR SEL on page P1 of the function menu is set to "ON" or "LCD" (*see page 82*), information such as timecode, menu settings, and error messages is superimposed on the output signals.

## 4 Digital audio signal input/output section

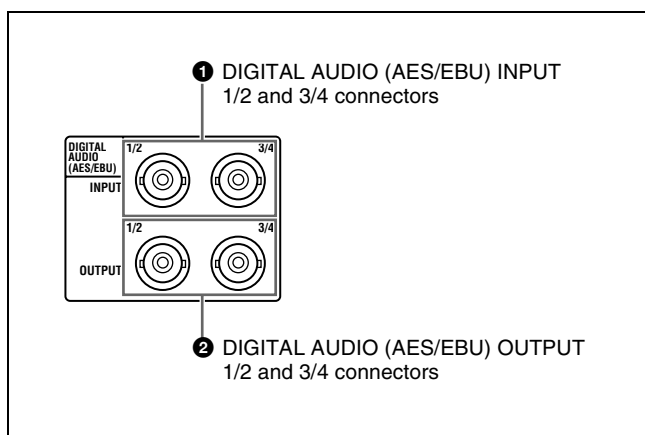

### 1 DIGITAL AUDIO (AES/EBU) INPUT 1/2 and 3/4 connectors (BNC type)

These input AES/EBU format digital audio signals. The 1/2 connector corresponds to audio channels 1 and 2, and the 3/4 connector corresponds to audio channels 3 and 4.

To handle input signals as non-audio data, use the AUDIO CONTROL > DATA MODE item of the setup menu (see page 93) to set the input of channels 1 and 2 (CH1/CH2 IN) or the input of channels 3 and 4 (CH3/CH4 IN) to "DATA".

## 2 DIGITAL AUDIO (AES/EBU) OUTPUT 1/2 and 3/4 connectors (BNC type)

These output AES/EBU format digital audio signals. The 1/2 connector corresponds to audio channels 1 and 2, and the 3/4 connector corresponds to audio channels 3 and 4.

## 5 Timecode input/output section

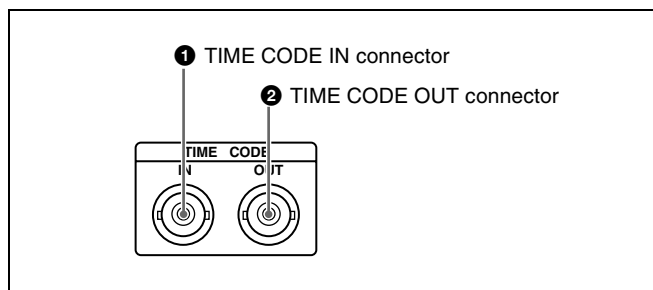

### 1 TIME CODE IN connector

Inputs SMPTE timecode generated by an external device.

### 2 TIME CODE OUT connector

Outputs the following timecode, depending on the operating state of the unit.

**During playback:** Playback timecode

**During recording:** The timecode from the internal timecode generator or the timecode input to the TIME CODE IN connector.

#### Note

In E-E mode no timecode is output if TIME CODE > EE OUT PHASE in the setup menu is set to "MUTING" (see page 90).

## 6 Power supply section

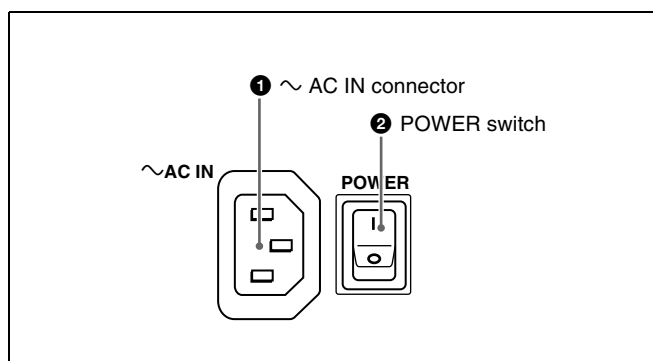

### 1 ~AC IN (AC power input) connector

Connect to an AC power supply with the power cord (not supplied).

### 2 POWER (main power) switch

Press the **I** side to power on the unit. Press the **O** side to power off.

When using the unit, normally leave the POWER switch in the **I** (on) position, and use the on/standby switch on the front panel to switch the unit between the operating state and standby state.

#### Note

If you press the on/standby switch on the front panel while the unit is in the operating state, the unit saves its data and then enters the standby state (the on/standby indicator lights red). Before turning the main power off, always check to be sure that the unit is in the standby state, and then push the main power switch to the **O** side.

## 7 External device connection section

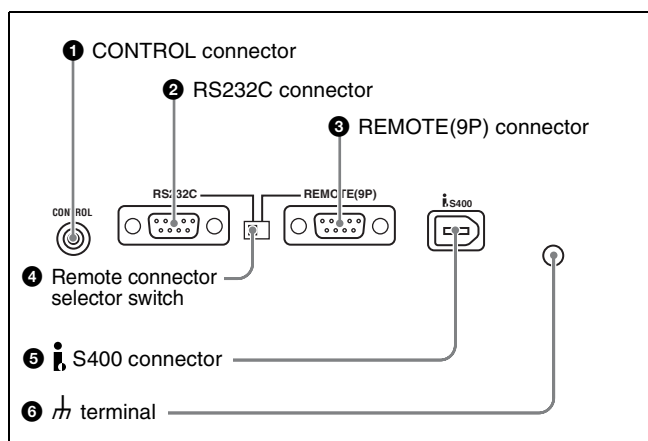

### 1 CONTROL connector (minijack 4-pole)

Connect the optional RM-LG2 Remote Control Unit.

### 2 RS232C (serial interface) connector (D-sub 9-pin, male)

Connect a computer or other device with a serial interface to control this unit from that device.

When you use this connector, set the remote connector selector switch to the RS232C side, and set INTERFACE SELECT > REMOTE I/F in the setup menu to "9PIN/RS-232C" (see page 94).

### 3 REMOTE(9P) (remote control 9-pin) connector (D-sub 9-pin, RS-422A compliant, female)

To control this unit from a controller or VTR supporting the RS-422A Sony 9-pin VTR protocol, connect the device to this connector. When you use this connector, set the remote connector selector switch to the REMOTE(9P) side, and set INTERFACE SELECT > REMOTE I/F in the setup menu to "9PIN/RS232C" (see page 94).

#### ④ Remote connector selector switch

Push this switch to the side of the remote control connector you are using, either the RS232C connector or the REMOTE (9P) connector.

#### ⑤ S400 connector (6-pin, IEEE1394 compliant)

Connect a DV device or computer using an i.LINK cable. The following connection types are supported. They are selected by setting INTERFACE SELECT >i.LINK MODE in the setup menu (see page 94).

**AV/C (Audio/Video Control) connection:** Output DVCAM format digital video and audio signals (i.LINK MODE set to "AV/C").

Audio output signals are 2ch or 4ch, as selected by AUDIO CONTROL >DV OUT MODE in the setup menu (see page 93).

**FAM (file access mode) connection:** Input and output files between this unit and a computer (i.LINK MODE set to "FAM (PC REMOTE)").

#### Notes

- If video or audio signals from an external device connected to the S400 connector fail to be output, disconnect the i.LINK cable and connect it again, pushing it straight in.
- Before connecting or disconnecting an i.LINK cable between this unit and a device with a 6-pin i.LINK connector, power off the device and disconnect its power cord from the electrical outlet. If the i.LINK cable is connected or disconnected with the device's power plug still connected, high voltage (8 to 40 V) from the device's i.LINK connector can flow into this unit, possibly damaging the unit.
- When connecting this unit to a device with a 6-pin i.LINK connector, connect to the 6-pin i.LINK connector of the other device first.
- Except in playback modes (jog and shuttle modes, etc.), audio signals output from this connector and monitored on another device may sound different from the audio signals played back on this unit.

#### ⑥ h (signal ground) terminal

Connect to the system ground.

## Infrared Remote Commander

The corresponding functions are executed when you point the remote commander at the infrared sensor of the main unit and press the keys and setting pad.

If you want to disable control of this unit from the remote commander, set INTERFACE SELECT >WIRELESS RMT in the setup menu to "DISABLE" (see page 94).

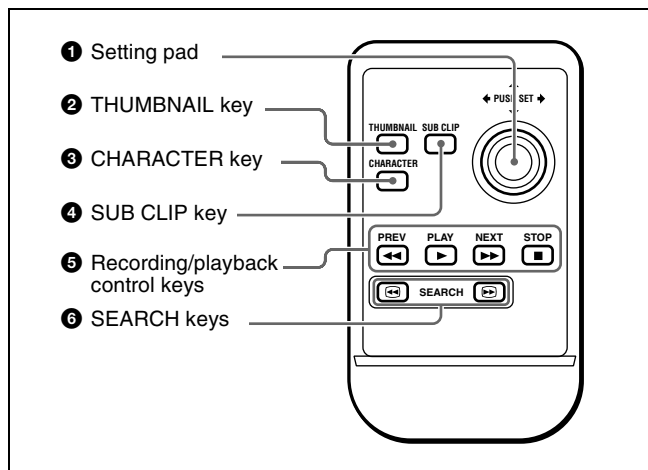

#### ① Setting pad

Positions on the pad correspond to functions of the main unit, as follows.

**Press the top side:** ↑/MARK1 button

**Press the bottom side:** ↓/MARK2 button

**Press the left side:** ←/IN button

**Press the right side:** →/OUT button

**Press the middle:** SET button

#### ② THUMBNAIL key

This has the same function as the THUMBNAIL button on the main unit.

#### ③ CHARACTER key

Each press of this key turns the character information superimposed on the monitor screen on and off, or switches to the LCD.

#### ④ SUB CLIP key

This has the same function as the SUB CLIP button on the main unit.

#### Note

Pressing this key has no effect when no clip list is registered.

#### ⑤ Recording/playback control keys

**PREV (previous) key:** Press this to jump to the first frame of the current clip. When pressed at the first frame of the current clip, this button jumps to the first frame of the previous clip.

**PLAY key:** Press this to start playback. Press the STOP key to stop playback.

**NEXT key:** Press this to jump to the first frame of the next clip.

**STOP key:** Press this to stop recording or playback.

#### ⑥ SEARCH keys

Press ◀ to perform -5 times normal speed shuttle playback in the reverse direction.

Press ►► to perform +5 times normal speed shuttle playback in the forward direction.

## Using the infrared remote commander

### Before use

Pull out the insulation sheet.

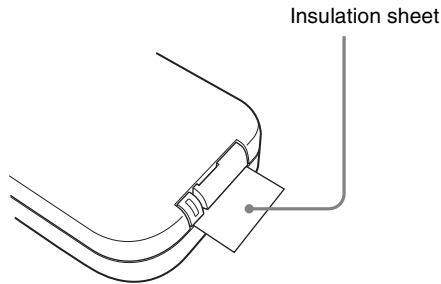

### To replace the lithium battery in the remote commander

The remote commander uses a CR2025 Lithium Battery. Do not use a battery other than the CR2025.

- 1 Hold down the lock lever ①, and then pull out the battery holder ②.

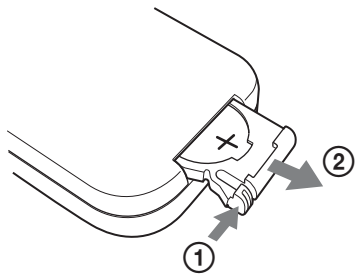

- 2 Insert a new battery with the + symbol facing upward ①, and then push the battery holder until it clicks ②.

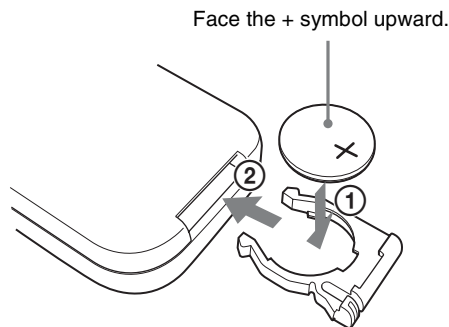

### WARNING

Battery may explode if mistreated. Do not recharge, disassemble or dispose of in fire.

### CAUTION

Danger of explosion if battery is incorrectly replaced.

Replace only with the same or equivalent type recommended by the manufacturer.

Dispose of used batteries according to the manufacturer's instructions.

### Battery lifetime

When the lithium battery output falls, even button presses may not operate. The average lithium battery lifetime is about one year, but this depends on the pattern of use.

If pressing the remote control buttons produces absolutely no effect on this unit, replace the battery, then check the operation again.

## Setting the System Frequency

This unit is shipped with the system frequency still unset. Therefore, you need to set the system frequency before using the unit. (The unit cannot be used unless the system frequency is set.)

Once it is set, the system frequency is retained even when the unit is powered off.

### To set the system frequency

Use the following procedure.

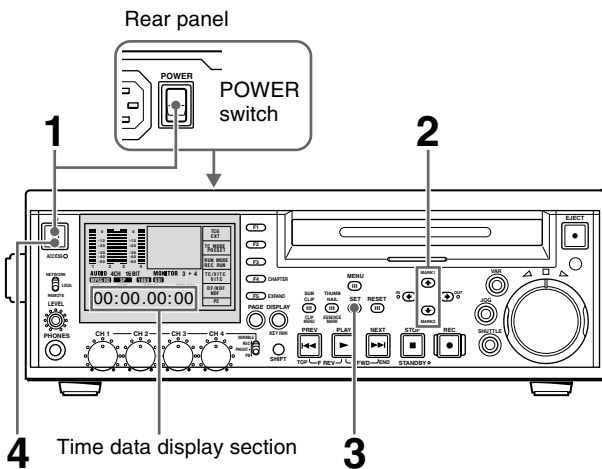

#### 1 Power the unit on.

“SYSTEM SEL” appears in the time data display section.

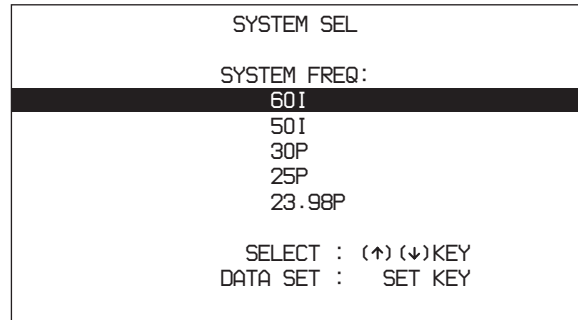

#### 2 Press the ↑/MARK1 button or the ↓/MARK2 button to select the system frequency to use.

#### 3 Press the SET button.

“NOW SAVING...” appears in the time data display section, and the modified setting is saved in the unit’s memory.

“COMPLETE ! !” appears when save processing finishes.

#### If you have selected 60I or 30P

When you press the SET button with 60I or 30P selected in step 2, the following screen appears.

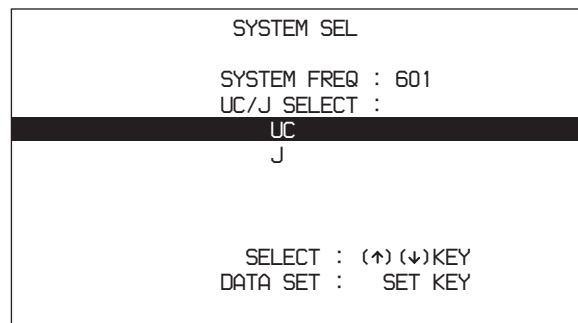

Press the ↑/MARK1 and ↓/MARK2 buttons to select “UC” (for areas outside Japan) or “J” (for Japan), then press the SET button.

**Note**

Be sure to carry out step **3** before powering the unit off (putting it into standby). The new system frequency setting will not be saved if you power off without carrying out step **3**.

- 4** Press the on/standby switch to power the unit off (put it into standby), and then press it again to power the unit on.

The selected system frequency becomes available for use.

*You can change the system frequency setting by using the setup menu item OPERATIONAL FUNCTION >SYSTEM SEL >SYSTEM FREQ.*

*For details about the setup menu, see page 83 “System Menu” in Chapter 6.*

**Note**

When the system frequency is set to 60I or 30P, select drop-frame mode (DF) or non-drop-frame mode (NDF) on page P2 of the function menu (see page 83).

---

## Connections and Settings

**Note**

Production of some of the peripherals and related devices described in this chapter has been discontinued. For advice about choosing devices, please contact your Sony dealer or a Sony sales representative.

---

### Connecting an External Monitor

You can connect a video monitor to this unit’s video output connectors or to the MONITOR connector. The following figure shows an example using a Sony multi-format LCD monitor.

*You can also superimpose character information such as timecode and the unit’s operating status on output video. For details, see “Superimposed Text Information” (page 37).*

#### To view HD video

Connect an HD video monitor using method ① or ② in the following figure.

When you connect a monitor with method ②, set the setup menu item INTERFACE SELECT >D-SUB OUTPUT to “YPbPr” (see page 93).



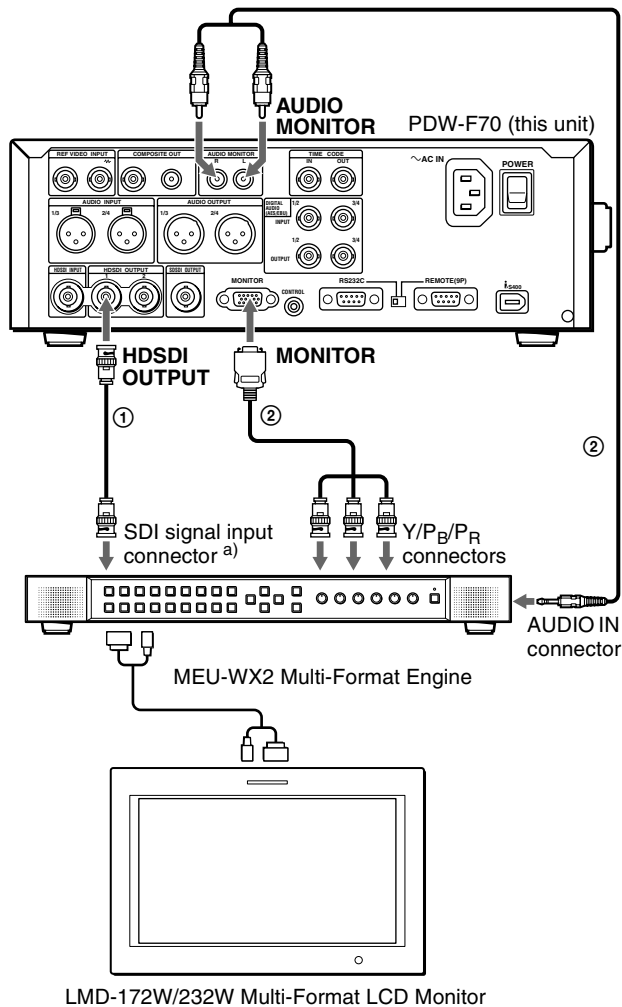

LMD-172W/232W Multi-Format LCD Monitor

a) To input HDSDI signals, a BKM-243HS (not supplied) is required.

### Connection method and connection cables

	Connection method	Connection cables (not supplied)
①	HDSDI	75Ω coaxial cable
②	Component (Y/P <sub>B</sub> /P <sub>R</sub> )	D-Sub 15-pin – analog component cable, phono plug – stereo miniplug cable

### To view SD video

Connect an SD video monitor using method ① or ② in the following figure.

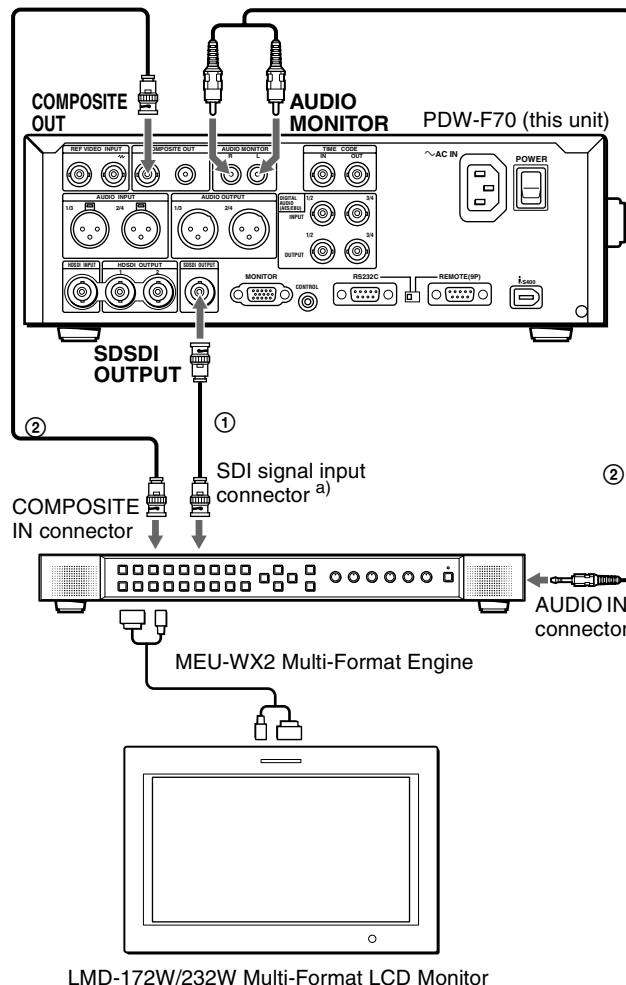

LMD-172W/232W Multi-Format LCD Monitor

a) To input SDSDI signals, a BKM-220D (not supplied) is required.

### Connection method and connection cables

	Connection method	Connection cables (not supplied)
①	SDSDI	75Ω coaxial cable
②	Composite	75Ω coaxial cable, phono plug – stereo miniplug cable

## Using PDZ-1 Over an i.LINK Connection (FAM Connection)

You can use the supplied PDZ-1 Proxy Browsing Software to do simple editing of proxy AV data. The following explains how to make an i.LINK connection between this unit and a computer with PDZ-1 installed, and how to access this unit by FAM (file access mode).

### Notes

- The required FAM driver is also installed when you install the PDZ-1 software.

- This unit's **i**S400 connector has 6 pins. Check the number of pins on the i.LINK connector of your notebook computer, and use an appropriate i.LINK cable.

See “Using PDZ-1 Proxy Browsing Software” in Chapter 4 (page 74) for more information about installing the PDZ-1 software. See the online help of PDZ-1 for more information about using PDZ-1.

Some limitations apply to FAM connections. For details, see “File Operations in File Access Mode” in Chapter 5 (page 78).

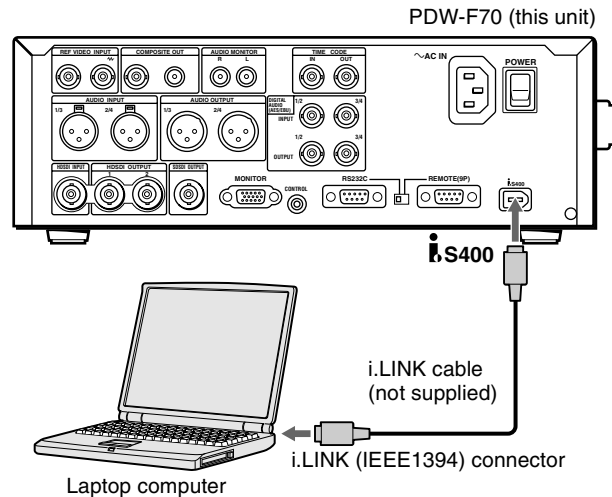
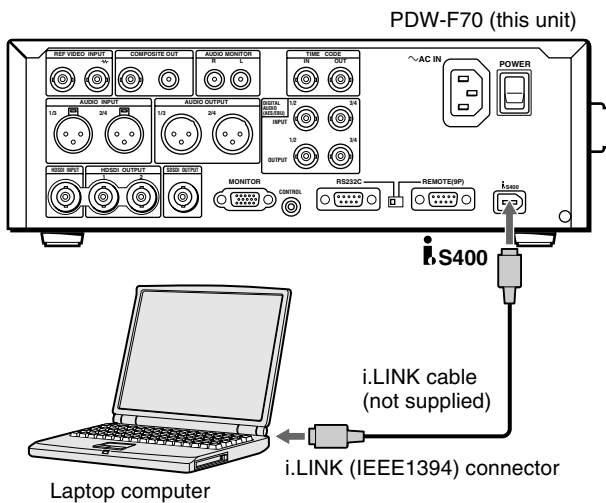

On the computer	On this unit
Install PDZ-1.	Set the setup menu item INTERFACE SELECT >i.LINK MODE to “FAM(PC REMOTE)” (see page 94).

On the computer	On this unit
Install editing software supporting the DVCAM format.	Set the setup menu item INTERFACE SELECT >REMOTE I/F to “i.LINK” (see page 94).
	Set the setup menu item INTERFACE SELECT >i.LINK MODE to “AV/C” (see page 94).

## Connecting to a Nonlinear Editing System (AV/C Connection)

You can send video/audio signals (AV/C data) from this unit to a nonlinear editing system connected to the **i**S400 connector.

The following figure shows an example connection.

See “Using PDZ-1 Over an i.LINK Connection (FAM Connection)” (page 25) for the connections and settings to make a FAM connection between this unit and a nonlinear editing system.

### Notes

- The **i**S400 connector of this unit outputs video/audio signals in DVCAM format. Data recorded in MPEG HD

format is output after being converted into DVCAM format.

- The nonlinear editing system to be connected to this unit requires editing software (not supplied) supporting the DVCAM format.
- To transfer video and audio signals (AV/C data), use AUDIO CONTROL >DV OUT MODE (see page 93) in the setup menu to select the audio mode (the factory default is “2ch”).
- This unit's **i**S400 connector has 6 pins. Check the number of pins on the i.LINK connector of your laptop computer, and use an appropriate i.LINK cable.

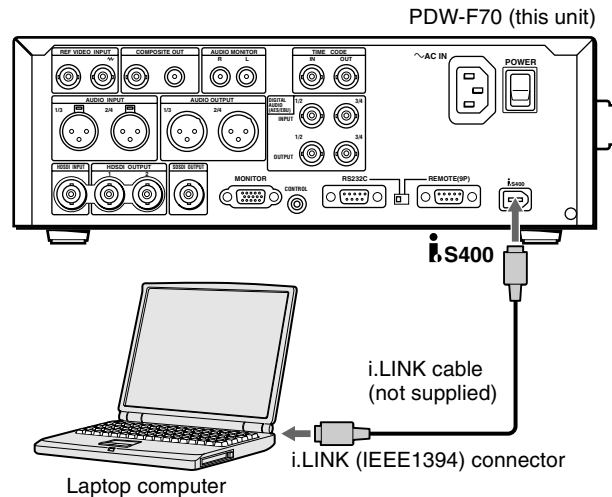

## Connections for Cut Editing

By connecting this unit to a VTR, you can configure a cut editing system. Some example connections are shown in the following.

When making the connections, also refer to the manuals provided with the equipment to be connected.

See page 29 for more information about editing control unit settings.

## When using an editing control unit

The following figure shows a cut editing system comprising this unit as a player, an HDW-M2000/M2000P

unit as a recorder, and a BVE-700A as an editing control unit.

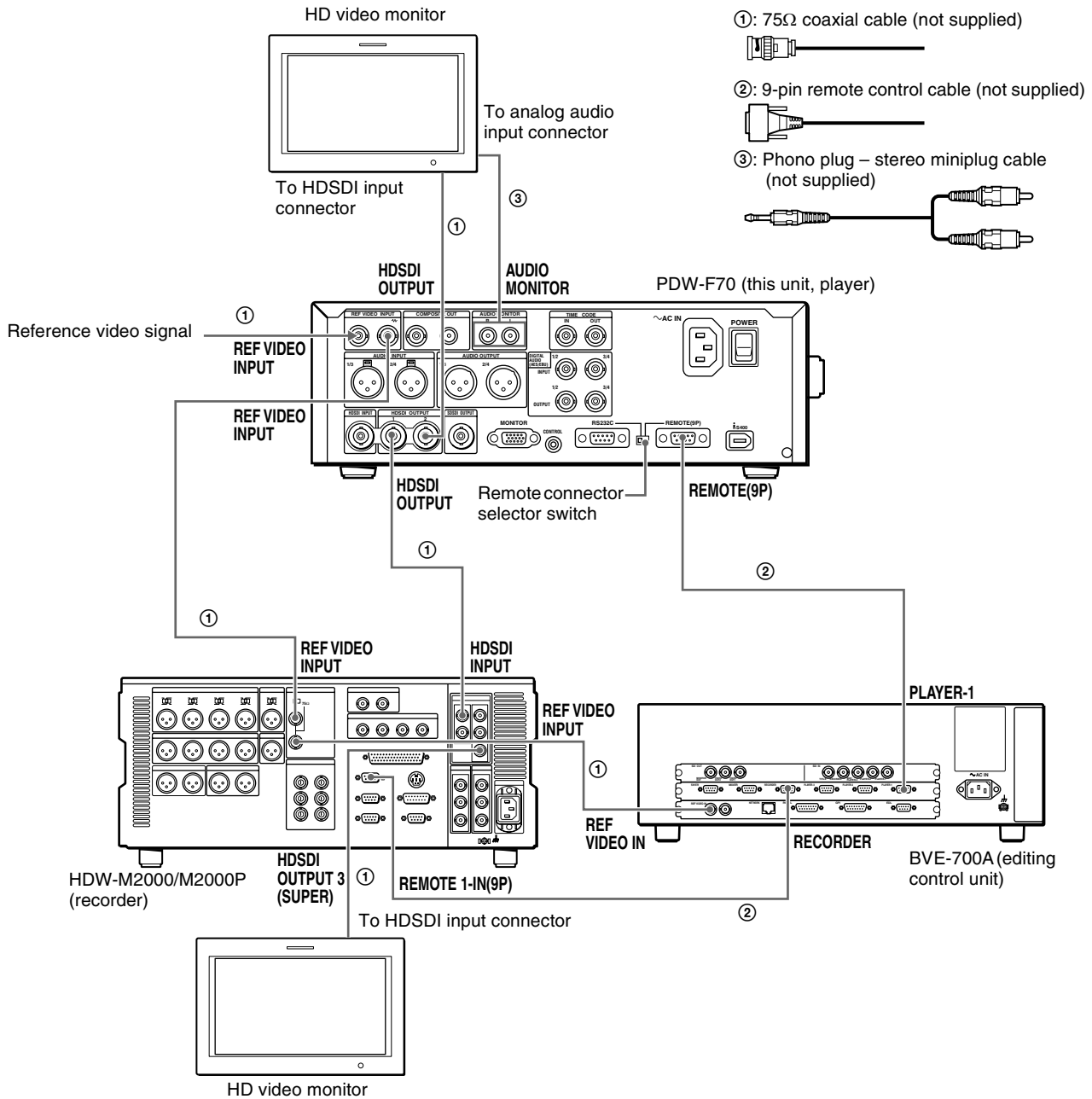

HDW-M2000/M2000P (recorder) settings	This unit (player) settings
REMOTE 1 (9P) button: Lit	Set the setup menu item INTERFACE SELECT >REMOTE I/F to "9PIN/RS-232C" (see page 94).
	Remote control switch: REMOTE
	Remote connector selector switch: REMOTE(9P)

For details about the settings of the HDW-M2000/M2000P, refer to the operation manual for the unit.

## When using the editing functions of the recorder (connections using the REMOTE (9P) connector)

The following figure shows a cut editing system comprising this unit as a player and an HDW-M2000/M2000P unit as a recorder. In this example, video and audio signals are connected by SDI, and control signals are transferred via the REMOTE(9P) connector.

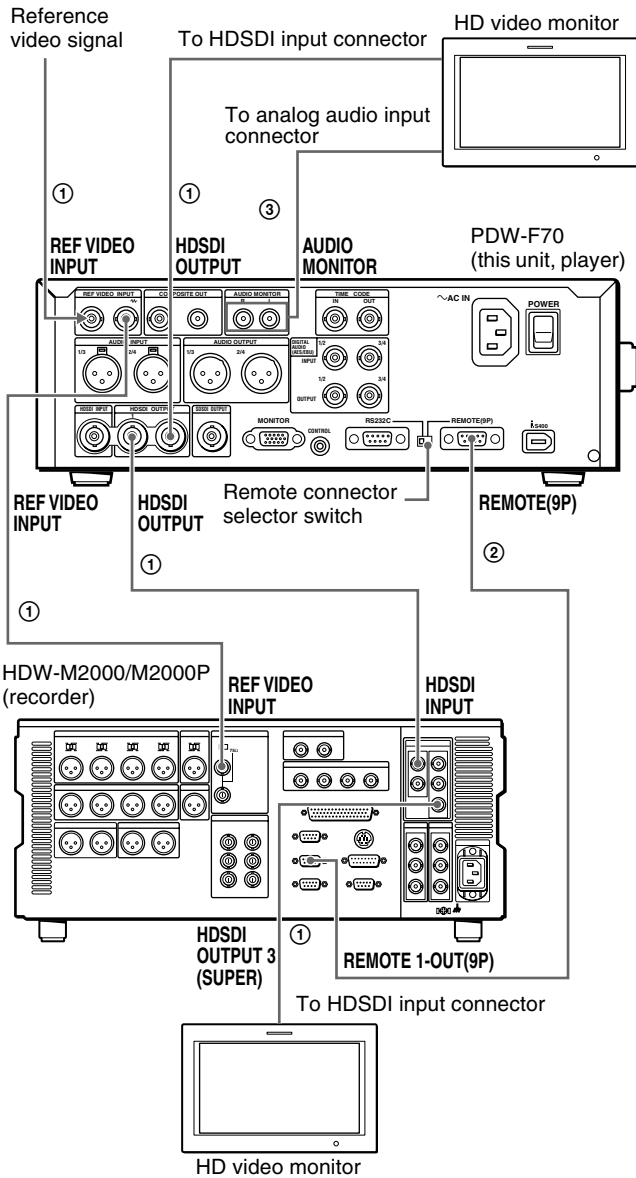

①: 75Ω coaxial cable (not supplied)

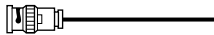

②: 9-pin remote control cable (not supplied)



③: Phono plug – stereo miniplug cable (not supplied)

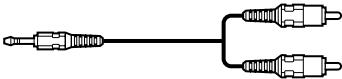

HDW-M2000/M2000P (recorder) settings	This unit (player) settings
75Ω termination switch: ON	Remote connector selector switch: REMOTE(9P)

For details about the settings of the HDW-M2000/M2000P, refer to the operation manual for that unit.

### When using the editing functions of the recorder (connections using the S400 connector)

The following figure shows a cut editing system comprising this unit as a player and a DSR-2000A/2000AP unit as a recorder. In this system, video/audio signals and control signals are all transferred through the S400 connector.

HDW-M2000/M2000P (recorder) settings	This unit (player) settings
REMOTE 1(9P) button: Unlit	Set the setup menu item INTERFACE SELECT >REMOTE I/F to "9PIN/RS-232C" (see page 94).
	Remote control switch: REMOTE

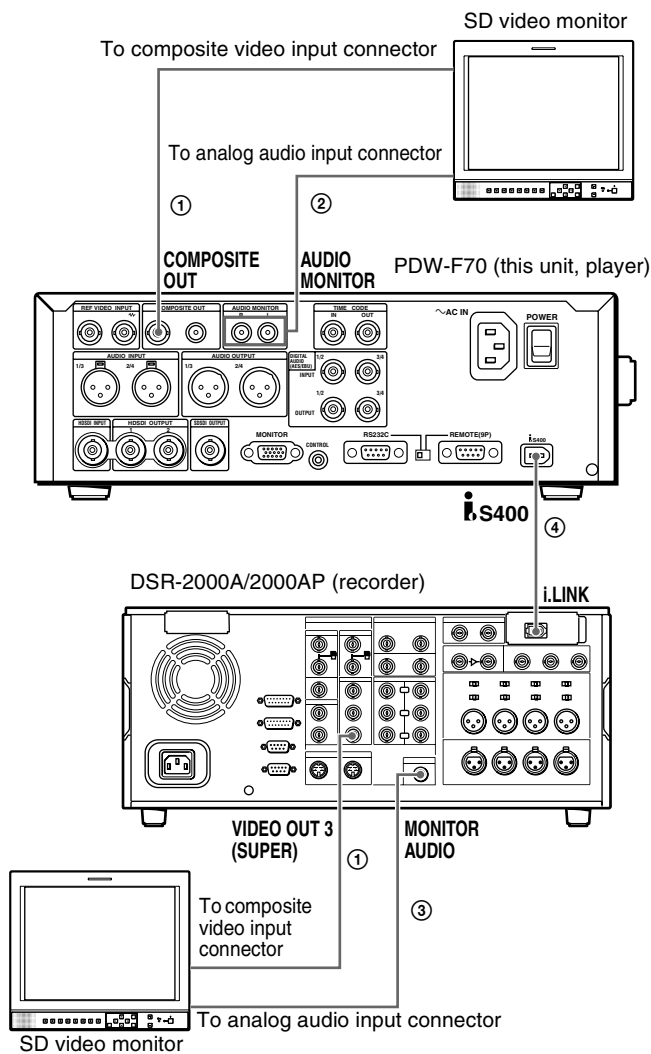

①: 75Ω coaxial cable (not supplied)

②: Phono plug – stereo miniplug cable (not supplied)

③: Phono plug cable (not supplied)

④: i.LINK cable (not supplied)

④: i.LINK cable (not supplied)

④: i.LINK cable (not supplied)

DSR-2000A/2000AP (recorder) settings	This unit's (player) settings
i.LINK button: Lit	Remote control switch: REMOTE
SDTi/i.LINK button: i.LINK	Set the setup menu item INTERFACE SELECT >REMOTE I/F to "i.LINK" (see page 94).

For details about the settings of the DSR-2000A/2000AP, refer to the operating instructions for that unit.

## Editing Control Unit Settings

When connecting an editing control unit to use with this unit, make the following settings.

### BVE-700/700A

Set VTR constants as follows.

System frequency	VTR CONSTANT 1							
	1	2	3	4	5	6	7	8
30P/60I	A0	93	00	96	16	16	03	80
25P/50I	A1	93	00	7D	16	16	03	80
24P	A2	93	00	78	16	16	03	80

System frequency	VTR CONSTANT 2							
	1	2	3	4	5	6	7	8
30P/60I	0A	07	FE	00	80	5A	FF	5A
25P/50I	0A	07	FE	00	80	4C	FF	4B
24P	0A	07	FE	00	80	48	FF	48

## Remote Control Unit Settings

You can control this unit from an RM-280 Remote Control Unit.

Connect this unit to the RM-280 with a 9-pin remote control cable (not supplied), and make the settings in the following table.

RM-280 settings	Settings on this unit
EDITOR/REMOTE CONTROL: REMOTE	Setup menu item INTERFACE SELECT >REMOTE I/F (see page 94): 9PIN/RS-232C
Setup menu item 19 FNC MODE: XDCAM	Remote control switch: REMOTE
	Remote connector selector switch: REMOTE(9P)

## Using XLR Cables (Audio Cables)

Before connecting XLR cables to this unit's analog audio input and output connectors, always attach the supplied ferrite cores to the XLR cables. Attach as shown below.

### To attach the ferrite core

Loop the XLR cable one time through the ferrite core, on the side closest to the connector that is connected to this unit, and fix the ferrite core at the specified position.

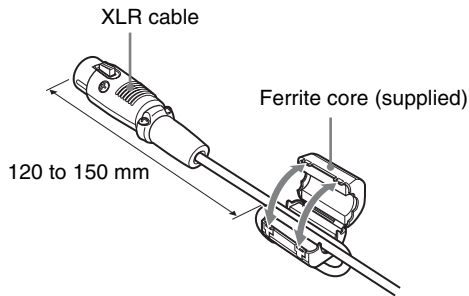

### When the diameter of the XLR cable is too large to loop

If the diameter of the XLR cable is so large that is difficult to loop the cable through the ferrite core, simply pass it through the core without looping. In this case, use a binding strap (not supplied) to at the specified position, as shown in the figure below.

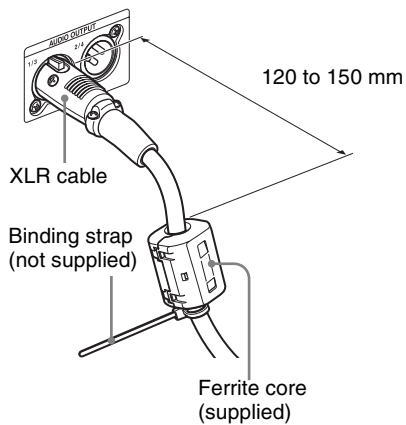

#### Note

This unit will not meet the requirements of the CISPR 22 Class B electromagnetic interference standard if ferrite cores are not attached to XLR cables.

## External Synchronization

This unit synchronizes as shown in the following table, according to the presence or absence of signals input to the HDSDI INPUT connector, the presence or absence of signals input to the REF VIDEO INPUT connector, and the setting of the V INPUT item on the HOME page of the function menu (*see page 81*).

Signal input to HDSDI INPUT connector	Signal input to REF VIDEO INPUT connector	V INPUT setting	External synchronization
Yes	Yes	HDSDI	Synchronize to HDSDI input
		SG	Synchronize to REF VIDEO input
Yes	No	HDSDI	Synchronize to HDSDI input
		SG	No external synchronization
No	Yes	HDSDI	Synchronize to REF VIDEO input
		SG	
No	No	HDSDI	No external synchronization
		SG	

#### Note

There is no external synchronization for file operations by FAM connection (*see page 78*).

# Setup

The principal setup operations before operating this unit are carried out using setup menus.

This section explains how to set the date and time and how to adjust the brightness of the LCD panel.

See Chapter 6 "Menus" (page 81) for more information about menu operations and menu items.

## Setting the Date and Time

When using this unit for the first time, you should set the date and time as follows.

### Note

Before starting, press the DISPLAY button to set the monitor video section to its largest size. Or connect an external video monitor to this unit and superimpose menus (see page 37) on the monitor screen.

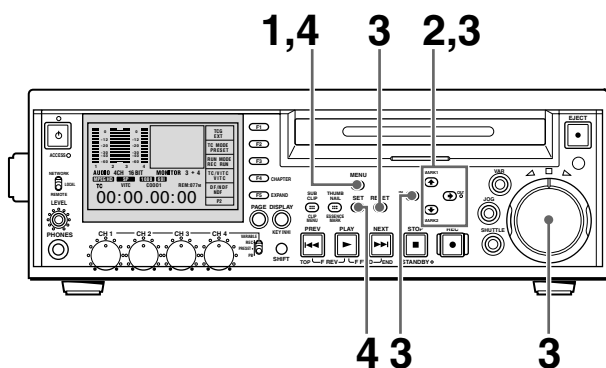

- 1 Press the MENU button.

The system menu appears on the monitor screen (see page 83).

- 2 Select DATE/TIME PRESET using the  $\uparrow$ /MARK1 button or  $\downarrow$ /MARK2 button, then press the  $\rightarrow$ /OUT button.

The DATE/TIME PRESET screen appears on the monitor.

### DATE/TIME PRESET

```

YEAR    2006
MONTH   04
DAY     08
TIME    10:09:17
TIME ZONE UTC_00:00
  
```

```

INC/DEC : JOG DIAL
SHIFT   : (←)(→)KEY
DATE SAVE : SET KEY
TO MENU : MENU KEY
  
```

This screen allows you to set the following items.

**YEAR:** Calendar year

**MONTH:** Month

**DAY:** Day

**TIME:** Time

**TIME ZONE:** Time zone (difference from UTC)

- 3 Set the date, time and time zone.

You can change the setting of the flashing digits.

### To change the flashing digits

Use the arrow buttons ( $\leftarrow$ /IN,  $\rightarrow$ /OUT).

### To increase or decrease the values of the flashing digits

Use the arrow buttons ( $\uparrow$ /MARK1,  $\downarrow$ /MARK2) or jog dial.

### To return the settings to the initial values

Press the RESET button.

- 4 When you have made the necessary settings, press the SET button.

The message "NOW SAVING..." appears, the settings are saved, and the menu closes.

### To clear the menu from the screen without saving settings

Press the MENU button twice in succession.

## Adjusting the Brightness of the LCD Panel

Proceed as follows to adjust the brightness of the LCD panel.

### Note

Before starting, press the DISPLAY button to set the monitor video section to its largest size. Or connect an external video monitor to this unit and superimpose menus (see page 37) on the monitor screen.

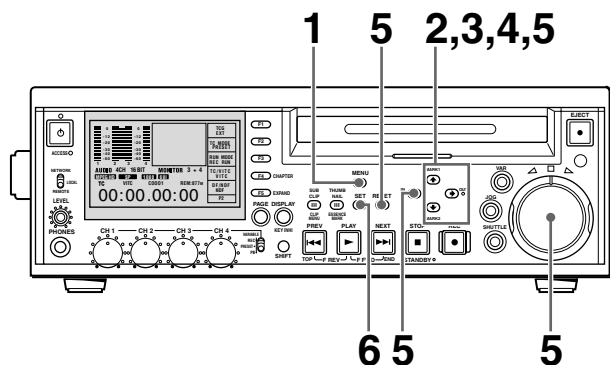

- 1** Press the MENU button.

The system menu appears on the monitor screen (*see page 83*).

- 2** Select SETUP MENU using the  $\uparrow$ /MARK1 button or  $\downarrow$ /MARK2 button, then press the  $\rightarrow$ /OUT button.

The setup menu appears on the monitor screen (*see page 84*).

- 3** Select DISPLAY CONTROL using the  $\uparrow$ /MARK1 button or  $\downarrow$ /MARK2 button, then press the  $\rightarrow$ /OUT button.

The DISPLAY CONTROL menu appears on the monitor screen (*see page 88*).

- 4** Select BRIGHTNESS using the  $\uparrow$ /MARK1 button or  $\downarrow$ /MARK2 button, then press the  $\rightarrow$ /OUT button.

The LCD BRIGHTNESS screen appears on the monitor.

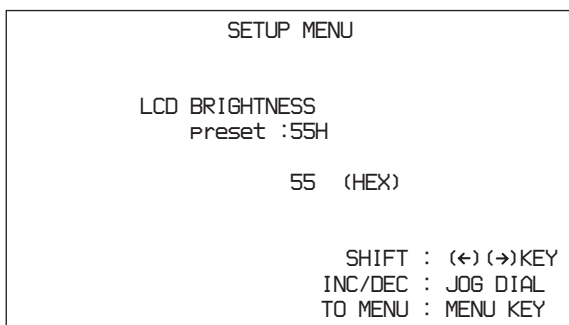

- 5** Adjust the brightness while viewing the screen.

You can change the values of digits which flash in the settings screen. Setting values are hexadecimal (00 to 7F (HEX)).

#### To change the flashing digits

Use the arrow buttons ( $\leftarrow$ /IN,  $\rightarrow$ /OUT).

#### To increase or decrease the values of the flashing digits

Use the arrow buttons ( $\uparrow$ /MARK1,  $\downarrow$ /MARK2) or jog dial.

#### To return the settings to the factory defaults

Press the RESET button.

- 6** When you are finished making adjustments, press the SET button.

The message “NOW SAVING...” appears, the settings are saved, and the menu closes.

#### To clear the menu from the screen without saving adjustments

Press the MENU button twice in succession.



# 24P (23.98P) Mode Settings

## Selecting the Playback Mode (23.98PsF or 2-3 Pulldown)

When the setup menu item SYSTEM FREQ is set to "23.98P", you can set monitor output to either 23.98PsF mode or 2-3 pulldown mode.

- 1 Press the MENU button.

The system menu (*see page 83*) appears.

- 2 Press the  $\uparrow$ /MARK1 or  $\downarrow$ /MARK2 button to select SETUP MENU.

- 3 Press the  $\rightarrow$ /OUT button.

The setup menu appears.

- 4 Press the  $\downarrow$ /MARK2 button to select MENU GRADE.

- 5 Press the  $\rightarrow$ /OUT button.

The second level of the MENU GRADE menu appears.

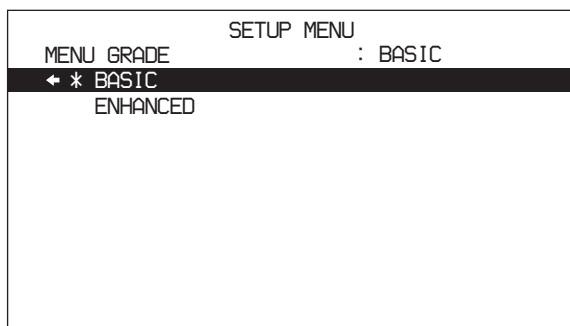

- 6 Press the  $\downarrow$ /MARK2 button to select ENHANCED.

- 7 Press the  $\leftarrow$ /IN button.

The enhanced menu items appear.

- 8 Press the  $\uparrow$ /MARK1 button to select "OPERATIONAL FUNCTION".

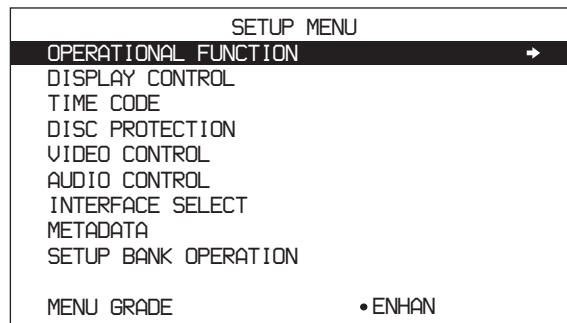

- 9 Press the  $\rightarrow$ /OUT button.

The second level of the OPERATIONAL FUNCTION menu appears.

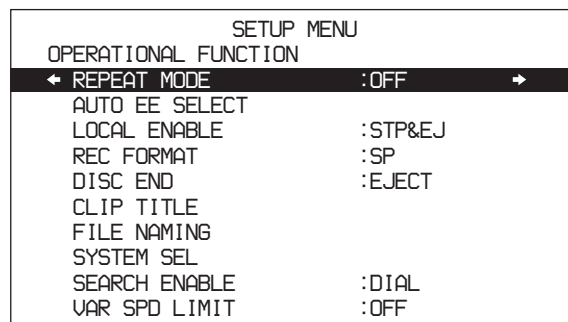

- 10 Press the  $\uparrow$ /MARK1 or  $\downarrow$ /MARK2 button to select "SYSTEM SEL".

- 11 Press the  $\rightarrow$ /OUT button.

The third level of the menu appears.

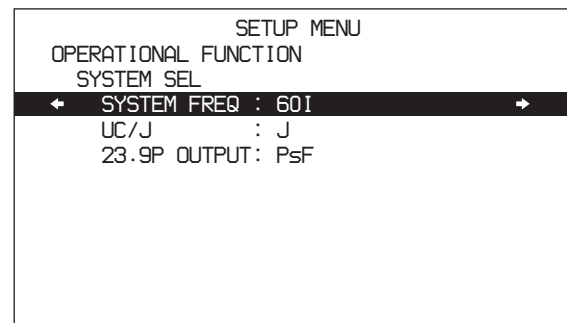

- 12 Press the  $\uparrow$ /MARK1 or  $\downarrow$ /MARK2 button to select "SYSTEM FREQ".

- 13 Press the  $\rightarrow$ /OUT button.

Setting values appear.

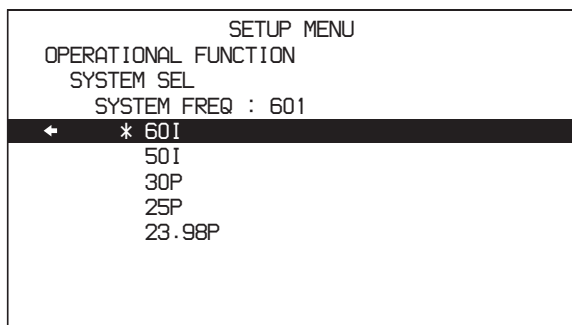

- 14** Press the **↓/MARK2** button to select “23.98P”.
- 15** If you want to change the monitor output setting as well, press the **←/IN** button to return to the higher level screen (the state of step **11**). If you do not want to change the monitor output setting, proceed to step **19**.
- 16** Press the **↓/MARK2** button to select “23.9P OUTPUT”.
- 17** Press the **→/OUT** button.

The setting value appears.

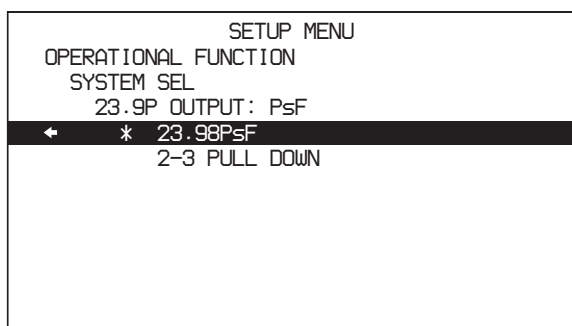

- 18** Press the **↑/MARK1** or **↓/MARK2** button to select one of the following.
- 23.98PsF:** Output as 23.98P.  
**2-3 PULL DOWN:** Output after pulldown conversion to 59.94i.
- 19** Press the SET button.
- A confirmation message appears.
- 20** Press the SET button to confirm the changes, or the RESET button to cancel them.
- If you have pressed the SET button, power the unit off and on again to enable the changes.

## Input and Output Signals in 24P (23.98P) Mode

The following tables show the signals input and output by the unit when “23.98PsF” and “2-3 PULL DOWN” are selected.

### Input and output signals

I/O	Type	23.98PsF	2-3 PULL DOWN
Input signals	Reference video input	23.98PsF reference signal	59.94i reference signal
	HDSDI input	23.98PsF video and audio signals	
Input timecode	LTC input	24-frame timecode	
	HDSDI LTC input		
Output signals	HDSDI output	23.98PsF video and audio signals	Video and audio signals pulled down to 59.94i
	SDSDI output	No output	
	Composite output		
	i.LINK DV output		
Timecode output	i.LINK TS output		
	LTC output	24-frame timecode	30-frame timecode after pulldown conversion
	HDSDI LTC/VITC output		
	SDSDI RP188 LTC output	–	
	SDSDI VITC output	–	
COMPOSITE VITC output	–		

## Timecode display

Type	23.98PsF	2-3 PULL DOWN
LTC display	24-frame timecode	
PDT display	–	30-frame timecode after pulldown conversion
VITC display	24-frame timecode	
COUNTER display	24-frame signals	30-frame signals after pulldown conversion

## Timecode in remote timecode mode

Type	23.98PsF	2-3 PULL DOWN
9-pin preset timecode	24-frame timecode	
9-pin preset timer 1 (Counter)	24-frame signals	30-frame signals after pulldown conversion
9-pin scene timecode	24-frame timecode	30-frame timecode after pulldown conversion
9-pin scene timer 1 (Counter)	24-frame signals	30-frame signals after pulldown conversion

See the optional “9pin Manual ‘PDW Series PROTOCOL OF REMOTE(9-pin) CONNECTOR’” for more information about remote timecode mode.

## Recording in 24P (23.98P) Mode

### Recording frame sequence and clip length

See the following figure for the frame sequence.

In 24P (23.98P) mode, recording start and stop timing is adjusted so that a recorded sequence always begins with an “A-frame” and ends with a “D-frame”. As a result, the number of frames in a clip is always a multiple of 4.

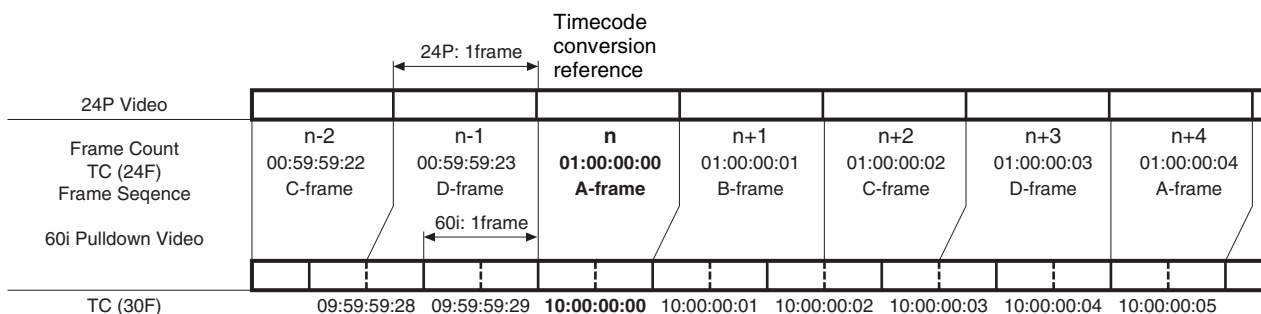

### Timecode during playback of pulldown signals

During playback of pulldown signals, timecode is

## Recording timecode

When you preset timecode manually, select a multiple of 4 as the number of frames in the timecode, and adjust so that the preset timing begins with an “A-frame”.

The unit will then adjust so that the timecode at the start of recorded clips will have a number of frames that is a multiple of 4.

### Notes

- The above adjustments are not carried out when you preset timecode remotely.
- No adjustments are made when you record external timecode. Therefore the number of frames in the timecode at the start of recorded clips may not have a number of frames that is a multiple of 4. If you want to make sure that the number of frames in the timecode of the first frames of recorded clips is a multiple of 4, set the run mode to “REC RUN”, and record after manually presetting the timecode.

## Playback in 24P (23.98P) 2-3 Pulldown Mode

### Pulldown playback frame sequences

During pulldown mode playback, playback is carried out so that the 24-frame timecode set with TIME CODE >PD PRESET in the setup menu becomes the “A-frame” of the frame sequence. The following figure shows the playback frame sequence when 01:00:00:00 has been set for the 24-frame timecode and 10:00:00:00 has been set for the 30-frame timecode.

### Note

This kind of frame sequence adjustment is not carried out for clip list playback.

converted to 30 frames to match the 59.94i video output signals.

The values of “24F TC” and “30F TC” under TIME CODE >PD PRESET in the setup menu are used as the conversion references.

### To display 30-frame pulldown timecode in the monitor video display section or on an external monitor

- 1 Press the MENU button.

The system menu (*see page 83*) appears.

- 2 Press the **↑**/MARK1 or **↓**/MARK2 button to select SETUP MENU.

- 3 Press the **→**/OUT button.

The setup menu appears.

- 4 Press the **↑**/MARK1 or **↓**/MARK2 button to select “DISPLAY CONTROL”.

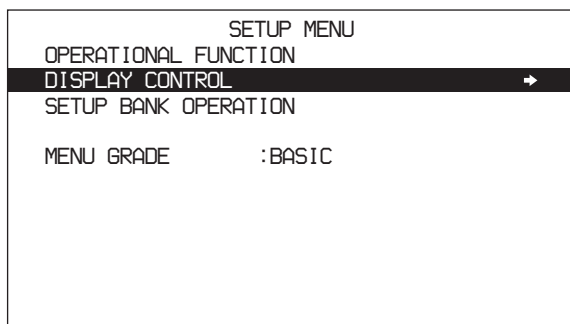

- 5 Press the **→**/OUT button.

The second level of the DISPLAY CONTROL menu appears.

- 6 Press the **↑**/MARK1 or **↓**/MARK2 button to select “DISPLAY INFO”.

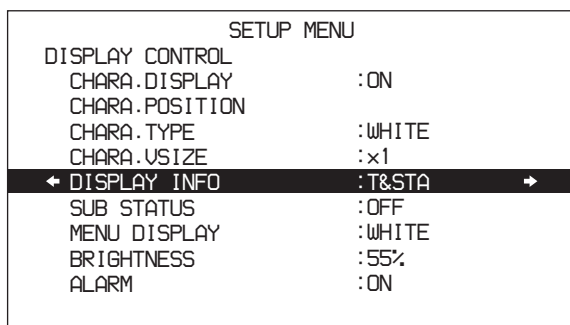

- 7 Press the **→**/OUT button.

The third level of the menu appears.

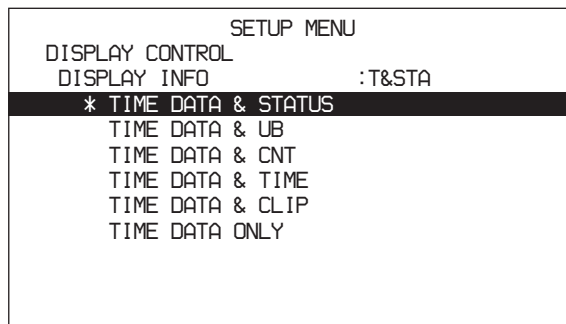

- 8 Press the **↑**/MARK1 or **↓**/MARK2 button to select “TIME DATA ONLY”.

- 9 Press the SET button.

The setting is confirmed.

- 10 Turn the display of character information on.

*For details, see “To turn superimposed text on and off” (page 37).*

As shown below, you can display 24-frame timecode at the same time as 30-frame pulldown timecode.

LTC	00:59:59:23
PDT	00:59:59:28

# Superimposed Text Information

The HDSDI signals output from the HDSDI OUTPUT 1 and 2 connectors and the MONITOR connector, the SDSDI signals output from the SDSDI OUTPUT connector, and the composite signals output from the COMPOSITE OUT connector can contain superimposed text information, including timecode, menu settings, and alarm messages.

## To turn superimposed text on and off

Set the CHAR SEL item on page P1 of the function menu.

**ON:** Display superimposed text.

**OFF:** Do not display superimposed text.

**LCD:** Display superimposed text on the LCD panel of this unit, but do not display it on an external video monitor connected to this unit.

### Note

Even when ON is selected, you can forcibly turn off the superimposition of character information in HD output by setting the SETUP MENU > DISPLAY CONTROL > HD CHARA item.

## Adjusting the text display

You can use the items in the DISPLAY CONTROL setup menu to specify the position, size, and type of superimposed characters.

See page 88 for more information about the items in the DISPLAY CONTROL menu.

## Information displayed

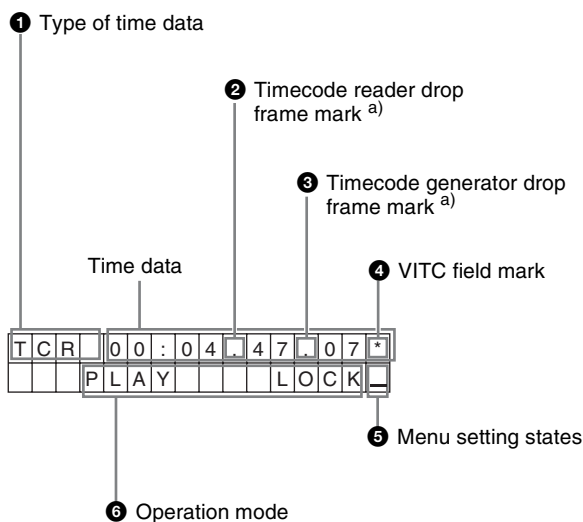

a) Only when the system frequency is 60I/30P.

### Note

The display shown above corresponds to the factory default settings of the unit.

You can use DISPLAY CONTROL > DISPLAY INFO (page 89) in the setup menu to change the information shown in the second line.

See page 96 “Setup Menu Operations” in Chapter 6 for more information about how to use the setup menu.

## 1 Type of time data

Display	Meaning
CNT	Counter data
TCR	TC reader timecode data
UBR	TC reader user bits data
TCR.	VITC reader timecode
UBR.	VITC reader user bits data
TCG	TC generator timecode
UBG	TC generator user bits data
IN	In point time data
OUT	Out point time data
DUR	Duration between In point and Out point

### Note

If the time data or user bits cannot be read correctly, they will be displayed with an asterisk. For example, “T\*R”, “U\*R”, “T\*R.” or “U\*R.”.

## 2 Timecode reader drop-frame mark (for system frequency 60I/30P only)

“.”: Indicates drop-frame mode

“:.”: Indicates non-drop-frame mode

## 3 Timecode generator drop-frame mark (for system frequency 60I/30P only)

“.”: Indicates drop-frame mode (factory default)

“:.”: Indicates non-drop-frame mode

## 4 VITC field mark

“ ” (blank): Fields 1 and 3 (for system frequency 60I/30P) or fields 1, 3, 5 and 7 (for system frequency 50I/25P)

“\*.”: Fields 2 and 4 (for system frequency 60I/30P) or fields 2, 4, 6 and 8 (for system frequency 50I/25P)

## 5 Menu setting states

This is displayed when the setup menu item DISPLAY CONTROL > MENU STATUS is set to “ENABLE” (see page 89).

Display	Description
B1	The current menu settings are the same as the settings in menu bank 1.
B2	The current menu settings are the same as the settings in menu bank 2.
B3	The current menu settings are the same as the settings in menu bank 3.
DF	The current menu settings are the same as the factory defaults.
No display	The current menu settings are different from all of the above.

### 6 Operation mode

The field is divided into two blocks as shown below.

- Block A displays the operation mode.
- Block B displays the servo lock status or playback speed.

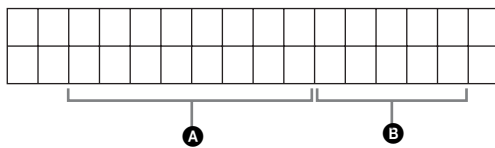

Display		Operation mode
Block A	Block B	
DISC OUT		Disc is not loaded.
LOADING		Disc is being loaded.
UNLOADING		Disc is being unloaded.
STANDBY OFF		Standby-off mode
STOP		Stop mode
NEXT		Cuing up to the first frame of the next clip.
PREV		Cuing up to the first frame of the current clip.
F.FWD		Fast forward search
F.REV		Fast reverse search
PLAY		Playback mode (servo unlocked)
PLAY	LOCK	Playback mode (servo locked)
REC		Record mode (servo unlocked)
REC	LOCK	Record mode (servo locked)
JOG	STILL	A still picture in jog mode
JOG	FWD	Jog mode in forward direction
JOG	REV	Jog mode in reverse direction

Display		Operation mode
Block A	Block B	
SHUTTLE	STILL	A still picture in shuttle mode
SHUTTLE	(Speed)	Shuttle mode
VAR	(Speed)	Variable speed mode
TOP 0001/xxxx		Cuing up to the first frame of the first clip.
END xxxx/xxxx		Cuing up to the last frame of the last clip.
PREROLL		Cuing up during preroll

## Displaying Supplementary Status Information

When you set the setup menu item DISPLAY CONTROL > SUB STATUS to other than "OFF" (see page 89), you can view supplementary status information on the monitor screen below the operating mode display area.

T	C	R	0	0	:	0	4	.	4	7	.	0	7	
			P	L	A	Y					L	O	C	K
			I	N	S	V	A	1	2	3	4	T	C	

Supplementary status information



The following items of supplementary status information are displayed depending on the setting of the menu item SUB STATUS.

Setting of menu item SUB STATUS	Items of supplementary information displayed
TC MODE	Operating mode of the internal timecode generator
REMAIN	Amount of free capacity on the disc (in minute units).
CLIP NO	Clip number

The following tables show the on-screen indications of supplementary information and their meaning.

### When the menu item SUB STATUS is set to "TC MODE":

On-screen indication	Meaning
INT PRST FREE	The internal timecode generator is operating in FREE RUN mode.
INT PRST REC	The internal timecode generator is operating in REC RUN mode.

On-screen indication	Meaning
INT REGEN-T&U	The internal timecode generator is in synchronization with the playback timecode (LTC) read from disc.
EXT LTC-T&U	The internal timecode generator is in synchronization with the external timecode (LTC) input to the unit and is generating the same timecode values and user bit values as those of the external timecode (regeneration).
EXT VITC-T&U	The internal timecode generator is in synchronization with VITC present in the external video signal input to the unit and is generating the same timecode values and user bit values as those of the external timecode (regeneration).
EXT DVIN-T&U	The internal timecode generator is in synchronization with the external timecode input to the unit via the  S400 connector and is generating the same timecode values and user bit values as those of the external timecode (regeneration).
EXT DVIN.V-T&U	The internal timecode generator is in synchronization with the external VITC input to the unit via the  S400 connector interface and is generating the same timecode values and user bit values as those of the external timecode (regeneration).

**When the menu item SUB STATUS is set to “REMAIN”:**

On-screen indication	Meaning
REMAIN 120 min	Remaining capacity of the disc in minutes. When the remaining capacity has not been calculated, “REMAIN --- min” appears.

## Handling Discs

### Discs Used for Recording and Playback

This unit uses the following disc for recording and playback:

PFD23 Professional Disc <sup>1)</sup> (capacity 23.3 GB)

1) Professional Disc is a trademark of Sony Corporation.

#### Note

It is not possible to use the following discs for recording or playback:

- Blu-ray Disc
- Professional Disc for Data

### Notes on Handling

#### Handling

The Professional Disc is housed in a cartridge, and is designed to allow handling free of risk from dust or fingerprints. However, if the cartridge is subjected to a severe shock, for example by dropping it, this can result in damage or scratching of the disc. If the disc is scratched, it may be impossible to record video/audio, or to play back the content recorded on the disc. The discs should be handled and stored carefully.

- Do not touch the surface of the disc itself within the cartridge.
- Deliberately opening the shutter may cause damage.
- Do not disassemble the cartridge.
- The supplied adhesive labels are recommended for indexing discs. Apply the label in the correct position.

#### Storage

- Do not store discs where they may be subjected to direct sunlight, or in other places where the temperature or humidity is high.

- Do not leave cartridges where dust may get inside.
- Store cartridges in their cases.

#### Care of the discs

- Remove dust and dirt on the outside of a cartridge using a soft dry cloth.
- If condensation forms, allow ample time to dry before use.

### Write-Protecting Discs

To protect the content recorded on the disc from accidental erasure, move the Write Inhibit tab on the lower surface of the disc in the direction of the arrow, as shown in the following figure.

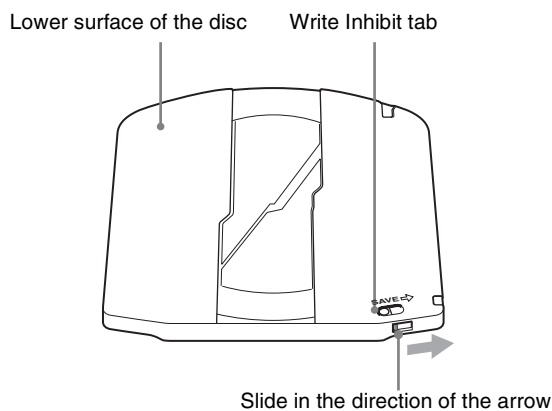

#### Write Inhibit tab settings

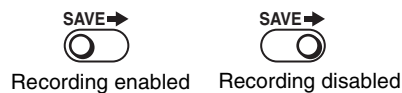

You can also write protect individual clips. For details, see “*Locking (Write-protecting) Clips*” (page 54).

### Loading and Unloading a Disc

When the on/standby switch indicator is lit green, you can load and unload a disc as shown in the following figure.



On/standby switch and indicator

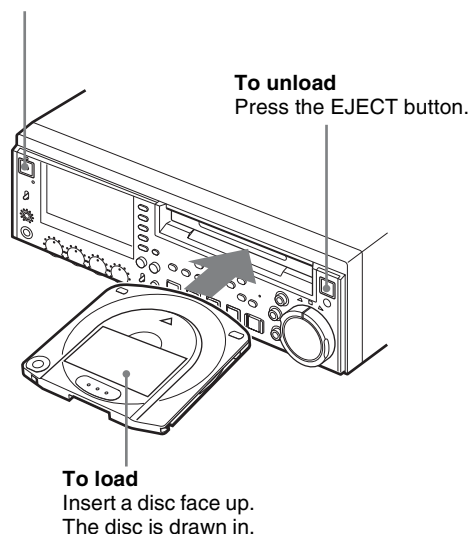

The disc slot indicator flashes orange when you insert a disc, and lights blue when the disc is completely loaded. The indicator flashes blue when you eject a disc, and goes out when the disc is completely ejected.

## Formatting a Disc

Unused discs are formatted automatically when they are loaded into this unit.

To format a recorded disc, load the disc into the unit, then proceed as follows.

### Note

When a recorded disc is formatted, all the data on the disc is erased. (Locked clips (*see page 54*) are also erased.)

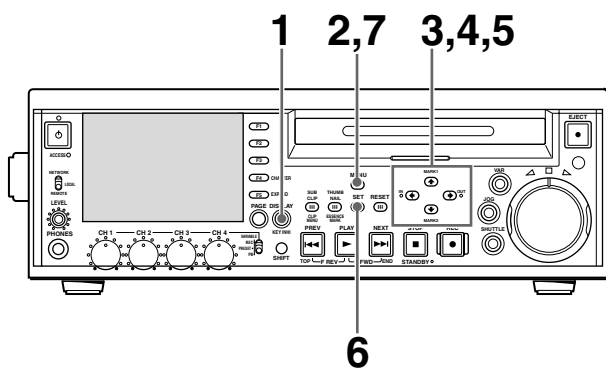

**1** Press the DISPLAY button to maximize the monitor video section.

**2** Press the MENU button.

The system menu appears on the display.

**3** Select “DISC MENU” using the  $\uparrow$ /MARK1 button or  $\downarrow$ /MARK2 button, then press the  $\rightarrow$ /OUT button.

**4** Select “FORMAT” using the  $\downarrow$ /MARK2 button, then press the  $\rightarrow$ /OUT button.

The menu item QUICK FORMAT is selected.

**5** Press the  $\rightarrow$ /OUT button.

The message “QUICK FORMAT OK?” appears.

### To cancel a disc format

Press the RESET button to return to the state of step **3**. To clear the menu from the screen, carry out step **7**.

**6** Press the SET button.

The format starts.

The message “FORMAT COMPLETED.” appears when formatting of the disc is completed.

### If you want to continue by formatting another disc

When the message “FORMAT COMPLETED.” appears, press the EJECT button to eject the disc. Insert the next disc to format, and press the SET button when the message “QUICK FORMAT OK?” appears.

**7** Press the MENU button to clear the menu from the screen.

## Handling of Discs When Recording Does Not End Normally (Salvage Functions)

Recording processing does not end normally if, for example, the POWER switch on the rear panel is turned off during recording, or if the power cord is disconnected during recording. Because the file system is not updated, video and audio data recorded in real time is not recognized as files and clip contents recorded up to that point are lost.

However, this unit has salvage functions which can hold losses to the minimum by reconstructing clips on such discs.

There is a quick salvage function which executes automatically and a full salvage function which you can execute as required.

**Quick salvage:** Clips are reconstructed on the basis of backup data stored in nonvolatile memory and markers recorded on the disc. Processing time is about 5 seconds.

Quick salvage executes automatically if the unit is powered on with a disc still loaded after recording was interrupted by power off.

**Full salvage:** Clips are reconstructed on the basis of markers recorded on the disc. Nonvolatile memory cannot be used, so processing takes longer than for a quick salvage (about 30 seconds, although it depends on the state of the disc).

You are prompted to execute a full salvage whenever you insert a disc that was removed manually from a powered off device after interruption of recording by power off.

Note that no recorded clip contents are lost when the on/standby switch on the front panel is set to standby during recording, because the unit does not enter standby mode until after the end of recording processing.

### Notes

- Even after recording finishes, do not set the POWER switch on the rear panel to off until the ACCESS indicator has gone out.
- These functions salvage as much recorded material as possible after an unforeseen accident, but 100% restoration cannot be guaranteed.
- Even when these functions are used, it is not possible to recover data from immediately before the interruption of recording. The amount of data lost is as follows.

**Quick salvage:** From 2 to 4 seconds of data before the interruption of recording.

**Full salvage:** From 4 to 6 seconds of data before the interruption of recording.

- You are prompted to execute a full salvage every time you insert a disc that has not been salvaged, or power the unit on with such as disc loaded.
- No recording is possible on discs containing clips that have not been salvaged, although it is possible to play back the normally recorded sections. Recording becomes possible if you perform a quick format, but this erases all of the original recorded content.

## To restore clips with a full salvage

- 1 Insert the disc on which recording did not end normally.

The message “Salvage ?” appears on the display.

### To cancel the clip salvage

Press the RESET button.

### Notes

- The message “EJECT?” appears when “REC INH” is displayed in the operation modes section of the display. If the disc is write protected, eject the disc, set the Write Inhibit tab to enable recording, and then insert the disc again. If REC INH on page P1 of the function menu is set to “ON”, set it to “OFF” (*see page 82*).

- This operation cannot be cancelled once it begins.

- 2 Press the SET button.

Processing begins and the message “Executing.” appears.

When processing finishes, a message appears to display the results.

If the message reads “Incomplete!”, the clips that failed were lost.

# Recording

This section describes video and audio recording on the unit.

See page 81 “Function Menu” in Chapter 6 for more information about function menu operations.

See page 96 “Setup Menu Operations” in Chapter 6 for more information about setup menu operations.

## Note

It is not possible to combine material recorded in different system frequencies and audio recording formats on a single disc (although different bit rates may be combined). If you attempt to record material in a system frequency or audio recording format that differs from that of existing recorded material on the disc, “REC INH” appears on the display and recording is inhibited.

Make the following settings and adjustments before starting to record.

**Recording format settings:** See the next section “To set the video and audio recording formats”.

**Video input signal selection:** Select with V INPUT on the HOME page of the function menu.

**Audio input signal selection:** Select with A1 INPUT to A4 INPUT on the HOME page of the function menu.

**Timecode and user bits settings:** See “Recording Timecode and User Bit Values” (page 43).

**Selection of time data to display:** Select with CNTR SEL on page P1 of the function menu.

**Selection of audio channels to monitor:** Select with MONI CH and MONI SEL on page P1 of the function menu.

**Volume adjustment of the monitor audio:** Adjust with the LEVEL knob.

**Remote/local setting:** Set the remote control switch. If you set it to REMOTE, also set the setup menu item INTERFACE SELECT > REMOTE I/F (“REMOTE” and the connector used appear on the display).

## To set the video and audio recording formats

### To set the video recording format

Set the video bit rate (compression method) by setting OPERATIONAL FUNCTION > REC FORMAT in the setup menu to one of the following.

Menu setting/display	Video bit rate
HQ	VBR 35 Mbps

Menu setting/display	Video bit rate
SP	CBR 25 Mbps
LP	VBR 18 Mbps

### To set the audio recording format

Set AUDIO CONTROL > REC MODE in the setup menu to one of the following.

Menu setting	Display	Audio recording format
2ch×16bit	2CH 16BIT	2 channels/16 bits
4ch×16bit	4CH 16BIT	4 channels/16 bits

## Recording Timecode and User Bit Values

There are the following four ways of recording timecode:

**Internal Preset mode:** This records the output of the internal timecode generator, set beforehand to an initial value. The following run modes can be selected.

- Free Run: Timecode advances continually.
- Rec Run: Timecode advances only during recording.

**Internal Regen mode:** This records the output of the internal timecode generator, initialized to timecode following continuously upon the timecode of the last frame of the last clip on the disc.

**External Regen mode:** This records the output of the internal timecode generator, synchronized to an external timecode generator. As the external input, the timecode input to any of the TIME CODE IN connector can be selected.

**External Preset mode:** This directly records the input of an external timecode generator. As the external input, the timecode input to either of the following connectors can be selected.

- TIME CODE IN connector: TC
- HDSDI INPUT connector: LTC

## To record timecode after setting an initial value (Internal Preset)

### To set an initial value

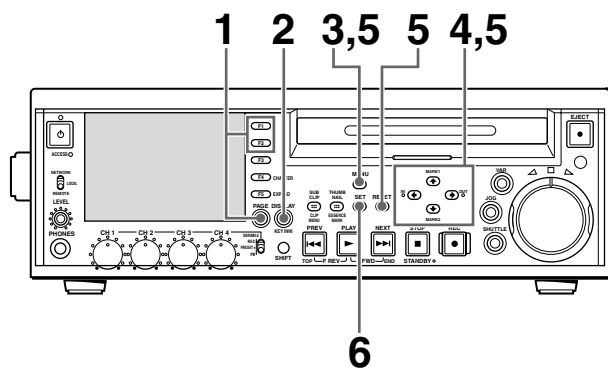

- 1** Make the following settings in the function menu.
  - Set CNTR SEL on page P1 to “TC”.
  - Set TCG on page P2 to “INT”.
  - Set TC MODE on page P2 to “PRESET”.
- 2** Press the DISPLAY button to maximize the monitor video section.
- 3** Press the MENU button.  
The system menu appears on the display.
- 4** Select “TC PRESET” using the **↑/MARK1** button or **↓/MARK2** button, then press the **→/OUT** button.  
The TC PRESET MODE screen appears.

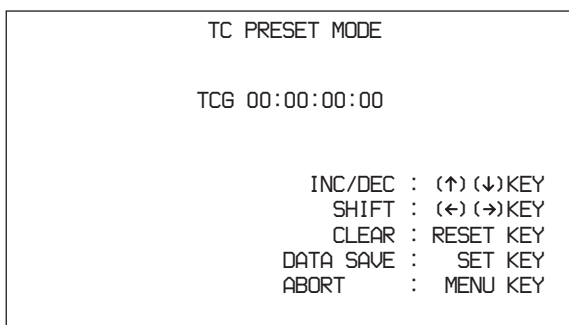

- 5** Use the arrow buttons and the RESET button to set the initial timecode value.
  - ←/IN button or →/OUT button:** Select the digit to change (it flashes).
  - ↑/MARK1 button or ↓/MARK2 button:** Change the value of the selected digit.
  - RESET button:** Reset all digits to 0.

#### To cancel the timecode setting

Press the MENU button.

- 6** Press the SET button.

The message “NOW SAVING...” appears, and the timecode set in step **5** is displayed.

If RUN MODE on page P2 of the function menu is set to “FREE RUN”, timecode begins to advance from the initial value you just set.

### To set timecode to the current time

- 1** Set RUN MODE on page P2 of the function menu to “FREE RUN”, and set DF/NDF to “DF”.
- 2** Carry out steps **1** to **5** of the previous section “To record timecode after setting an initial value (Internal Preset)” to set the timecode to a time slightly ahead of the current time.
- 3** Press the SET button at the instant when the current time matches the displayed timecode.

### To set user bits

You can record up to eight hexadecimal digits of information (date, time, clip number, etc.) in the timecode track.

- 1** Set CNTR SEL on page P1 of the function menu to “UB”.
- 2** Carry out steps **2** to **4** of the previous section “To record timecode after setting an initial value (Internal Preset)” (*see page 44*).

The UB PRESET MODE screen appears.

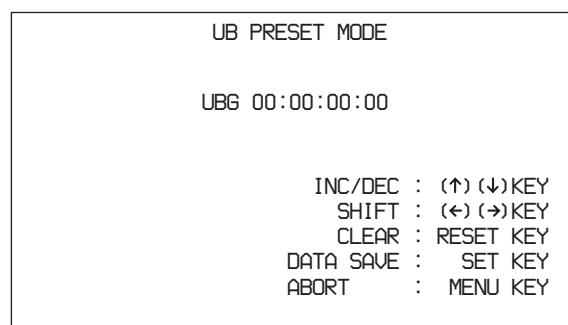

- 3** Use the arrow buttons and the RESET button to set the user bits.
  - ←/IN button or →/OUT button:** Select the digit to change (it flashes).
  - ↑/MARK1 button or ↓/MARK2 button:** Change the value of the selected digit.
  - RESET button:** Reset all digits to 0.

Settings are made in hexadecimal (0, 1, 2,... 8, 9, A, B,... E, F).

**To cancel the user bits setting**

Press the MENU button.

**4** Press the SET button.

The message “NOW SAVING...” appears, and the user bits set in step **3** are displayed.

**To record timecode that follows sequentially upon the last recorded timecode (Internal Regen)**

You can record timecode so that it is continuous from one clip to the next on the disc.

Set TC MODE on page P2 of the function menu to “INT”, and TCG to “REGEN”. When this setting is in force, the unit reads the timecode of the last frame of the last recorded clip on the disc before starting to record, and internally generates timecode that follows upon the recorded timecode.

In this case, the setting of DF/NDF on page P2 of the function menu is ignored. New timecode is recorded in the drop-frame mode of the last recorded timecode on the disc.

**To record with the internal timecode generator synchronized to external timecode (External Regen)**

Use this method to synchronize the timecode generators of a number of recorders, to record the playback timecode of external VTRs, or to record while maintaining synchronization between the source video and timecode. Use either of the following procedures according to the type of external timecode.

**Synchronizing with timecode input to the TIME CODE IN connector**

**1** Connect the timecode output of an external device to the TIME CODE IN connector, and input a reference video signal to the REF VIDEO INPUT connector.

**2** Make the following settings on page P2 of the function menu.

- Set TCG to “EXT”.
- Set TC MODE to “REGEN”.
- Set TC/VITC to “TC”.

**Synchronizing with multiplexed timecode input to the HDSDI INPUT connector**

**1** Connect an HDSDI signal containing multiplexed LTC to the HDSDI INPUT connector, and input a reference video signal to the REF VIDEO INPUT connector.

**2** Make the following settings on page P2 of the function menu.

- Set TCG to “SDI”.
- Set TC MODE to “REGEN”.
- Set TC/VITC to “TC”.

Executing either of these procedures starts the internal timecode generator running in synchronization with the external timecode generator.

Once the internal timecode generator is synchronized with the external timecode generator, the internal timecode generator continues to run even if the external timecode generator connection is removed.

The timecode advance mode is set automatically to Free Run. The frame count mode (for system frequency 60I/30P only) is set to the same mode as the external timecode signal (drop-frame or non-drop-frame).

**To check the synchronization to the external signal**

Press the STOP button to stop this unit, then press the REC button.

Check that the timecode value shown in the time data display coincides with the external timecode value.

**To record external timecode directly (External Preset)**

When you use this method, the internal timecode generator advances without being affected by the external timecode.

**To directly record timecode input to the TIME CODE IN connector**

Connect the timecode output of an external device to the TIME CODE IN connector, and make the following settings on page P2 of the function menu.

- Set TCG to “EXT”.
- Set TC MODE to “PRESET”.
- Set TC/VITC to “TC”.

---

**Carrying Out Recording**

One recording segment (from the start to the end of recording) is called a “clip”.

*See Chapter 4 “Scene Selection” for more information about clips.*

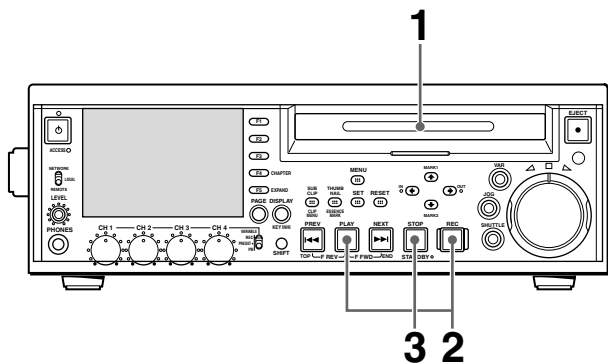

- 1 Insert a disc.
- 2 Hold down the REC button, and press the PLAY button.  
Recording starts.
- 3 To stop recording, press the STOP button.

#### If the disc becomes full

Recording stops and the message “ALARM DISC END.” appears on the monitor.

#### Notes

- The shortest clip that can be recorded is 2 seconds long. Even if recording start and stop operations are performed within 2 seconds, a 2-second clip is recorded.
- The maximum number of clips that can be recorded is 300. If the loaded disc already contains 300 clips, recording with the REC button is not possible. (The message “Disc Full!” appears in the time data display section.)
- During recording, do not turn off the POWER switch on the rear panel or disconnect the power cord. This could cause the clip being recorded to be lost. *For details, see “Handling of Discs When Recording Does Not End Normally (Salvage Functions)” on page 41.*

#### To specify the frame to use as the thumbnail image

You can display a list of thumbnails of all clips on a disc, and use it to check the recorded content (*see page 49*). When the unit is shipped from the factory, it is set up to display the first frame of each clip as the thumbnail. As required, you can select another frame to display as the thumbnail.

For example, if there are several seconds of color bars recorded at the start of the clip, selecting a frame after the end of the recording of color bars can make it easier to identify the clip.

You can use META DATA >INDEX POSITION in the setup menu to select the position of the thumbnail image

by specifying a number of seconds after the first frame. The selection range is 0 seconds (0 SEC) to 10 seconds (10 SEC).

#### To adjust the audio recording levels

##### When carrying out audio recording at a reference level

Set the VARIABLE switch to PRESET. The audio signals will be recorded at a preset reference level.

You can change the reference level and the input levels with AUDIO CONTROL >LEVEL SELECT in the setup menu.

**REF LEVEL:** Reference level

**CH1 IN LEVEL:** Input level of channel 1

**CH2 IN LEVEL:** Input level of channel 2

##### Manually adjusting the audio recording levels

Set the VARIABLE switch to “REC” and adjust the CH 1 to CH 4 knobs so that the audio level indications on the audio level meters do not exceed 0 dB for a maximum volume. Carry out the adjustment in E-E mode.

*See OPERATIONAL FUNCTION >AUTO EE SELECT in the setup menu for more information about the signal output settings in E-E mode (page 87).*

#### To set shot marks

A SHOT MARK1 essence mark or SHOT MARK2 essence mark is set if you hold down the ↑/MARK1 or ↓/MARK2 button and press the SET button during recording.

If the unit is set up to display superimposed text information (*see page 37*), “SHOTMARK1” or “SHOTMARK2” appears every time you set an essence mark.

When SHOT MARK1 or SHOT MARK2 essence marks are set, you can search for the shot marks by displaying thumbnails of the frames at those positions (*see page 51*). You can also use shot mark positions as edit points during scene selection operations (*see page 65*).

*You can also set shot marks during playback. See page 48 for the procedure.*

# Playback

This section describes playback of video and audio on the unit.

Before starting playback, make the following settings and adjustments.

**Selection of time data to display:** Select with CNTR SEL on page P1 of the function menu.

**Selection of audio channels to monitor:** Select with MONI CH and MONI SEL on page P1 of the function menu.

**Volume adjustment of the monitor audio:** Adjust with the LEVEL knob.

**Remote/local setting:** Set the remote control switch. If you set it to REMOTE, also set the setup menu item INTERFACE SELECT > REMOTE I/F (“REMOTE” and the connector used appear on the display).

## Disc playback start position

Although this unit uses optical discs, it is designed to offer the most convenient features of tape playback by VTRs. One of these is the playback start position, which works in the same way as tape, as described below.

### After playback stop

The unit stops at the position where the STOP button was pressed.

Press the PLAY button to resume playback at the stop position.

### After recording

The unit stops at the position where recording ended.

To play back a clip, press the PREV button to move to the start frame of any clip, or press the PREV button with the PLAY button held down to move to any position.

### After disc insertion

The unit stops at the position of the disc when it was most recently ejected.

Press the PLAY button to resume playback at the most recent position.

The playback position is saved to the disc when the disc is ejected, which allows playback to start at that position whenever it is loaded into any XDCAM player.

#### Note

This function is not available when the Write Inhibit tab of the disc is set to the recording disabled position, and when REC INH on page P1 of the function menu is set to “ON”. The REC INH indicator may light when neither of the above is true if the format of recorded sections on the disc is not the same as the recording settings of this unit. In this case, the playback position can be saved to the disc.

## Playback Operation

This section describes the following types of playback:

**Normal playback:** Playback at normal speed

**Playback in jog mode:** Variable-speed playback, with the speed determined by the speed of turning the jog dial

**Playback in shuttle mode:** Variable-speed playback, with the speed determined by the angular position of the shuttle dial

**Playback in variable-speed mode:** Variable-speed playback, with the speed finely determined by the angular position of the shuttle dial

### Normal playback

First insert a disc.

For details of how to insert a disc, see “Loading and Unloading a Disc” on page 40.

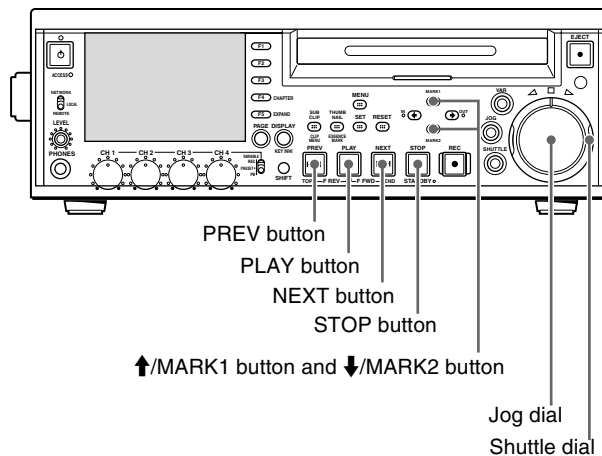

### To start playback

Press the PLAY button.

Playback starts.

When two or more clips are recorded on the disc, they are played back continuously.

#### Note

No audio is output when non-audio signals are played back.

### To jump to the next or previous clip, then start playback

Use the PREV button, NEXT button, jog dial, or shuttle dial.

### To stop playback

Press the STOP button.

If you play back to the end of the last clip, playback automatically stops.

If, in this state, you press the PLAY button, the message “ALARM DISC END.” appears on the display.

To carry out playback again, move back to the desired clip using the PREV button, jog dial or shuttle dial.

### To set shot marks

While playing back a disc, you can set essence marks such as SHOT MARK1 and SHOT MARK2 in desired frames. To set a SHOT MARK1 or SHOT MARK2, hold down the  $\uparrow$ /MARK1 or  $\downarrow$ /MARK2 button and press the SET button.

#### Note

To erase or change essence marks, use the supplied PDZ-1 Proxy Browsing Software.

### Playback in jog mode

In jog mode, you can control the speed of playback by the speed of turning the jog dial. The playback speed range is  $-1$  to  $+2$  times normal speed.

To carry out playback in jog mode, proceed as follows.

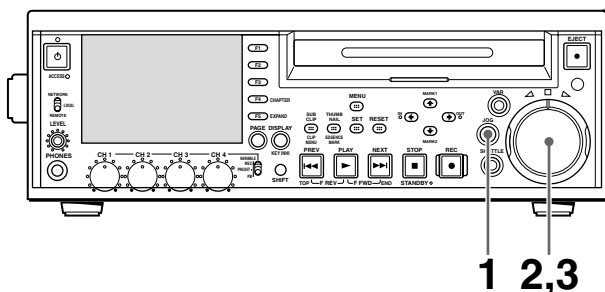

- 1 Press the JOG button, turning it on.
- 2 Turn the jog dial in the desired direction, at the speed corresponding to the desired playback speed.  
Playback in jog mode starts.
- 3 To stop playback in jog mode, stop turning the jog dial.

Normally, the unit enters jog mode as soon as you turn the jog dial. If you want it to enter jog mode only when you press the JOG button, set OPERATIONAL FUNCTION >SEARCH ENABLE in the setup menu to "VIA SEARCH KEY".

### Playback in shuttle mode

In shuttle mode, you can control the speed of playback by the angular position of the shuttle dial. The range of playback speed is  $\pm 20$  times normal speed. To carry out playback in shuttle mode, proceed as follows.

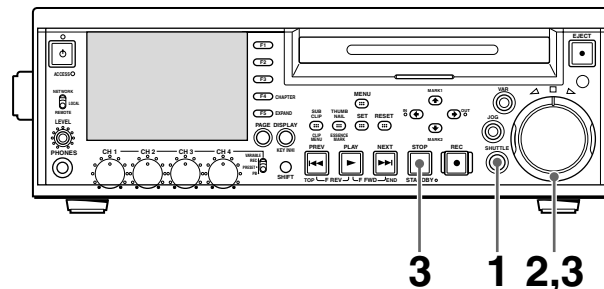

- 1 Press the SHUTTLE button, turning it on.
- 2 Turn the shuttle dial to the desired angle corresponding to the desired playback speed.  
Playback in shuttle mode starts.
- 3 To stop playback in shuttle mode, return the shuttle dial to the center position, or press the STOP button.

Normally, the unit enters shuttle mode as soon as you turn the shuttle dial.

If you want it to enter shuttle mode only when you press the SHUTTLE button, set OPERATIONAL FUNCTION >SEARCH ENABLE in the setup menu to "VIA SEARCH KEY".

### To alternate between normal-speed playback and shuttle mode playback

Set the shuttle dial to the position corresponding to the desired shuttle playback speed, then switch between normal-speed playback and shuttle playback by pressing the PLAY and SHUTTLE buttons alternately.

### Playback in variable-speed mode

In variable-speed mode, you can control the speed of playback in the range of  $-1$  to  $+2$  times normal speed. To carry out playback in variable-speed mode, proceed as follows.

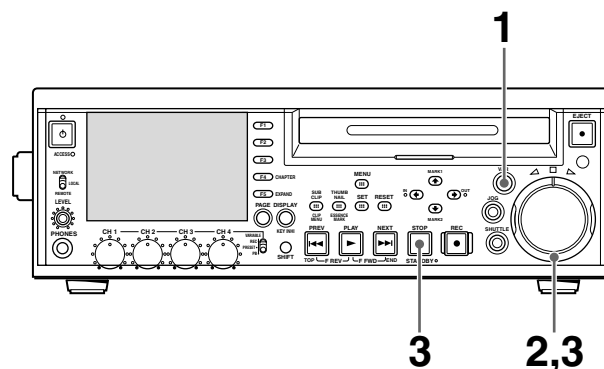

- 1 Press the VAR button, turning it on.
- 2 Turn the shuttle dial to the desired angle corresponding to the desired playback speed.



Playback in variable-speed mode starts.

- To stop playback in variable-speed mode, return the shuttle dial to the center position, or press the STOP button.

### To alternate between normal-speed playback and variable-speed mode playback

Set the shuttle dial to the position corresponding to the desired variable playback speed, then switch between normal-speed playback and variable-speed mode playback by pressing the PLAY and VAR buttons alternately.

## Searching for Clips With Thumbnails (Thumbnail Search)

You can display thumbnail images (index pictures) of all clips on the disc, and use them to cue up a desired clip.

### To display a list of thumbnail images

With the SUB CLIP button off, press the THUMBNAIL button, turning it on.

A list appears showing thumbnails of 12 clips on the disc, including the clip being currently played back. (In the following description, this is referred to as the “thumbnail screen”.)

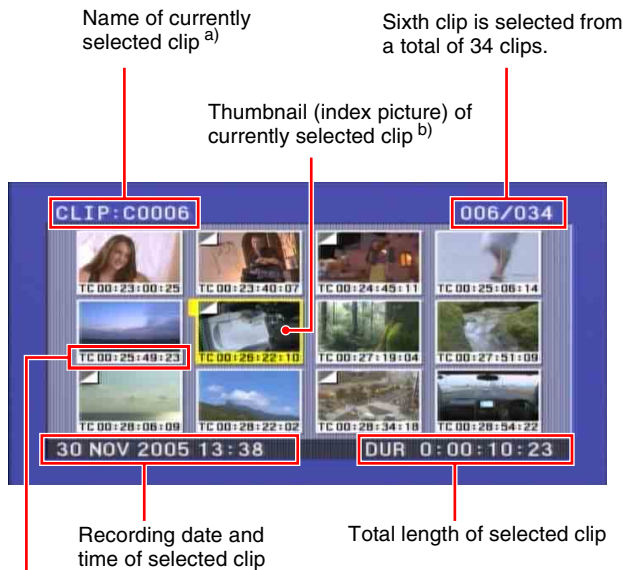

Clip information (recording date and time, initial timecode, total length, and so on)

a) When a title has been assigned to a clip (see page 60), the title is enclosed in double quotation marks, for example “TITLE00001”.

b) A mark is shown to indicate that the thumbnail (index picture) is not the first frame of the clip. (See “To change a thumbnail image (index picture)” on page 50.)

### To return to the original screen

Press the THUMBNAIL button, turning it off.

In any of the following screens, you can press the THUMBNAIL button to return to the original screen.

## To select a thumbnail image and start playback

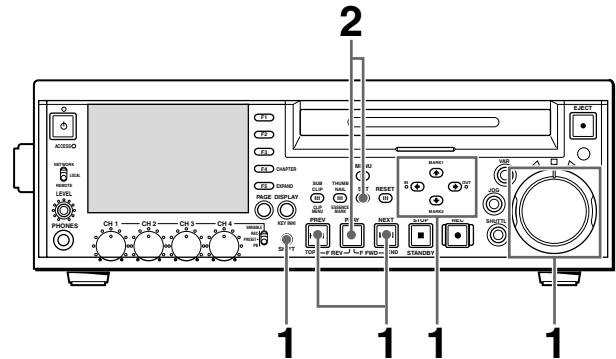

- Do one of the following to select the thumbnail of the clip you want to cue up.

- Press the arrow buttons.
- Turn the jog or shuttle dial.
- Press the PREV or NEXT button: Move to the previous or next thumbnail.
- Press the TOP (SHIFT + PREV) or END (SHIFT + NEXT) button: Move to the first or last thumbnail.
- Holding down the SHIFT button, press the ↑/MARK1 or ↓/MARK2 button: Display the previous or next page.

- Press the SET button or the PLAY button.

If you press the SET button, a still image appears showing the first frame of the selected clip.

If you press the PLAY button, playback starts from the first frame of the selected clip.

### Note

The factory default setting for the clip thumbnail is such that the first frame of the clip is used as the thumbnail but you can change this setting so that any desired frame is used as the clip thumbnail (see “To change a thumbnail image (index picture)” (page 50)). However, clip list playback always starts from the first frame, regardless of the thumbnail.

## To change the clip information displayed in the thumbnail list

With the thumbnail list displayed, proceed as follows.

- Press the CLIP MENU (SHIFT + SUB CLIP) button or the MENU button to display the clip menu.

- 2 Press the **↑/MARK1** button or **↓/MARK2** button to select CLIP INFORMATION.
- 3 Press the SET button.  
A list of CLIP INFORMATION items appears.  
**DATE:** Date and time of recording  
**TIME CODE:** Timecode of the first frame in the clip  
**DURATION:** Recording time  
**SEQUENCE NUMBER:** Thumbnail sequence number

See “To select a thumbnail image and start playback” (page 49) for more information about sequence thumbnail numbers.

“TIME CODE” is selected when the unit is shipped from the factory.

- 4 Press the **↑/MARK1** or **↓/MARK2** button to select an item that you want to display as part of the clip information, and then press the SET button.  
The selected item is displayed as clip information under the thumbnail image.

### To change a thumbnail image (index picture)

With the thumbnail list displayed, proceed as follows.

- 1 Press the CLIP MENU (SHIFT + SUB CLIP) button or the MENU button to display the clip menu.
- 2 Press the **↑/MARK1** button, **↓/MARK2** button, **←/IN** button, or **→/OUT** button to select SET INDEX PICTURE.
- 3 Press the SET button.  
“SET INDEX” appears in the upper left of the screen.
- 4 Select the clip whose thumbnail you want to change (you can do this with the same operations as step 1 of “To select a thumbnail image and start playback” (see page 49)).
- 5 Press the SET button.

An enlargement of the current thumbnail image appears.

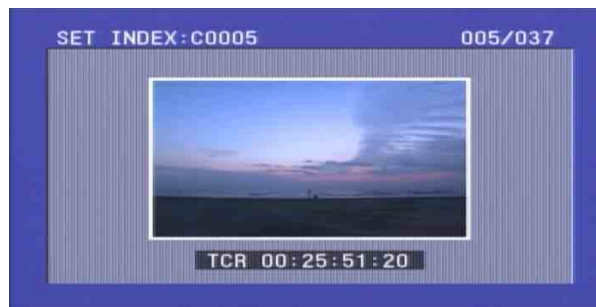

- 6 Press the PLAY button or use the jog or shuttle dial to play back the clip and display the frame that you want to use as the thumbnail image.

**To cancel the thumbnail image change**  
Press the RESET button.

- 7 Press the SET button.  
This returns you to the thumbnail list. The specified image appears as the thumbnail of the selected clip. A mark is shown to indicate that the thumbnail is not the first frame of the clip.

Mark indicating that the thumbnail is not the first frame



#### Note

When you press the SET button or the PLAY button after selecting a clip with this mark displayed, the clip is not cued up to the position of the thumbnail. It is always cued up to the first frame.

## Searching With the Expand Function

The expand function allows you to divide a selected clip into 12 blocks, and to display thumbnails of the first frame in each block in the thumbnail list. This function is available whenever the thumbnail list is displayed. This function allows you to quickly review the content of the selected clip, and to search efficiently for a target scene. You can repeat the expand operation up to three times (→ 12 blocks → 144 blocks → 1,728 blocks).

**Note**

The maximum number of blocks may be larger than 1728 when the recorded duration of the clip is short. In this case, the frame interval of expanded thumbnails is fixed at 1 frame. This allows you to view expanded thumbnails at equal intervals.

**To execute the expand function**

- 1 With the thumbnail list displayed, select the clip that contains the scene that you want to find.
- 2 Press the EXPAND (F5) button.

The selected clip is divided into 12 blocks, and the first frame of each block appears in the thumbnail list.



- 3 As required, repeat step 2 once or twice.

**Note**

Thumbnails cannot be further divided once their duration reaches 1 frame.

**To return to the thumbnail list screen of the previous level**

Hold down the SHIFT button and press the EXPAND button.

**To return to the thumbnail list screen**

Press the RESET button.

- 4 When you find the thumbnail of the target scene, press the SET button or the PLAY button.

If you press the SET button, a still image appears showing the selected frame.

If you press the PLAY button, playback starts from the selected frame.

## Searching for Frames With Essence Marks

Proceed as follows.

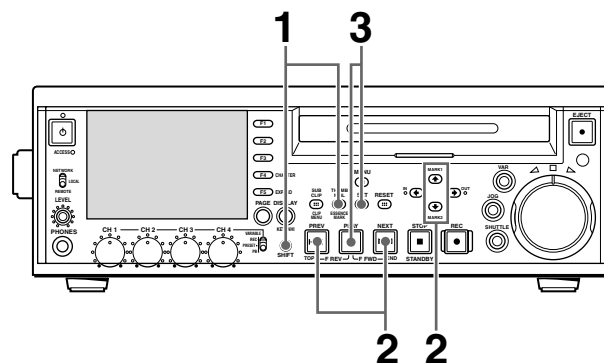

- 1 With the SUB CLIP button off, press the ESSENCE MARK (SHIFT + THUMBNAIL) button, turning it on.

The essence mark selection screen appears.



Essence marks not recorded on the disc are displayed in gray.

**To return to the thumbnail list screen**

Press the RESET button.

- 2 Press the PREV or NEXT button, or press the **↑**/MARK1 button or **↓**/MARK2 button, to select the desired essence mark.
- 3 Press the SET button.

A list appears showing the frames which contain the selected essence mark.

Indicates that this is a list of frames containing the essence mark (SHOT MARK1) Sixth frame is selected from a total of 36 SHOT MARK1 frames

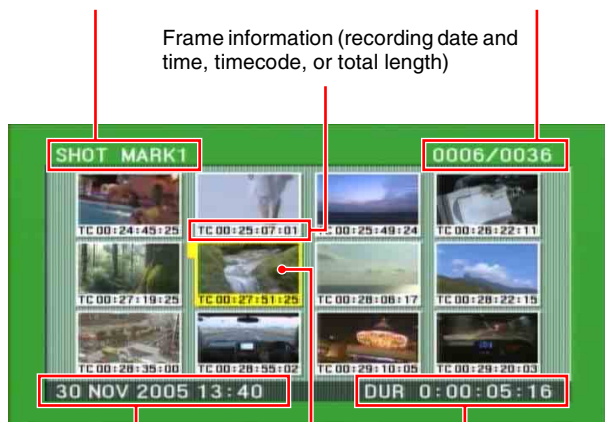

Recording date and time of the clip containing the selected frame

Time from selected shot mark to next shot mark

- 4 Select the clip whose thumbnail you want to change (you can do this with the same operations as step 1 of “To select a thumbnail image and start playback” (see page 49)).

- 5 Press the SET button or the PLAY button.

If you press the SET button, a still image appears showing selected essence mark frame.

If you press the PLAY button, playback starts from the selected essence mark frame.

## Searching With the Chapter Function

When a clip contains shot marks, you can display them as chapter thumbnails.

See “To set shot marks” (page 46) about how to set shot marks.

- 1 With the thumbnail list visible, select the thumbnail of the clip that contains the scenes you want.

An “S” mark appears in the upper right of the thumbnails of clips which have shot marks set.

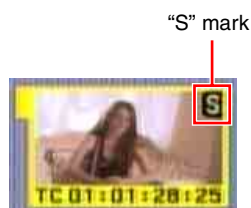

- 2 Press the CHAPTER (F4) button.

The CHAPTER screen appears, showing thumbnails of the frames where the shot marks are set.

“S1” and “S2” marks on thumbnails indicate frames where SHOT MARK1 and SHOT MARK2 marks are set.

Thumbnails without a mark are frames where REC START marks are set.



- 3 Select the clip whose thumbnail you want to change (you can do this with the same operations as step 1 of “To select a thumbnail image and start playback” (see page 49)).

- 4 Press the SET button or the PLAY button.

If you press the SET button, a still image appears showing selected shot mark frame.

If you press the PLAY button, playback starts from the selected shot mark frame.

### To delete shot marks at chapter positions

You can delete shot marks (SHOT MARK1 and SHOT MARK2) at chapter positions in the CHAPTER screen. (REC START essence marks cannot be deleted.)

- 1 With the CHAPTER screen visible, press the CLIP MENU (SHIFT + SUB CLIP) button or MENU button to display the clip menu.

- 2 Select DELETE SHOT MARK.

“DELETE SHOT MARK” appears in the upper left of the screen.

- 3 Select the thumbnail image of the shot mark position to delete.

- 4 Press the SET button.

A message appears, asking for confirmation of the deletion.

- 5 Press OK to execute the deletion or CANCEL to cancel it, and then press the SET button.



## Clip List Playback

You can play back clips in the same order as in a clip list created using the scene selection function.

See Chapter 4 for more information about scene selection.

### Playing back in clip list order

Proceed as follows.

- 1 If the clip list that you want to play exists on the disc, load it into the current clip list.
- 2 Press the SUB CLIP button, turning it on.
- 3 Press the PLAY button.

Playback begins from the first sub clip in the current clip list.

#### Notes

- Stop the unit before using the SUB CLIP button. Press the STOP button if a message appears telling you to stop the unit.
- Depending on the length of sub clips in the clip list and their arrangement on the disc, playback may freeze momentarily between sub clips.

### To cue up with sub clip thumbnail images

With the desired clip list loaded in the current clip list, proceed as follows.

- 1 Press the SUB CLIP button and the THUMBNAIL button, turning them on.

Thumbnails of the first frames in the sub clips appear.

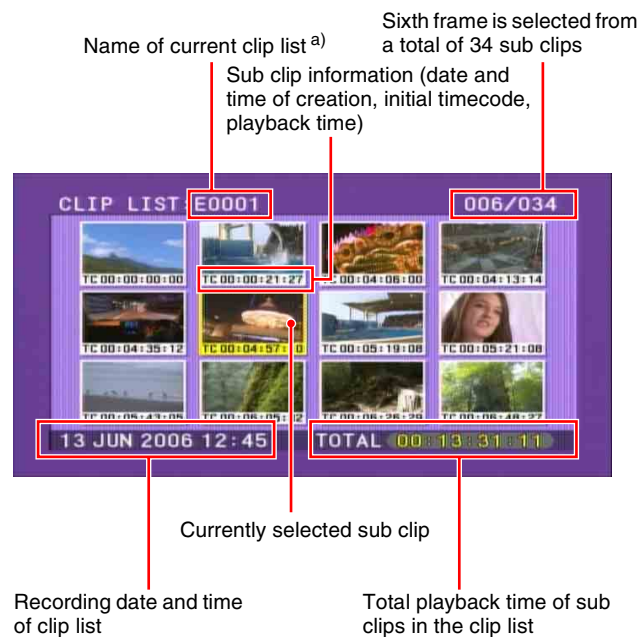

a) When a title has been assigned to a clip list, the title is enclosed in double quotation marks, for example "SAKURA".

#### To return to the previous screen

Press the THUMBNAIL button, turning it off.

- 2 Select the clip whose thumbnail you want to change (you can do this with the same operations as step 1 of "To select a thumbnail image and start playback" (see page 49)).
- 3 Press the SET button or the PLAY button.

If you press the SET button, a still image appears showing the first frame of the selected sub clip. If you press the PLAY button, playback starts from the first frame of the selected sub clip.

#### Note

In clip lists, the first frame of the sub clip (the In point frame) is always displayed as the thumbnail.

## Repeat Playback

You can perform repeat playback for normal and clip list playback.

To perform repeat playback, set OPERATIONAL FUNCTION > REPEAT MODE in the setup menu to "ON" (a REPEAT indicator appears in the display), and then proceed as follows.

- 1 Insert a disc.

To perform repeat playback for normal playback, proceed to step 3.

**2** To perform repeat playback for clip list playback, load a clip list into the current clip list and then press the SUB CLIP button.

**3** Press the PLAY button.

Playback starts from the saved playback position.

**Normal playback:** When playback of the last clip finishes, it resumes from the start of the disc, repeatedly playing from the first through the last clip on the disc.

**Clip list playback:** When playback of the last sub clip finishes, it resumes from the start of the clip list, repeatedly playing from the first through the last sub clip in the clip list.

Repeat playback begins the unit is powered on if it is powered on with a disc loaded and OPERATIONAL FUNCTION >REPEAT MODE in the setup menu set to "ON". Clip list playback starts from the first sub clip in the clip list.

### To start repeat playback from the device connected to the REMOTE (9P) connector

Set OPERATIONAL FUNCTION >REPEAT MODE in the setup menu to "ON", and then send the command to start repeat playback from the external device.

*For details of commands, refer to the REMOTE (9-pin) Protocol Manual for the PDW series (not supplied).*

### To stop repeat playback

Do one of the following.

- Set OPERATIONAL FUNCTION >REPEAT MODE in the setup menu to "OFF".
- Operate any of the playback buttons except the PLAY button, or operate the jog or shuttle dial.
- From the external device connected to the REMOTE (9P) connector on this unit, send a command other than the repeat playback start command to this unit.

#### Note

The unit enters search mode when you conduct a search, and stop mode at the end of the disc.

## Locking (Write-protecting) Clips

In the thumbnail screen, you can lock them so that they cannot be deleted or altered.

Locking prevents the following operations on clips.

- Deletion
- Renaming by FAM or FTP
- Changing the thumbnail image (index picture)
- Adding and deleting shot marks

#### Notes

- Locked clips are deleted along with other clips.
- Clips cannot be locked or unlocked when the Write Inhibit tab of the disc is set to the recording disabled position, or when "REC INH" on page P1 of the function menu is set to "ON".

**1** With the SUB CLIP button off, press the THUMBNAIL button, turning it on.

The thumbnails of the clips on the disc appear.

**2** Select the clip to lock (you can do this with the same operations as step 1 of "To select a thumbnail image and start playback" (see page 49)).



**3** Press the MENU button.

The CLIP menu appears.

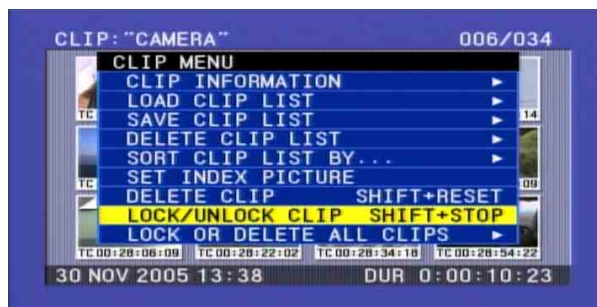

**4** Use the ▲/MARK1 or ▼/MARK2 button to select "LOCK/UNLOCK CLIP", and then press the SET button.

A lock confirmation screen appears. This screen displays clip names and clip titles.

### To cancel the lock operation and return to the THUMBNAIL screen

Select "CANCEL", and then press the SET button. Press the RESET or MENU button.

**5** With OK selected, press the SET button.

You return to the thumbnail screen, and a lock icon appears on the thumbnail of the selected clip to show that it is locked.

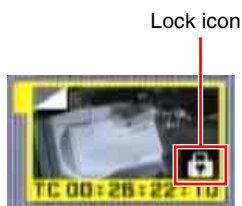

Locked clips cannot be deleted or set the thumbnail image (index picture) and so on. Unlock the clip if you want to perform any of these operations.

### To lock clips with a shortcut operation

After carrying out step **2** in the procedure, press the STOP button with the SHIFT button held down (shortcut operation).

You can lock clips without displaying the CLIP MENU.

### To unlock clips

Carry out step **2** of “Locking clips” to select a locked clip (one with the lock icon displayed on its thumbnail). Then do one of the following.

- Carry out steps **3** and **4** of “Locking Clips.”
- Press the STOP button with the SHIFT button held down (shortcut operation).

### To lock all clips

**1** Carry out steps **1** and **3** of “Locking Clips” to display the CLIP MENU.

**2** Use the  $\blacktriangle$ /MARK1 or the  $\blacktriangledown$ /MARK2 button to select LOCK OR DELETE ALL CLIPS, and then press the  $\blackrightarrow$ /OUT button.

A submenu screen appears.

**3** Select “LOCK ALL CLIPS”, and then press the SET button.

A confirmation screen appears.

**4** With “OK” selected, press the SET button.

All clips are locked.

### To unlock all clips

Carry out the procedure in “To lock all clips,” selecting UNLOCK ALL CLIPS in step **2**.

## Deleting Clips

You can delete selected clips while checking their content.

### Notes

- Clips cannot be deleted when the Write Inhibit tab of the disc is set to the recording disabled position, or when “REC INH” on page P1 of the function menu is set to “ON”.
- Locked clips cannot be deleted.
- When the target clip is referenced in a clip list, the clip list that references the clip will also be deleted.
- If the deletion target clip is referenced by the current clip list, all of the referenced sub clips, and only those sub clips, are deleted simultaneously.

**1** With the SUB CLIP button off, press the THUMBNAIL button, turning it on.

The thumbnails of the clips on the disc appear.

**2** Select the clip to delete. (You can do this with the same operations as step **1** of “To select a thumbnail image and start playback” (see page 49)).



**3** Press the MENU button.

The CLIP menu appears.

**4** Use the  $\blacktriangle$ /MARK1 or the  $\blacktriangledown$ /MARK2 button to select “DELETE CLIP,” and then press the SET button.

A deletion confirmation screen appears and then thumbnails of four frames (the first frame, intermediate frame 1, intermediate frame 2, and the last frame) in the target clip appear. At the same time, the clip name, title, date and time of creation, and duration appear.

One of the following messages appears, depending on whether the target clip is referenced in a clip list.

- When the target clip is not referenced in a clip list: “DELETE CLIP?”
- When the target clip is referenced in a clip list: “DELETE CLIP & CLIP LIST?” (The clip list that references the clip will also be deleted.)

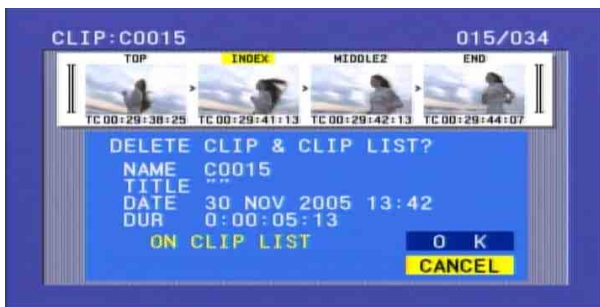

### To cancel the deletion and return to the CLIP MENU

Select "CANCEL", and then press the SET button. Press the RESET or MENU button.

- Use the  $\blacktriangle$ /MARK1 button to select "OK", and then press the SET button.

The clip is deleted and you return to the thumbnail screen.

### To go to the clip deletion screen without displaying the CLIP MENU

After step 2, press the RESET button with the SHIFT button held down (shortcut operation).

The clip deletion screen appears directly, without displaying the CLIP MENU.

### To delete all clips

- Carry out steps 1 and 3 of "Deleting Clips" to display the CLIP MENU.

- Use the  $\blacktriangle$ /MARK1 or the  $\blacktriangledown$ /MARK2 buttons to select "LOCK OR DELETE ALL CLIPS", and then press the  $\blacktriangleright$ /OUT button.

A sub menu appears.

- Select "DELETE ALL CLIPS", and then press the SET button.

A deletion confirmation screen appears.

- To execute the deletion, use the  $\blacktriangle$  button to select "OK", and then press the SET button.

All clips are deleted.

However, locked clips are not deleted.

If all clips have been deleted, you return from the thumbnail screen to the original screen.

## Assigning Sequence Numbers to Thumbnails

You can assign sequence numbers to displayed thumbnails.

- With the SUB CLIP button off, press the THUMBNAIL button, turning it on.

Thumbnails of the clips on the disc appear.

- Press the MENU button.

The CLIP menu appears.

- Use the  $\blacktriangle$ /MARK1 button to select "CLIP INFORMATION", and then press the SET button.

A sub menu appears.

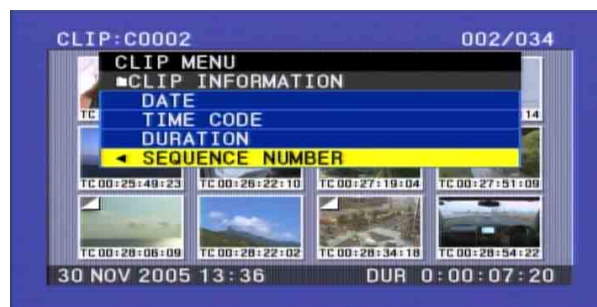

- Use the  $\blacktriangledown$ /MARK2 button to select "SEQUENCE NUMBER", and then press the SET button.

As shown in the following figure, sequential numbers are assigned to thumbnails.

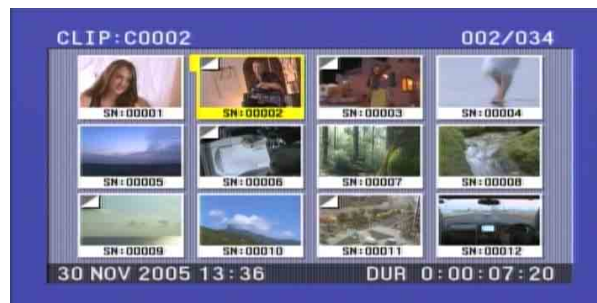



---

## Overview

### What is scene selection?

Scene selection is a function which allows you to select material (clips) from the material recorded on a disc and perform cut editing. You can do this by operating on this unit only.

- Scene selection is a convenient way to perform cut editing in the field and in other offline situations.
- With the scene selection function, you create clip lists (edit data). The clips themselves are not changed, so you can repeat the operation as often as you like.
- Clip lists created with the scene selection function can be played back on this unit.
- The scene selection function makes it easy to carry out operations such as adding material in clip units, adding parts of clips, adding by chapter, reordering the playback order, modifying In and Out points, and deletion, all on this unit.
- Clip lists (edit data) created with the scene selection function can be used on XPRI and other full-feature nonlinear editing systems.

# Flow of scene selection editing

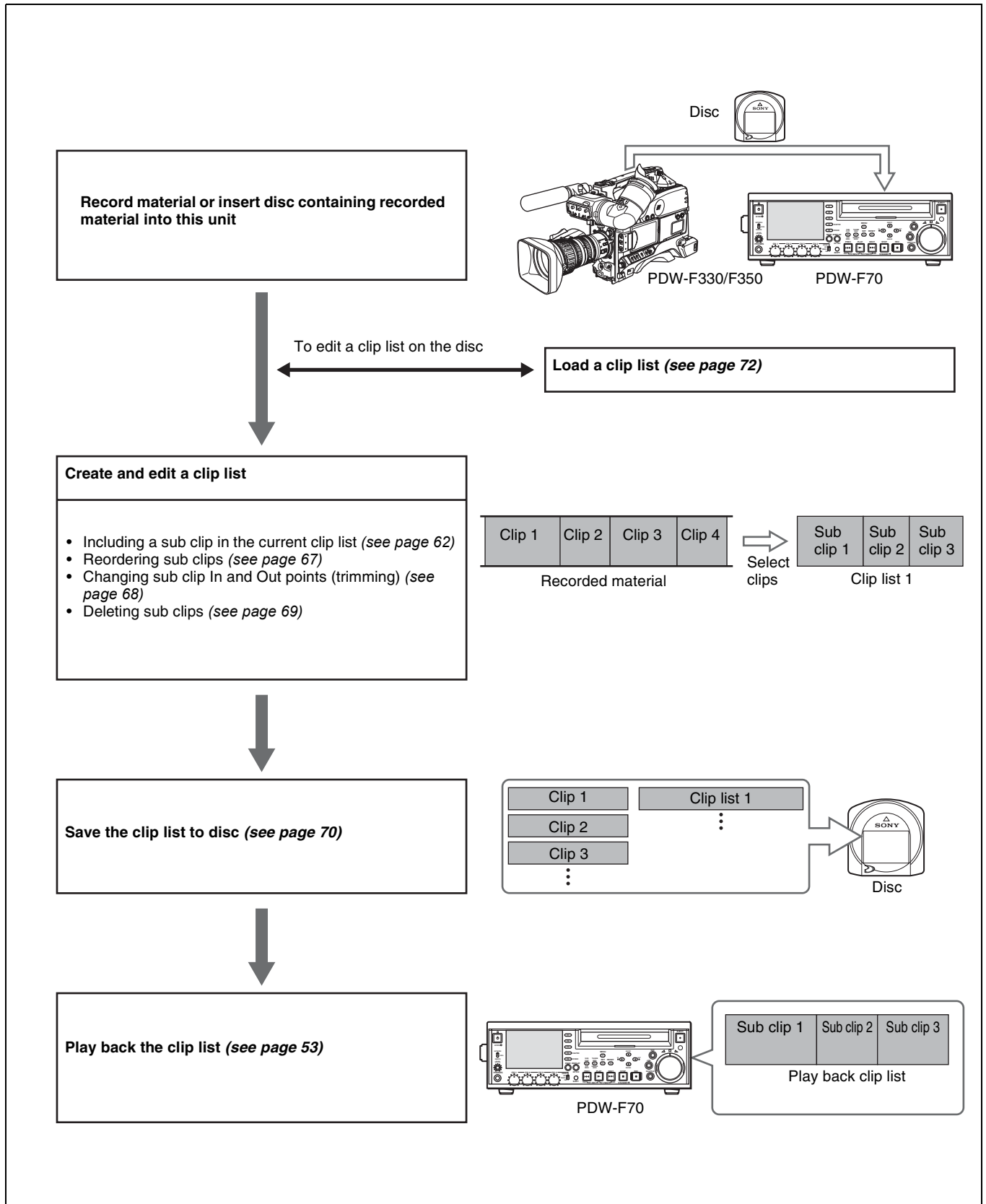

## Clips

Material recorded with this unit is managed in units called “clips”. A clip contains the material between a recording start point and a recording end point. Clips have numbers beginning with C, for example C0001.

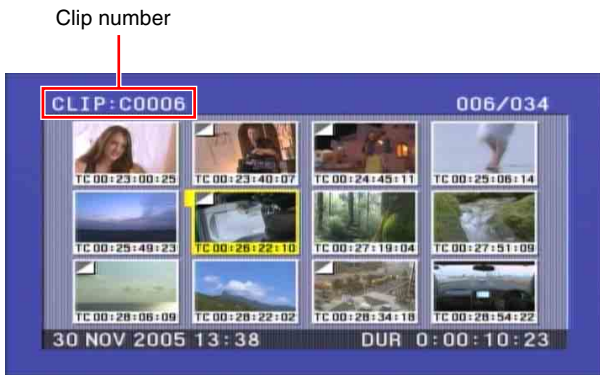
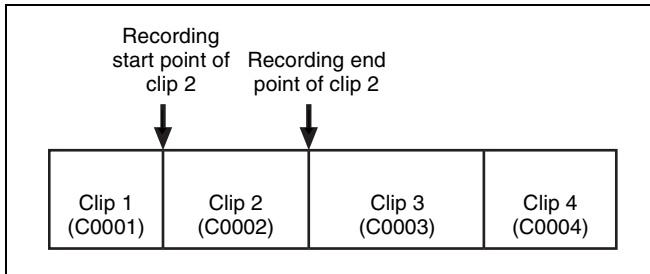

Instead of using clip numbers, you can manage clips by assigning clip titles. For details, see “Assigning Clip Titles” (page 60).

## Clip lists

Data called a “clip list” is created when you use the scene selection function to select desired clips from the clips stored on a disc. Clip lists have numbers beginning with E, for example E0001. Up to 99 clip lists can be saved on a disc.

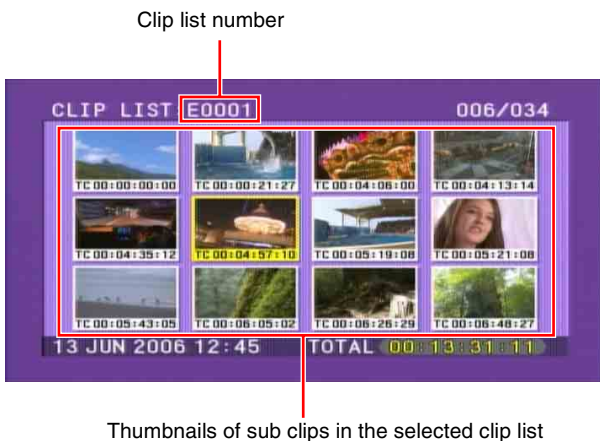

Thumbnails of sub clips in the selected clip list

## Sub clips (clips in clip lists)

The specified clips (or parts of clips) in a clip list are called “sub clips”. Sub clips are virtual data specifying ranges in the original clips. Clip data in the original clips is not overwritten. The following figure shows the relation between clips and sub clips.

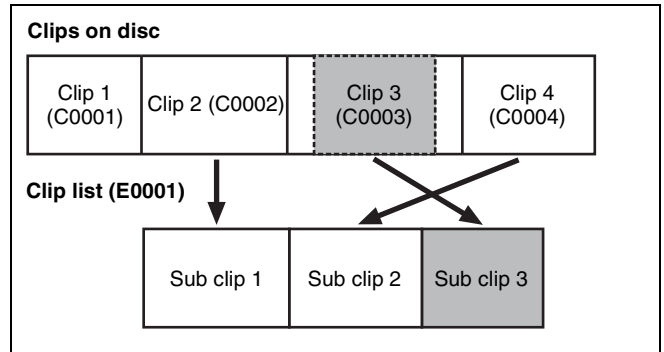

In the above example, the whole of clip 2 has been added as sub clip 1, and the whole of clip 4 has been added as sub clip 2. Sub clip 3 is part of clip 3. Therefore, when clip list E0001 is played back, clip 4 is played after clip 2, and then the part of clip 3 shown in gray color is played.

## Clip list editing (current clip list)

To edit a clip lists, you need to load the clip from the disc into the internal unit memory. The clip list which is currently loaded into the unit memory is called the “current clip list”. The current clip list is always the target of sub clip creation and editing. Clip list playback also uses the current clip list. After creating and editing a clip list, you need to save it to disc.

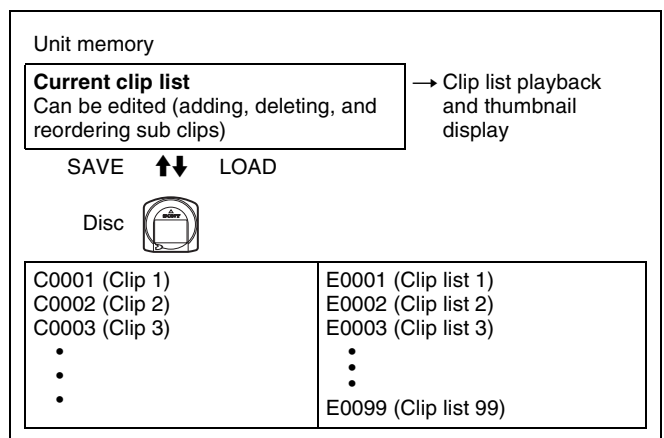

## Clip list playback

Clips and clip lists are saved together on a disc. Clips are played back according to clip list data.

## Assigning Clip Titles

When the setup menu item OPERATIONAL FUNCTION >CLIP TITLE >AUTO TITLE (see page 87) is set to “ENABLE”, titles are displayed instead of clip numbers for all clips recorded after the setting is made.



Titles are made up of a prefix of up to 10 characters and a 5-digit number. The factory default prefix is “TITLE”, and the initial value of the number is 00001. Therefore, the title of the first clip created with the “ENABLE” setting is “TITLE00001”. The number is incremented for each subsequent clip.

See “System Menu” (page 83) in Chapter 6 for more information about the setup menu.

### To switch to clip number display

Set CLIP TITLE >AUTO TITLE to “DISABLE”. Clip numbers are displayed for all clips recorded after the setting is made.

#### Notes

- Titles are displayed instead of clip numbers for clips that have titles.
- Use the CLIP STATUS screen of the disc menu (see page 99) if you want to check the clip number of a clip that has a title.

### To assign clip titles

You can set the clip title prefix and the initial clip title number to arbitrary values. For example, if you set the prefix to “SCENE” and the initial number to 00100, the next clip to be created will have the title “SCENE-00100”.

- 1 Select OPERATIONAL FUNCTION >CLIP TITLE >TITLE in the setup menu, and then press the **➔**/OUT button.

The CLIP AUTO TITLING screen appears.

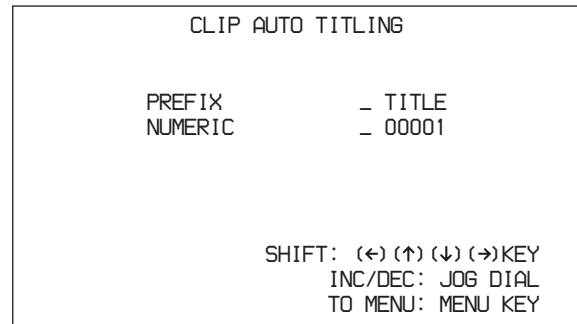

**PREFIX:** Prefix (up to 5 alphanumeric characters and symbols)

**NUMERIC:** Initial value of the number (00001 to 99999)

- 2 Enter the prefix and initial number.

**To select the item to set and the character to set (it flashes):** Use the arrow buttons.

**To select a character to enter at the selected position:** Turn the jog dial.

**To return the settings to the factory defaults:** Press the RESET button.

- 3 When you are finished entering the prefix and initial number, press the SET button.

The message “NOW SAVING...” appears, the title is saved, and the menu disappears from the screen.

**To clear the menu from the screen without saving a title**

Press the MENU button twice.

#### Note

If you return the initial number to the default value after creating several clips, and then continue recording, clips with the same titles may be created.

## Assigning User-Defined Clip and Clip List Names

The following standard format names are assigned automatically to clips and clip lists that are created or recorded by XDCAM devices.

Clips: C0001 to C0300

Clip lists: E0001E01 to E0099E01

You can use the supplied PDZ-1 Proxy Browsing Software to assign user-defined names instead of the standard format names. You can assign user-defined names instead of the standard format names. Assigning meaningful names to clips and clip lists can facilitate file management.

You can also use this unit's “AUTO TITLING” function to assign user-defined names to clips.

### To assign clip names on this unit

The title assigned to clip becomes its clip name (file name).

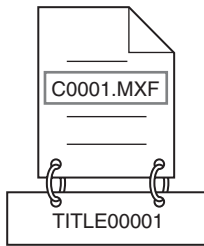

When sub item "AUTO NAMING" is set to "C\*\*\*\*"

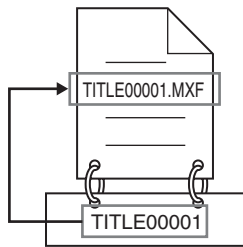

When sub item "AUTO NAMING" is set to "title"

**1** Set OPERATIONAL FUNCTION >CLIP TITLE >AUTO TITLE in the setup menu to "ENABLE" (see page 87).

**2** Set OPERATIONAL FUNCTION >FILE NAMING >AUTO NAMING to "free".

You are now able to use clips and clip lists with user-defined names.

**3** Set OPERATIONAL FUNCTION >FILE NAMING >AUTO NAMING to "title".

**C\*\*\*\*:** Assign standard format clip names automatically.

**title:** Assign clip titles as clip names.

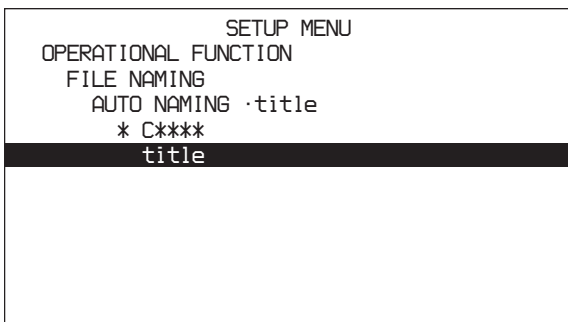

The same name will now be given to newly recorded clips.

### Note

When the first letter of the title setting on the CLIP TITLE menu is a space or period (.), the clip name is the title string minus the first letter.

### To enable clip and clip list renaming by FAM

Carry out step 2 "To assign clip names on this unit". It is now possible to write, transfer, and rename clips and clip lists with user-defined names over file access mode (FAM) connections (see page 78).

To change clip names, execute the "Rename" command for a file in the Clip folder with the extension ".MXF". The extension ".MXF" cannot be changed.

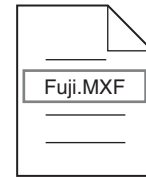

Clip renaming by FAM is enabled

To change clip list names, execute the "Rename" command for a file in the Edit folder with the extension ". SMI".

The extension ". SMI" cannot be changed.



Clip list renaming by FAM is enabled

### To check clip names

Press the THUMBNAIL button to display the thumbnail screen, and select the clip whose name you want to check. The name of the selected clip appears at the upper left of the screen.

However, when a title has been assigned to a clip, display of the title takes priority. Titles are displayed enclosed in double quotation marks (" ").

See "To display a list of thumbnail images" (page 49) for more information about the thumbnail screen.

### Note

Clip names, clip list names, and titles are converted as follows for display in the thumbnail screen and the CLIP menu.

- If the names are longer than 15 characters, only the first 9 characters and the last 5 characters are displayed. Other characters are converted into □.
- Lowercase characters are converted into uppercase.
- Kanji and other multibyte characters, and some alphabetic symbols, are converted into □ characters.

Sequences of multiple □ characters is converted into single □ characters.

The following alphabetic symbols can be displayed.

:.?!#\*/()+-&@=<>%";\_

### Display example

JumpingDolphin\_No103



JUMPINGDO□NO103

## Creating Clip Lists

Select the desired clip, to include it in the current clip list as a sub clip.

There are two ways to select clips.

- Select from the thumbnail screen.  
You can select the desired clips from the thumbnail screen. You can also select continuous clips at a time. In addition, you can use the Expand function to specify a range to add in a clip or to load and add a clip with a chapter registered.
- Select while playing back and searching.  
You can select the scene to use while viewing the video (quick scene selection).

### Before starting

Insert a disc containing recorded clips into the unit.

## Including Clips Selected in the Thumbnail Screen in the Clip List

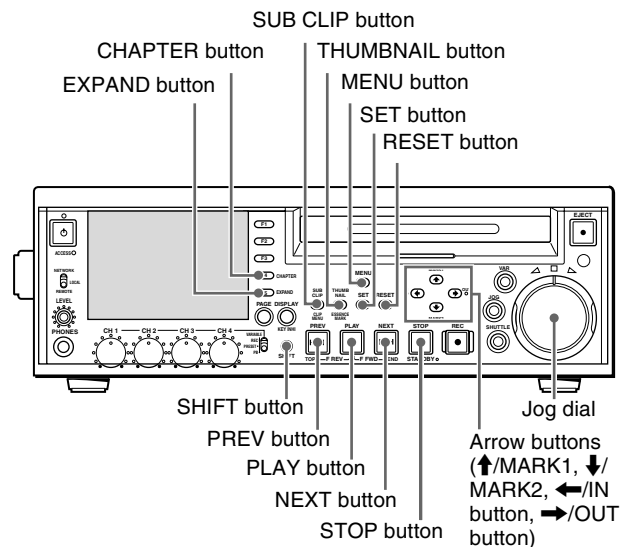

Proceed as follows.

- 1 With the SUB CLIP button unlit, press the THUMBNAIL button, lighting it.

Thumbnails of the clips on the disc appear. (In the following description, this is referred to as the “thumbnail screen”.)





2 Press the MENU button.

The CLIP menu appears (see page 71).  
(If no clip list is loaded in the current clip list, a screen as shown in step 3 appears.)

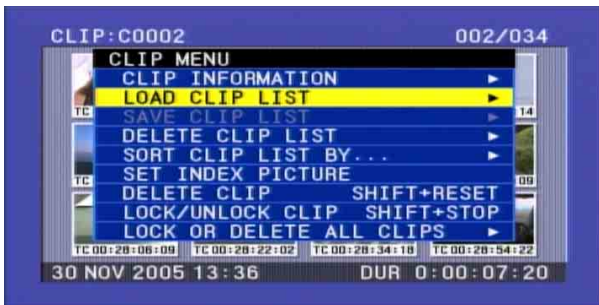

3 Use the ↑/MARK1 or ↓/MARK2 button to select LOAD CLIP LIST, and then press the SET button.

A clip list selection screen appears.  
For an already created clip list, the details including the creation date appear, and for an empty clip list, “NEW FILE” appears.

Display Item types

Press the →/OUT button to switch the display.



To select the type of clip list information to display  
Press the →/OUT button.

Each press of the button switches the display in the order Date >Title >Name.

The following information is displayed for display item types

+DATE: Date and time when the clip list was created or last modified

+TITLE: Title assigned to the clip list

+NAME: Name of the clip list, or a user-defined name  
You can use the supplied PDZ-1 Proxy Browsing Software to assign titles to clip lists.

4 Use the ↑/MARK1 or ↓/MARK2 button to select a clip list number such as E0001, and then press the SET button.

This returns to the thumbnail screen.

5 Press the SUB CLIP button.

The clip list window appears.

If you selected NEW FILE in step 4, the display shows the state with no clips loaded as shown below.  
Select NEW FILE to create a new clip list.

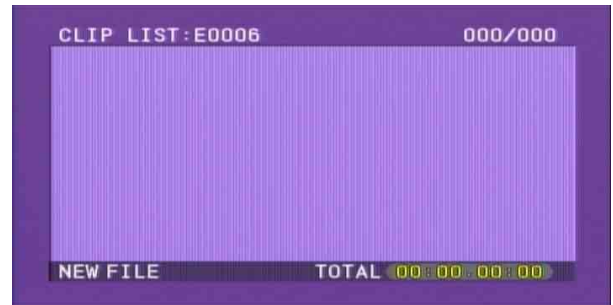

6 Press the MENU button.

The CLIP menu appears.

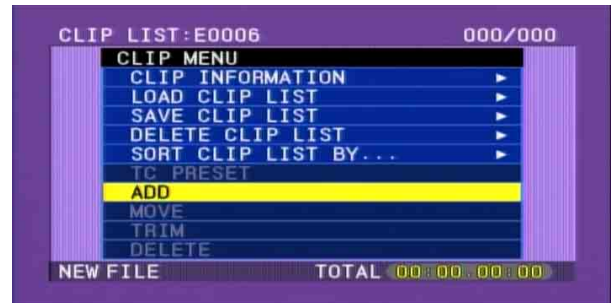

7 Use the ↑/MARK1 or ↓/MARK2 button to select “ADD”, and then press the SET button.

The scene selection window appears.

(Subsequently, this entire screen is called the “scene selection window”.)



- 8** Use the arrow buttons or jog dial to select the desired clip.

You can also select clips with the following operations.

**Press the PREV or NEXT button:** Moves to the previous or next clip.

**Press the PREV or NEXT button with the SHIFT button held down:** Moves to the first or last clip.

**Press the ↑/MARK1 or ↓/MARK2 button with the SHIFT button held down:** Switches to the previous or next page. Does not switch when there is only one page.

**Press the ←/IN button or →/OUT button with the SHIFT button held down:** Selects continuous multiple clips.

### To display the total duration of the current clip list after the addition of the selected clips

When you press the SHIFT button, the total duration of the selected clips is displayed, along with the total duration of the clip list after the addition of the selected clips. This allows you to check the new total duration before making the addition.

- 9** Press the SET button.

An I-shaped cursor appears in the lower part of the scene selection window.

Press the RESET button to return to the state of step **8**.

- 10** Use the arrow buttons or jog dial to move the I-shaped cursor to the desired position.

You can also move the I-shaped cursor with the following operations.

**Press the PREV or NEXT button:** Moves the cursor to the previous or next sub clip.

**Press the PREV or NEXT button with the SHIFT button held down:** Moves the cursor to the first or last sub clip.

**Press ↑/MARK1 or ↓/MARK2 button:** Moves to the 4th previous or 4th next sub clip.

- 11** With the SHIFT button held down, press the SET button.

All the clips selected in step **8** are added to the current clip list as sub clips and the scene selection window shows thumbnails of registered sub clips.

At the same time, the cursor disappears and you can select a new clip.

Total duration of sub clips in the current clip list

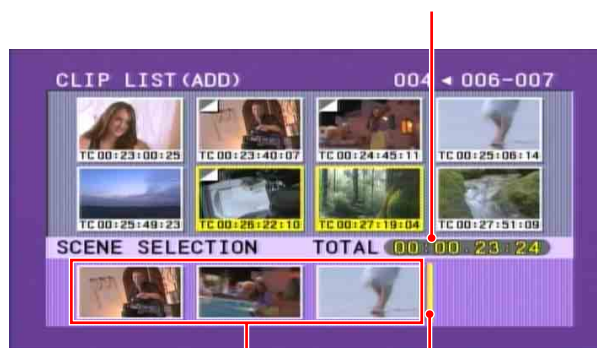

Cursor (shows insertion position of next sub clip)

Thumbnails of the sub clips already added to the current clip list

- 12** Repeat steps **8** to **11** until you have added all of the desired clips to the current clip list.

You can add the same clip as a sub clip any number of times.

- 13** When you have finished selecting all the clips you want, press the SET button without pressing the SHIFT button.

This closes the scene selection window, and the screen returns to the CLIP menu.

### To close the CLIP menu

Press the RESET button.

- 14** Save the current clip list to disc.

See “Saving the Current Clip List to Disc” (page 70).

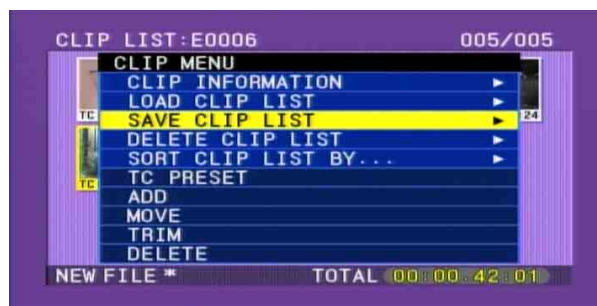

### Notes

- Unless the current clip list has been saved to disc, its contents will be lost when the unit is powered off or the disc is ejected. After creating a clip list, be sure to save it. An asterisk (\*) appears after the date and time of creation when a clip list has not been saved to disc.





Asterisk appears when clip list has not been saved to disc.

- Even when a clip whose thumbnail is not the first frame is added to a clip list, the thumbnail displayed in the clip list is always the first frame as a thumbnail.

### To add sub clips using the expand function

You can include a part of a sub clip in the current clip list by dividing the content of the sub clip into parts and displaying thumbnails of the parts.

For details, see Chapter 3 “Searching With the Expand Function” (page 50).

Proceed as follows.

- 1 After carrying out step 8 of the procedure in “Including Clips Selected in the Thumbnail Screen in the Clip List” (page 62), press the EXPAND (F5) button.

Thumbnails of the target clip divided into eight equal parts appear in the upper portion of the scene selection window.

#### To vary the expansion ratio

Each time you press the EXPAND button changes the ratio through the sequence  $\times 8 \rightarrow \times 64 \rightarrow \times 512$ . To return to the previous setting, hold down the SHIFT button and press the EXPAND button.

#### To cancel the expand display

Press the RESET button. You return to the scene selection window.

- 2 Carry out steps 8 to 12 of the procedure in “Including Clips Selected in the Thumbnail Screen in the Clip List” (page 62) to include thumbnails of the portions you want to include in the clip list.

The section from the selected thumbnail to the next thumbnail is included as a sub clip.

- 3 Save the current clip list to disc.

For details, see “Saving the Current Clip List to Disc” (page 70).

### Note

Even if you select several thumbnails, they are added to the clip list as one continuous sub clip.

### To add sub clips using the chapter function

The chapter function allows a thumbnail to be displayed for each shot mark recorded within a clip.

For details, see Chapter 3 “Searching for Frames With Essence Marks” (page 51).

- 1 Carry out step 8 of the procedure in “Including Clips Selected in the Thumbnail Screen in the Clip List” (page 62). An “S” mark appears in the upper right of thumbnails where short marks have been set. Select one of these thumbnails and press the CHAPTER button.

This displays thumbnails of chapters of the specified clip in the upper portion of the scene selection window.

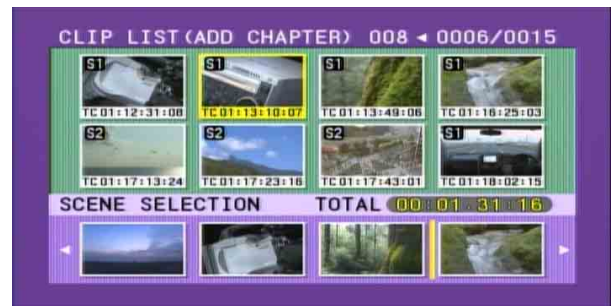

- 2 Carry out steps 8 to 12 of the procedure in “Including Clips Selected in the Thumbnail Screen in the Clip List” (page 62) to include thumbnails of the scenes you want to include in the clip list.

The section from the selected thumbnail to the next thumbnail is included as a sub clip.

- 3 Save the current clip list to disc.

For details, see “Saving the Current Clip List to Disc” (page 70).

When you select several chapter thumbnails, they are added to the clip list as a single sub clip.

### Quick Scene Selection (Adding Sub Clips During Recording, Playback, or Search)

Before starting, load the clip list to which you want to add a sub clip into the current clip list (see page 72).

You can use a trimming operation (see page 68) to change In and Out points set by the quick scene selection function.

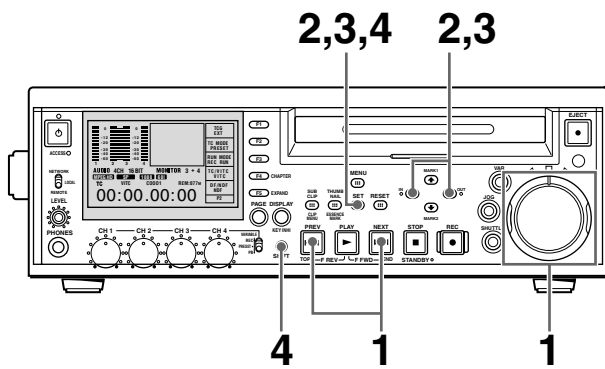

- 1 With the SUB CLIP button off, and the clip displayed in full-screen mode, play back the clip or conduct a search to find the point that you want to set as the In point.

**To display the desired clip in full-screen mode**

If the thumbnail screen is displayed, use the arrow buttons or jog dial to select the clip to display in full-screen mode, and then press the SET button.

**To search**

Use the jog and shuttle dials.

- 2 At the point you want to set as the In point, hold down the ◀/IN button and press the SET button.

An In point is set, and the IN indicator lights. If the unit is set up to superimpose character information on the display (see page 37), the In point timecode appears.

- 3 In the same way, search for the point you want to set as the Out point, and then hold down the ▶/OUT button and press the SET button.

An Out point is set, and the OUT indicator lights. If the unit is set up to superimpose character information on the display (see page 37), the Out point timecode appears.

**To check the In point or Out point**

The timecode of the In or Out point that you have set appears when you press the ◀/IN button or the ▶/OUT button. An image of the In point is cued up if you hold down the ◀/IN button and press the PREV button or NEXT button. An image of the Out point is cued up if you hold down the ▶/OUT button and press the PREV button or NEXT button.

**To check the duration**

Hold down the ◀/IN button and the ▶/OUT button at the same time.

The duration appears on the screen.

**To reset an In point or Out point**

With the ◀/IN button or ▶/OUT button held down, press the RESET button.

- 4 Holding down the SHIFT button, press the SET button.

The section between the In point and Out point is added to the end of the current clip list as a sub clip.

**When you set In and Out points stretching across several clips**

One sub clip is created for each of the clips.

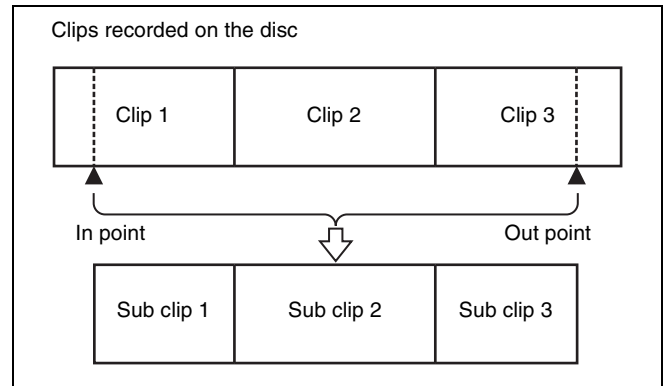

- 5 Repeat steps 1 to 4 until you have added all of the clips you want to the current clip list.

- 6 Save the current clip list to disc.

For details, see "Saving the Current Clip List to Disc" (page 70).

# Editing Clip Lists

You can select items from CLIP menus, and perform simple editing operations on clip lists and on sub clips registered in clip lists.

## Basic Operations

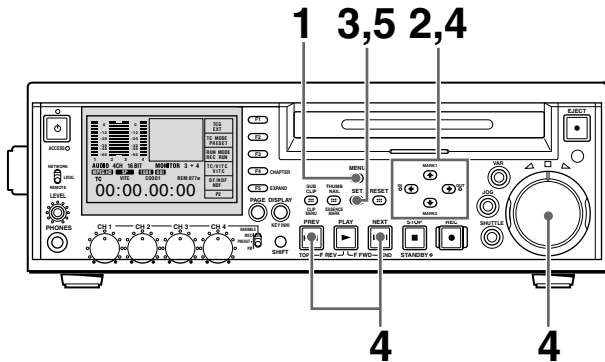

- 1 In the clip list screen, hold down the MENU button.  
The CLIP menu appears.

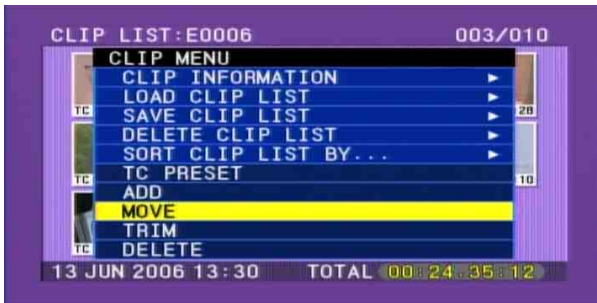

- 2 Press the **↑/MARK1** or **↓/MARK2** button to select the edit item you want.

You can carry out the following edit operations.

CLIP menu Item	Description
MOVE	Reorder sub clips.
TRIM	Change the In and Out points of sub clips.
DELETE	Delete unnecessary sub clips.
TC PRESET	Set the first timecode of the current clip list to any value.

- 3 Press the SET button.  
A screen appears to allow you to select the target sub clip of the operation. (A timecode setting screen appears if you have selected TC PRESET.)
- 4 Use the arrow buttons or jog dial to select the desired sub clip.

You can also select clips with the following operations.

- Press the PREV or NEXT button:** Moves to the previous or next clip.
- Press the PREV or NEXT button with the SHIFT button held down:** Moves to the first or last clip.
- Press **↑/MARK1** or **↓/MARK2** button with the SHIFT button held down:** Switches to the previous or next page. Does not switch when there is only one page.
- Press an **←/IN** button or **→/OUT** button with the SHIFT button held down:** Selects continuous multiple clips.

### Note

If you selected “TRIM”, you can select only one sub clip.

- 5 Press the SET button.  
This allows you to carry out the editing operation selected from the CLIP menu for the selected sub clip.
- 6 Carry out the selected editing operation.  
*For details, see the following pages.*

- Reordering sub clips:** Page 67
- Trimming sub clips:** Page 68
- Deleting sub clips:** Page 69
- Setting the timecode:** Page 69

- 7 Save the edited current clip list to disc.  
*For details, see “Saving the Current Clip List to Disc” (page 70).*

## Reordering Sub Clips

Proceed as follows.

- 1 Carry out steps 1 to 5 of the procedure in “Basic Operations” (*see page 67*) (select “MOVE” in step 2).

The I-shaped cursor indicating the move destination appears in the clip list window.

- 2 Use the arrow buttons or jog dial to move the I-shaped cursor to the desired position.

You can also move the cursor with the following operations.

- Press the PREV or NEXT button:** Moves the cursor to the previous or next sub clip.
- Press the PREV or NEXT button with the SHIFT button held down:** Moves the cursor to the first or last sub clip.
- Press **↑/MARK1** or **↓/MARK2** button with the SHIFT button held down:** Switches to the

previous or next page. Does not switch when there is only one page.

Indicates that 2nd sub clip will be moved to position of 7th sub clip.



I-shaped cursor showing position to which selected sub clip will be moved.

### To return to the clip list window without moving any sub clip

Press the RESET button.

### 3 Press the SET button.

The CLIP MENU appears after the sub clip order changes.

If you press the SHIFT + SET buttons instead of the SET button, you return to the state after step 4 in “Basic Operations”, allowing you to move another sub clip.



### 4 Save the current clip list to disc.

See “Saving the Current Clip List to Disc” (page 70).

## Modifying the In and Out Points of Sub Clips (Trimming)

Proceed as follows.

### 1 Carry out steps 1 to 5 of the procedure in “Basic Operations” (see page 67) (select TRIM in step 2).

The first frame (In point frame) of the selected sub clip appears. In this state, you can carry out playback and search all clips on the disc.



### To cancel the trim and return to the previous screen

Press the ↓/MARK2 button to display “OK” (the background color changes into yellow), and press the RESET button.

### 2 Carry out playback and search to find the new location of the In point or Out point of the selected sub clip.

### 3 At the scene where you want to set a new In or Out point, hold down the ←/IN button (to change the In point) or the →/OUT button (to change the Out point) and press the SET button.

Depending on the button that you pressed, a new In or Out point is set.

#### Note

The IN and OUT indicators flash if you set an Out point with timecode smaller than the In point. If this occurs, set the correct timecode.

### To change both the In and Out points

Carry out steps 2 and 3 for both the In and Out points.

### To reset the In or Out point

Hold down the ←/IN button or →/OUT button, and press the RESET button. The In or Out point is restored to the value it had before the sub clip trim screen opened.

### To cue up the In or Out point

The In point is cued up when you hold down the ←/IN button and press the PREV button or the NEXT button.

The Out point is cued up when you hold down the →/OUT button and press the PREV button or the NEXT button.

### 4 Once you have set the new In point or Out point, press the ↓/MARK2 button to select “OK”.

The background color of the OK button changes to yellow.

### 5 Press the SET button.



The CLIP MENU appears after the trim is executed. If you press the SHIFT + SET buttons instead of the SET button, you return to the state after step 4 in “Basic Operations”, allowing you execute another trim.

- 6 Save the current clip list to disc.

*For details, see “Saving the Current Clip List to Disc” (page 70).*

---

## Deleting Sub Clips

Proceed as follows.

- 1 Carry out steps 1 to 5 of the procedure in “Basic Operations” (see page 67) (select DELETE in step 2).

### To display the total duration of the current clip list after the addition of the selected clips

When you press the SHIFT button, the total duration of the selected clips is displayed, along with the total duration of the clip list after the deletion of the selected clips. This allows you to check the new total duration before making the deletion.

- 2 Press the SET button.

The deletion confirmation screen appears.

### To return to the clip list window without deleting any sub clip

Press the RESET button.

- 3 Use the ←/IN or →/OUT button to select “OK”, and then press the SET button.

The CLIP MENU appears after the deletion is executed.

If you press the SHIFT + SET buttons instead of the SET button, you return to the state after step 4 in “Basic Operations”, allowing you to execute another deletion.

- 4 Save the current clip list to disc.

*For details, see “Saving the Current Clip List to Disc” (page 70).*

---

## Setting the Start Timecode for the Current Clip List

Continuous timecode is used in clip lists, regardless of the timecode of the parent clips of sub clips. Therefore, you can set the start timecode for each clip list.

By default, the start timecode (LTC) for the current clip list is set to “00:00:00:00”.

To set this to a different value, proceed as follows.

- 1 Carry out steps 1 to 4 of the procedure in “Basic Operations” (see page 67) (select TC PRESET in step 2).

The timecode setting screen appears.



The timecode shown in this screen is the current initial timecode of the current clip list. If a clip list has been loaded from disc, and timecode has already been set for that clip list, then that value is displayed.

- 2 Use the ←/IN and →/OUT buttons to select the digit (HOUR, MIN, SEC or FRAME) you want to set.
- 3 Use the ↑/MARK1 and ↓/MARK2 buttons or jog dial to display the value you want to set.

### To cancel the timecode setting

Press the RESET button.

- 4 When you have finished setting all the digits you want, press the SET button.

The starting timecode for the current clip list is set to the specified LTC value. The count starts from that value when playback starts.

- 5 Save the current clip list to disc.

*For details, see “Saving the Current Clip List to Disc” (page 70).*

The drop-frame or non-drop-frame setting of the current clip list reflects the setting of the unit at the time when one of the following operations is performed.

- Adding the first sub clip
- Setting the start timecode

---

## Previewing the Edited Clip List

With the SUB CLIP button lit, press the PLAY button. If you are in the thumbnail screen (the THUMBNAIL button is lit), playback starts from the beginning of the selected sub clip.

However, if you press the SUB CLIP button to turn it off, and then press it again to light it, the playback start position is reset to the start of the clip list.

With the SUB CLIP button lit, press the PLAY button. You can repeat playback of the current clip list by setting SET UP > OPERATIONAL FUNCTION > REPEAT MODE to ON.

## Saving the Current Clip List to Disc

### Notes

- Edited clip list data is not saved unless you carry out this operation. If you are going to use the created or edited clip list data later on, be sure to save it to disc.
- If the Write Inhibit tab on the disc is set to the recording disabled position, you cannot save the current clip list to the disc.
- It may not be possible to record because of some other reason, for example not enough free capacity on the disc.

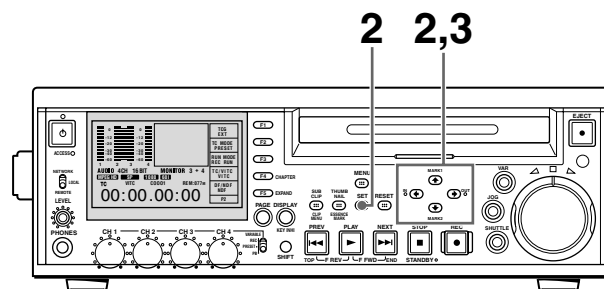

Proceed as follows.

- 1 Display the CLIP menu.  
*See “Displaying the CLIP menu” (page 71).*
- 2 Use the **↑**/MARK1 or **↓**/MARK2 button to move the cursor to “SAVE CLIP LIST”, and then press the SET button.

A list of clip lists appears. The date of creation or the title is displayed for each clip list. “NEW FILE” is displayed for clip lists without any saved data.

#### To switch between title display and date of creation display

Press the **→**/OUT button.

*For details, see “To select the type of clip list information to display” (page 63).*

- 3 Use the **↑**/MARK1 or **↓**/MARK2 button or jog dial to select the desired clip list, and then press the **→**/OUT button.

The current clip list is saved to disc.

#### To cancel the save

Press the MENU button.

#### To assign a title to a clip list

Use the supplied PDZ-1 Proxy Browsing Software.

For details, see the PDZ-1 online help.

## Managing Clip Lists

After you create or edit a clip list, you can use the CLIP menu to save it to disc, load it from disc into unit memory, and delete it from the disc.

### Displaying the CLIP menu

Hold down the SHIFT button and press the SUB CLIP button.

In the thumbnail list screen and the clip list screen, you can display the CLIP menu by pressing the MENU button.

The CLIP menu items you can display and select vary with the operating state of the unit (see the following table).

Item	Operation (reference page)
CLIP INFORMATION	Select the information displayed beneath thumbnails (see page 72)
LOAD CLIP LIST	Load a clip list from the disc into the current clip list (see page 72)
SAVE CLIP LIST	Save the current clip list to disc (see page 70)
DELETE CLIP LIST	Delete a clip list from the disc (see page 72)
SORT CLIP LISTS BY	You can sort the clip lists by name or date and time of creation (see page 72).
SET INDEX PICTURE <sup>a)</sup>	Change the thumbnail image (index picture) of a clip (see page 50)
ADD <sup>a)</sup>	Add sub clips to the current clip list (see page 62)
MOVE <sup>b)</sup>	Reorder sub clips (see page 67)
TRIM <sup>b)</sup>	Change the In point or Out point of a sub clip (see page 68)
DELETE <sup>b)</sup>	Delete unnecessary sub clips (see page 69)
TC PRESET <sup>b)</sup>	Change the start timecode for the current clip list to a desired value (see page 69)
DELETE CLIP	Delete a clip
LOCK/UNLOCK CLIP	Lock or unlock a clip
LOCK OR DELETE ALL CLIPS	Lock or delete all clips
DELETE SHOT MARK	Delete a shot mark

a) Displayed only in operating thumbnail list screen

b) Displayed only in operating the clip list screen

### To clear the CLIP menu from the screen

Press the MENU button (or hold down the SHIFT button and press the SUB CLIP button).

## Note

The CLIP menu can handle up to 99 clip lists.

## Changing Displayed Items of Information on Sub Clips

You can change information displayed in the lower portion of each thumbnail in the clip list window.

Proceed as follows.

- 1 Display the CLIP menu.

See “*Displaying the CLIP menu*” (page 71).

- 2 Use the **↑**/MARK1 or **↓**/MARK2 button to select “CLIP INFORMATION”, and then press the SET button.

A screen appears allowing you to select information items to display.

- 3 Use the **↑**/MARK1 or **↓**/MARK2 button to select the items you want to display, and then press the SET button.

**DATE:** Date and time of creation

**TIME CODE:** Timecode of the start of the sub clip

**DURATION:** Playback time

**SEQUENCE NUMBER:** Thumbnail sequence number

See “*Assigning Sequence Numbers to Thumbnails*” (page 56) for more information about sequence thumbnail numbers.

When the clip list window is displayed, the information of the selected items appears in the lower portion of each thumbnail.

## Loading a Clip List From a Disc Into the Current Clip List

Before you can play back or edit a clip list, you need to load it from the disc into the current clip list.

Proceed as follows.

- 1 Display the CLIP menu.

See “*Displaying the CLIP menu*” (page 71).

- 2 Use the **↑**/MARK1 or **↓**/MARK2 button to select “LOAD CLIP LIST”, and then press the SET button.

A list of clip lists appears (see page 63).

- 3 Use the **↑**/MARK1 or **↓**/MARK2 button to select the desired clip list, and then press the SET button.

The selected clip list is loaded into the unit as the current clip list.

## To display thumbnails of the loaded current clip list

Press the THUMBNAIL button and SUB CLIP button, turning them on.

## If an unsaved clip list exists in current clip list memory

A warning message like the following appears.

“CLIP LIST IS NOT SAVED. OVERWRITE CLIP LIST?”

Press the **←**/IN button or **→**/OUT button to select “OK” (overwrite) or “CANCEL” (do not overwrite), and then press the SET button.

## Deleting Clip Lists From a Disc

Proceed as follows.

- 1 Display the CLIP menu (see page 72).

- 2 Use the **↑**/MARK1 or **↓**/MARK2 button to select “DELETE CLIP LIST”, and then press the SET button.

A list of clip lists appears (see page 63).

- 3 Use the **↑**/MARK1 or **↓**/MARK2 button to select a clip list to delete, and then press the SET button.

A deletion confirmation screen appears.

- 4 Press the **←**/IN button or the **→**/OUT button to select OK, and then press the SET button.

## To cancel the clip list deletion

Press the RESET button.

The selected clip list is deleted from the disc.

## To continue deleting other clip lists

After selecting “OK”, press the SET button while holding down the SHIFT button. The selected clip list is deleted, and you return to step 3 and can continue deleting clip lists.

## Sorting Clip Lists

Proceed as follows to sort the list of existing clip lists by clip list name or by date of creation.

- 1 Display the CLIP menu.



See "Displaying the CLIP menu" (page 71).

You can jump to the first clip or last clip by pressing the PREV or NEXT button with the SHIFT button held down.

- 2 Use the **↑**/MARK1 or **↓**/MARK2 button to select "SORT CLIP LISTS BY...", and then press the SET button.

A screen like the one shown below appears.

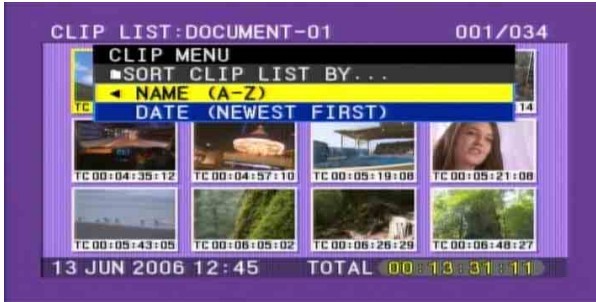

- 3 Use the **↑**/MARK1 or **↓**/MARK2 button to select the type of sorting.

**NAME:** Sort in ascending order by clip list name.

**DATE:** Sort by date of creation, with the newest clip list first.

- 4 Press the **←**/IN button.

Sorting starts on LOAD CLIP LIST screen and so on. Unused clip lists are excluded from the sort.

If you selected "NAME":

BY NAME: Indicates sorting by name

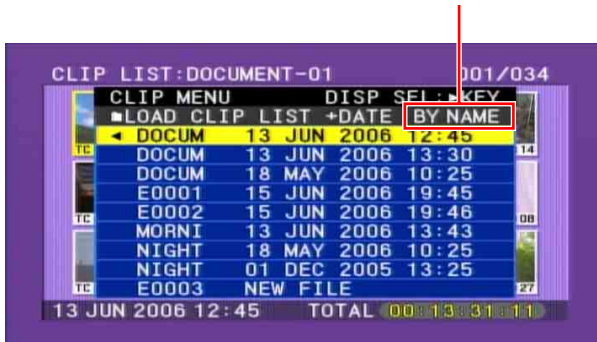

If you selected "DATE":

BY DATE: Indicates sorting by date

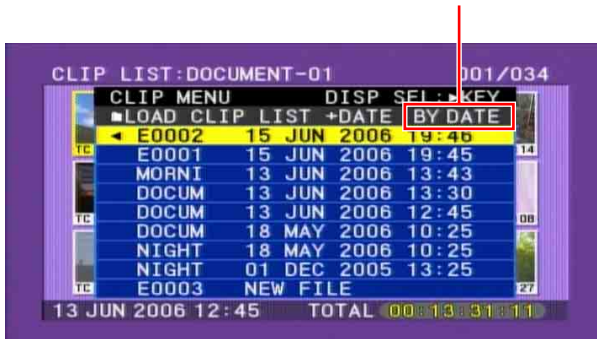

---

# Using the PDZ-1 Proxy Browsing Software

When a computer with the PDZ-1 Proxy Browsing Software installed is connected to this unit, you can transfer the proxy AV data and metadata files recorded on a disc to the computer. On the computer side, PDZ-1 enables you to browse the proxy AV data, add or modify metadata (titles, comments, essence marks, etc.), or create a clip list.

The modified metadata and the created clip list can then be written back to the disc loaded in this unit.

## System requirements to use the PDZ-1

The following are required to use PDZ-1.

- Computer: PC with Intel Pentium III CPU, at least 1 GHz (installed memory: at least 512 MB)
- Operating system: Microsoft Windows 2000 Service Pack 4 or higher, or Microsoft Windows XP Professional Service Pack 1 or higher
- Web browser: Internet Explorer 6.0 Service Pack 1 or higher
- DirectX: DirectX 8.1b or higher

## To install PDZ-1

Insert the supplied CD-ROM (PDZ-1 Proxy Browsing Software) in the CD-ROM drive of the computer and execute the Setup.exe file, then follow the installation instructions.

*For details, refer to the ReadMe file on the CD-ROM.*

### Note

Make sure that the work folder to store the material transferred from this unit is on a hard disk drive with adequate free space. The amount of proxy AV data transferred is up to 2.8 GB per disc (when recording in the LP format).

*For details, see “File Operations in File Access Mode” (page 78).*

## Overview

A remote computer can be connected to this unit and used to operate on recorded data which has been saved in data files, such as video and audio data files. Use FAM (file access mode) for the computer connection.

## Directory Structure

The following figure shows the directory structure of discs visible to a remote computer.

### Note

This structure is not the same as the actual structure recorded on the disc.

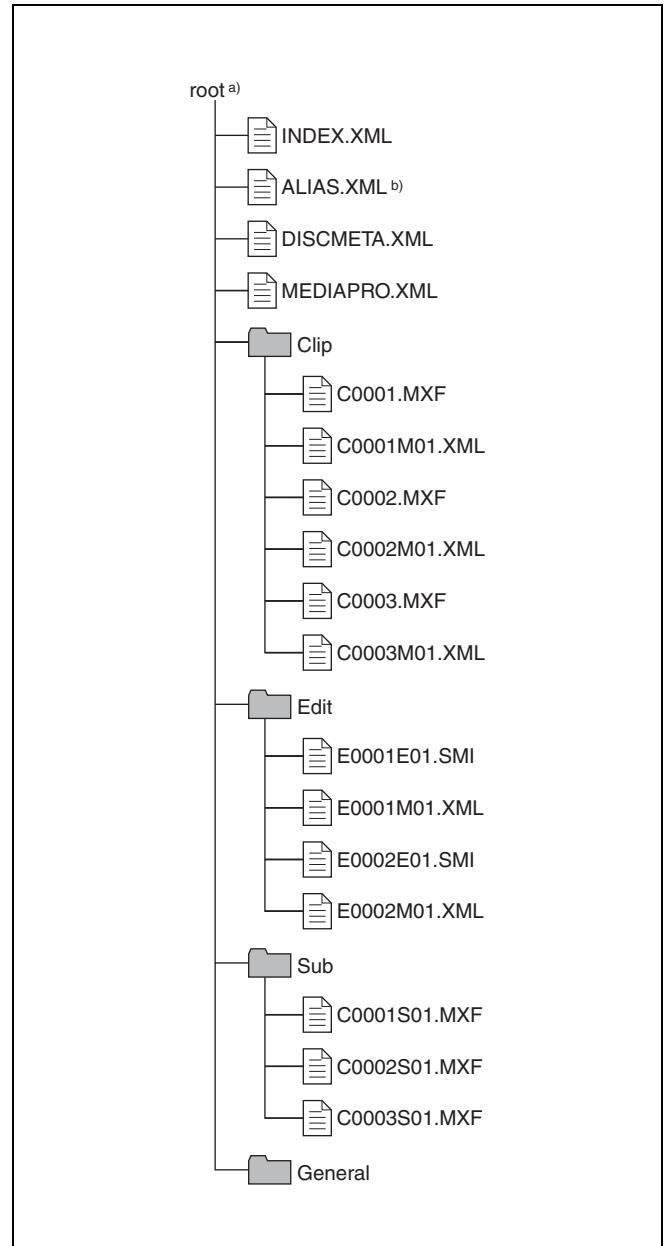

a) Root directory

b) Only when sub item "NAMING FORM" on the SETUP  
>OPERATIONAL FUNCTION >FILE NAMING page is set to "free"

## File Operation Restrictions

This section explains which operations are possible on files stored in each directory.

When required, the following operation tables distinguish reading and writing from partial reading and writing.

**Read:** Read data sequentially from the start to the end of the file.

**Partial read:** Read only a part of the data in the file.

**Write:** Write data sequentially from the start to the end of the file.

**Partial write:** Write data to a part of the file only.

### Root directory

File name	Content	Operations				
		Read/Partial read	Write/Partial write	Rename	Create	Delete
INDEX.XML	Contains data for management of the material on the disc.	Yes	No	No	No	No
ALIAS.XML <sup>a)</sup>	Contains conversion tables for assigning user-defined names to clips and clip lists.	Yes	No	No	No	No
DISCMETA.XML	Contains metadata to indicate the disc properties.	Yes	Yes <sup>b)</sup>	No	No	No
MEDIAPRO.XML	Contains a list of material on the disc, basic properties, related information, and information about access methods.	Yes	No	No	No	No
Other files	Files other than the above	–	No	–	No	–

a) Only when sub item “NAMING FORM” on the SETUP >OPERATIONAL FUNCTION >FILE NAMING page is set to “free”

b) Only files which can be written by XDCAM

#### Notes

- Directories cannot be created in the root directory.
- The directories in the root directory (Clip, Edit, Sub, and General) cannot be deleted or renamed.

### Clip directory

File name	Content	Operations				
		Read/Partial read	Write/Partial write	Rename	Create	Delete
C*.MXF <sup>a)</sup>	Clip file created by recording (MXF file) *: 0001 to 9999	Yes	No	No <sup>b)</sup>	Yes <sup>c)</sup>	Yes <sup>d)</sup>
C*M01.XML <sup>a)</sup>	Metadata file generated automatically when C*.MXF file is created. *: 0001 to 9999	Yes	Yes <sup>e)</sup>	No <sup>f)</sup>	No <sup>g)</sup>	No <sup>h)</sup>
Other files	Files other than the above	–	No	–	No	–

a) With firmware version 1.5 and higher, the unit can handle files with user-defined names in the “C\*” part.

b) Possible with firmware version 1.5 and higher.

c) Only files which are 2 seconds or longer in length, in a format matching the format (system frequency) and recording format (MPEG HD/DVCAM and number of audio channels) of the recorded sections of the disc, and which can be overwritten by XDCAM.

d) Only when the Write Inhibit tab on the disc is set to enable recording and “REC INH” is set to “OFF”. With firmware version 1.1 and lower, only the most recently recorded clip may be deleted. With firmware version 1.5 and higher, any clip may be selected and deleted.

e) Only files which can be written by XDCAM

f) With firmware version 1.5 and higher, when the “C\*” part of a C\*.MXF file name is changed, a C\*M01.XML file with the same name in the “C\*” part is also changed automatically.

g) When a C\*.MXF file is created, a C\*M01.XML file with the same name in the “C\*” part is created automatically.

h) When a C\*.MXF file is deleted, the C\*M01.XML file with the same name in the “C\*” part is also deleted automatically.

**Notes**

- Directories cannot be created in the Clip directory.
- When the following operations, supported by version 1.5 and higher XDCAM devices, are carried out on a disc, then it becomes impossible for version 1.4 and lower XDCAM devices to record new clips or delete existing clips on that disc. (The only possible operations are playback and disc formatting.)
  - Writing of clips with user-defined names
  - Deletion of clips (except the last recorded clip)
  - Locking of clips
- If you attempt to write a C\*.MXF file which does not meet the conditions specified as remark d) on this table via a FAM connection, a Windows error message appears to the effect that the file or directory is corrupt and cannot be read.

**Edit directory**

File name	Content	Operations				
		Read/Partial read	Write/Partial write	Rename	Create	Delete
E*E01.SMI <sup>a)</sup>	Clip list file *: 0001 to 0099	Yes	Yes <sup>b)</sup>	No <sup>c)</sup>	Yes <sup>d)</sup>	Yes <sup>e)</sup>
E*M01.XML <sup>a)</sup>	Metadata file generated automatically when E*E01.SMI file is created. *: 0001 to 0099	Yes	Yes <sup>b)</sup>	No <sup>f)</sup>	No <sup>g)</sup>	No <sup>h)</sup>
Other files	Files other than the above	–	No	–	No	–

- a) With firmware version 1.5 and higher, the “E\*” part can be changed to a user-defined name.
- b) Only files which can be written by XDCAM. Partial writing is not possible.
- c) Possible with firmware version 1.5 and higher.
- d) Only files which can be written by XDCAM
- e) Only when the Write Inhibit tab on the disc is set to enable recording and “REC INH” is set to “OFF”.
- f) With firmware version 1.5 and higher, when the “E\*” part of a \*E01.SMI is changed, an E\*M01.XML file with the same name in the “E\*” part is also changed automatically.

g) When an E\*E01.SMI file is created, an E\*M01.XML file with the same name in the “E\*” part is also generated automatically.

h) When an E\*E01.SMI file is deleted, an E\*M01.XML file with the same name in the “E\*” part is also deleted automatically.

**Note**

Directories cannot be created in the Edit directory.

**Sub directory**

File name	Content	Operations				
		Read/Partial read	Write/Partial write	Rename	Create	Delete
C*S01.MXF <sup>a)</sup>	Proxy AV data (MXF) file generated automatically when a C*.MXF file is created. *: 0001 to 4999	Yes	No	No <sup>b)</sup>	No <sup>c)</sup>	No <sup>d)</sup>
Other files	Files other than the above	–	No	–	No	–

- a) With firmware version 1.5 and higher, the “C\*” part can be changed to a user-defined name.
- b) With firmware version 1.5 and higher, when the “C\*” part of a C\*.MXF file name is changed, a C\*S01.MXF file with the same name in the “C\*” part is generated automatically.
- c) When a C\*.MXF file is created, a C\*S01.XML file with the same name in the “C\*” part is generated automatically.

d) When a C\*.MXF file is deleted, the C\*S01.XML file with the same name in the “C\*” part is also deleted automatically.

**Note**

Directories cannot be created in the Sub directory.

**General directory**

File name	Content	Operations				
		Read/Partial read	Write/Partial write	Rename	Create	Delete
Any file		Yes	Yes	Yes <sup>a)</sup>	Yes	Yes <sup>b)</sup>

- a) UTF-8 file names can be up to 63 bytes in length. (Depending on the character type, file names (including extension) may be limited to 21 characters.)
- b) Only when the Write Inhibit tab on the disc is set to enable recording and "REC INH" is set to "OFF".

The following directory operations are possible in the General directory.

- Directory creation (up to 64 levels, including the General directory)
- Deletion and renaming of directories

### Notes

- The maximum number of files that can be created on one disc, including directories, is 5,000.
- File names and directory names can use letters, numbers, and symbols from the Unicode 2.0 (UTF-8) character set.

However, the following control characters and symbols <sup>1)</sup> cannot be used.

- Control characters: U+0000 to U+001F, U+007F
- Symbols: ", \*, /, :, <, >, ?, \, |

1) This is supported from firmware version 1.4. However, the following character codes cannot be used by FAM connections. U+010000, U+020000, U+030000, U+040000, U+050000, U+060000, U+070000, U+080000, U+090000, U+0A0000, U+0B0000, U+0C0000, U+0D0000, U+0E0000, U+0F0000, U+100000

# File Operations in File Access Mode

## File access mode operating environment

Operating system requirements for file operations by file access mode are as follows.

- **Computer operating system:** Microsoft Windows 2000 Service Pack 4 or higher, or Microsoft Windows XP

## Preparations

Do the following on the remote computer and this unit.

- Install the FAM driver on the remote computer (*see the next item*).
- In the setup menu, set INTERFACE SELECT >i.LINK MODE to "FAM (PC REMOTE)" (*see page 94*).

### To install the FAM driver

Insert the supplied CD-ROM (PDZ-1 Proxy Browsing Software) in the CD-ROM drive of the computer and execute the Setup.exe file, then follow the installation instructions.

*For details, refer to the ReadMe file contained on the CD-ROM disc.*

## Making FAM Connections

Proceed as follows.

- 1** If there is a disc loaded in this unit, put the unit into the following state.
  - Recording, playback, search and other disc operations: Stopped
  - THUMBNAIL button (*see page 13*): Off
  - Disc access by DELETE LAST CLIP, DELETE ALL CLIPS, QUICK FORMAT in the DISC menu, and so on: Stopped
  - MENU button: OFF
  - Unsaved current clip list: Save or clear
- 2** Connect the **i** S400 connector on this unit to the i.LINK (IEEE1394) connector on the remote computer, using an i.LINK cable.

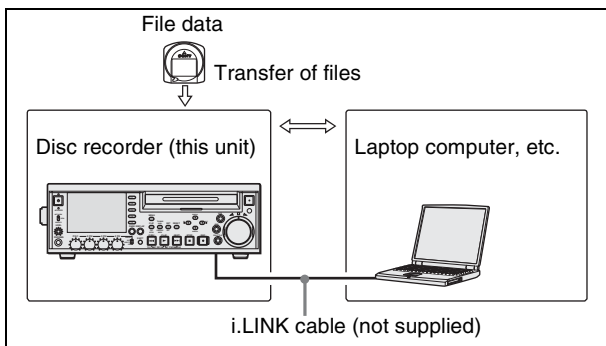

Windows recognizes this unit as a removable disc, and displays one of the following icons on the remote computer's task bar:

- **Windows 2000:**
- **Windows XP:**

The remote computer is now able to perform file operations when a disc is inserted into this unit.

### Operation limitations during FAM connections

- With the exception of the EJECT button, recording buttons and playback control buttons are disabled.
- This unit cannot be controlled from any device connected to an external device connector.
- There is no signal output from this unit, and the message "PC REMOTE!" appears in the display of this unit and on the external monitor.

## Operating on Files

Proceed as follows.

### 1 Start Explorer.

Check that a drive letter has been assigned to this unit. (The drive letter will differ depending on the number of other peripherals connected to the remote computer.)

### 2 Use Explorer to perform file operations on the disc loaded in this unit.

You can operate in the same way that you operate on local drives and files on network computers.

#### Notes

- If you power this unit off during an FAM connection, the data transferred thus far is discarded.
- All file operations are not possible for some types of files.

For details, see "File Operation Restrictions" (page 76).

### To eject discs from a remote computer

Right click the icon representing this unit in Explorer, and select "Eject" from the menu which appears.

### To exit file operations

Proceed as follows.

#### Note

Do not disconnect the cable before performing steps 1 to 3.

### 1 Do one of the following on the or icon displayed in the remote computer's taskbar.

- Double click.
- Right click, and select one of the following commands from the menu which appears.  
**Windows 2000:** Unplug or eject hardware  
**Windows XP:** Safely Remove Hardware

The "Unplug or Eject Hardware" dialog box (Windows 2000) or the "Safety Remove Hardware" dialog box (Windows XP) appears.

### 2 Select "Sony XDCAM PDW-F70 IEEE 1394 SBP2 Device" and click "Stop".

The "Stop a Hardware device" dialog appears.

### 3 Select "Sony XDCAM PDW-F70 IEEE 1394 SBP2 Device" and click "OK".

In Windows 2000, a confirmation message appears. In Windows XP, "Sony XDCAM PDW-F70 IEEE 1394 SBP2 Device" is deleted from the list of "hardware devices".

This unit can now resume normal operations. (The limitations described in "Operation limitations during FAM connections" (see page 79) no longer apply.)

### 4 Disconnect the i.LINK cable as required.

### To make a reconnection

To reconnect after exiting file operations, do one of the following, depending on whether an i.LINK cable is connected.

**i.LINK cable is not connected:** Connect this unit and a remote computer with an i.LINK cable.

**i.LINK cable is connected:** Disconnect the i.LINK cable from either this unit or the remote computer, wait for at least 10 seconds, and then reconnect the disconnected cable.

**The unit is powered off and an i.LINK cable is connected:** Power the unit on.

## To disable FAM connections

Execute one of the procedures described in the previous section “To make a reconnection” to make a FAM connection between this unit and the remote computer. To disable FAM connections, in the setup menu, set INTERFACE SELECT >i.LINK MODE to “AV/C” (*see page 94*).



## Function Menu

The function menu provides access to frequently used settings, such as input video signal selection and timecode settings.

Menu settings are stored in nonvolatile memory and are preserved even after the unit is powered off.

### Function Menu Operations

The function menu appears on the LCD panel of this unit. The following figure shows the buttons used in function menu operations.

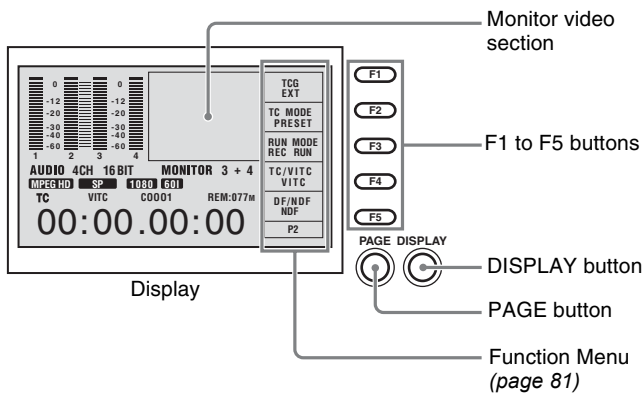

### To display the function menu

The function menu is made up of the HOME page and pages P1 and P2.

If the function menu is not already visible, press the PAGE button to display it. The most recently accessed function menu page appears.

The size of the monitor video section changes to the smallest size when the function menu appears.

### To display a different page

Each press of the PAGE button displays the next function menu page in the order HOME → P1 → P2 → HOME...

### To clear the function menu from the screen

Press the DISPLAY button. The size of the monitor video section increases.

### To change the setting of a function menu item

Use the F1 to F5 buttons.

Press the button to the right of each setting item to change the value of the item. Keep pressing the button until the value you want appears.

### Function Menu Settings

The following tables list the setting items on each page and describe their setting values.

#### HOME page

Setting item	Description
<b>F1: V INPUT</b> (video input)	Selects the video input signal. <b>HDSDI:</b> HDSDI signal <b>SG:</b> Test signal from the internal signal generator
<b>F2: A1 INPUT</b> (audio input 1)	Selects the audio input signals assigned to audio channels 1 and 3.
<b>F4: A3 INPUT</b> (audio input 3)	<b>HDSDI:</b> Audio signal multiplexed into HDSDI signal <sup>1)</sup> <b>ANALOG1:</b> Analog 1 audio signal <b>AES/EBU:</b> Signals input to DIGITAL AUDIO (AES/EBU) INPUT 1/2 and 3/4 connectors <b>SG:</b> Test signal from the internal signal generator

Setting item	Description
<b>F3:</b> A2 INPUT (audio input 2) <b>F5:</b> A4 INPUT (audio input 4)	Selects the audio input signals assigned to audio channels 2 and 4. <b>HDSDI:</b> Audio signal multiplexed into HDSDI signal <sup>1)</sup> <b>ANALOG2:</b> Analog 2 audio signal <b>AES/EBU:</b> Signals input to DIGITAL AUDIO (AES/EBU) INPUT 1/2 and 3/4 connectors <b>SG:</b> Test signal from the internal signal generator

1) Only when HDSDI is selected as the video input.

### Note

The signal name display flashes when the selected signal is not being input. Input the selected signal, or select another signal.

## Page P1

Setting item	Description
<b>F1:</b> CNTR SEL (counter selection)	Selects the time data to display in the time data display section. <b>TC:</b> Timecode <b>UB:</b> User bits <b>COUNTER:</b> Elapsed recording or playback time
<b>F2:</b> MONI CH (monitor channel)	Selects the audio channels to monitor. <b>CH 1/2:</b> Channels 1 and 2 <b>CH 3/4:</b> Channels 3 and 4
<b>F3:</b> MONI SEL (monitor selection)	Selects the audio monitor signal output from the AUDIO MONITOR connector and the PHONES jack. <b>STEREO:</b> Assign the channels selected with MONI CH to left and right. <b>MONO L (monaural L channel):</b> Output one of the channels selected with MONI CH. <b>MONO R (monaural R channel):</b> Output one of the channels selected with MONI CH. <b>MIX:</b> Output monaural audio mixed from the channels selected with MONI CH.
<b>F4:</b> REC INH (recording inhibit)	Turns recording inhibit mode on and off. <b>ON:</b> Recording inhibit mode on <b>OFF:</b> Recording inhibit mode off

Setting item	Description
<b>F5:</b> CHAR SEL (Character information display)	Turns the display of character information in the monitor video section of the LCD panel and on an external monitor on and off. <b>ON:</b> Character information on <b>OFF:</b> Character information off <b>LCD:</b> Character information on for the LCD panel only Even when ON is selected, you can forcibly turn off the superimposition of character information in HD output by setting the SETUP MENU >DISPLAY CONTROL >HD CHARA item.

## Page P2

Setting item	Description
<b>F1:</b> TCG (timecode generator)	Sets the operation of the internal timecode generator. <b>INT (internal):</b> The count value advances from a preset initial value, or advances consecutively from the timecode of the last frame recorded on the disc. <b>EXT (external):</b> Synchronize to the timecode input to the TIME CODE IN connector. <b>SDI:</b> Synchronize to the timecode of the signal input to the HDSDI connector.

Setting item	Description
<b>F2:</b> TC MODE (timecode mode)	<p><b>When TCG is set to “INT”</b> Selects whether the count value advances from a preset initial value, or advances consecutively from the timecode of the last frame recorded on the disc. <b>PRESET:</b> Advance from a preset initial value. <b>REGEN (regenerate):</b> Advance consecutively from the timecode of the last frame recorded on the disc.</p> <p><b>When TCG is set to “EXT”</b> Selects whether to record timecode synchronized to external timecode from a preset initial value, or record the external timecode itself. <b>PRESET:</b> Record external timecode. <b>REGEN (regenerate):</b> Record timecode synchronized to external timecode from a preset initial value.</p> <p><b>Note</b> When TCG is set to “SDI”, the external timecode itself is always recorded.</p>
<b>F3:</b> RUN MODE	<p>When TCG is set to “INT”, and TC MODE is set to “PRESET”, selects the run mode of the internal timecode generator. <b>REC RUN:</b> The timecode generator runs only during recording. <b>FREE RUN:</b> The timecode generator runs as long as the unit is powered on.</p>
<b>F4:</b> TC/VITC	Selects the type of timecode display in the time data display section (TC or VITC).
<b>F5:</b> DF/NDF (only when the system frequency is 60I/30P/24P (pulldown))	Use this item to select drop-frame mode (DF) or non-drop-frame mode (NDF).

## System Menu

Use the system menu to set up the unit for specific purposes and conditions. Menu settings are stored in nonvolatile memory and are preserved even after the unit is powered off.

The system menu is made up of the following five menus.

- Setup menu (SETUP MENU)
- TC preset menu (TC PRESET)
- Disc menu (DISC MENU)
- Date and time preset menu (DATE/TIME PRESET)
- Digital time display menu (HOURS METER)

This section explains the setup menu and the disc menu.

*See page 44 “To record timecode after setting an initial value (Internal Preset)” in Chapter 3 for more information about the TC preset menu.*

*See page 31 “Setting the Date and Time” in Chapter 2 for more information about the date and time preset menu.*

*See page 106 “Periodic Maintenance” in the appendixes for more information about the digital time display menu.*

## Displaying the Setup and Disc Menus

Menus appear in the monitor video section and in the time data display section. If you have connected an external monitor, they are also superimposed over the picture shown on that monitor.

- 1 Press the MENU button.

The system menu appears.

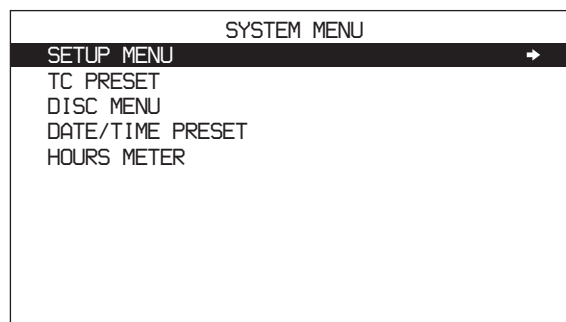

The entire system menu appears in the monitor video section and on the external monitor.

An uppercase and lowercase abbreviation of the selected line only (the line in reverse video) appears in the time data display section.

2 Press the **↑**/MARK1 or **↓**/MARK2 button to select SETUP MENU or DISC MENU.

3 Press the **→**/OUT button.

The setup menu (see page 86) or the disc menu (see page 98) appears.

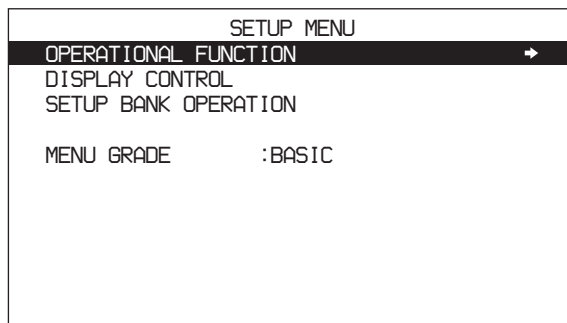

---

## Setup Menu

As shown in the following figure, the setup menu has three levels.

The top level shows a general classification of the setting items in the menu. Except for MENU GRADE, the actual setting items are found on the second or third level.

Setting items are divided into basic items, which are needed for normal operations, and enhanced items, which are needed for enhanced operations. In the figures, basic items are shown in bold characters.

When the unit is shipped from the factory, the setup menu is configured to display basic items only. To display enhanced items as well, change the setting of the MENU GRADE item.

*For details, see “Displaying enhanced items” on page 97.*

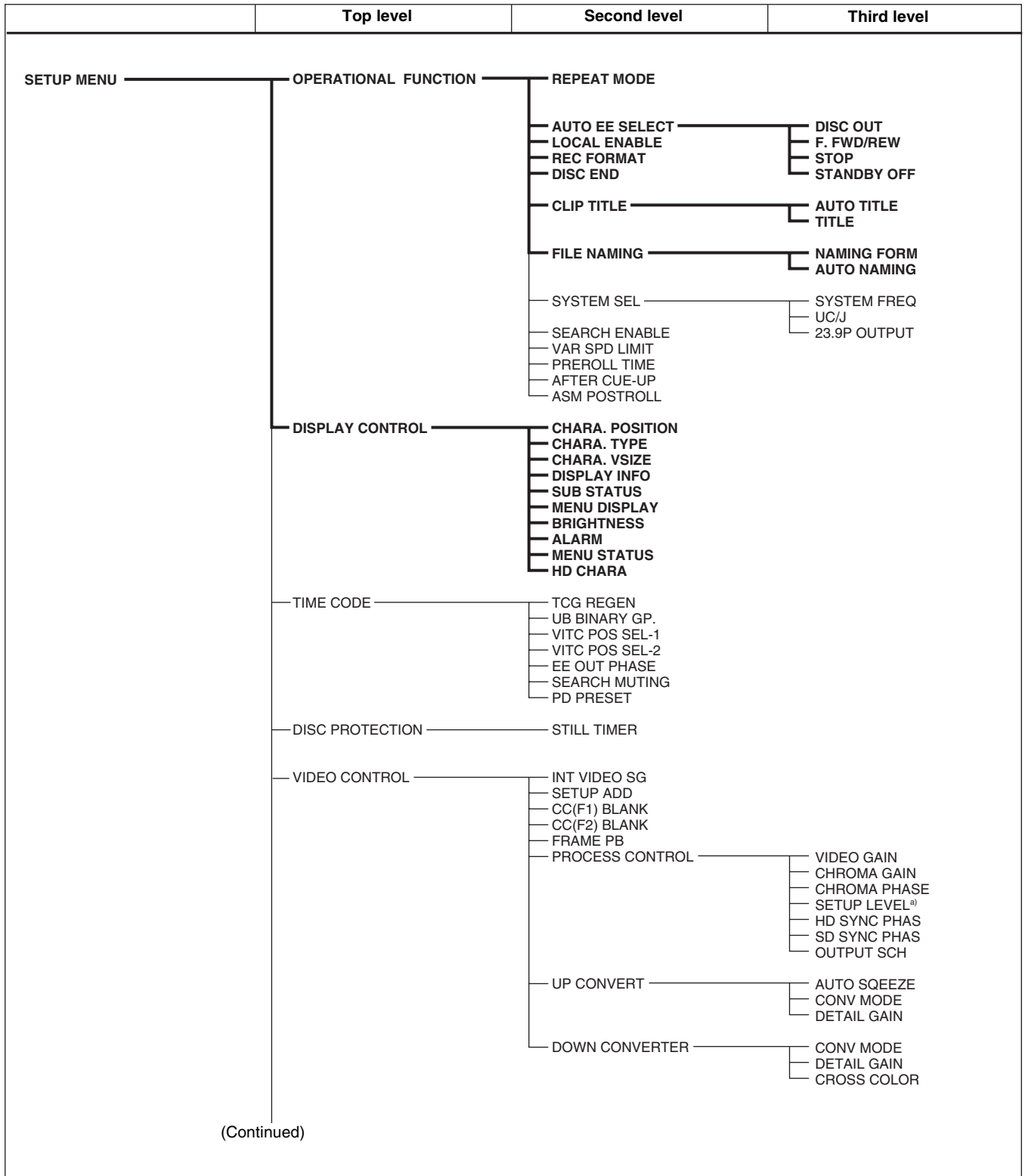

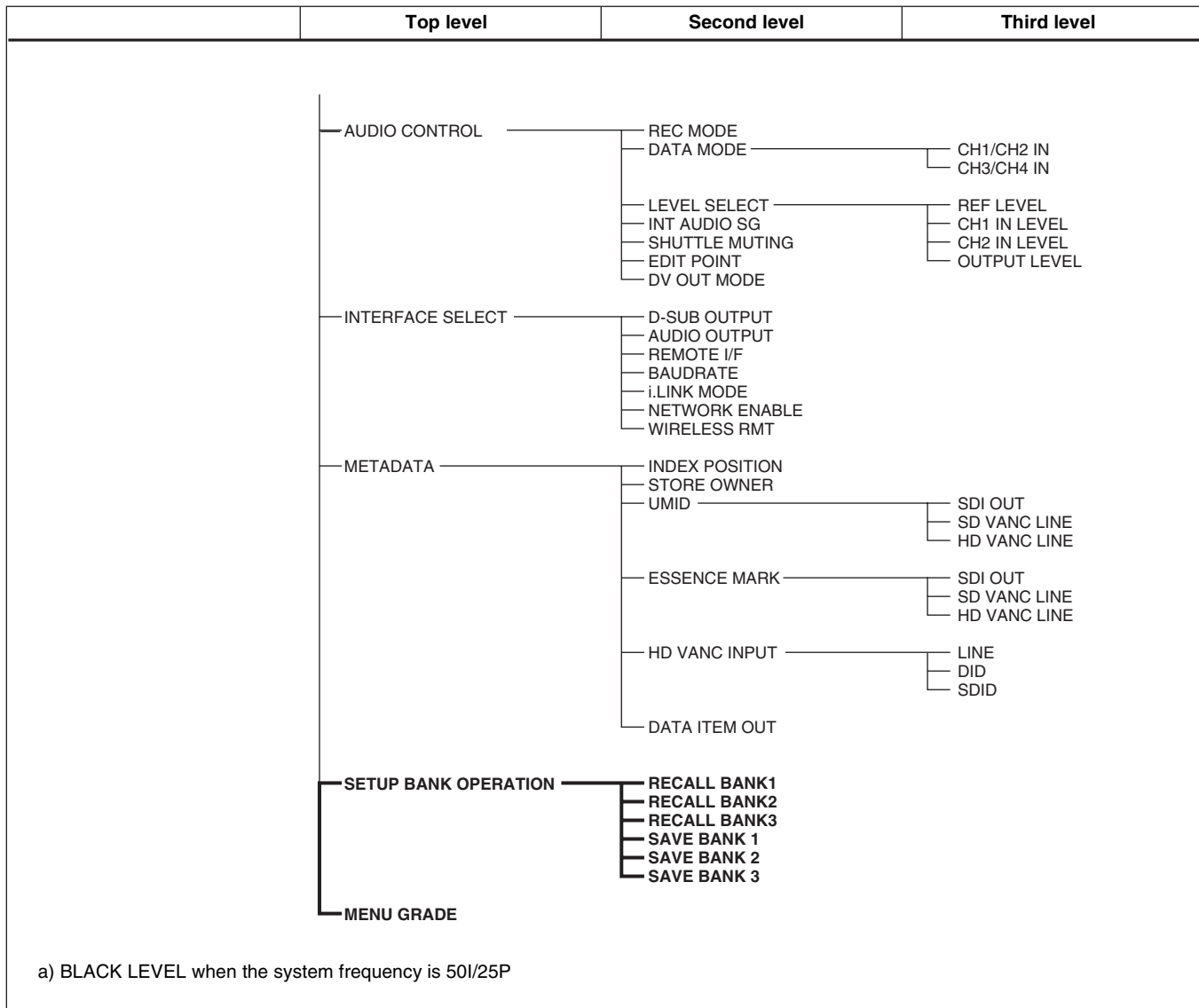

## Setup Menu Items

The purpose and settings of the setup menu items are described below.

- Brackets [ ] indicate characters and symbols that appear in the time data display section.

- An asterisk (\*) (for example \*EE) indicates that a setting is the factory default.

OPERATIONAL FUNCTION [Operational]: Operation settings	Description
<b>REPEAT MODE</b> [> REPEAT]: Determine whether or not to put the unit into repeat playback mode.	<b>*OFF</b> [>> OFF]: Do not put the unit into repeat playback mode. <b>ON</b> [>> ON]: Put the unit into repeat playback mode.

OPERATIONAL FUNCTION [Operational]: Operation settings		Description
<b>AUTO EE SELECT</b> [> <b>Auto EE</b> ]: Determine whether the unit enters E-E mode or PB mode when audio and video signals from other equipment are input.	<b>DISC OUT</b> [>> <b>DISC OUT</b> ]: When no disc is loaded.	* <b>EE</b> [>>> <b>EE</b> ]: Output video and audio signals received from other equipment. <b>PB</b> [>>> <b>PB</b> ]: Suppress video and audio signals.
	<b>F.FWD/REV</b> [>> <b>F.FWD/REV</b> ]: Operations when in fast forward or rewind mode	<b>EE</b> [>>> <b>EE</b> ]: Output video and audio signals received from other equipment. * <b>PB</b> [>>> <b>PB</b> ]: Output playback video. Suppress audio signals.
	<b>STOP</b> [>> <b>STOP</b> ]: Operations when in stop mode	<b>EE</b> [>>> <b>EE</b> ]: Output video and audio signals received from other equipment. * <b>PB</b> [>>> <b>PB</b> ]: Output a still image.
	<b>STANDBY OFF</b> [>> <b>STBY OFF</b> ]: Operations when in standby-off mode	
<b>LOCAL ENABLE</b> [> <b>Local ENA</b> ]: Select the buttons that can be operated on this unit even when the remote control switch is set to REMOTE.	<b>ALL DISABLE</b> [>> <b>All DIS</b> ]: The EJECT button and the buttons in the recording/playback control block cannot be operated. * <b>STOP &amp; EJECT</b> [>> <b>STOP&amp;EJ</b> ]: Only the STOP button and EJECT button can be operated. <b>ALL ENABLE</b> [>> <b>All ENA</b> ]: The EJECT button and all of the buttons in the recording/playback control block can be operated. The preroll time can be set and time data can be selected on this unit.	
<b>REC FORMAT</b> [> <b>REC format</b> ]: Select the recording format (MPEG-2 compression rate).	<b>HQ</b> [>> <b>HQ</b> ]: 35Mbps * <b>SP</b> [>> <b>SP</b> ]: 25Mbps <b>LP</b> [>> <b>LP</b> ]: 18Mbps	
<b>DISC END</b> [> <b>Disc End</b> ]: Select what the unit should do when the free disc capacity is exhausted during recording.	<b>GOTO TOP</b> [>> <b>GOTO TOP</b> ]: Move to the top of the disc. <b>END STOP</b> [>> <b>END STOP</b> ]: Stop at the end of the disc. * <b>EJECT</b> [>> <b>EJECT</b> ]: Eject the disc automatically.	
<b>CLIP TITLE</b> [> <b>Clip Title</b> ]: Specify how to assign clip titles.	<b>AUTO TITLE</b> [>> <b>AT Title</b> ]: Select whether to assign clip titles automatically.	* <b>DISABLE</b> [>>> <b>DISABLE</b> ]: Do not assign. <b>ENABLE</b> [>>> <b>ENABLE</b> ]: Assign.
	<b>TITLE</b> [>> <b>Title</b> ]: Assign arbitrary titles.	The CLIP AUTO TITLING screen appears. <i>For details, see "To assign clip titles" (page 60) in Chapter 4.</i>
<b>FILE NAMING</b> [> <b>File Name</b> ]: Specify the clip and clip list name format	<b>NAMING FORM</b> [>> <b>Name Form</b> ]: Specify the clip and clip list name format.	* <b>C****</b> [>>> <b>C****</b> ]: Standard format <b>free</b> [>>> <b>free</b> ]: Enable free format.
	<b>AUTO NAMING</b> [>> <b>AT Naming</b> ]: Specify the format of the file names generated when clips are recorded.	* <b>C****</b> [>>> <b>C****</b> ]: Standard format <b>title</b> [>>> <b>title</b> ]: Assign the same name as clip title.
<b>SYSTEM SEL</b> [> <b>System Sel</b> ]: Select the system frequency and area of use.  <b>Note</b> After changing any of the sub-items, press the on/standby switch to power the unit off (put it into standby), and then press it again to power the unit on. The initial settings of the setup menu as a whole will change to reflect the settings made here.	<b>SYSTEM FREQ</b> [>> <b>Sys Freq</b> ]: Select the system frequency.	* <b>60I</b> [>>> <b>60i</b> ]: 59.94i <b>50I</b> [>>> <b>50i</b> ]: 50i <b>30P</b> [>>> <b>30P</b> ]: 29.97P <b>25P</b> [>>> <b>25P</b> ]: 25P <b>23.98P</b> [>>> <b>23.98P</b> ]: 23.98P
	<b>UC/J</b> [>> <b>UC/J</b> ]: Select the area of use.	<b>UC</b> [>>> <b>UC</b> ]: For areas outside Japan * <b>J</b> [>>> <b>J</b> ]: For Japan
	<b>23.9P OUTPUT</b> [>> <b>23.9P out</b> ]: Select the monitor output when the SYSTEM FREQ is "23.98P".	* <b>23.98PsF</b> [>>> <b>23.9PsF</b> ]: Output as 23.98P. <b>2-3 PULL DOWN</b> [>>> <b>2-3PD</b> ]: Output after pulldown conversion to 59.94i.

OPERATIONAL FUNCTION [Operational]: Operation settings	Description
<b>SEARCH ENABLE</b> [> Search ENA]: Specify how to put the unit into a search mode (jog, shuttle, or variable-speed).	<p><b>*DIAL DIRECT</b> [&gt;&gt; DIAL]: The unit switches to a search mode when you press the JOG, SHUTTLE, or VAR button, or when you turn the jog or shuttle dial (except during recording).</p> <p><b>VIA SEARCH KEY</b> [&gt;&gt; via KEY]: The unit switches to a search mode when you press the JOG, SHUTTLE, or VAR button.</p>
<b>VAR SPD LIMIT</b> [> VAR limit]: Specify whether to limit the speed of variable speed playback	<p><b>*OFF</b> [&gt;&gt; OFF]: -1 to +2 times normal speed</p> <p><b>ON</b> [&gt;&gt; ON]: 0 to +1 times normal speed</p>
<b>PREROLL TIME</b> [> Preroll]: Set the preroll time.	<p><b>15 SEC</b> [&gt;&gt; 15 sec] to <b>0 SEC</b> [&gt;&gt; 0 sec]: The preroll time can be set in one-second increments to between 0 and 15 seconds.</p> <p><b>Factory default setting:</b> 5 SEC [&gt;&gt; 5 sec]</p> <p>A preroll time of at least 5 seconds is recommended when using this unit for editing. When an editing control unit such as the BVE-700A has been connected, this setting is disabled and the setting on the editing control unit is in effect. Operations such as preroll time setting and time data switching are also performed on the editing control unit.</p>
<b>AFTER CUE-UP</b> [> After CUE]: Select the operating mode following cue-up.	<p><b>*STOP</b> [&gt;&gt; STOP]: Stop mode</p> <p><b>STILL</b> [&gt;&gt; STILL]: Output still pictures in search mode.</p>
<b>ASM POSTROLL</b> [> Postroll]: Specify whether to record postroll when executing assemble editing	<p><b>OFF</b> [&gt;&gt; OFF]: Do not record postroll.</p> <p><b>*ON</b> [&gt;&gt; ON]: Record postroll.</p>

DISPLAY CONTROL [Display]: Settings related to display on the LCD panel of this unit and on an external monitor	Description
<b>CHARA. POSITION</b> [> Chara pos]: Specify the position where characters appear in the monitor video section and on external monitors.	<p>Make settings while viewing characters on the CHARA. POSITION (character position) screen.</p> <p><b>To move characters up or down:</b> Press the <b>↑</b>/MARK1 or <b>↓</b>/MARK2 button.</p> <p><b>To move characters left or right:</b> Press the <b>←</b>/IN or <b>→</b>/OUT button.</p> <p><b>To return to the top level of the setup menu:</b> Press the MENU button.</p>
<b>CHARA. TYPE</b> [> Chara type]: Select the type of characters shown in the monitor video section and on an external monitor.	<p>Make settings while viewing characters on the CHARA. TYPE (character type) screen.</p> <p><b>*WHITE (WITH BKGD):</b> White characters on black background</p> <p><b>BLACK (WITH BKGD):</b> Black characters on white background</p> <p><b>WHITE/OUTLINE:</b> White characters with black outline</p> <p><b>BLACK/OUTLINE:</b> Black characters with white outline</p> <p><b>To return to the top level of the setup menu:</b> Press the MENU button.</p>
<b>CHARA. VSIZE</b> [> Chara size]: Specify the vertical size of character information in the monitor video section and on an external monitor.	<p>Specify while viewing the display on the CHARA. VSIZE (character vertical size) screen.</p> <p><b>*x1</b> [&gt;&gt; x1]: Standard size</p> <p><b>x2</b> [&gt;&gt; x2]: 2 times standard size</p> <p><b>To return to the top level of the setup menu:</b> Press the MENU button.</p>





DISPLAY CONTROL [Display]: Settings related to display on the LCD panel of this unit and on an external monitor	Description
<b>DISPLAY INFO [&gt; DISP info]:</b> Select the content of the character information shown in the monitor video section and on an external monitor.	<p><b>*TIME DATA &amp; STATUS [&gt;&gt; Time&amp;STA]:</b> Time data and the operating mode of the unit</p> <p><b>TIME DATA &amp; UB [&gt;&gt; Time&amp;UB]:</b> Time data and user bits data. However, when user bits as time data is selected, user bits data and timecode are both displayed, in that order.</p> <p><b>TIME DATA &amp; CNT [&gt;&gt; Time&amp;CNT]:</b> Time data and elapsed recording or playback time. However, when recording/playback time as time data is selected, recording/playback time and timecode are both displayed, in that order.</p> <p><b>TIME DATA &amp; TIME [&gt;&gt; Time&amp;Time]:</b> Time data and VITC</p> <p><b>TIME DATA &amp; CLIP [&gt;&gt; Time&amp;Clip]:</b> Time data and clip number</p> <p><b>TIME DATA ONLY [&gt;&gt; Time]:</b> Time data only</p> <p>Time data is selected with CNTR SEL on page P1 of the function menu.</p>
<b>SUB STATUS [&gt; Sub status]:</b> Select the supplementary status information shown in the monitor video section and on an external monitor.	<p><b>*OFF [&gt;&gt; OFF]:</b> No supplementary status information</p> <p><b>TC MODE [&gt;&gt; TC mode]:</b> Indications of the operating mode of internal timecode generator</p> <p><b>REMAIN [&gt;&gt; Remain]:</b> Free capacity on the disc (in minute units)</p> <p><b>CLIP NO [&gt;&gt; Clip No]:</b> Clip number</p> <p><b>PLAYBACK REMAIN [&gt;&gt; PB remain]:</b> Time from the current playback position to the recording end position, displayed in time data format</p> <p><i>For details of supplementary status information displayed on the monitor when a setting other than OFF is selected, see "Displaying Supplementary Status Information" (page 38) in Chapter 2.</i></p>
<b>MENU DISPLAY [&gt; Menu DISP]:</b> Select the type of menu characters shown in the monitor video section and on an external monitor.	<p>Select while viewing characters on the MENU DISPLAY screen.</p> <p><b>*WHITE (WITH BKGD):</b> White characters on black background</p> <p><b>BLACK (WITH BKGD):</b> Black characters on white background</p> <p><b>WHITE/OUTLINE:</b> White characters with black outline</p> <p><b>BLACK/OUTLINE:</b> Black characters with white outline</p> <p><b>To return to the top level of the setup menu:</b> Press the MENU button.</p>
<b>BRIGHTNESS [&gt; Brightness]:</b> Adjust the brightness of the display.	<p>The LCD BRIGHTNESS screen appears.</p> <p><b>Factory default setting:</b> *55</p> <p><i>See page 31 "Adjusting the Brightness of the LCD Panel" for more information about how to adjust the brightness.</i></p>
<b>ALARM [&gt; ALARM]:</b> Select whether to display alarm messages.	<p><b>OFF [&gt;&gt; OFF]:</b> In general, do not display alarm messages. However, do display some important alarm messages.</p> <p><b>ON(LIMITED) [&gt;&gt; ON(Limit)]:</b> Display a minimum number of alarm messages.</p> <p><b>*ON [&gt;&gt; ON]:</b> Display all alarm messages.</p>
<b>MENU STATUS [&gt; Menu STAT]:</b> Select whether or not to display menu settings in the monitor video section of the LCD panel and on an external monitor when DISPLAY CONTROL >DISPLAY INFO is set to "TIME DATA & STATUS".	<p><b>*DISABLE [&gt;&gt; DISABLE]:</b> Do not display.</p> <p><b>ENABLE [&gt;&gt; ENABLE]:</b> Display (only when no disc is loaded or during disc insertion/ejection).</p> <p><i>See "Superimposed Text Information" (page 37) in Chapter 2 for the information that is displayed.</i></p>
<b>HD CHARA [&gt; HD cha]:</b> Specify whether, when CHAR SEL on page P1 of the function menu is set to "ON", to forcibly turn off superimposition of text information on HD output.	<p><b>OFF [&gt;&gt; OFF]:</b> Forcibly turn off superimposition of text information.</p> <p><b>*FUNCTION MENU [&gt;&gt; F-MENU]:</b> Do not forcibly turn off superimposition of text information. (The setting of CHAR SEL in the function menu takes priority.)</p>

TIME CODE [Time Code]: Settings related to the timecode generator	Description
<b>TCG REGEN</b> [> <b>TCG regen</b> ]: Select the signals to generate when the timecode generator is set to regenerate mode (TC MODE on page P2 of the function menu is set to "REGEN").	<b>*TC &amp; UB</b> [>> <b>TC &amp; UB</b> ]: Regenerate both timecode signals and user bits signals. <b>TC</b> [>> <b>TC</b> ]: Regenerate timecode signals only. <b>UB</b> [>> <b>UB</b> ]: Regenerate user bits signals only.
<b>UB BINARY GP.</b> [> <b>Binary Gp.</b> ]: Settings related to the user bits binary group flag.  <b>Note</b> When TCG on page P2 of the function menu is set to anything other than "INT", and TC MODE is set to "REGEN", the user bits binary flag setting of external timecode is followed.	<b>*000:NOT SPECIFIED</b> [>> <b>000</b> ]: Character set not specified <b>001:ISO CHARACTER</b> [>> <b>001</b> ]: 8-bit characters conforming to ISO 646 and ISO 2022 <b>010:UNASSIGNED-1</b> [>> <b>010</b> ]: Undefined <b>011:UNASSIGNED-2</b> [>> <b>011</b> ]: Undefined <b>100:UNASSIGNED-3</b> [>> <b>100</b> ]: Undefined <b>101:PAGE/LINE</b> [>> <b>101</b> ]: Multiplex <b>110:UNASSIGNED-4</b> [>> <b>110</b> ]: Undefined <b>111:UNASSIGNED-5</b> [>> <b>111</b> ]: Undefined
<b>VITC POS SEL-1</b> [> <b>VITC pos-1</b> ]: Select a line to insert the VITC in.  <b>Note</b> You can insert the VITC signal in two places. To insert it in two places, set both this item and VITC POS SEL-2.	When the system frequency is 60i, 23.98P or 30P <b>20LINE</b> [>> <b>20 line</b> ] to <b>12LINE</b> [>> <b>12 line</b> ]: Select any line from 12 to 20. <b>Factory default setting:</b> *16 LINE [>> 16 line]  <b>Note</b> When the system frequency is 60i, 23.98P, or 30P, the VIBID (Video Blanking ID) receives priority over a selection of "20LINE".  When the system frequency is 50i or 25P <b>22LINE</b> [>> <b>22 line</b> ] to <b>9LINE</b> [>> <b>9 line</b> ]: Select any line from 9 to 22. <b>Factory default setting:</b> *19 LINE [>> 19 line] (line 19)
<b>VITC POS SEL-2</b> [> <b>VITC pos-2</b> ]: Select a line to insert the VITC in.  <b>Note</b> You can insert the VITC signal in two places. To insert it in two places, set both this item and VITC POS SEL-1.	When the system frequency is 60i, 23.98P or 30P <b>20LINE</b> [>> <b>20 line</b> ] to <b>12LINE</b> [>> <b>12 line</b> ]: Select any line from 12 to 20. <b>Factory default setting:</b> *18 LINE [>> 18 line]  <b>Note</b> When the system frequency is 60i, 23.98P, or 30P, the VIBID (Video Blanking ID) receives priority over a selection of "20LINE".  When the system frequency is 50i or 25P <b>22LINE</b> [>> <b>22 line</b> ] to <b>9LINE</b> [>> <b>9 line</b> ]: Select any line from 9 to 22. <b>Factory default setting:</b> *21 LINE [>> 21 line] (line 21)
<b>EE OUT PHASE</b> [> <b>EE out</b> ]: Determine the output phase for the LTC signal output from the TIME CODE OUT connector when recording timecode and in STOP REC mode (forced E-E mode).	<b>*MUTING</b> [>> <b>muting</b> ]: Suppress the output. <b>THROUGH</b> [>> <b>through</b> ]: Output the timecode input to the TIME CODE IN connector as it is. <b>VIDEO INPUT PHASE</b> [>> <b>V input</b> ]: Output the timecode with the same phase as the input video signal phase. <b>VIDEO OUTPUT PHASE</b> [>> <b>V output</b> ]: Output the timecode with the same phase as the output video signal phase.
<b>SEARCH MUTING</b> [> <b>Srch muting</b> ]: Select whether to suppress the output from the TIME CODE OUT connector in search (jog/shuttle) mode.	<b>OFF</b> [>> <b>OFF</b> ]: Do not suppress. <b>*ON</b> [>> <b>ON</b> ]: Suppress.
<b>PD PRESET</b> [> <b>PD preset</b> ]: Select the timecode to preset. The A-frames of pulldown sequences are preset.	<b>24F TC</b> [>> <b>24F TC</b> ]: Timecode value that becomes the reference for A-frames. <b>30F TC</b> [>> <b>30F TC</b> ]: Pulldown value with respect to the above 24-frame timecode. This appears only when 24P (2-3 pulldown) is selected.

DISC PROTECTION [Disc protct]: Settings related to disc protection	Description
<b>STILL TIMER [ &gt;&gt; STL timer ]:</b> Specify the length of time the unit can be in still image mode before switching to disc protection mode.	<b>0.5SEC [ &gt;&gt;&gt; 0.5 sec ] to 30MIN [ &gt;&gt;&gt; 30 min ]:</b> Select time from 16 settings ranging from 0.5 second to 30 minutes. <b>Factory default setting:</b> *8MIN [ >>> 8 min ] (8 minutes)
VIDEO CONTROL [Video]: Settings related to video control	Description
<b>INT VIDEO SG [ &gt; Video SG ]:</b> Select the test signal to be output from the internal test signal generator. When you set V INPUT in the HOME page of the function menu to "SG", the internal signal generator is activated and outputs the selected test signal. You can record this signal.	<b>*100% COLOR BARS [ &gt;&gt; 100% bars ]:</b> 100% color bar signal <b>RAMP(Y/C) [ &gt;&gt; Ramp ]:</b> Bias signal <b>GRAY [ &gt;&gt; Gray ]:</b> Grayscale signal <b>BLACK BURST [ &gt;&gt; BB ]:</b> Black burst signal
<b>SETUP ADD [ &gt; Setup add ]:</b> Select whether to add black setup to the composite video output signal.	<b>*OFF [ &gt;&gt; OFF ]:</b> Do not add setup. <b>ON (ADD) [ &gt;&gt; ON ]:</b> Add setup.
<b>CC (F1) BLANK [ &gt; CC1 blank ]:</b> Select whether to suppress the closed caption signal to be superimposed on the 1st field of the output video signal.  <b>Note</b> When you play back a disc with a recorded closed caption signal, the closed caption signal is multiplexed into SDSDI and composite output only.	<b>*OFF [ &gt;&gt; OFF ]:</b> Suppress. <b>ON [ &gt;&gt; ON ]:</b> Do not suppress.
<b>CC (F2) BLANK [ &gt; CC2 blank ]:</b> Select whether to suppress the closed caption signal to be superimposed on the 2nd field of the output video signal.  <b>Note</b> When you play back a disc with a recorded closed caption signal, the closed caption signal is multiplexed into SDSDI and composite output only.	<b>*OFF [ &gt;&gt; OFF ]:</b> Suppress. <b>ON [ &gt;&gt; ON ]:</b> Do not suppress.
<b>FRAME PB [ &gt; Frame PB ]:</b> Select whether to output fields or frames as still images of video.	<b>*AUTO [ &gt;&gt; AUTO ]:</b> Output a field image when the format is interlaced, and output a frame image when the format is progressive. <b>FRAME [ &gt;&gt; FRAME ]:</b> Always output a frame image.

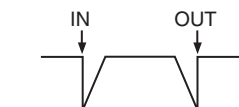
VIDEO CONTROL [Video]: Settings related to video control	Description	
<b>PROCESS CONTROL</b> [> Proc ctrl]: Separate adjustment screens appear for the following items. Use the jog dial to make settings, and press the MENU button to return from the adjustment screens to the second level of the setup menu.	<b>VIDEO GAIN [&gt;&gt; V gain]:</b> Adjust the video output level.	-848 [>>> -848] to 847 [>>> 847] <b>Factory default setting:</b> *0 [>>> 0]
	<b>CHROMA GAIN [&gt;&gt; C gain]:</b> Adjust the chroma output level	-848 [>>> -848] to 847 [>>> 847] <b>Factory default setting:</b> *0 [>>> 0]
	<b>CHROMA PHASE [&gt;&gt; C phase]:</b> Adjust the chroma phase.	-128 [>>> -128] to 127 [>>> 127] <b>Factory default setting:</b> *0 [>>> 0]
	<b>SETUP LEVEL [&gt;&gt; Setup lev]:</b> Adjust setup level.	-272 [>>> -272] to 271 [>>> 271] <b>Factory default setting:</b> *0 [>>> 0]
	<b>HD SYNC PHAS [&gt;&gt; HD S PHAS]:</b> Adjust HD sync phase.	-2200 [>>> -2200] to 2199 [>>> 2199] (system frequency: 60i) -2640 [>>> -2640] to 2639 [>>> 2639] (system frequency: 50i) -2750 [>>> -2750] to 2749 [>>> 2749] (system frequency: 23.98P) <b>Factory default setting:</b> *0 [>>> 0]
	<b>SD SYNC PHAS [&gt;&gt; SD S PHAS]:</b> Adjust SD sync phase.	-1716 [>>> -1716] to 1715 [>>> 1715] (system frequency: 60i/23.98P) -1728 [>>> -1728] to 1727 [>>> 1727] (system frequency: 50i) <b>Factory default setting:</b> *0 [>>> 0]
	<b>OUTPUT SCH [&gt;&gt; OutputSCH]:</b> Adjust the subcarrier H phase of composite video output.	-512 [>>> -512] to 511 [>>> 511] <b>Factory default setting:</b> *0 [>>> 0]  <b>Note</b> Valid for serial number 11001 or higher and firmware version 1.5 or higher.
<b>UP CONVERT [&gt; UP convert]:</b> Specify upconvert output.	<b>AUTO SQUEEZE [&gt;&gt; Auto SQZ]:</b> Select whether to use auto squeeze mode.	*OFF [>>> OFF]: Do not use. ON [>>> ON]: Use.
	<b>CONV MODE [&gt;&gt; Conv mode]:</b> Select the conversion mode.	*EDGE CROP [>>> Edge Crop]: Edge crop mode LETTER BOX [>>> LetterBox]: Letter box mode SQUEEZE [>>> Squeeze]: Squeeze mode
	<b>DETAIL GAIN [&gt;&gt; Detail]:</b> Select the gain level of the up converter image enhancer.	*LOW [>>> Low]: Low MID [>>> Mid]: Mid HIGH [>>> High]: High
<b>DOWN CONVERTER [&gt; Down conv]:</b> Set up the down converter.	<b>CONV MODE [&gt;&gt; Conv mode]:</b> Select the conversion mode.  <b>Note</b> "SQUEEZE" (squeeze mode) is selected automatically during recording.	*EDGE CROP [>> Edge Crop]: Edge crop mode LETTER BOX [>> LetterBox]: Letter box mode SQUEEZE [>> Squeeze]: Squeeze mode
	<b>DETAIL GAIN [&gt;&gt; Detail]:</b> Select the gain level of the down converter image enhancer.	*LOW [>> Low]: Low MID [>> Mid]: Mid HIGH [>> High]: High
	<b>CROSS COLOR [&gt;&gt; Cross col]:</b> Turn cross color adjustment on or off.	*OFF [>>> OFF]: The image enhancer uses default settings for cross color. ON [>>> ON]: The image enhancer adjusts so that there are fewer cross colors.

AUDIO CONTROL [Audio]: Settings related to audio control		Description
<b>REC MODE</b> [> REC mode]: Select the audio recording mode.		* <b>4ch×16bit</b> [>> <b>4ch/16bit</b> ]: 4-channel, 48-kHz mode * <b>2ch×16bit</b> [>> <b>2ch/16bit</b> ]: 2-channel, 48-kHz mode
<b>DATA MODE</b> [> Data mode]: Specify whether to handle digital audio signals as non-audio signals during recording.	<b>CH1/CH2 IN</b> [>> <b>CH1/CH2</b> ]: Specify for the input to the DIGITAL AUDIO (AES/EBU) 1/2 connectors.	* <b>AUDIO</b> [>>> <b>Audio</b> ]: Handle as audio signals. * <b>DATA</b> [>>> <b>Data</b> ]: Handle as non-audio signals.
	<b>CH3/CH4 IN</b> [>> <b>CH3/CH4</b> ]: Specify for the input to the DIGITAL AUDIO (AES/EBU) 3/4 connectors.	
<b>LEVEL SELECT</b> [> Level Sel]	<b>REF LEVEL</b> [>> <b>REF Level</b> ]: Specify the reference level (headroom) for audio signals recorded to disc. *-20dB [>>> -20dB] -18dB [>>> -18dB] -16dB [>>> -16dB] -12dB [>>> -12dB]	
	<b>CH1 IN LEVEL</b> [>> <b>CH1 input</b> ]: Select the audio level setting according to the audio level of the signal input to the AUDIO INPUT 1/3 connector. *+4dB [>>> +4dB] 0dB [>>> 0dB] -3dB [>>> -3dB] -6dB [>>> -6dB]	
	<b>CH2 IN LEVEL</b> [>> <b>CH2 input</b> ]: Select the audio level setting according to the audio level of the signal input to the AUDIO INPUT 2/4 connector.	
	<b>OUTPUT LEVEL</b> [>> <b>Out Level</b> ]: Select the analog audio output reference level.	
<b>INT AUDIO SG</b> [> Audio SG]: Select the operation of the internal audio test signal generator. When you set A1 INPUT to A4 INPUT in the HOME page of the function menu to "SG", the internal signal generator is activated and outputs the selected test signal. You can record this signal.		<b>SILENCE</b> [>> <b>silence</b> ]: Silent signal * <b>1kHz SINE</b> [>> <b>1kHz</b> ]: 1-kHz, -20 dB FS sine wave signal
<b>SHUTTLE MUTING</b> [> Shtl muting]: Set the audio muting conditions during shuttle playback.		* <b>OFF</b> [>> <b>OFF</b> ]: Do not perform muting. <b>ON</b> [>> <b>FULL</b> ]: Perform muting.
<b>EDIT POINT</b> [> Edit Point]: Specify the type of editing for audio signals.		<b>CUT</b> [>> <b>Cut</b> ]: Cut editing (Discontinuity in audio signal may result at the editing point, causing noise during playback.) * <b>FADE</b> [>> <b>Fade</b> ]: Fade in and fade out 
<b>DV OUT MODE</b> [> DV out mod]: Select the audio output mode of the S400 connector.		<b>4ch</b> [>> <b>4ch</b> ]: 12 bit/32 kHz/4ch * <b>2ch</b> [>> <b>2ch</b> ]: 16 bit/48 kHz/2ch
INTERFACE SELECT [Interface]: Settings related to interfaces		Description
<b>D-SUB OUTPUT</b> [> D-SUB Out]: Select the format of the signal output from the MONITOR connector.		<b>XGA(SYSTEM)</b> [>> <b>XGA(SYS)</b> ]: Set to XGA monitor output (according to system frequency). * <b>XGA(60Hz)</b> [>> <b>XGA(60Hz)</b> ]: Set to XGA monitor output (fixed at 60 Hz). <b>YPbPr</b> [>> <b>YPbPr</b> ]: Y/R-Y/B-Y component video signals

INTERFACE SELECT [Interface]: Settings related to interfaces	Description
<b>AUDIO OUTPUT</b> [> <b>Audio Out</b> ]: Select the channels for audio output from the AUDIO OUTPUT 1/3 and 2/4 connectors.	<b>*CH1/CH2</b> [>> <b>CH1/CH2</b> ]: Output channel 1 to the AUDIO OUTPUT 1/3 connector and channel 2 to the AUDIO OUTPUT 2/4 connector. <b>CH3/CH4</b> [>> <b>CH3/CH4</b> ]: Output channel 3 to the AUDIO OUTPUT 1/3 connector and channel 4 to the AUDIO OUTPUT 2/4 connector.
<b>REMOTE I/F</b> [> <b>Remote I/F</b> ]: Select how to perform remote control, when the remote control switch is set to REMOTE.	<b>i.LINK</b> [>> <b>i.LINK</b> ]: Use the  S400 connector. <b>*9PIN/RS-232C</b> [>> <b>9P/232C</b> ]: Use either the REMOTE(9P) connector or the RS232C connector, depending on the setting of the remote connector selector switch. <b>9PIN(PARA)</b> [>> <b>Para Run</b> ]: Use the REMOTE(9P) connector to connect several PDW-F70 units and perform remote control from one of them specified as the parent.
<b>BAUDRATE</b> [> <b>BaudRate</b> ]: Select the communications speed (bps) of the RS232C connector.	<b>*9600</b> [>> <b>9600</b> ] <b>19200</b> [>> <b>19200</b> ] <b>38400</b> [>> <b>38400</b> ] <b>57600</b> [>> <b>57600</b> ] <b>115200</b> [>> <b>115200</b> ]
<b>i.LINK MODE</b> [> <b>i.LinkMode</b> ]: Select the type of connection for the  S400 connector.	<b>*AV/C</b> [>> <b>AV/C</b> ]: AV/C connection. <b>FAM(PC REMOTE)</b> [>> <b>FAM</b> ]: FAM connection.
<b>NETWORK ENABLE</b> [> <b>Network En</b> ]: Select the positions of the remote control switch which enable access to the network.	<b>*NETWORK</b> [>> <b>Network</b> ]: Only when the switch is set to "NETWORK". <b>NETWORK&amp;RS-422A</b> [>> <b>Net&amp;Rmt</b> ]: Only when the switch is set to "NETWORK", or when the switch is set to "REMOTE" and the menu item REMOTE I/F is set to "9PIN/RS232".
<b>WIRELESS RMT</b> [> <b>Wireless</b> ]: Enable or disable operation from the wireless remote commander.	<b>DISABLE</b> [>> <b>DISABLE</b> ]: Disable. <b>*ENABLE</b> [>> <b>ENABLE</b> ]: Enable.

METADATA [Metadata]: Metadata settings		Description
<b>INDEX POSITION</b> [> <b>Index Pos</b> ]: Specify which frame to use as the thumbnail image (index picture) when recording.		<b>0SEC</b> [>> <b>0 sec</b> ] to <b>10SEC</b> [>> <b>10 sec</b> ]: The frame at 0 seconds to 10 seconds from the top of the clip, specified in units of 1 second. <b>Factory default setting:</b> *0SEC
<b>STORE OWNER</b> [> <b>Ownership</b> ]: Create UMID owner information.		The STORED OWNERSHIP screen appears. <i>For details, see Appendix "Setting UMID ownership information" on page 119.</i>
<b>UMID</b> [> <b>UMID</b> ]	<b>SDI OUT</b> [>> <b>SDI out</b> ]: Select whether to output UMID in the VANC of HD/SDSDI output.	<b>*ON</b> [>>> <b>ON</b> ]: Output. <b>OFF</b> [>>> <b>OFF</b> ]: Do not output.
	<b>SD VANC LINE</b> [>> <b>SDI line</b> ]: When SDI OUT is set to "ON", select the line of SDSDI output in which to output the UMID.	<b>12LINE</b> [>>> <b>12 line</b> ] to <b>19LINE</b> [>>> <b>19 line</b> ]: Select in the range line 12 to line 19. <b>Factory default setting:</b> *17LINE (line 17)
	<b>HD VANC LINE</b> [>> <b>HD line</b> ]: When SDI OUT is set to "ON", select the line of HDSDI output in which to output the UMID.	<b>9LINE</b> [>>> <b>9 line</b> ] to <b>20LINE</b> [>>> <b>20 line</b> ]: Select in the range line 9 to line 20. <b>Factory default setting:</b> *17LINE (line 17)

METADATA [Metadata]: Metadata settings		Description
<b>ESSENCE MARK [&gt; EssnceMk]</b>	<b>SDI OUT [&gt;&gt; SDI out]:</b> Select whether to output essence marks in the VANC of HD/SDSDI output.	<b>*ON [&gt;&gt;&gt; ON]:</b> Output. <b>OFF [&gt;&gt;&gt; OFF]:</b> Do not output.
	<b>SD VANC LINE [&gt;&gt; SDI line]:</b> When SDI OUT is set to "ON", select the line of SDSDI output in which to output essence marks.	<b>12LINE [&gt;&gt;&gt; 12 line] to 19LINE [&gt;&gt;&gt; 19 line]:</b> Select in the range line 12 to line 19. <b>Factory default setting:</b> *17LINE (line 17)
	<b>HD VANC LINE [&gt;&gt; HD line]:</b> When SDI OUT is set to "ON", select the line of HSDSI output in which to output essence marks.	<b>9LINE [&gt;&gt;&gt; 9 line] to 20LINE [&gt;&gt;&gt; 20 line]:</b> Select in the range line 9 to line 20. <b>Factory default setting:</b> *17LINE (line 17)
<b>HD VANC INPUT [&gt; HD VANC IN]:</b> Make settings related to recording of the VANC data contained in HSDSI input.	<b>LINE [&gt;&gt; Line]:</b> Select the line whose VANC you want to record.	<b>*OFF [&gt;&gt;&gt; OFF]:</b> Do not record VANC from any line. <b>9LINE [&gt;&gt;&gt; 9 LINE] to 20LINE [&gt;&gt;&gt; 20 line]:</b> Select from the range line 1 to line 20.  <b>Note</b> When this item is set to any setting other than OFF, VANC packet information is saved in the DATA ITEM section of MXF files.
	<b>DID [&gt;&gt; DID]:</b> Select the DID of the VANC you want to record.	<b>00 [&gt;&gt;&gt; 00] to FF [&gt;&gt;&gt; FF]</b> <b>Factory default setting:</b> *00 [>>> 00]
	<b>SDID [&gt;&gt; SDID]:</b> Select the SDID in the VANC you want to record.	<b>00 [&gt;&gt;&gt; 00] to FF [&gt;&gt;&gt; FF]</b> <b>Factory default setting:</b> *00 [>>> 00]
<b>DATA ITEM OUT [&gt; DATA ITEM]:</b> Specify whether to include the information from recorded VANC packets in data items in the DATA ITEM section of MXF files.		<b>OFF [&gt;&gt; OFF]:</b> Do not include VANC packet information in data items. <b>*ON [&gt;&gt; ON]:</b> Include VANC packet information in data items.  <b>Note</b> Set this menu item to OFF when you connect a nonlinear editing system that does not support DATA ITEM.

SETUP BANK OPERATION [Setup Bank]: Settings related to menu bank operations		Description
<b>Menu bank:</b> This unit allows three different complete sets of menu settings to be saved in what are termed "menu banks" numbered 1 to 3.		
<b>RECALL BANK 1 [&gt; Recall 1]:</b> Recall menu settings from menu bank 1.	Operate with the following procedure. (1) Select the bank you want to recall, then press the →/OUT button. Message "RECALL OK?" appears. (2) To recall, press the SET button. To quit recalling, press the RESET button	
<b>RECALL BANK 2 [&gt; Recall 2]:</b> Recall menu settings from menu bank 2		
<b>RECALL BANK 3 [&gt; Recall 3]:</b> Recall menu settings from menu bank 3.		
<b>SAVE BANK 1 [&gt; Save 1]:</b> Save current menu settings to menu bank 1.	Operate with the following procedure. (1) Select the bank you want to save, then press the →/OUT button. Message "SAVE OK?" appears. (2) To save, press the SET button. To quit saving, press the RESET button.	
<b>SAVE BANK 2 [&gt; Save 2]:</b> Save current menu settings to menu bank 2.		
<b>SAVE BANK 3 [&gt; Save 3]:</b> Save current menu settings to menu bank 3.		

MENU GRADE [Menu grade]: Selection of menu items to be displayed	Description
Determine whether to display basic items only or both basic and enhanced items in the monitor video section and the time data display section when using the setup menu.	* <b>BASIC</b> [-> <b>Basic</b> ]: Display basic items only. <b>ENHANCED</b> [->> <b>Enhanced</b> ]: Display both basic and enhanced items.

## Setup Menu Operations

This section explains how to change menu settings.

### Buttons used to change settings

Use the following buttons to change menu settings.

Menu control buttons	Functions
MENU button	<ul style="list-style-type: none"> <li>Display and hide the menu.</li> <li>Return to the menu from setting screens.</li> </ul>
↑/MARK1 and ↓/MARK2 buttons	These buttons move the highlighted cursor up and down within the current level to select an item or setting. Hold down one of these buttons to make the highlighted cursor move continuously.
←/IN and →/OUT buttons	Press the →/OUT button to go down one level. Press the ←/IN button to go up one level. Hold down one of these buttons to make the highlighted cursor move continuously.
RESET button	<ul style="list-style-type: none"> <li>Returns the setting to the factory default setting.</li> <li>Answer "No" to the question.</li> </ul>
SET button	<ul style="list-style-type: none"> <li>Saves the new setting in memory.</li> <li>Answer "Yes" to the question.</li> </ul>

### Changing the settings of basic items

The factory default setting is to display only the basic items. To change the settings of basic items, proceed as follows.

- 1 Press the ↑/MARK1 or ↓/MARK2 button to select the required item.

**Example:** Screen display when DISPLAY CONTROL is selected

SETUP MENU	
OPERATIONAL FUNCTION	
<b>DISPLAY CONTROL</b>	→
SETUP BANK OPERATION	
MENU GRADE	:BASIC

- 2 Press the →/OUT button.

This displays menu level 2 for the menu item selected in step 1.

**Example:** Screen display of the second level of the DISPLAY CONTROL menu

SETUP MENU	
DISPLAY CONTROL	
CHARA.DISPLAY	:ON
<b>← CHARA.POSITION</b>	→
CHARA.TYPE	:WHITE
CHARA.VSIZE	:x1
DISPLAY INFO	:T&STA
SUB STATUS	:OFF
MENU DISPLAY	:WHITE
BRIGHTNESS	:55%
ALARM	:ON

Current setting

- 3 Press the ↑/MARK1 or ↓/MARK2 button to select the required item.

For menu items on level 3, press the →/OUT button to go to level 3, then press the ↑/MARK1 or ↓/MARK2 button to select the item whose setting you wish to change.

**Example:** Screen display when SUB STATUS is selected



SETUP MENU	
DISPLAY CONTROL	
CHARA.DISPLAY	:ON
CHARA.POSITION	
CHARA.TYPE	:WHITE
CHARA.UsIZE	:x1
DISPLAY INFO	:T&STA
← SUB STATUS	:OFF →
MENU DISPLAY	:WHITE
BRIGHTNESS	:55%
ALARM	:ON

4 Press the →/OUT button.

This displays all possible settings for the item selected in step 3.

SETUP MENU	
DISPLAY CONTROL	
SUB STATUS	:OFF
← * OFF	→
TC MODE	
REMAIN	
CLIP NAME	

5 Press the ↑/MARK1 or ↓/MARK2 button to change the setting of the item.

SETUP MENU	
DISPLAY CONTROL	
SUB STATUS	:OFF
* OFF	
← TC MODE	→
REMAIN	
CLIP NAME	

6 To change other settings, press the ←/IN button to return to the previous screen, then repeat steps 3 to 5 as required.

7 When you have completed the settings, press the SET button.

The message “NOW SAVING...” appears in the monitor video section, and “Saving...” appears in the time data display section, while the new settings are saved in memory.

When the saving operation is completed, the monitor video section and time data display section return to their normal indications.

### Notes

- If you power off the unit before a save operation is completed, settings may be lost. Wait until the save is completed before powering off the unit.
- If, instead of pressing the SET button, you press the MENU button, the new settings are not saved. The message “ABORT !” appears in the monitor video section and “Abort !” in the time data display section for about 0.5 second, and the system exits the menus. To change more than one setting, be sure to press the SET button after making the settings.

## Meanings of indications on the menu screen

On-screen indication	Meaning
Right-pointing arrow (→) at the right of a menu item <i>See step 1 of the foregoing operating procedure (see page 96).</i>	Pressing the →/OUT button switches to the next lower menu level or to a setting selection screen.
Left-pointing arrow (←) at the left of a menu item <i>See step 2 of the foregoing operating procedure (see page 96).</i>	Pressing the ←/IN button returns to the previous (higher) menu level.
Character string at the right of a menu item	Current setting of the menu item <b>When shown with a colon (:):</b> the current setting is the same as the factory default setting. <i>See step 2 of the foregoing operating procedure (see page 96).</i> <b>When shown with a raised dot (•):</b> the current setting is different from the factory default setting. <i>See the next item, “Displaying enhanced items”.</i>
An * (asterisk) in a complete list of settings <i>See step 4 of the foregoing operating procedure (see page 97).</i>	Factory default setting

## Displaying enhanced items

The factory default setting is not to display enhanced items.

To display enhanced items, set the menu item MENU GRADE to “ENHANCED”, following the procedure in the previous section “Changing the settings of basic items”. In step 1, first select “MENU GRADE”, and next select “ENHANCED”, then press the SET button to save the setting in memory.

With this done, when you press the MENU button and the →/OUT button to display the setup menu, all basic and enhanced items on menu level 1 appear.

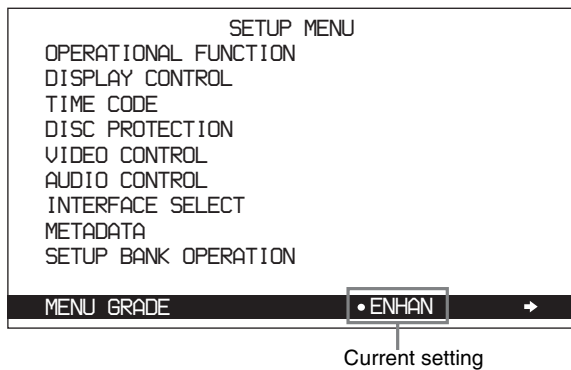

## Changing the settings of enhanced items

To change the settings of enhanced items, first carry out the procedure in the previous section “Displaying enhanced items” then proceed as follows.

**1** In the setup menu screen, repeat steps **2** to **7** of “Changing the Settings of Basic Items”, and then use the ←/IN, →/OUT, ↑/MARK1, ↓/MARK2 buttons to select a menu item and change the setting.

**2** When you have completed the settings, press the SET button.

The message “NOW SAVING...” appears in the monitor video section, and “Saving...” appears in the time data display section, while the new settings are saved in memory.

When the saving operation is completed, the monitor video section and time data display section return to their normal indications.

## Returning menu settings to their factory default settings

After making menu setting changes, to return settings to their factory default settings (setting initialization), use the following procedure.

### To return a particular setting to its factory default setting

In the section “Changing the settings of basic items” (page 96), carry out the procedure up to step **5**, then with the current setting displayed (in the example, if the factory default setting has been changed, the current setting will be TC MODE), proceed as follows.

**1** Press the RESET button.

“OFF” (factory default setting) is selected.

**2** Press the SET button.

The setting returned to its factory default is saved in memory as the current setting.

## To return all settings to their factory default settings

**1** Display the setup menu.

**2** Press the RESET button.

A message appears, to confirm whether or not you wish to return all settings to their factory default settings.

<b>Message in the monitor video section</b>	Initialize all items to factory preset values?
<b>Message in the time data display</b>	Init setup?

**3** Press the SET button.

The message “NOW SAVING...” appears in the monitor video section, and “Saving...” appears in the time data display, while the settings of all items are returned to their factory default settings. These factory default settings are saved in memory.

### Note

If you power off the unit while settings are being saved, settings may not be correctly returned to their factory default settings. Wait until the saving is completed before powering off the unit.

### To abandon the resetting operation

Instead of pressing the SET button, press the RESET button.

The display returns to the top level of setup menu, leaving the settings unchanged.

## Disc Menu

Use the disc menu to delete data on discs and to format discs.

*For the method of displaying the disc menu, see “Displaying the Setup and Disc Menus” (page 83).*

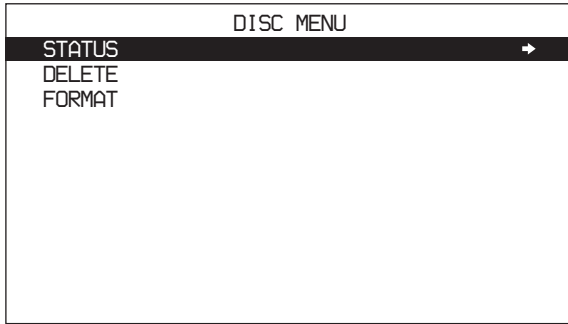

The disc menu contains the following items. Characters and symbols inside the brackets [ ] appear in the time data display section.

### STATUS [Status]

Displays disc or clip status.

**DISC [ > Disc ]:** Displays the DISC STATUS screen.

**CLIP [ > Clip ]:** Displays the CLIP STATUS screen.

### Note

The PDZ-1 Proxy Browsing Software allows you to write TITLE1 and TITLE 2 to the disc, but only TITLE1 appears here.

### DELETE [Delete]

Deletes clips from the disc.

**LAST CLIP [ > Last Clip ]:** Deletes the most recently recorded clip.

**ALL CLIP [ > All Clip ]:** Delete all clips. (Clips in the General directory are not deleted.)

### FORMAT [Format]

Formats a disc.

**QUICK FORMAT [ > Quick Format ]:** Deletes all data on the disc, including the contents of the General directory.

## Disc Menu Operations

### To display the status of the current disc or clip

Insert a disc, and then proceed as follows.

- 1 Display the disc menu (*see page 83*).
- 2 Press the **↑**/MARK1 button or **↓**/MARK2 button to select STATUS.
- 3 Press the **→**/OUT button.
- 4 Select DISC or CLIP and press the **→**/OUT button.

If you selected DISC, the status of the loaded disc appears.

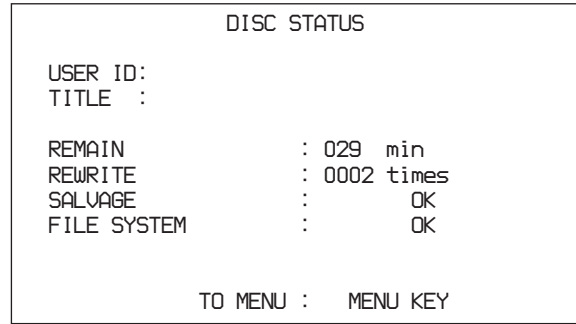

If you selected CLIP, the status of the current clip appears.



When playback or search reaches a new clip, the display changes to the status of the new clip.

### To return to the next highest level

Press the MENU button.

### To clear the menu from the screen

Press the MENU button twice.

### To delete the most recent recorded clip

### Note

If the clip is locked, it cannot be deleted.

Proceed as follows.

- 1 Display the disc menu (*see page 83*).
- 2 Press the **↑**/MARK1 button or the **↓**/MARK2 button to select DELETE.
- 3 Press the **→**/OUT button.  
The name of the clip to be deleted appears.
- 4 Press the SET button.

The clip is deleted, and the number of the deleted clip appears.

### To return to the next highest level without deleting the clip

Press the MENU button.

### **To clear the menu from the screen**

Press the MENU button twice.

### **To delete all clips**

#### **Note**

Carrying out the following procedure deletes all clips that are not locked.

Proceed as follows.

- 1** Display the disc menu (*see page 83*).
- 2** Press the **↑**/MARK1 button or the **↓**/MARK2 button to select DELETE.
- 3** Press the **→**/OUT button.
- 4** Select ALL CLIP, then press the **→**/OUT button.
- 5** When the message “ALL DELETE OK?” appears, press the SET button.

All of the clips on the disc are deleted.

#### **To return to the next highest level without deleting the clips**

Press the RESET button.

### **To clear the menu from the screen**

Press the MENU button.

### **To format a disc**

See “Formatting a Disc” (page 41) in Chapter 3.

---

## Option Boards for Enhanced Functionality

You can enhance the functionality of this unit by installing option boards in the option slots.

You can install up to two option boards. The boards which may be installed in each slot differ, as follows.

**Slot 1:** PDBK-101

**Slot 2:** One board from among the PDBK-102, PDBK-103, and PDBK-104

### Warning

Improper installation of option boards can result in fire, electric shock, bodily injury, and damage to equipment in the vicinity. For safety, always have option boards installed by a trained technician.

*Refer to the operation manual supplied with each board for information about installing, configuring, and operating the board.*

*Contact your Sony dealer regarding installation of option boards.*

---

## Using the PDBK-101 Network Board (Gigabit Ethernet)

Installing the PDBK-101 Network Board in slot 1 adds a network connector (  ) to this unit. This allows you to connect to a computer or network for high-speed FTP file transfers. You can also connect the unit to a Web site and display the unit's device information (model name, serial number, system frequency, software version, etc.).

### CAUTION

When you connect the unit to a computer or network, use a shielded-type cable to prevent malfunction due to radiation noise.

---

## Computer Connection Example (FTP Connection)

The following example shows a connection between this unit and a laptop computer.

# Using the PDBK-102 MPEG-TS Input/Output Board

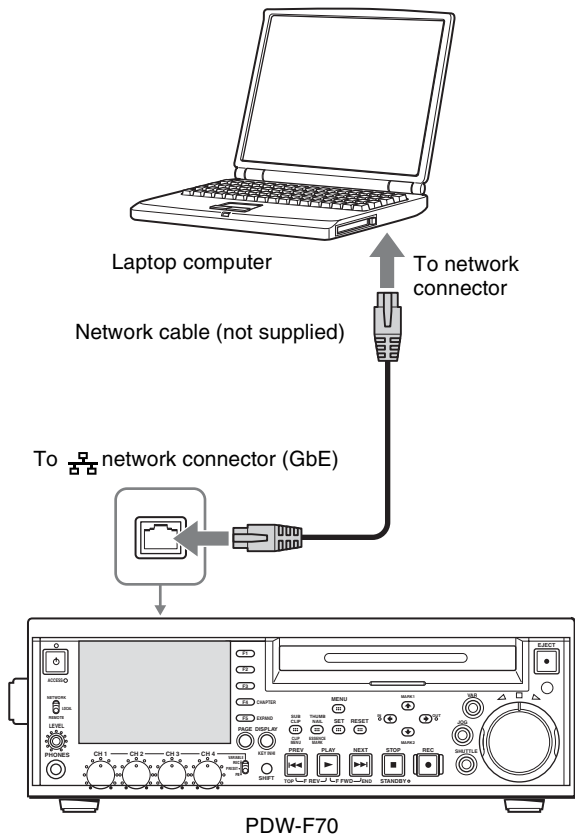

PDW-F70

Set the remote control switch to "NETWORK".

## Notes

- Install the PDBK-101 in option slot 1.
- Make network settings in the network settings menu. This menu appears only when the PDBK-101 option board is installed.

Refer to the PDBK-101 operation manual for more information about the network settings menu.

## Caution

For safety, do not connect a peripheral device connector that might have excessive voltage to the network connector of this unit. Follow the instructions in this manual when making connections.

With the PDBK-102 MPEG-TS Input/Output Board installed in option slot 2 of this unit, you can make i.LINK connections between this unit and video devices complying with the HDV 1080i<sup>1)</sup> standard (called "HDV devices" below), and between this unit and computers to which HDV devices may be connected. These connections can be used for input and output of MPEG-2 TS streams. This allows you to input material shot by HDV camcorders or the results of editing on a computer, and to record the input on XDCAM discs. You can also output video and audio from this unit to HDV devices.

1) HDV and **HDV** are trademarks of Sony Corporation and Victor Company of Japan, Limited.

## HDV Connection Example

The following example shows a connection between this unit and an HDV camcorder.

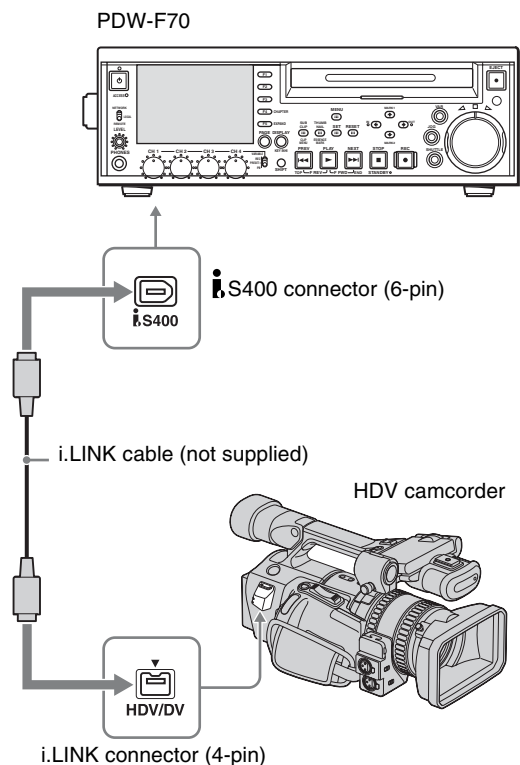

## Notes

- Install the PDBK-102 in option slot 2.

- The PDBK-103 and PDBK-104 cannot be used when the PDBK-102 is installed.

## Using the PDBK-103 Analog HD Input Board

With the PDBK-103 Analog HD Input Board installed in option slot 2 of this unit, you can record HD analog signals such as YPbPr signals and RGB signals in addition to HDSDI signals.

### Camcorder Connection Example

PDW-F330 Professional Disc Camcorder

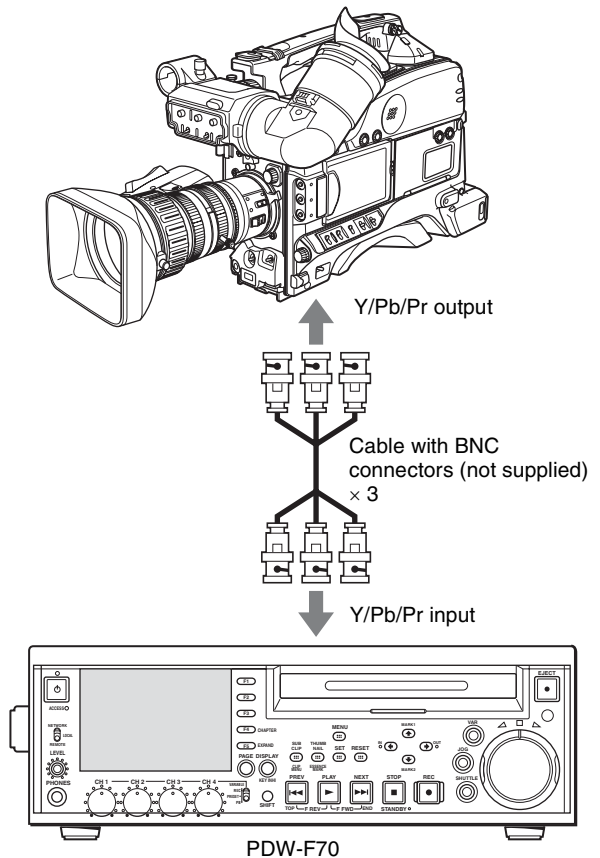

#### Notes

- Install the PDBK-103 in option slot 2.
- The PDBK-102 and PDBK-104 cannot be used when the PDBK-103 is installed.
- Select YPbPr signals or RGB signals in the input video selection menu. This menu appears only when an optional input board is installed.

# Using the PDBK-104 SD Input Upconverter Board

With the PDBK-104 SD Input Upconverter Board installed in option slot 2 of this unit, you can record upconverted SDDS and composite signals in addition to HDSI signals.

## Disc Recorder Connection Example

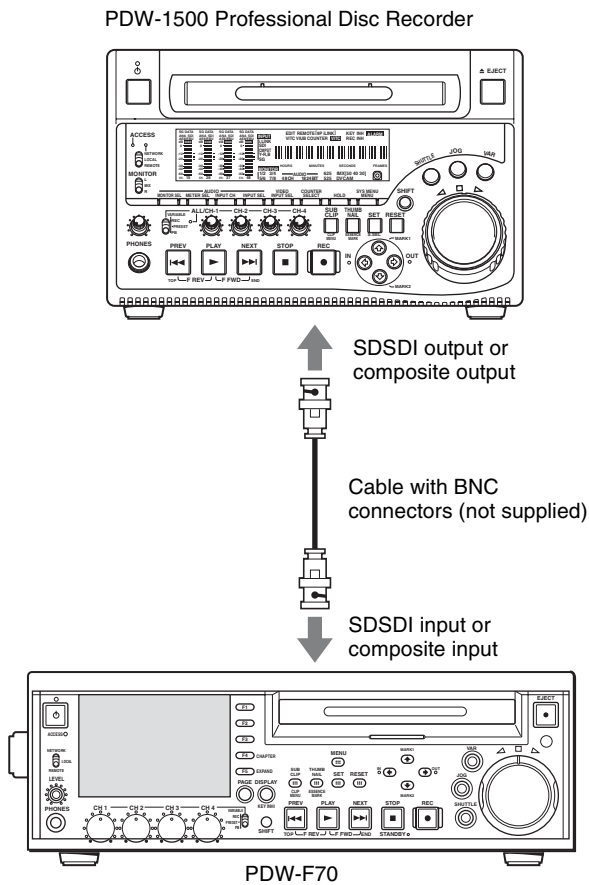

### Notes

- Install the PDBK-104 in option slot 2.
- The PDBK-102 and PDBK-103 cannot be used when the PDBK-104 is installed.
- Select SDDS or composite signals in the input video selection menu. This menu appears only when an optional input board is installed.



# Appendix

---

## Important Notes on Operation

### Use and storage

#### Do not subject the unit to severe shocks

The internal mechanism may be damaged or the body warped.

#### Do not cover the unit while operating

Doing so will cause temperatures to rise inside the unit, possibly resulting in failure.

#### After use

Turn off the on/standby switch.

If you plan not to use the unit for a long time, turn off the POWER switch on the rear panel as well.

#### Shipping

- Remove the disc before transporting the unit.
- If sending the unit by truck, ship, air or other transportation service, pack it in the shipping carton of the unit.

#### Care of the unit

If the body of the unit is dirty, clean it with a soft, dry cloth. In extreme cases, use a cloth steeped in a little neutral detergent, then wipe dry. Do not use organic solvents such as alcohol or thinners, as these may cause discoloration or other damage to the finish of the unit.

#### In the event of operating problems

If you should experience problems with the unit, contact your Sony dealer.

### Use and storage locations

Store in a level, ventilated place. Avoid using or storing the unit in the following places.

- In excessive heat or cold (operating temperature range: 5°C to 40°C (41°F to 104°F))  
Remember that in summer or in warm climates the

temperature inside a car with the windows closed can easily exceed 50°C (122°F).

- In damp or dusty locations
- Locations where the unit may be exposed to rain
- Locations subject to violent vibration
- Near strong magnetic fields
- Close to radio or TV transmitters producing strong electromagnetic fields.
- In direct sunlight or close to heaters for extended periods

#### To prevent electromagnetic interference from portable communications devices

The use of portable telephones and other communications devices near this unit can result in malfunctions and interference with audio and video signals.

It is recommended that the portable communications devices near this unit be powered off.

### About the LCD panel

LCD panels are manufactured with extremely high precision technology that yields effective pixel rates of 99.99% or higher. However, very rarely, one or more pixels may be permanently dark or permanently lit in white, red, blue, or green.

This phenomenon is not a malfunction. Such pixels have no effect on the recorded data, and the unit may be used with confidence even if they are present.

---

### Condensation

If you move the unit from a very cold place to a warm place, or use it in a damp location, condensation may form on the optical pickup. Then, if the unit is operated in this state, recording and playback may not be performed properly.

Do the following to prevent this from happening.

- When you move or operate the unit in an environment where condensation may form, be sure to insert a disc in advance.
- Whenever you turn on the On/standby switch, check that the HUMID indicator does not appear on the LCD panel.

If it appears, wait until it disappears before inserting a disc.

# Periodic Maintenance

## Digital Hours Meter

The digital hours meter can provide information about the operational history of the unit. Use the information as a guide in scheduling periodic maintenance. For periodic maintenance, contact your Sony dealer.

### To display digital hours meter

The digital hours meter appears in both the monitor video section and time data display section as the digital hours meter menu of the system menu. It can also be superimposed on the screen of the external video monitor connected to the unit (*see page 37*).

To display the digital hours meter, proceed as follows.

- 1 Press the MENU button to display the system menu.
- 2 Press the **↑**/MARK1 button or **↓**/MARK2 button, select the HOURS METER (Hours Meter in the time data display section), and then press the SET button.

HOURS METER			
H1	317/	317	HOURS
H2	22		HOURS
H3	92		HOURS
H4	92		TIMES
H5	114		
H1: OPERATION			
H2: LASER PARAMETER			
H3: SEEK RUNNING			
H4: SPINDLE RUNNING			
H5: LOADING COUNTER			

### Display of the digital hours meter

Any of the items can be reset during periodic maintenance or parts replacement. Resetting items allows you to roughly determine the timing of next periodic maintenance.

*For display resetting, contact your Sony dealer.*

Item name (name between [ ] is name in the time data display section)	Description
H1: OPERATION [Opr]	Displays the total number of hours the unit has been powered on in units of hours.
H2: LASER PARAMETER [Lasr]	This shows the cumulative light output time for optical head in units of hours.

Item name (name between [ ] is name in the time data display section)	Description
H3: SEEK RUNNING[Seek]	This shows the cumulative seek operation time for optical head in units of hours.
H4: SPINDLE RUNNING[Spdl]	This shows the cumulative spindle rotation time in units of hours.
H5: LOADING COUNTER[Load]	Display the total number of times discs have been loaded in the unit.

### To exit from the digital hours meter

Press the MENU button.

# Troubleshooting

## Alarms

An alarm (warning message) appears in the time data display section when an operation is attempted which is inappropriate for the settings on this unit or the state of the disc. Both the alarm message and the action to take to resolve the problem appear in the monitor video section and on the screen of the external video monitor connected to the unit.

REMOTE!

Example alarm in time data display section

ALARM  
 REMOTE MODE IS SELECTED.  
 SET REMOTE/LOCAL/NETWORK  
 SWITCH TO LOCAL.

Example alarm in monitor video section

When an alarm is displayed, remove the alarm cause by following the action to take. If the alarm display does not disappear, contact your Sony dealer.

Please note that there are some alarms which do not appear depending on the setting of DISPLAY CONTROL >ALARM in the setup menu (*see page 89*).

*See "System Menu" (page 83) for more information about setup menu operations.*

### When the unit is powered on

Alarm message in time data display section	Alarm message in monitor video section	Description/action
MENU Ver. UP	THE SETUP MENU SOFTWARE HAS BEEN UPGRADED. SET THE SETUP MENU ITEMS TO THE DESIRED SETTINGS.	Reset the settings in the setup menu ( <i>see page 84</i> ).
ILL. SETUP!	INVALID SETTINGS SELECTED IN SETUP MENU. SET ITEMS IN THE SETUP MENU TO THE APPROPRIATE VALUES. CONTACT SERVICE IF THIS ALARM APPEARS AGAIN AFTER ABOVE PROCEDURE.	Reset the settings in the setup menu ( <i>see page 84</i> ). If the same message appears after you reset the settings, contact your Sony dealer.
Exchg batt!	BATTERY NEEDS REPLACING. PLEASE CONTACT SERVICE.	The NVRAM battery is exhausted. Contact your Sony dealer.

## When a disc is inserted

Alarm message in time data display section	Alarm message in monitor video section	Description/action
Unknown FS!	UNKNOWN FILE SYSTEM. PLEASE FORMAT DISC OR EJECT.	Format the disc, or eject it (see page 41).
No FS!	NO FILE SYSTEM.PLEASE EJECT DISC.	Eject the disc.
ILL. Disc!	IRREGULAR DISC IS USED. USE PROFESSIONAL DISC.	Use a Professional Disc.
Salvage NG!	CLIP SALVAGE WAS NOT COMPLETED.	See "Handling of Discs When Recording Does Not End Normally (Salvage Functions)" (page 41).
525/60 Clip <sup>a)</sup>	IRREGULAR DISC IS USED. DVCAM 525/60 CLIP(S) EXIST.	Use another disc.
625/50 Clip <sup>a)</sup>	IRREGULAR DISC IS USED. DVCAM 625/50 CLIP(S) EXIST.	
4CHx16 Clip <sup>a)</sup>	DISC HAS 4CHx16 BIT CLIP(S). CHANGE RECORD FORMAT IN SETUP MENU.	Change the setting of AUDIO CONTROL >REC MODE in the setup menu (see page 93).
2CHx16 Clip <sup>a)</sup>	DISC HAS 2CHx16 BIT CLIP(S). CHANGE RECORD FORMAT IN SETUP MENU.	Change the setting of AUDIO CONTROL >REC MODE in the setup menu (see page 93).
No Support!	FORMAT NOT SUPPORTED. RECORDING AND PLAYBACK IS NOT POSSIBLE.	A disc in an unsupported recording format is loaded. Use a disc formatted in the MPEG HD or DVCAM format.
ILL. Index!	INDEX FILE ERROR. PLEASE FORMAT DISC OR EJECT.	Format the disc, or eject it (see page 41).
FORMAT NG!	AUTO FORMATTING WAS NOT COMPLETED.	Eject the disc and insert it again, or insert another disc.
DI read err	CANNOT READ DISC INFORMATION.PLEASE EJECT DISC.	
Read err		
DRV ADJ err	CANNOT PERFORM AUTO DRIVE ADJUSTMENT.	

a) Displayed only when DISPLAY CONTROL >ALARM is set to "ON" or "LIMITED".

## During front panel operations

Alarm message in time data display section	Alarm message in monitor video section	Description/action
KEY INHI! <sup>a)</sup>	KEY INHIBIT MODE IS SELECTED.	This appears when the KEY INH (SHIFT + DISPLAY) button is on. Turn the KEY INH button off.
REMOTE! <sup>a)</sup>	REMOTE MODE IS SELECTED. SET REMOTE/LOCAL/NETWORK SWITCH TO LOCAL.	Set the remote control switch to "LOCAL".
No Disc! <sup>a)</sup>	NO DISC.	Insert a disc and try again.
REC INHI! <sup>a)</sup>	THE DISC WRITE PROTECT TAB IS SET TO SAVE.	Set the disc's Write Inhibit tab to enable recording (see page 40).
	REC INHIBIT MODE IS SELECTED.	This appears when REC INH on page P1 of the function menu is set to "ON". Set REC INH to "OFF" (see page 82).
No Clip! <sup>b)</sup>	NO CLIP.	This appears when a playback, search or delete operation is attempted on a disc with no clips recorded on it. Insert a disc with clips recorded on it.

Alarm message in time data display section	Alarm message in monitor video section	Description/action
Disc Top! <sup>a)</sup>	DISC TOP.	This appears if you press the PREV button or conduct a high-speed reverse search when the unit is stopped at the start of the disc. Use forward search or playback instead.
Disc End! <sup>a)</sup>	DISC END.	This appears if you press the NEXT button or conduct a forward high-speed search when the unit is stopped at the end of the disc. Use reverse search or playback instead.
MAX # Files	DISC CANNOT BE RECORDED TO. FOR MORE RECORDING SPACE, DELETE CLIPS OR NON-AV DATA. (GENERAL FILES)	Delete clips or GENERAL files.
	DISC CANNOT BE RECORDED TO. FOR MORE RECORDING SPACE, DELETE OTHER CLIP LISTS.	Delete unneeded clips, or insert a disc with enough free space.
Disc Full!	DISC FULL. FOR MORE RECORDING, DELETE SOME CLIPS.	Delete unneeded clips, or insert a disc with enough free space.
MAX# SB CLP <sup>b)</sup>	NO MORE SUB CLIPS CAN BE ADDED TO CLIP LIST.	This appears when an attempt is made to add sub clips when 300 sub clips have already been registered. Limit the creation of sub clips to 300 or fewer.
CL OVER DUR <sup>b)</sup>	DURATION OF ONE CLIP LIST MUST BE LESS THAN 24 HOURS.	This appears when you try to add a sub clip when the total duration of sub clips in a clip list has already reached 24 hours. Create clip lists so that the total duration is within 24 hours.
Run Salvage	EXECUTE SALVAGE PROGRAM.	This appears when recording, E-E display, essence mark recording, or sub clip addition for quick scene selection is attempted on a disc that needs to be salvaged. Try again after salvaging the clips on the disc (see page 41).
CNT mode! <sup>a)</sup>	COUNTER MODE IS SELECTED. SET COUNTER SELECT SWITCH TO TC OR UB.	This appears when CNTR SEL on page P1 of the function menu is set to "COUNTER", and you try to preset timecode or user bits. To use timecode or user bits, set CNTR SEL to "TC" or "UB" (see page 82).
TC EXT! <sup>b)</sup>	TC EXTERNAL IS SELECTED. SET TC INTERNAL MODE IN FUNCTION MENU.	This appears when TCG on page P2 of the function menu is set to "EXT", and you try to preset timecode or user bits by setting TC MODE to "PRESET". Set TCG to "INT" (see page 82).
REGEN mode! <sup>a)</sup>	TCG REGEN MODE IS SELECTED. SET TC PRESET MODE IN FUNCTION MENU.	This appears when TC MODE on page P2 of the function menu is set to "REGEN", and you try to preset timecode or user bits. Set TC MODE to "PRESET" (see page 83).
REC RUN! <sup>a)</sup>	TCG RUN MODE IS SET TO REC RUN. SET TC FREE RUN MODE IN FUNCTION MENU.	This appears when RUN MODE on page P2 of the function menu is set to "REC RUN", and you try to preset timecode or user bits. Set RUN MODE to "FREE RUN" (see page 83).
REC mode! <sup>b)</sup>	THUMBNAIL(S) CANNOT BE DISPLAYED DURING RECORDING.	Stop recording and try again.
	CANNOT EXECUTE IN REC MODE.	
	DRIVE MAINTENANCE MENU CANNOT BE EXECUTED WHILE IN REC MODE.	
No SEL List <sup>b)</sup>	CLIP LIST IS NOT SELECTED.	This appears when you press the SUB CLIP button while the clip list on the disc is not loaded into the current clip list. Load the clip list (see page 62) and try again.

Alarm message in time data display section	Alarm message in monitor video section	Description/action
No SUB CLIP <sup>a)</sup>	CLIP LIST CANNOT LOCATE SPECIFIED SUB CLIP(S).	This appears when a playback button is pressed with no sub clips in the current clip list. Playback is not possible when there are no sub clips in the current clip list.
SB CLP mode <sup>b)</sup>	TO ADD AN ESSENCE MARK, EXIT FROM SUB CLIP MODE FIRST.	This appears when you press the ESSENCE MARK (SHIFT + THUMBNAIL) button with the SUB CLIP button lit. Try again after pressing the SUB CLIP button to turn it off.
SUB CLIP NG <sup>b)</sup>	SUB CLIP IS INVALID. SET APPROPRIATE IN/OUT POINTS.	Set the In and Out points again.
No List! <sup>b)</sup>	NO CLIP LIST.	This appears when you try to delete a clip list when there is no clip list saved on the disc. Load the disc that contains the clip list you want to delete.
STOP ONCE! <sup>b)</sup>	STOP ONCE, THEN EXECUTE.	This appears when you press the SUB CLIP button during clip list playback. Stop the playback and try again.
No EM space	ESSENCE MARK NOT RECORDED. NO SPACE AVAILABLE TO RECORD ESSENCE MARK.	Use the PDZ-1 Proxy Browsing Software to delete unneeded essence marks.
EM Full!	NO MORE ESSENCE MARKS CAN BE RECORDED.	
Disc Damage	DISC CANNOT BE RECORDED TO. USE ANOTHER DISC FOR RECORDING.	Use another disc.
NON-AV Full	DISC CANNOT BE RECORDED TO. FOR MORE RECORDING SPACE, DELETE CLIPS OR NON-AV DATA. (GENERAL FILES)	Delete unneeded clips or GENERAL files.
Index File!	UNSUPPORT INDEX FILE. DISC CANNOT BE RECORDED TO.	Use another disc.
File System	CURRENT VERSION OF THE SOFTWARE SETS THE DISC WRITE PROTECTED.	This appears when you insert a disc that can be played back but not recorded. Exchange the disc for one with a file system supported by this unit. Or format the disc (see page 41).
	FILE SYSTEM ON THE DISC INHIBITS WRITING.	
Loading! <sup>a)</sup>	LOADING.	This appears if you press a button while a disc is loading. Wait until the disc has finished loading and try again.
Unloading! <sup>a)</sup>	UNLOADING.	This appears if you press a button while a disc is unloading. Wait until the disc has finished unloading and try again.

a) Displayed only when DISPLAY CONTROL >ALARM is set to "ON".

b) Displayed only when DISPLAY CONTROL >ALARM is set to "ON" or "LIMITED".

## During recording and editing operations

Alarm message in time data display section	Alarm message in monitor video section	Description/action
Input Sig! <sup>a)</sup>	INPUT SIGNAL FREQUENCY IS NOT THE SAME AS THE SYSTEM SETUP.	This appears when an input signal does not match the system frequency of this unit. Input a signal that matches the system frequency, or change this unit's system frequency setting (see page 23).

Alarm message in time data display section	Alarm message in monitor video section	Description/action
HD 60I/30P <sup>a)</sup>	DISC CANNOT BE RECORDED. HD 60I or HD 30P CLIP(S) EXIST.	This appears when the system frequency of this unit does not match that of the loaded disc. Insert a disc that matches the system frequency, or change this unit's system frequency setting ( <i>see page 23</i> ).
HD 50I/25P <sup>a)</sup>	DISC CANNOT BE RECORDED. HD 50I or HD 25P CLIP(S) EXIST.	
HD 23P Disc <sup>a)</sup>	DISC CANNOT BE RECORDED. HD 23.98P CLIP(S) EXIST.	
ILL. REF! <sup>a)</sup>	INPUT VIDEO SIGNAL DOES NOT SYNCHRONIZE WITH REF VIDEO SIGNAL. USE COMMON REFERENCE SIGNAL OR CONNECT RECORDER REF OUT TO PLAYER REF IN.	Input a reference signal synchronized with this unit's system frequency.
ILL. REC! <sup>a)</sup>	ENCODING DOES NOT SYNCHRONIZE WITH REF VIDEO.	Check the signals being input to this unit.
ILL. PLAY! <sup>a)</sup>	ILLEGAL PLAYBACK.	Check the disc being played by this unit.
MEM. Full! <sup>a)</sup>	MEMORY FULL !!	Check the disc being recorded by this unit.
MEM. Empty! <sup>a)</sup>	MEMORY EMPTY !!	
Recording	NOW RECORDING ...	Wait for recording to finish.

a) Displayed only when DISPLAY CONTROL >ALARM is set to "ON" or "LIMITED".

## During playback

Alarm message in time data display section	Alarm message in monitor video section	Description/action
525/60 Disc <sup>a)</sup>	DISC CANNOT BE PLAYED BACK. USE DISC WITH HD 50I or HD 25P RECORDING.	This appears when the system frequency of this unit does not match that of the loaded disc. Insert a disc that matches the system frequency, or change this unit's system frequency setting (see page 23).
	DISC CANNOT BE PLAYED BACK. USE DISC WITH HD 23.98P RECORDING.	
	DISC CANNOT BE PLAYED BACK. USE DISC WITH DVCAM 625/50 RECORDING.	
625/50 Disc <sup>a)</sup>	DISC CANNOT BE PLAYED BACK. USE DISC WITH HD 60I or HD 30P RECORDING.	
	DISC CANNOT BE PLAYED BACK. USE DISC WITH HD 23.98P RECORDING.	
	DISC CANNOT BE PLAYED BACK. USE DISC WITH DVCAM 525/60 RECORDING.	
HD 60I/30P <sup>a)</sup>	DISC CANNOT BE PLAYED BACK. USE DISC WITH HD 50I or HD 25P RECORDING.	
	DISC CANNOT BE PLAYED BACK. USE DISC WITH HD 23.98P RECORDING.	
	DISC CANNOT BE PLAYED BACK. USE DISC WITH DVCAM 625/50 RECORDING.	
HD 50I/25P! <sup>a)</sup>	DISC CANNOT BE PLAYED BACK. USE DISC WITH HD 60I or HD 30P RECORDING.	
	DISC CANNOT BE PLAYED BACK. USE DISC WITH HD 23.98P RECORDING.	
	DISC CANNOT BE PLAYED BACK. USE DISC WITH DVCAM 525/60 RECORDING.	
HD 23P Disc <sup>a)</sup>	DISC CANNOT BE PLAYED BACK. USE DISC WITH HD 60I or HD 30P RECORDING.	
	DISC CANNOT BE PLAYED BACK. USE DISC WITH HD 50I or HD 25P RECORDING.	
	DISC CANNOT BE PLAYED BACK. USE DISC WITH DVCAM 525/60 RECORDING.	
	DISC CANNOT BE PLAYED BACK. USE DISC WITH DVCAM 625/50 RECORDING.	
Disc Error!	DISC ERROR DETECTED.	Use another disc.

a) Displayed only when DISPLAY CONTROL >ALARM is set to "ON" or "LIMITED".



## During thumbnail search, scene selection, and clip list operations

Alarm message in monitor video section	Description/action
CANNOT EXPAND CLIP ANY FURTHER.	The clip cannot be expanded into more blocks. This appears when the EXPAND button is pressed when the number of block is maximum, or when the duration of an expanded thumbnail is 1 frame.
SELECTED ESSENCE MARK DOES NOT EXIST.	The selected essence mark does not exist. This appears in the essence mark selection screen when the specified essence mark does not exist on the disc.
SUB CLIP IS INVALID. SET APPROPRIATE IN/OUT POINTS.	The temporal relationship between the specified In and Out points in a TRIM operation (see page 71) is not correct. Reset so that the value of the Out point timecode is larger than the value of the In point timecode.
DURATION OF ONE CLIP LIST MUST BE LESS THAN 24 HOURS.	The total duration of the current clip list is greater than 24 hours. This appears when the total duration of the current clip list exceeds the upper limit of 24 hours as the result of a sub clip ADD operation or a TRIM operation (see page 71).
NO MORE SUB CLIPS CAN BE ADDED TO THE CLIP LIST.	The upper limit of sub clips in the current clip list has been exceeded. This appears when the upper limit of 300 clips in a clip list has been exceeded as the result of a sub clip ADD operation. (see page 71).
SUB CLIP DOES NOT EXIST.	There are no sub clips in the current clip list. This appears when an attempt is made to execute a MOVE, TRIM, DELETE, or TC PRESET operation (see page 71) with no sub clips in the current clip list.
CLIP LIST DOES NOT EXIST.	There are no clip lists on the disc. This appears when an attempt is made to execute a DELETE CLIP LIST operation (see page 71) when there are no clip lists on the disc.
MOVE IS INVALID.	The sub clip cannot be moved. This appears when an attempt is made to execute a MOVE operation (see page 71) when there are no sub clip in the current clip list, or when there is only 1.
REC INHI!	The disc is write protected. This appears when an attempt is made to execute an operation that requires recording while the disc is write protected.
DISC FULL!	The disc is full. This appears when an attempt is made to execute an operation that requires recording while the disc is full.
SHOT MARK DOES NOT EXIST.	The specified shot mark has not been recorded. This appears when an attempt is made to execute a DELETE SHOT MARK operation on a clip when the specified shot mark has not been recorded for that clip.
REC START CANNOT BE DELETED.	REC START cannot be deleted. This appears when an attempt is made to delete a REC START with a DELETE SHOT MARK operation. DELETE SHOT MARK can delete only SHOT MARK1 and SHOT MARK2 marks.
CLIP IS LOCKED.	The clip is locked. This appears when an attempt is made to delete a clip, set the clip thumbnail, or delete a shot mark when the clip is locked.
ALL CLIPS ARE LOCKED.	All clips are locked. This appears when an attempt is made to execute a LOCK ALL CLIPS operation when all clips are already locked.
ALL CLIPS ARE UNLOCKED.	All clips are unlocked. This appears when an attempt is made to execute an UNLOCK ALL CLIPS operation when all clips are already unlocked.

## Alarms relating to audio and video signals

Alarm message in time data display section	Alarm message in monitor video section	Action
No INPUT! <sup>a)</sup>	INPUT VIDEO IS NOT DETECTED. CHECK THE VIDEO INPUT MODE AND SUPPLY A VIDEO SIGNAL TO VIDEO INPUT.	<ul style="list-style-type: none"> <li>• Check the setting of V INPUT on the HOME page of the function menu (see page 81).</li> <li>• Input an HDS DI signal.</li> </ul>

Alarm message in time data display section	Alarm message in monitor video section	Action
EMPHASIS! <sup>a)</sup>	INPUT AUDIO EMPHASIS IS NOT SUPPORTED. CHECK THE EMPHASIS OF THE AUDIO INPUT SIGNAL.	Check the emphasis of the audio input signal.

a) Displayed only when DISPLAY CONTROL >ALARM is set to "ON".

## Alarms relating to sensors and drives

Alarm message in time data display section	Alarm message in monitor video section	Description/action
FAN Stopped	FAN MOTOR STOPPED.	Contact your Sony dealer.
DR-FAN Stop	DRIVE FAN MOTOR STOPPED.	<b>Note</b> The unit will not stop operating, but if you continue to use it in this state temperatures inside the unit or the drive will rise, possibly resulting in failure or fire.
High TEMP!	HIGH TEMPERATURE.	
	HIGH TEMPERATURE IN DRIVE.	

## Error Messages

Error codes appear in the time data display when an error (usually a hardware problem) occurs. In addition, both error messages and error codes appear in the monitor video section and on the video monitor connected to the unit. When an error message appears, follow the instructions in the error message to resolve the problem.

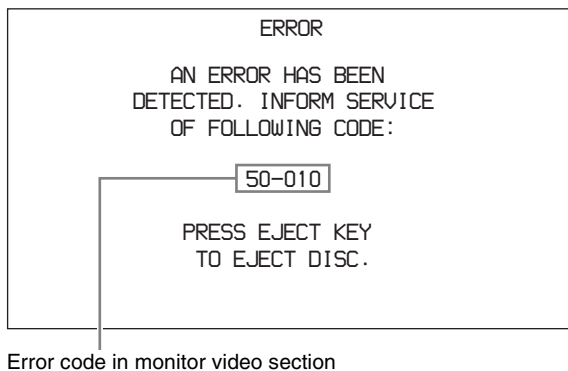
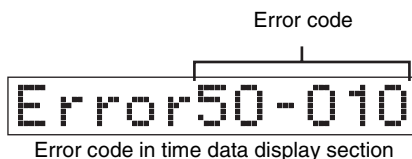

## To Eject Discs With the Unit Powered Off

As an emergency measure, disc cartridges can be removed with the unit powered off. This operation should always be done by a trained service technician.

## About i.LINK

This section explains the specifications and features of i.LINK.

### What is i.LINK?

i.LINK is a digital serial interface designed to integrate devices equipped with i.LINK connectors. i.LINK allows your device to:

- Perform two-way transmission and reception of data such as digital audio and digital video signals.
- Control other i.LINK devices.
- Easily connect multiple devices with a single i.LINK cable.

Your i.LINK device is capable of connecting to a wide range of digital AV devices for data transfer and other operations.

Other advantages include the following feature. When connected to multiple i.LINK devices, your i.LINK device can perform data transfer and other operations not only with the directly connected devices but also with any of the devices that are connected to those devices. Therefore, you do not need to be concerned with device connection order. However, depending on the features and specifications of the connected devices, you may need to use certain functions differently, and you may not be able to transfer data or perform certain operations.

i.LINK, a nickname for IEEE 1394 proposed by Sony, is a trademark supported by many companies worldwide. IEEE 1394 is an international standard defined by IEEE, the Institute of Electrical and Electronics Engineers, Inc.

## Note

The unit can be connected to one device with the i.LINK cable (DV cable). When you connect with a device that has two or more i.LINK connectors, refer to the operating instructions supplied with the connected device.

## About data transfer speed of i.LINK

i.LINK defines maximum data transfer speeds of approximately 100, 200 and 400 Mbps<sup>1)</sup> that are referred to as S100, S200 and S400 respectively.

The maximum data transfer speed that an i.LINK device supports is identified on the specifications page of the operating instructions supplied with the device or near its i.LINK connector.

When you connect a device that supports different data transfer speeds, the actual data transfer speeds may be different from those indicated on the i.LINK connectors.

### 1) What is Mbps?

Megabits per second. A measure of the rate at which data is transmitted per second. In case of 100 Mbps, 100 Megabits of data can be transmitted per second.

## i.LINK operation with this unit

For details on operation when other equipment with an i.LINK (DV) connector is connected, *see Chapter 2 (page 23)*.

For details on connection with an i.LINK cable and the necessary software, refer to the operating instructions supplied with the connected device.

### Use Sony i.LINK cables

Use Sony i.LINK cables to connect the i.LINK devices.

6 pins ↔ 4 pins (For DV dubbing)

6 pins ↔ 6 pins (For DV dubbing)

i.LINK and  are trademarks.

# Specifications

## General

External dimensions (w/h/d, excluding projections)  
307 × 100 × 411 mm  
(12<sup>1</sup>/<sub>8</sub> × 4 × 16<sup>1</sup>/<sub>4</sub> inches)

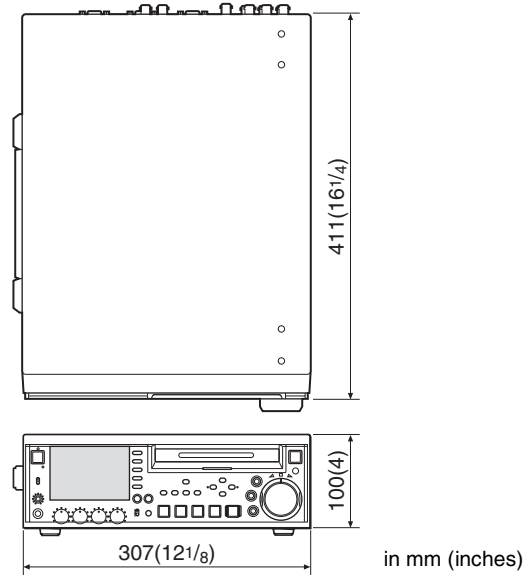

Mass 7.2 kg (15 lb 13 oz)

Power requirements

100 V to 240 V AC, 50/60 Hz

Power consumption

0.79-0.33 A

Peak inrush current

- (1) Power ON, current probe method:  
45 A (240 V), 15 A (100 V)
- (2) Hot switching inrush current,  
measured in accordance with  
European standard EN55103-1: 7 A  
(230 V)

Operating temperature

5°C to 40°C (41°F to 104°F)

Storage and transport temperature

-20°C to +60°C (-4°F to +140°F)

Operating relative humidity (no condensation allowed)

25% to 80% (RH)

Storage and transport relative humidity (no condensation allowed)

20% to 90%

## System

### Recording format

Video MPEG HD: HQ35/SP25/LP18 Mbps  
Proxy video MPEG-4<sup>1)</sup>  
Audio MPEG HD: 16 bits, 48 kHz, 4/2 channels  
Proxy audio A-law 8 bits, 8 kHz, 4 channels

## Playback format

Video	MPEG HD: HQ35/SP25/LP18 Mbps DVCAM: 25 Mbps
Proxy video	MPEG-4 <sup>1)</sup>
Audio	MPEG HD: 16 bits/48 kHz, 4/2 channels DVCAM: 16 bits/48 kHz, 4 channels
Proxy audio	A-law 8 bits, 8 kHz, 4 channels

1) The MPEG-4 Codec is a product of Ingenient Technologies, Inc.

## Recording/Playback time (when PFD23 is used)

### MPEG HD

Mode	4-channel audio	2-channel audio
HQ mode (VBR 35 Mbps)	65 minutes or more	68 minutes or more
SP mode (CBR 25 Mbps)	Approx. 85 minutes	Approx. 90 minutes
LP mode (VBR 18 Mbps)	112 minutes or more	122 minutes or more

DVCAM (playback only)  
85 minutes

## Search speed

Jog mode	-1 to +2 times normal speed
Variable-speed mode	-1 to +2 times normal speed
Shuttle mode	-20 to +20 times normal speed
Fast forward mode	+20 times normal speed
Fast reverse mode	-20 times normal speed

## Video performance

Sampling frequency	Y: 74.25 MHz, R-Y/B-Y: 37.125 MHz
Quantization	8 bits/sample
Compression	MPEG2 MP@HL

## Composite output (DV)

Frequency response	50I: 0 to 4.8 MHz +1.0/-3.0 dB 60I: 0 to 4.2 MHz +1.0/-3.0 dB
S/N (Y)	53 dB or more
Y/C delay	±25 ns or less
K-factor (K2T)	2% or less

## Audio performance

Sampling frequency	48 kHz
Quantization	16 bits/2 channels or 16 bits/4 channels
Headroom	20/18/16/12 dB (selectable)
Frequency response	20 Hz to 20 kHz +0.5/-1.0 dB (0 dB at 1 kHz)
Dynamic range	90 dB or more
Distortion	0.05% or less (at 1 kHz)

## Input connectors

### Digital video inputs

HDSI INPUT	BNC type (×1), complying with SMPTE 292M
SDSDI INPUT (with PDBK-104 option board installed)	BNC type (×1), complying with SMPTE 259M
i.LINK (HDV 1080i) (with PDBK-102 option board installed)	6-pin type (×1), complying with IEEE 1394

### Analog video inputs

REF VIDEO INPUT	BNC type (×2, loop-through) HD Tri-level sync or SD composite sync (0.3 Vp-p/75Ω/sync negative)
COMPOSITE VIDEO INPUT (with PDBK-104 option board installed)	BNC type (×1)
HD COMPONENT VIDEO INPUT (with PDBK-103 option board installed)	BNC type (×4)

### Analog audio inputs

AUDIO INPUT 1/3, 2/4	XLR 3-pin, female (×2), +4/0/-3/-6 dBu (selectable), 10 kΩ, balanced
----------------------	--

### Digital audio inputs

DIGITAL AUDIO (AES/EBU) INPUT	BNC type (×2), 1/2ch, 3/4ch complying with AES-3id-1995
-------------------------------	---

### Timecode input

TIME CODE IN	BNC type (×1), SMPTE timecode, 0.5 to 18 Vp-p, 3.3 kΩ, unbalanced
--------------	---

## Output connectors

### Digital video outputs

HDSI OUTPUT	BNC type (×2), complying with SMPTE 292M
SDSDI OUTPUT	BNC type (×1), complying with SMPTE 259M
i.LINK (HDV 1080i) (with PDBK-102 option board installed)	6-pin type, complying with IEEE 1394

### Analog video outputs

COMPOSITE OUT	BNC type (×1), 1.0 Vp-p, 75 Ω, sync negative
---------------	--

Phono jack (×1), 1.0 Vp-p, 75 Ω, sync negative

#### MONITOR OUT

D-sub 15-pin (RGB or YPbPr)

#### Analog audio outputs

##### AUDIO OUTPUT 1/3, 2/4

XLR 3-pin, male (×2), +4/0/−3/−6 dBu (selectable), 600 Ω, balanced

##### AUDIO MONITOR

Phono jack (×2) −∞ to +1 dBu/47 kΩ/unbalanced (L, R, L+R)

##### PHONES

Stereo phone jack (×1), −∞ to −14 dBu, 8 Ω, unbalanced

#### Digital audio outputs

##### DIGITAL AUDIO (AES/EBU) OUTPUT

BNC type (×2), 1/2 ch, 3/4 ch complying with AES-3id-1995

#### Timecode output

##### TIME CODE OUT

BNC type (×1), SMPTE timecode, 2.2 Vp-p ±3 dB, 600 Ω, unbalanced

#### Remote control connectors

REMOTE(9P) D-sub 9-pin, female (×1), complying with RS-422A

RS232C D-sub 9-pin, male (×1)

Ⓜ S400 6-pin (×1), complying with IEEE 1394

CONTROL Mini-jack 4-pole (×1), for connection of RM-LG2

Ⓜ Network (with PDBK-101 option board installed)

RJ-45 type (×1)

1000Base-T: complying with IEEE 802.3ab

100Base-TX: complying with IEEE 802.3u

10Base-T: complying with IEEE 802.3

#### Accessories supplied

Vertical installation stand (2)

Operating Instructions

English version (1)

Japanese version (1)

CD-ROM manual (1)

Infrared remote commander (1)

Ferrite core (part number 1-500-824-2X) (4)

PDZ-1 Proxy Browsing Software (1)

Warranty Booklet (1)

#### Accessories not supplied

AC power cord

- For the customers in the U.S.A and Canada  
Part number 1-551-812-41 (125 V, 10 A, about 2.4 m)

- For the customers in the United Kingdom  
Part number 1-777-823-12 (250 V, 10 A, about 2.0 m)
- For the customers in European countries other than the United Kingdom  
Part number 1-551-631-61 (250 V, 10 A, about 2.0 m)

Protocol Manual (part number 9-968-084-0X)

PDBK-101 Network Board

PDBK-102 MPEG-TS Input/Output Board

PDBK-103 Analog HD Input Board

PDBK-104 SD Input Upconverter Board

Design and specifications are subject to change without notice.

#### Notes

- Always make a test recording, and verify that it was recorded successfully. SONY WILL NOT BE LIABLE FOR DAMAGES OF ANY KIND INCLUDING, BUT NOT LIMITED TO, COMPENSATION OR REIMBURSEMENT ON ACCOUNT OF FAILURE OF THIS UNIT OR ITS RECORDING MEDIA, EXTERNAL STORAGE SYSTEMS OR ANY OTHER MEDIA OR STORAGE SYSTEMS TO RECORD CONTENT OF ANY TYPE.
- Always verify that the unit is operating properly before use. SONY WILL NOT BE LIABLE FOR DAMAGES OF ANY KIND INCLUDING, BUT NOT LIMITED TO, COMPENSATION OR REIMBURSEMENT ON ACCOUNT OF THE LOSS OF PRESENT OR PROSPECTIVE PROFITS DUE TO FAILURE OF THIS UNIT, EITHER DURING THE WARRANTY PERIOD OR AFTER EXPIRATION OF THE WARRANTY, OR FOR ANY OTHER REASON WHATSOEVER.

# Using UMID Data

Metadata is additional information recorded on discs along with audio-visual data. It is used to bring greater efficiency to the flow of operations from material acquisition through editing, and to make it easier to find and reuse material. As one of application of metadata, the UMID has been internationally standardized.

## What is a UMID?

A UMID (Unique Material Identifier) is a unique identifier for audio-visual material defined by the SMPTE 330M-2003 standard.

A UMID may be either as a 32-byte Basic UMID or an Extended UMID, which includes an additional 32 bytes of Source Pack to make a total 64 bytes.

*For details, refer to SMPTE 330M.*

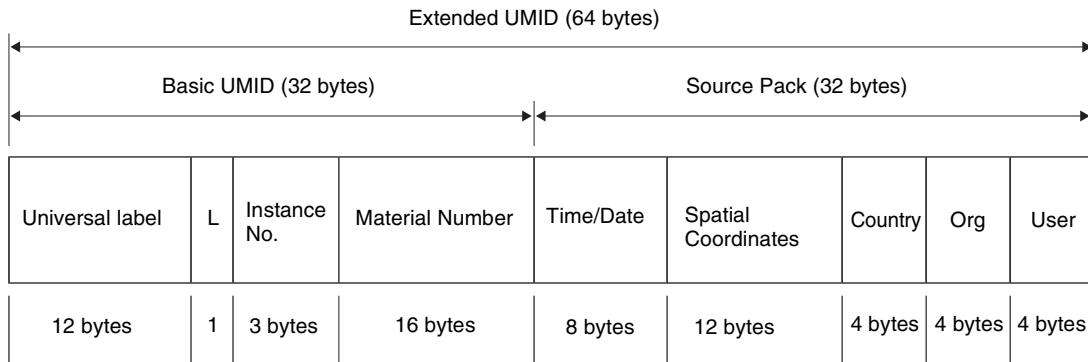

A globally unique ID is automatically recorded for every clip.

The Extended UMID is metadata that provides additional information such as location, time/date, company ID and so on.

The UMID is applied as follows.

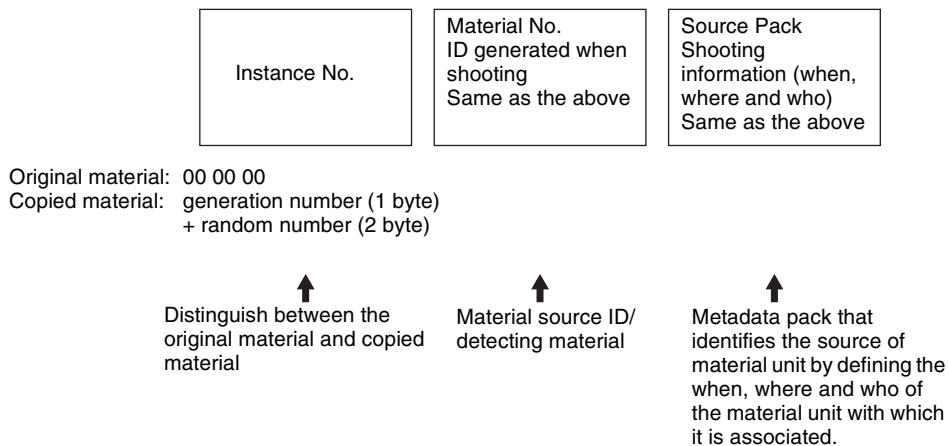

## Using the Extended UMID

You have to enter a country code, organization code and user code. Set the country code referring to the table in ISO 3166, and set the organization code and user code according to the guidelines of your organization.

*For details, see "Setting UMID ownership information" (page 119).*

## Functions of UMID data

UMID data enables the following:

- Addition of a globally unique ID to every clip of audio-visual material. The unique ID is used to detect the material source and to link it with the original source material.

- Distinguishing between original material and copied material. 00 is added to the Instance Number for original material.
- Recording with UTC time. UTC (coordinated universal time) is used when recording the UMID. Use of a universal time system enables uniform management of source material recorded all over the world.
- Calculation of date differences. Source material is recorded using modified Julian dates (MJD), which enables easy calculation of date differences between different source material items.

## Setting UMID ownership information

Proceed as follows.

- 1 Select METADATA >STORE OWNER in the setup menu (page 94).

The STORED OWNERSHIP (UMID ownership information setting) screen appears.

STORED OWNERSHIP	
COUNTRY	_
ORGANIZATION	_
USER	_
SHIFT: (←) (↑) (↓) (→)KEY	
INC/DEC: JOG DIAL	
TO MENU: MENU KEY	

**COUNTRY:** Sets the country code.

**ORGANIZATION:** Sets the organization code.

**USER:** Sets the user code

See the next item “About the UMID ownership information” for more information about these codes.

- 2 Set the ownership information using the arrow buttons and jog dial.

**Arrow buttons:** Select the item to set and the character input location (it blinks).

**Jog dial:** Selects characters to input at the selected location.

**RESET button:** Deletes all input data.

**To cancel the ownership information setting**

Press the MENU button.

- 3 Press the SET button.

The message “NOW SAVING...” appears, and the ownership information set in step 2 is saved.

See “System Menu” (page 83) in Chapter 6 for more information about system menu operations.

## About the UMID ownership information

### COUNTRY (country code)

Set the country code by entering an abbreviated alphanumeric string (4-byte alphanumeric string) according to the values defined in ISO 3166-1.

There are about 240 country codes.

Find your own country code on the following web page.

Refer to ISO 3166-1:

[http://www.din.de/gremien/nas/nabd/iso3166ma/codlstp1/en\\_listp1.html](http://www.din.de/gremien/nas/nabd/iso3166ma/codlstp1/en_listp1.html)

When the country code is less than 4 bytes, the active part of the code occupies the first part of the 4 bytes and the remainder must be filled with the space character (20h).

### Example: Japan

For Japan, the country code is JP, which is 2 bytes, or JPN, which is 3 bytes.

Thus, enter the following:

JP \_ \_

or

JPN \_

where \_ represents a space.

### ORGANIZATION (organization code)

Enter a 4-byte alphanumeric string for the organization code.

#### Notes

- There are no problems in recording or playing back audio-video signals, even if the ORGANIZATION is not set.
- Organization codes must be acquired by applying to the SMPTE registration office. When no organization code has been acquired, it is forbidden to enter an arbitrary string. As a rule, the code “00” must be entered. Freelance operators who do not belong to an origination should enter “~”.

### USER (user code)

Enter a 4-byte alphanumeric string to identify the user.

The user code is registered with each organization locally. It is usually not centrally registered.

When the user code is less than 4 bytes, enter the user code at the beginning of the 4 bytes and fill the remainder of the string with the space character (20H).

This user code is determined by the organization. The methods used depend on the organization.

#### Note

User code cannot be entered when no organization code has been entered.

---

# MPEG-4 Visual Patent Portfolio License

This product is licensed under the MPEG-4 Visual Patent Portfolio License for the personal and non-commercial use of a consumer for (i) encoding video in compliance with the MPEG-4 Visual Standard (“MPEG-4 Video”) and/or (ii) decoding MPEG-4 Video that was encoded by a consumer engaged in a personal and non-commercial activity and/or was obtained from a video provider licensed by MPEG LA to provide MPEG-4 Video. No license is granted or shall be implied for any other use. Additional information including that relating to promotional, internal and commercial uses and licensing may be obtained from MPEG LA, LLC.

See <http://www.mpegla.com>



# Glossary

## AES/EBU

A standard established jointly by the AES (Audio Engineering Society) and EBU (European Broadcasting Union) for serial transmission of digital audio. Two channels of audio can be transmitted via a single connector.

## Clip

A recording unit. Clips are created every time recording starts and stops.

## Clip list

A list of locations in the material recorded on the disc, arranged in any order. Clip lists can be created with the scene selection function of this unit, and with the supplied PDZ-1 Proxy Browsing Software.

## Composite video signal

A video signal in which luminance and chrominance are combined along with timing reference "sync" information to make composite video.

## Drop-frame mode

SMPTE time code runs at 30 frames/second, while the NTSC color television system runs at about 29.97 frames/second. Drop-frame mode adjusts the running of time code to eliminate the discrepancy between time code value and actual time by dropping two frames from the time code value at the beginning of each minute except every tenth minute.

## E-E mode

Electric-to-Electric mode. When you operate a VDR in E-E mode, input video and/or audio signals pass through electric circuits only and then come out from the output connectors, without passing through electromagnetic conversion circuits such as recording heads.

## Essence mark

A type of metadata that may be set for a specified frame. For more efficient searches, XDCAM equipment records essence

marks as part of Non-RealTime metadata, and uses them to display thumbnails.

## HD tri-level sync

An HDTV analog reference signal that applies to 59.94/50Hz systems. A sync signal defined in SMPTE 274M with positive, negative, and zero values.

## HDSDI signal

Abbreviation of HD Serial Digital Interface.

A signal in the HDTV serial interface defined by SMPTE 292M.

## i.LINK

Another name for the IEEE1394-1995 standards and their revisions. XDCAM uses the i.LINK interface to transfer DV streams by the AV/C protocol, and to read and write MPEG HD and DVCAM data files by FAM (file access mode).

## Metadata

Information about the properties of video and audio content. XDCAM records metadata such as UMIDs and essence marks, and the supplied PDZ-1 Proxy Browsing Software can be used to record information such as titles and comments.

## MXF

Material eXchange Format. A file exchange format developed by the Pro-MPEG Forum. Equipment from different manufacturers can exchange files in this format.

## Non-audio

General term for audio signals other than linear PCM, such as Dolby E<sup>1)</sup> and Dolby Digital (AC-3).<sup>1)</sup> XDCAM can record non-audio as an input signal.

<sup>1)</sup> Dolby is a trademark of Dolby Laboratories.

## Non-drop-frame mode

A mode of advancing time code which ignores the difference in frame values between real time and the time code. Using this mode produces a difference of approximately 86 seconds per day between real time and time code, which causes problems when editing programs in

units of seconds using the number of frames as a reference.

## Proxy AV data

Low-resolution data with a video bandwidth of 1.5 Mbps and an audio bandwidth of 64 kbps per channel. This unit records proxy AV data automatically whenever high-resolution MPEG HD or DVCAM data is recorded.

## Reference video signal

A video signal that contains a sync signal or sync and burst signals, used as a reference for synchronization of video equipment.

## SDSDI signal

SD Serial Digital Interface. An interface standardized as SMPTE 259M which enables the transmission of an uncompressed digital component stream.

## S/N

Signal-to-Noise ratio. The relation of the strength of the desired signal to the accompanying electronic interference, the noise. If S/N is high, sounds are reproduced with less noise and pictures are reproduced clearly without snow.

## Sub clip

One of the sections which make up a clip list. A sub clip may be part of a clip or an entire clip.

## Thumbnail image

A reduced still picture of video for display on a GUI screen. XDCAM creates thumbnail images from proxy video, and displays them as index pictures on GUI screens.

## Time code

A digitally encoded signal which is recorded with video data to identify each frame of the video by hour, minute, second and frame number. SMPTE time code is applied to NTSC system, and EBU time code to PAL and SECAM systems.

## UMID

Unique Material Identifier. A standard (SMPTE 330M) for video and audio metadata. The Basic section of a UMID contains a

globally unique number and a material number for the identification of recorded material. An optional section called the "Source Pack" contains information such as the time and location of recording. A UMID with the Basic section only is called a Basic UMID. A UMID with the Source Pack is called an Extended UMID.

### **User bits**

A total of 32 bits are provided in the time code which the user can use to record such information as date, reel number, or scene number on video tape or disc. Also called user's bits.

### **VBID (Video Blanking ID)**

This is a video ID signal, defined in the EIAJ CPR-1204 standard, which is inserted into VBS video output to enable the aspect ratio to be detected. The ID signal is inserted into line 20, VBI 283.



# Index

- A**
    - AC IN connector 20
    - ACCESS indicator 12
    - Alarms 107
    - Arrow buttons 16
    - Audio format 15
    - AUDIO INPUT 1/3 and 2/4 connectors 19
    - Audio level meters 15
    - Audio monitor channels 16
    - AUDIO MONITOR connectors 19
    - AUDIO OUTPUT 1/3 and 2/4 connectors 19
    - Audio recording
      - formats 43
      - levels 46
    - AV/C connection 26
  - B**
    - BVE-700/700A 29
  - C**
    - Camcorder connection 103
    - CH 1 to CH 4 knobs 16
    - CHAPTER button 14
    - Clip lists 59
      - adding sub clips 65
      - changing information 72
      - chapter function 65
      - creating 62
      - deleting 72
      - deleting sub clips 69
      - editing sub clips 67
      - expand function 65
      - including a clip selected in the thumbnail screen 62
      - loading a clip list from a disc into the current clip list 72
      - managing 71
      - modifying the in and out points of sub clips (trimming) 68
      - previewing 69
      - reordering sub clips 67
      - saving the current clip list 70
      - setting the start timecode 69
      - sorting 72
    - CLIP MENU button 13
    - Clip number 15
    - Clips 59
      - assigning clip titles 60
      - assigning user-defined names 60
      - deleting 55
      - lock 54
    - Component 25
    - COMPOSITE OUT connectors 18
    - Computer connection 101
    - Condensation 105
    - Connections and settings 24
      - connecting an external monitor 24
      - cut editing 26
      - editing control unit settings 29
      - using an editing control unit 27
      - viewing HD video 24
      - viewing SD video 25
    - CONTROL connector 20
    - Current clip list 59
    - Cut editing 26
  - D**
    - date and time settings 31
    - DIGITAL AUDIO (AES/EBU)
      - INPUT 1/2 and 3/4 connectors 19
      - OUTPUT 1/2 and 3/4 connectors 20
    - Digital hours meter 106
    - Directory structure 75
    - Disc capacity
      - remaining capacity 15
    - Disc menu 98
      - deleting all clips 100
      - deleting the most recent recorded clip 99
      - displaying 83
      - displaying the status of the current disc/clip 99
      - formatting a disc 100
      - operations 99
    - Disc recorder connection 104
    - Disc slot 13
    - Discs 40
      - directory structure 75
      - ejecting with the unit powered off 114
      - formatting 41
      - loading and unloading 40
      - Remaining capacity 15
      - write-protecting 40
    - Display 14
      - adjusting of the brightness 31
    - DISPLAY button 14
  - E**
    - Editing control unit
      - settings 29
      - using 27
      - using an editing control unit 27
  - Editing functions of the recorder 27
    - connections using the i.S400 connector 28
    - connections using the REMOTE (9P) connector 27
  - EJECT button 13
  - END button 17
  - Error Messages 114
  - ESSENCE MARK button 13
  - Essence marks
    - setting 46, 48
  - EXPAND button 14
  - External monitor 24
  - External Synchronization 30
- F**
    - F1 to F5 buttons 14
    - FAM connections 25, 78
      - to disable 80
    - Features 9
    - Ferrite core 29
    - File Access Mode 78
    - File operations 75
      - FAM connections 78
      - file access mode 78
      - operating on files 79
    - Formatting a disc 41
    - Front panel 12
    - FTP connection 101
    - Full salvage 42
    - Function menu 15, 81
      - displaying 81
      - operations 81
      - settings 81
  - G**
    - Ground terminal (signal) 21
  - H**
    - HD video view 24
    - HDSDI INPUT connector 19
    - HDSDI OUTPUT connectors 19
    - HDV connection 102
  - I**
    - i.LINK 114
      - connection 25
    - i.S400 connector 21
    - Important notes on operation 105
    - IN button 16
    - IN indicator 16
    - Infrared Remote Commander 21
    - Infrared sensor 13

## J

- JOG button 17
- Jog dial 17
- Jog/shuttle transport indicators 17

## K

- KEY INH 15
- KEY INH button 14
- Key operation inhibit mode 15

## L

- LEVEL knob 13
- Loading and unloading a disc 40

## M

- MARK1 button 16
- MARK2 button 16
- MENU button 13
- Menus 81
- MONITOR connector 18
- Monitor video display section 14
- MPEG HD 9

## N

- Names and functions of parts 12
- NEXT button 17
- Nonlinear editing system 26

## O

- On/standby switch and indicator 12
- Option boards 11, 101
  - PDBK-101 101
  - PDBK-102 102
  - PDBK-103 103
  - PDBK-104 104
- OUT button 16
- OUT indicator 16

## P

- PAGE button 14
- PDBK-101 101
- PDBK-102 102
- PDBK-103 103
- PDBK-104 104
- PDZ-1 74
  - using 25
- Periodic maintenance 106
- PHONES jack 13
- PLAY button 17
- Playback 40, 47
  - clip list 53
  - jog mode 48
  - normal open 47

- procedure 53
- recording essence marks 48
- repeat playback 53
- searching with essence marks 51
- searching with the chapter
  - function 52
- searching with the expand
  - function 50
- selecting a thumbnail image 49
- shuttle mode 48
- start position 47
- thumbnail search 49
- variable-speed mode 48
- POWER switch 20
- PREV button 17
- Proxy AV data 9
- Proxy browsing software 74

## Q

- Quick salvage 41

## R

- REC button 18
- REC INH 15
- Recording 40, 43
  - procedure 45
  - to adjust the audio recording levels 46
  - to record essence marks 46
  - to specify the frame to use as the thumbnail image 46
  - when recording does not end normally 41
- Recording inhibit mode 15
- Recording/playback format 15
- REF VIDEO INPUT connectors 18
- Reference signal 15
- REMOTE 15
- Remote commander 21
  - before use 22
  - replacing the lithium battery 22
- Remote connector selector switch 21
- Remote control switch 13
- Remote control unit 29
- Remote mode 15
- REMOTE(9P) connector 20
- REPEAT 15
- Repeat mode 15
- Repeat playback 53
- RESET button 13
- RM-280 29
- RS232C connector 20

## S

- Salvage functions 41
- Scene selection 57

- quick scene selection 65
- SD video view 25
- SDSDI OUTPUT connector 19
- Search
  - with essence marks 51
  - with the chapter function 52
  - with the expand function 50
  - with thumbnails 49

- SET button 13

- Setup 31

- Setup menu 84

- AUDIO CONTROL 93
- DISC PROTECTION 91
- DISPLAY CONTROL 88
- displaying 83
- displaying enhanced items 97
- INTERFACE SELECT 93
- items 86
- MENU GRADE 96
- METADATA 94
- OPERATIONAL FUNCTION 86
- operations 96
- returning the factory default settings 98
- SETUP BANK 95
- TIME CODE 90
- VIDEO CONTROL 91

- SHIFT button 13

- SHOT MARK1/2 46

- Shot marks

- deleting 52
- setting 46, 48

- SHUTTLE button 17

- Shuttle dial 17

- Specifications 115

- STANDBY button 18

- Status information (supplementary) 38

- STOP button 17

- SUB CLIP button 13

- Sub clips 59

- changing information 72
- deleting 69
- editing 67
- reordering 67

- Superimposed text information 37

- System frequency 15

- setting 23

- System line number 15

- System menu 83

## T

- Text information 37

- THUMBNAIL button 13

- Thumbnail image

- assigning sequence numbers 56

- changing 50
- displaying a list 49
- specifying the frame 46
- starting playback with 49
- Thumbnail search 49
  - changing an image 50
  - changing the clip information 49
  - displaying a list of thumbnail images 49
  - selecting an image 49
- TIME CODE IN connector 20
- TIME CODE OUT connector 20
- Time data display section 15
- Time data type 15
- Timecode 43
  - recording after setting an initial value 44
  - recording external timecode directly 45
  - recording sequentially upon the last recorded timecode 45
  - recording with the internal timecode generator synchronized to external timecode 45
- TOP button 17
- Troubleshooting 107

## U

- UMID Data 118
  - ownership information 119
- User bit values
  - setting 44

## V

- VAR button 17
- VARIABLE switch 16
- Variable-speed mode 48
- Video bitrates 9

## W

- Write-protecting discs 40

## Y

- Y/P<sub>B</sub>/P<sub>R</sub> 25

<http://www.sony.net/>

Sony Corporation

## Free Manuals Download Website

<http://myh66.com>

<http://usermanuals.us>

<http://www.somanuals.com>

<http://www.4manuals.cc>

<http://www.manual-lib.com>

<http://www.404manual.com>

<http://www.luxmanual.com>

<http://aubethermostatmanual.com>

Golf course search by state

<http://golfingnear.com>

Email search by domain

<http://emailbydomain.com>

Auto manuals search

<http://auto.somanuals.com>

TV manuals search

<http://tv.somanuals.com>