

Digital Video Camera Recorder

Operating Instructions

Before operating the unit, please read this manual thoroughly, and retain it for future reference.

Owner's Record

The model and serial numbers are located on the bottom. Record the serial number in the space provided below. Refer to these numbers whenever you call upon your Sony dealer regarding this product.

Model No. _____ Model No. AC- _____

Serial No. _____ Serial No. _____

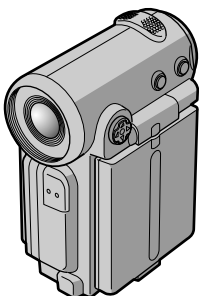

DCR-IP5/IP7BT

Network
Handycam IP
Digital
Handycam IP



MPEG MOVIE AD

Welcome!

Congratulations on your purchase of this Sony Handycam. With your Handycam, you can capture life's precious moments with superior picture and sound quality. Your Handycam is loaded with advanced features, but at the same time it is very easy to use. You will soon be producing home video that you can enjoy for years to come.

WARNING

To prevent fire or shock hazard, do not expose the unit to rain or moisture.

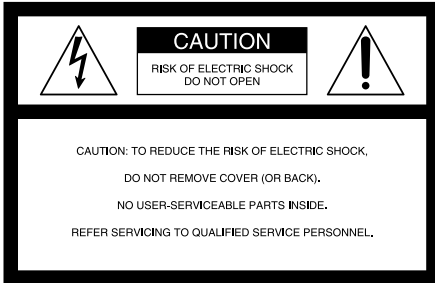

This symbol is intended to alert the user to the presence of uninsulated "dangerous voltage" within the product's enclosure that may be of sufficient magnitude to constitute a risk of electric shock to persons.



This symbol is intended to alert the user to the presence of important operating and maintenance (servicing) instructions in the literature accompanying the appliance.

For customers in the U.S.A. and CANADA

CAUTION

TO PREVENT ELECTRIC SHOCK, MATCH WIDE BLADE OF PLUG TO WIDE SLOT, FULLY INSERT.

DISPOSAL OF LITHIUM ION BATTERY. LITHIUM ION BATTERY. DISPOSE OF PROPERLY.

You can return your unwanted lithium ion batteries to your nearest Sony Service Center or Factory Service Center.

Note: In some areas the disposal of lithium ion batteries in household or business trash may be prohibited.

For the Sony Service Center nearest you call 1-800-222-SONY (United States only).

For the Sony Factory Service Center nearest you call 416-499-SONY (Canada only).

Caution: Do not handle damaged or leaking lithium ion battery.

DCR-IP7BT only

Countries and areas where you can use network functions are restricted. For details, refer to the separate Network Function Operating Instructions.

"Memory Stick" (DCR-IP7BT only)

This device complies with Part 15 of the FCC Rules. Operation is subject to the following two conditions: (1) This device may not cause harmful interference, and (2) this device must accept any interference received, including interference that may cause undesired operation.

This Class B digital apparatus complies with Canadian ICES-003.

For the Customers in the U.S.A.

If you have any questions about this product, you may call :
Sony Customer Information Center 1-800-222-SONY (7669)
The number below is for the FCC related matters only.
Regulatory Information

Declaration of Conformity

Trade Name: SONY
Model No.: DCR-IP5, DCR-IP7
Responsible Party: Sony Electronics Inc.
Address: 680 Kinderkamack Road,
Oradell, NJ 07649 U.S.A.

Telephone No.: 201-930-6972

This device complies with Part 15 of the FCC Rules. Operation is subject to the following two conditions.: (1) This device may not cause harmful interference, and (2) this device must accept any interference received, including interference that may cause undesired operation.

Note:

This equipment has been tested and found to comply with the limits for a Class B digital device, pursuant to Part 15 of the FCC Rules. These limits are designed to provide reasonable protection against harmful interference in a residential installation. This equipment generates, uses, and can radiate radio frequency energy and, if not installed and used in accordance with the instructions, may cause harmful interference to radio communications. However, there is no guarantee that interference will not occur in a particular installation. If this equipment does cause harmful interference to radio or television reception, which can be determined by turning the equipment off and on, the user is encouraged to try to correct the interference by one or more of the following measures:

- Reorient or relocate the receiving antenna.
- Increase the separation between the equipment and receiver.
- Connect the equipment into an outlet on a circuit different from that to which the receiver is connected.
- Consult the dealer or an experienced radio/TV technician for help.

CAUTION

You are cautioned that any changes or modifications not expressly approved in this manual could void your authority to operate this equipment.

Main Features

Taking moving or still images, and playing them back

- Recording a picture on a tape (p. 29)
- Recording a still image on a tape (p. 47)
- Playing back a tape (p. 39)
- Recording a still image on a “Memory Stick” (p. 118) (DCR-IP7BT only)
- Recording moving pictures on a “Memory Stick” (p. 126) (DCR-IP7BT only)
- Viewing a still image recorded on a “Memory Stick” (p. 137) (DCR-IP7BT only)
- Viewing a moving picture on a “Memory Stick” (p. 140) (DCR-IP7BT only)



Capturing images on your computer

- Viewing an image recorded on a tape using your computer via the i.LINK cable (p. 155)
- Viewing an image recorded on a “Memory Stick” using your computer via the USB cable (p. 156) (DCR-IP7BT only)

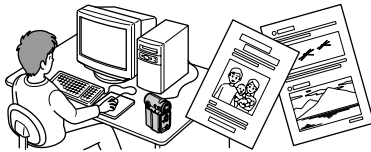

Accessing the Internet via a Bluetooth device (DCR-IP7BT only)

- Accessing the Internet and sending/receiving your e-mail. For details, refer to the network function operating instructions supplied with your camcorder.

Other uses

Functions to adjust exposure in recording mode

- Back light (p. 36)
- PROGRAM AE (p. 59)
- White balance (p. 62)
- Adjusting the exposure manually (p. 64)

Main Features

Functions to give an effect to your recordings

- Digital zoom (p. 102)
The default setting is set to OFF. (To zoom greater than 10×, set up the D ZOOM item in the menu settings.)
- Fader (p. 51)
- Picture effect (p. 54)
- Digital effect (p. 56)
- Title (p. 89, 95)
- MEMORY MIX (p. 132) (DCR-IP7BT only)

Functions to give a natural appearance to your recordings

- Manual focus (p. 65)
- Landscape mode (p. 59)

Functions used after recording

- END SEARCH (p. 38)
- DATA CODE (p. 41)
- Multi-picture search (p. 71)
- Title search (p. 75)
- Date search (p. 77)
- Photo search (p. 79)

Introduction – Basic operations

This section describes the basic operations used to control and ways to operate the camcorder.

How to turn on the power and select the mode

To supply power for the camcorder, see “Step 1 Preparing the power supply” on page 18.

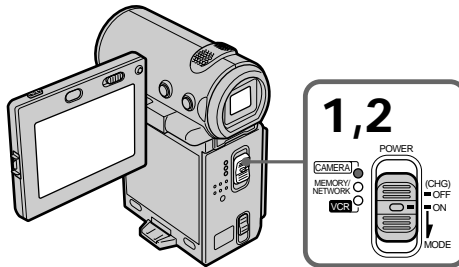

- (1) Slide the POWER switch down while pressing the small green button, then release your finger.
The camcorder is turned on, and then the camcorder turns to the CAMERA mode so that the CAMERA lamp lights up.
- (2) Slide the POWER switch down. Each time you slide it down, the mode changes as follows and corresponding mode lamp also lights up.
CAMERA Use this mode when you record on a tape.
MEMORY/NETWORK (DCR-IP7BT only)
 MEMORY: Use this mode when you record on a “Memory Stick,” or play back or edit an image in a “Memory Stick.”
 NETWORK: Use this mode when you use the network function. For details, refer to the supplied network function operating instructions.
VCR Use this mode when you play back or edit an image recorded on a tape or “Memory Stick” (A “Memory Stick” can only be used with the DCR-IP7BT).

Introduction – Basic operations

How to use the control button

Most of the operations are carried out using the control button. Select a button displayed on the screen using the control button, then press the center ● on the control button.

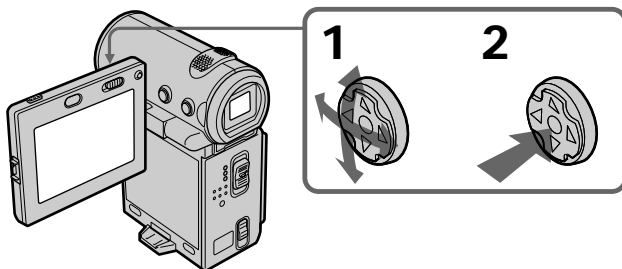

- (1) Press ▲/▼/◀/▶ on the control button repeatedly to select the desired button displayed on the screen.
The selected button turns orange.

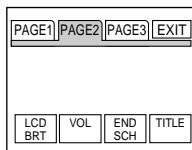

- (2) Press the center ● on the control button to enter the setting.
Repeat steps 1 and 2 to execute the function.

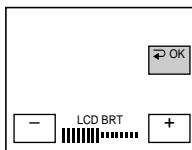

The procedure above is referred to as “Select [XXXX], then press the center ● on the control button” in this operating instructions.

When an item is selected

A green bar appears above the item.

If certain items are not available

The color of those items changes to gray.

Introduction – Basic operations

How to use the FN screen

If FN is not displayed on the screen, press DISPLAY or the center ● on the control button.

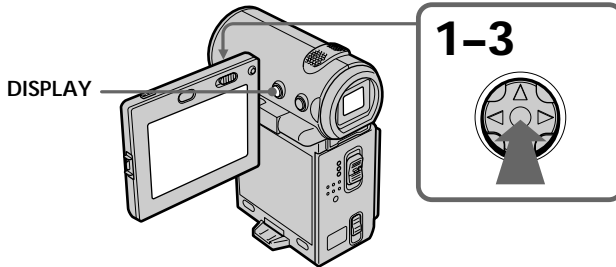

- (1) Select FN with ▲/▼/◀/▶ on the control button, then press the center ●. The FN screen appears.

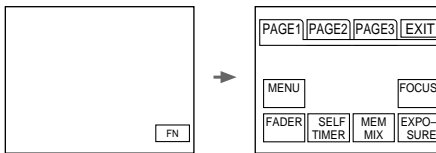

In CAMERA mode

- (2) To change the page, select PAGE1, PAGE2, or PAGE3 with ▲/▼/◀/▶ on the control button, then press the center ●. The PAGE1/PAGE2/PAGE3 screen appears.
- (3) Select the desired item with ▲/▼/◀/▶ on the control button, then press the center ●. The screen that corresponds to that button will appear, or that function will be executed.

To return to the FN screen

Select ↻ OK, then ↻ RETURN, or ↻ END with ▲/▼/◀/▶ on the control button, then press the center ●. Next, select EXIT with ▲/▼/◀/▶ on the control button, then press the center ●.

To execute settings

Select ↻ OK with ▲/▼/◀/▶ on the control button, then press the center ●. The display returns to the PAGE1/PAGE2/PAGE3 screen.

To cancel settings

Select ↻ OFF or AUTO with ▲/▼/◀/▶ on the control button, then press the center ●. The display returns to the PAGE1/PAGE2/PAGE3 screen.

















Introduction – Basic operations

The screen buttons on the PAGE1/PAGE2/PAGE3 screen

In CAMERA mode

PAGE1	MENU, FADER, SELFTIMER, MEM MIX*, EXPOSURE, FOCUS
PAGE2	LCD BRT, VOL, END SCH, TITLE
PAGE3	DIG EFFT, COUNT RESET

In VCR mode

PAGE1	MENU, VOL, TITLE, MULTI SRCH,  PB*,  ,  * ,   *
PAGE2	LCD BRT, DIG EFFT, END SCH,  PB*,  * ,  * ,   *
PAGE3	DATA CODE, COUNT RESET,  REC CTRL,  PB*,  * ,  * ,   *

* (DCR-IP7BT only)

See page 112 for the MEMORY/NETWORK mode (DCR-IP7BT only).

To turn on/off the screen buttons

Press DISPLAY. However, the finder can be used only in mirror mode.

A screen where the FN button is displayed is referred to as the FN screen in this operating instructions.

Table of contents

Main Features	4
Introduction – Basic operations	6
Quick Start Guide	12

Getting started

Using this manual	14
Checking supplied accessories	16
Step 1 Preparing the power supply ...	18
Installing the battery pack	18
Charging the battery pack	19
Connecting to a wall outlet	21
Step 2 Setting the date and time	23
Step 3 Inserting a cassette	27

Recording – Basics

Recording a picture	29
Shooting backlit subjects – BACK LIGHT	36
Self-timer recording	37
Checking the recording – END SEARCH	38

Playback – Basics

Playing back a tape	39
Viewing the recording on the TV screen	45

Advanced Recording Operations

Recording a still image on a tape – Tape Photo recording	47
Using the wide mode	49
Using the fader function	51
Using special effects – Picture effect ..	54
Using special effects – Digital effect ...	56
Using the PROGRAM AE function	59
Adjusting the white balance manually	62
Adjusting the exposure manually	64
Focusing manually	65

Advanced Playback Operations

Playing back a tape with picture effects	67
Playing back a tape with digital effects	69
Searching for a scene – Multi-picture search	71
Searching the boundaries of recorded tape by title – Title search	75

Searching a recording by date – Date search	77
Searching for a photo – Photo search	79

Editing

Dubbing a tape	81
Recording a program	84
Superimposing a title	89
Making your own titles	95
The Micro Cassette Memory	98

Customizing Your Camcorder

Changing the menu settings	102
----------------------------------	-----

“Memory Stick” Operations – DCR-IP7BT only

Using a “Memory Stick” – introduction	108
Recording still images on a “Memory Stick” – Memory Photo recording	118
Recording an image from a tape as a still image	123
Recording moving pictures on a “Memory Stick” – MPEG movie recording	126
Recording a picture from a tape as a moving picture	128
Superimposing a still image in a “Memory Stick” on a moving picture – MEMORY MIX	132
Copying still images from a tape – Photo save	135
Viewing a still image – Memory photo playback	137
Viewing a moving picture – MPEG movie playback	140
Dubbing images recorded on the “Memory Stick” onto the tape ...	143
Enlarging still images recorded on a “Memory Stick” – Memory PB ZOOM	145
Playing back images in a continuous loop – SLIDE SHOW	147
Preventing accidental erasure – Image protection	149
Deleting images	150
Writing a print mark – PRINT MARK	154

Table of contents

Connecting with a computer

- Viewing images recorded on a tape
using your computer 155
- Viewing images recorded on a
“Memory Stick” using your
computer - DCR-IP7BT only 156

Network operation

- DCR-IP7BT only

- Accessing the network 162

Troubleshooting

- Types of trouble and their
solutions 164
- Self-diagnosis display 170
- Warning indicators and messages 171

Additional Information

- Compatible cassettes 173
- About the “InfoLITHIUM” battery
pack 174
- About i.LINK 176
- Using your camcorder abroad 178
- Maintenance information and
precautions 179
- Specifications 185

Quick Reference

- Identifying the parts and controls 187
- Index 194

Quick Start Guide



This guide introduces you to the basic operations for recording/playback. See the page in parentheses “ () ” for more information.

1 Connecting the power cord (p. 21)

Use the battery pack when using your camcorder outdoors (p. 18).

Open the jack cover.

AC power adaptor (supplied)

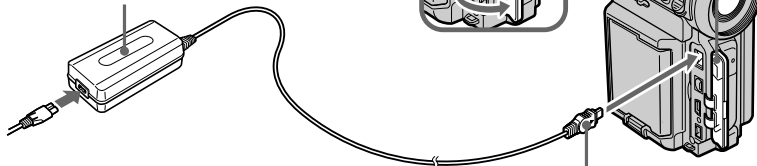

Connect the plug with its ▲ mark facing the lens side.

2 Inserting a cassette (p. 27)

- 1 Slide OPEN / ▲EJECT in the direction of the arrow and open the lid.



- 2 Push the middle portion of the back of the cassette to insert. Insert it in a straight line deeply into the cassette compartment with the window facing out.

- 3 Close the cassette compartment by pushing down the cassette lid halfway. After the cassette compartment goes down completely, close the lid until it clicks.

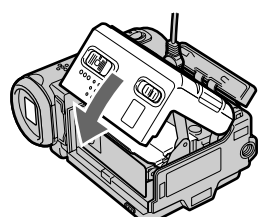
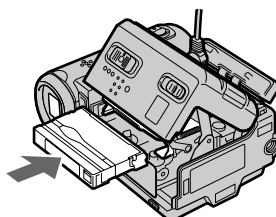
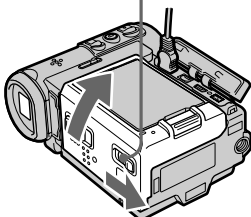

3 Recording a picture (p. 29)

- 1 Remove the lens cap.

- 2 Press OPEN to open the LCD panel.

Viewfinder

When the LCD panel is closed, pull out the viewfinder until it clicks and use it to monitor your recording.

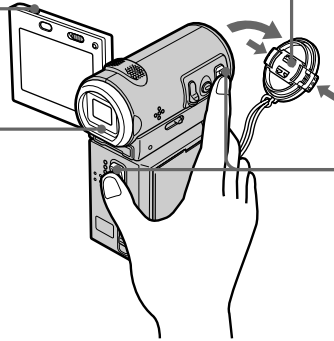

When you purchase your camcorder, the clock is not set up yet. Set up the clock before recording (p. 23).

- 3 Set the POWER switch to CAMERA. The CAMERA lamp lights up.

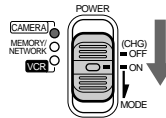



- 4 Press START/STOP. Your camcorder starts recording. To stop recording, press START/STOP again.

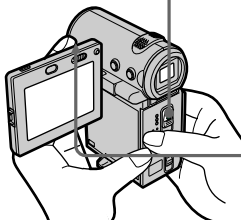
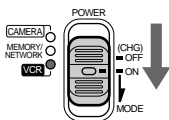

4 Monitoring the playback picture on the LCD screen (p. 39)

- 1 Set the POWER switch to VCR. The VCR lamp lights up.



- 2 Select , then press the center ● on the control button to rewind the tape.



- 3 Select , then press the center ● on the control button to start playback.



NOTE

Do not pick up your camcorder by holding the viewfinder, the LCD panel, the battery pack, or the jack cover.

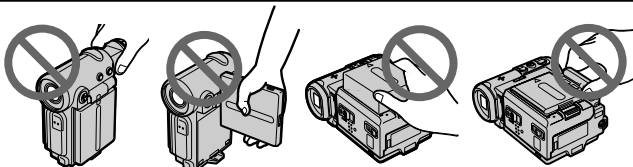

Using this manual

The instructions in this manual are for the two models listed in the table below. Before you start reading this manual and operating your camcorder, check the model number by looking at the bottom of your camcorder (The DCR-IP7BT is marked as “DCR-IP7” on the bottom of the unit). The DCR-IP7BT is the model used for illustration purposes. Otherwise, the model name is indicated in the illustrations. Any differences in operation are clearly indicated in the text, for example, “DCR-IP7BT only.”

As you read through this manual, buttons and settings on your camcorder are shown in capital letters.

e.g. Set the POWER switch to CAMERA.

When you carry out an operation, you can hear a beep or melody sound to indicate that the operation is being carried out.

Type of difference

DCR-	IP5	IP7BT
MEMORY/NETWORK mark ¹⁾ (on the POWER switch)	—	●

- Provided
- Not provided

¹⁾ The models with MEMORY/NETWORK marked on the POWER switch is provided with memory and network functions. See page 162 for details.

Note on the MICROMV format

Your camcorder is based on the MICROMV format. You can only use MICROMV cassettes with your camcorder.

- Records and plays back for about 60 minutes with equal quality when compared to DV (digital video).
- The Micro Cassette Memory feature is provided with all MICROMV cassettes. The camcorder can access any scene easily using the memory (Multi-picture search function).
- Adopts the MPEG2 format as a data compression method. This format is the same as the one for DVD (digital video disc).

Note on TV color systems

TV color systems differ from country to country. To view your recordings on a TV, you need an NTSC system-based TV.

Copyright precautions

Television programs, films, video tapes, and other materials may be copyrighted. Unauthorized recording of such materials may be contrary to the provision of the copyright laws.

Precautions on camcorder care

Lens and LCD screen/finder (on mounted models only)

- The LCD screen and the finder are manufactured using extremely high-precision technology, so over 99.99% of the pixels are operational for effective use. However, there may be some tiny black points and/or bright points (white, red, blue or green in color) that constantly appear on the LCD screen and the finder. These points are normal in the manufacturing process and do not affect the recording in any way.
- Do not let your camcorder get wet. Keep your camcorder away from rain and sea water. Letting your camcorder get wet may cause your camcorder to malfunction. Sometimes this malfunction cannot be repaired [a].
- Never leave your camcorder exposed to temperatures above 60°C (140°F), such as in a car parked in the sun or under direct sunlight [b].
- Be careful when placing the camcorder near a window or outdoors. Exposing the LCD screen, the finder or the lens to direct sunlight for long periods may cause malfunctions [c].
- Do not directly shoot the sun. Doing so might cause your camcorder to malfunction. Take pictures of the sun in any low light conditions such as dusk [d].

[a]



[b]

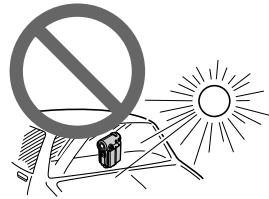

[c]

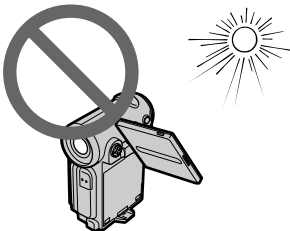



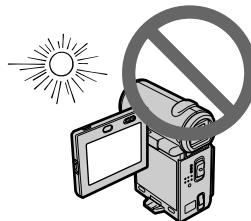

[d]

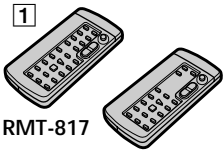
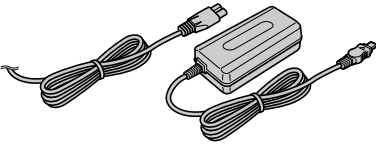
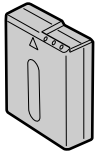
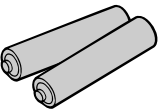
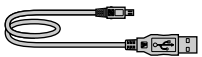

Checking supplied accessories

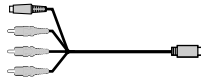
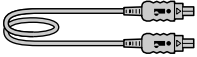
Make sure that the following accessories are supplied with your camcorder.

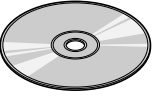
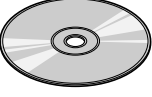
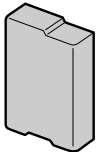
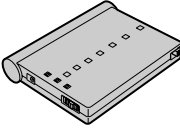
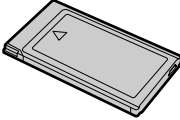
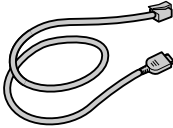
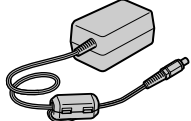
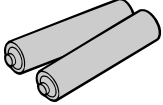
<p>1</p>  <p>RMT-817 or RMT-818</p>	<p>2</p> 	<p>3</p> 	
<p>4</p> 	<p>5</p> 	<p>6</p> 	<p>7</p> 
<p>8</p> 	<p>9</p> 	<p>10</p> 	<p>11</p> 
<p>12</p> 	<p>13</p> 	<p>14</p> 	<p>15</p> 
<p>16</p> 	<p>17</p> 		

Checking supplied accessories

- | | |
|--|---|
| 1 Wireless Remote Commander (1)
(p. 192)
RMT-817: DCR-IP7BT
RMT-818: DCR-IP5 | 11 CD-ROM (Movie Shaker Ver. 3.1 for
MICROMV) (1) (p. 155) |
| 2 AC-L20A AC power adaptor (1), the
power cord (1) (p. 19) | 12 Battery terminal cover (1) (p. 18) |
| 3 NP-FF50 battery pack (1) (p. 18, 19) | 13 BTA-NW1 Modem Adaptor with
Bluetooth Function** (1) |
| 4 Size AA (R6) batteries for the Remote
Commander (2) (p. 192) | 14 MDM-5614G Modem card** (1) |
| 5 USB cable* (1) (p. 157) | 15 Modem cable** (1) |
| 6 "Memory Stick"* (1) (p. 108) | 16 AC-PT1 AC power adaptor** (1) |
| 7 A/V connecting cable (1) (p. 45) | 17 Size AA (R6) alkaline dry batteries for
Modem Adaptor with Bluetooth
Function** (2) |
| 8 i.LINK cable (1) (p. 82) | |
| 9 Lens cap (1) (p. 29) | |
| 10 CD-ROM (SPVD-004 USB Driver)* (1)
(p. 157) | |

* DCR-IP7BT only.

** DCR-IP7BT only. For details, refer to the operating instructions of the Modem Adaptor with Bluetooth Function.

Contents of the recording cannot be compensated for if recording or playback is not made due to a malfunction of the camcorder, storage media, etc.

Step 1 Preparing the power supply

Installing the battery pack

We recommend that you use the battery pack when you use your camcorder outdoors.

- (1) While turning down the ▼BATT (battery) release lever in the direction of the arrow ❶, remove the battery terminal cover in the direction of the arrow ❷.
- (2) Install the battery pack in the direction of the arrow until it clicks.

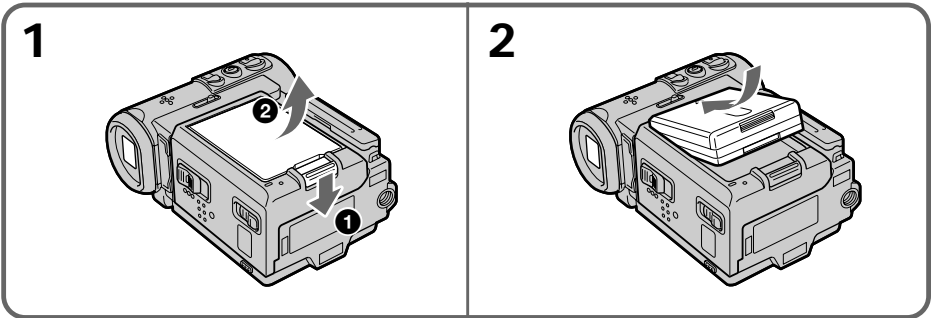

To remove the battery pack

The battery pack is removed in the same way as the battery terminal cover.

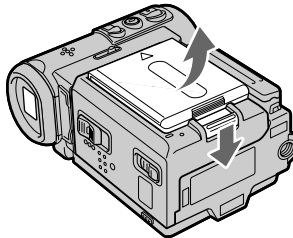

Note on the battery terminal cover

To protect the battery terminals, always install the battery terminal cover after the battery pack is removed.

Note on installing the battery pack

Make sure that the battery pack is properly installed. Check also the battery pack is not attached to the camcorder askew.

Step 1 Preparing the power supply

Charging the battery pack

Use the battery pack after charging it for your camcorder.
Your camcorder operates only with the "InfoLITHIUM" battery pack (F series).
See page 174 for details on the "InfoLITHIUM" battery pack.

- (1) Open the jack cover and connect the AC power adaptor supplied with your camcorder to the DC IN jack with the plug's ▲ mark facing the lens side.
- (2) Connect the power cord to the AC power adaptor.
- (3) Connect the power cord to a wall outlet.
- (4) Set the POWER switch to OFF (CHG).

The CHG lamp lights up when the charge begins. After the charge is completed, the CHG lamp goes out (full charge).

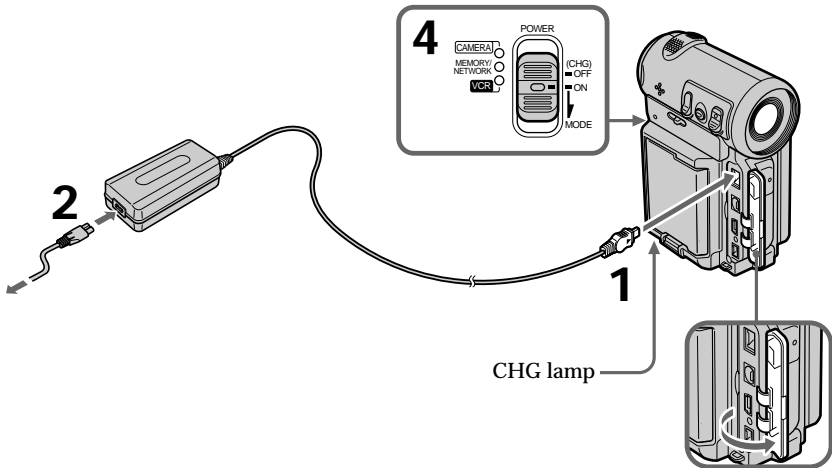

After charging the battery pack

Disconnect the AC power adaptor from the DC IN jack on your camcorder.

Note

Prevent metallic objects from coming into contact with the metal parts of the DC plug of the AC power adaptor. This may cause a short-circuit, damaging the AC power adaptor.

Step 1 Preparing the power supply

While the battery pack is being charged, the CHG lamp flashes in the following cases:

- The battery pack is not installed correctly.
- Something is wrong with the battery pack.

When you use the AC power adaptor

Place the AC power adaptor near the wall outlet. If any trouble occurs with this unit, disconnect the plug from the wall outlet as soon as possible to cut off the power.

Charging time

Battery pack	Full charge
NP-FF50 (supplied)	120
NP-FF70	150

The charging time may increase if the battery's temperature is extremely high or low because of the ambient temperature.

Approximate number of minutes at 25°C (77°F) needed to charge an empty battery pack

Recording time

Battery pack	Recording with the viewfinder		Recording with the LCD screen			
			Backlighting on		Backlighting off	
	Continuous*	Typical**	Continuous*	Typical**	Continuous*	Typical**
NP-FF50 (supplied)	80	45	65	35	80	45
NP-FF70	170	100	140	80	170	100

Approximate number of minutes of recording time when you use a fully charged battery

* Approximate continuous recording time at 25°C (77°F). The battery life will be shorter if you use your camcorder in a cold environment.

** Approximate number of minutes for recording while you repeat recording start/stop, zooming and turning the power on/off. The actual battery life may be shorter.

Playing time

Battery pack	Playing time on LCD screen	Playing time with LCD closed
NP-FF50 (supplied)	65	80
NP-FF70	135	165

Approximate number of minutes of playing time when you use a fully charged battery

Approximate continuous playing time at 25°C (77°F). The battery life will be shorter if you use your camcorder in a cold environment.

Step 1 Preparing the power supply

If the power runs out quickly even though sufficient remaining battery time is indicated

Fully charge the battery pack so that the correct battery remaining time will be indicated.

Recommended charging temperature

We recommend charging the battery pack in an ambient temperature of between 10 to 30°C (50 to 86°F).

What is "InfoLITHIUM"?

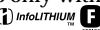
The "InfoLITHIUM" is a lithium ion battery pack which can exchange data such as battery consumption with compatible electronic equipment. This unit is compatible with the "InfoLITHIUM" battery pack (F series). Your camcorder operates only with the "InfoLITHIUM" battery. "InfoLITHIUM" F series battery packs have the  mark.

"InfoLITHIUM" is a trademark of Sony Corporation.

Connecting to a wall outlet

When you intend to use your camcorder for a long time, we recommend that you power it from a wall outlet using the AC power adaptor.

- (1) Open the jack cover and connect the AC power adaptor supplied with your camcorder to the DC IN jack on your camcorder with the plug's ▲ mark facing the lens side.
- (2) Connect the power cord to the AC power adaptor.
- (3) Connect the power cord to a wall outlet.

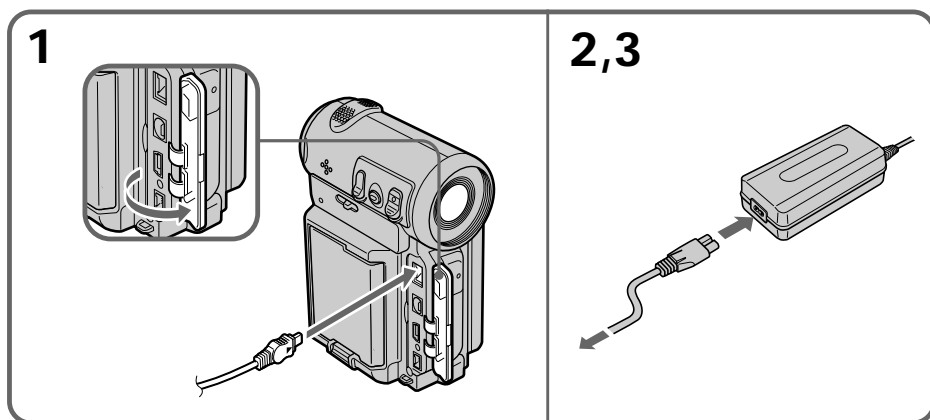

PRECAUTION

The set is not disconnected from the AC power source (house current) as long as it is connected to a wall outlet, even if the set itself has been turned off.

Step 1 Preparing the power supply

Notes

- The AC power adaptor cannot supply power if the battery pack is attached to your camcorder.
- The DC IN jack has “source priority.” This means that the battery pack cannot supply power when the power cord is connected to the DC IN jack, even when the power cord is not plugged into a wall outlet.

A car battery

You cannot use car batteries with the camcorder.

Step 2 Setting the date and time

Be sure to set the date and time when you use your camcorder for the first time. "CLOCK SET" will be displayed each time you set the POWER switch to CAMERA or MEMORY (DCR-IP7BT only) unless you set the date and time.

If you do not use your camcorder for about 3 months, the date and time settings may be erased (bars may appear) because the built-in rechargeable battery installed in your camcorder will have been discharged (p. 181).

First, set your area, then the daylight saving time, the year, the month, the day, the hour and then the minute.

- (1) Set the POWER switch to CAMERA or MEMORY (DCR-IP7BT only). The CAMERA or MEMORY lamp (DCR-IP7BT only) lights up.
- (2) Select FN, then press the center ● on the control button. The PAGE1 screen appears.
- (3) Select MENU, then press the center ● on the control button. The menu appears.
- (4) Select , then press the center ● or ► on the control button.
- (5) Select CLOCK SET, then press the center ● or ► on the control button.

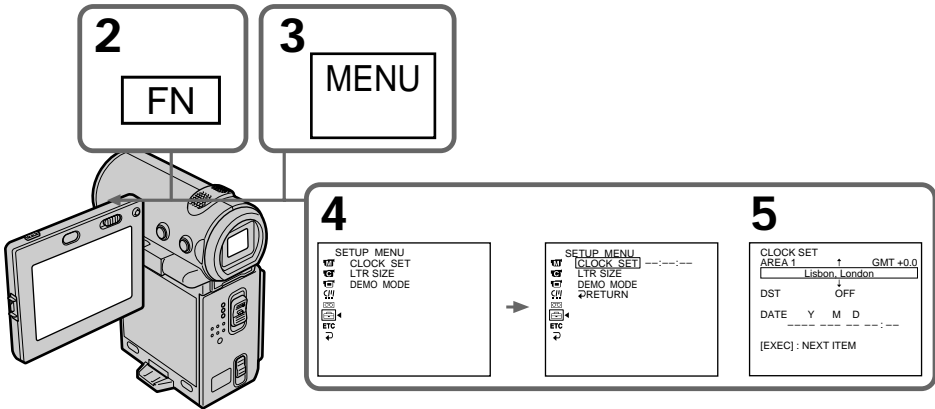

The illustration: In CAMERA mode

Step 2 Setting the date and time

- (6) Select your area, then press the center ● on the control button.
- (7) Select whether your area is in daylight saving time or not, then press the center ● on the control button.
When your area is in daylight saving time, select ON, when not in daylight saving time, select OFF.
- (8) Select the year, then press the center ● on the control button.
- (9) Set the month, day and hour with the same procedure as that in step 8.
- (10) Set the minute, and enter it using the time signal. The clock starts to move.
- (11) Press DISPLAY to turn off the menu. The clock setup is completed.

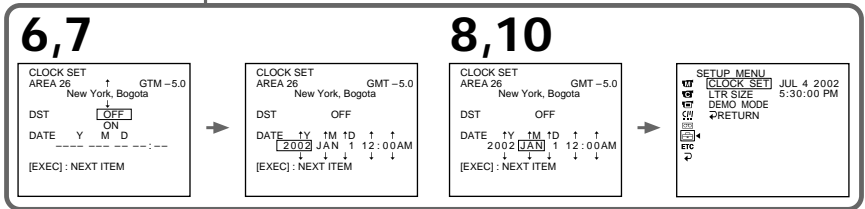
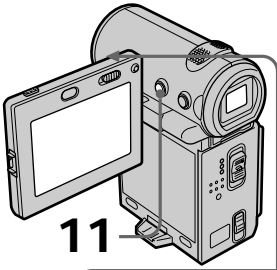

The illustration: In CAMERA mode

The year changes as follows:

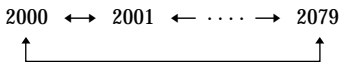

To return to the FN screen

Select , then press the center ● on the control button after step 10. The PAGE1 screen appears. Next, select EXIT, then press the center ● on the control button.

Step 2 Setting the date and time

Note

Instead of DST SET, SUMMERTIME is displayed on the screen for some models.

If you do not set the date and time

“-----” and “--:--:--” are recorded on the tape or the “Memory Stick” (DCR-IP7BT only) as the data code.

Note on the time indicator

The internal clock of your camcorder operates on a 12-hour cycle.

- 12:00 AM stands for midnight.
- 12:00 PM stands for noon.

Simple setting of clock by time difference

You can easily set the clock to the local time by setting a time difference. Set up the AREA SET and DST SET items in the menu settings.

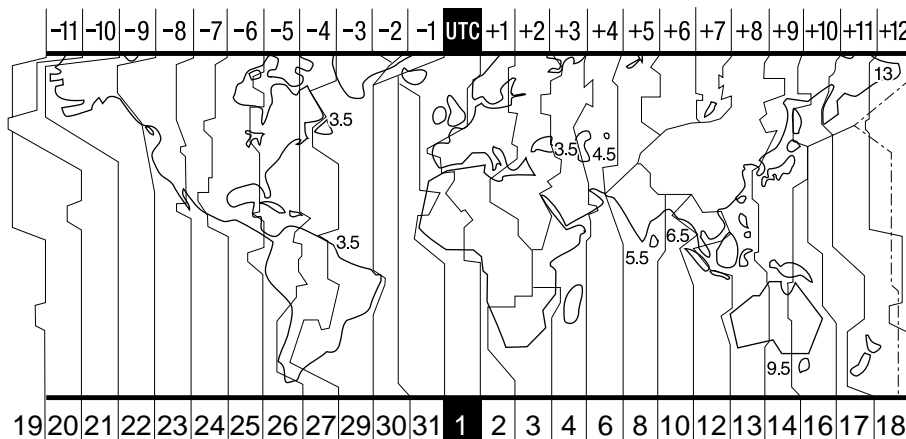

Step 2 Setting the date and time

Area code	Time-zone differences	Area setting
1	GMT	Lisbon, London
2	GMT+01:00	Berlin, Paris
3	GMT+02:00	Helsinki, Cairo
4	GMT+03:00	Moscow, Nairobi
5	GMT+03:30	Tehran
6	GMT+04:00	Abu Dhabi, Baku
7	GMT+04:30	Kabul
8	GMT+05:00	Karachi, Islamabad
9	GMT+05:30	Calcutta, New Delhi
10	GMT+06:00	Almaty, Dhaka
11	GMT+06:30	Rangoon
12	GMT+07:00	Bangkok, Jakarta
13	GMT+08:00	HongKong, Singapore
14	GMT+09:00	Seoul, Tokyo
15	GMT+09:30	Adelaide, Darwin
16	GMT+10:00	Melbourne, Sydney
17	GMT+11:00	Solomon Is
18	GMT+12:00	Fiji, Wellington

Area code	Time-zone differences	Area setting
19	GMT-12:00	Eniwetok, Kwajalein
20	GMT-11:00	Midway Is., Samoa
21	GMT-10:00	Hawaii
22	GMT-09:00	Alaska
23	GMT-08:00	LosAngeles, Tijuana
24	GMT-07:00	Denver, Arizona
25	GMT-06:00	Chicago, MexicoCity
26	GMT-05:00	New York, Bogota
27	GMT-04:00	Santiago
28	GMT-03:30	St. John's
29	GMT-03:00	Brasilia, Montevideo
30	GMT-02:00	Fernando de Noronha
31	GMT-01:00	Azores

To set your local time

Select AREA from the menu, then press the center ● or ► on the control button. Next, select the country or area where you stay in, using the table above, then press the center ● on the control button.

Step 3 Inserting a cassette

- (1) Install the battery pack, or connect the AC power adaptor for the power supply (p. 18 to 22).
- (2) Slide OPEN/▲EJECT in the direction of the arrow and open the cassette lid. The cassette compartment automatically lifts up and opens.
- (3) Push the middle portion of the back of the cassette to insert it. Insert the cassette in a straight line deeply into the cassette compartment with the window facing out.
- (4) Close the cassette compartment by pushing down the cassette lid halfway. The cassette compartment automatically goes down.
- (5) After the cassette compartment goes down completely, close the lid until it clicks.

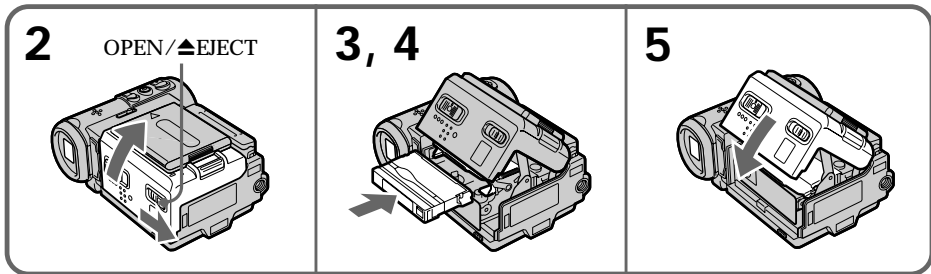

To eject the cassette

Follow the procedure above, and take out the cassette in step 3.

Notes

- Do not press the cassette compartment down firmly. Doing so may cause a malfunction.
- Before you open the cassette lid, be sure to disconnect the A/V connecting cable, i.LINK cable, and USB cable (DCR-IP7BT only). If you open the cassette lid without disconnecting the cables, the cables or plugs of the cables may be damaged.

To prevent accidental erasure

Slide the write-protect tab on the cassette to expose the red mark.

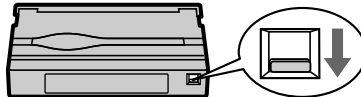

Step 3 Inserting a cassette

Note on the label

Labels may cause a malfunction of the camcorder. Therefore, be sure not to:

- Stick on any labels than the one supplied.
- Stick the label onto any part of the cassette other than the label position [a].

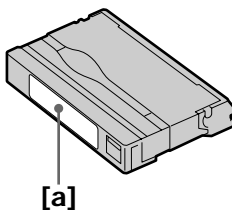

Recording a picture

Your camcorder automatically focuses for you.

- (1) Remove the lens cap and pull the lens cap string to fix it.
- (2) Install the power source. See “Step 1 Preparing the power supply” for more information (p. 18).
- (3) Insert a cassette. See “Step 3 Inserting a cassette” for more information (p. 27).
- (4) Press OPEN, then open the LCD panel.
- (5) Set the POWER switch to CAMERA. The CAMERA lamp lights up and your camcorder is set to the standby mode.
- (6) Press START/STOP. The STBY indicator flashes. Then, the REC indicator appears instead and the camcorder starts recording. The camera recording lamp located on the front of your camcorder lights up. To stop recording, press START/STOP again.

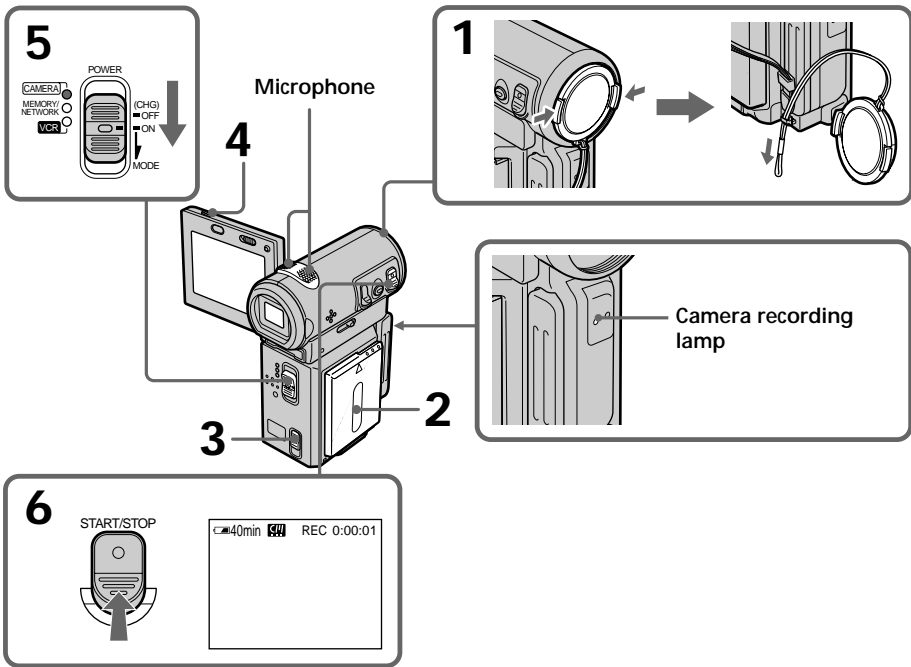

After recording

- (1) Set the POWER switch to OFF (CHG).
- (2) Close the LCD panel.
- (3) Eject the cassette.
- (4) Remove the power source.

Recording a picture

Note

Do not touch the built-in microphone during recording.

To enable unbroken transition

Transition between the last scene you recorded and the next scene is unbroken as long as you do not eject the cassette, even if you turn off your camcorder.

However, check the following:

- When you change the battery pack, set the POWER switch to OFF (CHG).

If you leave your camcorder in standby mode for 5 minutes while a cassette is inserted

Your camcorder automatically turns off. This is to save battery power and to prevent battery and tape wear. To resume the standby mode, set the POWER switch to OFF (CHG), and to CAMERA again. However, your camcorder does not turn off automatically when a cassette is not inserted.

Recording data

The recording data (date/time or various settings when recorded) are not displayed during recording. However, they are recorded automatically onto the tape. To display the recording data, press DATA CODE on the Remote Commander during playback. You can also use DATA CODE on the PAGE3 screen for this operation. (p. 41).

The usable battery time when you record using the LCD screen

The battery time is slightly shorter than the shooting time using the viewfinder.

While the STBY indicator is flashing

When you press START/STOP, the camcorder returns to standby. (The recording was not carried out.)

While the REC indicator is flashing

The START/STOP button does not work. Wait until the camcorder returns to standby. (The recording is being carried out while the REC indicator is flashing.)

Adjusting the angle of the LCD screen

The LCD panel can be rotated as illustrated below.

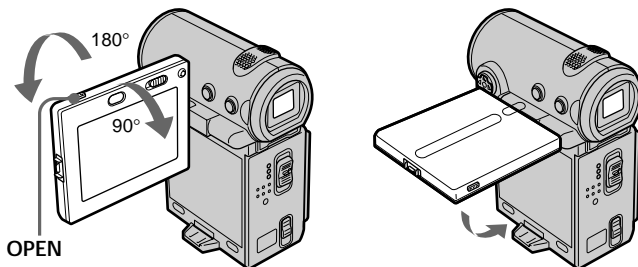

When you want to close LCD panel, set it horizontally, then swing it into the camcorder body.

Recording a picture

Note

When you use the LCD screen (except in the mirror mode), the viewfinder automatically turns off.

When you adjust the angle of the LCD panel

Make sure the LCD panel is opened up to 90 degrees.

Shooting with the mirror mode

This feature allows the camera subject to view himself-or herself on the LCD screen. The subject uses this feature to check his or her own image on the LCD screen while you look at the subject in the viewfinder.

In CAMERA or MEMORY (DCR-IP7BT only) mode.

Pull out the viewfinder, and open the LCD panel and rotate it as illustrated below.

The ☺ indicator appears in the viewfinder and on the LCD screen.

When the POWER switch is set to CAMERA, ■● appears in standby mode, and ● appears in recording mode. Some indicators appear mirror-reversed and others are not displayed.

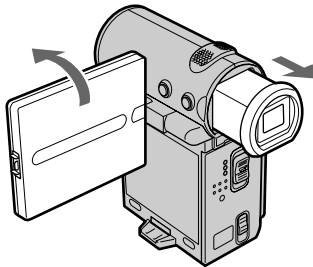

Pictures in the mirror mode

The picture on the LCD screen is a mirror-image. However, the picture will be normal when recorded.

During recording in the mirror mode

FN appears mirror-reversed in the viewfinder.

When you press the center ● on the control button when FN is displayed on the screen

The PAGE screen appears and the ☺ indicator is not displayed.

Recording a picture

Adjusting the brightness of the LCD screen

When recording in bright conditions, set the LCD BACKLIGHT switch to OFF.

- (1) In CAMERA, MEMORY (DCR-IP7BT only), playback, or playback pause mode, select FN, then press the center ● on the control button. The PAGE1 screen appears.
- (2) Select PAGE2, then press the center ● on the control button. The PAGE2 screen appears.
- (3) Select LCD BRT, then press the center ● on the control button. The screen used for adjusting the brightness of the LCD screen appears.
- (4) Select -/+, then press the center ● on the control button repeatedly to adjust the brightness.
-: to dim
+: to brighten
You can also adjust the brightness by pressing ◀/▶ repeatedly after you select -/+.
- (5) Press DISPLAY to clear the screen buttons.

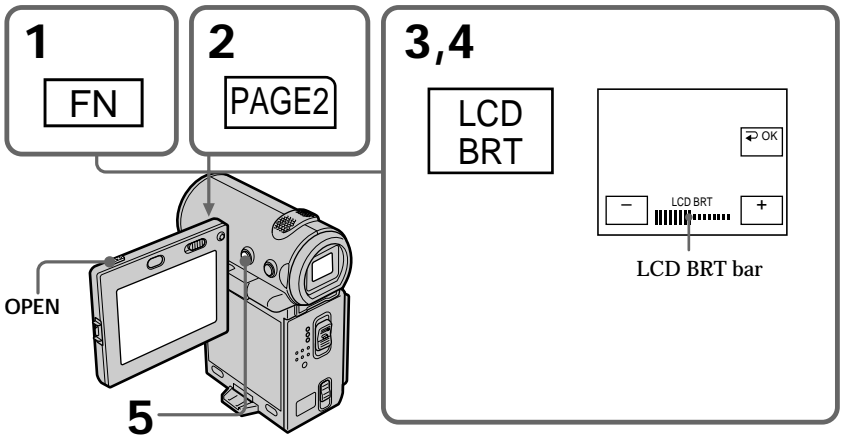

To return to the FN screen

Select ◀ OK, then press the center ● on the control button after step 4. The PAGE2 screen appears. Next, select EXIT, then press the center ● on the control button.

When FN is not displayed on the screen

Press DISPLAY or ● so that FN is displayed. You can also use DISPLAY on the Remote Commander.

Recording a picture

The color of the LCD screen

You can adjust it using the LCD COLOR item in the menu settings (p. 102).

Even if you adjust the screen using LCD BRT, LCD COLOR, or the LCD screen backlight

The recorded picture will not be affected.

The setting of the LCD BACKLIGHT switch

Normally, set it to ON. When you use the camcorder in bright conditions using the battery pack, set it to OFF. This position saves battery power.

Adjusting the viewfinder

If you record pictures with the LCD panel closed, check the picture with the viewfinder. Adjust the viewfinder lens to your eyesight so that the indicators in the viewfinder come into sharp focus.

Pull out the viewfinder and move the viewfinder lens adjustment lever.

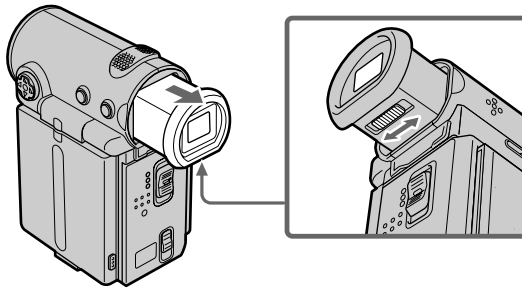

Viewfinder backlight

You can change the brightness of the backlight when using the battery pack. Set up the VF B.L. item in the menu settings (p. 102).

Even if you adjust the viewfinder backlight

The recorded picture will not be affected.

Recording a picture

Using the zoom feature

Push ZOOM up or down slightly for a slower zoom. Push it firmly for a faster zoom. Using the zoom function sparingly results in better-looking recordings.

“T” side: for telephoto (subject appears closer)

“W” side: for wide-angle (subject appears farther away)

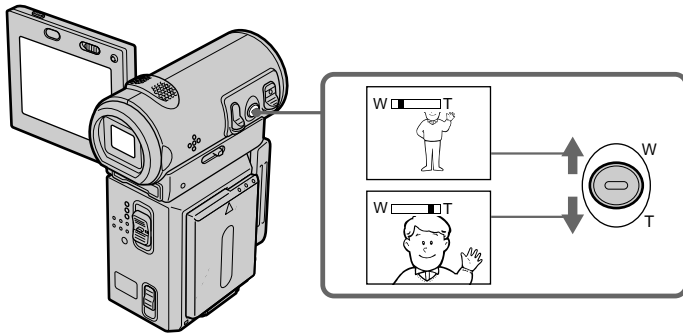

To use a zoom greater than 10×

A zoom greater than 10× is performed digitally. To activate digital zoom, set D ZOOM to 20× or 120× in the menu settings. The digital zoom function is set to OFF as a default setting (p. 102).

The right side of the bar shows the digital zooming zone.

The digital zooming zone appears when you set D ZOOM to 20× or 120× in the menu settings (p. 102)

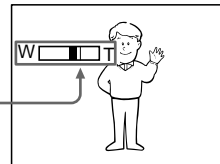

Note

During optical-zooming or when the zoom position is set to the “W”-end side, the SteadyShot function does not work.

When you shoot close to a subject

If you cannot get a sharp focus, push ZOOM toward the “W” side until the focus is sharp. You can shoot a subject that is at least about 80 cm (about 2 feet 5/8 inch) away from the lens surface in the telephoto position, or about 1 cm (about 1/2 inch) away in the wide-angle position.

Recording a picture

Notes on digital zoom

- Digital zoom allows you to set values up to 20× or 120×.
- The picture quality deteriorates as you push ZOOM down toward the “T” side.

When the POWER switch is set to MEMORY (DCR-IP7BT only)

You cannot use the digital zoom.

The indicators displayed in recording mode

The indicators are not recorded on the tape.

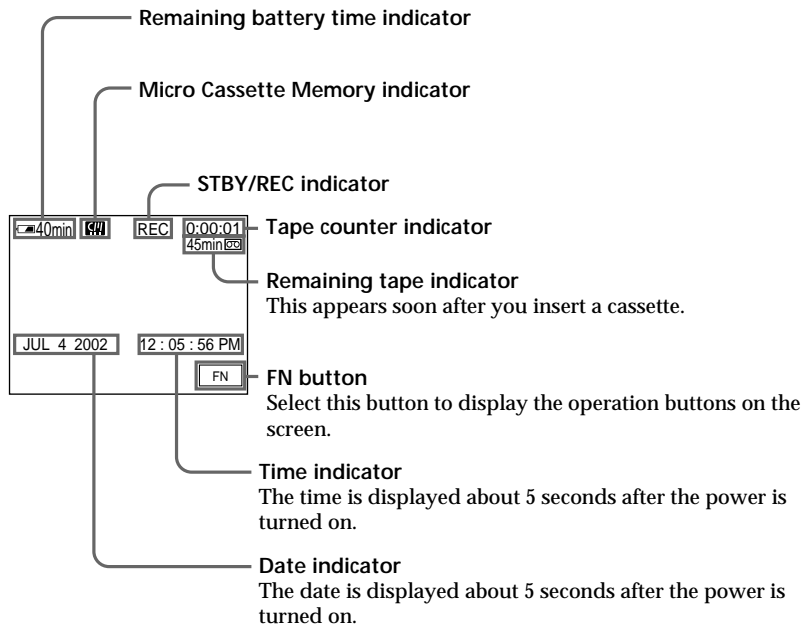

Remaining battery time indicator

The remaining battery time indicator roughly indicates the recording time. The indicator may not be correct, depending on the conditions under which you are recording. When you close the LCD panel and open it again, it takes about 1 minute for the correct remaining battery time in minutes to be displayed.

Tape counter

The tape counter can be reset using COUNT RESET on the PAGE3 screen via the FN screen.

Remaining tape indicator

The indicator may not be displayed accurately depending on the tape.

Recording a picture

Recording data

The recording data (date/time or various settings when recorded) are not displayed during recording. However, they are recorded automatically onto the tape. To display the recording data, press DATA CODE on the Remote Commander during playback. You can also use DATA CODE on the PAGE3 screen via the FN screen for this operation (p. 41).

Shooting backlit subjects - BACK LIGHT

When you shoot a subject with the light source behind the subject or a subject with a light background, use the backlight function.

Press BACK LIGHT in CAMERA or MEMORY (DCR-IP7BT only) mode.
The  indicator appears on the screen.
To cancel, press BACK LIGHT again.

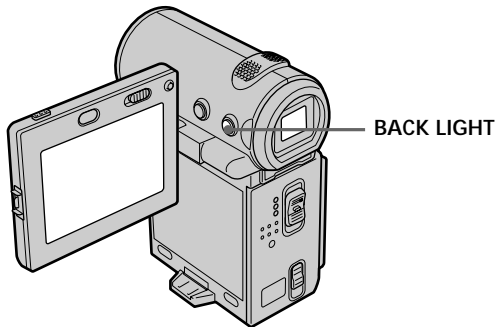

When the backlight function is activated

The backlight function will be canceled when you set EXPOSURE to MANUAL on the PAGE1 screen via the FN screen.

While the FN screen is displayed

The backlight function is deactivated.

Recording a picture

Self-timer recording

Recording with the self-timer starts automatically in 10 seconds. You can also use the Remote Commander for this operation.

- (1) In standby mode, select FN, then press the center ● on the control button. The PAGE1 screen appears.
- (2) Select SELF TIMER, then press the center ● on the control button. The ☺ (self-timer) indicator appears.
- (3) Press DISPLAY to turn off the screen buttons.
- (4) Press START/STOP.

Self-timer starts counting down from 10 with a beep sound. In the last 2 seconds of the countdown, the beep sound gets faster, then recording starts automatically.

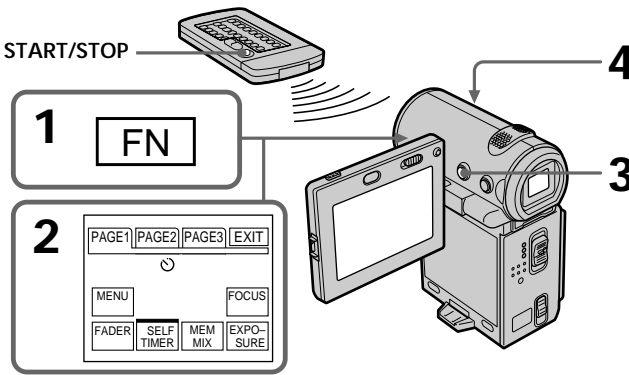

To stop the count down

Press START/STOP. To restart the countdown, press START/STOP again.

To record still images on a tape using the self-timer

Press PHOTO in step 4 (p. 48).

To cancel self-timer recording

Select SELF TIMER, then press the center ● on the control button in standby mode. The ☺ (self-timer) indicator disappears from the screen.

Note

The self-timer recording mode is automatically canceled when:

- The self-timer recording is finished.
- The POWER switch is set to OFF (CHG) or VCR.

When the POWER switch is set to MEMORY (DCR-IP7BT only)

You can also record a still image on the "Memory Stick" with the self-timer (p. 121).

Checking the recording – END SEARCH

You can go to the end of the last recorded point.

- (1) In standby mode, select FN, then press the center ● on the control button. The PAGE1 screen appears.
- (2) Select PAGE2, then press the center ● on the control button. The PAGE2 screen appears.
- (3) Select END SCH, then press the center ● on the control button.
The last 5 seconds of the recorded section are played back and your camcorder returns to the standby mode. You can monitor the sound from the speaker.

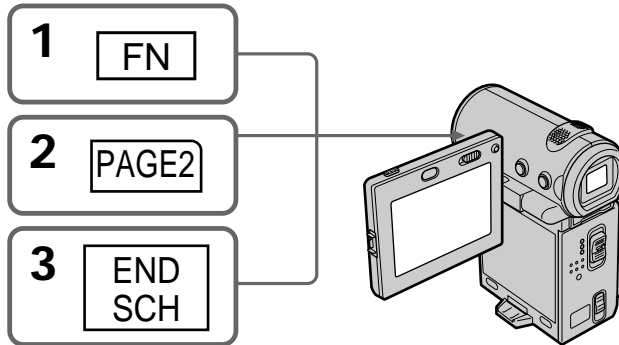

To return to the FN screen

Select EXIT, then press the center ● on the control button.

To stop searching



Select END SCH, then press the center ● on the control button again.

Even if you remove the cassette

The end search function works.

Playing back a tape

You can monitor the playback picture on the LCD screen. If you close the LCD panel, you can monitor the playback picture in the viewfinder. You can also control playback using the Remote Commander supplied with your camcorder.

- (1) Install the power source and insert a recorded tape.
- (2) Press OPEN to open the LCD panel.
- (3) Set the POWER switch to VCR. The camcorder turns on and the VCR lamp lights up.
- (4) Select , then press the center ● on the control button to rewind the tape.
- (5) Select , then press the center ● on the control button to start playback.
- (6) Adjust the volume following the procedure below.
 - ① Select FN, then press the center ● on the control button. The PAGE1 screen appears.
 - ② Select VOL, then press the center ● on the control button. The screen used for adjusting the volume appears.
 - ③ Select -/+ , then press the center ● on the control button repeatedly to adjust the volume.
 - : to turn down the volume
 - + : to turn up the volumeYou can adjust the volume by pressing ◀/▶ repeatedly after you select -/+.
- (7) Select  OK, then press the center ● on the control button. The PAGE1 screen appears.

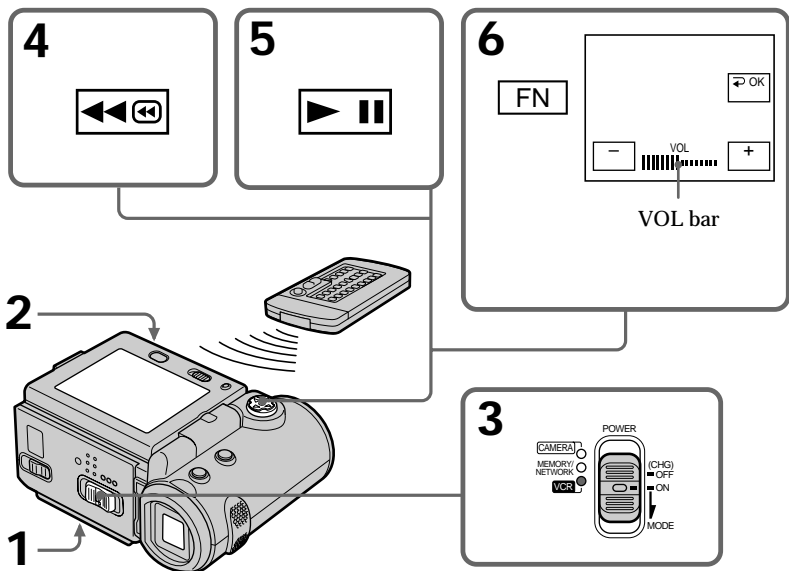

Playing back a tape

To return to the FN screen

Select EXIT, then press the center ● on the control button.

To stop playback

Select , then press the center ● on the control button.

When monitoring on the LCD screen

You can turn the LCD panel over and move it back to the camcorder body with the LCD screen facing out.

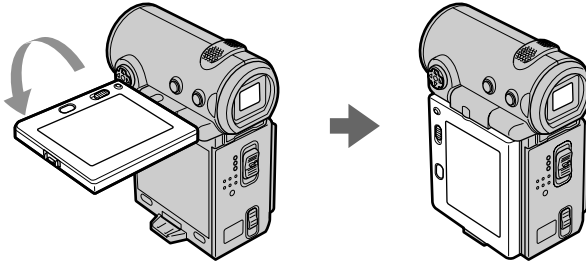

If you leave the power on for a long time

Your camcorder gets warm. However, this is not a malfunction.

When you open or close the LCD panel

Before you open or close the LCD panel return it to the position illustrated below.

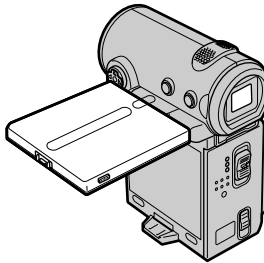

Note

Be careful not to touch the ▼BATT lever while you are playing back a tape. The battery pack may accidentally detached from the camcorder.

To display the screen indicators – Display function

Press DISPLAY on your camcorder or on the Remote Commander. The indicators being displayed disappear from the screen. To display the indicators, press DISPLAY again.

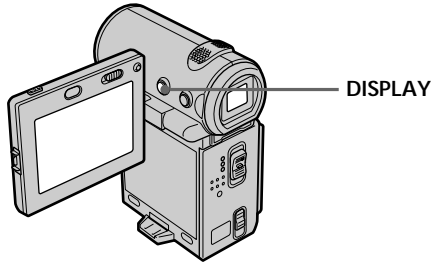

Using the data code function

Your camcorder automatically records not only images on the tape but also the recording data (date/time and various settings when recorded) (Data code). Follow the steps below to display the data code using the camcorder or the Remote Commander.

When using the camcorder

To display the data code

- (1) In playback or playback pause mode, select FN, then press the center ● on the control button. The PAGE1 screen appears.
- (2) Select PAGE3, then press the center ● on the control button. The PAGE3 screen appears.
- (3) Select DATA CODE, then press the center ● on the control button. The DATA CODE screen appears.

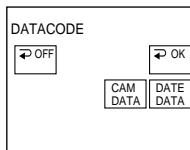

- (4) Select CAM DATA or DATE DATA, then press the center ● on the control button. The top of the selected button is indicated with a green bar.
- (5) Select → OK, then press the center ● on the control button.
- (6) Select EXIT, then press the center ● on the control button.

Playing back a tape

To clear the data code display

- (1) Select \leftarrow OFF, then press the center \bullet on the control button in step 4.
- (2) Select EXIT, then press the center \bullet on the control button. The data code disappears from the screen.

When using the Remote Commander

Press DATA CODE on the Remote Commander in playback or playback pause mode.

The display changes as follows:

date/time \rightarrow various settings (SteadyShot OFF, exposure, white balance, gain, shutter speed, aperture value) \rightarrow no indicator

To not display various settings while operating with the Remote Commander

Set DATA CODE via \leftarrow to DATE in the menu settings (p. 102).

The display changes as follows each time you press DATA CODE on the Remote Commander: date/time \leftrightarrow no indicator

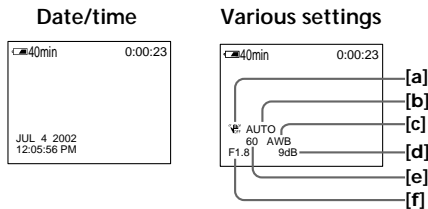

- [a] SteadyShot OFF indicator
- [b] Exposure mode indicator
- [c] White balance indicator
- [d] Gain indicator
- [e] Shutter speed indicator
- [f] Aperture value indicator

Various settings

Various settings is your camcorder's information when you recorded. In recording mode, the various settings are not displayed.

When you use the data code function, bars (-- --) appear if:

- A blank portion of the tape is being played back.
- The tape is unreadable due to tape damage or noise.
- The tape was recorded by a camcorder without the date and time set.
- The camcorder is in various playback modes.

Data code

When you connect your camcorder to a TV, the data code also appears on the TV screen.

Playing back a tape





Remaining battery time indicator during playback

The indicator shows the approximate continuous playback time. The indicator may not be correct, depending on the conditions in which you are playing back. When you close the LCD panel and open it again, it takes about 1 minute to display the correct remaining battery time.





Various playback modes

To operate the video control buttons, set the POWER switch to VCR.





To view a still image (playback pause)

- Select , then press the center  on the control button during playback. To resume normal playback, select , then press the center  on the control button again.
- Press PAUSE on the Remote Commander during playback. To resume normal playback, press PAUSE again.



To advance the tape

- Select , then press the center  on the control button when the tape is not being played back. To resume normal playback, select , then press the center  on the control button.
- Press FF on the Remote Commander when the tape is not being played back. To resume normal playback, press PLAY.





To rewind the tape

- Select , then press the center  on the control button when the tape is not being played back. To resume normal playback, select , then press the center  on the control button.
- Press REW on the Remote Commander when the tape is not being played back. To resume normal playback, press PLAY.

To locate a scene while monitoring the picture (picture search)

- Select  or , then keep pressing the center  on the control button during playback. To resume normal playback, release the button.
- Keep pressing REW or FF on the Remote Commander during playback. To resume normal playback, release the button.

To monitor the high-speed picture while advancing or rewinding the tape (skip scan)

- Select , then keep pressing the center  on the control button while rewinding the tape, or select , then keep pressing  while advancing the tape. To resume normal rewinding or advancing, release the button.
- Keep pressing REW on the Remote Commander while rewinding the tape, or keep pressing FF on the Remote Commander while advancing the tape. To resume normal rewinding or advancing, release the button.

To view the picture at slow speed (slow playback)





Press SLOW on the Remote Commander during playback. To pause playback, press PAUSE on the Remote Commander. To resume normal playback, press PLAY on the Remote Commander.

Playing back a tape

To search for the last scene recorded (END SEARCH)

Select END SCH on the PAGE2 screen through the FN screen, then press the center ● on the control button when the tape is not being played back. The camcorder plays back the last 5 seconds of the recorded section, then stops the playback.

Video control buttons of the camcorder

-  To play back or pause a tape
-  To stop a tape
-  To rewind a tape
-  To fastforward a tape

When the playback pause mode lasts for 5 minutes

The playback pause mode will be released, then the camcorder stops the playback. To resume playback, select , then press the center ● on the control button or press PLAY on the Remote Commander.

Viewing the recording on the TV screen

Connect your camcorder to your TV with the A/V connecting cable supplied with your camcorder to watch the playback picture on the TV screen. You can operate the video control buttons in the same way as when you monitor playback pictures on the camcorder screen. When monitoring the playback picture on the TV screen, we recommend that you power your camcorder from a wall outlet using the AC power adaptor (p. 21). Also, refer to the operating instructions of your TV.

Open the jack cover. Connect your camcorder to the TV using the A/V connecting cable. Then, set the TV/VCR selector on the TV to VCR.

The supplied A/V connecting cable is equipped with an S video plug and a video plug. Use either the S video plug or the video plug depending on the TV. Do not connect both of the plugs to the TV.

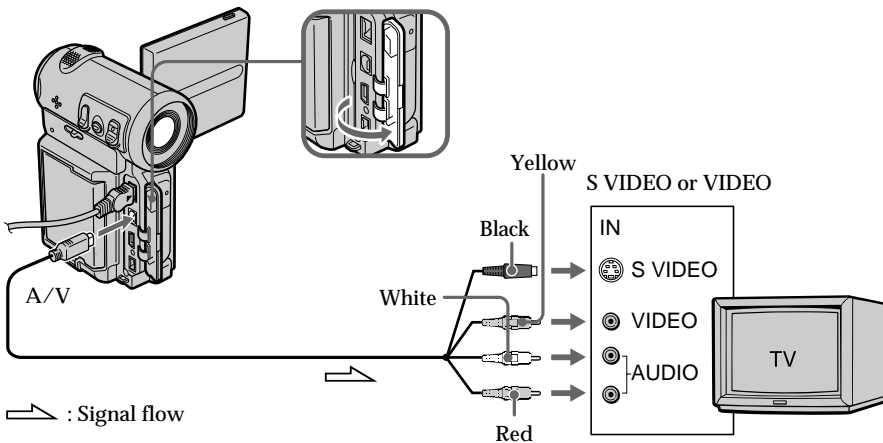

If your TV is already connected to a VCR

Connect your camcorder to the LINE IN input on the VCR using the A/V connecting cable supplied with your camcorder. Set the input selector on the VCR to LINE.

If your TV or VCR is a monaural type

Connect either the yellow or the black plug of the A/V connecting cable to the video or S video input jack and the white or red plug to the audio input jack on the VCR or the TV. If you connect the white plug, the sound is an L (left) signal. If you connect the red plug, the sound is an R (right) signal.

Viewing the recording on the TV screen

If your TV has an S video jack

Connect using the S video plug to faithfully obtain original pictures. With this connection, you do not need to connect the yellow (video) plug of the A/V connecting cable. Connect the S video plug to the S video jack on the TV or VCR. This connection produces higher quality MICROMV format pictures.

To display the screen indicators on the TV screen

Set DISPLAY via  to V-OUT/LCD in the menu settings (p. 102). You can turn on/off the screen indicators using the DISPLAY button.

Recording a still image on a tape - Tape Photo recording

You can record a still image onto a tape. This mode is useful when you want to print an image using a video printer (optional). You can record about 510 images on a 60-minute cassette.

Besides the operation described here, your camcorder can record still images on a "Memory Stick" (DCR-IP7BT only) (p. 118).

- (1) In standby mode, keep pressing PHOTO lightly until a still image appears. The CAPTURE indicator appears. Recording does not start yet.

To change the still image, release PHOTO, select a still image again, and then press and hold PHOTO lightly.

- (2) Press PHOTO deeper.

The still image on the screen is recorded for about 7 seconds. The sound during those 7 seconds is also recorded.

The still image is displayed on the screen until the recording is completed.

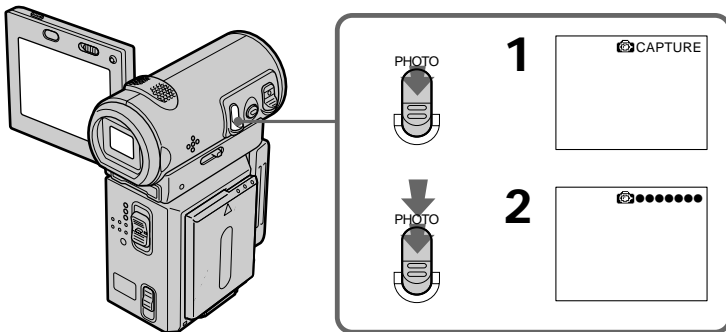

Notes

- You cannot make a tape photo recording during normal CAMERA recording.
- During tape photo recording, you cannot change the mode or setting.
- When recording a still image, do not shake your camcorder. The image may fluctuate.
- The tape photo recording function does not work during the following operations:
 - Fader
 - Digital effect

If you record a moving subject with the tape photo recording function

When you play back the still image using other equipment, the image may fluctuate.

To use the tape photo recording function while using the Remote Commander

Press PHOTO on the Remote Commander. Your camcorder immediately records an image on the screen.

To record clear and less fluctuated still images (DCR-IP7BT only)

We recommend that you record on a "Memory Stick."

Recording a still image on a tape – Tape Photo recording

Self-timer recording

You can make a tape photo recording with the self-timer. You can also use the Remote Commander for this operation.

- (1) In standby mode, select FN, then press the center ● on the control button. The PAGE1 screen appears.
- (2) Select SELF TIMER, then press the center ● on the control button. The ⌚ (self-timer) indicator appears on the screen.
- (3) Press DISPLAY to turn off the screen buttons.
- (4) Press PHOTO firmly.

Self-timer starts counting down from 10 with a beep sound. In the last 2 seconds of the countdown, the beep sound gets faster, then the recording starts automatically.

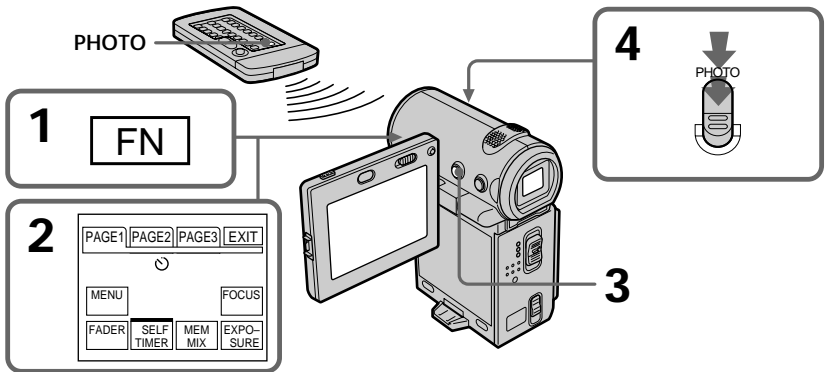

To cancel self-timer recording

Select SELF TIMER on the PAGE1 screen again, then press the center ● on the control button in standby mode. The ⌚ (self-timer) indicator disappears from the screen. You cannot cancel the self-timer recording using the Remote Commander.

Note

The self-timer recording mode is automatically canceled when:

- The self-timer recording is finished.
- The POWER switch is set to OFF (CHG) or VCR.

Using the wide mode

You can record a 16:9 wide picture to watch on a 16:9 wide-screen TV (16:9WIDE). Black bands appear on the screen during recording in 16:9WIDE mode [a]. The pictures viewed during playing back on a normal TV [b] or a wide -screen TV [c] are compressed in the widthwise direction. If you set the screen mode of the wide-screen TV to the full mode, you can watch pictures of normal images [d].

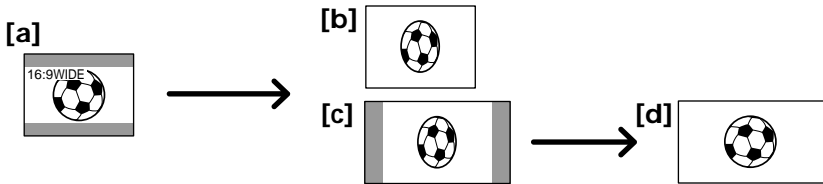

- (1) In standby mode, select FN, then press the center ● on the control button. The PAGE1 screen appears.
- (2) Select MENU, then press the center ● on the control button. The menu appears.
- (3) Select 16:9WIDE via , then press the center ● or ► on the control button.
- (4) Select ON, then press the center ● on the control button.
- (5) Press DISPLAY to turn off the menu.

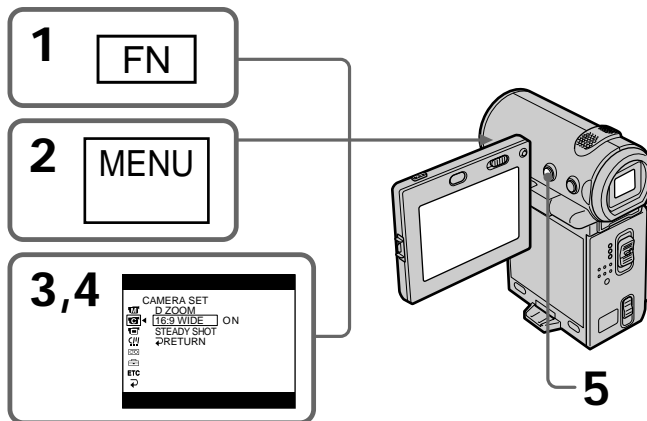

To cancel the wide mode

Set 16:9WIDE to OFF in the menu settings.

Using the wide mode

To return to the FN screen

Select \leftarrow RETURN, \rightarrow , then press the center ● on the control button. The PAGE1 screen appears. Next, select EXIT, then press the center ● on the control button.

In wide mode, you cannot select the following functions:

- Old movie
- Bounce

During recording

You cannot select or cancel the wide mode. When you cancel the wide mode, set your camcorder to the standby mode and then set 16:9WIDE to OFF in the menu settings.

Connection for a TV

Pictures recorded in 16:9WIDE mode automatically appear on the TV screen at full size when:

- You connect your camcorder to a TV that is compatible with the video ID (ID-1/ID-2) system.
- You connect your camcorder to the S video jack on the TV.

ID-1 system

The ID-1 system sends aspect ratio information (16:9, 4:3, or letter box) with video signals. If you connect a TV compatible with the ID-1 system, the screen size is automatically selected.

ID-2 system

The ID-2 system sends a copyright protection signal with ID-1 signals inserted between video signals when you connect your camcorder to other equipment using the A/V connecting cable.

Using the fader function

You can fade in or out to give your recording a professional appearance.

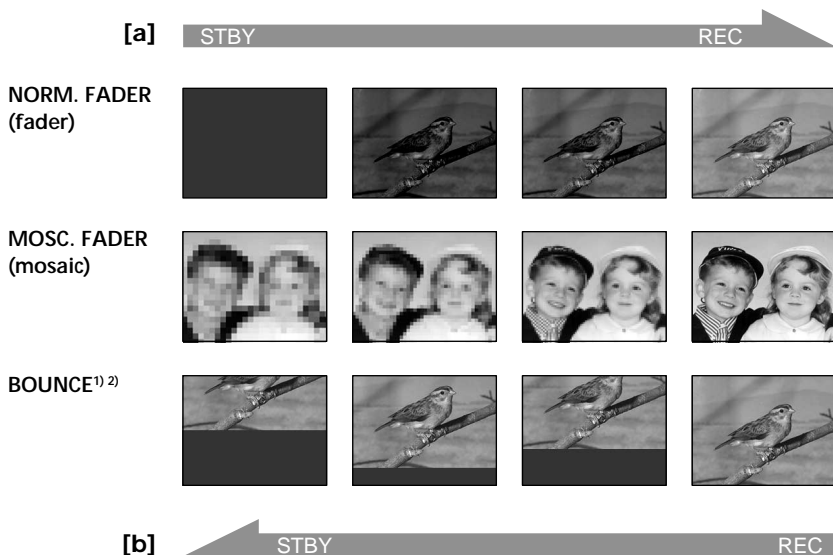

MONOTONE

When fading in, the picture gradually changes from black-and-white to color.
When fading out, the picture gradually changes from color to black-and-white.

¹⁾ You can use the bounce function when D ZOOM is set to OFF in the menu settings.

²⁾ Fade in only.

Using the fader function

(1) When fading in [a]

In standby mode, select FN, then press the center ● on the control button. The PAGE1 screen appears.

When fading out [b]

During recording, select FN, then press the center ● on the control button. The PAGE1 screen appears.

(2) Select FADER, then press the center ● on the control button. The FADER screen for selecting the fader mode appears.

(3) Select the desired fader mode, then press the center ● on the control button. The top of the selected button is indicated with a green bar.

(4) Press DISPLAY to turn off the screen buttons.

(5) Press START/STOP. The fader indicator flashes, then lights up. After the fade in/out is carried out, your camcorder automatically returns to the normal mode.

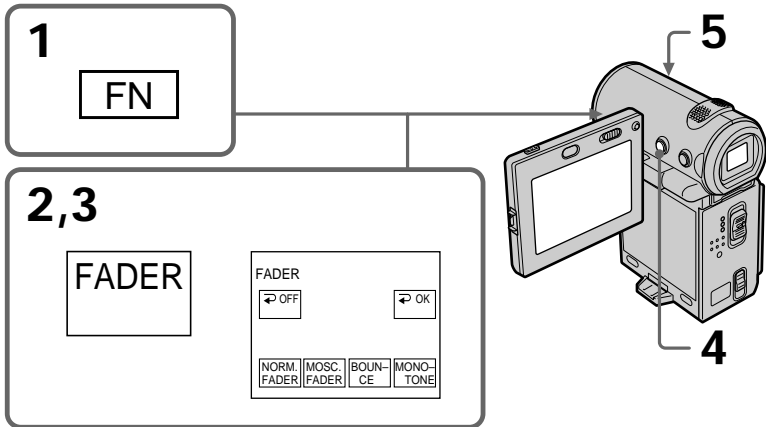

To return to the FN screen

Select ↵ OK, then press the center ● on the control button after step 3. The PAGE1 screen appears. Next, select EXIT, then press the center ● on the control button.

To cancel the fader function

Before pressing START/STOP, select ↵ OFF, then press the center ● on the control button.

Note

You cannot use the following functions while using the fader function, and vice versa.

- Digital effect
- Tape Photo recording

Using the fader function

While using the bounce mode, you cannot use the following functions:

- Exposure
- Focus
- Zoom
- Picture effect

Note on the bounce mode

You cannot select the bounce mode in the following mode or when using these functions:

- D ZOOM is set to 20× or 120× in the menu settings
- Wide mode
- Picture effect
- PROGRAM AE

When the POWER switch is set to MEMORY (DCR-IP7BT only)

You cannot use the fader function.

Using special effects – Picture effect

You can digitally process images to obtain special effects like those in films or on TV.

NEG. ART [a] : The color and brightness of the picture are reversed.

SEPIA : The picture is sepia.

B&W : The picture is monochrome (black-and-white).

SOLARIZE [b] : The light intensity is clearer, and the picture looks like an illustration.

SLIM [c] : The picture expands vertically.

STRETCH [d] : The picture expands horizontally.

PASTEL [e] : The contrast of the picture is emphasized, and the picture looks like an animated cartoon.

MOSAIC [f] : The picture is a mosaic.

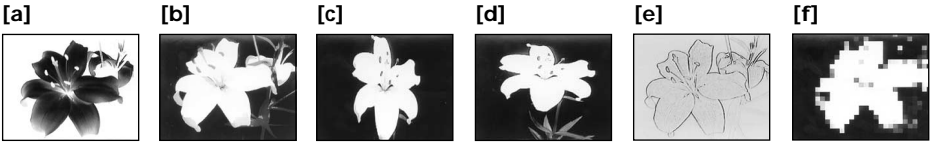

- (1) In CAMERA mode, select FN, then press the center ● on the control button. The PAGE1 screen appears.
- (2) Select MENU, then press the center ● on the control button. The menu appears.
- (3) Select P EFFECT via , then press the center ● or ► on the control button.
- (4) Select the desired picture effect mode, then press the center ● on the control button.
- (5) Press DISPLAY to turn off the menu.

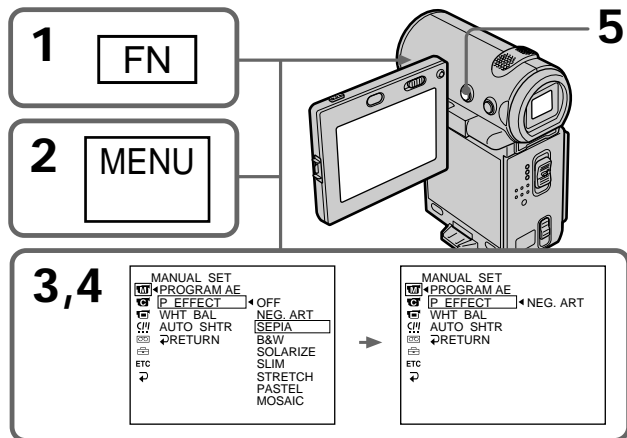

Using special effects – Picture effect

To return to the FN screen

Select \leftarrow RETURN, \leftarrow , then press the center ● on the control button after step 4. The PAGE1 screen appears. Next, select EXIT, then press the center ● on the control button.

To turn the picture effect function off

Set P EFFECT to OFF in the menu settings.

While using the picture effect function

You cannot select the old movie mode with the digital effect function.

When you set the POWER switch to OFF (CHG)

The picture effect will be automatically canceled.

Using special effects – Digital effect

You can add special effects to recorded pictures using the various digital functions. The sound is recorded normally.

STILL

You can record a still image so that it is superimposed on a moving picture.

FLASH (FLASH MOTION)

You can record still image successively at constant intervals.

LUMI. (LUMINANCEKEY)

You can swap a brighter area in a still image with a moving picture.

TRAIL

You can record a picture so that an incidental image like a trail is left.

SLOW SHTR (SLOW SHUTTER)

You can slow down the shutter speed. The slow shutter mode is good for recording dark pictures more brightly.

OLD MOVIE

You can add an old movie-type atmosphere to pictures. Your camcorder automatically sets the wide mode to ON, the picture effect to SEPIA, and sets the appropriate shutter speed.

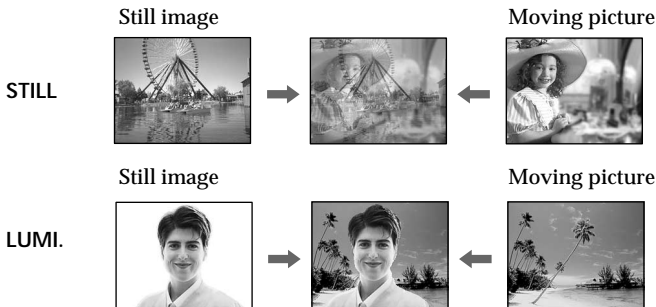

Using special effects – Digital effect

- (1) In CAMERA mode, select FN, then press the center ● on the control button. The PAGE1 screen appears.
- (2) Select PAGE3, then press the center ● on the control button. The PAGE3 screen appears.
- (3) Select DIG EFFT, then press the center ● on the control button. The DIG EFFT screen used for selecting the desired digital effect mode appears.
- (4) Select the desired digital effect mode, then press the center ● on the control button. In STILL and LUMI. modes, the still image is stored in memory.
- (5) Select -/+, then press the center ● on the control button repeatedly to adjust the effect. You can also adjust the effect by pressing ◀/▶ repeatedly after you select -/+,.

Items to be adjusted

STILL	The rate of the still image you want to superimpose on the moving picture
FLASH	The interval of flash motion
LUMI.	The color scheme of the area in the still image which is to be swapped with a moving picture
TRAIL	The vanishing time of the incidental image
SLOW SHTR	Shutter speed. The larger the shutter speed number, the slower the shutter speed.
OLD MOVIE	No adjustment necessary

- (6) Press DISPLAY to turn off the screen buttons.

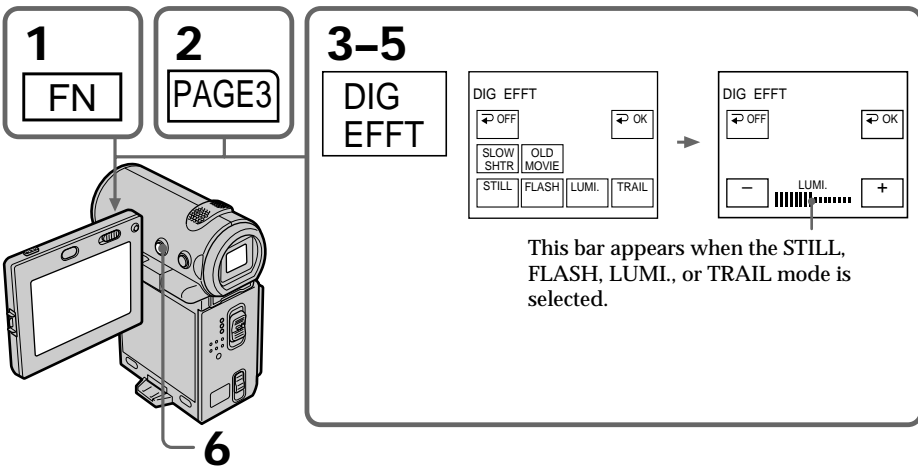

Using special effects – Digital effect

To return to the FN screen

Select \rightarrow OK, then press the center \bullet on the control button after step 5. The PAGE3 screen appears. Next, select EXIT, then press the center \bullet on the control button.

To cancel the digital effect

Select \rightarrow OFF, then press the center \bullet on the control button in step 3.

Notes

- The following functions do not work when you are working with digital effect:
 - Fader
 - The Low lux mode of PROGRAM AE (The indicator flashes)
 - Tape Photo recording
- The PROGRAM AE function does not work in slow shutter mode.
- The following functions do not work in old movie mode:
 - Wide mode
 - Picture effect
 - PROGRAM AE
- The SteadyShot function does not work in slow shutter or old movie mode

When you set the POWER switch to OFF (CHG)

The digital effect will be automatically canceled.

When recording in slow shutter mode

Auto focus may not be effective. Focus manually using a tripod.

Shutter speed

Shutter speed number	Shutter speed
SLOW SHTR 1	1/30
SLOW SHTR 2	1/15
SLOW SHTR 3	1/8
SLOW SHTR 4	1/4

Using the PROGRAM AE function

You can use the PROGRAM AE (Auto Exposure) function to suit your specific shooting requirements.

Spotlight

This mode prevents people's faces, for example, from appearing excessively white when shooting subjects lit by strong light in a theater.

Soft portrait

This mode brings out the subject while creating a soft background for subjects such as people or flowers.

Beach & ski

This mode prevents people's faces from appearing dark in strong light or reflected light, such as at a beach in midsummer or on a ski slope.

Sunset & moon

This mode allows you to maintain atmosphere when you are recording sunsets, general night views, and neon signs.

Landscape

This mode is for when you are recording distant subjects such as mountains and prevents your camcorder from focusing on glass or metal mesh in windows when you are recording a subject behind glass or a screen.

Low lux

This mode makes subjects brighter in insufficient light.



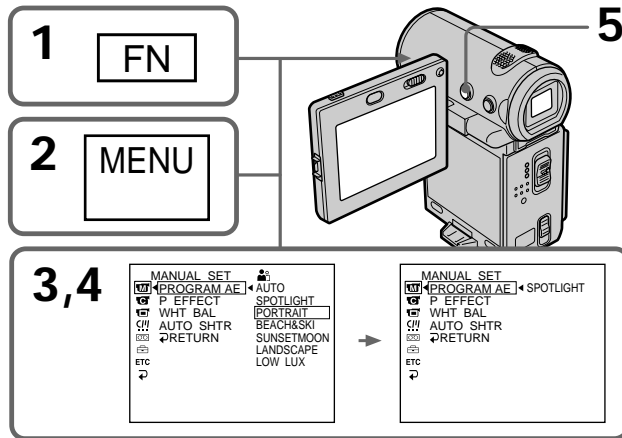

Using the PROGRAM AE function

- (1) In standby or MEMORY (DCR-IP7BT only) mode, select FN, then press the center ● on the control button. The PAGE1 screen appears.
- (2) Select MENU, then press the center ● on the control button. The menu appears.
- (3) Select PROGRAM AE via , then press the center ● or ► on the control button.
- (4) Select a desired PROGRAM AE mode, then press the center ● on the control button.
- (5) Press DISPLAY to turn off the menu. The PROGRAM AE mode indicator appears at the lower-left corner on the screen.



To return to the FN screen

Select  RETURN, , then press the center ● on the control button after step 4. The PAGE1 screen appears. Next, select EXIT, then press the center ● on the control button.

To turn the PROGRAM AE function off

Set PROGRAM AE to AUTO in the menu settings in step 4.

Notes

- Because your camcorder is set to focus only on subjects in the middle to far distance in these modes, you cannot take close-ups in the following modes:
 - Spotlight
 - Beach & ski
- Your camcorder is set to focus only on distant subjects in the following modes:
 - Sunset & moon
 - Landscape

Using the PROGRAM AE function

- The following functions do not work in PROGRAM AE mode:
 - Slow shutter
 - Old movie
 - Bounce
- The digital effect function does not work in low lux mode:
- While shooting in MEMORY mode, the low lux mode does not work. (The indicator flashes.) (DCR-IP7BT only)
- The SteadyShot function does not work in low lux mode.

When WHT BAL is set to AUTO in the menu settings



The white balance is adjusted even if the PROGRAM AE function is selected.

If you are recording under a discharge tube such as a fluorescent lamp, sodium lamp or mercury lamp

Flickering or changes in color may occur in soft portrait mode. If this happens, turn the PROGRAM AE function off.



Adjusting the white balance manually

You can manually adjust and set the white balance. This adjustment makes white subjects look white and allows more natural color balance. Normally white balance is automatically adjusted.

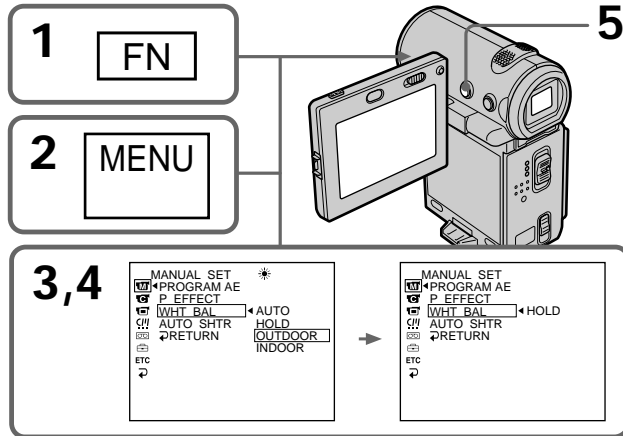
- (1) In CAMERA or MEMORY (DCR-IP7BT only) mode, select FN, then press the center ● on the control button. The PAGE1 screen appears.
- (2) Select MENU, then press the center ● on the control button. The menu appears.
- (3) Select WHT BAL through , then press the center ● or ► on the control button.
- (4) Select the desired white balance mode, then press the center ● on the control button.
HOLD (HOLD) : Recording a single-colored subject or background
OUTDOOR (*):
 - Recording a sunset/sunrise, just after sunset, just before sunrise, neon signs, or fireworks
 - Under a color matching fluorescent lampINDOOR () :
 - When lighting conditions change quickly
 - In bright places such as photography studios
 - Under sodium lamps or mercury lamps
- (5) Press DISPLAY to turn off the menu.



To return to the FN screen

Select  RETURN, , then press the center ● on the control button after step 4. The PAGE1 screen appears. Next, select EXIT, then press the center ● on the control button.

Adjusting the white balance manually

To return to the automatic white balance mode

Select AUTO, then press the ● center on the control button in step 4.

If the picture is being taken in a studio lit by TV lighting

We recommend that you use the  indoor mode.

When you record under fluorescent lighting

Use the automatic white balance or hold mode.

Your camcorder may not adjust the white balance correctly in  indoor mode.

In automatic white balance mode

Point your camcorder at the white subject for about 10 seconds after setting the POWER switch to CAMERA to get better adjustment when:

- You detach the battery for replacement.
- You bring your camcorder from the interior of a house holding the exposure, and vice versa.

In hold white balance mode

Set the white balance to AUTO and reset to HOLD after a few seconds when:

- You change the PROGRAM AE mode.
- You bring your camcorder from the interior of a house, and vice versa.

Adjusting the exposure manually

You can adjust and set the exposure. Normally exposure is automatically adjusted. Adjust the exposure manually in the following cases:

- To make a fine exposure adjustment
- To shoot a bright subject with a dark background
- To record dark pictures (e.g. night scenes) faithfully

- (1) In CAMERA or MEMORY (DCR-IP7BT only) mode, select FN, then press the center ● on the control button. The PAGE1 screen appears.
- (2) Select EXPOSURE, then press the center ● on the control button. The EXPOSURE screen used for adjusting the exposure appears.
- (3) Select MANUAL, then press the center ● on the control button.
- (4) Select -/+, then press the center ● on the control button repeatedly to adjust the exposure.
 - : to dim
 - + : to brightenYou can also adjust the exposure by pressing ◀/▶ repeatedly after you select -/+.
- (5) Press DISPLAY to turn off the screen buttons.

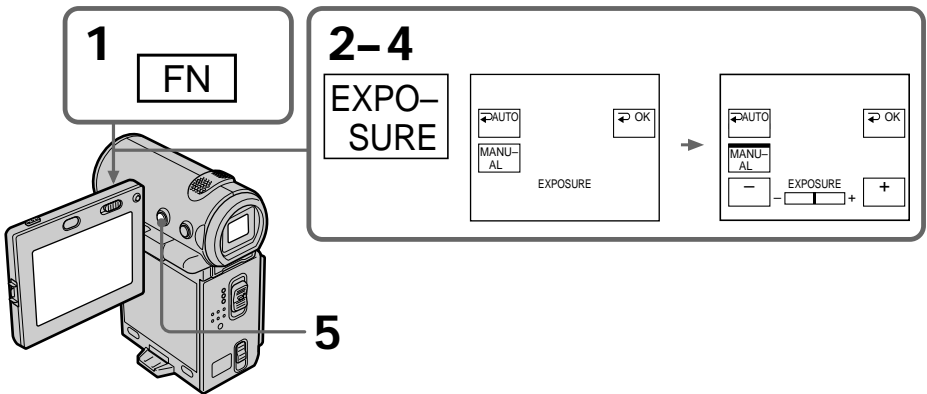

To return to the FN screen

Select ↵ OK, then press the center ● on the control button after step 4. The PAGE1 screen appears. Next, select EXIT, then press the center ● on the control button.

To return to the automatic exposure mode

Select ↵ AUTO, then press the center ● on the control button in step 4.

Note

When you adjust the exposure manually, the backlight function does not work.

Your camcorder automatically returns to the automatic exposure mode:







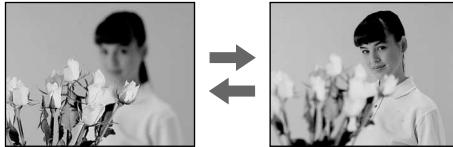

- If you change the PROGRAM AE mode.

Focusing manually

You can gain better results by manually adjusting the focus in the following cases. Normally, focus is automatically adjusted.

- The autofocus mode is not effective when shooting
 - subjects through glass coated with water droplets
 - horizontal stripes
 - subjects with little contrast with backgrounds such as walls and sky
- When you want to change the focus point from a subject in the foreground to a subject in the background
- Shooting a stationary subject when using a tripod



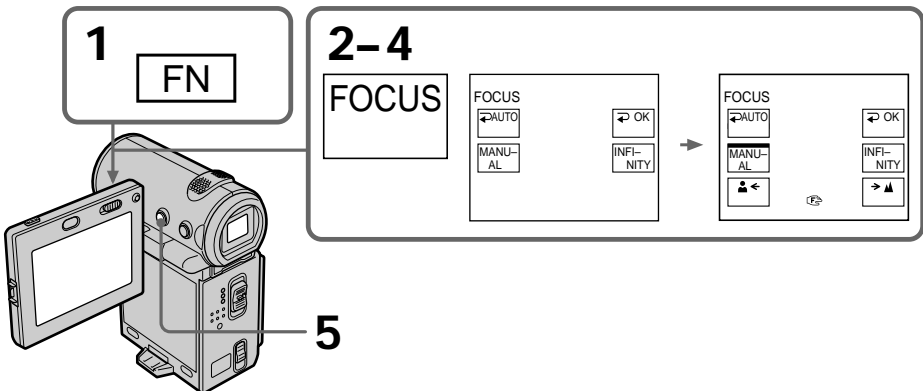

- (1) In CAMERA or MEMORY (DCR-IP7BT only) mode, select FN, then press the center ● on the control button. The PAGE1 screen appears.
- (2) Select FOCUS, then press the center ● on the control button. The FOCUS screen used for adjusting the focus appears.
- (3) Select MANUAL, then press the center ● on the control button. The top of the selected button is indicated with a green bar and the  indicator appears.
- (4) Select  ← or → , then press the center ● on the control button repeatedly to adjust the focus.
 -  ← : To move the focus point closer
 -  : To move the focus point further awayYou can also adjust the focus by pressing  /  repeatedly after you select  ← or → .
- (5) Press DISPLAY to turn off the screen buttons.







Focusing manually



To return to the FN screen

Select  OK, then press the center  on the control button after step 4. The PAGE1 screen appears. Next, select EXIT, then press the center  on the control button.

To return to the autofocus mode

Select  AUTO, then press the center  on the control button in step 4. The ,  or  indicator is turned off, and the camcorder returns to the autofocus mode.

To record distant subjects

In step 4, select INFINITY, then press the center  on the control button. The focus is set to the infinity position and the  indicator appears. Use this mode when your camcorder focuses on near by objects even though you are trying to shoot a distant object.



To focus precisely

It is easier to focus on the subject if you adjust the zoom to shoot at the “W” (wide-angle) after focusing at the “T” (telephoto) position.

When you shoot close to the subject

Focus at the end of the “W” (wide-angle) position.

 changes as follows:

-  when recording a distant subject.
-  when the subject is too close to focus on.



Playing back a tape with picture effects

During playback, you can process a scene using the picture effect function: NEG.ART, SEPIA, B&W, and SOLARIZE.

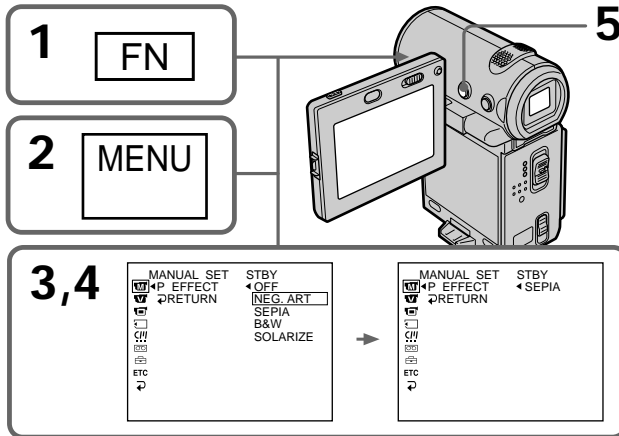
- (1) In playback or playback pause mode, select FN, then press the center ● on the control button. The PAGE1 screen appears.
- (2) Select MENU, then press the center ● on the control button. The menu appears.
- (3) Select P EFFECT via , then press the center ● or ► on the control button.
- (4) Select the desired picture effect mode, then press the center ● on the control button.
See page 54 for details on each picture effect mode.
- (5) Press DISPLAY to turn off the menu. Pressing DISPLAY again displays the video control buttons.



To return to the FN screen

Select  RETURN, , then press the center ● on the control button after step 4. The PAGE1 screen appears. Next, select EXIT, then press the center ● on the control button.

To cancel the picture effect function

Set P EFFECT to OFF in the menu settings in step 4.

Notes

- You cannot process externally input scenes using the picture effect function.
- You cannot record images on the tape inserted in your camcorder when you have processed the image using the picture effect function. However, you can record images on a “Memory Stick” (DCR-IP7BT only) (p. 123, 128), or on a VCR using your camcorder as a player.

Playing back a tape with picture effects

Pictures processed by the picture effect function

Pictures processed by the picture effect function are not output through the i.LINK (MICROMV) jack.

When you set the POWER switch to OFF (CHG) or stop playback

The picture effect function is automatically canceled.

Playing back a tape with digital effects

During playback, you can process a scene using the digital effect function: STILL, FLASH, LUMI., and TRAIL.

- (1) In playback or playback pause mode, select FN, then press the center ● on the control button. The PAGE1 screen appears.
- (2) Select PAGE2, then press the center ● on the control button. The PAGE2 screen appears.
- (3) Select DIG EFFT, then press the center ● on the control button. The DIG EFFT screen used for selecting the desired digital effect mode appears.
- (4) Select the desired digital effect mode, then press the center ● on the control button.

In STILL or LUMI. mode, when the mode is selected, the picture being displayed is stored in memory as a still image.

- (5) Select -/+ , then press the center ● on the control button repeatedly to adjust the effect. See page 56 for details on each digital effect mode.
- (6) Press DISPLAY to turn off the screen buttons. Pressing DISPLAY again displays the video control buttons.

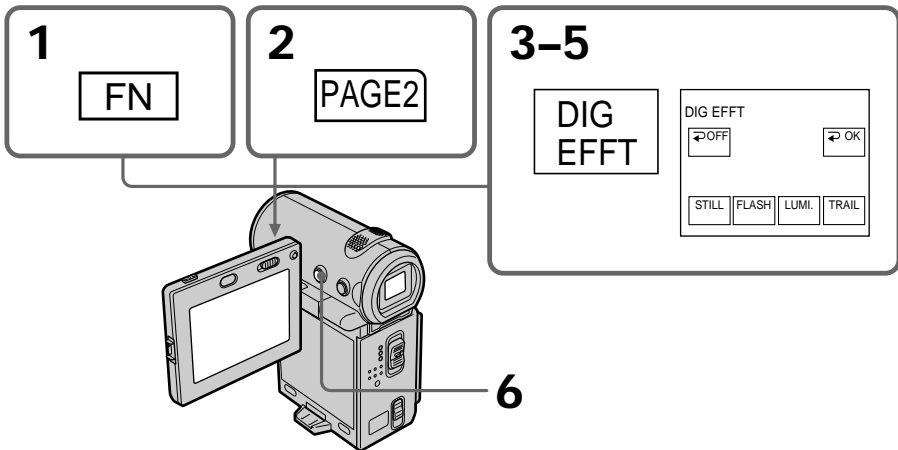

To return to the FN screen

Select ↩ OK, then press the center ● on the control button after step 5. The PAGE2 screen appears. Next, select EXIT, then press the center ● on the control button.

To cancel the digital effect function

Select ↩ OFF, then press the center ● on the control button in step 4 or 5.

Playing back a tape with digital effects

Notes

- You cannot process externally input scenes using the digital effect function.
- You cannot record images on the tape inserted in your camcorder when you have processed the image using the digital effect function. However, you can record images on a "Memory Stick" (DCR-IP7BT only) (p. 123, 128), or on a VCR using your camcorder as a player.

Pictures processed by the digital effect function

Pictures processed by the digital effect function are not output through the i.LINK (MICROMV) jack.

When you set the POWER switch to OFF (CHG) or stop playback

The digital effect function is automatically canceled.

Searching for a scene – Multi-picture search

Using the multi-picture search function, you can display thumbnails of all the beginning scenes of moving pictures and still images recorded in the tape onto the index screen. The recording date and title of each image or scene are also indicated. Select the thumbnail you want to play back, then press the center ● on the control button, the camcorder starts searching for the image or scene and plays it back automatically. You can also control this function using the Remote Commander.

- (1) Set the POWER switch to VCR.
- (2) Select FN, then press the center ● on the control button. The PAGE1 screen appears.
- (3) Select MULTI SRCH, then press the center ● on the control button. The MULTI SCH screen appears.
- (4) Select ←/→, then press the center ● on the control button. The camcorder starts scanning in the selected direction. When you select →, the thumbnails are displayed from the upper-left window, and when you select ←, they are displayed from the lower-right window. After the scanning is completed, the upper-left window turns black and the thumbnails will be displayed on the index screen.

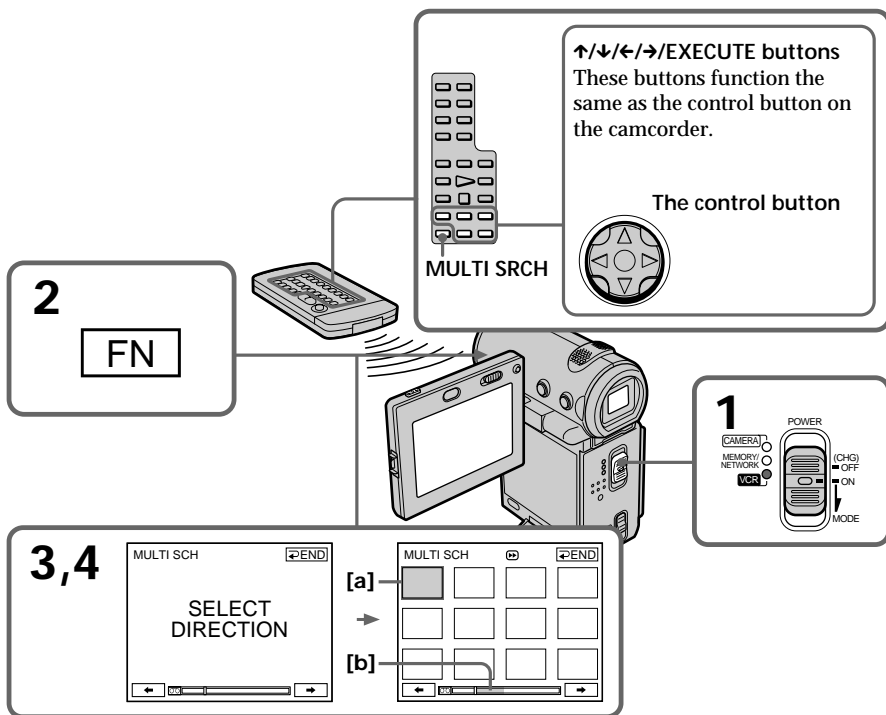

- [a] The picture being fast-forwarded or rewind
[b] The blue portion indicates the range of the scan currently being made to display thumbnails

Searching for a scene – Multi-picture search

- (5) Select the thumbnail you want to play back, then press the center ● on the control button. The camcorder starts searching for the image or scene and plays it back automatically. The blue portion of the bar indicates the scanning range and the white portion of the bar indicates the recorded portion.

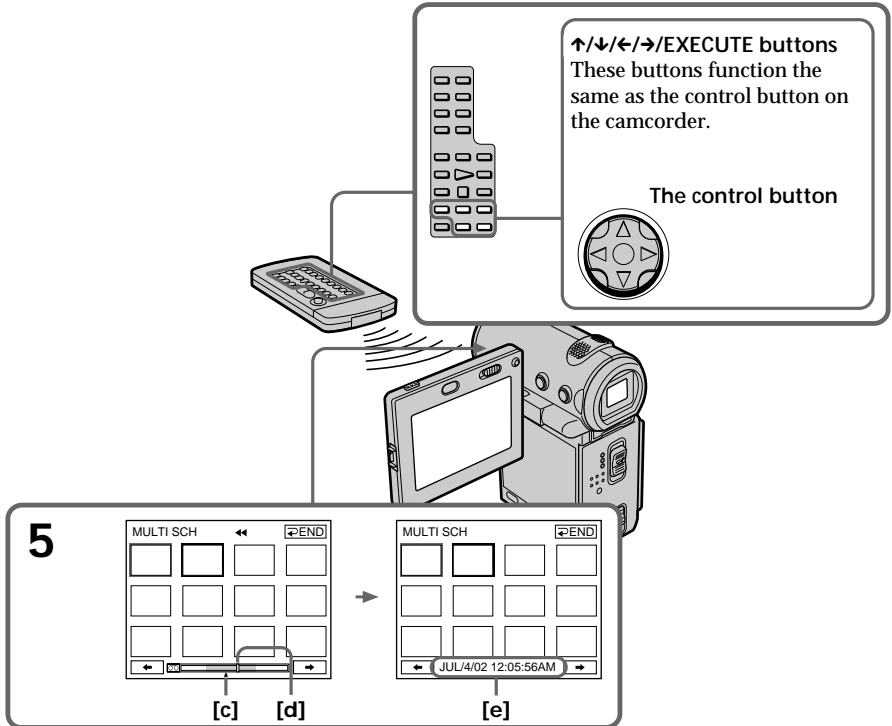

[c] The actual point you are trying to search for (yellow ▲ mark)

[d] The present point on the tape (yellow bar)

[e] The title/date (The title turns to the date indication after 5 seconds.)

To return to the MULTI SCH screen from playback

Select ◀ RETURN, then press the center ● on the control button.

To stop searching

Press STOP on the Remote Commander.

To end the multi-picture search function

Select ◀ END, then press the center ● on the control button.

To end the multi-picture search function from the playback screen

Select EXIT, then press the center ● on the control button.

Searching for a scene – Multi-picture search

When controlling the camcorder from the Remote Commander

You can use the MULTI SRCH and $\uparrow/\downarrow/\leftarrow/\rightarrow$ /EXECUTE buttons.

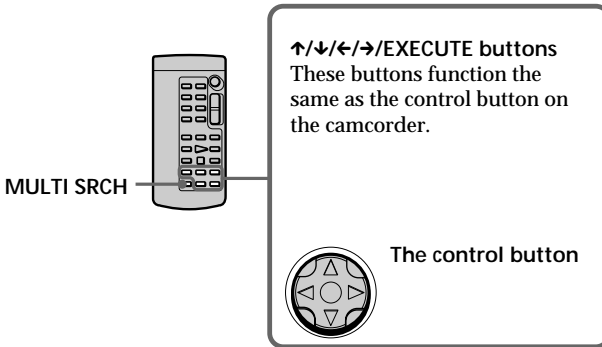

If the tape has a blank portion between recorded portions
The multi-picture search function may not work correctly.

The number of thumbnails stored in one cassette
About 400 thumbnails can be stored.

The number of thumbnails that can be searched for in one scanning
A maximum of 11 thumbnails can be searched for in one scanning.

When you press MULTI SRCH on the Remote Commander
The MULTI SCH screen appears.

During searching
The other functions of this camcorder do not work.

The thumbnail images displayed on the MULTI SCH screen
You cannot modify these thumbnail images.

When you use the multi-picture search function with the digital effect activated
The digital effect will be canceled.

Some of the 11 thumbnails may not be displayed in the following cases:

- These are fewer than 11 recorded images and scenes on the searched portion of the tape.
- When scanning a tape recorded over previous recordings.
- When you have erased all the Micro Cassette Memory of the tape (p. 101).

Searching for a scene – Multi-picture search

Notes

- Thumbnails may not be displayed depending on the condition of the tape. This is not a malfunction.
- Noise may appear on the thumbnails. However, this has no effect on the recorded images.

When you select ◀ or ▶, then press the center ● on the control button during scanning

The next 11 thumbnails will be scanned.

Even if the first thumbnail is not displayed before the scanning is completed
You can play back the image or scene.

Searching the boundaries of recorded tape by title – Title search

You can search for the boundaries of recorded tape by title. You can only use this function with the Remote Commander.

- (1) Set the POWER switch to VCR.
- (2) Press SEARCH MODE on the Remote Commander repeatedly until the TITLE SEARCH indicator appears.

The indicator changes as follows:



- (3) Press **↑** or **↓** on the Remote Commander to select the title you want to playback. Your camcorder automatically starts playback of the scene having the title that you selected.

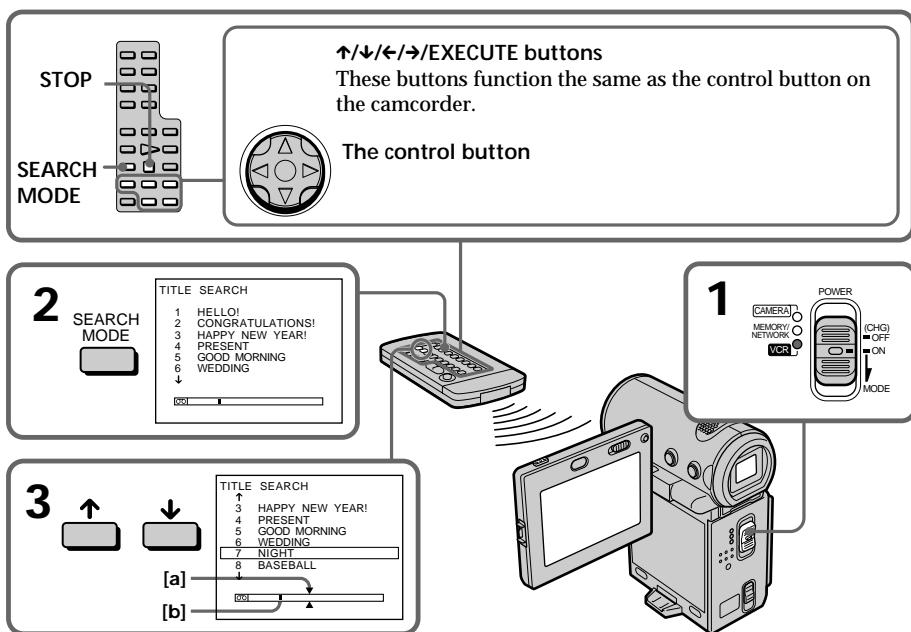

[a] The actual point you are trying to search for

[b] The present point on the tape

Searching the boundaries of recorded tape by title – Title search

To stop searching

Press STOP on the Remote Commander.

If the tape has a blank portion between recorded portions

The title search function may not work correctly.

To superimpose a title

See page 89.

Searching a recording by date

- Date search

You can automatically search for the point where the recording date changes and start playback from that point. You can only use this function with the Remote Commander. Use this function to check where recording dates change or to edit the tape at each recording date.

- (1) Set the POWER switch to VCR.
- (2) Press SEARCH MODE on the Remote Commander repeatedly until the DATE SEARCH indicator appears.

The indicator changes as follows:



- (3) Press **↑** or **↓** on the Remote Commander to select the date you want to playback. Your camcorder automatically starts playback at the beginning of the selected date.

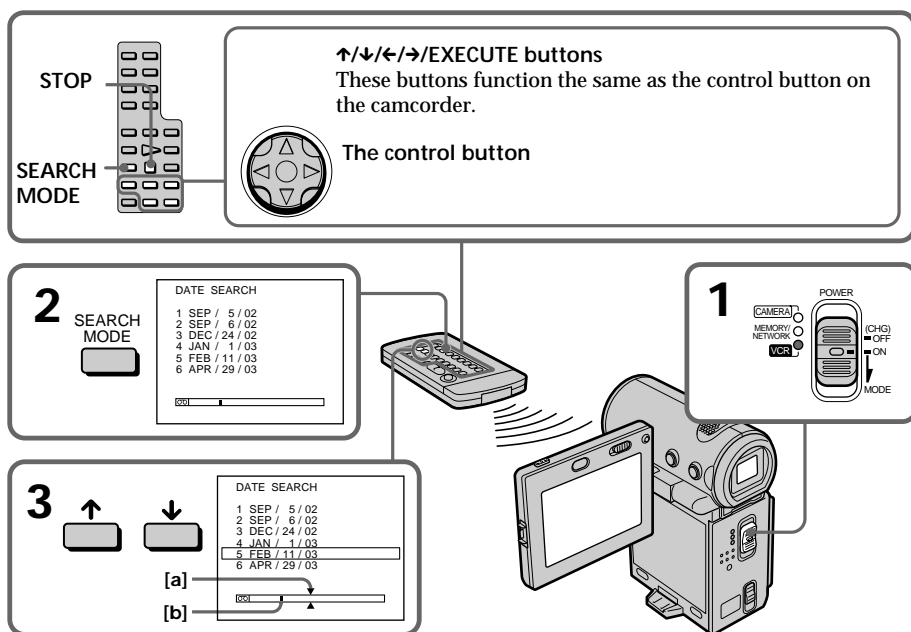

- [a] The actual point you are trying to search for
[b] The present point on the tape

Searching a recording by date – Date search

To stop searching

Press STOP on the Remote Commander.

If the tape has a blank portion between recorded portions

The date search function may not work correctly.

Micro Cassette Memory

The Micro Cassette Memory can hold 20 recording date data.

Searching for a photo – Photo search

You can search for a still image you have recorded on a tape.

You can only use this function with the Remote Commander. Use this function to check or edit still images.

- (1) Set the POWER switch to VCR.
- (2) Press SEARCH MODE on the Remote Commander repeatedly until the PHOTO SEARCH indicator appears.

The indicator changes as follows:



- (3) Press \uparrow or \downarrow on the Remote Commander to select the date you want to playback. Your camcorder automatically starts playback of the photo having the date that you selected.

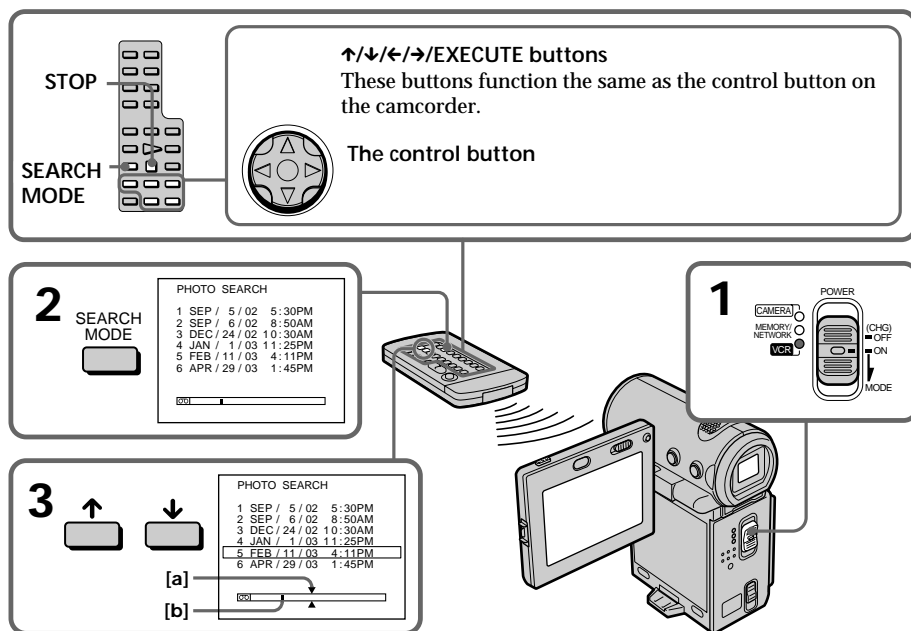

[a] The actual point you are trying to search for

[b] The present point on the tape

Searching for a photo – Photo search

To stop searching

Press STOP on the Remote Commander.

If the tape has a blank portion between recorded portions

The photo search function may not work correctly.

The number of photos that can be searched for

The available number is up to approximate 400 photos. However, if a moving picture is recorded, the searchable number decreases.

Dubbing a tape

- Using the A/V connecting cable

You can dub or edit on the VCR connected to your camcorder using your camcorder as a player. Connect your camcorder to the VCR using the A/V connecting cable supplied with your camcorder. The supplied A/V connecting cable is equipped with an S video plug and a video plug. Use either the S video plug or the video plug depending on the recorder. Do not connect both of the plugs to the recorder.

Before operation

- Set DISPLAY to LCD in the menu settings. (The default setting is LCD.)
- Press the following buttons to turn off the indicators so that they will not be superimposed on the edited tape:
 - On your camcorder: DISPLAY
 - On the Remote Commander: DISPLAY, DATA CODE, SEARCH MODE
- Set DATA CODE on the PAGE3 screen to OFF.

- (1) Insert a blank tape (or a tape you want to record over) into the VCR, and insert a recorded tape into your camcorder.
- (2) Prepare the VCR for recording: connect the A/V connecting cable, then set the input selector to LINE.
Refer to the operating instructions of the VCR.
- (3) Set the POWER switch to VCR.
- (4) Play back the recorded tape on your camcorder.
- (5) Start recording on the VCR.
Refer to the operating instructions of your VCR.

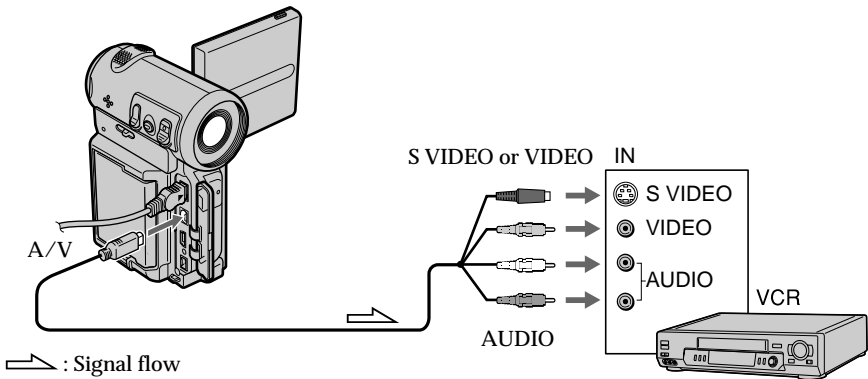

When you have finished dubbing the tape

Stop the recording on the VCR, and stop the playback on the camcorder.

Dubbing a tape

You can edit on VCRs that support the following systems

8 8 mm, **Hi8** Hi8, **D** Digital8, **VHS** VHS, **S-VHS** S-VHS, **VHS-C** VHS-C, **S-VHS-C** S-VHS-C, **B** Betamax, **ED Beta** ED Betamax, **mini DV** mini DV, **DV** DV, or **MICROMV**

If your VCR is a monaural type

Connect the yellow or black plug of the A/V connecting cable to the video or S video input jack on the VCR, and the white or red plug to the audio input jack on the VCR. When the white plug is connected, the left channel audio is output, and when the red plug is connected, the right channel audio is output.

If your VCR has an S video jack

Connect using the S video plug to faithfully obtain original pictures. With this connection, you do not need to connect the yellow (video) plug of the A/V connecting cable. Connect the S video plug to the S video jack of the VCR. This connection produces higher quality MICROMV format pictures.

- Using the i.LINK cable

Simply connect the supplied i.LINK cable to the i.LINK (MICROMV) jack of your camcorder and to the i.LINK (MICROMV) jack of the MICROMV product. With digital-to-digital connection, video and audio signals are transmitted in digital form for high-quality editing. You cannot dub the titles, displayed indicators, the contents of Micro Cassette Memory, or letters on the "Memory Stick" index screen (DCR-IP7BT only). (You cannot connect the camcorder to a DV product.)

- (1) Insert a blank tape (or a tape you want to record over) into the recorder, and insert a recorded tape into your camcorder.
- (2) Prepare the recorder for recording.
Set the input selector to LINE if it is provided. Refer to the operating instructions of the recorder.
- (3) Set the POWER switch to VCR.
- (4) Play back the recorded tape on your camcorder.
- (5) Start recording on the recorder.

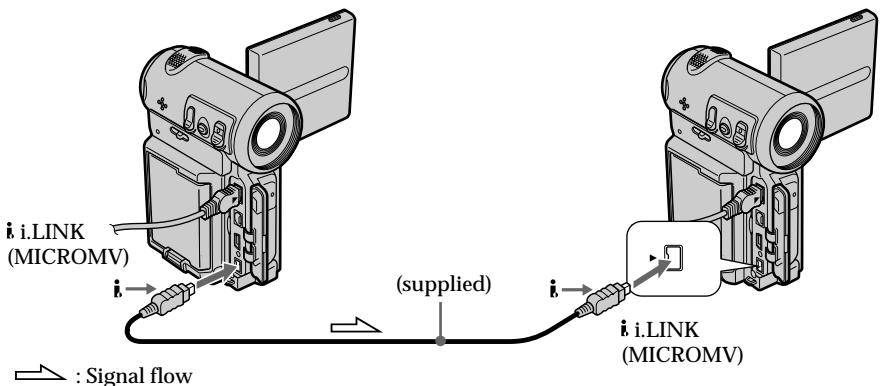

Dubbing a tape

When you have finished dubbing the tape

Stop the recording on the recorder, and stop the playback on the camcorder.

You can connect only one recorder using the i.LINK cable

See page 176 for more information about i.LINK.

The following functions do not work during digital editing:

- Picture effect
- Digital effect

Note on playback pause pictures

When you dub a playback pause picture:

- The recorded picture becomes rough when recorded through the i.LINK (MICROMV) jack.
- The picture may jitter when you play back the tape on other video devices.
- There may be a time-lag when you play back the tape on other video devices.

Recording a program

When using the A/V connecting cable

You can record or edit a program from another VCR that has video/audio outputs. Use your camcorder as a recorder.

1 Switching the video input jack of the A/V connecting cable

The supplied A/V connecting cable is equipped with an S video plug and a video plug. You have to select one of the jacks in the menu settings. The default setting is VIDEO. If the setup is not necessary, go to "**2** Making a recording" on page 85.

- (1) Set the POWER switch to VCR.
- (2) Select FN, then press the center ● on the control button. The PAGE1 screen appears.
- (3) Select MENU, then press the center ● on the control button. The menu appears.
- (4) Select VIDEOINPUT via , then press the center ● or ► on the control button.
- (5) Select VIDEO or S VIDEO, then press the center ● on the control button.
- (6) Press DISPLAY to turn off the menu. Pressing DISPLAY again displays the video control buttons.

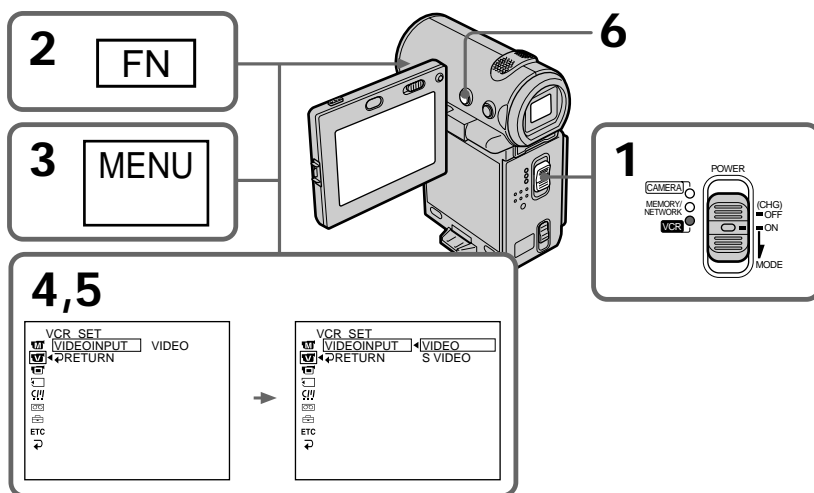



Recording a program

2 Making a recording

Before operation

Set DISPLAY to LCD in the menu settings (The default setting is LCD.) (p. 102).

- (1) Insert a blank tape (or a tape you want to record over) into your camcorder and insert a recorded tape into the VCR.
- (2) Set the POWER switch to VCR.
- (3) Select FN, then press the center ● on the control button. The PAGE1 screen appears.
- (4) Select PAGE3, then press the center ● on the control button. The PAGE3 screen appears.
- (5) Select  REC CTRL, then press the center ● on the control button, and select REC PAUSE, then press the center ● on the control button.
- (6) Press  on the VCR to start playback. The picture from the VCR appears on the screen on your camcorder.
- (7) Select REC START, then press the center ● on the control button at the scene where you want to start recording. The recording starts.

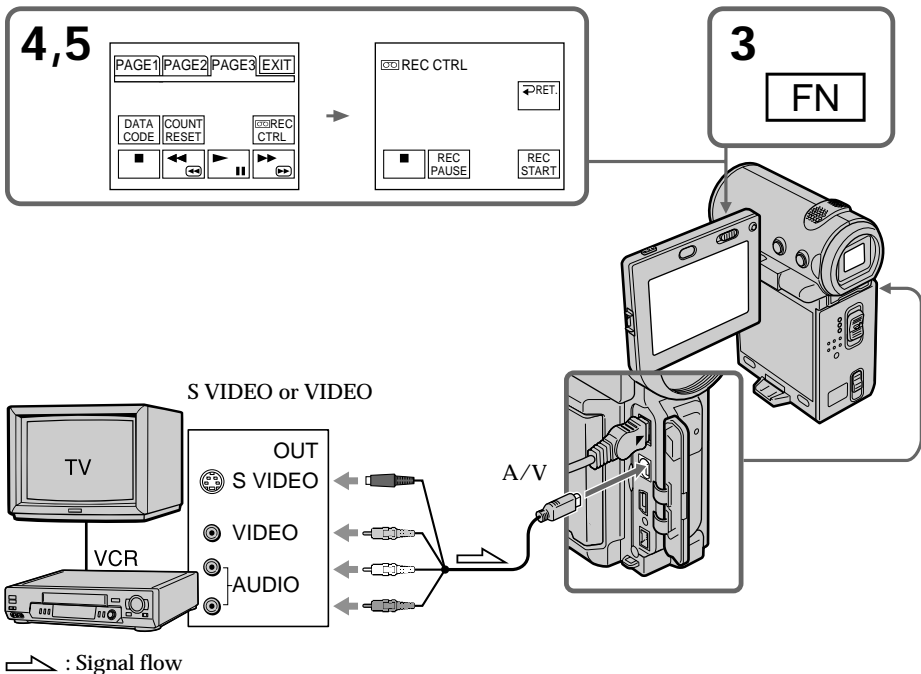

Recording a program

When you have finished dubbing the tape

Select **[■]**, then press the center **●** on the control button on your camcorder and stop the playback of the VCR.

If your VCR is a monaural type

Connect the yellow plug of the A/V connecting cable to the video output jack and the white or red plug to the audio output jack on the VCR. When the white plug is connected, the left channel audio is output, and when the red plug is connected, the right channel audio is output.

If your VCR has an S video jack

Connect using the S video plug to faithfully obtain original pictures. With this connection, you do not need to connect the yellow (video) plug of the A/V connecting cable. Connect the S video plug to the S video jack of the VCR. This connection produces higher quality MICROMV format pictures.

Note (DCR-IP7BT only)

When you press MEMORY PLAY on the Remote Commander in step 5, an image recorded on the "Memory Stick" is displayed. If you select REC START, then press the center **●** on the control button, the image will be recorded on the tape. To stop memory playback, press MEMORY PLAY on the Remote Commander again.

Recording a program

When using the i.LINK cable

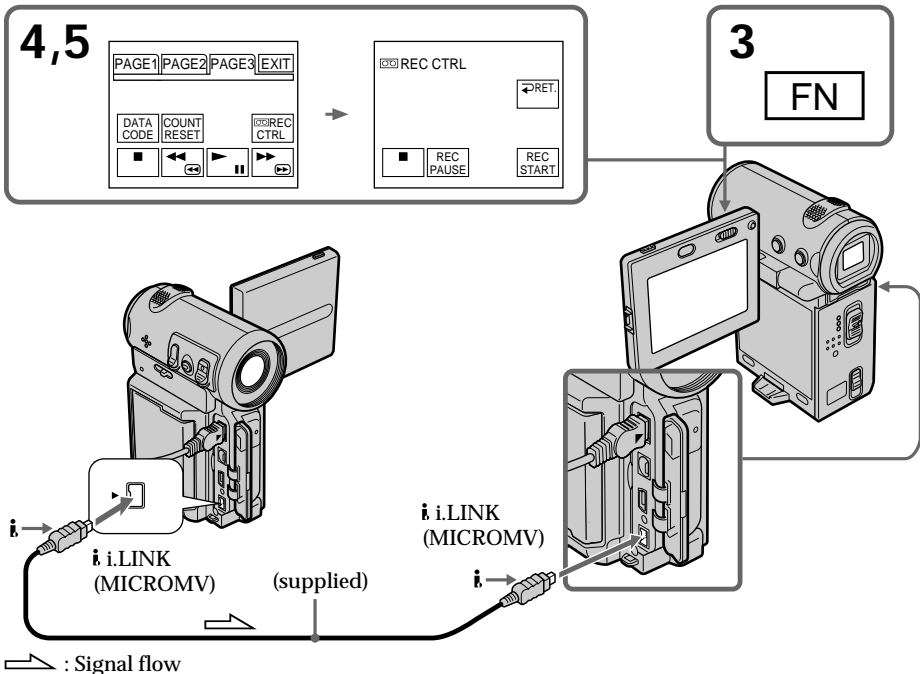

Simply connect the supplied i.LINK cable to the **i** i.LINK (MICROMV) jack of your camcorder and to the i.LINK (MICROMV) jack of the MICROMV product. With digital-to-digital connection, video and audio signals are transmitted in digital form for high-quality editing. (You cannot connect the camcorder to a DV product.)

- (1) Insert a blank tape (or a tape you want to record over) into your camcorder, and insert a recorded tape into the player.
- (2) Set the POWER switch to VCR.
- (3) Select FN, then press the center ● on the control button. The PAGE1 screen appears.
- (4) Select PAGE3, then press the center ● on the control button. The PAGE3 screen appears.
- (5) Select  REC CTRL, then press the center ● on the control button, and select REC PAUSE, then press the center ● on the control button.
- (6) Press ► on the player to start playback. The picture from the player appears on the screen on your camcorder.
- (7) Select REC START, then press the center ● on the control button at the scene where you want to start recording.



Recording a program

When you have finished dubbing the tape

Select , then press the center  on the control button and stop the playback of the player.

Notes

- When an incompatible picture (such as one recorded with the DV format) is input, the message “INPUT ERROR” appears.
- You can connect only one recorder using the i.LINK cable.

When you dub a picture in digital form

The color of the display may be uneven. However, this does not affect the dubbed picture.

If you record a playback pause picture with the i.LINK (MICROMV) jack

The recorded picture becomes rough. And when you play back the picture using your camcorder, the picture may jitter.

Note

First, start playback or turn to the playback pause mode before the camcorder starts recording or turns to the recording pause mode. If no signal is input into the camcorder, the message “NO INPUT” appears and the camcorder cannot start recording.

Before recording

Make sure the MPEG IN indicator appears on the screen. The MPEG IN indicator may appear on both pieces of equipment.

Superimposing a title

You can superimpose a title for 5 seconds from the recording start point. When you play back the tape, the title is displayed for about 5 seconds from the point where you superimposed it.

You can select one of eight preset titles and two custom titles (p. 95). You can also select the color, size and position of titles.



Superimposing a title on starting a recording

- (1) In standby mode, select FN, then press the center ● on the control button. The PAGE1 screen appears.
- (2) Select PAGE2, then press the center ● on the control button. The PAGE2 screen appears.
- (3) Select TITLE, then press the center ● on the control button. The title menu appears.
- (4) Select □, then press the center ● or ► on the control button.
- (5) Select the desired title, then press the center ● on the control button. The selected title appears on the screen.

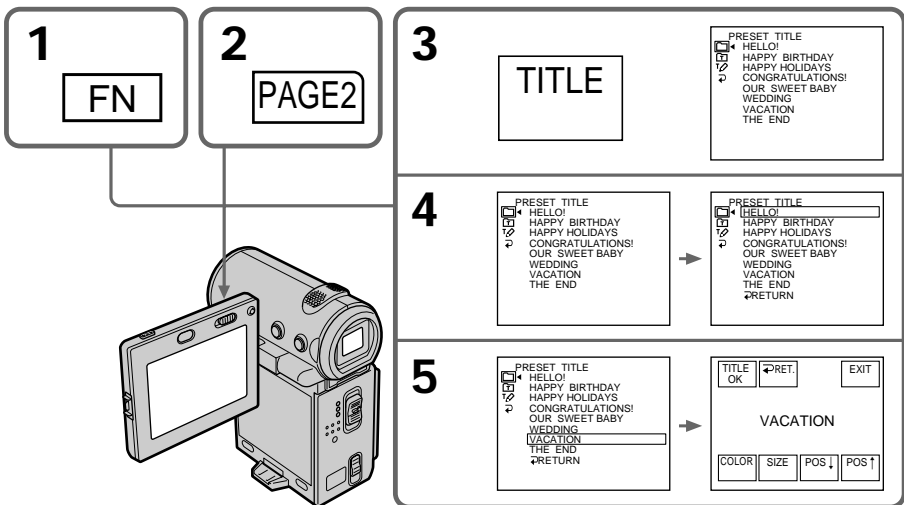

Superimposing a title

- (6) If necessary, change the color, size, or position by selecting COLOR, SIZE, POS ↓ or POS ↑, then press the center ● on the control button repeatedly.
- (7) Select TITLE OK, then press the center ● on the control button.
- (8) Select SAVE TITLE, then press the center ● on the control button.
The “TITLE” indicator appears. And when you press START/STOP to start recording, “TITLE SAVE” appears on the screen for about 5 seconds and the title is set.

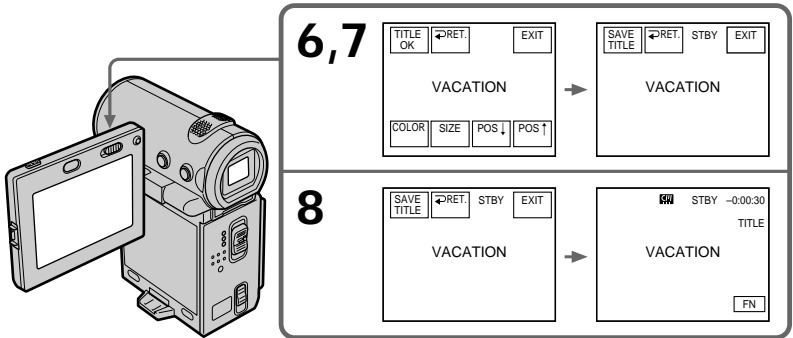

If you set the write-protect tab to lock

You cannot superimpose a title. Slide the write-protect tab to release the write protection.

To use a custom title

If you want to use a custom title, select  in step 4 (p. 95).

If the tape has a blank portion

You cannot superimpose a title on the blank portion.

If the tape has a blank portion in the middle of the recorded portions

The title may not be displayed correctly.

To not display title during playback

Set TITLE DSPL to OFF in the menu settings (p. 102).

Superimposing a title

Title setting

- The title color changes as follows:
WHITE → YELLOW → VIOLET → RED → CYAN → GREEN → BLUE
- The title size changes as follows:
SMALL ↔ LARGE
You cannot input more than 12 characters in LARGE size. If you input more than 12 characters, the title size returns to SMALL even if you select LARGE.
- If you select the title size "SMALL," you have nine choices for the title position.
If you select the title size "LARGE," you have eight choices for the title position.

The number of titles recordable on one cassette

You can record up to 20 titles when each title consists of 12 characters.

When 20 titles are already superimposed

The message "TITLE FULL" appears. Erase unnecessary titles.

Superimposing a title

Superimposing a title on a recorded tape

The title is recorded for about 5 seconds from the recording start point.

- (1) Set the POWER switch to VCR.
- (2) Select FN, then press the center ● on the control button. The PAGE1 screen appears.
- (3) Select TITLE, then press the center ● on the control button. The TITLE screen appears.
- (4) Select INPUT TITLE, then press the center ● on the control button. The INPUT TITLE screen appears.
- (5) Select ←/→, then press the center ● on the control button. The camcorder starts scanning in the selected direction. When you select →, the thumbnails are displayed from the upper-left window, and when you select ←, they are displayed from the lower-right window. After the scanning is completed, the thumbnails are displayed on the index screen.
- (6) Select the thumbnail on which you want to superimpose a title, then press the center ● on the control button. The title menu appears.
- (7) Perform steps 4 to 6 in “Superimposing a title on starting a recording” on page 89.
- (8) Select SAVE TITLE, then press the center ● on the control button. The “TITLE SAVE” indicator appears on the screen for about 5 seconds and the title is set.

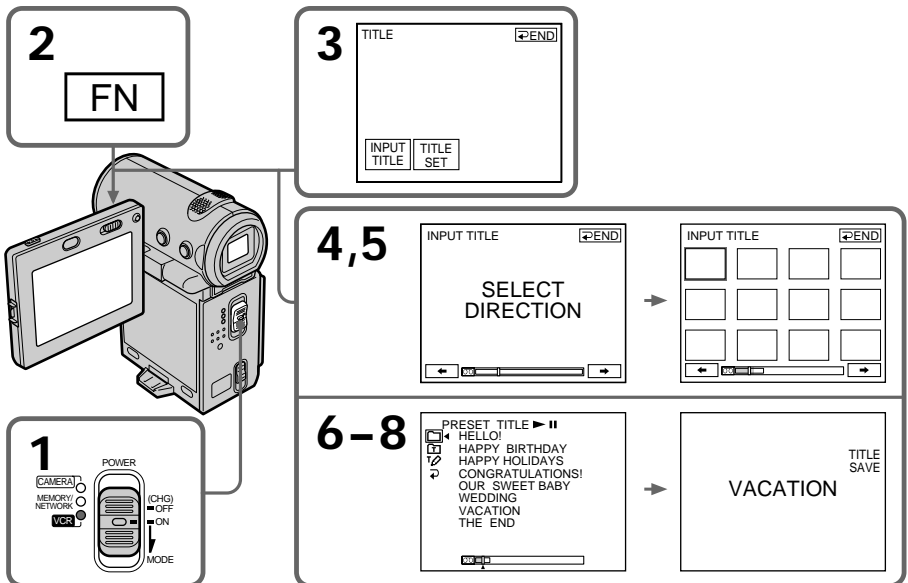

Superimposing a title

To use a custom title

If you want to use a custom title, select  in step 6 (p. 95).

Notes

- Thumbnails may not be displayed depending on the condition of the tape. This is not a malfunction.
- Noise may appear on the thumbnails. However, this has no effect on the recorded images.
- You cannot execute TITLE SAVE until the playback picture is displayed in step 8.

Superimposing a title

Erasing a title

- (1) Set the POWER switch to CAMERA or VCR.
- (2) Select FN, then press the center ● on the control button. The PAGE1 screen appears.
- (3) Select MENU, then press the center ● on the control button. The menu appears.
- (4) Select TITLEERASE via , then press the center ● or ► on the control button. The TITLE ERASE screen appears.
- (5) Select the title you want to erase, then press the center ● on the control button. The message "ERASE OK?" appears.
- (6) Make sure the title is the one you want to erase, and select OK, then press the center ● on the control button. The message "ERASING" flashes while erasing. After the erasing is completed, the message "COMPLETE" appears.

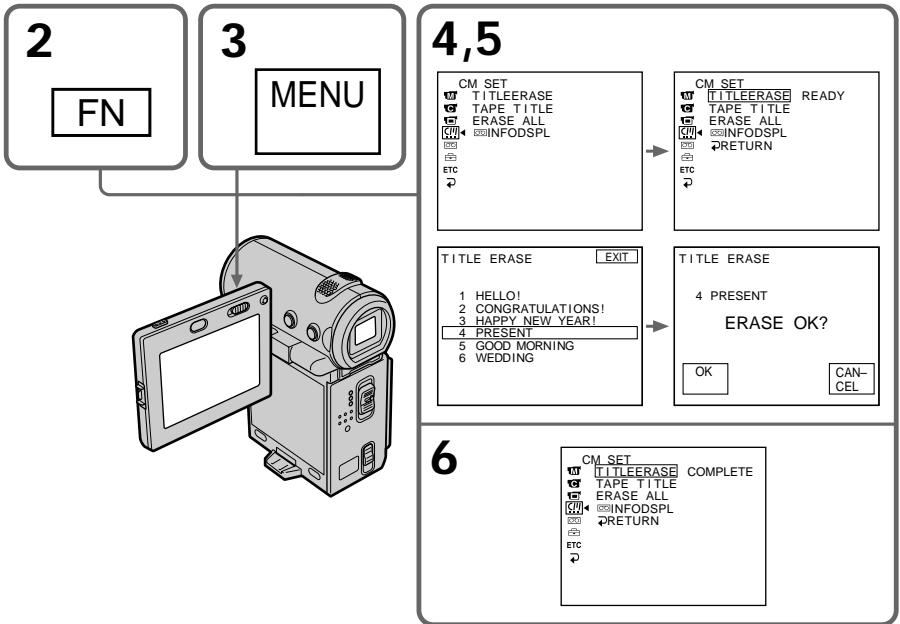



Illustration: In CAMERA mode

To return to the FN screen

Select , , then press the center ● on the control button after step 6. Next, select EXIT, then press the center ● on the control button.

To cancel erasing

Select CANCEL, then press the center ● on the control button in step 6.

Making your own titles

You can make up to two titles and store them in the memory of your camcorder. Each title can have up to 20 characters.

Making a title in CAMERA mode

- (1) Set the POWER switch to CAMERA.
- (2) Select FN, then press the center ● on the control button. The PAGE1 screen appears.
- (3) Select PAGE2, then press the center ● on the control button. The PAGE2 screen appears.
- (4) Select TITLE, then press the center ● on the control button. The TITLE SET screen appears.
- (5) Select , then press the center ● or ► on the control button.
- (6) Select CUSTOM1 SET or CUSTOM2 SET, then press the center ● on the control button.
- (7) Select the desired character button and press ● repeatedly to select the desired character on the button.
- (8) Select another character button, then press the center ● on the control button. The cursor moves to the next character. Repeat the same procedure as in steps 6 and 7 to complete your title.
- (9) Select SET, then press the center ● on the control button. The title is stored in memory.

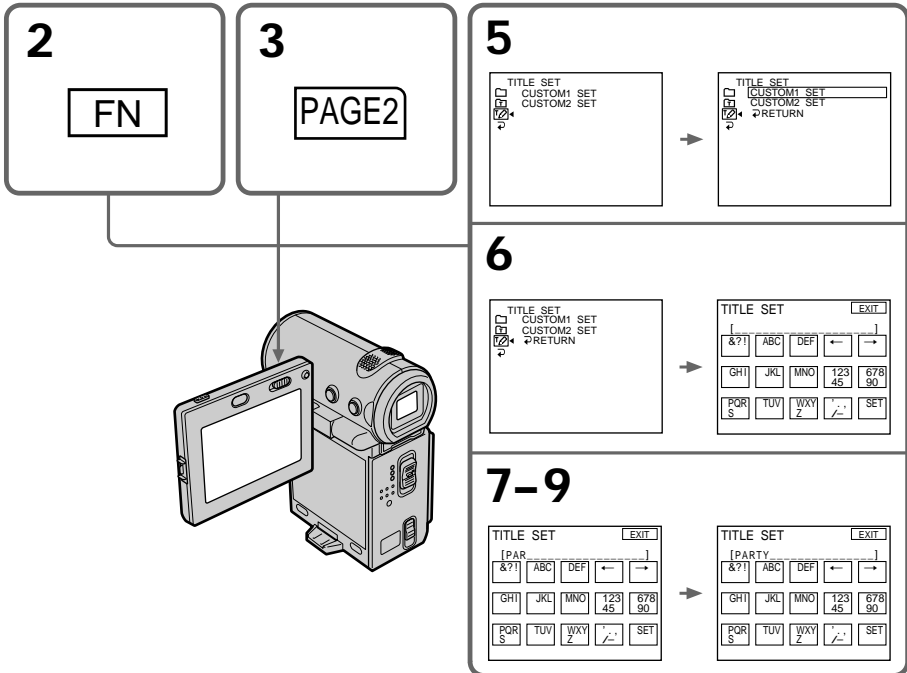

Making your own titles

To return to the FN screen

Select \rightarrow , then press the center ● on the control button after step 9. The PAGE2 screen appears. Next, select EXIT, then press the center ● on the control button.

To change the title you have stored

In step 5, select CUSTOM1 SET or CUSTOM2 SET, depending on which title you want to change, then press the center ● on the control button and then enter a new title as desired.

If you take 5 minutes or longer to enter characters in standby mode while a cassette is in your camcorder

The power automatically goes off. The characters you have entered remain stored in memory. Set the POWER switch to OFF (CHG) once and then to CAMERA again, then complete your title.

We recommend setting the POWER switch to VCR or removing the cassette so that your camcorder is not automatically turned off while you are entering title characters.

To erase the title

Select \leftarrow , then press the center ● on the control button. The last character is erased.

To enter a space

Select \rightarrow , then press the center ● on the control button.

To enter the same character on the same button in succession

Select \rightarrow , then press the center ● on the control button to move the cursor to the next position, and enter the character.

Making your own titles

Making a title in VCR mode

- (1) Set the POWER switch to VCR.
- (2) Select FN, then press the center ● on the control button. The PAGE1 screen appears.
- (3) Select TITLE, then press the center ● on the control button. The TITLE screen appears.
- (4) Select TITLE SET, then press the center ● on the control button. The TITLE SET screen appears.
- (5) Select CUSTOM1 SET or CUSTOM2 SET, then press the center ● on the control button.
- (6) Perform the same procedure as in steps 7 to 8 in “Making a title in CAMERA mode” on page 95.
- (7) Select SET, then press the center ● on the control button. The title is stored in memory.

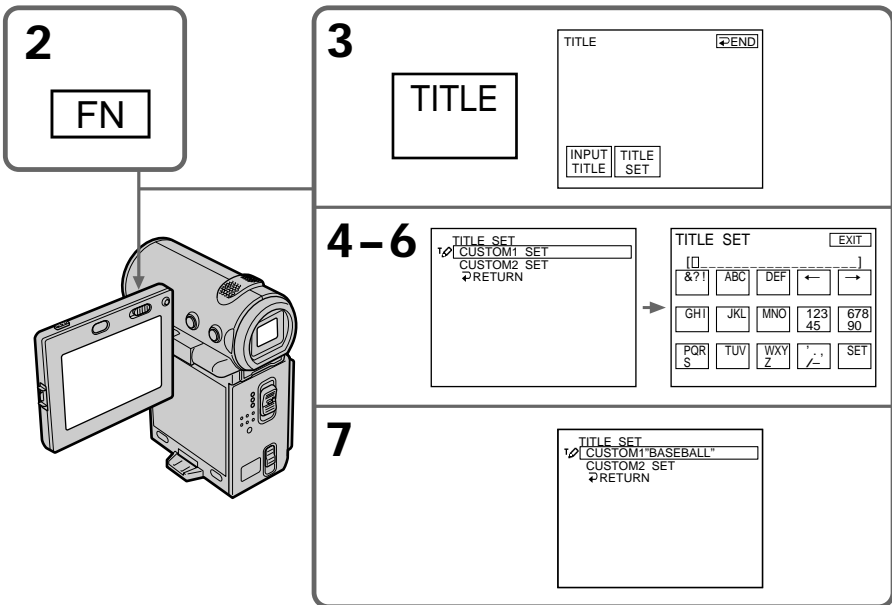

To return to the FN screen

Select ↵ RETURN, then press the center ● on the control button. The TITLE screen appears. Next, select ↵ ENDI, then press the center ● on the control button. Last, select EXIT, then press the center ● on the control button.

The Micro Cassette Memory

The MICROMV cassette automatically records the recording settings and date. You can also label a cassette. The label can consist of up to 16 characters and is stored in the Micro Cassette Memory. When you insert the labeled cassette and set the POWER switch to CAMERA or VCR, the label is displayed for about 5 seconds.

The cassette information

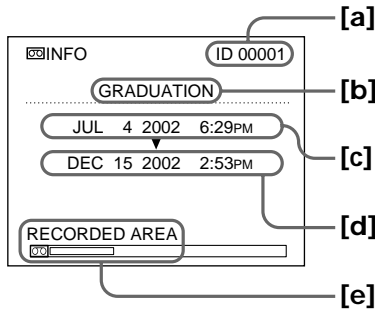

- [a] The unique number of each cassette. The camcorder automatically assign this number.
- [b] The cassette title set by the TAPE TITLE item in the menu settings (Cassette label).
- [c] The first-recorded date in this cassette.
- [d] The last-recorded date in this cassette.
- [e] The recorded area is indicated by the white bar.

The Micro Cassette Memory

Labeling a cassette

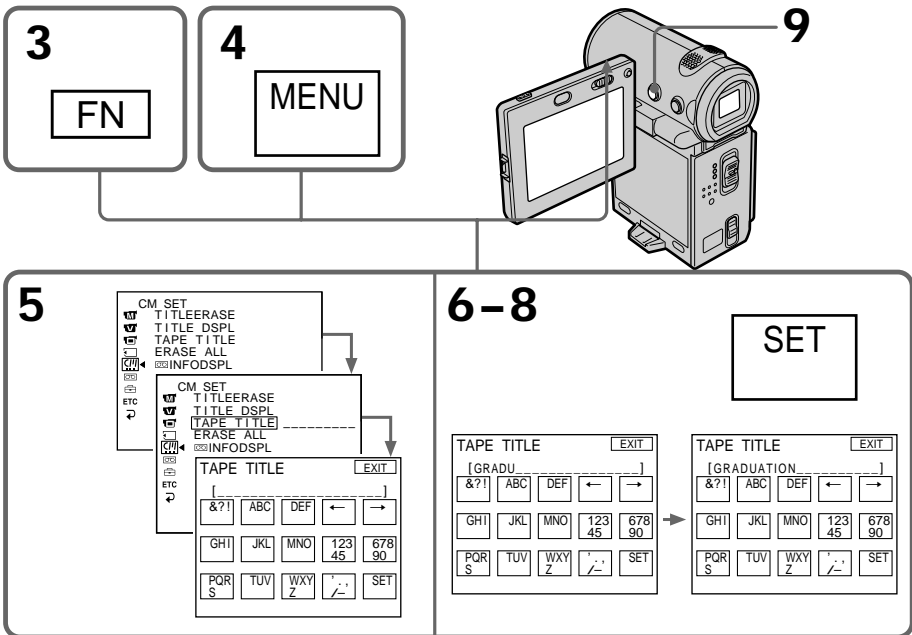

- (1) Insert the cassette you want to label.
- (2) Set the POWER switch to CAMERA or VCR.
- (3) Select FN, then press the center ● on the control button. The PAGE1 screen appears.
- (4) Select MENU, then press the center ● on the control button. The menu appears.
- (5) Select TAPE TITLE via , then press the center ● or ► on the control button.
- (6) Select the desired character button and press the center ● on the control button repeatedly to select the desired character on the button .
- (7) Select another character button, then press the center ● on the control button. The cursor moves to the next character. Repeat the same procedure as in steps 6 and 7 to complete the label.
- (8) Select SET, then press the center ● on the control button. The label is stored in memory.
- (9) Press DISPLAY to turn off the menu.

Editing



The Micro Cassette Memory

To return to the FN screen

Select , , then press the center ● on the control button after step 8. The PAGE1 screen appears. Next, select EXIT, then press the center ● on the control button.

To erase the label you have made

Select ←, then press the center ● on the control button in step 6. The last character is erased.

To change the label you have made

Insert the cassette for which you want to change the label, and proceed in the same way as you do to make a new label.

If you set the write-protect tab of the tape to lock

You cannot label the tape. Slide the write-protect tab to release the write protection.

Note on recorded areas

A blank portion between recorded areas is also indicated as a recorded area.

Note on cassette information

You can turn off the cassette information using the  INFODSPL item in the menu settings.

When "⌘" is flashing

Remove the cassette and insert it again. If the message is still displayed, the Micro Cassette Memory may be corrupted. Replace the cassette with another cassette.

To erase the title

Select ←, then press the center ● on the control button. The last character is erased.

To enter a space

Select →, then press the center ● on the control button.

To enter the same character on the same button in succession



Select →, then press the center ● on the control button to move the cursor to the next position, and enter the character.

Deleting all the data in the Micro Cassette Memory

You can delete all the data (cassette title, date, photo, thumbnail, and cassette information) in Micro Cassette Memory at once.

- (1) Set the POWER switch to CAMERA or VCR.
- (2) Select FN, then press the center ● on the control button. The PAGE1 screen appears.
- (3) Select MENU, then press the center ● on the control button. The menu appears.
- (4) Select ERASE ALL via , then press the center ● or ► on the control button.
- (5) Select ERASE OK?, then press the center ● on the control button.
- (6) Select OK, then press the center ● on the control button.
- (7) Select EXECUTE, then press the center ● on the control button. The message “ERASING” appears on the screen. Once deleting is completed, the message “COMPLETE” appears.
- (8) Press DISPLAY to turn off the screen indicators.

To return to the FN screen

Select , , then press the center ● on the control button after step 7. The PAGE1 screen appears. Next, select EXIT, then press the center ● on the control button.

To cancel deleting

Select RETURN in step 5 or 6, then press the center ● on the control button.

Note

Once you delete all the data in the Micro Cassette Memory, the following operations do not work:

- Multi-picture search
- Title search
- Date search
- Photo search

Note on the ID number

This item cannot be deleted.

Changing the menu settings

To change the mode settings in the menu settings, select the menu items with the control button. The default settings can be partially changed. First, select the icon, then the menu item, and then the mode.

- (1) In standby, MEMORY (DCR-IP7BT only) or VCR mode, select FN, then press the center ● on the control button. The PAGE1 screen appears.
- (2) Select MENU, then press the center ● on the control button. The menu appears.
- (3) Select the desired icon, then press the center ● or ► on the control button.
- (4) Select the desired item, then press the center ● or ► on the control button.
- (5) Select the desired setting, then press the center ● on the control button.
- (6) Repeat steps 3 to 5 if you want to change other items. To return to step 3, select ↶ RETURN, then press the center ● on the control button.

For details, see “Selecting the mode setting of each item” (p. 103).

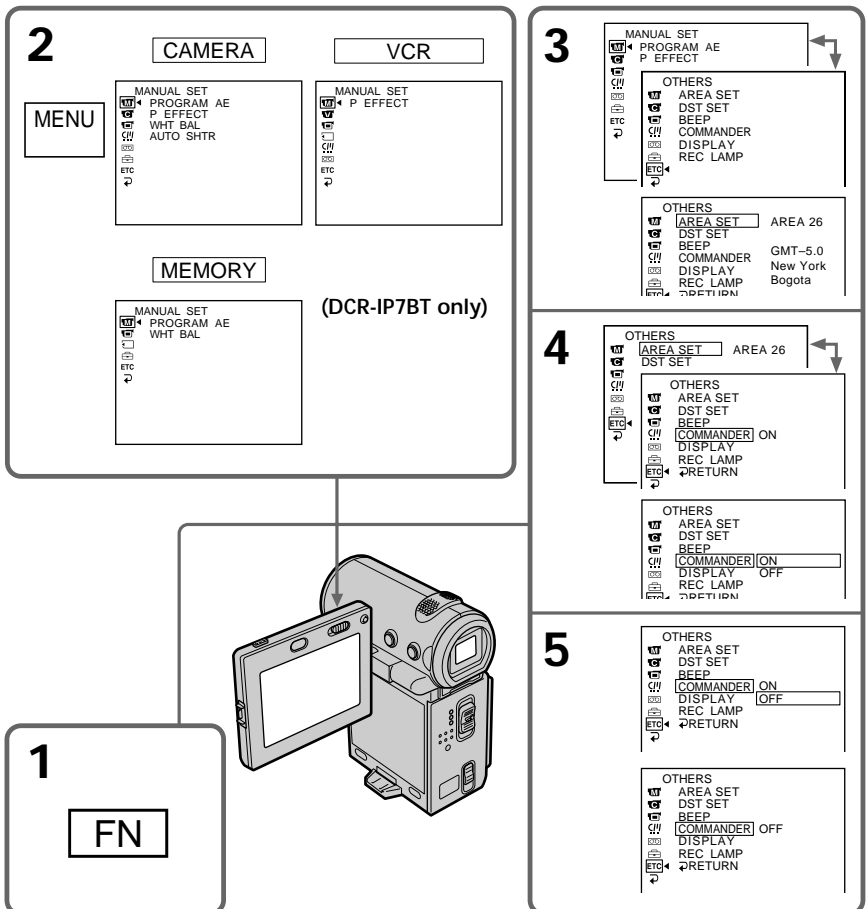



Changing the menu settings









To turn off the menu

After step 5, press DISPLAY to turn off the menu.

To return to the FN screen





After step 5, select , then press the center  on the control button. The PAGE1 screen appears. Next, select EXIT, then press the center  on the control button.

Menu items are displayed as the following icons:

-  MANUAL SET
-  CAMERA SET
-  VCR SET
-  LCD/VF SET
-  MEMORY SET (DCR-IP7BT only)
-  CM SET
-  TAPE SET
-  SETUP MENU
-  OTHERS

Selecting the mode setting of each item is the default setting.

Menu items differ depending on the position of the POWER switch. The screen shows only the items you can operate at the moment. The MEMORY position of the POWER switch is only available for the DCR-IP7BT.

Icon/item	Mode	Meaning	POWER switch
 PROGRAM AE	---	To suit your specific shooting requirements (p. 59).	CAMERA MEMORY
P EFFECT	---	To add special effects like those in films or on TV to images (p. 54).	CAMERA VCR
WHT BAL	---	To adjust the white balance (p. 62).	CAMERA MEMORY
AUTO SHTR	 ON	To automatically activate the electronic shutter when shooting in bright conditions.	CAMERA
	OFF	To deactivate the electronic shutter even when shooting in bright conditions.	
 D ZOOM	 OFF	To deactivate the digital zoom. Up to 10× zoom is carried out.	CAMERA
	20×	To activate the digital zoom. More than 10× to 20× zoom is performed digitally (p. 34).	
	120×	To activate the digital zoom. More than 10× to 120× zoom is performed digitally (p. 34).	
16:9WIDE	 OFF	—	CAMERA
	ON	To record a 16:9 wide picture (p. 49).	

Changing the menu settings

Icon/item	Mode	Meaning	POWER switch
[G] STEADYSHOT	● ON	To compensate for camera-shake.	CAMERA
	OFF	To cancel the SteadyShot function. Natural pictures are produced when shooting a stationary object with a tripod.	
[V] VIDEOINPUT	● VIDEO	To use the video plug of the A/V connecting cable when recording from a player.	VCR
	S VIDEO	To use the S video plug of the A/V connecting cable when recording from a player.	
[C] LCD COLOR	---	To adjust the color on the LCD screen with ◀/▶.	CAMERA MEMORY VCR
			
VF B.L.	● BRT NORMAL	To set the brightness on the viewfinder screen to normal.	CAMERA MEMORY
	BRIGHT	To brighten the viewfinder screen.	
[M] * STILL SET			
PIC MODE	● SINGLE	To not record continuously.	MEMORY
	MULTI SCRN	To record nine images continuously (p. 119).	
QUALITY	● FINE	To record still images in the fine image quality mode.	MEMORY VCR
	STANDARD	To record still images in the standard image quality mode.	

* DCR-IP7BT only

Notes on the SteadyShot function

The SteadyShot function may not work properly in the following cases:

- When the camera shake is excessive.
- When shooting in dark conditions.
- When the contrast of the subject and its background is low.
- When the subject is in vertical stripes.
- When shooting a moving subject.
- When attaching a conversion lens (optional).

If you cancel the SteadyShot function

The SteadyShot off indicator  appears. Your camcorder prevents excessive compensation for camera-shake.

Notes on VF B.L.

When you select "BRIGHT," the battery life is reduced by about 10 percent during recording.

When you use a power source other than the battery pack

VF B.L. is automatically set to BRIGHT.

Changing the menu settings

Icon/item	Mode	Meaning	POWER switch
 * MOVIE SET			
MOVIE MODE	● SUPER FINE	To record moving pictures with super fine image quality.	MEMORY VCR
	FINE	To record moving pictures with fine image quality.	
	STANDARD	To record moving pictures with standard image quality.	
	LIGHTMODE	To record moving pictures to be used as an e-mail attachment.	
SLIDE SHOW	---	To play back images in a continuous loop (p. 147).	MEMORY
DELETE ALL	---	To delete all unprotected images (p. 152).	MEMORY
FORMAT	● RETURN	To cancel formatting.	MEMORY
	OK	To format the inserted "Memory Stick." 1. Select FORMAT, then press the center ● on the control button. 2. Select OK, then press the center ● on the control button. 3. After "EXECUTE" appears, select EXECUTE, then press the center ● on the control button. "FORMATTING" flashes during formatting. "COMPLETE" appears when formatting is finished.	
PHOTO SAVE	---	To duplicate still images on the tape and save them onto the "Memory Stick" (p. 135).	VCR

* DCR-IP7BT only

Notes on formatting (DCR-IP7BT only)

- The "Memory Stick" supplied with your camcorder has been formatted at the factory. Formatting with your camcorder is not required.
- Do not slide the POWER switch or press any button while "FORMATTING" is displayed.
- You cannot format the "Memory Stick" if its write-protect switch is set to LOCK.
- Format the "Memory Stick" if "FORMAT ERROR" appears.







Formatting erases all information on the "Memory Stick" (DCR-IP7BT only)

Check the contents of the "Memory Stick" before formatting.

- Formatting erases sample images on the "Memory Stick."
- Formatting erases protected image data on the "Memory Stick."

(continued on the following page)

Changing the menu settings

Icon/item	Mode	Meaning	POWER switch
 TITLEERASE	---	To erase a superimposed title (p. 94).	CAMERA VCR
TITLE DSPL	● ON	To display a superimposed title.	VCR
	OFF	To not display the title.	
TAPE TITLE	---	To label a cassette (p. 99).	CAMERA VCR
ERASE ALL	---	To erase all the data in the Micro Cassette Memory (p. 101).	CAMERA VCR
 INFODSPL	● ON	To display the cassette information of the tape. This is displayed for 5 seconds in the following cases: (p. 98). • When turning on the power with a cassette inserted or inserting a cassette. • When entering the VCR mode using the POWER switch.	CAMERA VCR
	OFF	To not display the cassette information of the tape.	
  REMAIN	● AUTO	To display the remaining tape bar: • for about 8 seconds after your camcorder is turned on or a cassette is inserted, and also calculate the remaining amount of tape. • for about 8 seconds after you select  and you press the center ● on the control button or DISPLAY is pressed to display the screen indicators. • During fast-forwarding or rewinding the tape.	CAMERA VCR
	ON	To always display the remaining tape indicator.	
 CLOCK SET	---	To set the date or time (p. 23).	CAMERA MEMORY
LTR SIZE	● NORMAL	To display the selected menu item in normal size.	CAMERA MEMORY VCR
	2×	To display the selected menu item at twice the normal size.	
DEMO MODE	● ON	To make the demonstration appear.	CAMERA
	OFF	To cancel the demonstration mode.	

Notes on DEMO MODE

- You cannot select DEMO MODE when a cassette is inserted in your camcorder.
- DEMO MODE is set to STBY (Standby) as the default setting and the demonstration starts about 10 minutes after you have set the POWER switch to CAMERA without a cassette inserted.

To cancel the demonstration, insert a cassette, set the POWER switch to a position other than CAMERA, or set DEMO MODE to OFF. To set to STBY (Standby) again, leave the DEMO MODE to ON in the menu settings, set the POWER switch to OFF (CHG), and slide the POWER switch to CAMERA.

Changing the menu settings

Icon/item	Mode	Meaning	POWER switch
ETC DATA CODE*	● DATE/CAM	To display date, time and various settings during playback.	MEMORY VCR
	DATE	To display date and time during playback.	
AREA SET	---	To set your area temporarily, when using the camcorder, in a new location (p. 25).	CAMERA MEMORY
DST SET	● OFF	To be used when your area is not in daylight saving time.	CAMERA MEMORY
	ON	To be used when your area is in daylight saving time.	
BEEP	● MELODY	To output a melody when you start/stop recording or when an unusual condition occurs on your camcorder.	CAMERA MEMORY VCR
	NORMAL	To output a beep instead of the melody.	
	OFF	To cancel both the melody and beep sound.	
COMMANDER	● ON	To activate the Remote Commander supplied with your camcorder.	CAMERA MEMORY VCR
	OFF	To deactivate the Remote Commander to avoid remote control misoperation caused by remote control of other VCRs.	
DISPLAY	● LCD	To show the indicators on the LCD screen and viewfinder.	CAMERA MEMORY VCR
	V-OUT/LCD	To show the indicators on the TV screen, LCD screen and viewfinder.	
REC LAMP	● ON	To light up the camera recording lamp at the front of your camcorder.	CAMERA MEMORY
	OFF	To turn the camera recording lamp off so that the subject is not aware of your recording.	

* Using the Remote Commander only

Note

If you press DISPLAY with "DISPLAY" set to "V-OUT/LCD" in the menu settings, the picture from the TV or VCR will not appear on the screen even when your camcorder is connected to outputs on the TV or VCR.

Even if the power source is detached from the camcorder

The menu items settings will be retained even if you remove the power source.

When recording a close subject

When REC LAMP is set to ON, the red camera recording lamp on the front of the camcorder may reflect on the subject if it is too close. In this case, we recommend you set REC LAMP to OFF.

Using a “Memory Stick” – introduction

– DCR-IP7BT only

You can record an image onto the “Memory Stick” and easily play it back on your camcorder. The following functions are also available using the “Memory Stick.”

- To capture an image recorded on the tape using the “Memory Stick.”
- To duplicate a still image recorded on the “Memory Stick” onto the tape.
- To duplicate an image and save it to your computer via the supplied USB cable.
- To delete an image, protect an image, and write a print mark.

On file format

Still image (JPEG)

Your camcorder compresses image data in the JPEG format (file extension .jpg).

Moving picture (MPEG)

Your camcorder compresses picture data in the MPEG format (file extension .mpg).

Typical image data file name

Still image

100-0001: This file name appears on the screen of your camcorder.

Dsc00001.jpg: This file name appears on the display of your computer.

Moving picture

MOV10001: This file name appears on the screen of your camcorder.

Mov10001.mpg: This file name appears on the display of your computer.

Using a “Memory Stick”

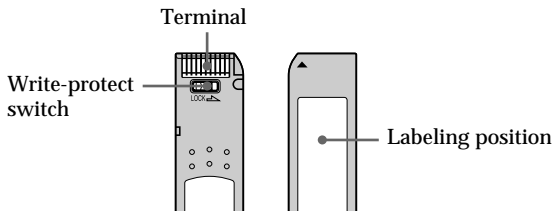

- You cannot record or erase images when the write-protect switch on the “Memory Stick” is set to LOCK.
- The position and shape of the write protect switch may be different depending on the model.
- We recommend backing up important data.
- Image data may be damaged in the following cases:
 - If you remove the “Memory Stick,” turn the power off or detach the battery for replacement when the access lamp is flashing.
 - If you use “Memory Stick”’s near magnets or magnetic fields such as those of speakers and televisions.

Using a “Memory Stick” – introduction

- Prevent metallic objects or your finger from coming into contact with the metal parts of the connecting section.
- Stick its label on the labeling position.
- Do not bend, drop or apply strong shock to “Memory Stick”s.
- Do not disassemble or modify “Memory Stick”s.
- Do not let “Memory Stick”s get wet.
- Do not use or keep “Memory Stick”s in locations that are:
 - Extremely hot such as in a car parked in the sun or under the scorching sun.
 - Under direct sunlight.
 - Very humid or subject to corrosive gases.
- When you carry or store a “Memory Stick,” put it in its case.

“Memory Stick”s formatted by a computer

“Memory Stick”s formatted by the Windows OS or Macintosh computers does not have guaranteed compatibility with this camcorder.

Notes on image data compatibility

- Image data files recorded on “Memory Stick”s by your camcorder conform with the Design rule for Camera File system universal standard established by the JEITA (Japan Electronics and Information Technology Industries Association).
On your camcorder, you cannot play back still images recorded on other equipment (DCR-TRV890E/TRV900/TRV900E or DSC-D700/D770) that does not conform to this universal standard. (These models are not sold in some areas.)
- If you cannot use the “Memory Stick” that is used with other equipment, format it with this camcorder (p. 105). However, formatting erases all information on the “Memory Stick.”

“Memory Stick” and  are trademarks of Sony Corporation.

-
- Windows and Windows Media are either registered trademarks or trademarks of Microsoft Corporation in the United States and/or other countries.
 - Macintosh and Mac OS, QuickTime are trademarks of Apple Computer, Inc.
 - Pentium is either a registered trademark or trademark of Intel Corporation.
 - All other product names mentioned herein may be the trademarks or registered trademarks of their respective companies.
- Furthermore, “™” and “®” are not mentioned in each case in this manual.

Using a "Memory Stick" – introduction

Inserting a "Memory Stick"

Insert a "Memory Stick" in the "Memory Stick" slot as far as it can go with the ▲ mark facing up as illustrated.

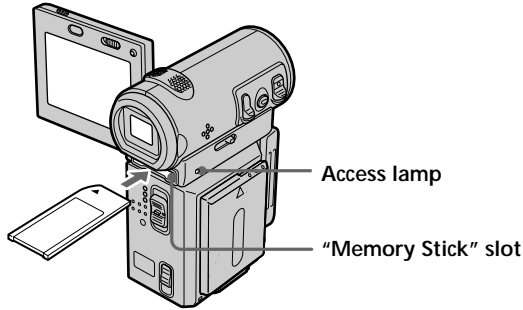

Ejecting the "Memory Stick"

Slide the MEMORY EJECT lever in the direction of the arrow.

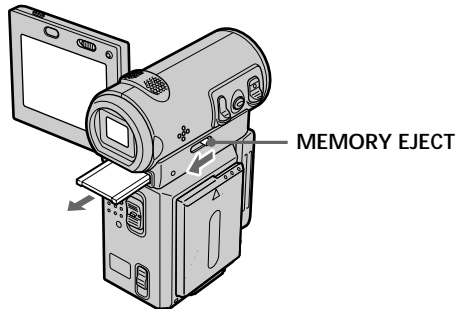

While the access lamp is lit or flashing

Do not shake or strike your camcorder because your camcorder is reading the data from the "Memory Stick" or recording data on the "Memory Stick." Do not turn the power off, eject the "Memory Stick" or remove the battery pack. Otherwise, the image data may be corrupted.

If "MEMORYSTICK ERROR" is displayed

Remove the "Memory Stick," then insert it again. If the message is still displayed, the "Memory Stick" may be corrupted. Use another "Memory Stick."

Using a "Memory Stick" – introduction

Using a button displayed on the screen

Your camcorder has operation buttons on the screen. Use the control button to operate the buttons on the screen.

- (1) Set the POWER switch to MEMORY.
- (2) Press OPEN to open the LCD panel. Operation buttons appear on the LCD screen. You can switch the memory playback/memory camera modes by selecting PLAY/CAM.
- (3) Select FN, then press the center ● on the control button. The PAGE1 screen appears. Operation buttons appear on the screen.
- (4) Select PAGE2, then press the center ● on the control button. The PAGE2 screen appears. Operation buttons appear on the screen.
- (5) Select PAGE3, then press the center ● on the control button. The PAGE3 screen appears. Operation buttons appear on the screen.
- (6) Select a desired operation item, then press the center ● on the control button. Refer to the relevant pages for each function.

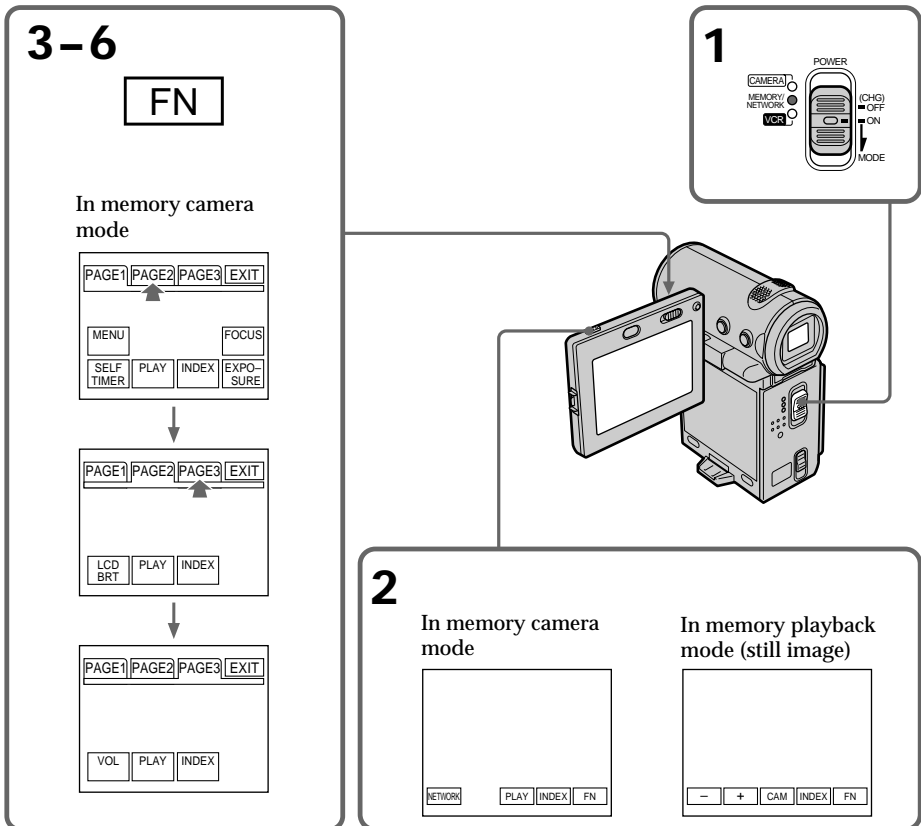

Using a “Memory Stick” – introduction

To return to the FN screen

Select EXIT, then press the center ● on the control button.

To execute settings

Select ↵ OK, then press the center ● on the control button.

If the item is not available

The color of the item changes to gray.

Select FN, then press the center ● on the control button to display the following buttons:

In memory camera mode

PAGE1	MENU, SELF TIMER, PLAY, INDEX, EXPOSURE, FOCUS
PAGE2	LCD BRT, PLAY, INDEX
PAGE3	VOL, PLAY, INDEX

In memory playback mode

PAGE1	MENU, CAM, INDEX, DELETE, +, -
PAGE2	LCD BRT, CAM, INDEX, PB ZOOM, +, -
PAGE3	DATA CODE, CAM, INDEX, +, -

Using a "Memory Stick" – introduction

Selecting the still image quality mode

You can select the image quality mode for still image recording. The default setting is FINE.

- (1) Set the POWER switch to MEMORY.
- (2) Select FN, then press the center ● on the control button. The PAGE1 screen appears.
- (3) Select MENU, then press the center ● on the control button. The menu appears.
- (4) Select , then press the center ● or ► on the control button.
- (5) Select STILL SET, then press the center ● or ► on the control button.
- (6) Select QUALITY, then press the center ● or ► on the control button.
- (7) Select the desired image quality mode, then press the center ● on the control button.
- (8) Press DISPLAY to turn off the menu.

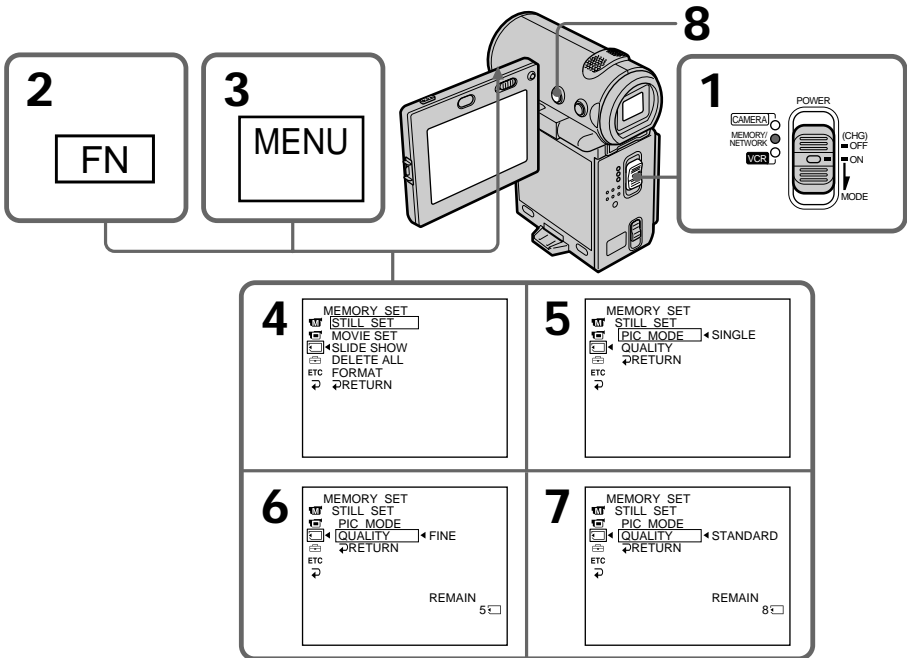

Using a “Memory Stick” – introduction

To return to the FN screen

Select \Rightarrow RETURN, \Rightarrow , then press the center \bullet on the control button after step 7. The PAGE1 screen appears. Next, select EXIT, then press the center \bullet on the control button.

Image quality settings

Setting	Meaning
FINE (Indicator: FINE)	Use this mode when you want to record high quality images. The image is compressed to about 1/6.
STANDARD (Indicator: STD)	This is the standard image quality. The image is compressed to about 1/10.

Approximate number of still images you can record on a “Memory Stick”

The number of images you can record varies depending on which image quality mode you select. The table below indicates the numbers when using a “Memory Stick” formatted with this camcorder.

Quality	“Memory Stick”					
	128 MB*	64 MB*	32 MB*	16 MB*	8 MB	4 MB*
FINE	1310 images	650 images	325 images	160 images	80 images	39 images
STANDARD	1970 images	980 images	485 images	240 images	120 images	58 images

* Optional

Note

In some cases, changing the image quality mode may not affect the image quality, depending on the types of images you are shooting.

Differences in image quality mode

Recorded images are compressed in the JPEG format before being stored in memory. The memory capacity allotted to each image varies depending on the selected image quality mode. Details are shown in the table below. (The image size is 640×480 , regardless of image quality mode. The data size before compression is about 600 KB.)

Image quality mode	Memory capacity
FINE (FINE)	About 100 KB
STANDARD (STD)	About 60 KB

Image quality mode indicator

The image quality mode indicator is not displayed during playback.

Using a "Memory Stick" – introduction

Setting the moving picture quality mode



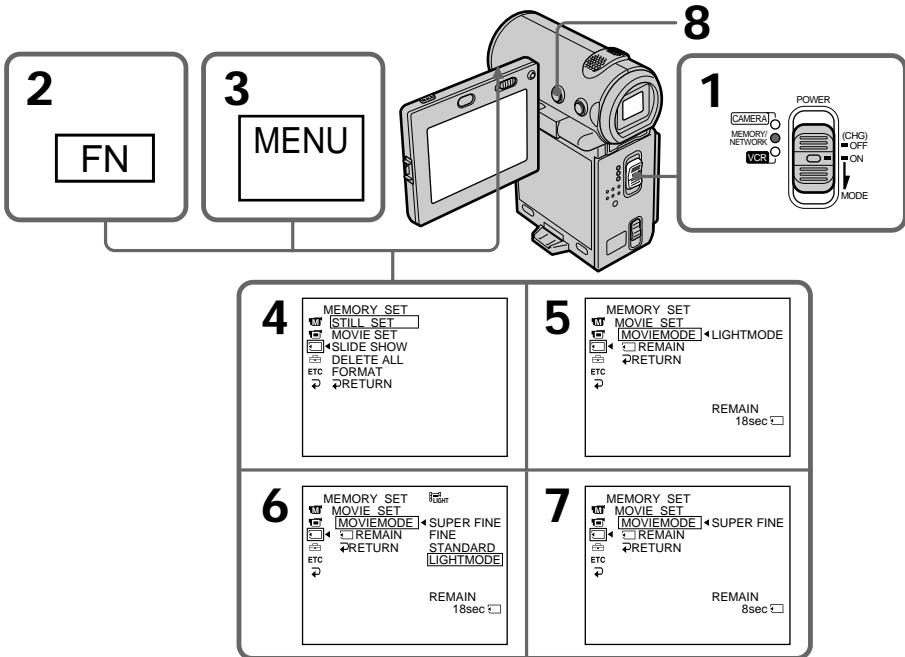

You can select the moving picture quality mode. The default setting is SUPER FINE.

- (1) Set the POWER switch to MEMORY.
- (2) Select FN, then press the center ● on the control button. The PAGE1 screen appears.
- (3) Select MENU, then press the center ● on the control button. The menu appears.
- (4) Select , then press the center ● or ► on the control button.
- (5) Select MOVIE SET, then press the center ● or ► on the control button.
- (6) Select MOVIEMODE, then press the center ● or ► on the control button.
- (7) Select the desired movie mode, then press the center ● on the control button.
- (8) Press DISPLAY to turn off the menu.



Using a “Memory Stick” – introduction

Image quality settings

Setting	Meaning	Frame rate	Transmission rate (image and audio)	Indicator (during playback)
SUPER FINE (Indicator: SFN)	Records moving pictures at 352 × 240.	30 fps	1200 Kbps	
FINE (Indicator: FINE)	Records moving pictures at 352 × 240.	30 fps	750 Kbps	
STANDARD (Indicator: STD)	Records moving pictures at 144 × 96.	10 fps	400 Kbps	
LIGHTMODE (Indicator: LIGHT)	Records moving pictures at 144 × 96.	10 fps	200 Kbps	

SUPER FINE: You can record moving pictures at the highest quality. This mode is suitable when you intend to modify the pictures using your computer. SUPER FINE is the default setting of the camcorder.

FINE: You can record moving pictures for a longer time than with the SUPER FINE mode, the quality, however, declines slightly.

STANDARD: You can record moving pictures for a longer time than with the FINE mode, the image size, however, is smaller.

LIGHTMODE: Since the file size is small, this mode is suitable for e-mail transmission. The image quality, however, declines.

Note on frame rate

A moving picture consists of continuous still images. Frame rate indicates the number of images played back in one second. The more the number increases, the more natural the moving picture becomes.

Note on transmission rate

The higher the transmission rate, the more natural the moving picture becomes.

Maximum recording time for moving pictures

Image quality mode	Maximum recording time
SUPER FINE	45 s
FINE	1 min 10 s
STANDARD	2 min 20 s
LIGHTMODE	4 min 40 s

Using a "Memory Stick" – introduction

Approximate length of time of the moving pictures you can record on a "Memory Stick"

The table below indicates the recordable time when using a "Memory Stick" formatted with this camcorder.

Quality	"Memory Stick"					
	128 MB*	64 MB*	32 MB*	16 MB*	8 MB	4 MB*
SUPER FINE	13 min	6 min	3 min	1 min	45 s	20 s
FINE	20 min	10 min	5 min	2 min	1 min	35 s
STANDARD	41 min	20 min	10 min	5 min	2 min	1 min
LIGHTMODE	82 min	41 min	20 min	10 min	5 min	2 min

* Optional

Recording still images on a “Memory Stick” – Memory Photo recording

– DCR-IP7BT only

You can record still images on a “Memory Stick.” You can also record nine still images continuously. (MULTI SCRNL)

Before operation

Insert the “Memory Stick” into your camcorder.

- (1) Set the POWER switch to MEMORY.
- (2) Keep pressing PHOTO lightly. The green ● mark stops flashing, then lights up. The brightness of the image and focus are adjusted, being targeted for the middle of the image and are fixed. Recording does not start yet.
- (3) Press PHOTO deeper. The image displayed on the screen will be recorded on the “Memory Stick.” Recording is complete when the bar scroll indicator disappears.

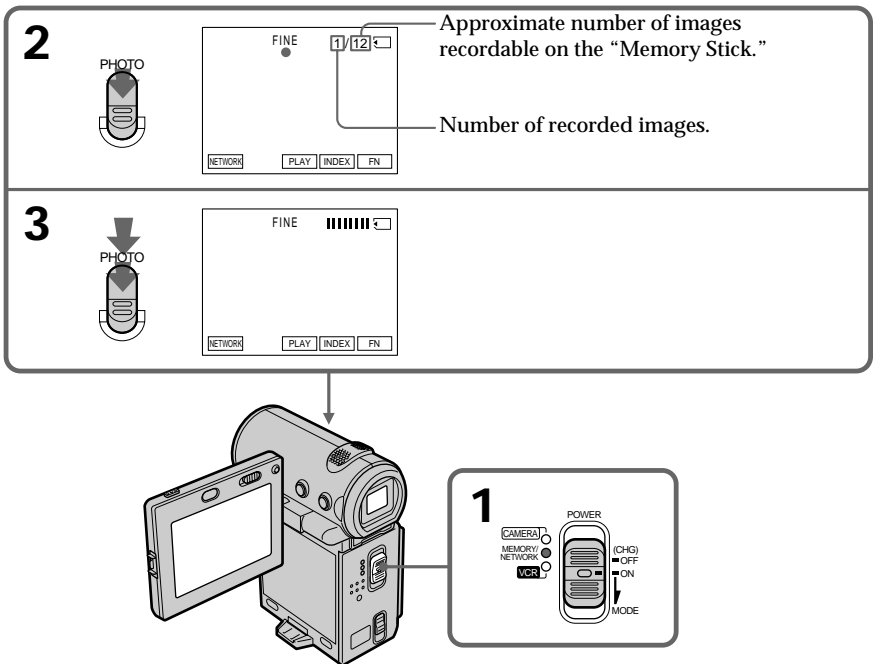

Recording still images on a “Memory Stick” – Memory Photo recording

When the POWER switch is set to MEMORY

The following functions do not work:

- Wide mode
- Digital zoom
- SteadyShot
- Fader
- Picture effect
- Digital effect
- Title
- Low lux mode of PROGRAM AE (The indicator flashes.)

While you are recording a still image

You can neither turn off the power nor press PHOTO.

When you press PHOTO on the Remote Commander

Your camcorder immediately records the image displayed on the screen when you press the button.

When recording a still image in step 2

The image momentarily flickers. This is not a malfunction.

Recording data

The recording data (date/time or various settings used when recording) are not displayed while recording. However, they are automatically recorded onto the “Memory Stick.”

To display the recording data, press DATA CODE on the Remote Commander. When using the camcorder for this operation, select CAM DATA or DATE DATA, then press the center ● on the control button, via DATA CODE on the PAGE3 screen (p. 41).

The number of still images recordable on a “Memory Stick”

It varies according to the image quality mode and the complexity of the subject.

Recording images continuously

You can record still images continuously. Select the multi screen mode described below before recording.

Multi screen mode

Your camcorder shoots nine still images at about 0.5 sec intervals and displays the images on a single page divided into 9 boxes. (Indicator: )



Recording still images on a "Memory Stick" - Memory Photo recording

- (1) Set the POWER switch to MEMORY.
- (2) Select FN, then press the center ● on the control button. The PAGE1 screen appears.
- (3) Select MENU, then press the center ● on the control button. The menu appears.
- (4) Select , then press the center ● or ► on the control button.
- (5) Select STILL SET, then press the center ● or ► on the control button.
- (6) Select PIC MODE, then press the center ● or ► on the control button.
- (7) Select MULTI SCRNR, then press the center ● on the control button.
- (8) Press DISPLAY to turn off the menu.

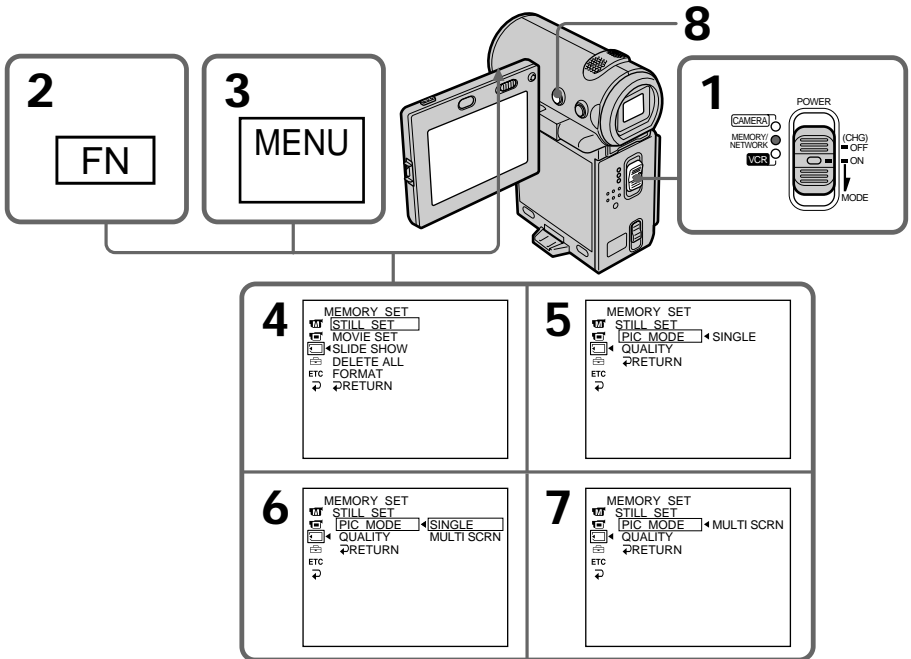

To return to the FN screen

Select RETURN, then press the center ● on the control button after step 7. The PAGE1 screen appears. Next, select EXIT, then press the center ● on the control button.

If the capacity of the "Memory Stick" becomes full

"FULL" appears on the screen, and you cannot record still images on this "Memory Stick."

Recording still images on a “Memory Stick” – Memory Photo recording

Self-timer memory photo recording

You can record images on a “Memory Stick” with the self-timer. You can also use the Remote Commander for this operation.

- (1) Set the POWER switch to MEMORY.
- (2) Select FN, then press the center ● on the control button. The PAGE1 screen appears.
- (3) Select SELF TIMER, then press the center ● on the control button. The ☺ (self-timer) indicator appears on the screen.
- (4) Press DISPLAY to turn off the screen buttons.
- (5) Press PHOTO firmly.

The self-timer starts counting down from 10 with a beep sound. In the last 2 seconds of the countdown, the beep sound gets faster, then recording starts automatically.

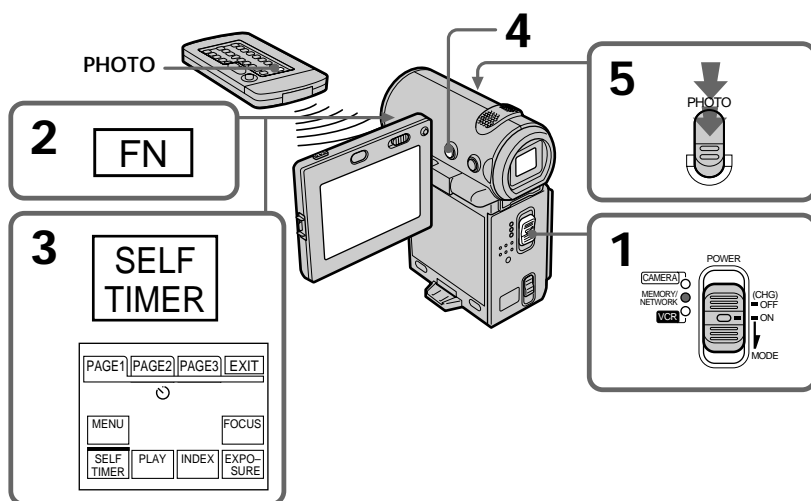

“Memory Stick” Operations

To record moving pictures on a “Memory Stick” with the self-timer

Press START/STOP in step 5. To stop the recording, press START/STOP again.

To cancel the self-timer recording

Select SELF TIMER on the PAGE1 screen, then press the center ● on the control button before the shutter is fired so that the ☺ (self-timer) indicator disappears from the screen. You cannot cancel the self-timer recording using the Remote Commander.

Recording still images on a “Memory Stick” - Memory Photo recording

Note

The self-timer recording mode is automatically canceled when:

- The self-timer recording is finished.
- The POWER switch is set to OFF (CHG) or VCR.

Recording an image from a tape as a still image



- DCR-IP7BT only

Your camcorder can read moving picture data recorded on a tape and record it on a "Memory Stick" as a still image.

Your camcorder can also take in moving picture data through the input jack and record it as a still image on a "Memory Stick."

Before operation

- Insert a recorded tape into your camcorder.
- Insert a "Memory Stick" into your camcorder.

- (1) Set the POWER switch to VCR.
- (2) Select , then press the center  on the control button. The picture recorded on the tape is played back.
- (3) Keep pressing PHOTO lightly until the picture from the tape freezes. "CAPTURE" appears on the screen. Recording does not start yet.
- (4) Press PHOTO deeper. The image displayed on the screen will be recorded on the "Memory Stick." Recording is complete when the bar scroll indicator disappears.

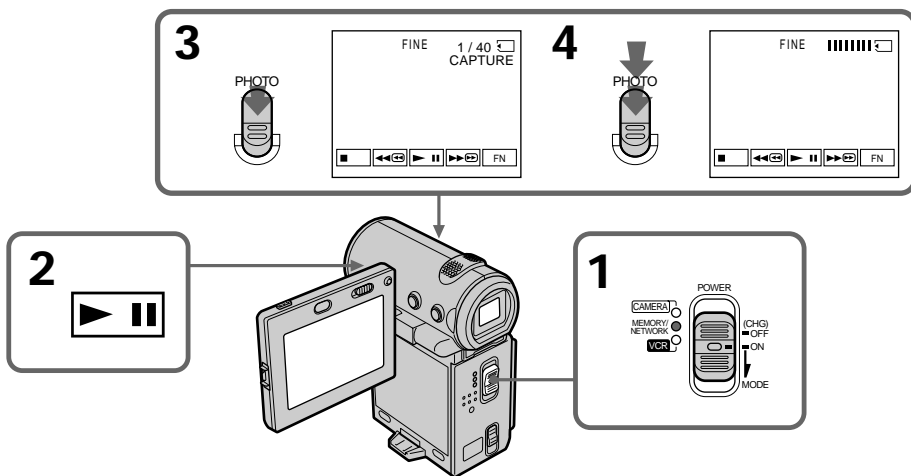

When the access lamp is lit or flashing

Do not shake or strike the camcorder. Also, do not turn the power off, eject the "Memory Stick" or remove the battery pack. Otherwise, the image data may be corrupted.

If "" appears on the screen

The inserted "Memory Stick" is incompatible with your camcorder because its format does not conform with that used by your camcorder. Check the format of the "Memory Stick."

Recording an image from a tape as a still image

If you press PHOTO lightly in the playback mode
Your camcorder stops momentarily.

Sound recorded on a tape
You cannot record the audio from the tape.

Titles which have already been recorded on tapes
You cannot record the titles on a "Memory Stick." The title does not appear while you are recording a still image with PHOTO.

Recording date/time
The date/time when it is recorded on the "Memory Stick" is recorded. Various settings are not recorded.

When you press PHOTO on the Remote Commander
Your camcorder immediately records the image that is on the screen when you press the button.

Recording a still image from other equipment

Before operation
Set DISPLAY in **ETC** to LCD in the menu settings (p. 102). (The default setting is LCD.)

- (1) Set the POWER switch to VCR.
- (2) When using the A/V connecting cable, set VIDEOINPUT to the appropriate position depending on the player (p. 84).
- (3) Play back the recorded tape.
The image from the other equipment is displayed on the screen.
- (4) Follow steps 3 and 4 on page 123.

Using the A/V connecting cable

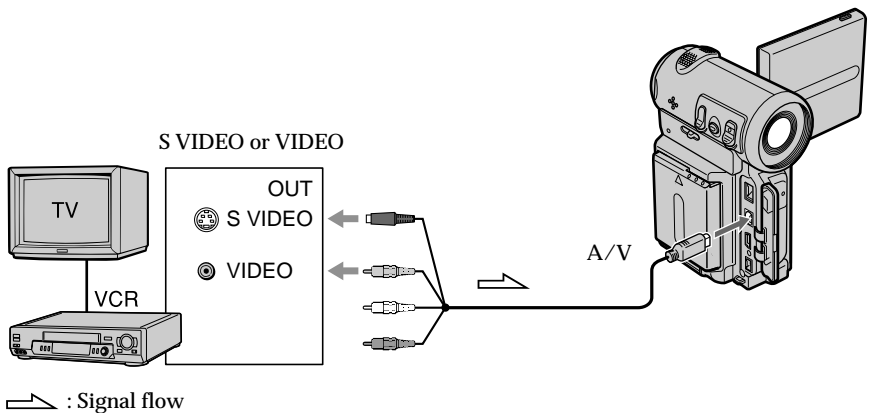

Connect the yellow or black plug of the A/V connecting cable to the video or S video jack on the VCR.

Recording an image from a tape as a still image

If your VCR has an S VIDEO jack

Connect using the S video plug to faithfully obtain original pictures. With this connection, you do not need to connect the yellow (video) plug of the A/V connecting cable. Connect the S video plug to the S video jack of the VCR. This connection produces higher quality MICROMV format pictures.

Using the i.LINK cable

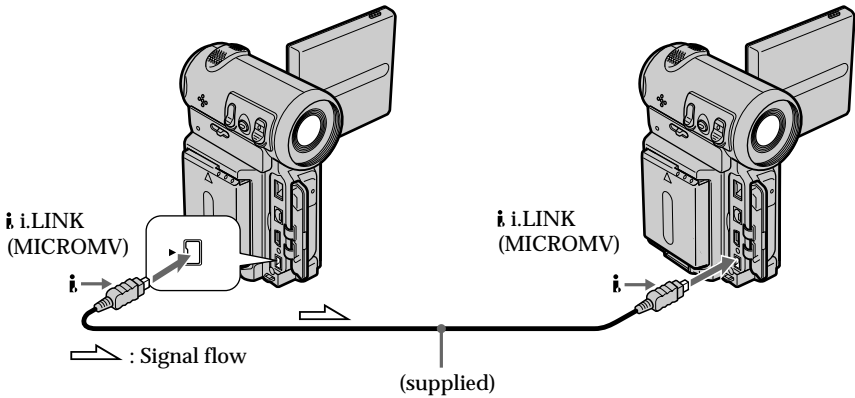

Note

"" flashes in the following instances. If this happens, eject and insert the "Memory Stick" again, and record distortion-free images.

- When recording on a tape in a poor recording state, for example, on a tape that has been repeatedly used for dubbing.

Recording moving pictures on a “Memory Stick” – MPEG movie recording

– DCR-IP7BT only

You can record moving pictures with sound on a “Memory Stick.”

Before operation

Insert the “Memory Stick” into your camcorder.

- (1) Set the POWER switch to MEMORY.
- (2) Press START/STOP. Your camcorder starts recording. The camera recording lamp located on the front of your camcorder lights up.

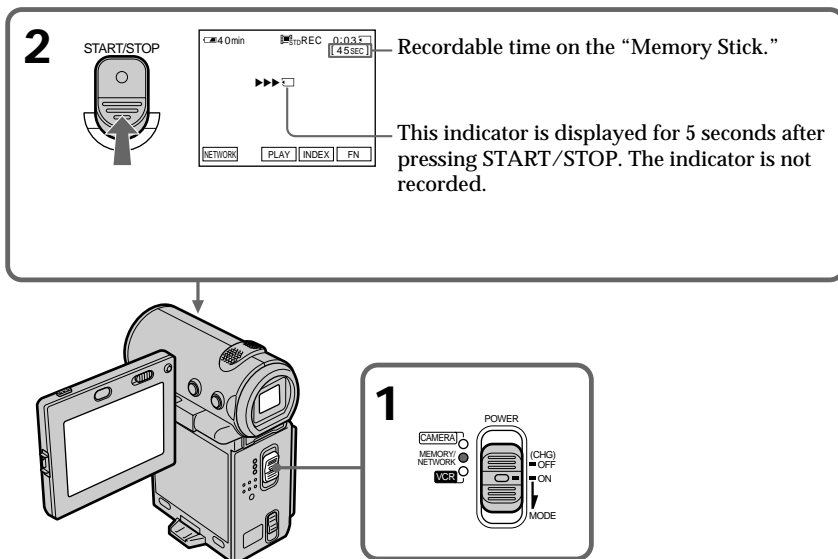

The recordable time for an MPEG movie

Quality mode	recordable time
SUPER FINE	Maximum 45 s
FINE	Maximum 1 min 10 s
STANDARD	Maximum 2 min 20 s
LIGHTMODE	Maximum 4 min 40 s

To stop recording

Press START/STOP.

Recording moving pictures on a “Memory Stick” - MPEG movie recording

Note

Sound is recorded in monaural.

When the POWER switch is set to MEMORY

The following functions do not work:

- Wide mode
- Digital zoom
- SteadyShot
- Fader
- Picture effect
- Digital effect
- Title
- Low lux of PROGRAM AE (The indicator flashes.)

Recording date/time

The date/time are not displayed while recording. However, they are automatically recorded onto the “Memory Stick.”

To display the recording date/time, press DATA CODE on the Remote Commander during playback. Various settings cannot be recorded.

While recording on a “Memory Stick”

Do not eject the cassette tape from your camcorder. While you are carrying out the eject operation, sound is not recorded on the “Memory Stick.”



Recording a picture from a tape as a moving picture

- DCR-IP7BT only

Your camcorder can read moving picture data recorded on a tape and record it as a moving picture on a "Memory Stick." Your camcorder can also take in moving picture data through the input jack and record it as a moving picture on a "Memory Stick."

Before operation

- Insert a recorded tape into your camcorder.
- Insert a "Memory Stick" into your camcorder.

- (1) Set the POWER switch to VCR.
- (2) Select , then press the center  on the control button. The picture recorded on the tape is played back.
- (3) Press START/STOP at the scene where you want to start recording. Your camcorder starts recording.

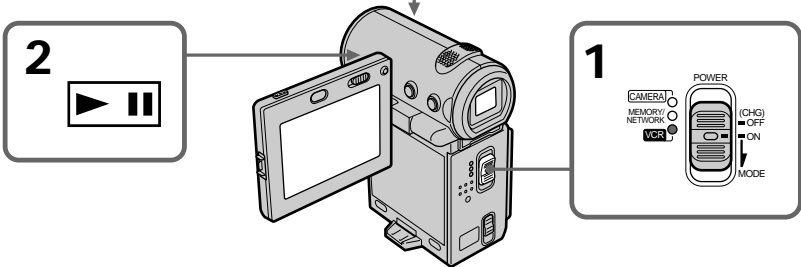
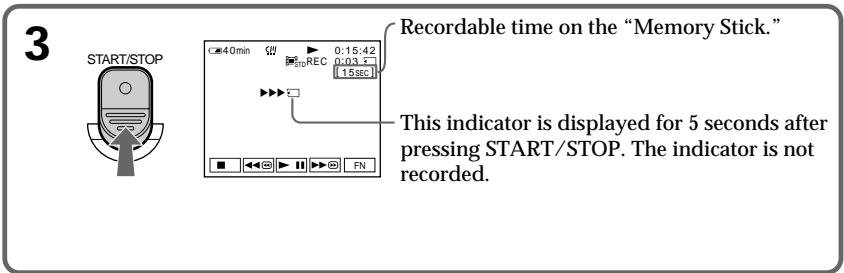

The recordable time for an MPEG movie

Quality mode	recordable time
SUPER FINE	Maximum 45 s
FINE	Maximum 1 min 10 s
STANDARD	Maximum 2 min 20 s
LIGHTMODE	Maximum 4 min 40 s

Recording a picture from a tape as a moving picture

To stop recording

Press START/STOP.

Note

Sound recorded in stereo is converted to monaural sound when recording from tapes.

When the access lamp is lit or flashing

Do not shake or strike the camcorder. Also, do not turn the power off, eject the "Memory Stick" or remove the battery pack. Otherwise, the image data may be corrupted.

Titles already recorded on tapes

You cannot record the titles on a "Memory Stick." The title does not appear while you are recording a moving picture.

The data code recorded on the tape

This is not recorded on the "Memory Stick." The camcorder records a new date and time when the recording on the "Memory Stick" is made.

During recording

The video control buttons do not work.

Recording a moving picture from other equipment

Before operation

Set DISPLAY to LCD in the menu settings. (The default setting is LCD.)

- (1) Set the POWER switch to VCR.
- (2) When using the A/V connecting cable, set VIDEOINPUT to the appropriate position depending on the player.
- (3) Play back the recorded tape.
The image from the other equipment is displayed on the screen.
- (4) Press START/STOP at the point where you want to start recording.

To pause or cancel recording

Press START/STOP again.

Recording a picture from a tape as a moving picture

Using the A/V connecting cable

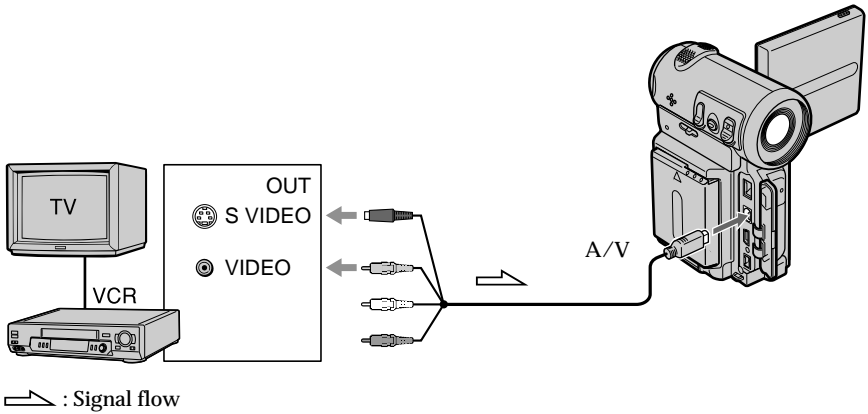

Connect the yellow or black plug of the A/V connecting cable to the video or S video jack or the black plug to the S video jack on the VCR.

If your VCR has an S video jack

Connect using the S video plug to faithfully obtain original pictures. With this connection, you do not need to connect the yellow (video) plug of the A/V connecting cable. Connect the S video plug to the S video jack of the VCR. This connection produces higher quality MICROMV format pictures.

Using the i.LINK cable

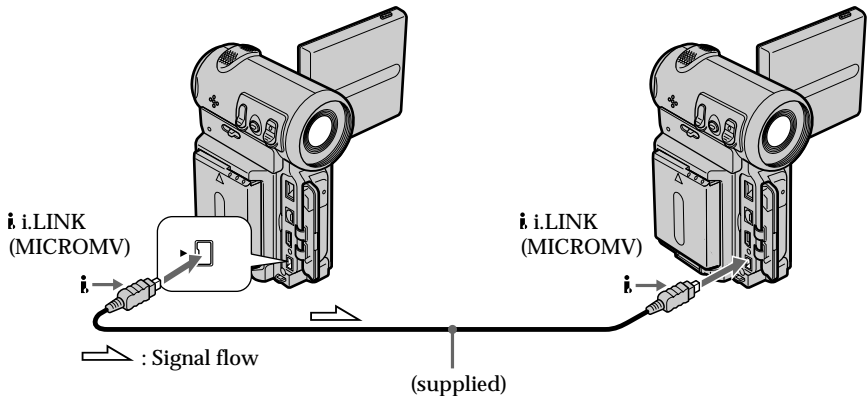

Recording a picture from a tape as a moving picture

Note

"" flashes in the following instances. If this happens, eject and insert the "Memory Stick" again, and record distortion-free images.

- When recording on a tape in a poor recording state, for example, on a tape that has been repeatedly used for dubbing.

While recording on the "Memory Stick"

Do not eject the cassette tape from your camcorder. While you are carrying out the eject operation, sound is not recorded on the "Memory Stick."

Superimposing a still image in a “Memory Stick” on a moving picture – MEMORY MIX

– DCR-IP7BT only

You can superimpose a still image you have recorded on a “Memory Stick” on top of the moving picture you are recording.

You can record the superimposed images on a tape. However, you cannot record these images back onto a “Memory Stick.”

M. CHROM (Memory chromakey)

You can swap a blue area of a still image such as an illustration or a frame with a moving picture.

M. LUMI (Memory luminancekey)

You can swap a brighter area of a still image such as a handwritten illustration or title with a moving picture. Record a title on a “Memory Stick” before a trip or event for convenience.

C. CHROM (Camera chromakey)

You can superimpose a moving picture on top of a still image such as an image which can be used as background. Shoot the subject against a blue background. The blue area of the moving picture will be swapped with a still image.

M.OVERLAP (Memory overlap)

You can make a moving picture fade in on top of a still image.

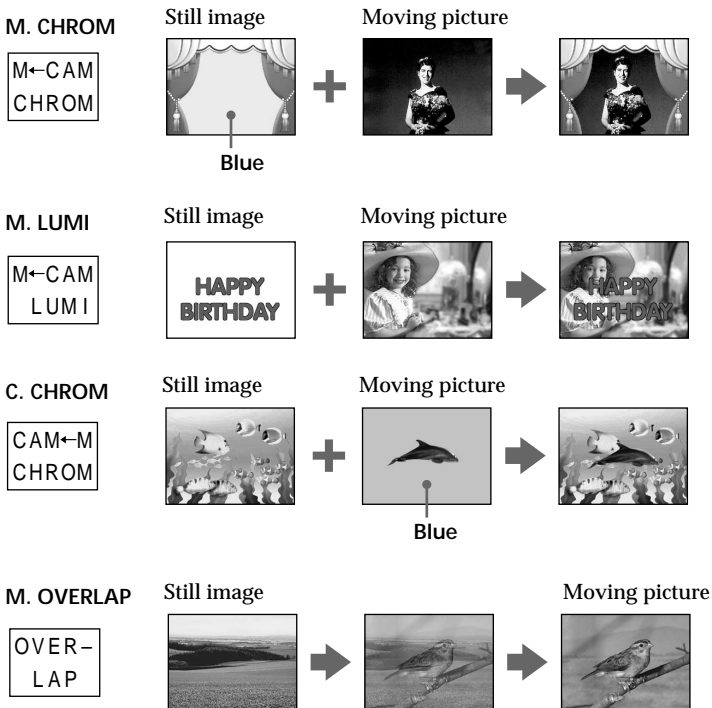

Superimposing a still image in a "Memory Stick" on a moving picture - MEMORY MIX

Before operation

- Insert the tape you want to use for recording into your camcorder.
- Insert the "Memory Stick" with still images recorded into your camcorder.

- (1) Set the POWER switch to CAMERA.
- (2) In standby mode, select FN, then press the center ● on the control button. The PAGE1 screen appears.
- (3) Select MEM MIX, then press the center ● on the control button. The last recorded or last composed image appears on the lower part of the screen as a thumbnail image.
- (4) Select -/+ on the lower-right corner of the screen, then press the center ● on the control button to select the still image which you want to superimpose.
- : to see the previous image
+ : to see the next image
- (5) Select the desired mode, then press the center ● on the control button. The still image is superimposed on the moving picture.
- (6) Select -/+ on the lower-left corner of the screen, then press the center ● on the control button to adjust the effect.
- (7) Select ↻ OK, then press the center ● on the control button. The PAGE1 screen appears.
- (8) Select EXIT, then press the center ● on the control button. The FN screen appears.
- (9) Press START/STOP to start recording.

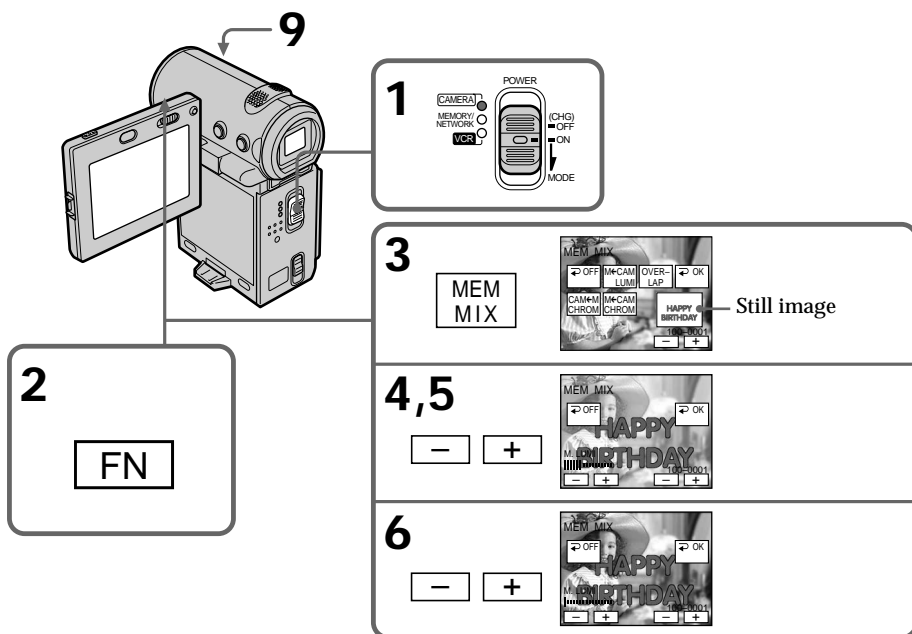

Superimposing a still image in a "Memory Stick" on a moving picture – MEMORY MIX

Items to adjust

M. CHROM	The color (blue) scheme of the area in the still image which is to be swapped with a moving picture
M. LUMI	The color (bright) scheme of the area in the still image which is to be swapped with a moving picture
C. CHROM	The color (blue) scheme of the area in the moving picture which is to be swapped with a still image
M.OVERLAP	No adjustment necessary

The fewer bars there are on the screen, the stronger the effect.

To change the still image to be superimposed

Before step 7, select -/+ in the lower-right corner, then press the center ● on the control button.

To cancel MEMORY MIX

Before step 7, select ↶ OFF, then press the center ● on the control button.

Notes

- You cannot use the memory mix function using a moving image. If you select a moving image file, the black thumbnail image appears.
- When you try to mix a moving file image recorded on a "Memory Stick," the message "NOT REC" appears and you cannot mix the moving file image onto the tape.
- When the overlapping still image has a large amount of white, the thumbnail image of the picture may not be clear.
- You cannot reselect the mode. Select ↶ OFF, then press the center ● on the control button again to return to PAGE1.

The "Memory Stick" supplied with your camcorder stores 20 images

– For M. CHROM: 18 images (such as a frame) 100-0001~100-0018

– For C. CHROM: two images (such as a background) 100-0019~100-0020

Sample images

Sample images stored in the "Memory Stick" supplied with your camcorder are protected (p. 149).

Image data modified with a computer or shot with other equipment

You may not be able to play them back such image data with your camcorder.

To record a still image without any effects on a tape

Select -/+ on the lower-left corner, then press the center ● on the control button to increase the bars to maximum in the M. LUMI mode in step 6.

Note on M.OVERLAP

Once you select M.OVERLAP, you cannot reselect a still image. If you select another image, select ↶ OFF, then press the center ● on the control button to release M.OVERLAP before step 7 and select another image.

When you press the PHOTO button in step 9

You can record a still image on the tape.



Copying still images from a tape – Photo save

– DCR-IP7BT only

Using the search function, you can automatically take in only still images from tapes and record them on a “Memory Stick” in sequence.

Before operation

- Insert a recorded tape into your camcorder and rewind the tape.
- Insert a “Memory Stick” into your camcorder.

- (1) Set the POWER switch to VCR.
- (2) Select FN, then press the center ● on the control button. The PAGE1 screen appears.
- (3) Select MENU, then press the center ● on the control button. The menu appears.
- (4) Select , then press the center ● or ► on the control button.
- (5) Select PHOTO SAVE, then press the center ● or ► on the control button. “PHOTO BUTTON” appears on the screen.
- (6) Press PHOTO firmly. The still image from the tape is recorded on the “Memory Stick.” The number of still images copied is displayed. “END” is displayed when copying is completed.
- (7) Select  END, then press the center ● on the control button. The PAGE1 screen appears.
- (8) Select EXIT, then press the center ● on the control button. The FN screen appears.

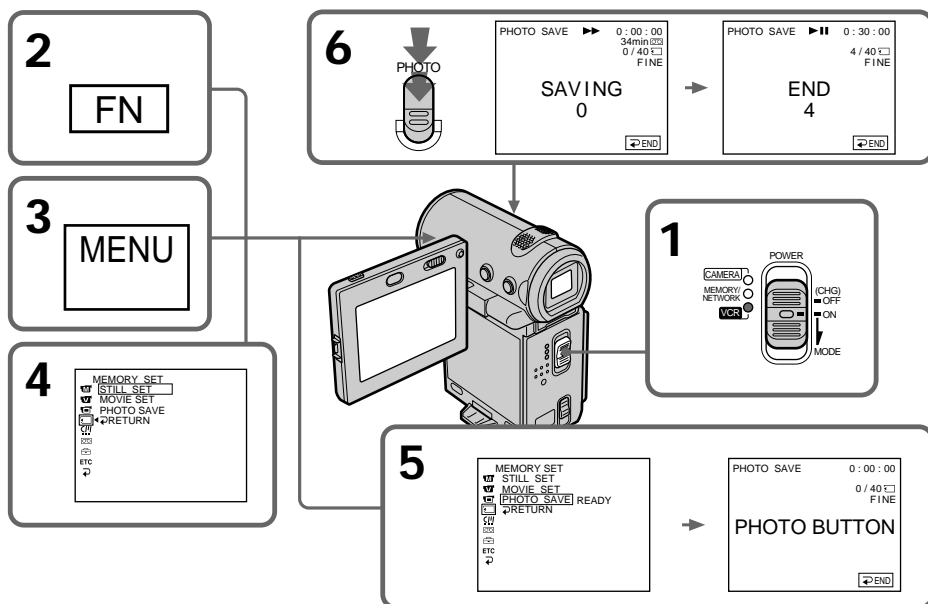

Copying still images from a tape – Photo save

To stop or end copying

Select ↶ END, then press the center ● on the control button in step 5.

When the “Memory Stick” is full

“MEMORY FULL” appears on the screen, and the copying stops. Select ↶ END, then press the center ● on the control button, insert another “Memory Stick” and repeat the procedure from step 2.

When the access lamp is lit or flashing

Do not shake or strike your camcorder. Also, do not turn the power off, eject the “Memory Stick” or remove the battery pack. Otherwise, the image data may be corrupted.

If the write-protect switch on the “Memory Stick” is set to LOCK

“NOT READY” appears when you select the item in the menu settings.

When you change the “Memory Stick” in the middle of copying

Your camcorder resumes copying from the last image recorded on the previous “Memory Stick.”

Note

The message “NOT READY” appears when you select PHOTO SAVE in the following cases:

- There are no images recorded on the tape.
- Images are recorded before the current position on the tape.

In such cases, do the tape photo recording first, or rewind the tape, then select PHOTO SAVE.

Viewing a still image

- Memory photo playback

- DCR-IP7BT only

You can play back still images recorded on a "Memory Stick." You can also play back six images (including moving pictures) in order at a time by selecting the index screen.

Before operation

Insert the "Memory Stick" into your camcorder.

- (1) Set the POWER switch to MEMORY or VCR.
- (2) In MEMORY mode, select PLAY, then press the center ● on the control button.
In VCR mode, select  PB, then press the center ● on the control button.
The last recorded image is displayed.
- (3) Select -/+ , then press the center ● on the control button to select the desired still image.
- : to see the previous image
+ : to see the next image

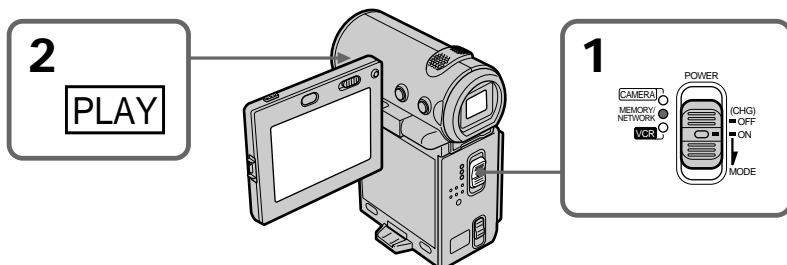

To stop memory photo playback



Select CAM or VCR, then press the center ● on the control button.

Note

Playback images recorded on the "Memory Stick" are not output:

- From the i.LINK (MICROMV) jack.
- From the A/V jack if the i.LINK cable is plugged into the camcorder.

Notes on file names

- The directory number may not be displayed and only the file name may be displayed if the structure of the directory does not conform to the DCF standard.
- "   DIRECTORY ERROR" may appear on the screen if the structure of the directory does not conform to the DCF standard. While this message appears, you can play back images but cannot record them on the "Memory Stick."
- The file name flashes on the screen if the file is corrupted or if the file is unreadable.

Viewing a still image – Memory photo playback

To play back recorded images on a TV screen

- Connect your camcorder to the TV with the A/V connecting cable supplied with your camcorder before the operation.
- When operating memory photo playback on the TV or on the LCD screen, the image quality may appear to have deteriorated. This is not a malfunction. The image data is as good as ever.
- Turn the audio volume of the TV down before operation, or noise (howling) may be output from the TV speakers.

Image data modified with a computer or shot with other equipment

You may not be able to play back such image data with your camcorder.

Still images

You can also select still images from the PAGE1/PAGE2/PAGE3 screens by selecting -/+.

When no images are recorded on the “Memory Stick”

The message “ NO FILE” appears.

Screen indicators displayed during still image playback

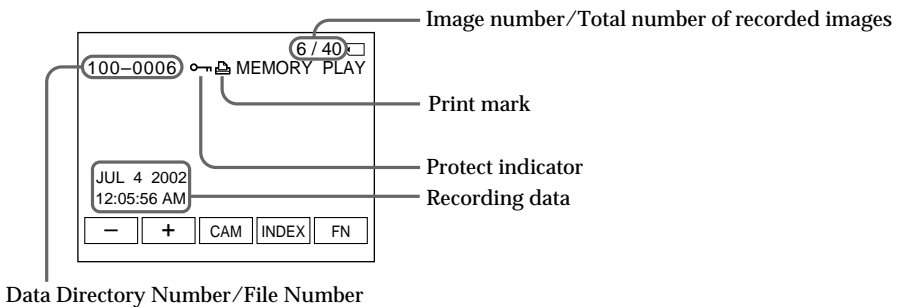

Recording data

To display the recording data (date/time or various settings used when recording), select CAM DATA or DATE DATA, then press the center ● on the control button via DATA CODE on the PAGE3 screen during playback. You can also use the Remote Commander for this operation (p. 41).



To turn off the screen indicators

Press DISPLAY.



Viewing a still image – Memory photo playback

Playing back six recorded images at a time (index screen)

You can play back six recorded images at a time. This function is especially useful when searching for a particular image.

- (1) Set the POWER switch to MEMORY or VCR.
- (2) In MEMORY mode, go to step 3.
In VCR mode, select  PB, then press the center  on the control button.
- (3) Select INDEX, then press the center  on the control button to display the index screen.

An orange  mark appears above the image that is displayed before changing to the index screen mode.

Selecting the  mark makes the color of the  mark change to orange from green. However, the  mark remains green when you use $-/+$ or \leftarrow/\rightarrow on the Remote Commander.

\leftarrow : to display the previous six images

\rightarrow : to display the next six images

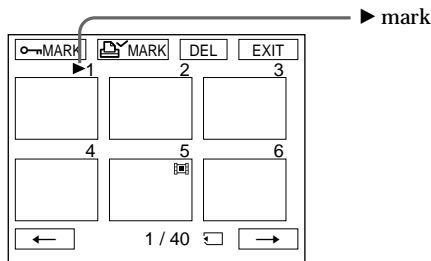

You can also use $-/+$ or \leftarrow/\rightarrow on the Remote Commander instead.



To return to the FN screen

Select EXIT, then press the center  on the control button.

To return to the normal playback screen (single screen)

Move the  mark to the image you want to display, then press the center  on the control button. When you use the Remote Commander, move the  mark to the image you want to display, then press PLAY.

Note

When displaying the index screen, a number appears above each image. This indicates the order in which images are recorded on the “Memory Stick.” These numbers are different from the data file names (p. 108).

Image data modified with a computer or shot with other equipment

These files may not be displayed on the index screen.





Viewing a moving picture – MPEG movie playback

– DCR-IP7BT only

You can play back moving pictures recorded on a “Memory Stick.” You can also play back six images, including still images, in order, at one time, by selecting the index screen.



Before operation

Insert the “Memory Stick” into your camcorder.

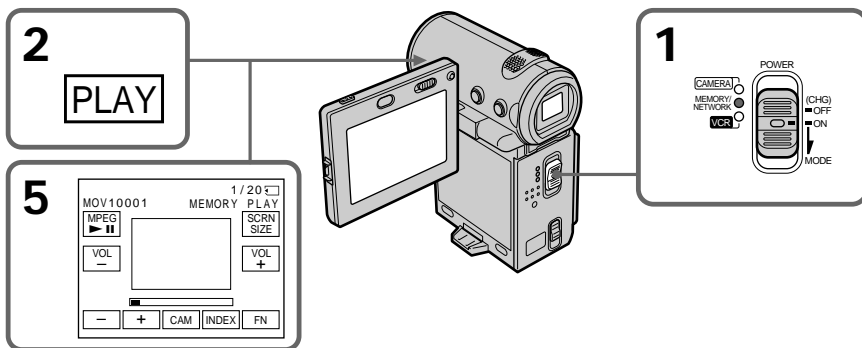
- (1) Set the POWER switch to MEMORY or VCR.
- (2) In MEMORY mode, select PLAY, then press the center ● on the control button. In VCR mode, select  PB, then press the center ● on the control button. The last recorded image is displayed.
- (3) Select +/-, then press the center ● on the control button to select the desired moving picture. To see the previous picture, select -, then press the center ● on the control button. To see the next picture, select +, then press the center ● on the control button.
- (4) Select MPEG  , then press the center ● on the control button. Playback starts.
- (5) Select VOL -/VOL +, then press the center ● on the control button repeatedly to adjust the volume.
 - : To turn down the volume.
 - + : To turn up the volume.You can adjust the volume by pressing /  repeatedly after you select VOL -/VOL +.



To pause playback

Select MPEG  , then press the center ● on the control button. Press again to start playback.

Viewing a moving picture – MPEG movie playback

To change the screen size

Select **SCRN SIZE**, then press the center ● on the control button. The screen size changes as follows:

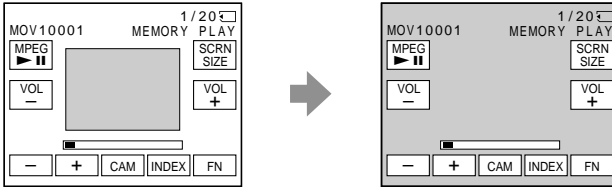

Note

An MPEG movie recorded with the camcorder:

- Is MPEG MOVIE AD.
- Cannot be played back on other digital still cameras and digital video camera recorders.
- Cannot be output from the i.LINK (MICROMV) jack.

To play back recorded images on a TV screen

- Connect your camcorder to a TV with the A/V connecting cable supplied with your camcorder before operation.
- Turn the audio volume of the TV down before operation, or noise (howling) may be output from the TV speakers.

Image data modified with a computer or shot with other equipment

You may not be able to play back such images with your camcorder and the volume cannot be adjusted.

When there are no images recorded on the “Memory Stick”

The message “ NO FILE” appears.

Moving picture

You can select moving pictures from the PAGE1/PAGE2/PAGE3 screens by selecting -/+.

Notes on the screen size

- The picture may not be displayed at the middle of the screen, depending on the movie.
- Even if you switch the screen size, the picture may not be displayed full-screen size, depending on the movie.

Viewing a moving picture – MPEG movie playback

Screen indicators during moving picture playback

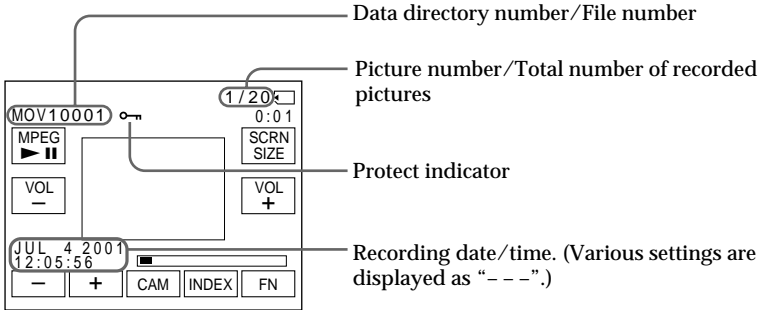

Recommended computer environment

Recommended Windows environment

OS: Microsoft Windows 95, Windows 98, or Windows NT 3.51 or later. Standard installation is required.

Operation is not assured if the above environment is an upgraded OS

* MPEG files cannot be handled on Windows 3.1.

Application: InternetExplorer 4.0 or later (This application comes with Windows 98 or later), or Windows Media Player (Active Movie Player) must be installed.

Recommended Macintosh environment

CPU: PowerPC

OS: Mac OS 7.6.1 or later

Application: QuickTime 3.0 or later

* For details on system requirements for QuickTime, refer to the Web site of Apple Computer, Inc.

Recording date/time

To display the date/time of the recording, press DATA CODE on the Remote Commander during playback. Various settings are not displayed. You can also use DATA CODE on the PAGE3 screen for this operation (p. 41).

To turn off the screen indicators

Press DISPLAY.











Dubbing images recorded on the "Memory Stick" onto the tape

- DCR-IP7BT only

You can dub a still image or title recorded on a "Memory Stick" to a tape. You can also use the Remote Commander to do this operation.

Before operation

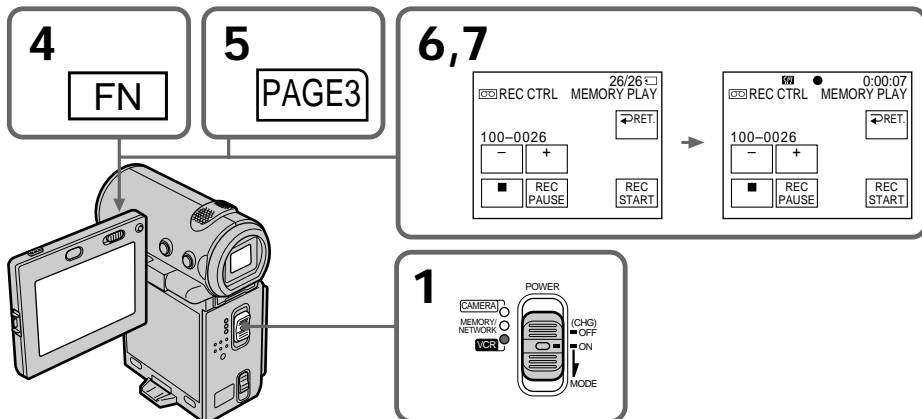

- Insert a tape to be recorded into your camcorder.
- Insert a "Memory Stick" into your camcorder.

- (1) Set the POWER switch to VCR.
- (2) Locate the desired recording start point of the tape, then stop the tape.
- (3) Select  PB, then press the center  on the control button. Next, select the still image you want to dub by selecting -/+.
- (4) Select FN, then press the center  on the control button. The PAGE1 screen appears.
- (5) Select PAGE3, then press the center  on the control button. The PAGE3 screen appears.
- (6) Select  REC CTRL, then press the center  on the control button. The  REC CTRL appears.
- (7) Select REC START, then press the center  on the control button. The camcorder starts dubbing. To pause the dubbing, select REC PAUSE, then press the center  on the control button.
- (8) When you try to dub another image, select -/+, then press the center  on the control button and carry out step 7.



Dubbing images recorded on the "Memory Stick" onto the tape

To stop dubbing

Select , then press the center  on the control button, or press the stop button on the Remote Commander.

When using the Remote Commander

Press the REC buttons on the Remote Commander simultaneously after step 3. The camcorder starts dubbing.

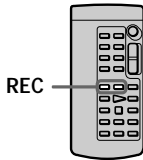

Notes

- You cannot dub MPEG movie files to the tape.
- You cannot dub the index screen to the tape.

Image files modified with a computer or shot with other equipment

You may not be able to dub these images.

Enlarging still images recorded on a “Memory Stick” – Memory PB ZOOM

– DCR-IP7BT only

You can enlarge still images recorded on a “Memory Stick.”

Before operation

Insert the “Memory Stick” into your camcorder.

- (1) In memory playback mode, select FN, then press the center ● on the control button. The PAGE1 screen appears.
- (2) Select PAGE2, then press the center ● on the control button. The PAGE2 screen appears.
- (3) Select PB ZOOM, then press the center ● on the control button. The PB ZOOM screen appears.
- (4) Push down ZOOM to enlarge the image. The zoom scaling can be selected from 2×, 3×, 4×, and 5×.
- (5) Move the enlarged area.
 - ▲: To view the upper portion of the original image.
 - ▼: To view the lower portion of the original image.
 - ◀: To view the left portion of the original image.
 - ▶: To view the right portion of the original image.

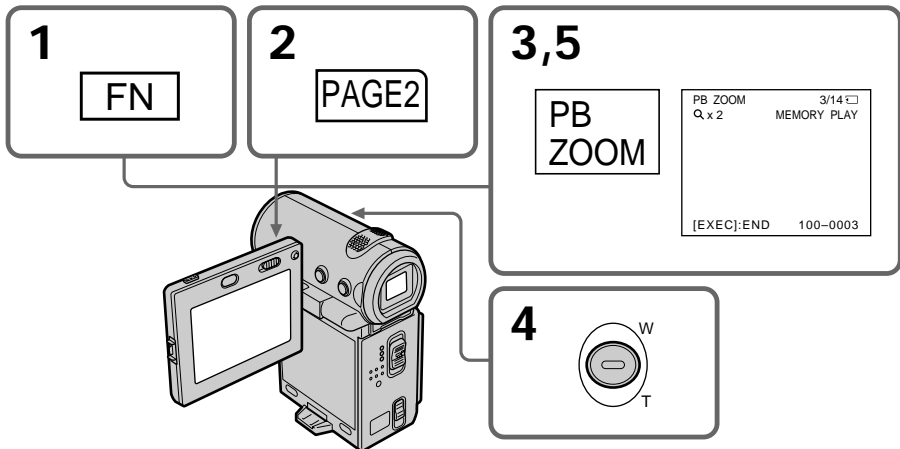

To cancel the Memory PB ZOOM function

Press the center ● on the control button.

Enlarging still images recorded on a “Memory Stick” – Memory PB ZOOM

Note

You cannot record images on the “Memory Stick” which are enlarged by the Memory PB ZOOM function. Record those images on the VCR using your camcorder as a player.

Pictures in the Memory PB ZOOM mode

Pictures are not output through the i.LINK (MICROMV) jack.

In Memory PB ZOOM mode

If you press DISPLAY, the indicators on the Memory PB ZOOM screen disappear.

The edges of an enlarged image

The edges of an enlarged image cannot be displayed at the center of the screen.

MPEG movie files recorded on a “Memory Stick”

The PB ZOOM function does not work with these files.

Playing back images in a continuous loop – SLIDE SHOW

– DCR-IP7BT only

You can automatically play back images in sequence. This function is useful especially when checking recorded images or during a presentation.

Before operation

Insert the “Memory Stick” with your images recorded into your camcorder.

- (1) Set the POWER switch to MEMORY.
- (2) Select FN, then press the center ● on the control button. The PAGE1 screen appears.
- (3) Select MENU, then press the center ● on the control button. The menu appears.
- (4) Select , then press the center ● or ► on the control button.
- (5) Select SLIDE SHOW, then press the center ● or ► on the control button.
- (6) Select START, then press the center ● on the control button. Your camcorder plays back the images recorded on the “Memory Stick” in sequence.

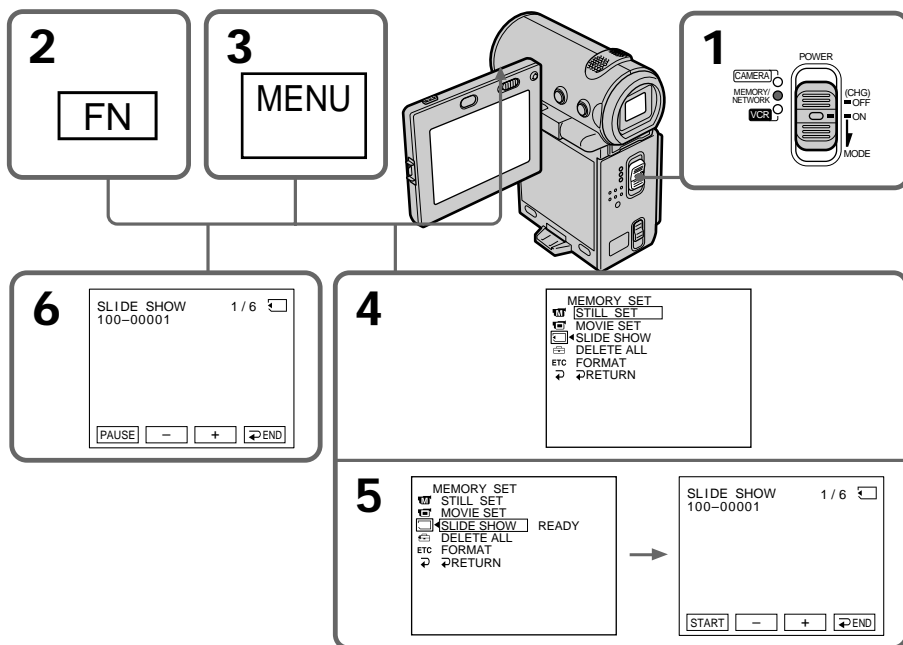

Playing back images in a continuous loop – SLIDE SHOW

To stop the slide show

Select \rightarrow END, then press the center ● on the control button.

To pause during a slide show

Select PAUSE, then press the center ● on the control button.

To return to the FN screen

Select \rightarrow END, then press the center ● on the control button. The PAGE1 screen appears. Next, select EXIT, then press the center ● on the control button.

To start the slide show from a particular image

Select the desired image by selecting -/+ before step 5.

To view the recorded images on the TV screen

Connect your camcorder to a TV with the A/V connecting cable supplied with your camcorder before operation.

If you change the “Memory Stick” during operation

The slide show does not operate. If you change the “Memory Stick,” carry out the procedure again from the beginning.

To play the slide show with the screen indicators turned off

After step 5, press DISPLAY to turn off the screen indicators. You can start/pause the slide show using MEMORY PLAY on the Remote Commander. To end the slide show, press DISPLAY again, next, select \rightarrow END, then press the center ● on the control button.

When there are no images on the “Memory Stick”

The message “ NO FILE” appears.

Preventing accidental erasure – Image protection

– DCR-IP7BT only

To prevent accidental erasure of important images, you can protect selected images.

Before operation

Insert the “Memory Stick” into your camcorder.

- (1) Set the POWER switch to MEMORY or VCR.
- (2) In MEMORY mode, go to step 3.
In VCR mode, select \square PB, then press the center \bullet on the control button.
- (3) Select INDEX, then press the center \bullet on the control button. The index screen appears.
- (4) Select \circ MARK, then press the center \bullet on the control button. The screen used for protecting your image appears.
- (5) Select the image you want to protect, then press the center \bullet on the control button. The “ \circ MARK” mark appears on the protected image.
- (6) Repeat step 5 to select other images.

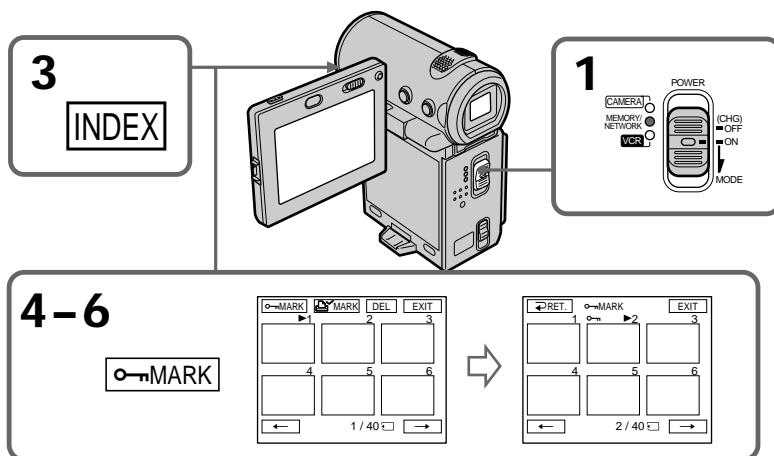

To return to the FN screen

Select EXIT, then press the center \bullet on the control button.

To cancel image protection

Select the image for which you want to cancel image protection, then press the center \bullet on the control button in step 5 again. The “ \circ MARK” mark disappears.

Note

Formatting erases all information on the “Memory Stick,” including the protected image data. Check the contents of the “Memory Stick” before formatting.

If the write-protect switch on the “Memory Stick” is set to LOCK

You cannot carry out image protection.

Deleting images

- DCR-IP7BT only

You can delete images stored in a “Memory Stick.” You can delete all images or selected images.

Deleting selected images

Before operation

Insert the “Memory Stick” into your camcorder.

- (1) Set the POWER switch to MEMORY or VCR.
- (2) In MEMORY mode, select PLAY, then press the center ● on the control button.
In VCR mode, select  PB, then press the center ● on the control button.
Select -/+, then press the center ● on the control button to select the image you want to delete.
- (3) Select FN, then press the center ● on the control button. The PAGE1 screen appears.
- (4) Select DELETE, then press the center ● on the control button. “DELETE?” appears on the screen.
- (5) Select OK, then press the center ● on the control button. The selected image is deleted.

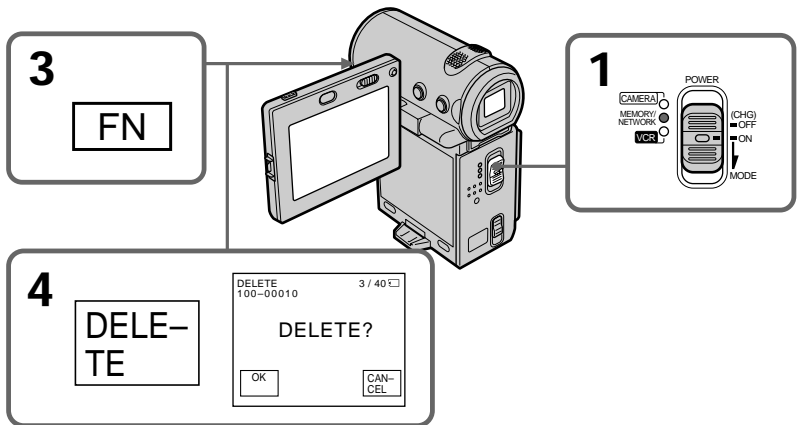

To return to the FN screen

Select EXIT, then press the center ● on the control button after step 5.

To cancel deleting an image

Select CANCEL, then press the center ● on the control button in step 5.

Deleting images

Notes

- When you want to delete a protected image, first cancel the image protection.
- Once you delete an image, you cannot restore it. Check the images before deleting them.

If the write-protect switch on the "Memory Stick" is set to LOCK
You cannot delete images.

Deleting selected images on the index screen

Before operation

Insert the "Memory Stick" into your camcorder.

- (1) Set the POWER switch to MEMORY or VCR.
- (2) In MEMORY mode, go to step 3.
In VCR mode, select \square PB, then press the center \bullet on the control button.
- (3) Select INDEX, then press the center \bullet on the control button.
The index screen appears.
- (4) Select DEL, then press the center \bullet on the control button. The DEL screen appears.
- (5) Move the \blacktriangleright mark to the image you want to delete, then press the center \bullet on the control button. The number of the selected image is highlighted.
- (6) Repeat step 5 to select other images.
- (7) After selecting all the images you want to delete, select EXEC, then press the center \bullet on the control button. "DELETE?" appears on the screen.
- (8) Select OK, then press the center \bullet on the control button. The selected images are deleted. The message "ERASING" appears. After the erasing is completed, the index screen appears.

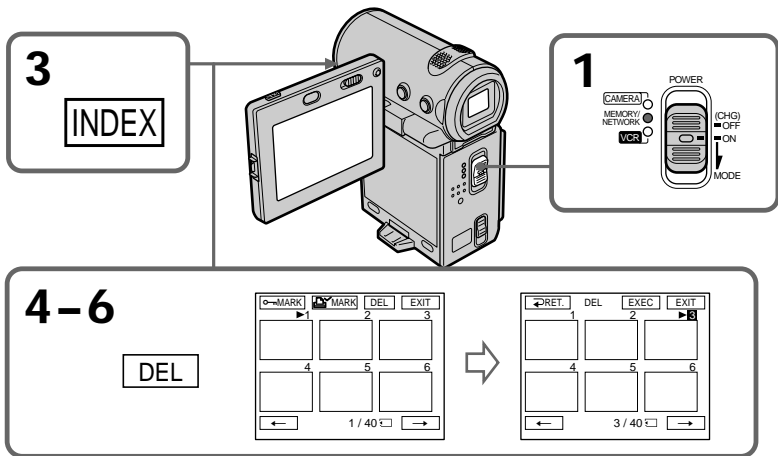

Deleting images

To return to the FN screen

Select EXIT, then press the center ● on the control button after step 8.

To cancel deleting an image

Select CANCEL, then press the center ● on the control button in step 8.

Deleting all the images

You can delete all the unprotected images in a “Memory Stick.”

Before operation

Insert the “Memory Stick” into your camcorder.

- (1) Set the POWER switch to MEMORY.
- (2) Select FN, then press the center ● on the control button. The PAGE1 screen appears.
- (3) Select MENU, then press the center ● on the control button. The menu appears.
- (4) Select , then press the center ● or ► on the control button.
- (5) Select DELETE ALL, then press the center ● or ► on the control button.

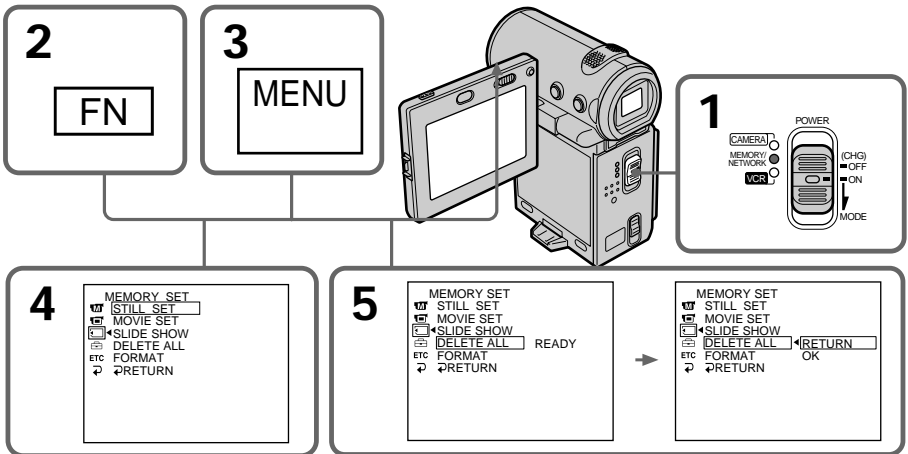

Deleting images

- (6) Select OK, then press the center ● on the control button. OK changes to EXECUTE.
- (7) Select EXECUTE, then press the center ● on the control button. "DELETING" appears on the screen. When all the unprotected images are deleted, "COMPLETE" is displayed.
- (8) Press DISPLAY to turn off the menu.

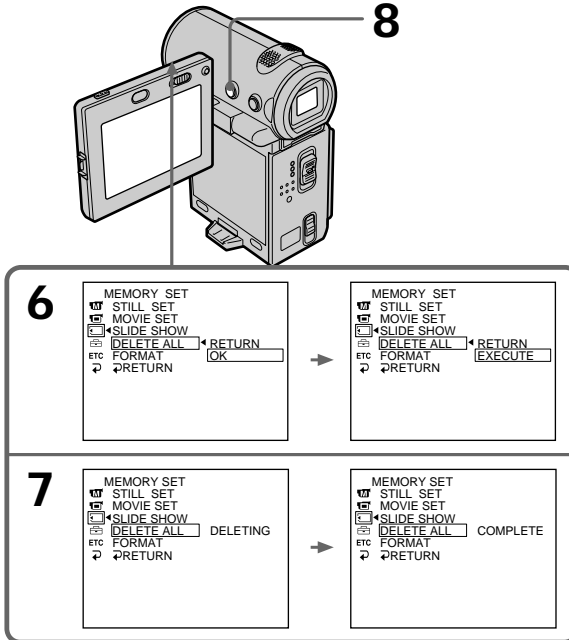

To return to the FN screen

Select \leftarrow RETURN, \rightarrow , then press the center ● on the control button.

To cancel deleting all the images in the "Memory Stick"

Select RETURN in step 5 or 6, then press the center ● on the control button.

While "DELETING" appears

Do not slide the POWER switch or press any buttons.

Writing a print mark – PRINT MARK









– DCR-IP7BT only

You can specify a recorded still image to print out by putting marks on it. This function is useful for printing out still images later.

Your camcorder conforms with the DPOF (Digital Print Order Format) standard for specifying the still images to print out.



Before operation

Insert the “Memory Stick” into your camcorder.

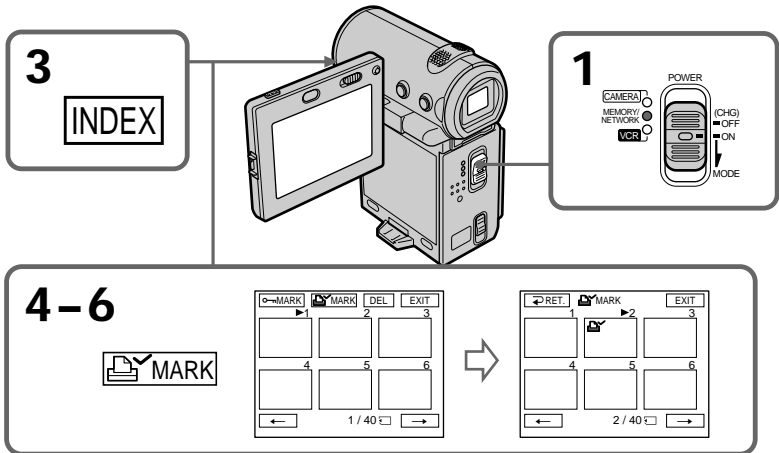
- (1) Set the POWER switch to MEMORY or VCR.
- (2) In MEMORY mode, go to step 3.
In VCR mode, select  PB, then press the center  on the control button.
- (3) Select INDEX, then press the center  on the control button.
The index screen appears.
- (4) Select  MARK, then press the center  on the control button. The screen used for writing a print mark appears.
- (5) Move the  mark to the image for which you want to write a print mark, then press the center  on the control button.
The  mark appears on the selected image.
- (6) Repeat step 5 to write print marks on other images.
- (7) After writing all the print marks needed, select EXIT, then press the center  on the control button. The FN screen appears.



To cancel writing print marks

Select the image for which you want to cancel the print mark, then press the center  on the control button again in step 5. The  mark disappears from the image.

If the write-protect switch on the “Memory Stick” is set to LOCK

You cannot write print marks on still images.

Moving pictures

You cannot write print marks on moving pictures.

Download from Www.Somanuals.com. All Manuals Search And Download.

Viewing images recorded on a tape using your computer

You can view or edit the images recorded on a tape using your computer. You can record images edited with the computer on the tape. To view images on your computer, the application software MovieShaker Ver. 3.1 for MICROMV (supplied) is required.

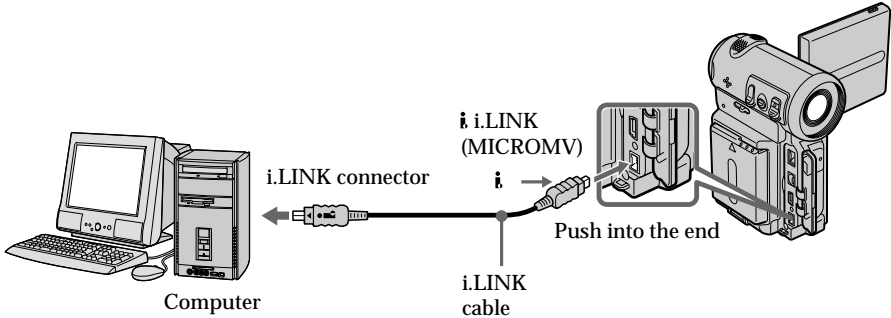

Note

To view images on your computer, you have to install the i.LINK driver and the application software into your computer. They are included in the supplied application software MovieShaker Ver. 3.1 for MICROMV.

Before installing the i.LINK driver and the application software into your computer, be sure not to connect the camcorder to the computer. For details on installing and on an i.LINK connection, refer to the operating instructions supplied with MovieShaker Ver. 3.1 for MICROMV.

Recommended computer environment

Recommended Windows environment

OS:	Microsoft Windows Millennium Edition, Windows 2000 Professional, Windows XP Home/Professional (support to be provided). Standard installation is required.
CPU:	Operation is not assured if the above environment is an upgraded OS. MMX Pentium III 600 MHz or faster (Required) MMX Pentium III 800 MHz or faster (Recommended)
Main memory:	128 MB or larger (Required) 256 MB or larger (Recommended)
Display:	800 × 600 or larger screen size/1024 × 480 or larger screen size, 16-bit color or higher
Hard disk:	100 MB hard disk space (for installation), ATA66 or higher speed (required for capturing an image)

The i.LINK (IEEE1394) connector must be provided as standard.

Note

Operations are not guaranteed for all the recommended computer environments mentioned above.

Viewing images recorded on a “Memory Stick” using your computer

– DCR-IP7BT only

You can view data recorded on a “Memory Stick” using your computer.

Note

Data recorded on a “Memory Stick” is stored in the following formats. Make sure that applications that support these file formats are installed on your computer.

- Still images: JPEG format
- Moving images/audio: MPEG format

Recommended computer environment

Recommended Windows environment

OS: Microsoft Windows 98, Windows 98SE, Windows Me or Windows 2000
Professional standard installation is required.

Operation is not assured if the above environment is an upgraded OS.

CPU: MMX Pentium 200 MHz or faster

- A USB connector must be provided as standard.
- An application such as Windows Media Player, capable of playing back MPEG pictures, must be installed (to play back moving pictures).

Recommended Macintosh environment

Macintosh computer with the Mac OS 8.5.1/8.6/9.0/9.1, Mac OS X standard installation
However, note that the update to Mac OS 9.0/9.1 should be used for the following models.

- iMac with the Mac OS 8.6 standard installation and a slot loading type CD-ROM drive
- iBook or Power Mac G4 with the Mac OS 8.6 standard installation

- A USB connector must be provided as standard.
- QuickTime 3.0 or later must be installed (to play back moving pictures).

Notes

- Operations are not guaranteed for either the Windows or Macintosh environment if you connect two or more USB devices to a single computer at the same time or when using a hub.
- Depending on the type of USB equipment that is used simultaneously, some equipment may not operate.
- Operations are not guaranteed for all the recommended computer environments mentioned above.

Viewing images recorded on a "Memory Stick" using your computer

Installing the USB driver

Before connecting your camcorder to your computer, install the USB driver to the computer. The USB driver is contained together with the application software used for viewing images on a CD-ROM supplied with your camcorder.

Do not connect the USB cable to your computer before installation of the USB driver is completed.

For Windows 98, Windows 98SE, Windows Me, Windows 2000 Professional users

- (1) Turn on the power of your computer and allow Windows to load.
- (2) Insert the supplied CD-ROM in the CD-ROM drive of your computer. The application software screen appears.
- (3) Set the cursor on "USB Driver Installation for Windows 98/98SE/Me and Windows 2000" and click. USB driver installation starts.
- (4) Follow the on-screen messages to install the USB driver.
- (5) Connect the USB jack on your camcorder to the USB connector on your computer using the supplied USB cable.
- (6) Insert a "Memory Stick" into your camcorder, connect the AC power adaptor and set the POWER switch to MEMORY.
USB MODE appears on the screen of your camcorder. Your computer recognizes the camcorder, and the Windows Add Hardware Wizard starts.
- (7) Follow the on-screen messages to have the Add Hardware Wizard recognize the hardware. The Add Hardware Wizard starts twice because 2 different USB drivers are installed. Be sure to allow the installation to complete without interrupting it.

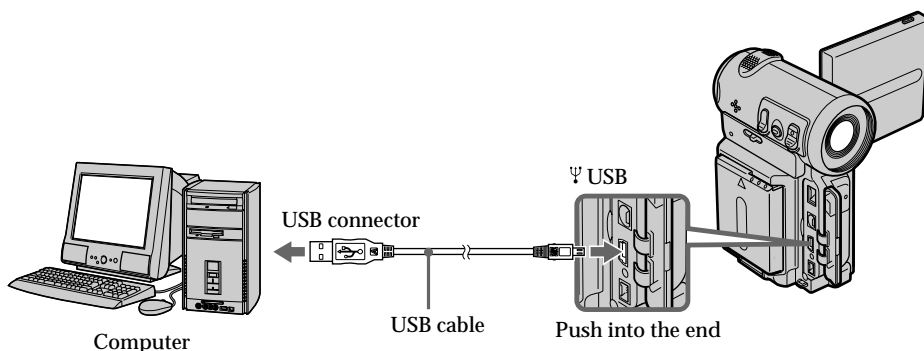

Notes

- You cannot install the USB driver if a "Memory Stick" is not in your camcorder. Be sure to insert a "Memory Stick" into your camcorder before installing the USB driver.
- The USB driver has been registered incorrectly as your computer was connected to your camcorder before installation of the USB driver was completed. Re-install the USB driver following the procedure on page 158.

Viewing images recorded on a "Memory Stick" using your computer

Image data cannot be transferred over the USB connection

The USB driver has been registered incorrectly as your computer was connected to your camcorder before installation of the USB driver was completed. Perform the following procedure to correctly install the USB driver.

Step 1 Uninstall the incorrect USB driver

- ① Turn on the power and allow Windows to load.
- ② Connect the USB jack on your computer to the USB jack on your camcorder using the USB cable supplied with your camcorder.
- ③ Insert a "Memory Stick" into your camcorder, connect the AC power adapter, and set the POWER switch to MEMORY.
- ④ Open your computer's "Device Manager."
Windows 2000 Professional:
Open "My Computer" → "Control Panel" → "Hardware" tab, and click the "Device Manager" button.
Other OS:
Select "My Computer" → "Control Panel" → "System," and click "Device Manager."
⑤ Select "Other devices."
Select the device prefixed with a "?" mark and delete it.
Ex: (?)Sony Handycam
- ⑥ Turn the power OFF (CHG), and then disconnect the USB cable.
- ⑦ Reboot your computer.

Step 2 Install the USB driver on the CD-ROM

Perform the entire procedure listed in "Installing the USB driver" on page 157.

For Mac OS 8.5.1/8.6/9.0 users

- (1) Turn on the power of your computer and allow the Mac OS to load.
- (2) Insert the supplied CD-ROM in the CD-ROM drive of your computer.
- (3) Double-click the CD-ROM drive icon to open the window.
- (4) Double-click the icon of the hard disk containing the OS to open the window.
- (5) Move the following 2 files from the window opened in step 3 to the System Folder icon in the window opened in step 4 (drag and drop).
 - Sony Camcorder USB Driver
 - Sony Camcorder USB Shim
- (6) When "Put these items into the Extensions folder?" appears, click OK.
- (7) Restart your computer.

For Mac OS 9.1, Mac OS X

The USB driver need not be installed. Your Mac is automatically recognized as a driver just by connecting your Mac using the USB cable.

Viewing images recorded on a "Memory Stick" using your computer

Viewing images

For Windows users

- (1) Turn on the power of your computer and allow Windows to load.
- (2) Connect one end of the USB cable to the USB jack on the camcorder and the other end to the USB connector on your computer.
- (3) Insert a "Memory Stick" into your camcorder, and connect the AC power adaptor to your camcorder and then to a wall outlet.
- (4) Set the POWER switch to MEMORY.
USB MODE appears on the screen of the camcorder.
- (5) Open "My Computer" on Windows and double click the newly recognized drive. (Example: "Removable Disk (E:)"
The folders inside the "Memory Stick" are displayed.
- (6) Select and double-click the desired image file from the folder.
For the detailed folder and file name, see "Image file storage destinations and image files" (p. 161).
As for stored files using the network function, refer to the network function operating instructions.

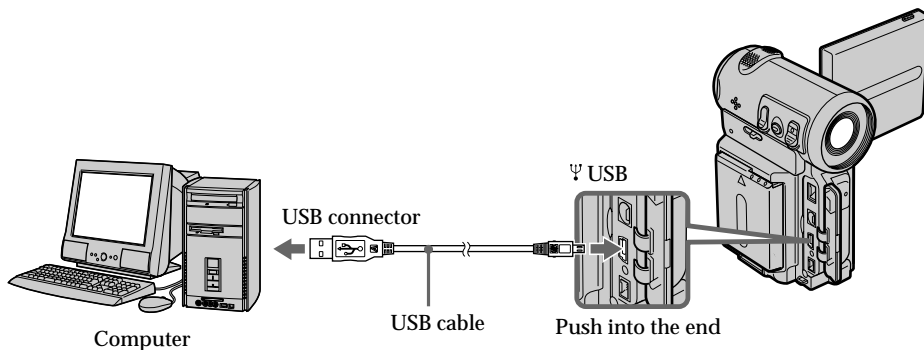

Desired file type	Double-click in this order
Still image/ Moving picture*	"Dcim" folder → "100msdcf" folder → Image file

* Copying a file to the hard disk of your computer before viewing it is recommended. If you play back a file directly from the "Memory Stick," the image and sound may break up.

Viewing images recorded on a “Memory Stick” using your computer

Unplug the USB cable/Eject the “Memory Stick”

For Windows 2000 Professional, Windows Me users

To unplug the USB cable or eject the “Memory Stick,” follow the procedure below.

- (1) Move the cursor to the “Unplug or Eject Hardware” icon on the Task Tray and click to cancel the applicable drive.
- (2) A message asking you to remove the device from the system appears, then unplug the USB cable or eject the “Memory Stick.”

For Macintosh users

- (1) Quit any application programs opened.
Make sure that the access lamp of the hard disk is not lit.
- (2) Drag and drop the “Memory Stick” icon to the Trash or select Eject under the Special menu.
- (3) Eject the “Memory Stick.”

Notes on using your computer

“Memory Stick”

- “Memory Stick” operations on your camcorder cannot be assured if a “Memory Stick” formatted on your computer is used on your camcorder, or if the “Memory Stick” in your camcorder was formatted using your computer when the USB cable was connected.
- Do not optimize the “Memory Stick” on a Windows machine. This will shorten the “Memory Stick” life.
- Do not compress the data on the “Memory Stick.” Compressed files cannot be played back on your camcorder.

Software

- Depending on your application software, the file size may increase when you open a still image file.
- When you load an image modified using a retouch software from your computer to the camcorder or when you directly modify the image on the camcorder, the image format will differ so a file error indicator may appear and you may be unable to open the file.

Communicating with your computer

Communications between your camcorder and your computer may not recover after recovering from Suspend, Resume, or Sleep.

Viewing images recorded on a "Memory Stick" using your computer

Image file storage destinations and image files

Image files recorded with your camcorder are grouped in folders by recording mode. The meanings of the file names are as follows. □□□□ stands for any number within the range from 0001 to 9999.

For Windows Me users
(The drive recognizing the camera is [E:])

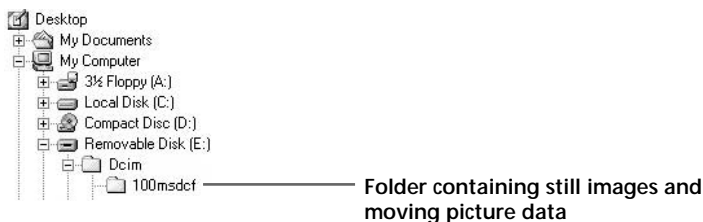

Folder	File	Meaning
100msdcf	DSC0□□□□.jpg	Still image file
	MOV1□□□□.mpg	Moving picture file

Accessing the network

– DCR-IP7BT only

You can access the Internet using a Bluetooth device that complies to the standards of the camcorder. Once the access is made, you can view a Web page and send/receive your e-mail, etc. This section describes only how to open the Network Menu. For details on network operations, refer to the network function operating instructions supplied with the camcorder.

- (1) Set the POWER switch to MEMORY/NETWORK.
- (2) Select NETWORK, then press the center ● on the control button. The Network Menu appears and the  (Bluetooth) lamp turns on.

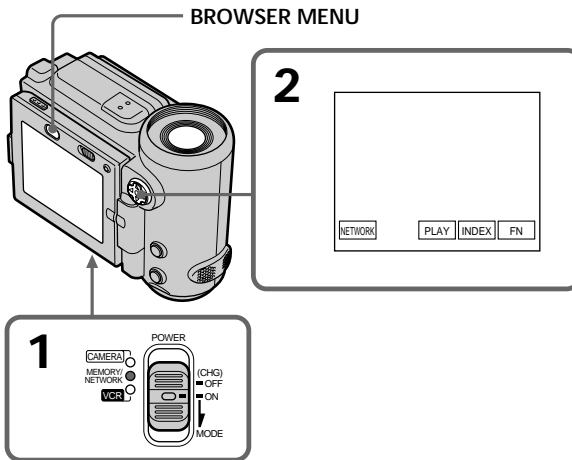

When you send e-mail using the network function, you can attach an image recorded on a "Memory Stick" to your e-mail. Attachable file size is up to 3 MB per one e-mail message. When attaching a moving image file, the available time for the attached image depends on the image quality mode. For details, see the table below.

Image quality mode	SUPER FINE	FINE	STANDARD	LIGHTMODE
Available time/one e-mail	17 s	29 s	58 s	119 s

Accessing the network

Note on trademarks

- The BLUETOOTH trademarks are owned by their proprietor and used by Sony Corporation under license.
- All other product names mentioned herein may be the trademarks or registered trademarks of their respective companies. Furthermore, “™” and “®” are not mentioned in each case in this manual.

When using the network function

Hold the camcorder with both hands as illustrated below.

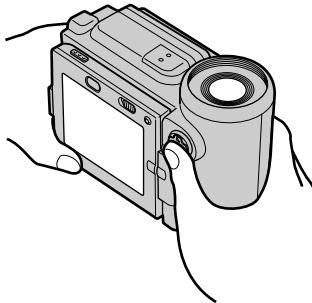

Note

Be careful not to touch the ▼ BATT lever while you are operating the camcorder. The battery pack may be accidentally detached from the camcorder.

Types of trouble and their solutions

If you run into any problem using your camcorder, use the following table to troubleshoot the problem. If the problem persists, disconnect the power source and contact your Sony dealer. If “C:□□:□□” appears on the screen, the self-diagnosis display function has worked. See page 170.

In recording mode

Symptom	Cause and/or Corrective Actions
START/STOP does not operate.	<ul style="list-style-type: none"> • The POWER switch is not set to CAMERA. → Set it to CAMERA (p. 29). • The tape has run out. → Rewind the tape or insert a new one (p. 27, 43). • The write-protect tab is set to expose the red mark. → Use a new tape or slide the tab (p. 27). • The tape is stuck to the drum (moisture condensation). → Remove the cassette and leave your camcorder for at least 1 hour to acclimatize it (p. 179).
The power goes off.	<ul style="list-style-type: none"> • While being operated in CAMERA mode, your camcorder has been in standby mode for more than 5 minutes. → Set the POWER switch to OFF (CHG) and turn on the power (p. 30). • The battery pack is dead or nearly dead. → Install a fully charged battery pack.
The image on the viewfinder screen is not clear.	<ul style="list-style-type: none"> • The viewfinder is not extended to the end. → Pull out the viewfinder. • The viewfinder lens is not adjusted. → Adjust the viewfinder lens (p. 33).
The SteadyShot function does not work.	<ul style="list-style-type: none"> • STEADYSHOT is set to OFF in the menu settings. → Set it to ON (p. 102).
The autofocusing function does not work.	<ul style="list-style-type: none"> • The setting is the manual focus mode. → Set it to the auto focus mode. (p. 65) • Shooting conditions are not suitable for autofocus. → Adjust to focus manually (p. 65).
The picture does not appear in the viewfinder.	<ul style="list-style-type: none"> • The LCD panel is open. → Close the LCD panel. (p. 30)
A vertical band appears when you shoot a subject such as lights or a candle flame against a dark background.	<ul style="list-style-type: none"> • The contrast between the subject and the background is too high. This is not a malfunction.
A vertical band appears when you shoot a very bright subject.	<ul style="list-style-type: none"> • This is called the smear phenomenon. This is not a malfunction.
Some tiny white spots appear on the screen.	<ul style="list-style-type: none"> • Slow shutter or low lux mode is activated. This is not a malfunction.
An unknown picture is displayed on the screen.	<ul style="list-style-type: none"> • If 10 minutes elapse after you set the POWER switch to CAMERA or DEMO MODE is set to ON in the menu settings without a cassette inserted, your camcorder automatically starts the demonstration. → Insert a cassette. The demonstration stops. You can also cancel DEMO MODE (p. 106).

Types of trouble and their solutions

Symptom	Cause and/or Corrective Actions
The picture appears too bright, and the subject does not appear on the screen.	<ul style="list-style-type: none">• The backlight function is active. → Set it to off (p. 36).
The click of the shutter does not sound.	<ul style="list-style-type: none">• BEEP is set to OFF in the menu settings. → Set it to MELODY or NORMAL (p. 102).
A horizontal band appears when shooting a TV screen or computer screen.	<ul style="list-style-type: none">• Set STEADYSHOT to OFF in the menu settings (p. 102).

In the playback mode





Symptom	Cause and/or Corrective Actions
Playback is not possible.	<ul style="list-style-type: none">• The tape has run out. → Rewind the tape. (p. 43)
There are horizontal lines on the picture or the playback picture is not clear or does not appear.	<ul style="list-style-type: none">• The video head may be dirty. → Clean the heads using the cleaning cassette (p. 180).
No sound or only a low sound is heard when playing back a tape.	<ul style="list-style-type: none">• The volume is turned to minimum. → Turn up the volume (p. 39).
The multi-picture search, title search, date search, or photo search function does not work.	<ul style="list-style-type: none">• The tape has a blank portion at the beginning of the tape or between recorded portions. (p. 73, 76, 78, 80).
The title is not displayed.	<ul style="list-style-type: none">• TITLE DSPL is set to OFF in the menu settings. → Set it to ON in the menu settings (p. 102).• The screen indicators are displayed. → Turn off the screen indicators (p. 41).
Dubbing cannot be made when using the A/V connecting cable.	<ul style="list-style-type: none">• The setup of VIDEOINPUT is wrong. → Set it to the appropriate position (p. 84).
The playback picture freezes for about 1 second.	<ul style="list-style-type: none">• When playing back a transition of recordings, the playback picture freezes for about 1 second. This is not a malfunction.

In the recording and playback modes

Symptom	Cause and/or Corrective Actions
The camcorder does not function even if you slide the POWER switch.	<ul style="list-style-type: none">• The battery pack is not installed, or is dead or nearly dead. → Install a charged battery pack (p. 18, 19).• The AC power adaptor is not connected to a wall outlet. → Connect the AC power adaptor to a wall outlet (p. 21).

Types of trouble and their solutions

In the recording and playback modes

Symptom	Cause and/or Corrective Actions
The battery pack is quickly discharged.	<ul style="list-style-type: none"> • The temperature of the environment is too low. • The battery pack is not fully charged. → Charge the battery pack fully again (p. 19). • The battery pack is completely dead, and cannot be recharged. → Replace it with a new battery pack (p. 18).
The battery remaining indicator does not indicate the correct time.	<ul style="list-style-type: none"> • You have used the battery pack in an extremely hot or cold environment for a long time. • The battery pack is completely dead, and cannot be recharged. → Replace it with a new battery pack (p. 18). • The battery is not fully charged. → Use a charged battery pack (p. 19). • A deviation has occurred in the remaining battery time. → Charge the battery pack fully again (p. 19).
The power goes off although the battery remaining indicator indicates that the battery pack has enough power to operate.	<ul style="list-style-type: none"> • A deviation has occurred in the remaining battery time. → Charge the battery pack fully again so that the indication on the battery remaining indicator is correct (p. 19).
The cassette cannot be removed from the holder.	<ul style="list-style-type: none"> • The power source is disconnected. → Connect it firmly (p. 18, 21). • The battery is not fully charged. → Use a charged battery pack (p. 19).
The  and  indicators flash and no functions except for cassette ejection work.	<ul style="list-style-type: none"> • Moisture condensation has occurred. → Remove the cassette and leave your camcorder for at least 1 hour to acclimatize it (p. 179).
The  indicator is flashing.	<ul style="list-style-type: none"> • The camcorder cannot recognize the Micro Cassette Memory of the tape. → Insert the cassette again (p. 27).
The remaining tape indicator is not displayed.	<ul style="list-style-type: none"> •  REMAIN is set to AUTO in the menu settings. → Set it to ON to always display the remaining tape indicator (p. 102).

Types of trouble and their solutions

When operating using a “Memory Stick”

– DCR-IP7BT only

Symptom	Cause and/or Corrective Actions
The “Memory Stick” does not function.	<ul style="list-style-type: none">• The POWER switch is not set to MEMORY. → Set it to MEMORY (p. 118).• The “Memory Stick” is not inserted. → Insert a “Memory Stick” (p. 110).
Recording does not function.	<ul style="list-style-type: none">• The “Memory Stick” has already been recorded to its full capacity. → Delete unnecessary images and record again (p. 150).• An incorrectly formatted “Memory Stick” is inserted. → Format the “Memory Stick” using your camcorder or use another “Memory Stick” (p. 105).• The write-protect switch on the “Memory Stick” is set to LOCK. → Release the lock (p. 108).
The image cannot be deleted.	<ul style="list-style-type: none">• The image is protected. → Cancel image protection (p. 149).• The write-protect switch on the “Memory Stick” is set to LOCK. → Release the lock (p. 108).
You cannot format the “Memory Stick.”	<ul style="list-style-type: none">• The write-protect switch on the “Memory Stick” is set to LOCK. → Release the lock (p. 108).
Deleting all the images cannot be carried out.	<ul style="list-style-type: none">• The write-protect switch on the “Memory Stick” is set to LOCK. → Release the lock (p. 108).
You cannot protect an image.	<ul style="list-style-type: none">• The write-protect switch on the “Memory Stick” is set to LOCK. → Release the lock (p. 108).• The INDEX screen is not displayed. → The protect marks cannot be written when the single screen is displayed (p. 149).
You cannot write a print mark on a still image.	<ul style="list-style-type: none">• The write-protect switch on the “Memory Stick” is set to LOCK. → Release the lock (p. 108).• The INDEX screen is not displayed. → The print marks cannot be written when the single screen is displayed (p. 154).• You are trying to write a print mark on a moving picture. → Print marks cannot be written to a moving picture.

Types of trouble and their solutions

When operating using a "Memory Stick"

- DCR-IP7BT only

Symptom	Cause and/or Corrective Actions
The photo save function does not work.	<ul style="list-style-type: none">• The write-protect switch on the "Memory Stick" is set to LOCK. → Release the lock (p. 108).
You cannot play back images in actual size.	<ul style="list-style-type: none">• You may not be able to play back images in actual size when you try to play back images recorded by other equipment. This is not a malfunction.
No audio during playback.	<ul style="list-style-type: none">• No audio was recorded on the file.

Others

Symptom	Cause and/or Corrective Actions
The title is not recorded.	<ul style="list-style-type: none">• The 20 numbers of titles is already recorded. → Erase unnecessary titles (p. 94).• The tape is set to prevent accidental erasure. → Slide the write-protect tab so that the red portion is not visible (p. 27).
The Remote Commander supplied with your camcorder does not work.	<ul style="list-style-type: none">• COMMANDER is set to OFF in the menu settings. → Set it to ON (p. 102).• Something is blocking the infrared rays of the Remote Commander. → Remove the obstacle.• The batteries are inserted in the battery holder with the + - polarities incorrectly matching the + - marks. → Insert the batteries with the correct polarity (p. 192).• The batteries are dead. → Insert new ones (p. 192).
The picture from the TV or VCR does not appear even when your camcorder is connected to outputs on the TV or VCR.	<ul style="list-style-type: none">• DISPLAY is set to V-OUT/LCD in the menu settings. → Set it to LCD (p. 102).• The VIDEOINPUT setting in the menu settings is wrong. → Set it to the appropriate position.

Types of trouble and their solutions

Others

Symptom	Cause and/or Corrective Actions
No function works though the power is on.	<ul style="list-style-type: none">• Disconnect the AC power adaptor from a wall outlet or remove the battery, then reconnect it in about 1 minute. Turn the power on. If the functions still do not work, press the reset button using a sharp-pointed object. (If you press the reset button, all the settings (DCR-IP7BT: except the NETWORK mode settings) including the date and time return to the default) (p. 190).
While charging the battery pack, the CHG lamp does not light up.	<ul style="list-style-type: none">• Charging is completed.• The battery pack is not properly installed. → Install it properly (p. 18).
You cannot charge the battery pack.	<ul style="list-style-type: none">• The POWER switch is not set to OFF (CHG). → Set it to OFF (CHG).
While charging the battery pack, the CHG lamp flashes.	<ul style="list-style-type: none">• The battery pack is not properly installed. → Install it properly (p. 18).• Something is wrong with the battery pack. → Please contact your Sony dealer or local authorized Sony service facility.
The melody or beep sounds for 5 seconds.	<ul style="list-style-type: none">• Moisture condensation has occurred. → Remove the cassette and leave your camcorder for at least 1 hour to acclimatize it (p. 179).• Some troubles have occurred in your camcorder. → Remove the cassette and insert it again, then operate your camcorder.
The buttons do not appear on the screen.	<ul style="list-style-type: none">• DISPLAY was pressed. → Press the center ● on the control button. → Press DISPLAY on your camcorder or on the Remote Commander (p. 41).
The indicators appear mirror-reversed in the viewfinder or on the TV screen.	<ul style="list-style-type: none">• The mirror mode is activated. This is not a malfunction.
Image data cannot be transferred by the USB connection (DCR-IP7BT only).	<ul style="list-style-type: none">• The USB cable was connected before installation of the USB driver was completed. → Uninstall the incorrect USB driver and re-install the USB driver (p. 158).
Your camcorder gets warm.	<ul style="list-style-type: none">• This is not a malfunction.
No image is displayed on the screen when connecting with other equipment using the i.LINK cable.	<ul style="list-style-type: none">• The camcorder cannot be connected to a DV product.

Self-diagnosis display

Your camcorder has a self-diagnosis display function.

This function displays the current condition of your camcorder as a 5-digit code (a combination of a letter and figures) on the screen. If a 5-digit code is displayed, check the following code chart. The last 2 digits (indicated by □□) will differ depending on the state of your camcorder.

LCD screen or Viewfinder

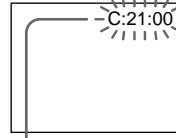

Self-diagnosis display

- C:□□:□□

You can service your camcorder yourself.

- E:□□:□□

Contact your Sony dealer or local authorized Sony facility.

Five-digit display	Cause and/or Corrective Actions
C:04:□□	<ul style="list-style-type: none"> • You are using a battery pack that is not an "InfoLITHIUM" battery pack. → Use an "InfoLITHIUM" battery pack.
C:21:□□	<ul style="list-style-type: none"> • Moisture condensation has occurred. → Remove the cassette and leave your camcorder for at least 1 hour to acclimatize it (p. 179).
C:22:□□	<ul style="list-style-type: none"> • The video heads are dirty. → Clean the heads using the cleaning cassette (p. 180).
C:31:□□ C:32:□□	<ul style="list-style-type: none"> • A malfunction other than the above that you can service has occurred. → Remove the cassette and insert it again, then operate your camcorder. → Disconnect the power cord of the AC adaptor or remove the battery pack. After reconnecting the power source, operate your camcorder.
E:61:□□	<ul style="list-style-type: none"> • A malfunction that you cannot service has occurred. → If the same code appears again after you remove and attach the power source, contact your Sony dealer or local authorized Sony service facility and inform them of the 5-digit code. (example: E:61:10)

If you are unable to rectify the problem even if you try corrective actions a few times, contact your Sony dealer or local authorized Sony service facility.

Warning indicators and messages

If indicators and messages appear on the screen, check the following:
See the page in parentheses “()” for more information.

Warning indicators

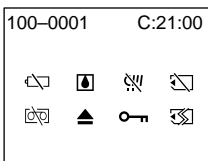

100-0001 Warning indicator as to file (DCR-IP7BT only)

Slow flashing:

- The file is corrupted.
- The file is unreadable.
- You are trying to carry out the MEMORY MIX function on a moving picture.

C:21:00 Self-diagnosis display (p. 170).

The battery is dead or nearly dead

Slow flashing:

- The battery is nearly dead.
Depending on the operating conditions, environment and battery condition, the  indicator may flash, even if there are approximately 5 to 10 minutes remaining.

Fast flashing:

- The battery is dead (p. 18).

Moisture condensation has occurred*

Fast flashing:

- Eject the cassette, turn off your camcorder, and leave it for about 1 hour with the cassette compartment open (p. 179).

Warning indicator as to “Memory Stick” (DCR-IP7BT only)*

Slow flashing:

- No “Memory Stick” is inserted.

Fast flashing:

- The “Memory Stick” inserted is not readable with your camcorder (p. 108).
- The image cannot be recorded on “Memory Stick” (p. 123, 128).

Warning indicator as to “Memory Stick” formatting (DCR-IP7BT only)*

Fast flashing:

- The “Memory Stick” data is corrupted.
- The “Memory Stick” is not formatted correctly (p. 105).

Warning indicator as to tape

Slow flashing:

- The tape is near the end.
- No tape is inserted.*
- The write-protect tab on the cassette is out (red) (p. 27).*

Fast flashing:

- The tape has run out.*

You need to eject the cassette*

Slow flashing:

- The write-protect tab on the cassette is out (red) (p. 27).

Fast flashing:

- Moisture condensation has occurred (p. 179).
- The tape has run out.
- The self-diagnosis display function is activated (p. 170).

The image is protected (DCR-IP7BT only)*

Slow flashing:

- The image is protected (p. 149).

Warning indicator as to Micro Cassette Memory*

Slow flashing:

- Eject the cassette, and insert it again. If even then the indicator flashes, the Micro Cassette Memory of the cassette may be faulty.

















Fast flashing:



- The Micro Cassette Memory of the camcorder may be faulty.

* You hear the melody or beep sound.

Warning indicators and messages

Warning messages

- CLOCK SET Set the date and time (p. 23).
- FOR “InfoLITHIUM” BATTERY ONLY Use an “InfoLITHIUM” battery pack (p. 19).
-  CLEANING CASSETTE¹⁾ The video heads are dirty (p. 180).
- COPY INHIBIT You tried to record a picture that has a copyright control signal (p. 173).¹⁾
-  FULL The Micro Cassette Memory is full (p. 91).²⁾
-  FULL The “Memory Stick” is full (p. 120).^{2) 3)}
-  NO FILE No image is recorded on the “Memory Stick” (p. 138).^{2) 3)}
-  NO MEMORY STICK No “Memory Stick” is inserted.^{2) 3)}
-  MEMORY STICK ERROR The “Memory Stick” data is corrupted (p. 110).^{2) 3)}
-  FORMAT ERROR The “Memory Stick” is not recognized (p. 105).^{2) 3)}
Check the format.
-   DIRECTORY ERROR There are more than two same directories with the same name (p. 137).^{2) 3)}
-   TAPE END The tape has reached the end of the tape.²⁾
-  NO TAPE Insert a cassette tape.²⁾
- DELETING You pressed the PHOTO button on your camcorder while deleting data in a “Memory Stick.”^{2) 3)}
- FORMATTING You pressed the PHOTO button on your camcorder while formatting a “Memory Stick.”^{2) 3)}
-   CLEANING END The cleaning is complete. Eject the cleaning cassette (p. 180).
-  TITLE FULL 20 titles have been recorded (p. 91).
- INPUT ERROR A picture in an incompatible format (such as one recorded with the DV format) is input (p. 88).
- NO INPUT You tried to start recording when no signal is input into the camcorder (p. 88).
-  NOT REC You tried to mix a moving file image (p. 134).³⁾
- CHANGE TO “CAM” or “VCR” A cleaning cassette cannot be used in MEMORY mode (p. 180).³⁾

¹⁾ The  indicator and the “ CLEANING CASSETTE“ message appear one after another on the screen.

²⁾ You hear the melody or beep sound.

³⁾ DCR-IP7BT only

Compatible cassettes

Selecting cassette types

You can use **|||||** MICROMV cassette only. You cannot use any other **8** 8 mm, **Hi8** Hi8, **D** Digital8, **VHS** VHS, **VHS-C** VHSC, **S-VHS** S-VHS, **S-VHS-C** S-VHSC, **B** Betamax, **ED Beta** ED Betamax, **DV** DV, or **mini DV** mini DV cassettes.

All of the MICROMV cassettes have Micro Cassette Memory.

CM Micro Cassette Memory, **|||||** MICROMV, and **|||||** MICROMV are trademarks of Sony Corporation.

Copyright signal

When you play back

Using any other video camera recorder, you cannot record on a tape that has recorded copyright control signals for copyright protection of software which is played back on your camcorder.

When you record

You cannot record software on your camcorder that contains copyright control signals for copyright protection of software.

COPY INHIBIT appears on the LCD screen, in the viewfinder or on the TV screen if you try to record such software. Your camcorder does not record copyright control signals on the tape when it records.

Notes on the MICROMV cassette

When affixing a label on the MICROMV cassette

Be sure to affix a label only on the location illustrated below [a] so as not to cause malfunction of your camcorder.

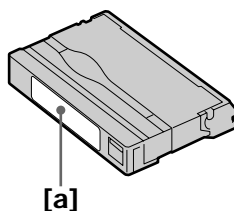

After using the MICROMV cassette

Rewind the tape to the beginning, put the cassette in its case, and store it in an upright position.

When the Micro Cassette Memory function does not work

Reinsert the cassette.

About the “InfoLITHIUM” battery pack

What is the “InfoLITHIUM” battery pack?

The “InfoLITHIUM” battery pack is a lithium-ion battery pack that has functions for communicating information related to operating conditions between your camcorder and an optional AC adaptor/charger.

The “InfoLITHIUM” battery pack calculates the power consumption according to the operating conditions of your camcorder, and displays the remaining battery time in minutes.

Charging the battery pack

- Be sure to charge the battery pack before you start using your camcorder.
- We recommend charging the battery pack in an ambient temperature of between 10°C to 30°C (50°F to 86°F) until the CHG lamp goes off, indicating that the battery pack is fully charged. If you charge the battery outside of this temperature range, you may not be able to efficiently charge the battery pack.
- After charging is completed, either disconnect the cable from the DC IN jack on your camcorder or remove the battery pack.

Effective use of the battery pack

- Battery pack performance decreases in low-temperature surroundings. So, the time that the battery pack can be used is shorter in a cold place. We recommend the following to use the battery pack longer:
 - Put the battery pack in a pocket to warm it up, and insert it in your camcorder immediately before you start taking shots.
 - Use the large capacity battery pack (NP-FF70, optional).
- Frequently using the LCD screen or frequently operating playback, fast forward or rewind wears out the battery pack faster. We recommend using the large capacity battery pack (NP-FF70, optional).
- Be certain to slide the POWER switch to OFF (CHG) when not taking shots or playing back on your camcorder. The battery pack is also consumed when your camcorder is in standby or playback paused mode.
- Have spare battery packs handy for two or three times the expected recording time, and make a trial recording before taking the actual recording.
- Do not expose the battery pack to water. The battery pack is not water resistant.

Remaining battery time indicator

- If the power goes off even although the remaining battery time indicator indicates that the battery pack has enough power to operate, charge the battery pack fully again so that the indication on the remaining battery time indicator is correct. Note, however, that the correct battery indication sometimes will not be restored if it is used in high temperatures for a long time or left in a fully charged state, or the battery pack is frequently used. Regard the remaining battery time indication as an approximate shooting time.
- The  mark indicating there is little remaining battery time sometimes flashes depending on the operating conditions or ambient temperature and environment even if the remaining battery time is about 5 to 10 minutes.

About the "InfoLITHIUM" battery pack

How to store the battery pack

- Even if the battery pack is not used for a long time, remove the battery pack from the camcorder, store it in a dry, cool place after fully charging it once per year and then using the battery pack fully on your camcorder. This is to maintain the battery pack's functions.
- To use the battery pack fully on your camcorder, turn on your camcorder and leave it as it is without a cassette inserted.

Battery life

- The battery life is limited. Battery capacity drops little by little as you use it more and more, and as time passes. When the available battery time is shortened considerably, a probable cause is that the battery pack has reached the end of its life. Please buy a new battery pack.
- The battery life varies according to how it is stored, the operating conditions, and the environment for each battery pack.

About i.LINK

The i.LINK (MICROMV) jack on this unit is an i.LINK-compliant MICROMV jack. This section describes the i.LINK standard and its features.

What is i.LINK?

i.LINK is a digital serial interface for handling digital video, digital audio and other data in two directions between equipment having i.LINK jacks, and for controlling other equipment.

i.LINK-compatible equipment can be connected by a single i.LINK cable. Possible applications are operations and data transactions with various digital AV equipment. When two or more i.LINK-compatible devices are connected to this unit in a daisy chain, operations and data transactions are possible with not only the equipment that this unit is connected to but also with other devices via the directly connected equipment.

Note, however, that the method of operation sometimes varies according to the characteristics and specifications of the equipment to be connected, and that operations and data transactions are sometimes not possible on some connected equipment.

Note

Normally, only one piece of equipment can be connected to this unit using the i.LINK cable. When connecting this unit to MICROMV-compatible equipment having two or more i.LINK jacks, refer to the instruction manual of the equipment to be connected.

About the Name "i.LINK"

i.LINK is a more familiar term for the IEEE 1394 data transport bus proposed by SONY, and is a trademark approved by many corporations. IEEE 1394 is an international standard standardized by the Institute of Electrical and Electronics Engineers.

i.LINK Baud rate

The maximum baud rate of the camcorder is "S400."

i.LINK's maximum baud rate varies according to the equipment. Three maximum baud rates are defined:

S100 (approx. 100 Mbps*)

S200 (approx. 200 Mbps)

S400 (approx. 400 Mbps)

The baud rate is listed under "Specifications" in the instruction manual of each piece of equipment. It is also indicated near the i.LINK jack on some equipment.

The maximum baud rate of equipment, except for this unit, on which it is not indicated is "S100."

When units are connected to equipment having a different maximum baud rate, the baud rate sometimes differs from the indicated baud rate.

*What is Mbps?

Mbps stands for megabits per second, or the amount of data that can be sent or received in one second. For example, a baud rate of 100 Mbps means that 100 megabits of data can be sent in one second.

About i.LINK

i.LINK functions on this unit

For details on how to dub when this unit is connected to other video equipment having i.LINK (MICROMV) jacks, see page 82, 87.

This unit can also be connected to other i.LINK compatible equipment made by SONY (e.g. VAIO series personal computers) other than video equipment.

Before connecting this unit to your computer, make sure that application software supported by this unit is already installed on your computer.

For details on precautions when connecting this unit, also refer to the instruction manuals for the equipment to be connected.

Required i.LINK Cable

Use the Sony i.LINK 4-pin-to-4-pin cable (during MPEG2 dubbing).

i.LINK and  are trademarks.

Using your camcorder abroad

Using your camcorder abroad

Countries and areas where you can use network functions are restricted. For details, refer to the separate network function operating instructions (DCR-IP7BT only).

You can use your camcorder in any country or area with the AC adaptor supplied with your camcorder within 100 V to 240 V AC, 50/60 Hz.

When charging the battery pack, use a commercially available AC plug adaptor [a], if necessary, depending on the design of the wall outlet [b].

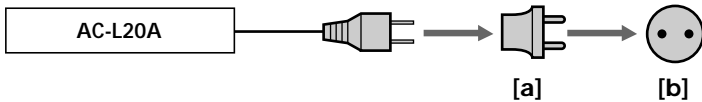

Your camcorder is an NTSC system based camcorder. If you want to view the playback picture on a TV, it must be an NTSC system-based TV with a VIDEO/AUDIO input jack.

The following shows TV color systems used overseas.

NTSC system

Bahama Islands, Bolivia, Canada, Central America, Chile, Colombia, Ecuador, Jamaica, Japan, Korea, Mexico, Peru, Surinam, Taiwan, the Philippines, the U.S.A., Venezuela, etc.

PAL system

Australia, Austria, Belgium, China, Czech Republic, Denmark, Finland, Germany, Great Britain, Holland, Hong Kong, Italy, Kuwait, Malaysia, New Zealand, Norway, Portugal, Singapore, Slovak Republic, Spain, Sweden, Switzerland, Thailand, etc.

PAL-M system

Brazil

PAL-N system



Argentina, Paraguay, Uruguay

SECAM system

Bulgaria, France, Guyana, Hungary, Iran, Iraq, Monaco, Poland, Russia, Ukraine, etc.

Maintenance information and precautions

Moisture condensation

If your camcorder is brought directly from a cold place to a warm place, moisture may condense inside your camcorder, on the surface of the tape, or on the lens. In this condition, the tape may stick to the head drum and be damaged or your camcorder may not operate correctly. If there is moisture inside your camcorder, the beep sounds and the  indicator flashes. When the  indicator flashes at the same time, a cassette is inserted in your camcorder. If moisture condenses on the lens, the indicator will not appear.

If moisture condensation occurred

None of the functions except cassette ejection will work. Eject the cassette, turn off your camcorder, and leave it for about 1 hour with the cassette compartment open. Your camcorder can be used again if the  indicator does not appear when the power is turned on again.

Note on moisture condensation

Moisture may condense when you bring your camcorder from a cold place into a warm place (or vice versa) or when you use your camcorder in a hot place as follows:

- You bring your camcorder from a ski slope into a place warmed up by a heating device
- You bring your camcorder from an air-conditioned car or room into a hot place outside
- You use your camcorder after a squall or a shower
- You use your camcorder in a high temperature and humidity place



How to prevent moisture condensation

When you bring your camcorder from a cold place into a warm place, put your camcorder in a plastic bag and tightly seal it. Remove the bag when the air temperature inside the plastic bag has reached the surrounding temperature (after about 1 hour).

Maintenance information

Cleaning the video head

To ensure normal recording and clear pictures, clean the video head. The video head may be dirty when:

- mosaic-pattern noise appears on the playback picture.
- playback pictures do not move.
- playback pictures do not appear.
- the  indicator and “ CLEANING CASSETTE” message appear one after another or the  indicator flashes on the screen during recording.

If the above problem, [a], [b] or [c] occurs, clean the video heads with the Sony MGRCLD cleaning cassette. Check the picture and if the above problem persists, repeat cleaning.

[a]



[b]



[c]



If the video heads get dirtier, the entire screen becomes blue [c].

Playing back a cleaning cassette automatically

The camcorder is equipped with the cleaning cassette auto playback function. Follow the procedure below.

- (1) Set the POWER switch to CAMERA or VCR.
- (2) Insert the cleaning cassette.
- (3) Select OK, then press the center  on the control button. The message “NOW CLEANING” appears.
After the cleaning is finished, the message “CLEANING END” appears.
- (4) Eject the cleaning cassette.

To cancel cleaning

Select CANCEL, then press the center  on the control button.

The video head

The video head wears out if you use the camcorder for a long time. When use of the cleaning cassette does not make the picture clear, the video head may have worn out. In such cases, you must replace the video head. For details, consult your nearest Sony dealer.

Notes

- When cleaning the video head, do not use any equipment other than the cleaning cassette.
- The cleaning cassette does not work in MEMORY mode (DCR-IP7BT only).

Maintenance information and precautions

Cleaning the LCD screen

If fingerprints or dust make the LCD screen dirty, we recommend using an LCD Cleaning Kit (optional) to clean the LCD screen.

Removing dust from inside the viewfinder

- (1) Pull out the viewfinder in the direction of the arrow ①. Remove the two screws in the direction of the arrow ② with a screwdriver (optional). Remove the eyecup in the direction of the arrow while pressing the projection ③.

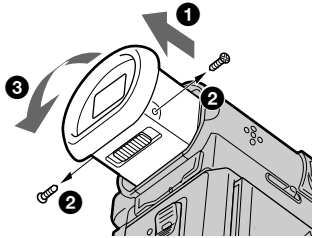

- (2) Remove dust from inside the eyecup and viewfinder with a commercially available blower.
- (3) In reverse, starting from ③, attach the eyecup. Then replace the screws in the direction of the arrow ②.

Caution

Do not remove any other screws. You may remove only the screws necessary to remove the eyecup.

Notes

- Do not drop or bend the eyecup shaft.
- Be careful when handling the eyecup.

Charging the built-in rechargeable battery

Your camcorder is supplied with a built-in rechargeable battery installed so as to retain the date and time, etc., regardless of the setting of the POWER switch. The built-in rechargeable battery is always charged as long as you are using your camcorder. The battery, however, will get discharged gradually if you do not use your camcorder. It will be completely discharged in about 3 months if you do not use your camcorder at all. Even if the built-in rechargeable battery is not charged, it will not affect the camcorder operation. To retain the date and time, etc., charge the battery if the battery is discharged.

Maintenance information and precautions

Charging the built-in rechargeable battery:

- Connect your camcorder to the house current using the AC adaptor supplied with your camcorder, and leave your camcorder with the POWER switch turned off for more than 24 hours.
- Install a fully charged battery pack in your camcorder, and leave your camcorder with the POWER switch turned off for more than 24 hours.

Precautions

Camcorder operation

- Operate your camcorder on 7.2 V (battery pack) or 8.4 V (AC power adaptor).
- For DC or AC operation, use the accessories recommended in this operating instructions.
- If any solid object or liquid gets inside the casing, unplug your camcorder and have it checked by a Sony dealer before operating it any further.
- Avoid rough handling or mechanical shock. Be particularly careful of the lens.
- Keep the POWER switch set to OFF (CHG) when you are not using your camcorder.
- Do not wrap your camcorder with a towel, for example, and operate it. Doing so might cause heat to build up inside.
- Keep your camcorder away from strong magnetic fields or mechanical vibration.
- Do not touch the LCD screen with a sharp-pointed object.
- Do not strongly press the LCD screen.
- If your camcorder is used in a cold place, a residual image may appear on the LCD screen. This is not a malfunction.
- While using your camcorder, the back of the LCD screen may heat up. This is not a malfunction.
- Do not use the network function in a medical institution or in an aircraft (DCR-IP7BT only).

On handling tapes

- Do not insert anything into the small holes on the rear of the cassette. These holes are used to sense the type and thickness of the tape and if the recording tab is in or out.
- Do not open the tape protect cover or touch the tape.
- Avoid touching or damaging the terminals. To remove dust, clean the terminals with a soft cloth.

Camcorder care

- Remove the tape, and periodically turn on the power, operate the CAMERA and VCR sections and play back a tape for about 3 minutes when your camcorder is not to be used for a long time.
- Clean the lens with a soft brush to remove dust. If there are fingerprints on the lens, remove them with a soft cloth.
- Clean the camcorder body with a dry soft cloth, or a soft cloth lightly moistened with a mild detergent solution. Do not use any type of solvent which may damage the finish.
- Do not let sand get into your camcorder. When you use your camcorder on a sandy beach or in a dusty place, protect it from the sand or dust. Sand or dust may cause your camcorder to malfunction, and sometimes this malfunction cannot be repaired.

Maintenance information and precautions

AC power adaptor

- Unplug the unit from a wall outlet when you are not using the unit for a long time. To disconnect the power cord, pull it out by the plug. Never pull the power cord itself.
- Do not operate the unit with a damaged cord or if the unit has been dropped or damaged.
- Do not bend the power cord forcibly, or place a heavy object on it. This will damage the cord and may cause fire or electrical shock.
- Prevent metallic objects from coming into contact with the metal parts of the connecting section. If this happens, a short may occur and the unit may be damaged.
- Always keep metal contacts clean.
- Do not disassemble the unit.
- Do not apply mechanical shock or drop the unit.
- While the unit is in use, particularly during charging, keep it away from AM receivers and video equipment. AM receivers and video equipment disturb AM reception and video operation.
- The unit becomes warm during use. This is not a malfunction.
- Do not place the unit in locations that are:
 - Extremely hot or cold
 - Dusty or dirty
 - Very humid
 - Vibrating

About care and storage of the lens

- Wipe the surface of the lens clean with a soft cloth in the following instance:
 - When there are fingerprints on the lens surface
 - In hot or humid locations
 - When the lens is used in environments such as at the seaside
- Store the lens in a well-ventilated location subject to little dirt or dust.

To prevent mold from occurring, periodically perform the above preventive tasks. We recommend turning on and operating the video camera recorder about once per month to keep the video camera recorder in an optimum state for a long time.

Battery pack

- Use only the specified charger or video equipment with for charging function.
- To prevent an accident from a short circuit, do not allow metal objects to come into contact with the battery terminals.
- Keep the battery pack away from fire.
- Never expose the battery pack to temperatures above 60°C (140°F), such as in a car parked in the sun or under direct sunlight.
- Store the battery pack in a cool, dry place.
- Do not expose the battery pack to any mechanical shock.
- Do not disassemble nor modify the battery pack.
- Attach the battery pack to the video equipment securely.
- Charging while some capacity remains does not affect the original battery capacity.

Notes on dry batteries

To avoid possible damage from battery leakage or corrosion, observe the following:

- Be sure to insert the batteries with the + - polarities matched to the + - marks.
- Dry batteries are not rechargeable.
- Do not use a combination of new and old batteries.
- Do not use different types of batteries.
- Current flows from batteries when you are not using them for a long time.
- Do not use leaking batteries.

If batteries are leaking

- Wipe off the liquid in the battery compartment carefully before replacing the batteries.
- If you touch the liquid with your hands, wash it off with water.
- If the liquid gets into your eyes, wash your eyes with a lot of water and then consult a doctor.

If any problem occurs, unplug your camcorder and contact your nearest Sony dealer.

Specifications

Video camera recorder

System

Video recording system

2 rotary heads

Helical scanning system

Audio recording system

Rotary heads, PCM system

Quantization: 12 bits

(Fs 48 kHz, stereo)

Video signal

NTSC color, EIA standards

Usable cassette

MICROMV cassette with the

■■■■ mark printed

Tape speed

Approx. 5.66 mm/s

Recording/playback time

(using cassette MGR60)

1 hour

Fastforward/rewind time

(using cassette MGR60)

Approx. 1 min and 30 s

Viewfinder

Electric viewfinder (color)

Image device

3.0 mm (1/6 type) CCD

(Charge Coupled Device)

Approx. 680 000 pixels

(Effective: 340 000 pixels)

Lens

Carl Zeiss

Combined power zoom lens

Filter diameter 30 mm. (1 3/16 in.)

10× (Optical), 120× (Digital)

Focal length

2.3 - 23 mm (3/32 - 29/32 in.)

When converted to a 35 mm still

camera 44 - 440 mm (1 3/4 -

17 3/8 in.)

Color temperature

Auto, HOLD (Hold),  Indoor

(3 200K),  Outdoor (5 800K)

Minimum illumination

7 lx (lux) (F 1.7)

Input/Output connectors

Audio/Video input/output

10-pin connector

Input/output auto switch

Video signal: 1 Vp-p, 75 Ω (ohms),

unbalanced, sync negative

Luminance signal: 1 Vp-p, 75 Ω

(ohms), unbalanced

Chrominance signal: 0.286 Vp-p,

75 Ω (ohms), unbalanced

Audio signal: 327 mV, (at output impedance more than 47 kΩ

(kilohms))

Input impedance with more than 47 kΩ (kilohms)

Output impedance with less than 2.2 kΩ (kilohms)

USB jack

mini-B

i.LINK (MICROMV) input/output

4-pin connector S400

LCD screen

Picture

6.2 cm (2.5 type)

50 × 37 mm (2 × 1 1/2 in.)

Total dot number:

211 200 (960 × 220)

Wireless communication (DCR-IP7BT only)

Communication system

Bluetooth specification Ver. 1.1

Maximum communication

speed ¹⁾²⁾

Approx. 723 kbps

Maximum output

Bluetooth specification Power

Class2

Communication distance ²⁾

Approx. 10 m (33 feet) (Open

space, when using a Sony BTA-

NW1 Modem Adaptor with

Bluetooth Function)

Compatible Bluetooth profiles ³⁾

Generic Access Profile

Dial-up Networking Profile

Usable frequency band

2.4 GHz band

(2.400 - 2.4835 GHz)

1) The maximum rate defined by Bluetooth specification Ver. 1.1

2) Depends on obstacles between the Bluetooth devices, radio wave conditions, etc.

3) Defined by Bluetooth specification for intended use between the Bluetooth devices

General

Power requirements

7.2 V (battery pack)

8.4 V (AC power adaptor)

Average power consumption

(when using the battery pack)

During camera recording using

the viewfinder (brightness

normal) 3.5 W

During camera recording using the LCD (Backlighting on) 4.2 W

During camera recording using the LCD (Backlighting off) 3.5 W

Operating temperature

0°C to 40°C (32°F to 104°F)

Storage temperature

-20°C to +60°C (-4°F to +140°F)

Dimensions (approx.)

47 × 103 × 80 mm

(1 7/8 × 4 × 3 1/8 in.) (w/h/d)

(excluding protruding parts)

Mass (approx.)

310 g (10 oz)

Main unit only

370 g (13 oz)

including the battery pack,

NP-FF50, cassette MGR60, lens

cap, and wrist strap

Supplied accessories

See page 16.

AC power adaptor AC-L20A

Power requirements

100 - 240 V AC, 50/60 Hz

Power consumption

23 W

Output voltage

DC OUT: 8.4 V, 1.5 A in the

operating mode

Operating temperature

0°C to 40°C (32°F to 104°F)

Storage temperature

-20°C to +60°C (-4°F to +140°F)

Dimensions (approx.)

125 × 39 × 62 mm (5 × 1 9/16 ×

2 1/2 in.) (w/h/d) excluding

(projecting parts) power cord

Mass (approx.)

280 g (9.8 oz)

excluding the power cord

Specifications

Battery pack NP-FF50

Maximum output voltage

DC 8.4 V

Output voltage

DC 7.2 V

Capacity

4.8 Wh (675 mAh)

Operating temperature

0°C to 40°C (32°F to 104°F)

Dimensions (approx.)

40.8 × 12.5 × 49.1 mm

(1 5/8 × 1/2 × 1 15/16 in.)

(w/h/d)

Mass (approx.)

45 g (1.6 oz)

Type

Lithium ion

“Memory Stick” (DCR-IP7BT only)

Memory

Flash memory

8 MB: MSA-8A

Operating voltage

2.7-3.6V

Power consumption

Approx. 45 mA in the operating mode

Approx. 130 µA in the standby mode

Dimensions (approx.)

50 × 2.8 × 21.5 mm

(2 × 1/8 × 7/8 in.) (w/h/d)

Mass (approx.)

4 g (0.14 oz)

Design and specifications are subject to change without notice.

Identifying the parts and controls

Camcorder

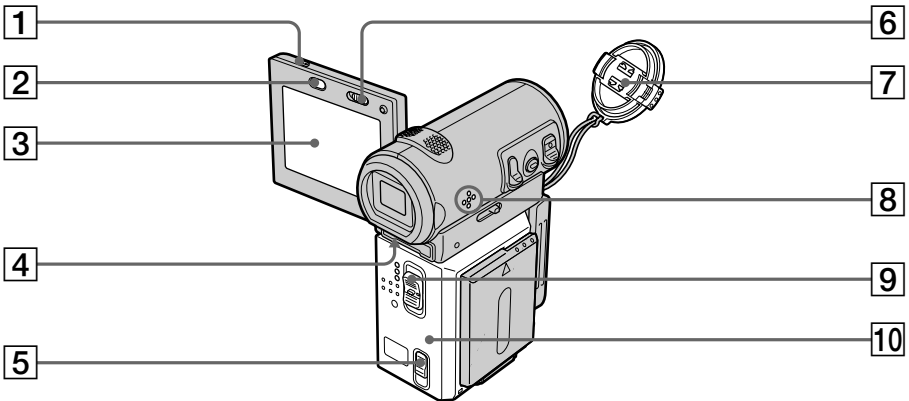

- | | |
|---|---------------------------------------|
| 1 OPEN button (p. 27) | 6 LCD BACKLIGHT switch (p. 32) |
| 2 BROWSER MENU button (p. 162)
(DCR-IP7BT only) | 7 Lens cap (p. 29) |
| 3 LCD screen (p. 30) | 8 Speaker |
| 4 Viewfinder lens adjustment lever
(p. 33) | 9 POWER switch (p. 29) |
| 5 OPEN/▲EJECT lever (p. 27) | 10 Cassette lid (p. 27) |



This mark indicates that this product is a genuine accessory for Sony video products.

When purchasing Sony video products, Sony recommends that you purchase accessories with this "GENUINE VIDEO ACCESSORIES" mark.

Identifying the parts and controls

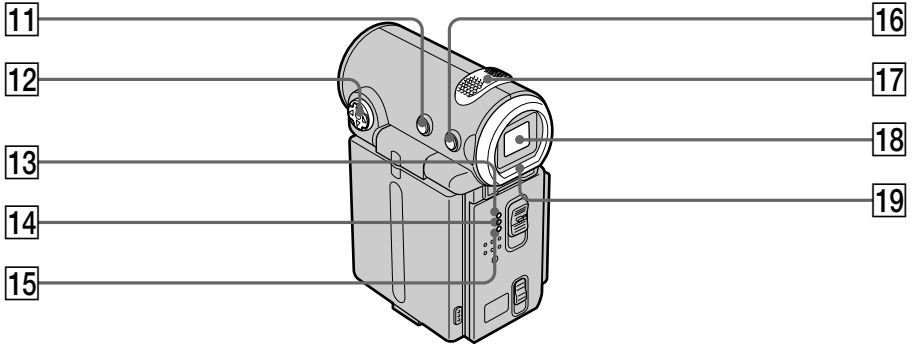

11 DISPLAY button (p. 41)

12 Control button (▲/▼/◀/▶/●) (p. 7)

13 CAMERA lamp

14 MEMORY/NETWORK lamp
(DCR-IP7BT only)

15 VCR lamp

16 BACK LIGHT button (p. 36)





17 Built-in Microphone (p. 29)

18 Viewfinder (p. 33)

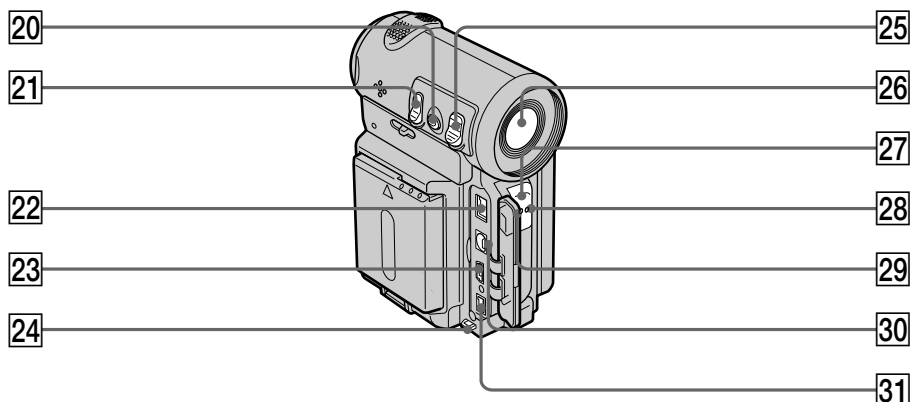
19 Eyecup

Identifying the parts and controls



- | | |
|---|---|
| 20 ZOOM button (p. 34) | 26 Lens |
| 21 PHOTO button (p. 47, 118) | 27 Camera recording lamp (p. 29) |
| 22 DC IN jack (p. 19) | 28  (Bluetooth) lamp (p. 162)
(DCR-IP7BT only) |
| 23  USB jack (p. 157)
(DCR-IP7BT only) | 29 Remote sensor |
| 24 Hook for wrist strap | 30 A/V (ID-2) jack (p. 45, 81, 85, 124, 130) |
| 25 START/STOP button (p. 29) | 31  i.LINK (MICROMV) jack
(p. 82, 87, 125, 130)
The  i.LINK (MICROMV) jack is i.LINK compatible. |

Note on the Carl Zeiss lens

Your camcorder is equipped with a Carl Zeiss lens which can reproduce a fine image. The lens for your camcorder was developed jointly by Carl Zeiss, in Germany, and Sony Corporation. It adopts the MTF* measurement system for video cameras and offers a quality as the Carl Zeiss lens.

* MTF is an abbreviation of Modulation Transfer Function.

The value number indicates the amount of light of a subject penetrating into the lens.

Identifying the parts and controls

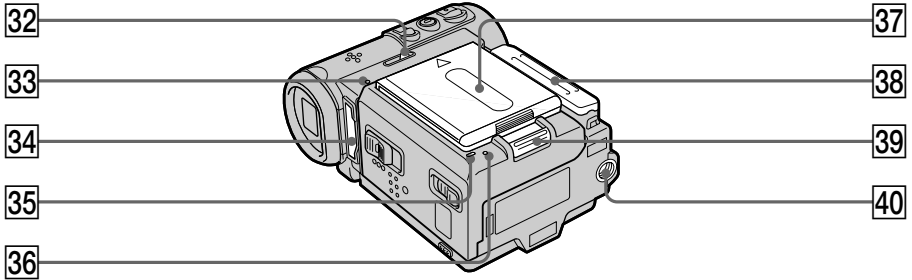

32 MEMORY EJECT lever (p. 110)
(DCR-IP7BT only)

33 Access lamp (p. 110)
(DCR-IP7BT only)

34 "Memory Stick" slot (p. 110)
(DCR-IP7BT only)

35 CHG lamp (p. 19)

36 Reset button (p. 169)

37 Battery/Battery terminal cover (p. 18)

38 Jack cover

39 ▼BATT (battery) release lever (p. 18)

40 Tripod receptacle
Make sure that the length of the tripod
screw is less than 5.5 mm (7/32 inch).
Otherwise, you cannot attach the tripod
securely and the screw may damage
your camcorder.

Identifying the parts and controls

Remote Commander

The buttons that have the same name on the Remote Commander as on your camcorder function identically to the buttons on your camcorder.

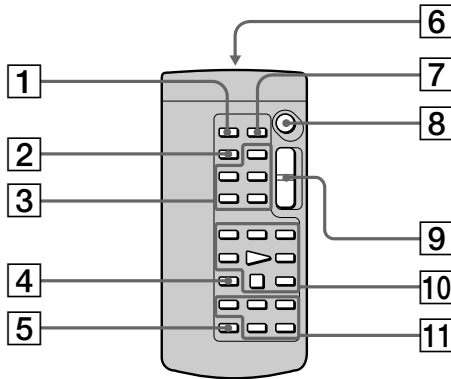

- | | |
|--|---|
| 1 PHOTO button (p. 47, 118) | 6 Transmitter
Point toward the remote sensor to control your camcorder after turning on your camcorder. |
| 2 DISPLAY button (p. 41) | 7 DATA CODE button (p. 41) |
| 3 MEMORY control buttons (DCR-IP7BT only) | 8 START/STOP button (p. 29) |
| 4 SEARCH MODE button (p. 75 to 79) | 9 Power zoom button (p. 34) |
| 5 MULTI SRCH button (p. 71) | 10 Video control buttons (p. 39) |
| | 11 ↑/↓/←/→/EXECUTE buttons
These buttons function the same as the control button on the camcorder. |

Identifying the parts and controls

To prepare the Remote Commander

Insert two size AA (R6) batteries by matching the + and - polarities on the batteries to the + - marks inside the battery compartment.

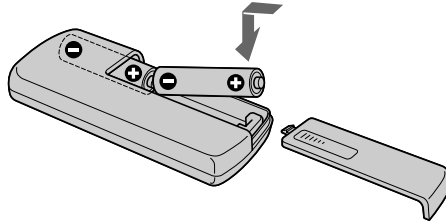

Notes on the Remote Commander

- Point the remote sensor away from strong light sources such as direct sunlight or overhead lighting. Otherwise, the Remote Commander may not function properly.
- Your camcorder works in commander mode VTR 2. Commander modes 1, 2 and 3 are used to distinguish your camcorder from other Sony VCRs to avoid remote control misoperation. If you use another Sony VCR in Commander mode VTR 2, we recommend changing the commander mode or covering the sensor of the VCR with black paper.

Identifying the parts and controls

Operation indicators

LCD screen and viewfinder

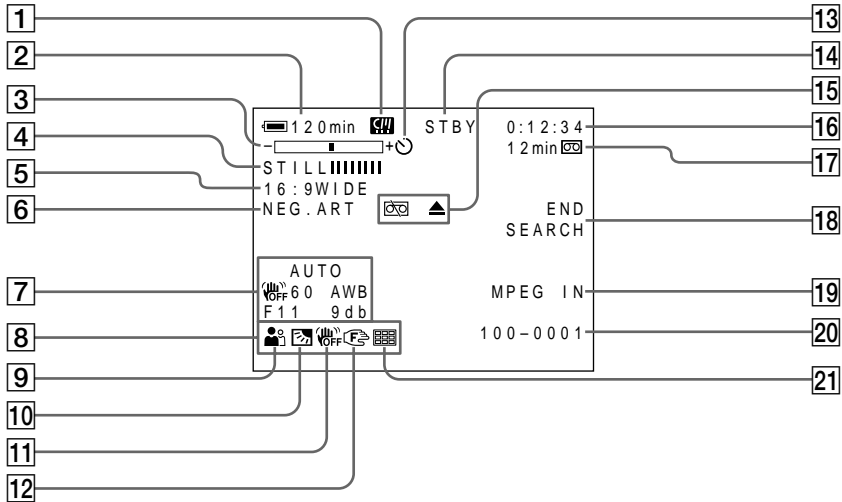

- 1 Micro Cassette Memory indicator (p. 173)
- 2 Remaining battery time indicator (p. 35)
- 3 Zoom indicator (p. 34)/Data file name indicator (p. 108) (DCR-IP7BT only)
- 4 Digital effect indicator (p. 56)/MEMORY MIX indicator (p. 132) (DCR-IP7BT only)/FADER indicator (p. 51)
- 5 16:9WIDE indicator (p. 49)
- 6 Picture effect indicator (p. 54)
- 7 Data code indicator (p. 41)
- 8 Date indicator
- 9 PROGRAM AE indicator (p. 59)
- 10 Backlight indicator (p. 36)
- 11 SteadyShot off indicator (p. 104)
- 12 Manual focus/Infinity indicator (p. 65)
- 13 Self-timer indicator (p. 37, 48, 121)
- 14 STBY/REC indicator (p. 29)/Video control mode indicator (p. 43)/Movie mode indicator (p. 115) (DCR-IP7BT only)/Image quality mode indicator (p. 113) (DCR-IP7BT only)
- 15 Warning indicators (p. 171)
- 16 Tape counter indicator (p. 35)/Self-diagnosis indicator (p. 170)/Photo mode indicator (p. 47, 118)/Image number indicator (p. 118) (DCR-IP7BT only)
- 17 Remaining tape indicator (p. 35)/Memory playback indicator (p. 138)
- 18 END SEARCH indicator (p. 38)
- 19 MPEG IN indicator (p. 88)
- 20 Data file name indicator (p. 132) (DCR-IP7BT only)
This indicator appears when the MEMORY MIX functions work. /Time indicator
- 21 Multi screen mode indicator (p. 119)

Index

A, B

AC power adaptor	21
Adjusting viewfinder	33
AUTO SHTR	103
A/V connecting cable	44, 81, 85, 124, 130
A/V jack	44, 81, 85, 124, 130
BACK LIGHT	36
Battery pack	18
BEEP	107
BOUNCE	51

C, D

Camera chromakey	132
Carl Zeiss lens	189
Cassette information	98
Charging the battery	19
Clock set	23
Data code	41
Date/time indicator	35
Date search	77
DEMO MODE	106
DIGITAL EFFECT	57, 69
DISPLAY	41
Dubbing a tape	81

E

END SEARCH	38
Exposure	64

F, G, H

Fader	51
Fade in/out	51
FLASH MOTION	56
FOCUS	65
Format	105
Full charge	19
Heads	180

I, J, K, L

i.LINK	82, 87, 125, 130, 176
Image protection	149
Image quality mode	113
Index screen	139
"InfoLITHIUM" battery	174
JPEG	108
Labeling a cassette	99
LUMINANCEKEY	56

M, N

Manual focus	65
Memory chromakey	132
Memory luminancekey	132
MEMORY MIX	132
Memory overlap	132
Memory PB ZOOM	145
"Memory Stick"	108
Menu settings	102
Micro Cassette Memory	98
MICROMV format	14, 173
Mirror mode	31
Moisture condensation	179
MONOTONE	51
MOSC.FADER	51
MPEG	108
Multi-picture search	71
Multi screen mode	119
Multi-screen shooting	119
NORM. FADER	51
NTSC system	178

O, P, Q

OLD MOVIE	56
Operation indicators	193
Photo save	135
Photo search	79
PICTURE EFFECT	54, 67
Picture search	43
Playback pause	43
Power zoom	34
Print mark	154
PROGRAM AE	59

R

Rechargeable battery	181
Recording time	20
Remaining battery time indicator	35
Remaining tape indicator	35
Remote commander	191
Remote sensor	189
Reset	169

S

Self-diagnosis display	170
Self-timer recording	37, 48, 121
Skip scan	43
Slide show	147
Slow playback	43
SLOW SHUTTER	56
STEADYSHOT	104
STILL	56

T, U, V

Tape counter	35
Tape Photo recording	47
Telephoto	34
Time-zone difference	25
Title	89, 95
Title search	75
TRAIL	56
Transition	30
TV color systems	178
USB	157

W, X, Y, Z

Warning indicators	171
White balance	62
Wide-angle	34
Wide mode	49
Write-protect switch	108
Write-protect tab	26
Zoom	34

<http://www.world.sony.com/>

Printed on recycled paper

Sony Corporation Printed in Japan



3 0 6 9 9 3 3 1 2

Download from [Www.Somanuals.com](http://www.Somanuals.com). All Manuals Search And Download.

Free Manuals Download Website

<http://myh66.com>

<http://usermanuals.us>

<http://www.somanuals.com>

<http://www.4manuals.cc>

<http://www.manual-lib.com>

<http://www.404manual.com>

<http://www.luxmanual.com>

<http://aubethermostatmanual.com>

Golf course search by state

<http://golfingnear.com>

Email search by domain

<http://emailbydomain.com>

Auto manuals search

<http://auto.somanuals.com>

TV manuals search

<http://tv.somanuals.com>