

Digital Video Camera Recorder ^{Mini DV} Digital Video Cassette

Operating Instructions

Before operating the unit, please read this manual thoroughly, and retain it for future reference.

Owner's Record

The model and serial numbers are located on the bottom. Record the serial number in the space provided below. Refer to these numbers whenever you call upon your Sony dealer regarding this product.

Model No. **DCR-TRV** _____ Model No. **AC**- _____

Serial No. _____ Serial No. _____

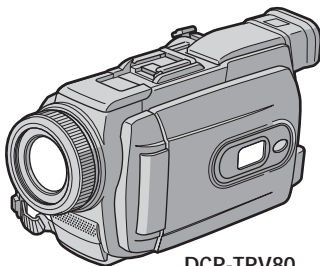

DCR-TRV80

Digital Handycam

Network Handycam



DCR-TRV75/TRV80

Welcome!

Congratulations on your purchase of this Sony Handycam. With your Handycam, you can capture life's precious moments with superior picture and sound quality. Your Handycam is loaded with advanced features, but at the same time it is very easy to use. You will soon be producing home video that you can enjoy for years to come.

WARNING

To prevent fire or shock hazard, do not expose the unit to rain or moisture.

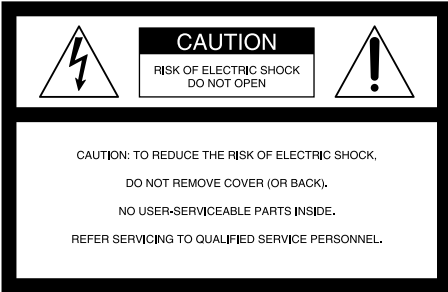

This symbol is intended to alert the user to the presence of uninsulated "dangerous voltage" within the product's enclosure that may be of sufficient magnitude to constitute a risk of electric shock to persons.



This symbol is intended to alert the user to the presence of important operating and maintenance (servicing) instructions in the literature accompanying the appliance.

CAUTION

The use of optical instruments with this product will increase eye hazard. As the laser beam used in this Handycam is harmful to eyes, do not attempt to disassemble the cabinet.

Refer to servicing to qualified personnel only.

Notice

If static electricity or electromagnetism causes data transfer to discontinue midway (fail), restart the application or disconnect and connect the USB cable again.

For customers in the U.S.A. and CANADA

CAUTION

TO PREVENT ELECTRIC SHOCK, MATCH WIDE BLADE OF PLUG TO WIDE SLOT, FULLY INSERT.

RECYCLING LITHIUM-ION BATTERIES

Lithium-Ion batteries are recyclable. You can help preserve our environment by returning your used rechargeable batteries to the collection and recycling location nearest you.



For more information regarding recycling of rechargeable batteries, call toll free 1-800-822-8837, or visit <http://www.rbrbc.org/>

Caution: Do not handle damaged or leaking Lithium-Ion batteries.

"Memory Stick"

This device complies with Part 15 of the FCC Rules. Operation is subject to the following two conditions: (1) This device may not cause harmful interference, and (2) this device must accept any interference received, including interference that may cause undesired operation.

This Class B digital apparatus complies with Canadian ICES-003.

DCR-TRV80 only

You can only use the Bluetooth wireless connection function in the country or area where you purchase the devices. For details, refer to the separate Network Function/Application Operating Instructions.

For customers in the U.S.A.

If you have any questions about this product, you may call:
Sony Customer Information Center 1-800-222-SONY (7669)
The number below is for the FCC related matters only.

Regulatory Information

Declaration of Conformity

Trade Name: SONY
Model No.: DCR-TRV80
Responsible Party: Sony Electronics Inc.
Address: 680 Kinderkamack
Road, Oradell,
NJ07649 U.S.A.
Telephone No.: 201-930-6972

This device complies with Part 15 of the FCC Rules. Operation is subject to the following two conditions: (1) This device may not cause harmful interference, and (2) this device must accept any interference received, including interference that may cause undesired operation.

DCR-TRV80 only IMPORTANT NOTE

To comply with FCC RF exposure compliance requirements, the following antenna installation and device operating configurations must be satisfied: the antenna has been installed by the manufacturer and no changes can be made.

This device and its antenna (s) must not be co-located or operating in conjunction with any other antenna or transmitter.

CAUTION

You are cautioned that any changes or modifications not expressly approved in this manual could void your authority to operate this equipment.

Note:

This equipment has been tested and found to comply with the limits for a Class B digital device, pursuant to Part 15 of the FCC Rules. These limits are designed to provide reasonable protection against harmful interference in a residential installation. This equipment generates, uses, and can radiate radio frequency energy and, if not installed and used in accordance with the instructions, may cause harmful interference to radio communications. However, there is no guarantee that interference will not occur in a particular installation. If this equipment does cause harmful interference to radio or television reception, which can be determined by turning the equipment off and on, the user is encouraged to try to correct the interference by one or more of the following measures:

- Reorient or relocate the receiving antenna.
- Increase the separation between the equipment and receiver.
- Connect the equipment into an outlet on a circuit different from that to which the receiver is connected.
- Consult the dealer or an experienced radio/TV technician for help.

The supplied interface cable must be used with the equipment in order to comply with the limits for a digital device pursuant to Subpart B of Part 15 of FCC Rules.

For customers in CANADA

DCR-TRV80 only

The term "IC:" before the radio certification number only signifies that Industry Canada technical specifications were met.

Main Features

Recording moving pictures or still images, and playing them back

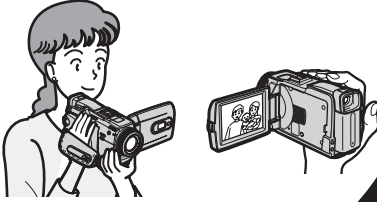

- Recording moving pictures on the tape (p. 25)
- Playing back the tape (p. 37)
- Recording still images on the “Memory Stick” (p. 44, 107)
- Recording moving pictures on the “Memory Stick” (p. 120)
- Viewing still images recorded on the “Memory Stick” (p. 128)
- Viewing moving pictures recorded on the “Memory Stick” (p. 130)

- Viewing moving pictures recorded on the tape using the USB cable (p. 154)
- Viewing images recorded on the “Memory Stick” using the USB cable (p. 161, 166)
- Capturing images on the computer from your camcorder using the USB cable (p. 156)
- Converting an analog signal into digital to capture images onto the computer (p. 167)

Capturing images on the computer

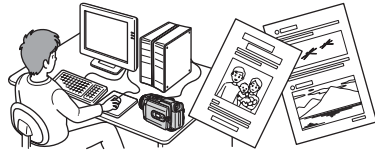

Accessing the network and using BIP (DCR-TRV80 only)

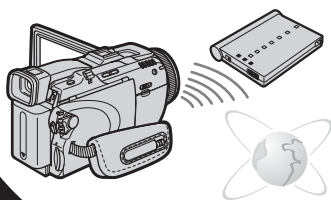

- You can access the Internet using a Bluetooth device (optional) or a dedicated accessory that serves as a USB Network Adaptor (optional) etc.
- You can use the following functions by connecting to a Bluetooth device (optional) using BIP.

- Remote Camera
- Image Transport

For details, refer to the Network Function/Application Operating Instructions supplied with your camcorder. (DCR-TRV80 only) (p. 169)

Other uses

Functions for adjusting exposure during recording

- Back light function (p. 32)
- NightShot/Super NightShot/Color Slow Shutter (p. 32)
- PROGRAM AE (p. 57)
- Manual exposure (p. 59)
- Flexible Spot Meter (p. 60)
- Recording images with the flash (p. 111)

Functions for giving images more impact

- Digital zoom (p. 31)
The default setting is OFF. (To zoom greater than 10 \times , select the digital zoom power in D ZOOM in the menu settings.)
- Fader (p. 50)
- Picture effect (p. 53)
- Digital effect (p. 54)
- Title (p. 95)
- MEMORY MIX (p. 116)

Functions for giving a natural appearance to your recordings

- PROGRAM AE (p. 57)
 - SPORTS
 - LANDSCAPE
- Manual focus (p. 61)
- Expanded focus (p. 61)
- Spot Focus (p. 63)

Functions for using after recording

- End search/Edit search/Rec Review (p. 35)
- Data code (p. 38)
- Tape PB ZOOM/Memory PB ZOOM (p. 71, 133)
- Zero set memory (p. 72)
- Title search (p. 73)
- Digital program editing (p. 78, 125)

Table of contents

Main Features	4
----------------------------	---

Quick Start Guide

- Recording on tape	8
- Recording on “Memory Stick”	10

Getting Started

Using this manual	12
Checking supplied accessories	14
Step 1 Preparing the power source	15
Installing the battery pack	15
Charging the battery pack	16
Connecting to a wall outlet	19
Step 2 Setting the date and time	20
Step 3 Using the touch panel	23

Recording – Basics

Recording a picture	25
Shooting backlit subjects	
- Back light function	32
Shooting in the dark	
- NightShot/Super NightShot/ Color Slow Shutter	32
Checking recordings	
- End search/Edit search/Rec	
Review	35

Playback – Basics

Playing back tape	37
To display the screen indicators	
- Display function	38
Viewing a recording on TV	42

Advanced Recording Operations

Recording still images on “Memory Stick” during tape recording standby or tape recording	44
Self-timer recording	46
Adjusting the white balance manually	47
Using the wide mode	48
Using the fader function	50
Using special effects	
- Picture effect	53
Using special effects – Digital effect ...	54
Using PROGRAM AE	57
Adjusting the exposure manually	59
Using spot light-metering function	
- Flexible Spot Meter	60

Focusing manually	61
Using spot focus function	
- Spot Focus	63
Interval Recording	64
Frame by frame recording	
- Frame recording	65
Recording with all the pixels	
- Progressive Recording Mode	66
Using the viewfinder	67

Advanced Playback Operations

Playing back tape	
with picture effect	69
Playing back tape	
with digital effect	70
Enlarging images recorded on tape	
- Tape PB ZOOM	71
Quickly locating a scene	
- Zero set memory	72
Searching the boundaries of recorded tape by title – Title search	73
Searching a recording by date	
- Date search	74

Editing

Dubbing tape	76
Dubbing only desired scenes	
- Digital program editing (on tape)	78
Recording video or TV programs	87
Inserting a scene from a VCR	
- Insert editing	89
Audio dubbing	91
Superimposing a title on a cassette	
with Cassette Memory	95
Making your own titles	97
Labeling a cassette on a cassette	
with Cassette Memory	98
Erasing all the data in Cassette Memory	99

“Memory Stick” Operations

Using “Memory Stick”	
- Introduction	100
Selecting the quality and size of image data	103
Recording still images on “Memory Stick”	
- Memory Photo recording	107
Recording an image from tape as a still image	114

Table of contents

Superimposing a still image in “Memory Stick” on an image – MEMORY MIX	116
Interval Photo Recording	119
Recording moving pictures on “Memory Stick” – MPEG MOVIE recording	120
Self-timer recording	122
Recording a picture from tape as a moving picture	123
Recording edited pictures from tape as a moving picture – Digital program editing (on “Memory Stick”)	125
Changing the recording folder	127
Viewing a still image – Memory Photo playback	128
Viewing a moving picture – MPEG MOVIE playback	130
Choosing playback folder	132
Enlarging still images recorded on “Memory Stick” – Memory PB ZOOM	133
Playing back images continuously – Slide show	134
Preventing accidental erasure – Image protection	135
Deleting images – DELETE	136
Changing image size – Resize	139
Writing a print mark – Print mark ...	140

Viewing images with a computer

Viewing images with a computer – Introduction	141
Connecting your camcorder to a computer using the USB cable (For Windows users)	144
Viewing pictures recorded on tape on a computer – USB Streaming (For Windows users)	154
Viewing images recorded on “Memory Stick” on a computer (For Windows users)	161
Connecting your camcorder to a computer using the USB cable (For Macintosh users)	164
Viewing images recorded on “Memory Stick” on a computer (For Macintosh users)	166

Capturing images from an analog video unit on a computer – Signal convert function	167
--	-----

Using the Network function (DCR-TRV80 only)

For details, refer to the Network Function/
Application Operating Instructions
supplied with your camcorder.

Accessing the network	169
Using applications	171

Customizing Your Camcorder

Changing the menu settings	172
----------------------------------	-----

Troubleshooting

Types of trouble and how to correct trouble	183
Self-diagnosis display	191
Warning indicators	192
Warning messages	193

Additional Information

Usable cassettes	194
About the “InfoLITHIUM” battery pack	197
About i.LINK	199
Using your camcorder abroad	201
Maintenance information and precautions	202
Specifications	208

Quick Reference

Identifying parts and controls	210
Index	217

Quick Start Guide – Recording on tape

1 Connecting the power cord

Use the battery pack when using your camcorder outdoors (p. 15).

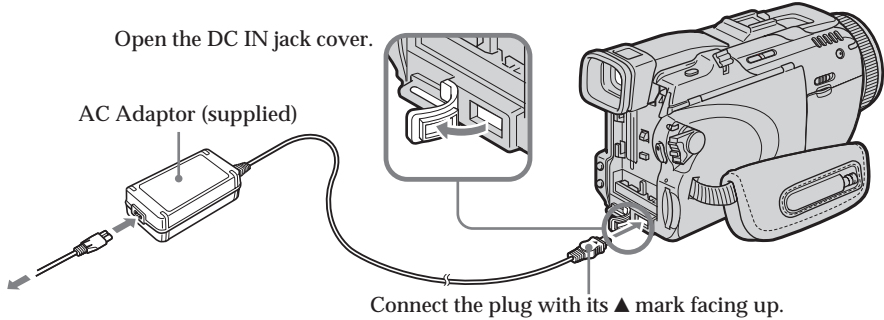

2 Inserting the cassette

- 1 Slide **OPEN**/**EJECT** in the direction of the arrow and open the lid.

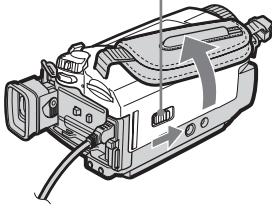

- 2 Push the center of the cassette back to insert the cassette. Insert the cassette straight as far as possible into the cassette compartment with the window facing up.

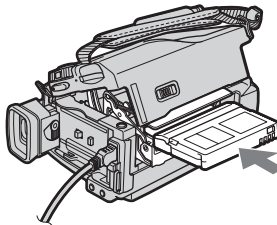

- 3 Close the cassette compartment by pressing **PUSH** on the cassette compartment. After the cassette compartment goes down completely, close the lid until it clicks.

PUSH

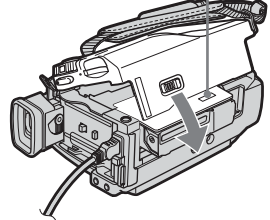

To eject the cassette

Follow the procedures above, and take out the cassette after the cassette compartment opens completely in step 3.

Note

Do not press the cassette compartment down forcibly. Doing so may cause a malfunction.

How to hold your camcorder

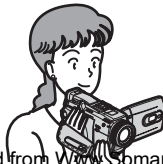

Fastening the grip belt
Fasten the grip belt firmly.

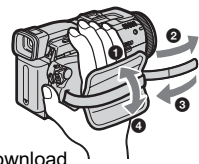

3

Recording a picture on the tape (p. 25)

1 Remove the lens cap.

3 Press OPEN to open the LCD panel. The picture appears on the screen.

2 Set the POWER switch to CAMERA while pressing the small green button.

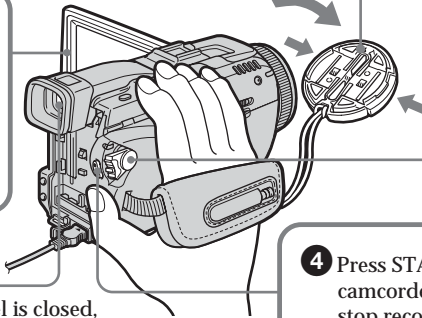
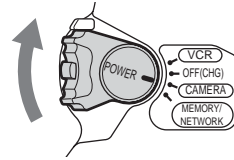

4 Press START/STOP. Your camcorder starts recording. To stop recording, press START/STOP again.



Viewfinder

When the LCD panel is closed, use the viewfinder with your eye against the eyecup. Adjust the viewfinder lens to your eyesight (p. 30).

When you purchase your camcorder, the clock setting is set to off. If you want to record the date and time for a picture, set the clock setting before recording (p. 20).

4

Monitoring the playback picture on the LCD screen (p. 37)

1 Set the POWER switch to VCR while pressing the small green button.

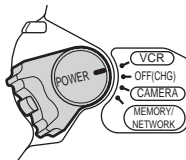

2 Press  of the touch panel to rewind the tape.



3 Press  of the touch panel to start playback.



Note

When using the touch panel, press operation buttons lightly with your finger or the supplied stylus (DCR-TRV80 only) supporting the LCD panel from the back side of it. Do not press the LCD screen with sharp objects other than the supplied stylus (DCR-TRV80 only).

Do not pick up your camcorder by holding parts as illustrated.



Viewfinder LCD panel Battery pack Flash

Quick Start Guide – Recording on “Memory Stick”

1 Connecting the power cord

Use the battery pack when using your camcorder outdoors (p. 15).

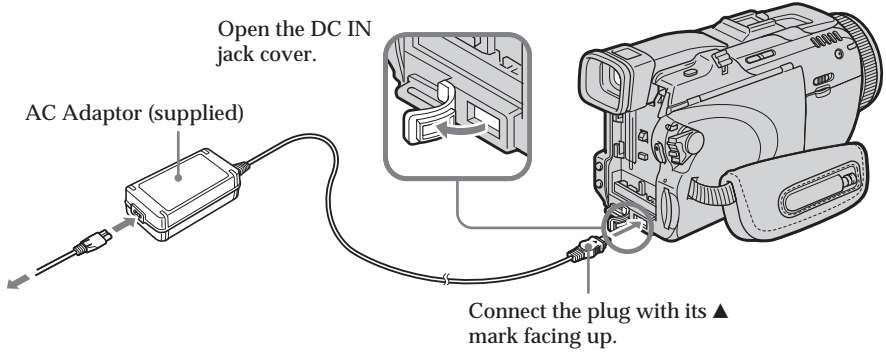

2 Inserting the “Memory Stick” (p. 102)

Insert the “Memory Stick” in the “Memory Stick” slot as far as it can go with the ► mark facing up as illustrated.

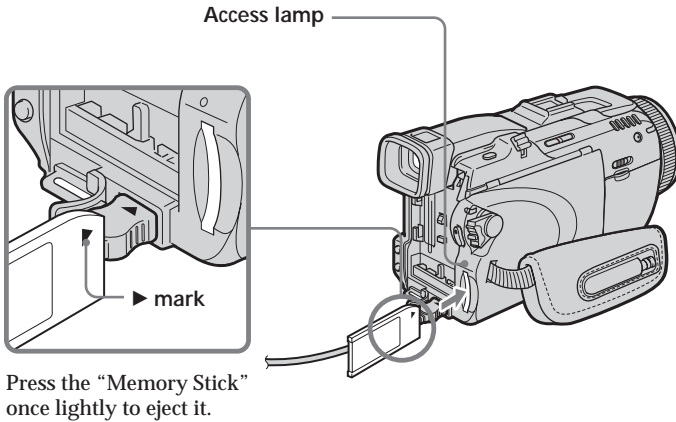

While the access lamp is lit or flashing

Do not shake or strike your camcorder because your camcorder is reading the data from the “Memory Stick” or recording the data on the “Memory Stick.” Do not turn the power off, eject the “Memory Stick” or remove the battery pack. Otherwise, image data breakdown may occur.

How to hold your camcorder

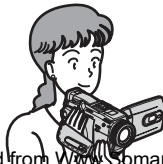

Fastening the grip belt
Fasten the grip belt firmly.

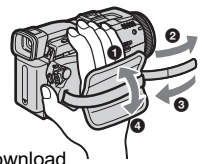

3

Recording still images on the "Memory Stick" (p. 107)

1 Remove the lens cap (p. 25).

3 Press OPEN to open the LCD panel. The picture appears on the screen.

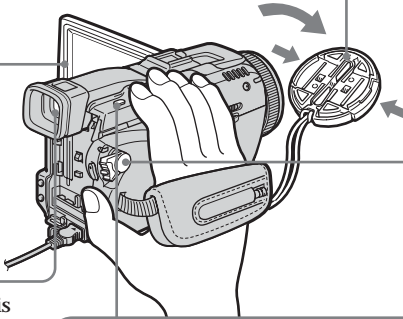

2 Set the POWER switch to MEMORY while pressing the small green button. Make sure that the LOCK switch is set to the left (unlock) position.

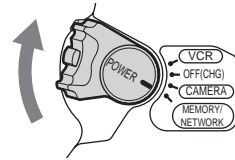

Viewfinder
When the LCD panel is closed, use the viewfinder with your eye against the eyecup. Adjust the viewfinder lens to your eyesight (p. 30).

4 Press PHOTO lightly. When the green ● mark stops flashing, then lights up, you can record a still image.



5 Press PHOTO deeply. The image when you pressed PHOTO deeply will be recorded on the "Memory Stick."



When you purchase your camcorder, the clock setting is set to off. If you want to record the date and time for a picture, set the clock setting before recording (p. 20).

4

Monitoring the playback still image on the LCD screen (p. 128)

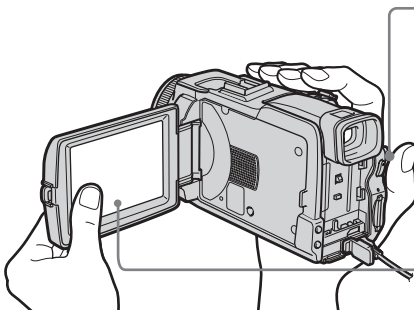

1 Set the POWER switch to MEMORY while pressing the small green button.

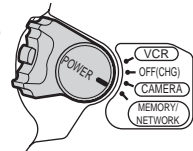

2 Press PLAY. The last recorded image is displayed.



Do not pick up your camcorder by holding parts as illustrated.



Viewfinder LCD panel Battery pack Flash

Using this manual

The instructions in this manual are for the two models listed in the table below. Before you start reading this manual and operating your camcorder, check the model number by looking at the bottom of your camcorder. The DCR-TRV80 is the model used for illustration purposes. Otherwise, the model name is indicated in the illustrations. Any differences in operation are clearly indicated in the text, for example, “DCR-TRV80 only.”

As you read through this manual, buttons and settings on your camcorder are shown in capital letters.

After “Advanced Recording Operations” section of this manual, position of the POWER switch is shown by the icons below.

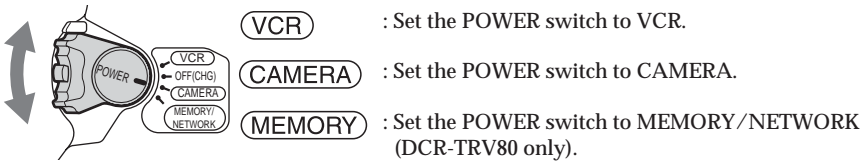

DCR-TRV80 only

The MEMORY / NETWORK position of the POWER switch is shown as MEMORY or **MEMORY** in this manual.

When you carry out an operation, you can hear a beep to indicate that the operation is being carried out.

Types of differences

DCR-	TRV75	TRV80
Mark on the POWER switch	MEMORY	MEMORY / NETWORK
Network function	—	●

- Provided
- Not provided

Note on Cassette Memory

Your camcorder is based on the DV format. You can use only mini DV cassettes with your camcorder. We recommend that you use a cassette with Cassette Memory **CM**.

Cassettes with Cassette Memory have the **CM** (Cassette Memory) mark.

Note on TV color systems

TV color systems differ depending on the country or area. To view your recordings on a TV, you need an NTSC system-based TV.

Copyright precautions

Television programs, films, video tapes, and other materials may be copyrighted. Unauthorized recording of such materials may be contrary to the copyright laws.

Note on connecting to other devices

If you connect your camcorder to a VCR or computer using the USB cable or the i.LINK cable, make sure that the jack is connected in the right direction. Pushing it forcibly may damage the jack or cause your camcorder to malfunction.

Precautions on camcorder care

Lens and LCD screen/finder (on mounted models only)

- The LCD screen and the finder are manufactured using extremely high-precision technology, so over 99.99% of the pixels are operational for effective use. However, there may be some tiny black points and/or bright points (white, red, blue or green in color) that constantly appear on the LCD screen and the finder. These points are normal in the manufacturing process and do not affect the recording in any way.
- Do not let your camcorder get wet. Keep your camcorder away from rain and sea water. Letting your camcorder get wet may cause your camcorder to malfunction. Sometimes this malfunction cannot be repaired [a].
- Never leave your camcorder exposed to temperatures above 60°C (140°F), such as in a car parked in the sun or under direct sunlight [b].
- Be careful when placing the camera near a window or outdoors. Exposing the LCD screen, the finder or the lens to direct sunlight for long periods may cause malfunctions [c].
- Do not directly shoot the sun. Doing so might cause your camcorder to malfunction. Take pictures of the sun in low light conditions such as dusk [d].

[a]



[b]

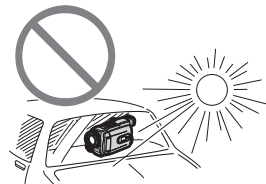

[c]

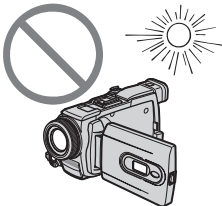

[d]

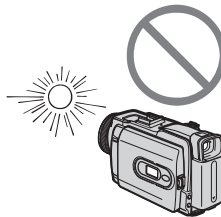

Checking supplied accessories

Make sure that the following accessories are supplied with your camcorder.

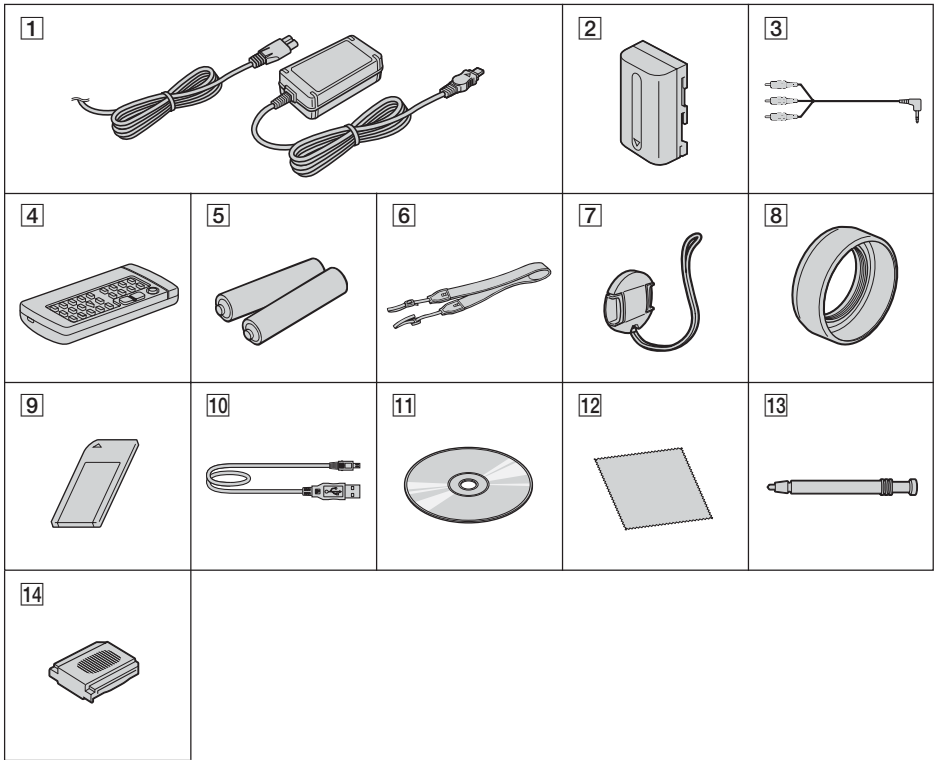

1 AC-L15A/L15B AC Adaptor (1), Power cord (1) (p. 16)

2 NP-FM50 rechargeable battery pack (1) (p. 15, 16)

3 A/V connecting cable (1) (p. 42)

4 Wireless Remote Commander (1) (p. 215)

5 Size AA (R6) battery for Remote Commander (2) (p. 215)

6 Shoulder strap (1)

7 Lens cap (1) (p. 25)

8 Lens hood (1) (p. 30)

9 "Memory Stick" (1) (p. 100)

10 USB cable (1) (p. 141)

11 CD-ROM (SPVD-010 USB Driver) (1) (p. 146)

12 Cleaning cloth (1) (p. 203)

13 Stylus (1) (DCR-TRV80 only) (p. 170)

14 Shoe cover (1) (p. 92)

Contents of the recording cannot be compensated if recording or playback is not made due to a malfunction of the camcorder, storage media, etc.

Step 1 Preparing the power source

Installing the battery pack

- (1) Lift up the viewfinder.
- (2) Slide the battery pack down until it clicks.

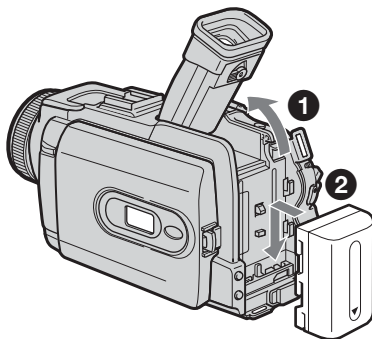

To remove the battery pack

- (1) Lift up the viewfinder.
- (2) Slide the battery pack out in the direction of the arrow while pressing BATT down.

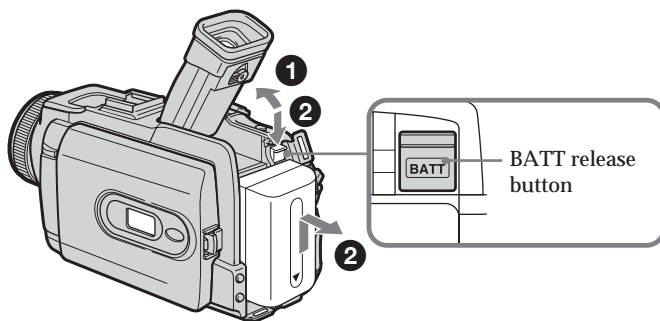

If you use the large capacity battery pack

If you install the NP-FM70/QM71/QM71D/FM91/QM91/QM91D battery pack on your camcorder, extend its viewfinder.

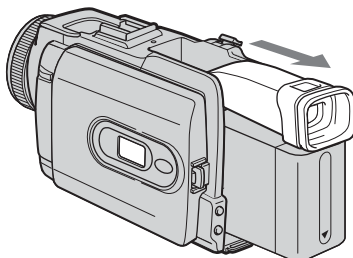

Step 1 Preparing the power source

Charging the battery pack

Use the battery pack after charging it for your camcorder.
Your camcorder operates only with the "InfoLITHIUM" battery pack (M series).
See page 197 for details of "InfoLITHIUM" battery pack.

- (1) Install the battery pack on your camcorder.
- (2) Connect the AC Adaptor supplied with your camcorder to the DC IN jack with the DC plug's ▲ mark facing up.
- (3) Connect the power cord to the AC Adaptor.
- (4) Connect the power cord to a wall outlet.
- (5) Set the POWER switch to OFF (CHG). Charging begins. The remaining battery time is indicated in minutes in the display window.

When the remaining battery time indicator changes to , normal charge is complete. To fully charge the battery pack (full charge), leave the battery pack attached for about one hour after normal charge is complete until the FULL indicator appears in the display window. Fully charging the battery pack allows you to use the battery pack longer than usual.

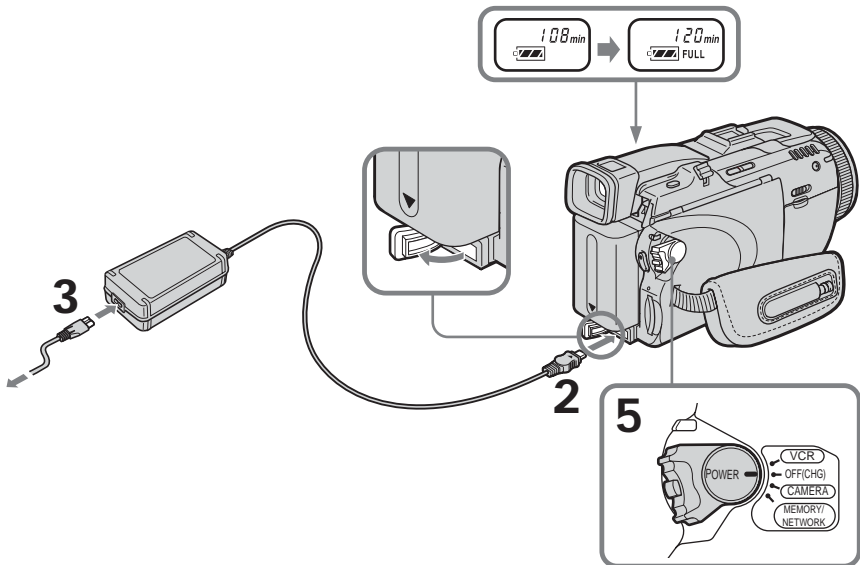

After charging the battery pack

Disconnect the AC Adaptor from the DC IN jack on your camcorder.

Step 1 Preparing the power source

Note

Prevent metallic objects from coming into contact with the metal parts of the DC plug of the AC Adaptor. This may cause a short-circuit, damaging the AC Adaptor.

When you use the AC Adaptor

Place the AC Adaptor near a wall outlet. While using the AC Adaptor if any trouble occurs with this unit, disconnect the plug from a wall outlet as soon as possible to cut off the power.

Remaining battery time indicator

The remaining battery time indicator in the display window indicates the approximate recording time when recording with the viewfinder.

Until your camcorder calculates the actual remaining battery time

"---- min" appears in the display window.

Charging time

Battery pack	Full charge (Normal charge)
NP-FM50 (supplied)	150 (90)
NP-FM70	240 (180)
NP-QM71/QM71D	260 (200)
NP-FM91/QM91/QM91D	360 (300)

Approximate minutes at 25°C (77°F) to charge an empty battery pack

The charging time may increase if the battery's temperature is extremely high or low because of the ambient temperature.

Recording time

Battery pack	Recording with the viewfinder		Recording with the LCD screen	
	Continuous	Typical*	Continuous	Typical*
NP-FM50 (supplied)	120	70	95	55
NP-FM70	250	145	200	115
NP-QM71/QM71D	290	170	230	135
NP-FM91/QM91/QM91D	445	260	350	205

Approximate minutes when you use a fully charged battery pack

* Approximate number of minutes when recording while you repeat recording start/stop, zooming and turning the power on/off. The actual battery life may be shorter.

Step 1 Preparing the power source

Playing time

Battery pack	Playing time with the LCD panel closed	Playing time on the LCD screen
NP-FM50 (supplied)	200	140
NP-FM70	415	295
NP-QM71/QM71D	485	340
NP-FM91/QM91/QM91D	725	520

Approximate minutes when you use a fully charged battery pack

Note

Approximate recording time and continuous playing time at 25°C (77°F). The battery life will be shorter if you use your camcorder in a cold environment.

Checking status of battery pack – Battery Info

- (1) Set the POWER switch to OFF (CHG).
- (2) Press OPEN to open the LCD panel.
- (3) Press DISPLAY/BATTERY INFO.

The battery charge level (the percentage of remaining battery time) and remaining battery time when using the LCD screen or viewfinder are displayed for about seven seconds.

If you keep pressing DISPLAY/BATTERY INFO, the Battery Info is displayed for up to about 20 seconds.

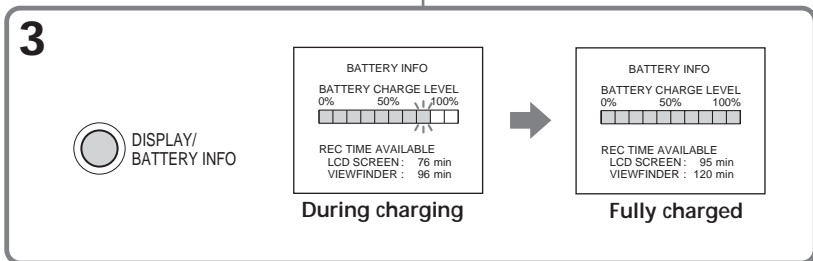
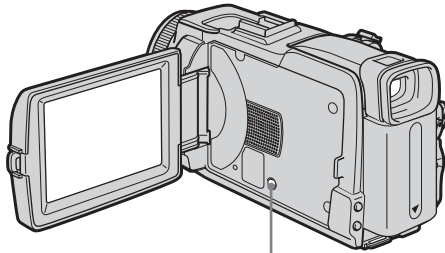

Step 1 Preparing the power source

Note

The BATTERY INFO indicator is not displayed in the following cases:

- The battery pack is not properly installed.
- Something is wrong with the battery pack.
- The battery pack is fully discharged.

Battery Info

The number displayed as Battery Info is the approximate recording time.

While the remaining battery time is being calculated

“CALCULATING BATTERY INFO...” is displayed.

Connecting to a wall outlet

Connect in the same way as when charging the battery pack (p. 16).

PRECAUTION

The set is not disconnected from the AC power source (house current) as long as it is connected to the wall outlet, even if the set itself has been turned off.

Notes

- The AC Adaptor can supply power from a wall outlet even if the battery pack is attached to your camcorder.
- The DC IN jack has “source priority.” This means that the battery pack cannot supply any power if the power cord is connected to the DC IN jack, even when the power cord is not plugged into a wall outlet.

Step 2 Setting the date and time

Set the date and time when you use your camcorder for the first time. The “CLOCK SET” indicator will appear each time you set the POWER switch to CAMERA or MEMORY unless you set the date and time settings.

If you do not set the date and time, “-----” and “-:--:--” are recorded on the tape or the “Memory Stick” as the data code.

If you do not use your camcorder for **about three months**, the date and time settings may be released (bars may appear) because the built-in rechargeable battery installed in your camcorder will have been discharged (p. 204). In this case, charge the built-in rechargeable battery, then set your area, the daylight saving time (DST*), the year, the month, the day, the hour and the minute.

* Instead of DST, SUMMERTIME is displayed on the screen for some models.

- (1) Set the POWER switch to CAMERA or MEMORY.
- (2) Press FN (Function) to display PAGE1 (p. 23).
- (3) Press MENU to display the menu.
- (4) Press ↓/↑ to select , then press EXEC.
- (5) Press ↓/↑ to select CLOCK SET, then press EXEC.
- (6) Press ↓/↑ to select your area, then press EXEC.
- (7) Press ↓/↑ to select whether your area is in the daylight saving time or not, then press EXEC.
- (8) Press ↓/↑ to select a desired year, then press EXEC.
- (9) Set the month, day and hour with the same procedure as step 8.
- (10) Press ↓/↑ to set the minute, then press EXEC by the time signal. The clock starts to move.

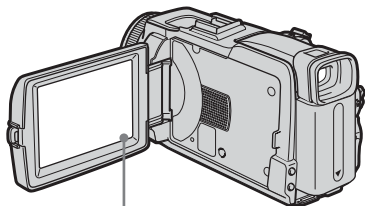

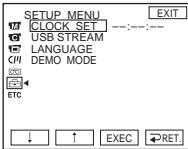
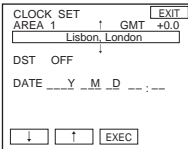
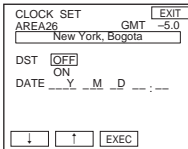
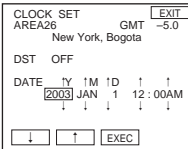
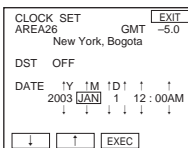
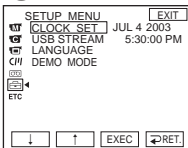
<p>4</p> 	<p>5</p> 
<p>6</p> 	<p>7</p> 
<p>8</p> 	<p>10</p> 

Step 2 Setting the date and time

To return to FN (Function)

Press EXIT.

When using your camcorder abroad

Set the clock to the local time (p. 22).

If you use your camcorder in an area where daylight saving time is used
Set DST SET in  to ON in the menu settings.

Note on the time indicator

The internal clock of your camcorder operates on a 12-hour cycle.

- 12:00 AM stands for midnight.
- 12:00 PM stands for noon.

Step 2 Setting the date and time

Simple setting of clock by time difference

You can easily set the clock to the local time by setting a time difference. Select AREA SET and DST SET* in **ETC** in the menu settings.

See page 181 for details.

* Instead of DST, SUMMERTIME is displayed on the screen for some models.

World time difference

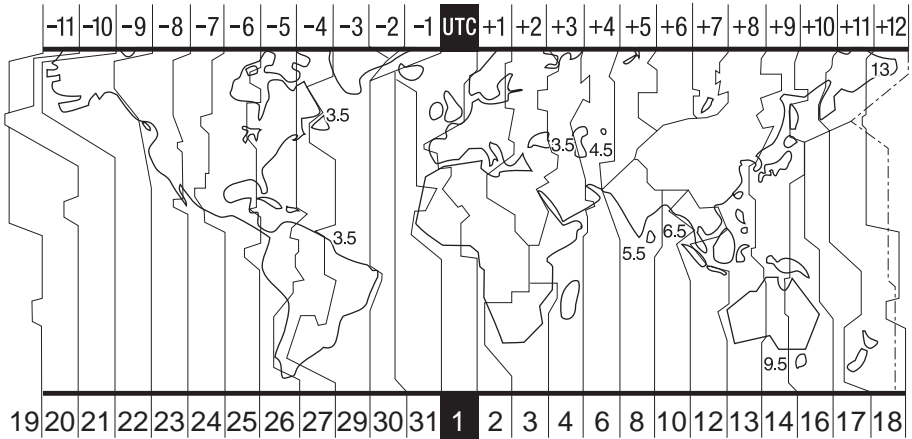

Area code	Time-zone differences	Area setting
1	GMT	Lisbon, London
2	+01:00	Berlin, Paris
3	+02:00	Helsinki, Cairo
4	+03:00	Moscow, Nairobi
5	+03:30	Tehran
6	+04:00	Abu Dhabi, Baku
7	+04:30	Kabul
8	+05:00	Karachi, Islamabad
9	+05:30	Calcutta, New Delhi
10	+06:00	Almaty, Dhaka
11	+06:30	Rangoon
12	+07:00	Bangkok, Jakarta
13	+08:00	HongKong, Singapore
14	+09:00	Seoul, Tokyo
15	+09:30	Adelaide, Darwin
16	+10:00	Melbourne, Sydney

Area code	Time-zone differences	Area setting
17	+11:00	Solomon Is
18	+12:00	Fiji, Wellington
19	-12:00	Eniwetok, Kwajalein
20	-11:00	Midway Is., Samoa
21	-10:00	Hawaii
22	-09:00	Alaska
23	-08:00	LosAngeles, Tijuana
24	-07:00	Denver, Arizona
25	-06:00	Chicago, MexicoCity
26	-05:00	New York, Bogota
27	-04:00	Santiago
28	-03:30	St. John's
29	-03:00	Brasilia, Montevideo
30	-02:00	Fernando de Noronha
31	-01:00	Azores

Step 3 Using the touch panel

Your camcorder has operation buttons on the LCD screen.

Touch the LCD screen directly with your finger or the supplied stylus (DCR-TRV80 only) to operate each function.

- (1) Press OPEN to open the LCD panel.
- (2) Set the POWER switch to CAMERA to record, VCR to play back or MEMORY to use the "Memory Stick."
- (3) Press FN. Operation buttons on PAGE1 are displayed on the LCD screen.
- (4) Press PAGE2/PAGE3 to display PAGE2/PAGE3. Operation buttons on PAGE2/PAGE3 are displayed on the LCD screen.
- (5) Press a desired operation item. See relevant pages of this manual for each function.

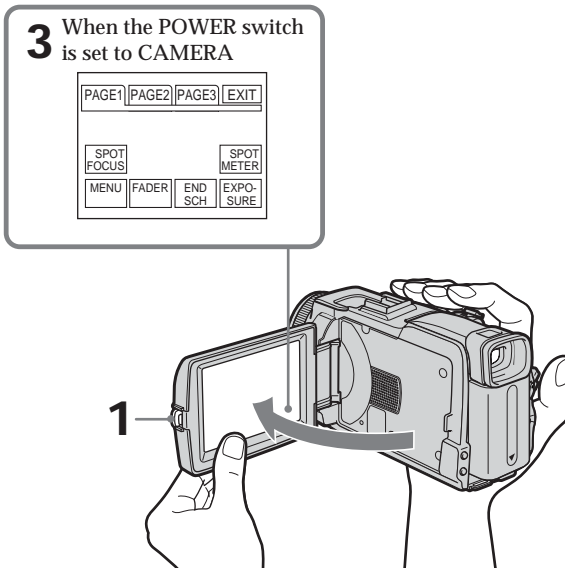

To return to FN

Press EXIT.

To execute settings

Press \rightarrow OK. The display returns to PAGE1/PAGE2/PAGE3.

To cancel settings

Press \rightarrow OFF. The display returns to PAGE1/PAGE2/PAGE3.

To make screen indicators disappear

Press DISPLAY/BATTERY INFO.

Step 3 Using the touch panel

Operation buttons on each display

When the POWER switch is set to CAMERA

PAGE1	SPOT FOCUS, MENU, FADER, END SCH, SPOT METER, EXPOSURE
PAGE2	SELFTIMER, DIG EFFT, LCD BRT, VOL, MEM MIX
PAGE3	SUPER NS, COLOR SLW S, PRGRE REC, RMT CAM*

When the POWER switch is set to VCR

PAGE1	MENU, LCD BRT, VOL, END SCH
PAGE2	PB ZOOM, DIG EFFT, DATA CODE
PAGE3	V SPD PLAY, A DUB CTRL, REC CTRL

When the POWER switch is set to MEMORY

During memory camera

PAGE1	SPOT FOCUS, MENU, PLAY, PB FOLDR, SPOT METER, EXPOSURE
PAGE2	SELFTIMER, PLAY, MEM MIX
PAGE3	LCD BRT, PLAY, IMAGE TRANS*, VOL

During memory playback

PAGE1	MENU, CAM, PB FOLDR, DEL
PAGE2	PB ZOOM, CAM, RESIZE, DATA CODE
PAGE3	LCD BRT, CAM, IMAGE TRANS*, VOL

* DCR-TRV80 only

Notes

- When using the touch panel, press operation buttons lightly with your finger or the supplied stylus (DCR-TRV80 only) supporting the LCD panel from the back side of it.
- Do not press the LCD screen with sharp objects other than the supplied stylus. (DCR-TRV80 only)
- Do not press the LCD screen too hard.
- Do not touch the LCD screen with wet hands.
- If FN is not on the LCD screen, touch the LCD screen lightly to make it appear. You can control the display with DISPLAY/BATTERY INFO on your camcorder.

When executing each item

The green bar appears above the item.

If the items are not available

The color of the items changes to gray.

Touch panel

You can operate with the touch panel using the viewfinder (p. 67).

Recording a picture

See relevant “Step 1” and “Step 2.”

- (1) Remove the lens cap and pull the lens cap string to fix it.
- (2) Prepare the power source (p. 15 to 19) and insert the cassette (p. 8).
- (3) Set the POWER switch to CAMERA while pressing the small green button. This sets your camcorder to standby.
- (4) Press OPEN to open the LCD panel. The picture appears on the screen.
- (5) Press START/STOP. Your camcorder starts recording. The REC indicator appears. The camera recording lamp located on the front of your camcorder lights up. To stop recording, press START/STOP again.

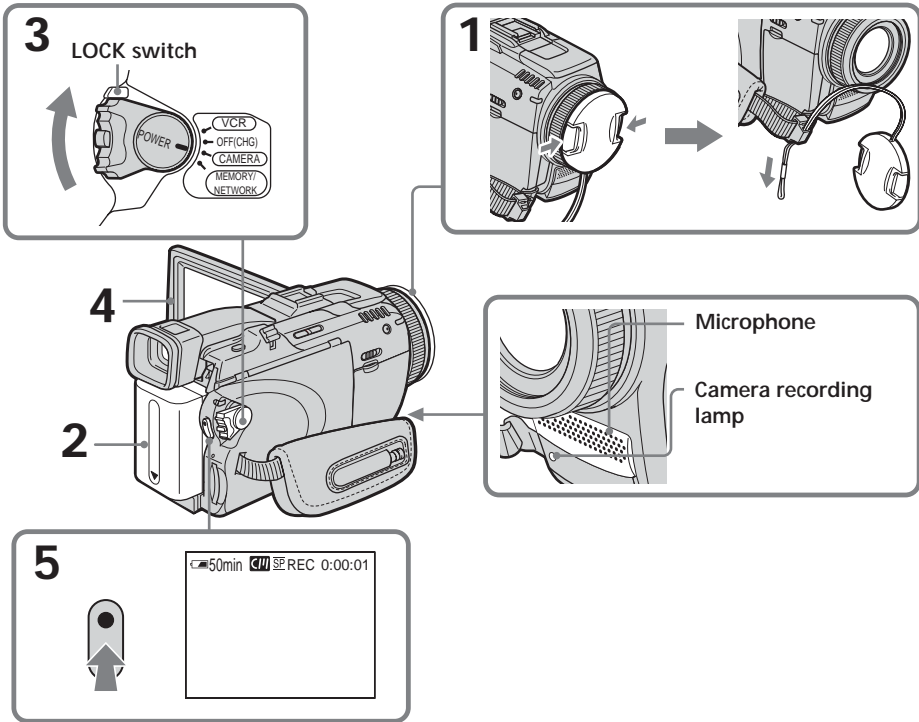

Recording a picture

Note on recording

Your camcorder records and plays back in the SP (standard play) mode and in the LP (long play) mode. Select SP or LP in the menu settings (p. 179). In the LP mode, you can record 1.5 times as long as in the SP mode.

When you record the tape in the LP mode on your camcorder, we recommend playing back the tape on your camcorder.

To enable smooth transition

Transition between the last scene you recorded and the next scene is smooth as long as you do not eject the cassette even if you turn off your camcorder.

However, check the following:

- Do not mix recordings in the SP and LP modes on one tape.
- When you change the battery pack, set the POWER switch to OFF (CHG).

Self-timer recording

You can record images on the tape with the self-timer. See page 46 for details.

Note

The recording data (date/time or various settings when recorded) do not appear during recording. However, they are recorded automatically on the tape. To display the recording data, press DATA CODE during playback. You can also use the Remote Commander for this operation (p. 38).

If you leave your camcorder during standby for five minutes while the cassette is inserted

Your camcorder automatically turns off. This is to save battery power and to prevent battery pack and tape wear. To return to standby, set the POWER switch to OFF (CHG) and then back to CAMERA. However, your camcorder does not turn off automatically while the cassette is not inserted.

When you record in the SP and LP modes on one tape or you record in the LP mode

- The transition between scenes may not be smooth.
- The playback picture may be distorted or the time code may not be written properly between scenes.

Note on the LOCK switch

When you slide the LOCK switch to the right, the POWER switch can no longer be set to MEMORY accidentally. The LOCK switch is set to the left as the default setting.

Indicators displayed during recording

Indicators are not recorded on the tape.

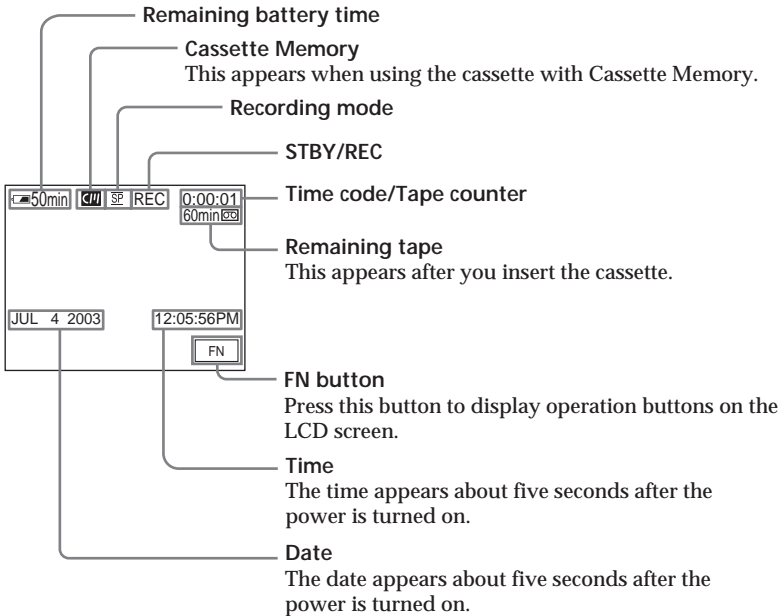

Remaining battery time indicator during recording

The remaining battery time indicator roughly indicates the continuous recording time. The indicator may not be correct, depending on the conditions in which you are recording. When you close the LCD panel and open it again, it takes about one minute for the correct remaining battery time in minutes to be displayed.

Time code

The time code indicates the recording or playback time, "0:00:00" (hours : minutes : seconds) in CAMERA and "0:00:00:00" (hours : minutes : seconds : frames) in VCR. You cannot rewrite only the time code.

Recording data

The recording data (date/time or various settings when recorded) are not displayed during recording. However, they are recorded automatically on the tape. To display the recording data, press DATA CODE during playback. You can also use the Remote Commander for this operation (p. 38).

Recording a picture

After recording

- (1) Set the POWER switch to OFF (CHG).
- (2) Close the LCD panel.
- (3) Eject the cassette.
- (4) Remove the power source.

Adjusting the LCD screen

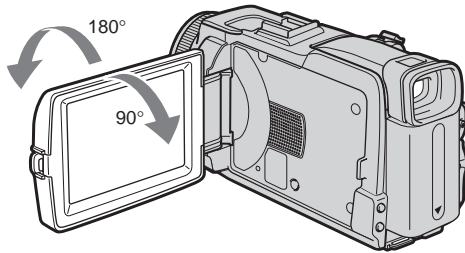

When you adjust the LCD panel, make sure if the LCD panel is opened up to 90 degrees.

Note

When using the LCD screen except in the mirror mode, the viewfinder automatically turns off.

When monitoring on the LCD screen

You can turn the LCD panel over and move it back to your camcorder body with the LCD screen facing out.

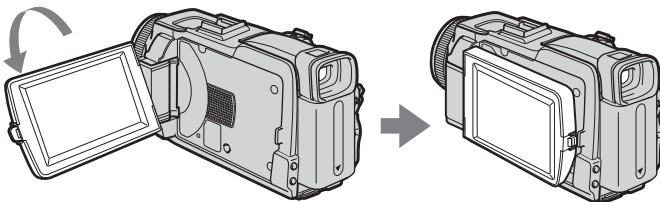

Recording a picture

Shooting with the mirror mode

This feature allows the camera subject to view him- or herself on the LCD screen. The subject uses this feature to check his or her own image on the LCD screen while you look at the subject in the viewfinder.

- (1) Set the POWER switch to CAMERA or MEMORY.
- (2) Rotate the LCD panel 180 degrees.

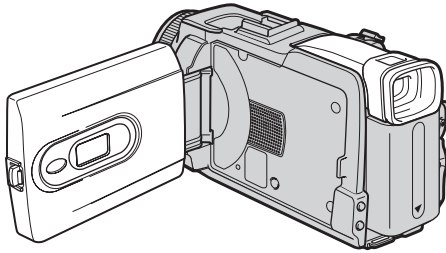

Picture in the mirror mode

The picture on the LCD screen is a mirror-image. However, the picture will be normal when recorded.

Adjusting the brightness of the LCD screen

- (1) When the POWER switch is set to CAMERA, press FN and select PAGE2. When the POWER switch is set to VCR, press FN to display PAGE1. When the POWER switch is set to MEMORY, press FN and select PAGE3.
- (2) Press LCD BRT. The screen to adjust the brightness of the LCD screen appears.
- (3) Adjust the brightness of the LCD screen using - (to dim)/+ (to brighten).
- (4) Press \rightarrow OK to return to PAGE1/PAGE2/PAGE3 in step 1.

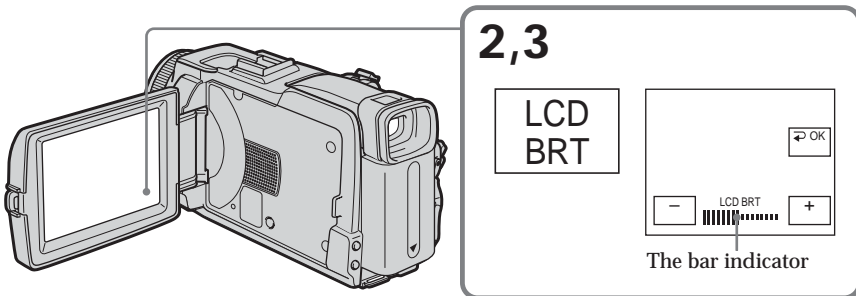

To return to FN

Press EXIT.

LCD screen backlight

You can change the brightness of the backlight. Select LCD B.L. in  in the menu settings when using the battery pack (p. 175).

Even if you adjust LCD BRT or LCD B.L.

The recording will continue normally.

Recording a picture

Adjusting the viewfinder

If you record pictures with the LCD panel closed, check the picture with the viewfinder. Adjust the viewfinder lens to your eyesight so that the images in the viewfinder come into sharp focus.

Lift up the viewfinder and move the viewfinder lens adjustment lever.

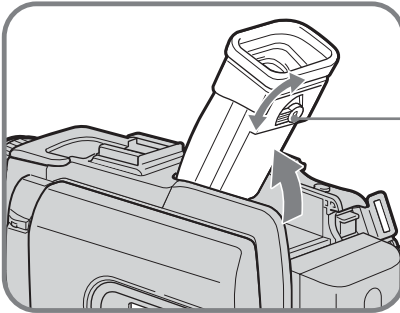

The viewfinder lens adjustment lever

Viewfinder backlight

You can change the brightness of the backlight. Select VF B.L. in  in the menu settings when using the battery pack (p. 175).

Even if you adjust VF B.L.

The recorded picture will not be affected.

Attaching the supplied lens hood

To record fine pictures under strong light, we recommend attaching the lens hood. Also the lens cap can be attached even with the lens hood on.

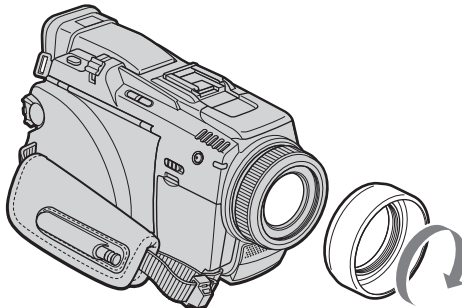

Note

You cannot attach filters or other objects onto the lens hood.

If you forcibly attach these objects onto the lens hood, you will no longer be able to remove filters or other objects from the hood.

When you use the filter (optional)

The shadow of the lens hood may appear in the corners of the screen.

Recording a picture

Using the zoom feature

Move the power zoom lever a little for a slower zoom. Move it further for a faster zoom. Using the zoom sparingly results in better-looking recordings.

W : Wide-angle (subject appears farther away)

T : Telephoto (subject appears closer)

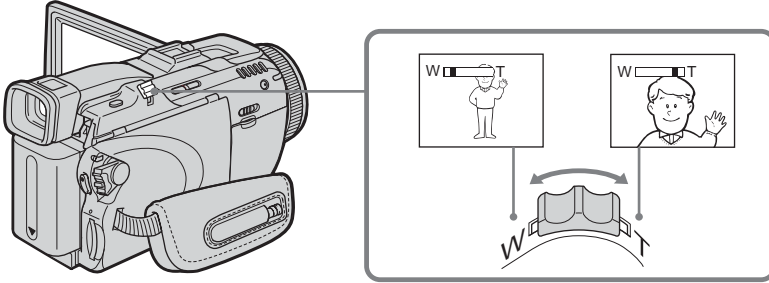

To use zoom greater than 10×

Zoom greater than 10× is performed digitally. Digital zoom can be set to 20× or 120×.

To activate digital zoom, select the digital zoom power in D ZOOM in  in the menu settings (p. 174). The digital zoom is set to OFF as a default setting.

The right side of the bar shows the digital zooming zone.

The digital zooming zone appears when you select the digital zoom power in the menu settings.

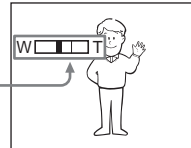

When you shoot close to a subject

If you cannot get a sharp focus, move the power zoom lever to the “W” side until the focus is sharp. You can shoot a subject that is at least about 80 cm (about 2 5/8 feet) away from the lens surface in the telephoto position, or about 1 cm (about 1/2 inch) away in the wide-angle position.

Note on digital zoom

The picture quality deteriorates as you move the power zoom lever towards the “T” side.

When the POWER switch is set to MEMORY

You cannot use the digital zoom.

Shooting backlit subjects – Back light function

When you shoot a subject with the light source behind the subject or a subject with a light background, use the back light function.

- (1) Set the POWER switch to CAMERA or MEMORY.
- (2) Press BACK LIGHT.

The  indicator appears on the screen.

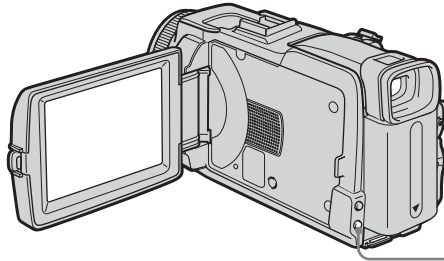

BACK LIGHT

To cancel the back light function

Press BACK LIGHT again.

When shooting backlit subjects

If you press MANUAL of EXPOSURE (p. 59) or SPOT METER (p. 60), the back light function will be canceled.

Shooting in the dark – NightShot/Super NightShot/Color Slow Shutter

Using NightShot

NightShot enables you to shoot a subject in the night or in a dark place.

When recording with NightShot, the picture may be recorded in incorrect or unnatural colors.

- (1) Set the POWER switch to CAMERA or MEMORY.
- (2) Slide NIGHTSHOT to ON.

The  and "NIGHTSHOT" indicators flash on the screen.

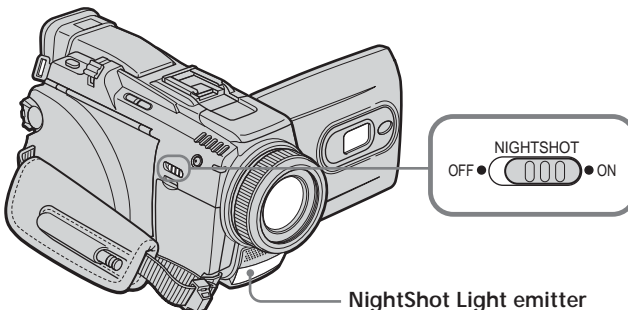



NightShot Light emitter

To cancel NightShot
Slide NIGHTSHOT to OFF.

Using Super NightShot

Super NightShot makes subjects more than 16 times brighter than those recorded in NightShot.

- (1) Set the POWER switch to CAMERA.
- (2) Slide NIGHTSHOT to ON.
The  and "NIGHTSHOT" indicators flash on the screen.
- (3) Press FN and select PAGE3.
- (4) Press SUPER NS.
The  indicator lights up on the screen.
- (5) Press EXIT to return to FN.

To cancel Super NightShot

Press SUPER NS again to return to NightShot.

Using the NightShot Light

The picture will be clearer with the NightShot Light on. To enable the NightShot Light, set N.S. LIGHT in  to ON in the menu settings. (The default setting is ON.)

Using Color Slow Shutter

Color Slow Shutter enables you to record color images in a dim place.



- (1) Set the POWER switch to CAMERA.
- (2) Slide NIGHTSHOT to OFF.
- (3) Press FN and select PAGE3.
- (4) Press COLOR SLW S.
The  indicator lights up on the screen.
- (5) Press EXIT to return to FN.

To cancel Color Slow Shutter

Press COLOR SLW S again to make the  indicator disappear.

Notes

- Do not use NightShot in bright places (e.g. the outdoors in the daytime). This may cause a malfunction.
- If focusing is difficult during recording with NightShot, focus manually.

While using NightShot, you cannot use the following functions:

- White balance
- PROGRAM AE
- Manual exposure
- Flexible Spot Meter
- HOLOGRAM AF

While using Super NightShot or Color Slow Shutter

The shutter speed is automatically adjusted depending on the brightness. At this time, the motion of the picture may slow down.

Download from [Www.Somanuals.com](http://www.Somanuals.com). All Manuals Search And Download.

Recording a picture

While using Super NightShot, you cannot use the following functions:

- White balance
- Fader
- Digital effect
- PROGRAM AE
- Manual exposure
- Flexible Spot Meter
- Progressive Recording Mode
- Recording with the flash

When the POWER switch is set to MEMORY

You cannot use the following functions:

- Super NightShot
- Color Slow Shutter

NightShot Light

The NightShot Light rays are infrared and so are invisible. The maximum shooting distance using the NightShot Light is about 3 m (10 feet).

While using Color Slow Shutter, you cannot use the following functions:

- Fader
- Digital effect
- PROGRAM AE
- Manual exposure
- Flexible Spot Meter
- Progressive Recording Mode
- Recording with the flash

In total darkness

Color Slow Shutter may not work normally.

Checking recordings

- End search/Edit search/Rec Review

You can use these buttons to check the recorded picture or shoot so that the transition between the last recorded scene and the next scene you record is smooth.

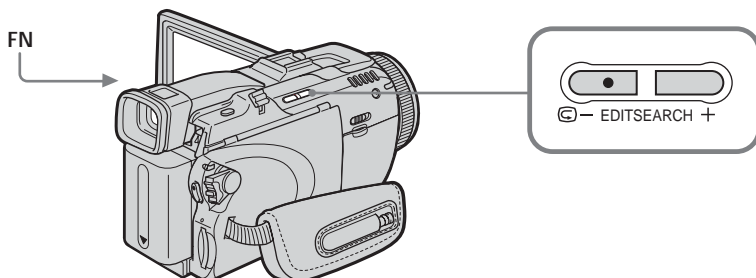

End search

You can go to the end of the recorded section after you record.

- (1) Set the POWER switch to CAMERA.
- (2) Press FN to display PAGE1.
- (3) Press END SCH.

The last five seconds of the recorded section are played back and your camcorder returns to standby.

To return to FN

Press EXIT.

To cancel end search

Press END SCH again.

End search

When you use the cassette without Cassette Memory, end search does not work once you eject the cassette after you have recorded on the tape. If you use a cassette with Cassette Memory, end search works even once you eject the cassette.

If the tape has a blank portion between recorded portions

End search may not work correctly.

Checking recordings – End search/Edit search/Rec Review

Edit search

You can search for the next recording start point. You cannot monitor the sound.

- (1) Set the POWER switch to CAMERA.
- (2) Hold down the EDITSEARCH. The recorded portion is played back. Release EDITSEARCH to stop playback. If you press START/STOP, recording begins from the point you released EDITSEARCH.

⏮ -: To go backwards

+ : To go forwards



Rec Review

You can check the last recorded section.

- (1) Set the POWER switch to CAMERA.
- (2) Press the ⏮ – side of EDITSEARCH momentarily. The section you have stopped most recently will be played back for a few seconds, and then your camcorder will return to standby.

Playing back tape

You can monitor the recorded tape on the LCD screen. If you close the LCD panel, you can monitor the playback picture in the viewfinder. You can also control playback using the Remote Commander supplied with your camcorder.

- (1) Press the POWER switch to VCR while pressing the small green button.
- (2) Press OPEN to open the LCD panel.
- (3) Press  to rewind the tape.
- (4) Press  to start playback.
- (5) Adjust the volume following the steps below.
 - ① Press FN to display PAGE1.
 - ② Press VOL. The screen to adjust volume appears.
 - ③ Press - (to turn down the volume)/+ (to turn up the volume).
 - ④ Press  OK to return to PAGE1.

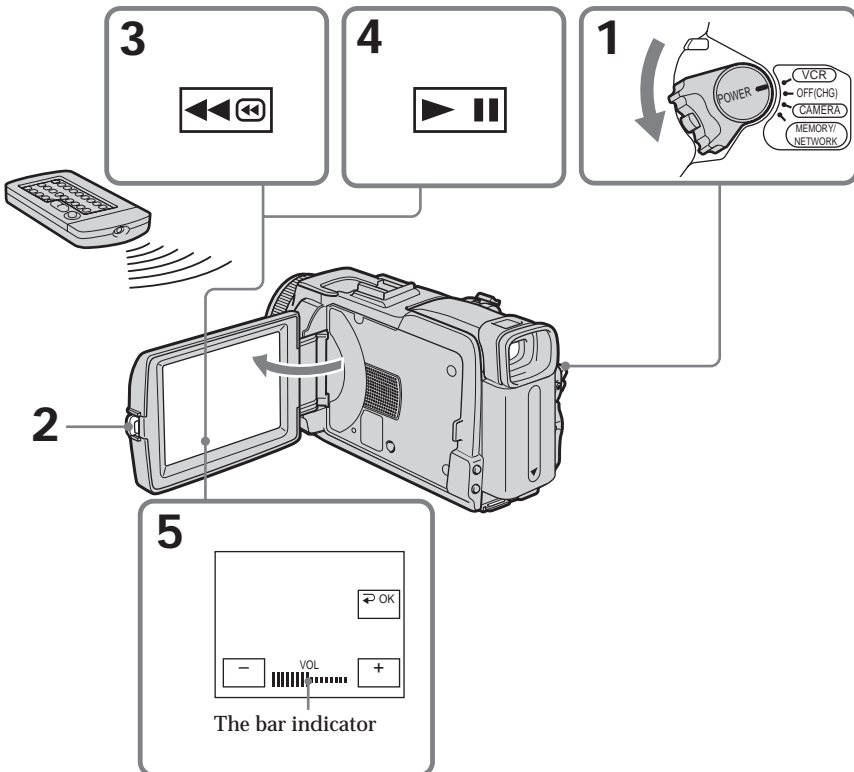

Playing back tape

To return to FN

Press EXIT.

To cancel playback

Press .

To rewind the tape

Press  during playback stop.

To fastforward the tape

Press  during playback stop.

To view a still image (playback pause)

Press  during playback. To resume playback, press  again.

If you leave the power on for a long time

Your camcorder gets warm. This is not a malfunction.

To display the screen indicators - Display function

Press DISPLAY/BATTERY INFO on your camcorder or DISPLAY on the Remote Commander supplied with your camcorder.

The indicators disappear from the screen.

To make the indicators appear, press DISPLAY/BATTERY INFO or DISPLAY on the Remote Commander again.

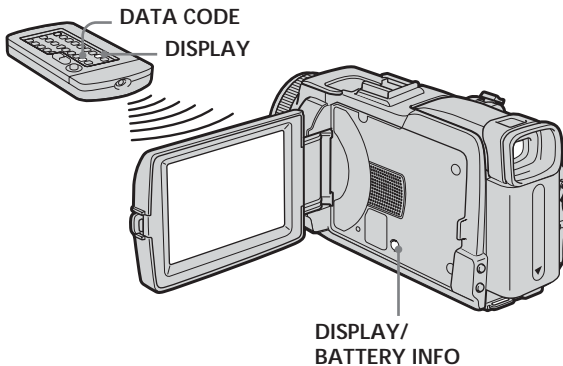

Note

Even if you press DISPLAY on the Remote Commander with the POWER switch set to OFF(CHG), the BATTERY INFO indicator is not displayed.

Playing back tape

About date/time and various settings

Your camcorder automatically records not only images on the tape but also the recording data (date/time or various settings when recorded) (**Data code**). Follow the steps below to display the data code using the touch panel or the Remote Commander.

Using the touch panel

- (1) Set the POWER switch to VCR, then play back the tape.
- (2) During playback, press FN and select PAGE2.
- (3) Press DATA CODE.
- (4) Select CAM DATA or DATE DATA, then press \Rightarrow OK.
- (5) Press EXIT.

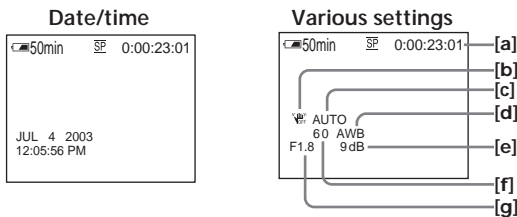

- [a] Tape counter
- [b] SteadyShot off
- [c] Exposure
- [d] White balance
- [e] Gain
- [f] Shutter speed
- [g] Aperture value

Using the Remote Commander

Press DATA CODE on the Remote Commander during playback.

The display changes as follows:

date/time \rightarrow various settings (SteadyShot off, exposure, white balance, gain, shutter speed, aperture value) \rightarrow (no indicator)

Various settings

Various settings shows your camcorder's recording information at the time of recording. During tape recording standby, the various settings will not be displayed.

When you use data code, bars (-- --) appear if:

- A blank portion of the tape is being played back.
- The tape is unreadable due to tape damage or noise.
- The tape was recorded by a camcorder without the date and time set.

Data code

When you connect your camcorder to a TV, the data code also appears on the TV screen.

Various playback modes

To operate video control buttons, set the POWER switch to VCR.

Using the touch panel



(1) Press FN and select PAGE3.

(2) Press V SPD PLAY to display video control buttons.



To change the playback direction

Press  during playback to reverse the playback direction.¹⁾



To locate a scene while monitoring the picture (picture search)

Keep pressing  or  during playback. To resume normal playback, release the button.



To monitor the high-speed picture while fastforwarding or rewinding the tape (skip scan)

Keep pressing  while fastforwarding or  while rewinding the tape. To resume fastforwarding or rewinding, release the button.

To view the picture at slow speed (slow playback)

Press  during playback. For slow playback in the reverse direction, press , then press .

To view the picture at double speed

Press  during playback. For double speed playback in the reverse direction, press , then press .

To view the picture frame-by-frame

Press  during playback pause.²⁾

For frame-by-frame playback in the reverse direction, press .

To search the last scene recorded (END SEARCH)

Press END SCH on PAGE1 during stop. The last five seconds of the recorded section are played back then your camcorder stops.

¹⁾ Press  to pause playback. Press  to resume normal playback.









²⁾ Press  to resume normal playback.

Playing back tape









Video control buttons

Marks on your camcorder are different from those on the Remote Commander supplied with your camcorder.

On your camcorder:

-  To play back or pause the tape
-  To stop the tape
-  To rewind the tape
-  To fastforward the tape
-  To play back the tape slowly
-  To forward one frame at a time
-  To rewind one frame at a time
-  To play back the tape at double speed

On the Remote Commander:

-  To play back the tape
-  To pause the tape
-  To stop the tape
-  To rewind the tape
-  To fastforward the tape
-  To play back the tape slowly
-  To forward one frame at a time
-  To rewind one frame at a time
-  To play back the tape at double speed

In the various playback modes

- Sound is muted.
- The previous picture may remain as a mosaic image during playback.

When playback pause lasts for five minutes

Your camcorder automatically enters the stop mode. To resume playback, press



When you play back the tape in reverse

Horizontal noise may appear at the center, or the top and bottom of the screen. This is not a malfunction.

Slow playback

Slow playback can be performed smoothly on your camcorder. However, this function does not work for an output signal from the  DV Interface.

Viewing a recording on TV

Connect your camcorder to a TV with the A/V connecting cable supplied with your camcorder to watch the playback pictures on the TV screen. You can operate the playback control buttons in the same way as when you view playback pictures on the LCD screen.

When viewing the playback picture on the TV screen, we recommend that you power your camcorder from a wall outlet using the AC Adaptor. Refer to the operating instructions of your TV.

Open the jack cover. Connect your camcorder to the TV with the A/V connecting cable. Then set the TV/VCR selector on the TV to VCR to be able to view images from your camcorder.

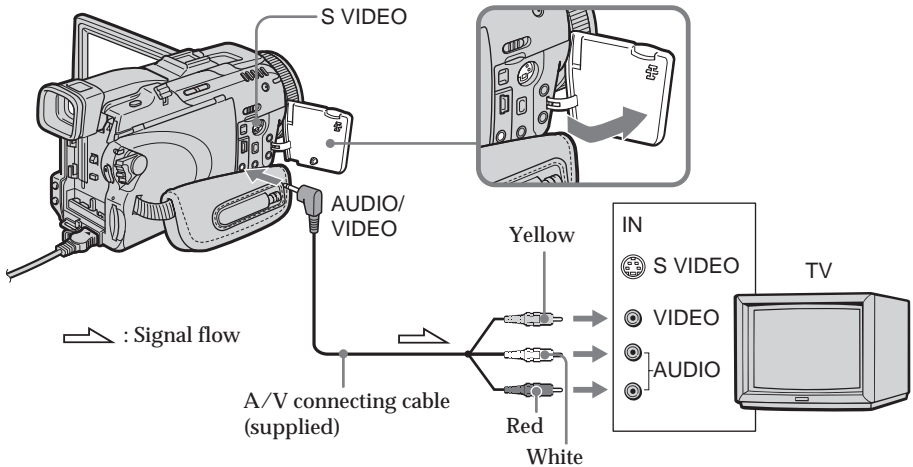

If your TV is already connected to the VCR

Connect your camcorder to the LINE IN input on the VCR with the A/V connecting cable supplied with your camcorder. Set the input selector on the VCR to LINE.

If your TV or VCR is a monaural type

Connect the yellow plug of the A/V connecting cable to the video input jack and the white or the red plug to the audio input jack on the VCR or the TV. If you connect the white plug, the sound is L (left) signal. If you connect the red plug, the sound is R (right) signal.

Viewing a recording on TV

If the device you want to connect to has an S video jack

- Pictures can be reproduced more faithfully by using an S video cable (optional). With this connection, you do not need to connect the yellow (video) plug of the A/V connecting cable.

Connect the S video cable (optional) to the S video jacks on both your camcorder and the device you want to connect to.

This connection produces higher quality DV format pictures.

- There is no sound output when connecting only with an S video cable (optional).

To display the screen indicators on TV

Set DISPLAY to V-OUT/LCD in  in the menu settings (p. 181). To make the screen indicators disappear, press DISPLAY/BATTERY INFO on your camcorder.

Recording still images on “Memory Stick” during tape recording standby or tape recording

During tape recording standby

The POWER switch should be set to **CAMERA**.

- (1) Keep pressing PHOTO lightly until a still image appears. The CAPTURE indicator appears. Recording does not start yet. To change the still image, release PHOTO, select a still image again, then press and hold PHOTO lightly.
- (2) Press PHOTO deeply.
Recording is complete when the bar scroll indicator disappears.
The image displayed on the screen when you pressed PHOTO deeply will be recorded on the “Memory Stick.”

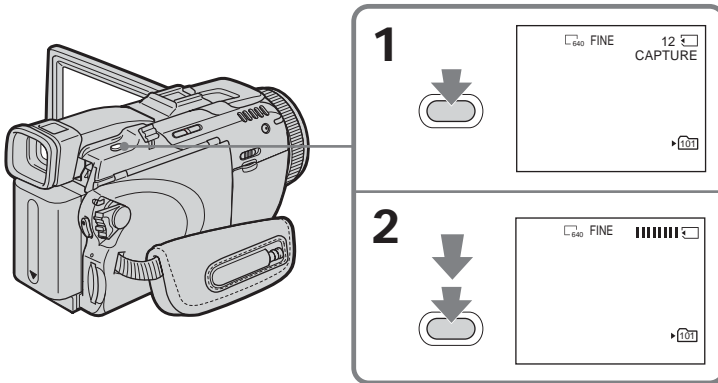

During tape recording

The POWER switch should be set to **CAMERA**.

Press PHOTO deeply.

The image displayed on the screen when you pressed PHOTO deeply will be recorded on the “Memory Stick.”

Recording on the “Memory Stick” is complete when the bar scroll indicator disappears.

Recording still images on “Memory Stick” during tape recording standby or tape recording

Note

You cannot record still images on the “Memory Stick” during following operations (The  indicator flashes):

- End search
- Wide mode
- During fading in with BOUNCE
- Progressive Recording Mode
- MEMORY MIX

“Memory Stick”

See page 100 for details.

Still images

- The image size will be 640 × 480.
- If the POWER switch is set to CAMERA, image quality cannot be changed. Images will be recorded with image quality as set when the POWER switch is set to MEMORY.
- When recording with higher image quality, use of Memory Photo recording is recommended (p. 107).

During and after recording still images on the “Memory Stick”

Your camcorder continues recording on the tape.

When you press PHOTO on the Remote Commander

Your camcorder immediately records the image that is on the screen when you press the button.

To record still images on the “Memory Stick” during tape recording

You cannot check an image on the screen by pressing PHOTO lightly. The image when you press PHOTO deeply will be recorded on the “Memory Stick.”

Title

You cannot record the titles.

Self-timer recording

During recording standby, you can record still images on the “Memory Stick” with the self-timer. See page 46 for details.

Recording with the flash

During recording standby, you can record still images on the “Memory Stick” with the flash. See page 111 for details.

Self-timer recording

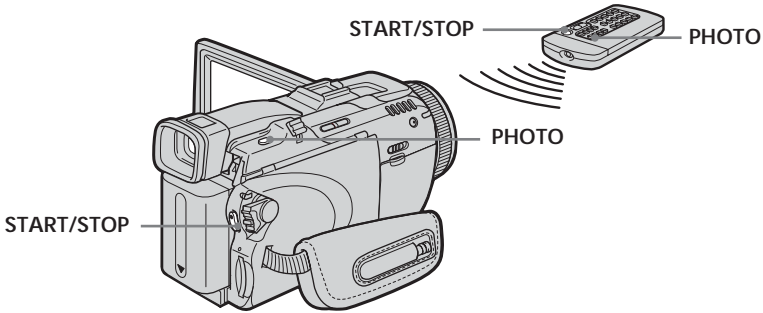

Recording on the tape

The POWER switch should be set to **CAMERA**.
Operate by touching the panel.

- (1) During standby, press FN and select PAGE2.
- (2) Press SELFTIMER.
The  (self-timer) indicator appears on the screen.
- (3) Press EXIT to return to FN.
- (4) Press START/STOP.

The self-timer starts counting down from about 10 while beeping. In the last two seconds of the countdown, the beep gets faster, then recording starts automatically.

Recording still images on the "Memory Stick" during recording standby

The POWER switch should be set to **CAMERA**.
Operate by touching the panel.

- (1) Follow the step 1 to 3 in "Recording on the tape."
- (2) Press PHOTO deeply.

The self-timer starts counting down from about 10 while beeping. In the last two seconds of the countdown, the beep gets faster, then the recording starts automatically.

To stop the countdown for recording on the tape

Press START/STOP. To restart the countdown, press START/STOP again.

To cancel the self-timer

With your camcorder during standby, press SELFTIMER and the  (self-timer) indicator disappears from the screen. You cannot cancel the self-timer using the Remote Commander.

Notes

- The self-timer recording is automatically canceled when self-timer recording is finished.
- You can record using the self-timer only during recording standby.

When the POWER switch is set to MEMORY

You can also record still images onto the "Memory Stick" with the self-timer (p. 122).

Download from [Www.Somanuals.com](http://www.Somanuals.com). All Manuals Search And Download.

Adjusting the white balance manually

Normally white balance is automatically adjusted.

The POWER switch should be set to **CAMERA** or **MEMORY**.
Operate by touching the panel.

- (1) Press FN to display PAGE1.
- (2) Press MENU to display the menu.
- (3) Select WHT BAL in **MF**, then press EXEC (p. 173).

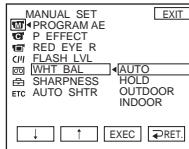

- (4) Select a desired mode, then press EXEC.

HOLD:

When recording a single-colored subject or background

OUTDOOR (☀):

- When recording a sunset/sunrise, just after sunset, just before sunrise, neon signs, or fireworks
- Under a color matching fluorescent lamp

INDOOR (☾):

- When lighting conditions change quickly
- In too bright places such as photography studios
- Under sodium lamps or mercury lamps

To return to FN

Press EXIT.

To return to the automatic white balance

Set WHT BAL to AUTO in the menu settings.

If the picture is being taken in a studio lit by TV lighting

We recommend that you record in the INDOOR mode.

When you record under fluorescent lighting

Select AUTO or HOLD.

Your camcorder may not adjust the white balance correctly in the INDOOR mode.

In the AUTO mode

Point your camcorder at the white subject for about 10 seconds after setting the POWER switch to CAMERA to get better adjustment when:

- You remove the battery pack for replacement.
- You bring your camcorder from indoors to outdoors holding the exposure, or vice versa.

In the HOLD mode

Set WHT BAL to AUTO and reset to HOLD after few seconds when:

- You change the mode of PROGRAM AE.
- You bring your camcorder from indoors to outdoors, or vice versa.

Download from [Www.Somanuals.com](http://www.Somanuals.com). All Manuals Search And Download.

Using the wide mode

If you move the power zoom lever to “W” side, you can record with a wider angles than normal tape recording.

You can record a 16:9 wide picture to watch on the 16:9 wide-screen TV (16:9WIDE). Black bands appear on the screen during recording in the 16:9WIDE mode [a]. The picture during playing back in the 4:3 mode on a wide-screen TV [b] or a normal TV [c]* are compressed in the widthwise direction. If you set the screen mode of the wide-screen TV to the full mode, you can watch pictures of normal images [d].

*The picture played back in the wide mode on a normal TV appears the same as the picture played back in the wide mode on your camcorder [a].

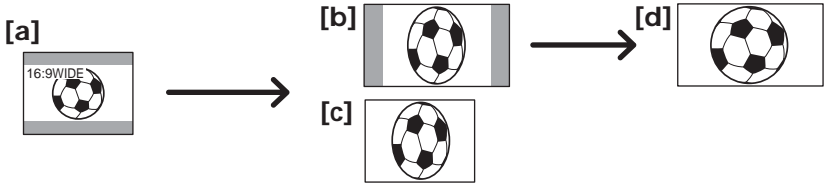

The POWER switch should be set to **CAMERA**.
Operate by touching the panel.

- (1) During recording standby, press FN to display PAGE1.
- (2) Press MENU to display the menu.
- (3) Select 16:9WIDE in , then press EXEC (p. 174).
- (4) Select ON, then press EXEC.

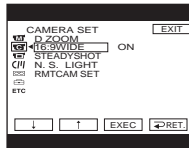

To return to FN

Press EXIT.

To cancel the wide mode

Set 16:9WIDE to OFF in the menu settings.

Using the wide mode

Notes

- In the wide mode, you cannot operate the following functions:
 - Recording still images on the “Memory Stick” during recording or tape recording standby
 - BOUNCE
 - OLD MOVIE
 - Progressive Recording Mode
- Pictures recorded on the tape in wide mode cannot be returned to normal size.

Connection for a TV

Pictures recorded in the 16:9WIDE mode automatically appear on the TV screen at full size when:

- You connect your camcorder to a TV that is compatible with the video ID (ID-1/ID-2) system.
- You connect your camcorder to the S video jack on a TV.

ID-1 system

The ID-1 system sends aspect ratio information (16:9, 4:3, or letter box) with video signals. If you connect a TV compatible with the ID-1 system, the screen size is automatically selected.



















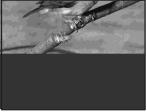

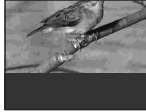

ID-2 system

The ID-2 system sends a copyright protection signal with ID-1 signals inserted between video signals when you connect your camcorder to other equipment using the A/V connecting cable.

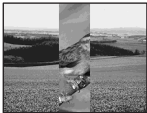
Using the fader function

You can fade in or out to give your recording a professional appearance.

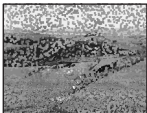
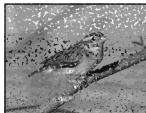
[a] STBY REC

NORM. FADER (normal)				
MOSC. FADER (mosaic)				
BOUNCE^{1) 2)}				
OVERLAP²⁾				
WIPE²⁾				
DOT²⁾				

[b] STBY REC

MONOTONE

When fading in, the picture gradually changes from black-and-white to color.

When fading out, the picture gradually changes from color to black-and-white.

¹⁾ You can use BOUNCE when D ZOOM in  is set to OFF in the menu settings.

²⁾ You can fade in only.

Using the fader function

The POWER switch should be set to **CAMERA**.
Operate by touching the panel.

(1) When fading in [a]

Press FN to display PAGE1 during recording standby.

When fading out [b]

Press FN to display PAGE1 during recording.

(2) Press FADER. The screen to select the fader mode appears.

(3) Press a desired mode.

(4) Press \rightarrow OK to return to PAGE1.

(5) Press EXIT to return to FN.

The fader indicator you selected flashes.

(6) Press START/STOP.

After the fade in/out is carried out, your camcorder automatically returns to the normal mode.

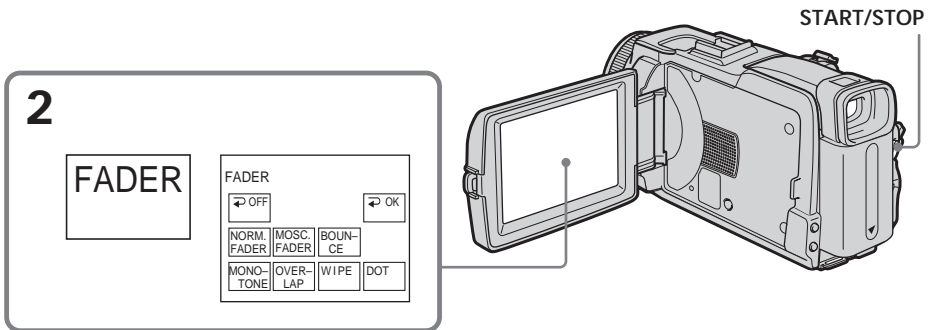

To cancel the fade in/out

Before pressing START/STOP, press \rightarrow OFF to return to PAGE1.

Using the fader function

Note

You cannot use the following functions while using fader. Also, you cannot use fader while using following functions:

- Super NightShot
- Color Slow Shutter
- Digital effect
- Interval Recording
- Frame recording
- Recording with the flash

When you select OVERLAP, WIPE or DOT

Your camcorder automatically stores the image recorded on the tape. As the image is being stored, the indicator becomes fast flashing, then the playback picture disappears.

During fading in with BOUNCE, you cannot use the following functions:

- Zoom
- Recording still images on the "Memory Stick"
- Picture effect
- PROGRAM AE
- Manual exposure
- Flexible Spot Meter
- Manual focus

Note on the BOUNCE mode

You cannot select BOUNCE in the followings:

- D ZOOM is activated in the menu settings
- Wide mode
- Picture effect
- PROGRAM AE
- Progressive Recording Mode

Using special effects – Picture effect

NEG. ART [a] : The color and brightness of the picture are reversed.

SEPIA : The picture is sepia.

B&W : The picture is monochrome (black-and-white).

SOLARIZE [b] : The picture looks like an illustration with a strong contrast.

PASTEL [c] : The picture looks like a pale pastel drawing.

MOSAIC [d] : The picture is mosaic.

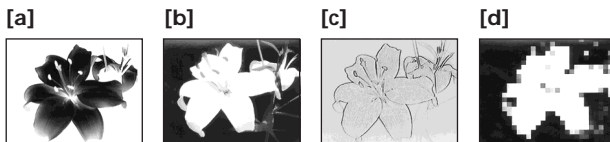

The POWER switch should be set to **CAMERA**.
Operate by touching the panel.

- (1) Press FN to display PAGE1.
- (2) Press MENU to display the menu.
- (3) Select P EFFECT in **[M]**, then press EXEC (p. 173).

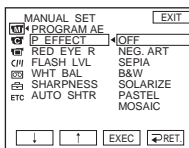

- (4) Select a desired mode, then press EXEC.

To return to FN

Press EXIT.

To cancel picture effect

Set P EFFECT to OFF in the menu settings.

Note

While using picture effect, you cannot use following functions:

- BOUNCE
- OLD MOVIE

Using special effects – Digital effect

STILL

You can record a still image so that it is superimposed on a moving picture.

FLASH (flash motion)

You can record still images successively at regular intervals.

LUMI. (luminance key)

You can swap the brighter area in a still image with a moving picture.

TRAIL

You can record a picture so that an incidental image like a trail is left.

SLOW SHTR (slow shutter)

You can slow down the shutter speed. The SLOW SHTR mode is good for recording dark pictures more brightly.

OLD MOVIE

You can add an old movie type atmosphere to pictures. Your camcorder automatically sets the 16:9WIDE mode, picture effect to SEPIA, and the appropriate shutter speed.

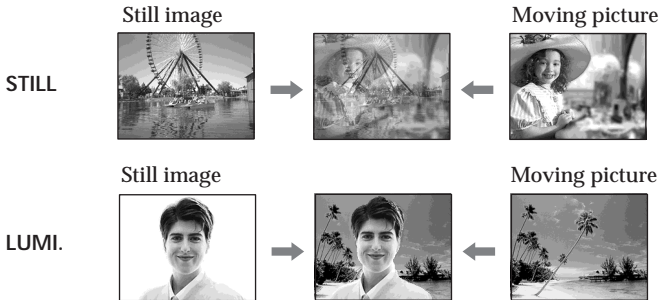

Using special effects – Digital effect

The POWER switch should be set to **CAMERA**.
Operate by touching the panel.

- (1) Press FN and select PAGE2.
- (2) Press DIG EFFT. The screen to select a digital effect is displayed.
- (3) Press a desired mode. When you select STILL or LUMI., the still image is stored in memory.
- (4) Press – (to decrease the effect)/+ (to increase the effect) to adjust the effect.

Items to adjust

STILL	The rate of the still image you want to superimpose on the moving picture
FLASH	The interval of flash motion
LUMI.	The color scheme of the area in the still image which is to be swapped with a moving picture
TRAIL	The vanishing time of the incidental image
SLOW SHTR	Shutter speed. The larger the shutter speed number, the slower the shutter speed.
OLD MOVIE	No adjustment necessary

- (5) Press ↵ OK to return to PAGE2.

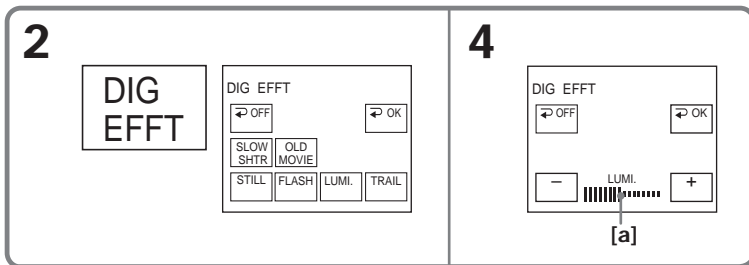

[a] The bar appears when setting following digital effect modes: STILL, FLASH, LUMI., TRAIL.

To return to FN

Press EXIT.

To cancel digital effect

Press ↵ OFF to return to PAGE2.

Using special effects – Digital effect

Notes

- While using digital effect, you cannot use the following functions:
 - Super NightShot
 - Color Slow Shutter
 - Fader
- PROGRAM AE does not work in the SLOW SHTR mode.
- The following functions do not work in the OLD MOVIE mode:
 - Wide mode
 - Picture effect
 - PROGRAM AE

When recording in the SLOW SHTR mode

Auto focus may not be effective. Focus manually using a tripod.

Shutter speed

Shutter speed number	Shutter speed
SLOW SHTR 1	1/30
SLOW SHTR 2	1/15
SLOW SHTR 3	1/8
SLOW SHTR 4	1/4

Using PROGRAM AE

SPOTLIGHT¹⁾

This mode prevents people's faces, for example, from appearing excessively white when shooting subjects lit by strong light in the theater.

PORTRAIT (soft portrait)

This mode brings out the subject while creating a soft background for subjects such as people or flowers.

SPORTS (sports lesson)¹⁾

This mode minimizes shake on fast-moving subjects such as in tennis or golf.

BEACH&SKI¹⁾

This mode prevents people's faces from appearing dark in strong light or reflected light, such as at a beach in midsummer or on a ski slope.

SUNSETMOON (sunset & moon)²⁾

This mode allows you to maintain atmosphere when you are recording sunsets, general night views, fireworks displays and neon signs.

LANDSCAPE²⁾

This mode is for when you record distant subjects such as mountains. Also it prevents your camcorder from focusing on glass or metal mesh in windows when you record a subject behind glass or a screen.



¹⁾ Your camcorder focuses only on subjects in the middle to far distance.

²⁾ Your camcorder focuses only distant subject.

Using PROGRAM AE

The POWER switch should be set to **CAMERA** or **MEMORY**.
Operate by touching the panel.

- (1) Press FN to display PAGE1.
- (2) Press MENU to display the menu.
- (3) Select PROGRAM AE in , then press EXEC (p. 173).

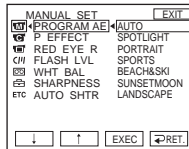

- (4) Select a desired mode, then press EXEC.

To return to FN

Press EXIT.

To cancel PROGRAM AE

Set PROGRAM AE to AUTO in the menu settings.

Notes

- The following functions do not work in PROGRAM AE:
 - Color Slow Shutter
 - During fading in with BOUNCE
 - SLOW SHTR
 - OLD MOVIE
 - Spot Focus
- PROGRAM AE does not work in the following cases (The indicator flashes):
 - NightShot
 - When the POWER switch is set to MEMORY, you use MEMORY MIX.
- When you set the POWER switch to MEMORY, the SPORTS mode does not work. (The indicator flashes.)

Adjusting the exposure manually

We recommend adjusting the exposure manually in the following cases:

- When the subject is backlit
- When the subject is too bright against the background
- When recording dark pictures (e.g. night scenes) faithfully

The POWER switch should be set to **CAMERA** or **MEMORY**.

Operate by touching the panel.

- (1) Press FN to display PAGE1.
- (2) Press EXPOSURE. The screen to adjust the exposure appears.
- (3) Press MANUAL.
- (4) Adjust the exposure using - (to dim)/+ (to brighten).
- (5) Press ↵ OK to return to PAGE1.

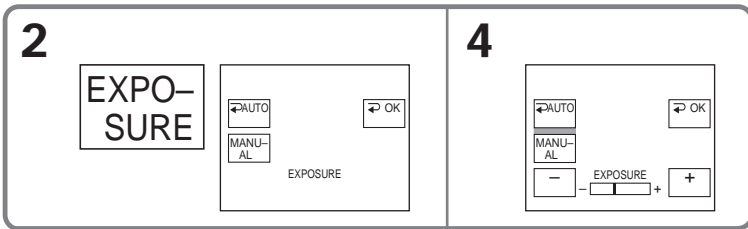

To return to FN

Press EXIT.

To return to the automatic exposure

Press ↵ AUTO to return to PAGE1.

Note

When you adjust the exposure manually, the following functions do not work:

- Back light function
- Color Slow Shutter

Using spot light-metering function – Flexible Spot Meter

You can take a picture with the appropriate exposure automatically for just the point you want to focus on and with its exposure fixed.

Use Flexible Spot Meter in the following cases:

- The subject is backlit.
- When there is strong contrast between the subject and background such as with a subject that is on stage and lit by a spotlight.

The POWER switch should be set to **CAMERA** or **MEMORY**.

Operate by touching the panel.

- (1) Press FN to display PAGE1.
- (2) Press SPOT METER. The SPOT METER screen appears.
- (3) Press the desired area in the frame.

The SPOT METER indicator flashes on the screen. The exposure of the point you selected is adjusted.

- (4) Press **↶** OK to return to PAGE1.

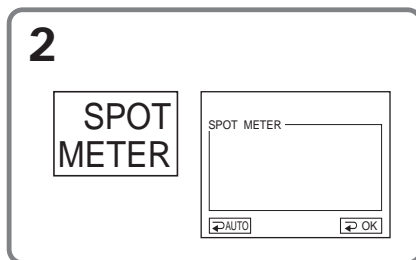

To return to FN

Press EXIT.

To return to the automatic exposure

Press **↶** AUTO to return to PAGE1.

Note

The following functions do not work during Flexible Spot Meter:

- Back light function
- Color Slow Shutter
- Spot Focus

Focusing manually

You can gain better results by manually adjusting the focus in the following cases. Normally, focus is automatically adjusted.

When the POWER switch is set to MEMORY, you can adjust the focus manually with the image enlarged to twice the size (Expanded focus).

- The autofocus mode is not effective when shooting:
 - Subjects through glass coated with water droplets
 - Horizontal stripes
 - Subjects with little contrast with backgrounds such as walls or the sky
- When you want to change the focus from a subject in the foreground to a subject in the background
- Shooting a stationary subject when using a tripod

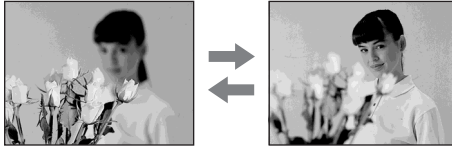

The POWER switch should be set to **CAMERA** or **MEMORY**.



(1) Press FOCUS.

The  (focus) indicator appears on the screen.

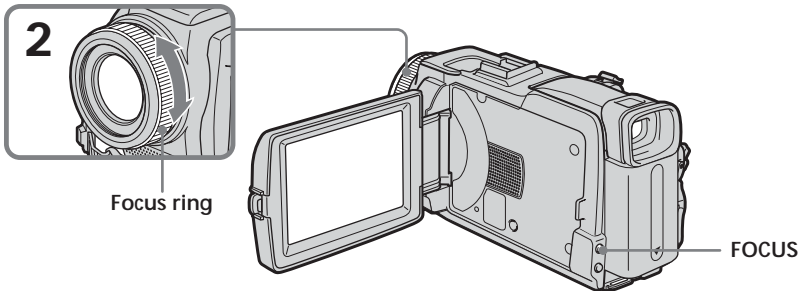

(2) Turn the focus ring to sharpen focus.



To return to the autofocus

Press FOCUS to turn off the ,  or  indicator.

About expanded focus

If you set EXPANDED F in  to ON in the menu settings (p. 174) when the POWER switch is set to MEMORY, the  (expanded focus) indicator appears when the focus ring is turned and the image will be enlarged to twice its size. The focal distance information is also displayed. Adjustment is complete, the image returns to its original size automatically.

Focusing manually



To focus precisely

It is easier to focus on the subject if you adjust the zoom to shoot at the “W” (wide-angle) position after focusing at the “T” (telephoto) position.

When you shoot close to the subject

Focus at the end of the “W” (wide-angle) position.

 changes as follows:

-  when recording a distant subject
-  when the subject is too close to focus on

Focal distance information is displayed for about three seconds on the LCD screen in the following cases:

- When switching the focus adjustment mode from autofocus to manual
- When turning the focus ring

Focal distance information

You cannot get correct information if you have attached a conversion lens (optional) to your camcorder.

Using spot focus function – Spot Focus

You can take a picture with the appropriate focus automatically for just the point you want to focus on and with its focus fixed.

The POWER switch should be set to **CAMERA** or **MEMORY**.
Operate by touching the panel.

- (1) Press FN to display PAGE1.
- (2) Press SPOT FOCUS. The SPOT FOCUS screen appears.
- (3) Press the desired area in the frame.

The SPOT FOCUS indicator flashes on the screen. The focus of the point you selected is adjusted.

- (4) Press **↩** OK to return to PAGE1.

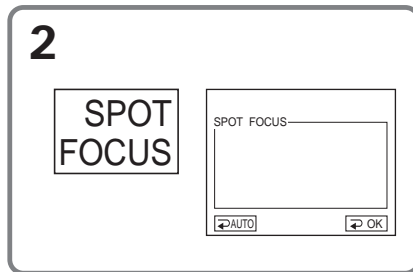

To return to FN

Press EXIT.

To return to the autofocus

Press **↩** AUTO to return to PAGE1.

Note

The back light function does not work during Spot Focus.

Focal distance information

It is not displayed on the screen.

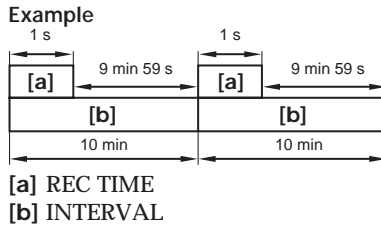

Interval Recording

You can make a time-lapse recording by setting your camcorder to automatically record and standby sequentially. You can achieve an excellent recording for flowering, emergence, etc. with this function.



There may be a discrepancy in recording time of up to +/- six frames from the selected time.

The POWER switch should be set to **CAMERA**.
Operate by touching the panel.

- (1) Press FN to display PAGE1.
- (2) Press MENU to display the menu.
- (3) Select INT. REC in , then press EXEC (p. 179).
- (4) Select SET, then press EXEC.
- (5) Select INTERVAL, then press EXEC.
- (6) Select a desired interval time, then press EXEC.
The time: 30SEC ↔ 1MIN ↔ 5MIN ↔ 10MIN
- (7) Select REC TIME, then press EXEC.
- (8) Select a desired recording time, then press EXEC.
The time: 0.5SEC ↔ 1SEC ↔ 1.5SEC ↔ 2SEC
- (9) Press  RET.
- (10) Set INT. REC to ON, then press EXEC.
- (11) Press EXIT to return to FN.
The INTERVAL TAPE indicator flashes on the screen.
- (12) Press START/STOP to start Interval Recording.
The INTERVAL TAPE indicator lights up during Interval Recording.

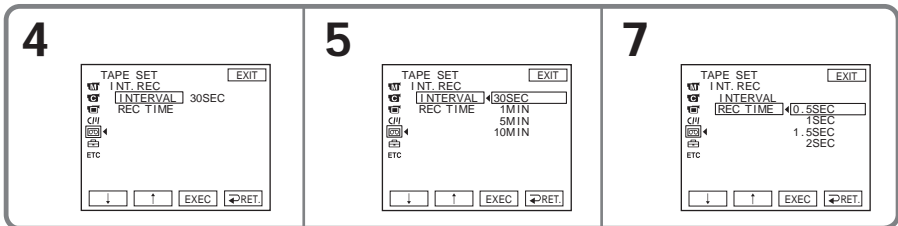

To cancel Interval Recording

Set INT. REC to OFF in the menu settings.

Frame by frame recording

- Frame recording

You can make a recording with a stop-motion animated effect using frame recording. To create this effect, alternately move the subject a little and make frame recording. We recommend that you use a tripod, and operate your camcorder using the Remote Commander after step 6.

The POWER switch should be set to **CAMERA**.

Operate by touching the panel.

- (1) Press FN to display PAGE1.
- (2) Press MENU to display the menu.
- (3) Select FRAME REC in , then press EXEC (p. 179).

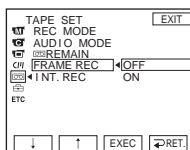

- (4) Select ON, then press EXEC.
- (5) Press EXIT to return to FN.
The FRAME REC indicator lights up.
- (6) Press START/STOP to start frame recording. Your camcorder makes a recording for about six frames, and returns to recording standby.
- (7) Move the subject, and repeat step 6.

To cancel frame recording

Set FRAME REC to OFF in the menu settings.

Note

The proper remaining tape time is not indicated if you use frame recording continuously.

When using frame recording

The last recorded frame is longer than other frames.

Recording with all the pixels

- Progressive Recording Mode

To import moving pictures to a computer to view still images, we recommend you record in Progressive Recording Mode. To use Progressive Recording Mode, follow the procedure below. Still images produced this way are more stable than those recorded in normal mode, and thus are more suitable for analyzing high-speed action such as sports scenes. (Since your camcorder takes in an image every 1/30 of a second in Progressive Recording Mode, moving pictures recorded in this mode may be subject to too much jitter. To view moving pictures, we recommend recording in normal mode.)



The POWER switch should be set to **CAMERA**. Operate by touching the panel.

- (1) Press FN and select PAGE3.
- (2) Press PRGRE REC.

To cancel Progressive Recording Mode

Press PRGRE REC again.

To return to FN

Press EXIT.

Note on Progressive Recording Mode

The normal TV broadcast divides the screen into two finer fields and displays them in turns every 1/60 of a second. Thus, the actual image displayed in an instant covers only half of the apparent image area. Displaying the whole image simultaneously on a full screen is called displaying with all the pixels. In this function the picture is clearer than one in normal function, but moving objects appear jerky since the picture is read/output every about 1/30 second.

When recording under fluorescent light

When recording in Progressive Recording Mode under fluorescent light or light bulb, a rare phenomenon may happen in which the screen lights up brightly (Flicker phenomenon). This is not a malfunction. If you want to stop this phenomenon, cancel Progressive Recording Mode.

When you record with Progressive Recording Mode

The angle of view is slightly larger than normal recording.





During Progressive Recording Mode, you cannot use the following functions:

- Digital zoom
- Recording still images on the "Memory Stick" during tape recording or tape recording standby
- Wide mode
- BOUNCE
- SLOW SHTR
- OLD MOVIE
- SteadyShot

Using the viewfinder

Turn the LCD panel over and move it back to your camcorder body with the LCD screen facing out. You can operate with the touch panel using the viewfinder. Use the viewfinder when operating camera brightness and fader on the touch panel.

The POWER switch should be set to **CAMERA** or **MEMORY**. Operate by touching the panel.

- (1) Turn the LCD panel over and move it back to your camcorder body with the LCD screen facing out.
- (2) Press  OFF. The PANEL OFF indicator appears on the screen.
- (3) Press OK. The LCD screen is turned off.
- (4) Using the viewfinder, press the LCD screen. EXPOSURE,  OK,  ON and FADER (only when the POWER switch is set to CAMERA) appear.
- (5) Press the LCD screen and select a desired item, then press  OK.

EXPOSURE: Adjust the exposure by pressing -/+.

FADER: Press FADER until a desired fader mode appears.

The indicator changes as follows:

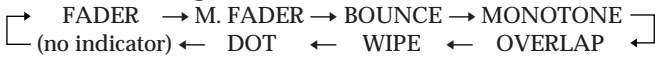

 ON: The LCD screen lights up.

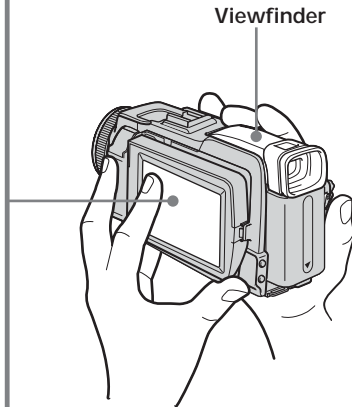
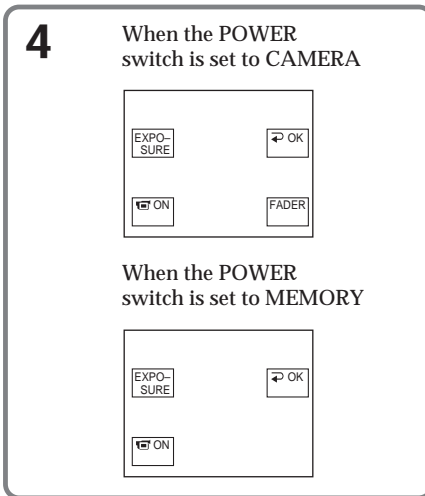

To make the buttons on the LCD screen disappear

Press  OK.

Using the viewfinder

Note

When the POWER switch is set to VCR or during memory playback, you cannot operate with the touch panel using the viewfinder.

To operate the items that do not appear

Set the LCD panel back to the previous position. Operate the items using the LCD screen.

Available recording time

This is the time when you record pictures using the viewfinder (p. 17).

Playing back tape with picture effect

The POWER switch should be set to (VCR).
Operate by touching the panel.

- (1) During playback or playback pause, press FN to display PAGE1.
- (2) Press MENU to display the menu.
- (3) Select P EFFECT in **[M]**, then press EXEC (p. 173).

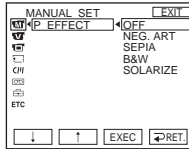

- (4) Select a desired mode, then press EXEC.
You can use NEG. ART, SEPIA, B&W and SOLARIZE.
See page 53 for details of each mode.

To return to FN

Press EXIT.

To cancel picture effect

Set P EFFECT to OFF in the menu settings.

Notes

- You cannot process externally input scenes using picture effect.
- You cannot record images on the tape on your camcorder while you are processing the image using picture effect. Record images on the “Memory Stick” (p. 114, 123), or on a VCR using your camcorder as a player.

Pictures processed by picture effect

Pictures processed by picture effect are not output through the **[i]** DV Interface.

Playing back tape with digital effect

The POWER switch should be set to (VCR).
Operate by touching the panel.

- (1) During playback or playback pause, press FN and select PAGE2.
- (2) Press DIG EFFT. The screen to select a digital effect is displayed.
- (3) Select a desired mode. You can use STILL, FLASH, LUMI. and TRAIL. See page 54 for details of the each mode.
When you select STILL or LUMI., the picture that you select the mode to is stored in memory as a still image.
- (4) Press -/+ to adjust the effect.
- (5) Press ↵ OK to return to PAGE2.

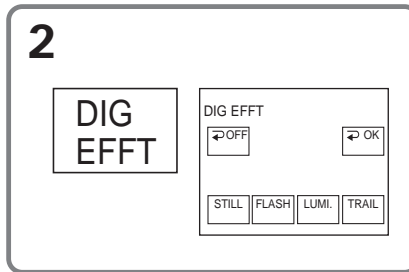

To return to FN

Press EXIT.

To cancel digital effect

Press ↵ OFF to return to PAGE2.

Notes

- You cannot process externally input scenes using digital effect.
- You cannot record images on the tape on your camcorder while you are processing the image using digital effect. Record images on the “Memory Stick” (p. 114, 123), or on a VCR using your camcorder as a player.

Pictures processed by digital effect

Pictures processed by digital effect are not output through the i DV Interface.

Enlarging images recorded on tape

- Tape PB ZOOM

Besides the operation described here, your camcorder can enlarge still images recorded on the "Memory Stick" (p. 133).

The POWER switch should be set to **(VCR)**.
Operate by touching the panel.

- (1) During playback or playback pause, press FN and select PAGE2.
- (2) Press PB ZOOM. The PB ZOOM screen appears.
- (3) Press the area you want to enlarge in the frame.
The area you pressed moves to the center of the screen, and the playback image is enlarged to about twice the size. If you then press another area, that area moves to the center of the screen.
- (4) Adjust the zoom ratio by the power zoom lever.
You can select the zoom ratio from approximately 1.1 times up to 5 times its size.
W : Decrease the zoom ratio.
T : Increase the zoom ratio.

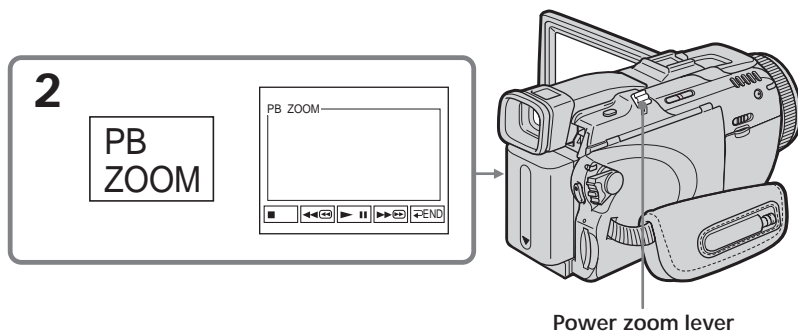

To cancel tape PB ZOOM

Press **↶** END.

Notes

- You cannot process externally input scenes using tape PB ZOOM with your camcorder.
- You cannot record images on the tape on your camcorder while you are processing the image using tape PB ZOOM. However, you can record images on the "Memory Stick" (p. 114), or on a VCR using your camcorder as a player.
- You cannot record moving pictures on the "Memory Stick" on your camcorder when you have processed the picture using tape PB ZOOM.

Images in tape PB ZOOM

Images in tape PB ZOOM are not output through the **i** DV Interface.

In tape PB ZOOM

If you press DISPLAY/BATTERY INFO, the frame on the PB ZOOM screen disappears. You cannot move the part you pressed to the center of the screen.

Edge of the enlarged image

The edge of the enlarged image cannot be displayed at the center of the screen.

Quickly locating a scene

- Zero set memory

Your camcorder automatically searches for a desired scene having the tape counter value of "0:00:00." Use the Remote Commander for this operation.

The POWER switch should be set to (VCR).

- (1) During playback, press ZERO SET MEMORY on the Remote Commander at the point you want to locate later. The tape counter shows "0:00:00," then starts counting. If the indicators do not appear, press DISPLAY. The ZERO SET MEMORY indicator flashes.
- (2) Press ■ when you want to stop playback.
- (3) Press ◀◀ to rewind the tape to the tape counter's zero point. The tape stops automatically when the tape counter reaches approximately zero.
- (4) Press ▶▶. Playback starts from the counter's zero point.

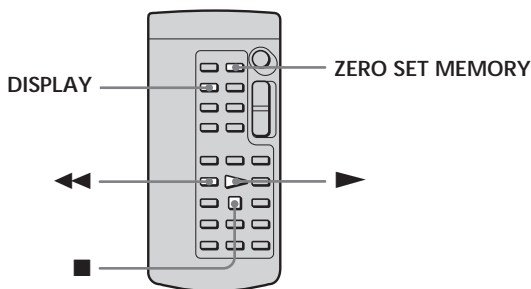

Notes

- When you press ZERO SET MEMORY before rewinding the tape, the zero set memory function will be canceled.
- There may be a discrepancy of several seconds between the time code and the tape counter.
- The ZERO SET MEMORY indicator disappears when you press FN.

If the tape has a blank portion in the recorded portions
The zero set memory function may not work correctly.

Searching the boundaries of recorded tape by title – Title search

Use the cassette with **Cassette Memory** for this operation.

Use the **Remote Commander** for this operation.

Before operation

Set **CM SEARCH** in **[CM]** to **ON** in the menu settings. (The default setting is **ON**.)

The **POWER** switch should be set to **(VCR)**.

- (1) Press **SEARCH MODE** on the Remote Commander repeatedly, until the **TITLE SEARCH** indicator appears.

The title search screen appears.

The indicator changes as follows:

→ **TITLE SEARCH** → **DATE SEARCH** → (no indicator)

- (2) Press **◀◀** or **▶▶** on the Remote Commander to select the title for playback. Your camcorder automatically starts playback of the scene having the title that you selected.

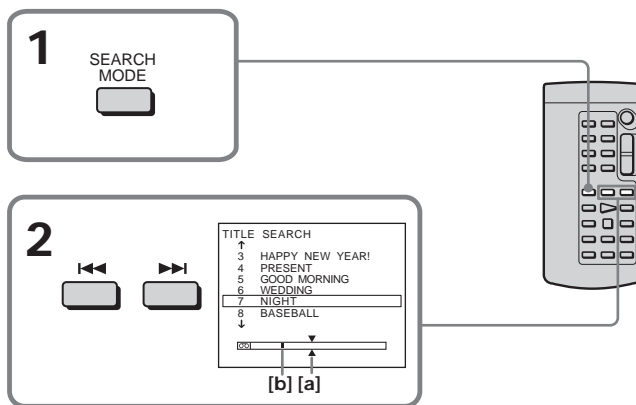

[a] Actual point you are trying to search for

[b] Present point on the tape

To cancel searching

Press **■** on the Remote Commander.

If the tape has a blank portion between recorded portions

Title search may not work correctly.

To superimpose a title

See page 95.

Searching a recording by date

- Date search

- DATE SEARCH by using Cassette Memory
 - Cue by selecting the recording date on the screen
 - DATE SEARCH without using Cassette Memory
 - Cue to changing point of recording date
- Use the Remote Commander for this operation.

Searching for the date by using Cassette Memory

Before operation

- You can use this function only when playing back the cassette with Cassette Memory.
- Set CM SEARCH in  to ON in the menu settings. (The default setting is ON.)

The POWER switch should be set to .



Operate by touching the panel.

- (1) Press SEARCH MODE on the Remote Commander repeatedly, until the DATE SEARCH indicator appears.

The date search screen appears.

The indicator changes as follows:

→ TITLE SEARCH → DATE SEARCH → (no indicator) →

- (2) Press  or  on the Remote Commander to select the date for playback. Your camcorder automatically starts playback at the beginning of the selected date.

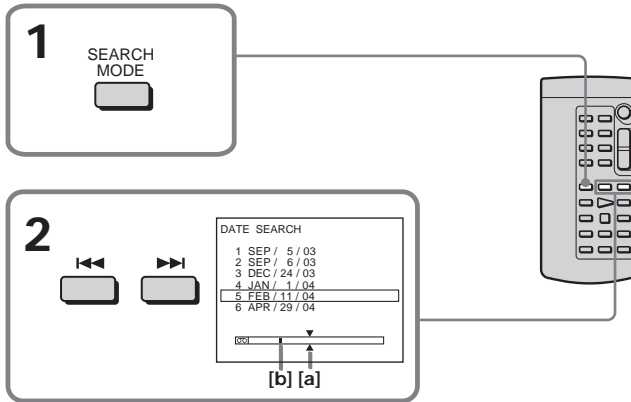

[a] Actual point you are trying to search for

[b] Present point on the tape

To cancel searching

Press  on the Remote Commander.

Searching a recording by date – Date search

Searching for the date without using Cassette Memory

The POWER switch should be set to **(VCR)**.
Operate by touching the panel.

- (1) Press FN to display PAGE1.
- (2) Press MENU to display the menu.
- (3) Select CM SEARCH in **[CM]**, then press EXEC (p. 178).

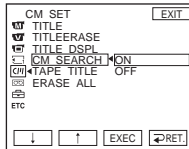

- (4) Select OFF, then press EXEC.
- (5) Press SEARCH MODE on the Remote Commander, until the DATE SEARCH indicator appears.
- (6) Press **◀◀** on the Remote Commander to search for the previous date or press **▶▶** on the Remote Commander to search for the next date. Your camcorder automatically starts playback at the point where the date changes. Each time you press **◀◀** or **▶▶**, your camcorder searches for the previous or next date.

To cancel searching

Press **■** on the Remote Commander or **■** on your camcorder.

Note

If one day's recording is less than two minutes, your camcorder may not accurately find the point where the recording date changes.

If the tape has a blank portion between recorded portions

Date search may not work correctly.

Cassette Memory

The cassette with Cassette Memory can hold six recording date data. If you search the date among seven or more data, see "Searching for the date without using Cassette Memory."

Dubbing tape

You can dub or edit on the VCR connected to your camcorder using your camcorder as a player.

You can connect either the A/V connecting cable (supplied) or i.LINK cable (optional). If you connect with the i.LINK cable (optional), video and audio signals are transmitted in digital form for high-quality editing.

Titles, screen indicators, Cassette Memory contents, and "Memory Stick" index screen lettering cannot be recorded.

Connecting to the VCR

You can edit on VCRs that support the following systems:

8 mm **B**, Hi8 **Hi8**, Digital8 **D8**, VHS **VHS**, S-VHS **S-VHS**, VHSC **VHSC**, S-VHSC **S-VHSC**, Betamax **B**, ED Betamax **ED Beta**, mini DV **Mini DV**, DV **DV** or MICROMV **MICROMV**

Connecting with the A/V connecting cable

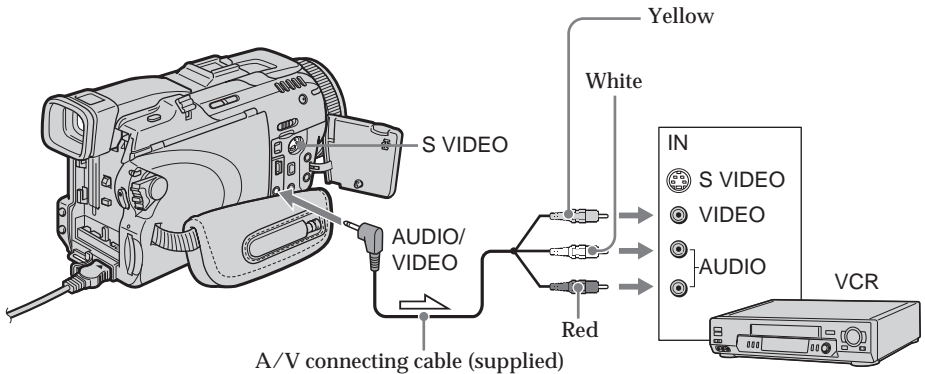

➤ : Signal flow

Connecting with the i.LINK cable

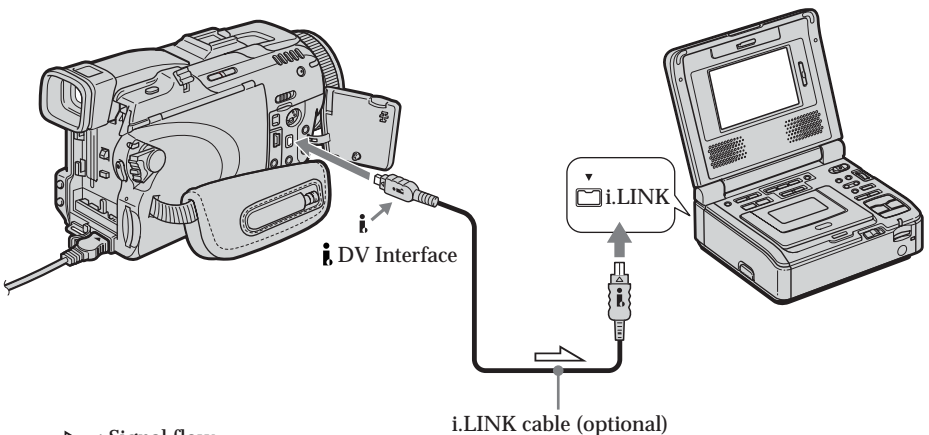

➤ : Signal flow

Dubbing a tape

Before operation for connecting with the A/V connecting cable

- Set DISPLAY in **[ETC]** to LCD in the menu settings. (The default setting is LCD.)
- Press the following buttons to make the indicator disappear so that they will not be superimposed on the edited tape:

On your camcorder:

DISPLAY/BATTERY INFO, DATA CODE

On the Remote Commander:

DISPLAY, DATA CODE, SEARCH MODE

The POWER switch should be set to **(VCR)**.

- (1) Insert the blank tape (or the tape you want to record over) into the VCR, and insert the recorded tape into your camcorder.
- (2) Prepare the VCR for recording. If the VCR has an input selector, set it to input mode.
Refer to the operating instructions of the VCR.
- (3) Play back the recorded tape on your camcorder.
- (4) Start recording on the VCR.
Refer to the operating instructions of your VCR.

When you have finished dubbing the tape

Press **■** on both your camcorder and the VCR.

If your VCR is a monaural type

Connect the yellow plug of the A/V connecting cable to the video input jack and the white or the red plug to the audio input jack on the VCR or the TV. When the white plug is connected, the left channel audio is output, and when the red plug is connected, the right channel audio is output.

If your VCR has an S video jack

See page 43 for details.

About i.LINK

See page 199 for details.

Pictures processed by picture effect, digital effect or PB ZOOM

These are not output through the **i** DV Interface.

If you record a paused playback picture

- The recorded picture becomes rough with the **i** DV Interface.
- The picture may jitter when you play back the picture using other video equipment.

If you connect with the i.LINK cable

Recording of only the picture or sound cannot be done.

Dubbing only desired scenes

- Digital program editing (on tape)

You can duplicate selected scenes (programs) for editing onto the tape without operating the VCR.

Scenes can be selected by frame. You can set up to 20 programs.

Your camcorder can dub on the "Memory Stick." See page 125 for details.

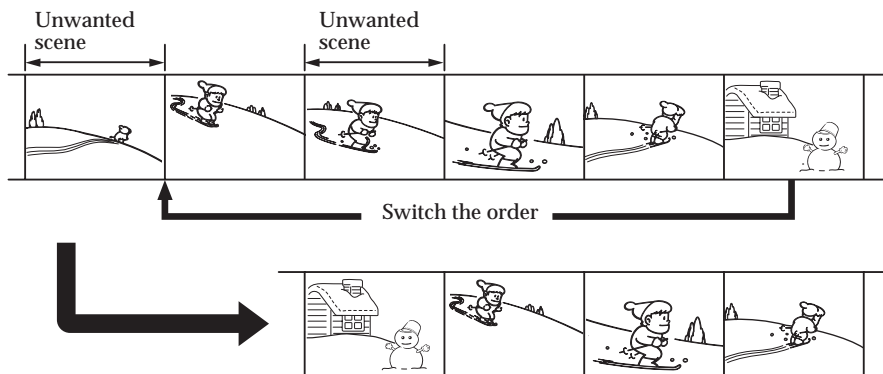

Before operating Digital program editing on the tape recorded on other equipment

Step 1 Connecting to the VCR (p. 78).

Step 2 Setting the VCR to operate (p. 79).

Step 3 Adjusting the synchronization of the VCR (p. 82).

When you dub using the same VCR again, you can skip step 2 and 3.

Using Digital program editing on the tape recorded on other equipment

Operation 1 Making a program (p. 84).

Operation 2 Performing Digital program editing (Dubbing the tape) (p. 86).

Note

When editing digital video, the operation signals to the VCR cannot be sent with LANC jack.

Step 1: Connecting to the VCR

You can connect either the A/V connecting cable or the i.LINK cable. Connect the devices as illustrated on page 76.

Dubbing only desired scenes – Digital program editing (on tape)

Step 2: Setting the VCR to operate

To connect using the A/V connecting cable, send the control signal by infrared rays to the remote sensor on the VCR.

The POWER switch should be set to **(VCR)**.
Operate by touching the panel.

- (1) Turn the power of the connected VCR on.
If the VCR has an input selector, set it to input mode.
When you connect a video camera recorder, set its power switch to VCR/VTR.
- (2) Press FN to display PAGE1.
- (3) Press MENU to display the menu.
- (4) Select VIDEO EDIT in **[ETC]**, then press EXEC (p. 182).
- (5) Select TAPE, then press EXEC.
- (6) Press EDIT SET.
- (7) Select CONTROL, then press EXEC.
- (8) When connecting with the A/V connecting cable, select IR, then press EXEC.
When connecting with the i.LINK cable, select i.LINK, press EXEC, then go to "Step 3: Adjusting the synchronization of the VCR" on page 82.
- (9) Select IR SETUP, then press EXEC.
- (10) Select the IR SETUP code of your VCR, then press EXEC. Check the code in "About the IR SETUP code" (p. 81).

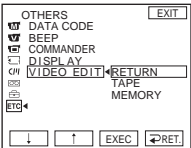
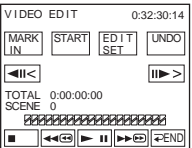
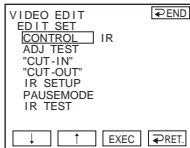
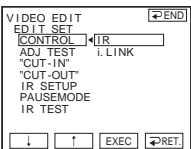
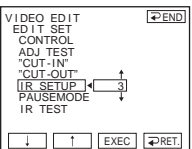
<p>4</p>  <p>OTHERS [EXIT] DATA CODE BEEP COMMANDER DISPLAY VIDEO EDIT [RETURN] TAPE MEMORY [ETC] [↓] [↑] [EXEC] [RET.]</p>	<p>5</p>  <p>VIDEO EDIT 0:32:30:14 [MARK] [START] [EDIT] [UNDO] [IN] [SET] [◀] [▶] TOTAL 0:00:00:00 SCENE 0 [▶] [◀] [▶▶] [◀◀] [END]</p>	<p>6</p>  <p>VIDEO EDIT [END] EDIT SET CONTROL [] IR ADJ TEST "CUT-IN" "CUT-OUT" IR SETUP PAUSEMODE IR TEST [↓] [↑] [EXEC] [RET.]</p>
<p>7</p>  <p>VIDEO EDIT [END] EDIT SET CONTROL [] IR ADJ TEST i.LINK "CUT-IN" "CUT-OUT" IR SETUP PAUSEMODE IR TEST [↓] [↑] [EXEC] [RET.]</p>	<p>9</p>  <p>VIDEO EDIT [END] EDIT SET CONTROL ADJ TEST "CUT-IN" "CUT-OUT" IR SETUP [] 3 PAUSEMODE IR TEST [↓] [↑] [EXEC] [RET.]</p>	

Dubbing only desired scenes – Digital program editing (on tape)

- (11) Select PAUSEMODE, then press EXEC.
- (12) Select the mode to cancel recording pause on the VCR, then press EXEC.
The correct button depends on your VCR.
Refer to the operating instructions of your VCR.

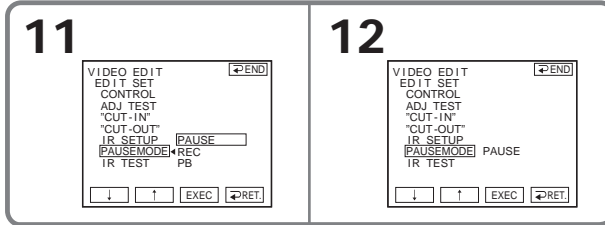

- (13) Locate the infrared rays emitter of your camcorder and face it towards the remote sensor of the VCR about 30 cm (12 in.) apart.

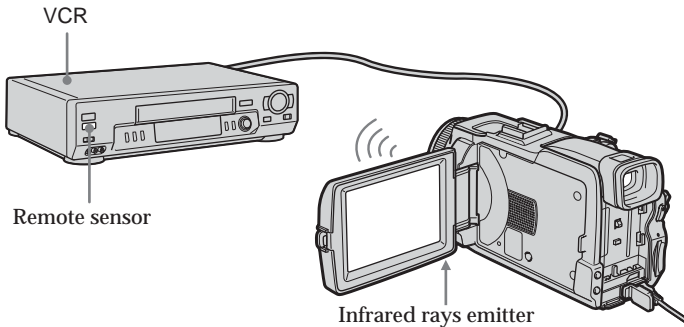

- (14) Insert the recordable tape into the VCR, then set the VCR to recording pause.
- (15) Select IR TEST, then press EXEC.
- (16) Select EXECUTE, then press EXEC.
If the VCR starts recording, the setting is correct.
The indicator you selected to cancel recording pause on the VCR flashes on the screen. When finished, the indicator changes to COMPLETE.

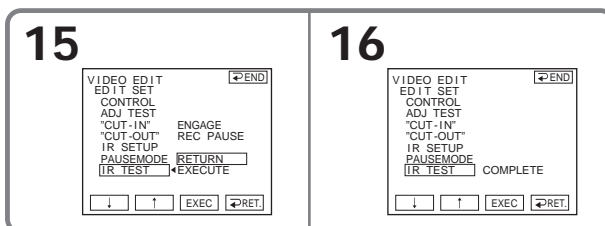

Dubbing only desired scenes – Digital program editing (on tape)

Note

When you connect with an i.LINK cable, you may not be able to operate the dubbing function correctly, depending on the VCR.

Set CONTROL to IR in the menu settings of your camcorder.

About the IR SETUP code

The IR SETUP code is stored in the memory of your camcorder. Be sure to set the correct code, depending on your VCR. Default setting is code number 3.

Brand	IR SETUP code
Sony	1, 2, 3, 4, 5, 6
Admiral (M. Wards)	89
Aiwa	47, 54, 80
Akai	49, 51
Audio Dynamic	21, 35
Bell&Howell (M. Wards)	36
Broksonic	21, 70, 82
Canon	77, 78
Citizen	47
Craig	47, 73
Curtis Mathis	8, 77, 80
Daewoo	26, 40, 77
DBX	21, 33, 35
Dimensia	8
Emerson	26, 48, 59, 70, 80, 81, 82
Fisher	36, 37, 44, 45
Funai	80
General Electric	8, 32*, 77, 94*, 101
Goldstar/LG	47
GO VIDEO	71
Hitachi	8, 42, 78
HQ	40
Instant Replay	77, 78
JC Penny	8, 21, 33, 35, 36, 42, 77
JVC	12, 13, 14, 21, 33, 35
Kenwood	21, 33, 35, 47
LXI (Sears)	36, 37, 42, 44, 45, 47, 49, 80
Magnavox	17, 77, 78, 83
Marantz	21, 33, 35
Marta	47
Memorex	37, 77
Minolta	8, 42

Brand	IR SETUP code
Mitsubishi/MGA	22, 23, 24, 28, 29
Multitech	23, 32, 80
NEC	21, 33, 35
Olympic	77, 78
Optimus	22
Orion	60
Panasonic	16, 17, 77, 78
Pentax	8, 42
Philco	26, 70, 77, 78
Philips	47, 77, 78, 83
Pioneer	78
Quasar	6, 16, 17, 77, 78
RCA/PROSCAN	7, 8, 16, 40, 41, 42, 77, 78, 78*, 83, 101
Realistic	22, 36, 37, 77, 80, 88
Sansui	21
Singer	73
Samsung	24, 24*, 32, 32*, 41, 94, 94*
Sanyo	26, 36, 37, 47
Scott	22, 23, 24, 28, 32, 37, 40, 41
Sharp	88, 89
Shintom	73
Signature 2000	80, 89
Sylvania	77, 78, 80, 83
Symphonic	80
Tashiro	47
Tatung	21, 33, 35
Teac	21, 33, 35, 80
Technics	77, 78
Toshiba	7, 40, 49
Wards	37, 47, 88, 89, 95
Yamaha	21, 33, 35, 36
Zenith	95

* TV/VCR component

Note on the IR SETUP code

Digital program editing is not possible if the VCR does not support IR SETUP codes.

Dubbing only desired scenes – Digital program editing (on tape)

When the VCR does not operate correctly

- After checking the code in “About the IR SETUP code” (p. 81), set the IR SETUP or the PAUSEMODE again.
- Place your camcorder at least 30 cm (12 in.) away from the VCR.
- Refer to the operating instructions of your VCR.

Step 3: Adjusting the synchronization of the VCR

You can adjust the synchronization of your camcorder and the VCR.

Prepare a pen and paper for notes.

Before operation, eject the cassette from your camcorder (if inserted).

- (1) Insert the recordable cassette into the VCR, then set the VCR to recording pause.
When you select i.LINK in CONTROL, the recording pause is not necessary.
- (2) Select ADJ TEST, then press EXEC.
- (3) Select EXECUTE, then press EXEC.
IN and OUT are recorded on an image for five times each to calculate the number values for adjusting the synchronization.
The EXECUTING indicator flashes on the screen. When finished, the indicator changes to COMPLETE.
- (4) Rewind the tape in the VCR, then start slow playback.
Five IN numbers and corresponding OUT numbers are displayed.
Take a note of the opening number value of each IN and the closing number value of each OUT.
- (5) Calculate the average of five opening number values of five IN, and the average of all the closing number values of each OUT.
- (6) Select "CUT-IN," then press EXEC.
- (7) Select the average number value of IN, then press EXEC.
The calculated start position for recording is set.
- (8) Select "CUT-OUT," then press EXEC.
- (9) Select the average number value of OUT, then press EXEC.
The calculated stop position for recording is set.
- (10) Press \leftarrow RET. to execute.

Dubbing only desired scenes – Digital program editing (on tape)

<p>2</p> <pre>VIDEO EDIT [END] EDIT SET CONTROL ADJ TEST [RETURN] "CUT-IN" EXECUTE "CUT-OUT" IR SETUP ENGAGE PAUSEMODE REC PAUSE IR TEST [DOWN] [UP] [EXEC] [RET]</pre>	<p>3</p> <pre>VIDEO EDIT [END] EDIT SET CONTROL ADJ TEST COMPLETE "CUT-IN" "CUT-OUT" IR SETUP PAUSEMODE IR TEST [DOWN] [UP] [EXEC] [RET]</pre>
<p>6</p> <pre>VIDEO EDIT [END] EDIT SET CONTROL ADJ TEST [CUT-IN] [0] "CUT-OUT" IR SETUP PAUSEMODE IR TEST [DOWN] [UP] [EXEC] [RET]</pre>	<p>8</p> <pre>VIDEO EDIT [END] EDIT SET CONTROL ADJ TEST "CUT-IN" [CUT-OUT] [0] IR SETUP PAUSEMODE IR TEST [DOWN] [UP] [EXEC] [RET]</pre>

To return to FN

Press \rightarrow END to return to PAGE1, then press EXIT.

Notes

- When you complete step 3, the image to adjust the synchronization is recorded for about 50 seconds.
- If you start recording from the very beginning of the tape, the first few seconds of the tape may not be recorded properly. Be sure to allow about 10 seconds' lead before starting the recording.
- When the recording unit cannot be operated properly by the i.LINK cable, leave the connection as it is, and make the A/V connecting cable settings (p. 79). Video and audio are sent by digital signals.

Dubbing only desired scenes – Digital program editing (on tape)

Operation 1: Making a Program

The POWER switch should be set to (VCR).
Operate by touching the panel.

- (1) Insert the cassette for playback into your camcorder, and insert the tape for recording into the VCR.
- (2) Press FN to display PAGE1.
- (3) Press MENU to display the menu.
- (4) Select VIDEO EDIT in **[ETC]**, then press EXEC (p. 182).
- (5) Select TAPE, then press EXEC.
- (6) Search for the beginning of the first scene you want to insert using the video control buttons on the screen, then pause playback. You can fine-adjust one frame at a time with **[<<|>]**.
- (7) Press MARK IN on the screen or MARK on the Remote Commander.
The IN point of the first program is set, and the upper part of the program mark changes to light blue.
- (8) Search for the end of the first scene you want to insert using the video control buttons on the screen, then pause playback. You can fine-adjust one frame at a time with **[<<|>]**.
- (9) Press MARK OUT on the screen or MARK on the Remote Commander.
The OUT point of the first program is set, then the lower part of the program mark changes to light blue.
- (10) Repeat step 6 to 9.
When one program is set, the program mark changes to light blue.
You can set 20 programs in maximum.

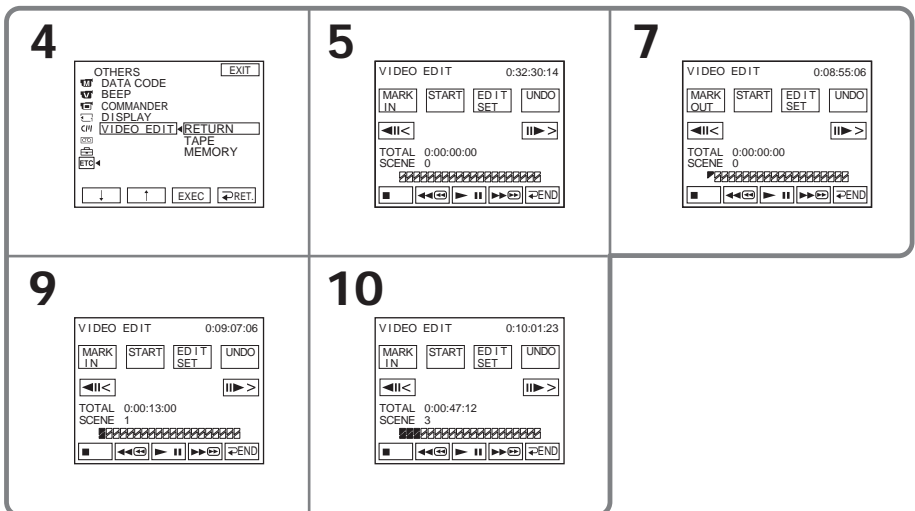

To finish making programs

Press **[END]**.

The program is stored in memory until the tape is ejected.

Dubbing only desired scenes – Digital program editing (on tape)

Note

You cannot operate recording during Digital program editing.

On a blank portion of the tape

You cannot set IN or OUT.

If there is a blank portion between the IN point and the OUT point on the tape

The total time may not be displayed correctly.

Erasing the program you have set

Erase OUT mark first, and then IN mark of the last set program.

- (1) Press UNDO.
- (2) Press ERASE 1 MARK. The last set program mark flashes, then the DELETE ? indicator appears.
- (3) Press EXEC. The last set program is deleted.

To cancel erasing

Press CANCEL in step 3.

Erasing all programs

- (1) Follow the step 2 to 5 on page 84.
- (2) Press UNDO.
- (3) Press ERASE ALL. All the set program marks flash, then the DELETE ? indicator appears.
- (4) Press EXEC. All the set programs are deleted.

To cancel erasing all programs

Press CANCEL in step 4.

Operation 2: Performing Digital program editing (Dubbing the tape)

- (1) When you use a digital video camera recorder, set the power switch of VCR to VCR/VTR.
- (2) Make sure your camcorder and the VCR are connected, and that the VCR is set to recording pause.
When you use an i.LINK cable the following procedure is not necessary.
- (3) Press FN to display PAGE1.
- (4) Press MENU to display the menu.
- (5) Select VIDEO EDIT in , then press EXEC (p. 182).
- (6) Select TAPE, then press EXEC.
- (7) Press START.
- (8) Press EXEC.

Search for the beginning of the first program, then start dubbing.

The program mark flashes.

The SEARCH indicator appears during searching, and the EDITING indicator appears during editing on the screen.

The program mark changes to light blue after the dubbing is complete.

When the dubbing ends, your camcorder and the VCR automatically stop.

To cancel dubbing during editing

Press CANCEL.

To end Digital program editing

Your camcorder stops when the dubbing is complete. Then the display returns to VIDEO EDIT in the menu settings.

Press  END to end the video edit function.

You cannot record on the VCR in the following

Indicator	Cause
No indicator	<ul style="list-style-type: none">• The write-protect tab on the cassette is set to lock.• The IR SETUP code is not correct. (When IR is selected.)• The button to cancel recording pause is not correct. (When IR is selected.)
CHECK "i.LINK" & REC STATUS	<ul style="list-style-type: none">• i.LINK is selected but an i.LINK cable is not connected.• The power of the connected VCR is not turned on. (When i.LINK is selected.)

When the program has not been set

You cannot press START.

Recording video or TV programs

You can record the tape from another VCR or a TV program from a TV that has video/audio outputs. Use your camcorder as a recorder. You can connect either the A/V connecting cable (supplied) or i.LINK cable (optional).

If you connect with the i.LINK cable (optional), video and audio signals are transmitted in digital form for high-quality editing.

Connecting to the VCR or the TV

Connecting with the A/V connecting cable

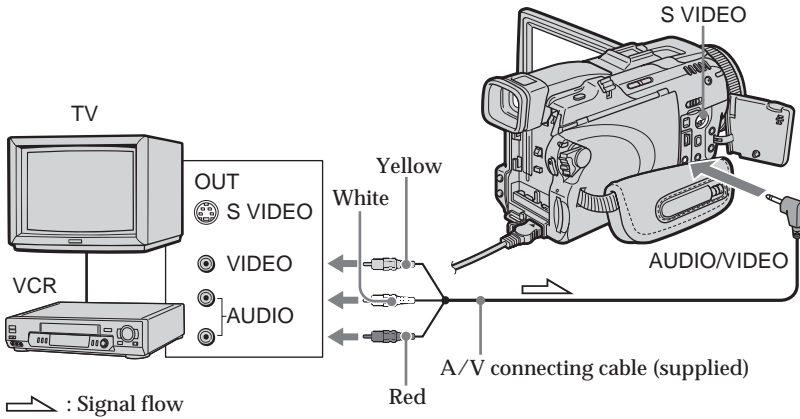

Connecting with the i.LINK cable

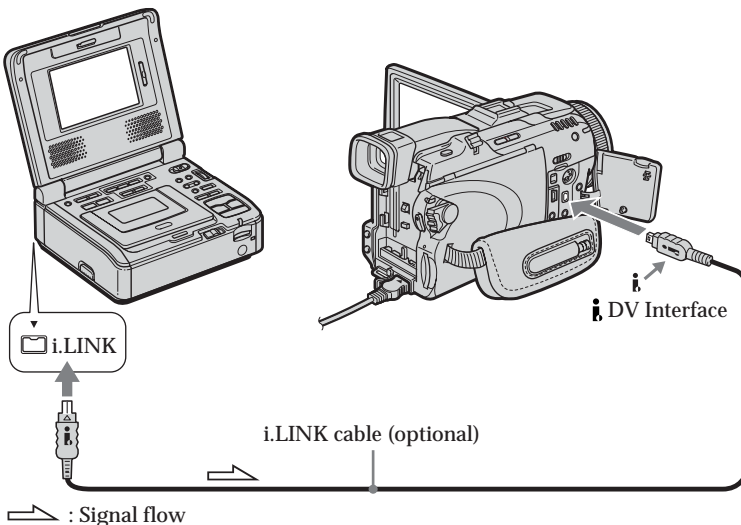

Recording video or TV programs

Recording video or TV programs

Before operation for connecting with the A/V connecting cable

Set DISPLAY in **ETC** to LCD in the menu settings when using the A/V connecting cable. (The default setting is LCD.)

The POWER switch should be set to **VCR**.

Operate by touching the panel.

- (1) Insert the blank tape (or the tape you want to record over) into your camcorder. If you are recording the tape from the VCR, insert the recorded tape into the VCR.
- (2) Press FN and select PAGE3.
- (3) Press REC CTRL.

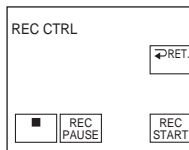

- (4) Press REC PAUSE.
- (5) Press **▶** on the VCR to start playback if you record the tape from a VCR. Select a TV program if you record from a TV. The picture from playback side appears on the screen.
- (6) Press REC START at the scene where you want to start recording from.

When you have finished dubbing the tape

Press **■** on your camcorder, and then press the stop button on the VCR.

Using the Remote Commander

In step 2 to 4, press **●** REC and MARK simultaneously, then immediately press **■**. In step 6, press **■** at the scene where you want to start recording from.

Note on the Remote Commander

Your camcorder works in the commander mode VTR 2. Commander modes 1, 2 and 3 are used to distinguish your camcorder from other Sony VCRs to avoid erroneous remote control operation. If you use another Sony VCR in the commander mode VTR 2, we recommend changing the commander mode or covering the sensor of the VCR with black paper.

If your VCR is a monaural type

Connect the yellow plug of the A/V connecting cable to the video output jack and the white or the red plug to the audio output jack on the VCR or the TV. When the white plug is connected, the left channel audio is output, and when the red plug is connected, the right channel audio is output.

If your VCR has an S video jack

See page 43 for details.

When using the i.LINK cable

- Before recording, make sure if the DV IN indicator appears on the screen. The DV IN indicator may appear on both equipment.
- Recording of only the picture or sound cannot be done.

Download from [Www.Somanuals.com](http://www.Somanuals.com). All Manuals Search And Download.

Inserting a scene from a VCR

- Insert editing

You can insert a new scene with sound from a VCR onto the originally recorded tape by specifying the insert start and end points. Use the Remote Commander for this operation.

Connections are the same as on page 87. Insert a cassette containing the desired scene to insert into the VCR.

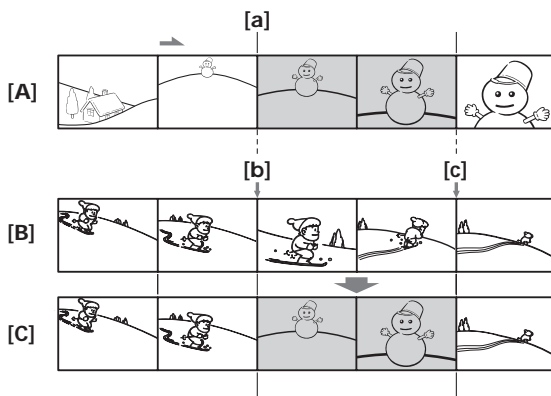

[A] The tape that contains the scene to be superimposed

[B] The tape before editing

[C] The tape after editing

The POWER switch should be set to **VCR**.
Operate by touching the panel.

- (1) On the VCR, locate just before the insert start point [a], then set the VCR to playback pause.
- (2) On your camcorder, locate the insert end point [c], then set it to playback pause.
- (3) Press ZERO SET MEMORY on the Remote Commander. The ZERO SET MEMORY indicator flashes and the end point of the insert is stored in memory. The tape counter shows "0:00:00."
- (4) On your camcorder, locate the insert start point [b].
- (5) Press FN and select PAGE3.
- (6) Press REC CTRL.
- (7) Press REC PAUSE.
- (8) First press **II** on the VCR, and after a few seconds press REC START on your camcorder to start inserting the new scene with sound.
Inserting automatically stops near the zero point on the tape counter. Your camcorder automatically stops recording. The zero set memory function will be canceled.

Inserting a scene from a VCR – Insert editing

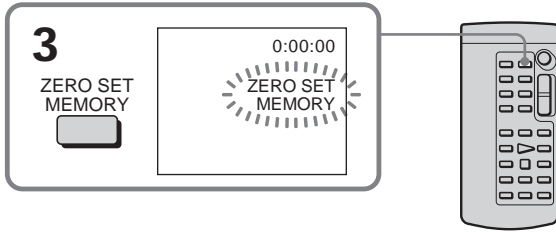

To change the insert end point

Press ZERO SET MEMORY on the Remote Commander again after step 4 to erase the ZERO SET MEMORY indicator and begin from step 2.

Using the Remote Commander

In step 5 to 7, press ● REC and MARK simultaneously, then immediately press ■. In step 8, press ■ at the scene where you want to start recording from.

To insert a scene without setting the insert end point

Skip step 2 and 3. Press ■ on the Remote Commander or ■ on your camcorder when you want to stop inserting.

Audio dubbing

You can record additional audio to the original sound on the tape by connecting audio equipment or a microphone. If you connect the audio equipment, you can add sound to the tape already recorded in the 12-bit mode by specifying starting and ending points. The original sound will not be erased.

Preparing for audio dubbing

You can record additional audio in the following:

- Dubbing with the built-in microphone
- Connecting the microphone (optional) to the MIC jack
- Connecting the microphone (optional) to the intelligent accessory shoe
- Connecting the A/V connecting cable to the AUDIO/VIDEO jack

The audio input to be recorded will take precedence over others in the following order:

- MIC jack
- Intelligent accessory shoe
- AUDIO/VIDEO jack
- Built-in microphone

Dubbing with the built-in microphone

No connection is necessary.

If no external microphone (optional) is connected, sound is recorded via the built-in microphone.

Connecting the microphone (optional) to the MIC jack

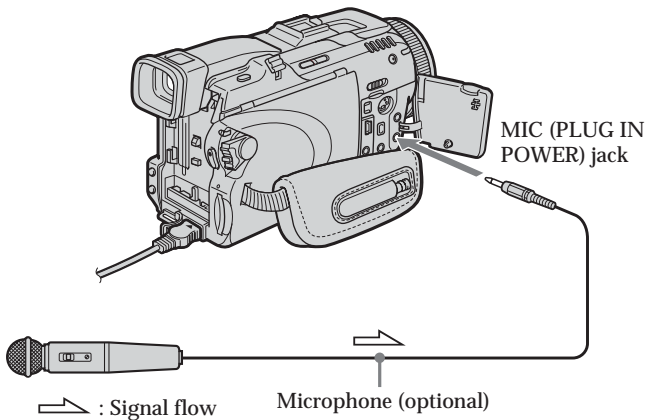

You can check the recorded picture and sound by connecting the AUDIO/VIDEO jack to a TV.

The recorded sound is not output from a speaker. Check the sound by using the headphones or TV.

Audio dubbing

Connecting the microphone (optional) to the intelligent accessory shoe

Install the Microphone after removing the shoe cover.

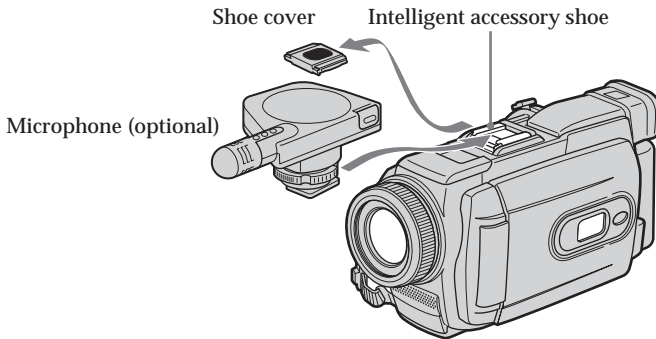

Connecting the A/V connecting cable to the AUDIO/VIDEO jack

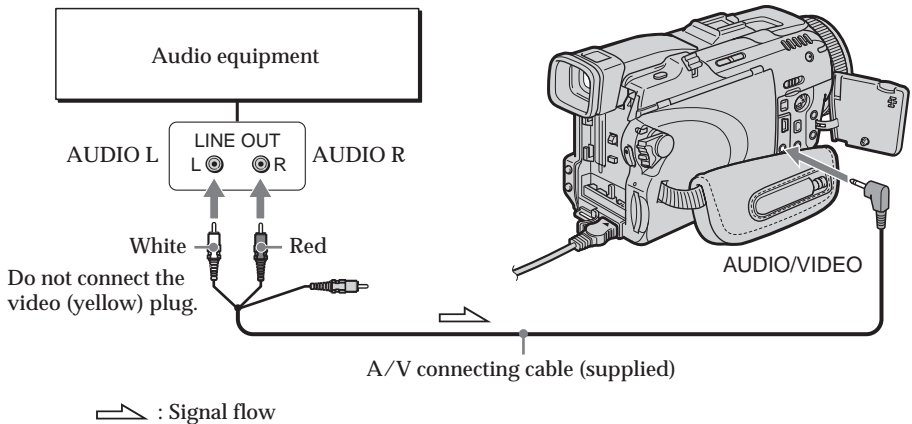

Note

When dubbing with the AUDIO/VIDEO jack or the built-in microphone, pictures are not output through the S VIDEO jack or AUDIO/VIDEO jack. Check the recorded picture on the screen. You can check the recorded sound by using headphones.

Adding an audio sound on the recorded tape

Choose a connection mentioned on page 91, and connect audio equipment or microphone to your camcorder. Then follow the procedure below using the touch panel or the Remote Commander supplied with your camcorder.

Using the touch panel

The POWER switch should be set to **(VCR)**.
Operate by touching the panel.

- (1) Insert the recorded tape into your camcorder.
- (2) Locate the recording start point. Press **[▶▶]** to start playing back. To pause playing back, press **[▶▶]** at the recording start point. You can fine-adjust the recording start point by pressing **[◀◀◀]** / **[▶▶▶]**.
- (3) Press FN and select PAGE3.
- (4) Press A DUB CTRL.

The A DUB CTRL screen appears.

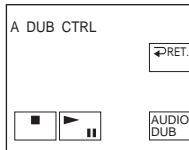

- (5) Press AUDIO DUB. The green **●||** indicator appears on the screen.
- (6) Press **[▶▶]** on your camcorder and at the same time start playing back the audio you want to record.
The new sound is recorded in stereo 2 (ST2) during playback. While recording new sound, the red **●** indicator appears on the screen.
- (7) Press **[■]** on your camcorder at the point where you want to stop recording.

Using the Remote Commander

The POWER switch should be set to **(VCR)**.

- (1) Follow the step 1 and 2 in "Using the touch panel."
- (2) Press AUDIO DUB on the Remote Commander.
The green **●||** indicator appears on the screen.
- (3) Press **[||]** on the Remote Commander and at the same time start playing back the audio you want to record.
The new sound is recorded in stereo 2 (ST2) during playback. While recording new sound, the red **●** indicator appears on the screen.
- (4) Press **[■]** on the Remote Commander at the point where you want to stop recording.

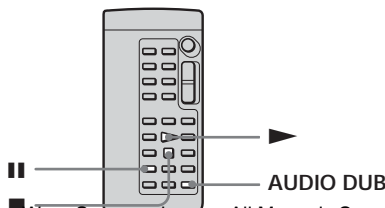

Audio dubbing

You cannot audio dubbing in the following cases:

- The tape recorded in the 16-bit mode
- The tape recorded in the LP mode
- Connecting with the DV Interface
- The blank portions of the tape
- The cassette set the write-protect tab to lock

To add new sound more precisely

Press ZERO SET MEMORY at the point where you want to stop recording later during playback.

Follow the step 2 in "Using the touch panel." Recording automatically stops at the point where ZERO SET MEMORY was pressed.

We recommend that you add new sound on the tape recorded with your camcorder

If you add new sound on the tape recorded with another camcorder (including other DCR-TRV75/TRV80), the sound quality may become worse.

Monitoring the new recorded sound

The POWER switch should be set to **VCR**.

Operate by touching the panel.

- (1) Play back the tape on which you added audio.
- (2) Press FN to display PAGE1.
- (3) Press MENU to display the menu.
- (4) Select AUDIO MIX in **V**, then press EXEC (p. 175).

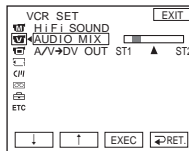

- (5) Press ↓/↑ to adjust the balance between the original sound (ST1) and the new sound (ST2), then press EXEC.

About five minutes after you disconnect the power source or remove the battery pack, the setting of AUDIO MIX returns to the original sound (ST1) only. The default setting is original sound only.

Superimposing a title on a cassette with Cassette Memory





One cassette can have up to about 20 titles, if one title consists of five characters. However, if the Cassette Memory is full with date and cassette label data, one cassette can have only up to about 11 titles with five characters each.

Cassette Memory capacity is as follows:

- Six date data (maximum)
- One cassette label (maximum)

The POWER switch should be set to **CAMERA** or **VCR**. Operate by touching the panel.

- (1) Insert the cassette with Cassette Memory.
- (2) During standby, recording, playback or playback pause, press FN to display PAGE1.
- (3) Press MENU to display the menu.
- (4) Select TITLE in , then press EXEC (p. 178).
- (5) Select , then press EXEC.
- (6) Select a desired title, then press EXEC. The title appears on the screen.
- (7) If necessary, change the color, size, or position by pressing COLOR, SIZE, POS ↓ or POS ↑.
- (8) Press TITLE OK.
- (9) Press SAVE TITLE.

During playback, playback pause or recording:

The TITLE SAVE indicator appears on the screen for about five seconds and the title is set.

During recording standby:

The TITLE indicator appears. And when you press START/STOP to start recording, the TITLE SAVE indicator appears on the screen for about five seconds and the title is set.

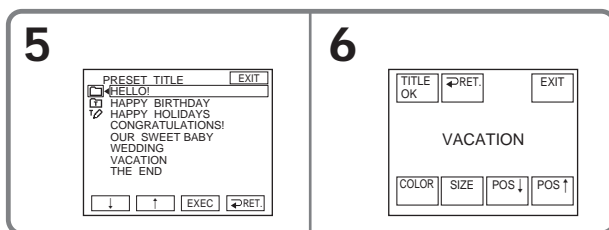

Superimposing a title on a cassette with Cassette Memory

To use the custom title

If you want to use the custom title, select  in step 5.

The titles superimposed with your camcorder

- They appear only by DV ^{Mini} DV format video equipment with index titler function.
- The point you superimposed the title may be detected as an index signal when searching a recording with other video equipment.

To not display title

Set TITLE DSPL to OFF in the menu settings (p. 178).

Title setting

- The title color changes as follows:

→ WHITE → YELLOW → VIOLET → RED → CYAN → GREEN → BLUE →

- The title size changes as follows:

SMALL ↔ LARGE



You cannot input 13 characters or more in LARGE size.

- The title position as follows:

If you select the title size SMALL, you have nine choices for the title position.

If you select the title size LARGE, you have eight choices for the title position.

Erasing a title

The POWER switch should be set to  or .

Operate by touching the panel.

- (1) Press FN to display PAGE1.
- (2) Press MENU to display the menu.
- (3) Select TITLEERASE in , then press EXEC (p. 178). The TITLE ERASE screen appears.
- (4) Select the title you want to erase, then press EXEC.
The ERASE OK? indicator appears.
- (5) Make sure the title is the one you want to erase, then press OK.
The ERASING indicator flashes on the screen.
When the title is erased, the COMPLETE indicator appears.

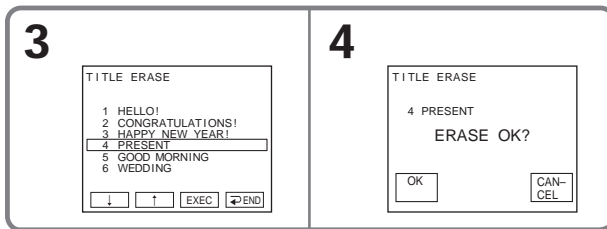

To return to FN

Press EXIT.

To cancel erasing

Press CANCEL in step 5.

Making your own titles

You can make up to two titles and store them in the memory of your camcorder. Each title can have up to 20 characters.

The POWER switch should be set to **CAMERA** or **VCR**.
Operate by touching the panel.

- (1) Press FN to display PAGE1.
- (2) Press MENU to display the menu.
- (3) Select TITLE in **[MENU]**, then press EXEC (p. 178).
- (4) Select **[TITLE]**, then press EXEC.
- (5) Select CUSTOM1 SET or CUSTOM2 SET, then press EXEC.
- (6) Select a desired character. Repeat pressing a key to select a desired character on the key.
- (7) Press **→** to move the cursor for the next character. Repeat the same procedure as step 6 and 7 to complete your title.
- (8) Press SET. The title is stored in memory.

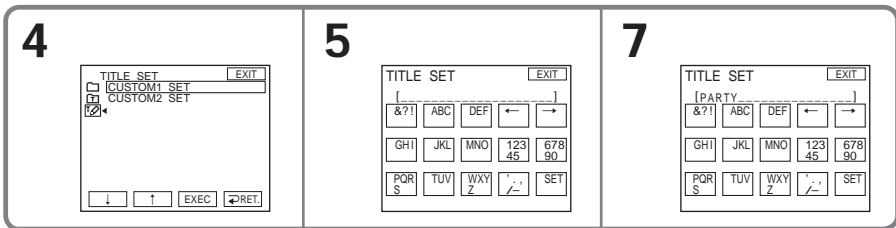

To return to FN

Press EXIT.

To change a title you have stored

In step 5, select CUSTOM1 SET or CUSTOM2 SET, depending on which title you want to change, then press EXEC and enter the new title as desired.

If you take five minutes or longer to enter characters during tape recording standby with the cassette inserted in your camcorder

The power automatically goes off. The characters you have entered remain stored in memory. Set the POWER switch to OFF (CHG) once and then to CAMERA again, then start again from step 1.

We recommend setting the POWER switch to VCR or removing the cassette so that your camcorder does not automatically turn off while you are entering title characters.

To erase the character

Press **←**. The last character is erased.

To enter a space

Press **→**.

Labeling a cassette on a cassette with Cassette Memory

The label can consist of up to 10 characters and are stored in Cassette Memory. When you insert the labeled cassette with the POWER switch set to CAMERA, or the POWER switch is set to VCR, the label is displayed for about five seconds.

The POWER switch should be set to **CAMERA** or **VCR**.
Operate by touching the panel.

- (1) Insert the cassette with Cassette Memory you want to label.
- (2) Press FN to display PAGE1.
- (3) Press MENU to display the menu.
- (4) Select TAPE TITLE in **[CM]**, then press EXEC (p. 178). The TAPE TITLE screen appears.
- (5) Select a desired character. Repeat pressing a key to select a desired character on the key.
- (6) Press → to move the cursor for the next character. Repeat the same procedure as step 5 and 6 to complete the label.
- (7) Press SET. The label is stored in memory.

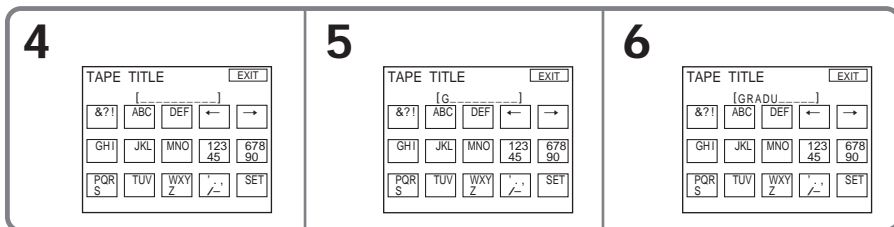

To return to FN

Press EXIT.

To erase the label you have made

Select ← to erase the label in step 5, then press SET.

To change the label you have made

Insert the cassette to change the label, and operate in the same way to make a new label.

If you have superimposed titles in the cassette

When the label appears, up to four titles also appear.

To erase the character

Press ←. The last character is erased.

To enter a space

Press →.

Erasing all the data in Cassette Memory

The following data saved in Cassette Memory can be completely erased once:

- Date data
- Title data
- Cassette label

The POWER switch should be set to **CAMERA** or **VCR**.

Operate by touching the panel.

- (1) Press FN to display PAGE1.
- (2) Press MENU to display the menu.
- (3) Select ERASE ALL in **[CM]**, then press EXEC (p. 178).
- (4) Select OK, then press EXEC.
- (5) Select EXECUTE, then press EXEC. The ERASING indicator flashes on the screen. Once erasing is complete, the COMPLETE indicator appears.

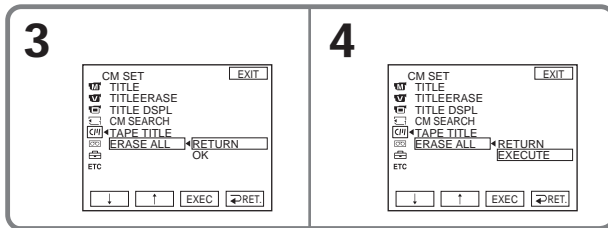

To return to FN

Press EXIT.

To cancel erasing

Select RETURN in step 5, then press EXEC.

Using “Memory Stick” – Introduction

The “Memory Stick” is a new light and small recording media which, despite of the size, can store greater data than a floppy disk.

The “Memory Stick” can, in addition to recording images and easily playing back images you want to see, follow operations such as:

- Copying images into the “Memory Stick” from the tape
- Capturing images into the computer using the supplied USB cable
- Allow image deletion, protection and writing (with a print mark).

File format

Still image (JPEG)

Your camcorder compresses and records image data in JPEG (Joint Photographic Experts Group) format. The file extension is .jpg.

Exif *Ver.2.2 JPEG compliant, DPOF compatible.

*Exif: Exif is a file format for still images, established by the Japan Electronics and Information Technology Industries Association (JEITA). Files in this format can have additional information such as your camcorder’s setting information at the time of recording.

Moving picture (MPEG)

Your camcorder compresses and records picture data in MPEG (Moving Picture Expert Group) format. The file extension is .mpg.

Typical image data file name

Still image

101-0001: This file name appears on the screen of your camcorder.

DSC00001.JPG: This file name appears on the display of a computer.

Moving picture

MOV00001: This file name appears on the screen of your camcorder.

MOV00001.MPG: This file name appears on the display of a computer.

To prevent from erasing images accidentally

Rear part of the “Memory Stick”

Slide the write-protect tab on the “Memory Stick” to LOCK.

The position and shape of the write-protect tab may be different depending on the model.

Some kinds of “Memory Stick” have no write-protect tab.

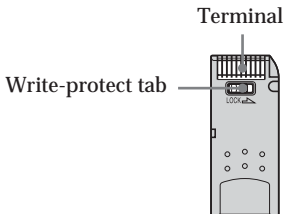

Notes on the “Memory Stick”

Labeling position

Stick its label on the labeling position.

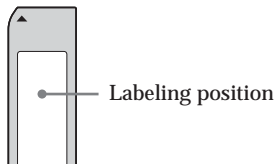

Using “Memory Stick” – Introduction

Image data may be damaged in the following cases. Damaging image data is not guaranteed

- If you eject the “Memory Stick” or turn off your camcorder while reading the image file from the “Memory Stick” or recording data onto the “Memory Stick” (while the access lamp is lit or flashing).
- If you use the “Memory Stick” near magnets or magnetic fields such as those of speakers and TV.

We recommend backing up important data on the hard disk of a computer.

On handling

- When you carry or store the “Memory Stick,” put it in its case.
- Prevent metallic objects or your finger from coming into contact with the metal parts of the connecting section.
- Do not bend, drop or apply strong shock to the “Memory Stick.”
- Do not disassemble or modify the “Memory Stick.”
- Do not let the “Memory Stick” get wet.

On location for use

Do not use or keep the “Memory Stick” in locations that are:

- Extremely hot such as in a car parked in the sun or under the scorching sun
- Under direct sunlight
- Very humid or subject to corrosive gases

The “Memory Stick” formatted by a computer

The “Memory Stick” formatted by Windows OS or Macintosh computers does not have a guaranteed compatibility with your camcorder.

Note on the “MagicGate Memory Stick”

You can use the “MagicGate Memory Stick” for recording image data on your camcorder. However, you cannot record or play back the music protected by copyright signals on your camcorder.

Notes on using the “Memory Stick Duo”

- Be sure to insert the “Memory Stick Duo” into the “Memory Stick Duo” Adaptor when using the “Memory Stick Duo” with your camcorder.
- Verify that the insert direction of the “Memory Stick Duo.” The use of wrong direction may cause a malfunction.
- Do not insert the “Memory Stick Duo” not inserted into the “Memory Stick Duo” Adaptor into the “Memory Stick”-compatible unit. This may cause a malfunction of the unit.

Notes on image data compatibility

- Image data files recorded on the “Memory Stick” by your camcorder conform with the Design Rules for Camera File Systems universal standard established by the JEITA (Japan Electronics and Information Technology Industries Association).
On your camcorder, you cannot play back still images recorded on other equipment (DCR-TRV890E/TRV900/TRV900E or DSC-D700/D770) that does not conform to this universal standard. (These models are not sold in some areas.)
- If you cannot use the “Memory Stick” that is used with other equipment, format it with your camcorder (p. 177). Note that formatting erases all information on the “Memory Stick.”
- Some playback devices may not be able to play back images recorded with your camcorder.
- You may not be able to play back images with your camcorder:
 - When playing back image data modified on a computer
 - When playing back image data shot with other equipment

Using “Memory Stick” – Introduction

- The “Memory Stick,”  and “MagicGate Memory Stick” are trademarks of Sony Corporation.
- “Memory Stick Duo” and **MEMORY STICK DUO** are trademarks of Sony Corporation.
- “MagicGate” and **MAGICGATE** are trademarks of Sony Corporation.
- All other product names mentioned herein may be the trademarks or registered trademarks of their respective companies.
Furthermore, “™” and “®” are not mentioned in each case in this manual.

Inserting the “Memory Stick”

Insert the “Memory Stick” in the “Memory Stick” slot as far as it can go with the ► mark facing as illustrated.

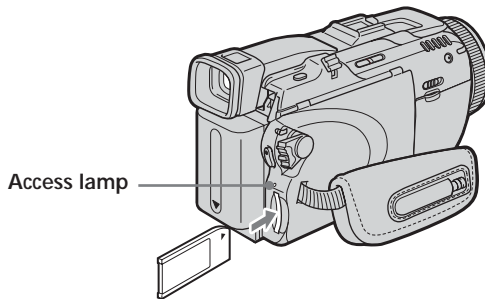

Ejecting the “Memory Stick”

Press the “Memory Stick” once lightly.

Notes

- If you insert the “Memory Stick” forcibly in the opposite direction, the “Memory Stick” slot may be damaged.
- Do not insert anything other than the “Memory Stick” into the “Memory Stick” slot. This may cause a malfunction.

While the access lamp is lit or flashing

Do not shake or strike your camcorder because your camcorder is reading the data from the “Memory Stick” or recording the data on the “Memory Stick.” Do not turn the power off, eject the “Memory Stick” or remove the battery pack. Otherwise, image data breakdown may occur.

If “ MEMORY STICK ERROR” appears

Reinsert the “Memory Stick” a few times. The “Memory Stick” may be damaged if the indicator still appears. If this occurs, use another “Memory Stick.”

Selecting the quality and size of image data

Selecting still image quality

The default setting is FINE.

The POWER switch should be set to (MEMORY) or (VCR).
Operate by touching the panel.

- (1) Press FN to display PAGE1.
- (2) Press MENU to display the menu.
- (3) Select STILL SET in , then press EXEC (p. 176).
- (4) Select QUALITY, then press EXEC.
- (5) Select a desired image quality, then press EXEC.

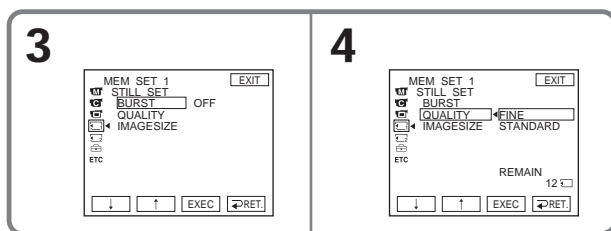

Setting	Meaning
FINE (FINE)	Use this mode when you want to record high quality images. Fine images are compressed to about 1/4.
STANDARD (STD)	This is the standard image quality. Standard images compressed to about 1/10.

To return to FN

Press EXIT.

Selecting the quality and size of image data

Selecting the still image size

You can select image size 1600 × 1200 or 640 × 480 (When the POWER switch is set to CAMERA or VCR, the image size is automatically set to 640 × 480.).
The default setting is 1600 × 1200.

The POWER switch should be set to **(MEMORY)**.
Operate by touching the panel.

- (1) Press FN to display PAGE1.
- (2) Press MENU to display the menu.
- (3) Select STILL SET in , then press EXEC (p. 176).
- (4) Select IMAGESIZE, then press EXEC.
- (5) Select a desired image size, then press EXEC.

The indicator changes as follow:

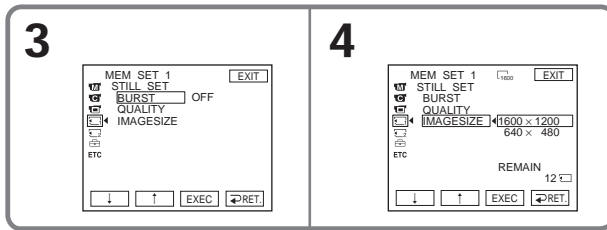

Memory capacity of still images

Recorded images are compressed in JPEG format before being stored in memory. The memory capacity of still images varies depending on the selected image quality mode and image size. Details are shown in the table below.

1600 × 1200 image size

Image quality	Memory capacity
FINE	About 960 KB
STANDARD	About 420 KB

640 × 480 image size

Image quality	Memory capacity
FINE	About 150 KB
STANDARD	About 60 KB

Selecting the quality and size of image data

Selecting the moving picture size

You can select picture size 320 × 240 or 160 × 112.
The default setting is 320 × 240.

The POWER switch should be set to **(MEMORY)** or **(VCR)**.
Operate by touching the panel.

- (1) Press FN to display PAGE1.
- (2) Press MENU to display the menu.
- (3) Select MOVIE SET in , then press EXEC (p. 176).
- (4) Select IMAGESIZE, then press EXEC.
- (5) Select a desired image size, then press EXEC.

The indicator changes as follow:

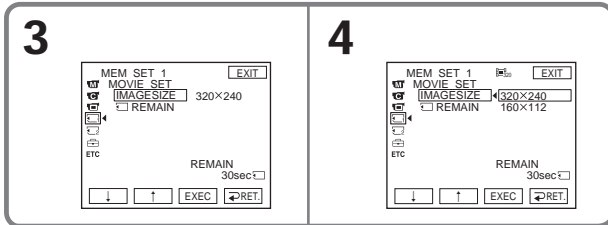





Selecting the quality and size of image data

Approximate number of still images and time of moving pictures that can be recorded on one "Memory Stick"



The number of still images and the time of moving pictures you can record vary depending on which image quality mode you select and the complexity of the subject.

Still images

(Unit: Image)

Type of "Memory Stick"	FINE		STANDARD	
	1600 × 1200 	640 × 480 	1600 × 1200 	640 × 480 
8MB (supplied)	8	50	18	120
16MB (optional)	16	96	37	240
32MB (optional)	32	190	75	485
64MB (optional)	65	390	150	980
128MB (optional)	130	780	300	1970

Moving pictures

Type of "Memory Stick"	Image size	
	320 × 240 	160 × 112 
8MB (supplied)	1 min. 20 sec.	5 min. 20 sec.
16MB (optional)	2 min. 40 sec.	10 min. 40 sec.
32MB (optional)	5 min. 20 sec.	21 min. 20 sec.
64MB (optional)	10 min. 40 sec.	42 min. 40 sec.
128MB (optional)	21 min. 20 sec.	1 hr 25 min. 20 sec.

The table shows approximate number of still images and time of moving pictures that can be recorded on the "Memory Stick" formatted with your camcorder.

Recording still images on “Memory Stick” – Memory Photo recording

The POWER switch should be set to (MEMORY).

- (1) Keep pressing PHOTO lightly and check the image. The green ● indicator stops flashing, then lights up. The brightness of the image and the focus are adjusted and fixed while your camcorder targets at the middle of the image. Recording does not start yet.
- (2) Press PHOTO deeply.
Recording is complete when the bar scroll indicator disappears.
The image displayed on the screen when you pressed PHOTO deeply will be recorded on the “Memory Stick.”

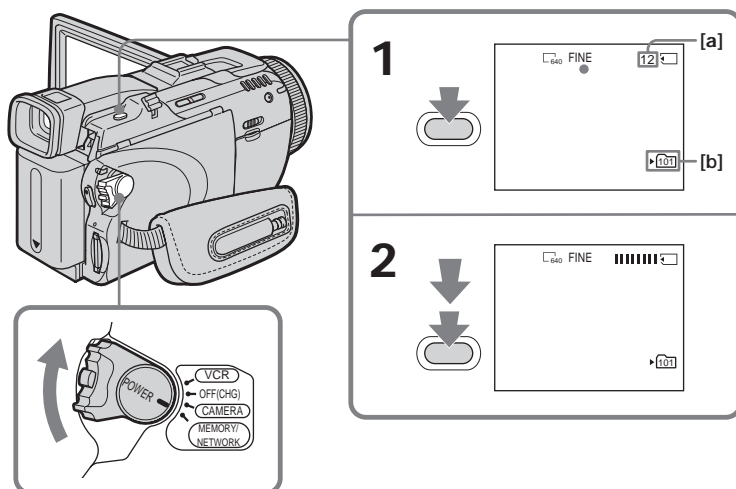

- [a] Approximate number of images can be recorded on the “Memory Stick”
[b] Folder name to be recorded

Recording still images on "Memory Stick" - Memory Photo recording

You can record still images on the "Memory Stick" during tape recording or tape recording standby

See page 44 for details.

When the POWER switch is set to MEMORY

The following functions do not work:

- Digital zoom
- Super NightShot
- Color Slow Shutter
- Wide mode
- Fader
- Picture effect
- Digital effect
- SPORTS or PROGRAM AE (The indicator flashes.)
- Title
- SteadyShot

During saving a still image data

You cannot turn off the power or press PHOTO.

When you press PHOTO on the Remote Commander

Your camcorder immediately records the image that is on the screen when you press the button.

When you press PHOTO lightly in step 1

The image momentarily flickers. This is not a malfunction.

Recording data

The recording data (date/time or various settings when recorded) do not appear during recording. However, they are recorded automatically onto the "Memory Stick." To display the recording data, press DATA CODE during playback. You can also use the Remote Commander for this operation (p. 38).

If you record still images when the POWER switch is set to MEMORY

The angle of view is slightly larger compared with the angle of view when the POWER switch is set to CAMERA.

Recording still images on “Memory Stick” – Memory Photo recording

Recording images continuously

You can record still images continuously. Before recording, select a desired mode described below in the menu settings.

NORMAL [a] ()

Your camcorder shoots up to four still images in 1600 × 1200 size or 25 still images in 640 × 480 size at about 0.5 sec intervals.

HIGH SPEED [a] ()

Your camcorder shoots up to 32 still images in 640 × 480 size at about 0.07 sec intervals.

EXP BRKTG [b] ()

Your camcorder automatically shoots three images at about 0.5 sec intervals at different exposures.

[a]



[b]



The POWER switch should be set to **(MEMORY)**.
Operate by touching the panel.

- (1) Press FN to display PAGE1.
- (2) Press MENU to display the menu.
- (3) Select STILL SET in , then press EXEC (p. 176).
- (4) Select BURST, then press EXEC.

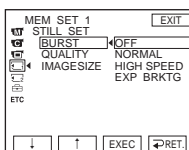

- (5) Select a desired mode, then press EXEC.
- (6) Press EXIT to make the menu display disappear.
- (7) Press PHOTO deeply.

Recording still images on “Memory Stick” - Memory Photo recording

The number of still images in continuous shooting

The number of still images you can shoot continuously varies depending on the image size and the capacity of the “Memory Stick.”

During continuous recording of images

The flash does not work.

When shooting with the self-timer or the Remote Commander

Your camcorder automatically records up to the maximum number of still images.

When selecting HIGH SPEED

Flickering or changes in color may occur.

If remaining capacity on the “Memory Stick” is less than for three images

EXP BRKTG does not work. “ FULL” appears when you press PHOTO.

The effect of EXP BRKTG

The effect of EXP BRKTG may not be noticeable on the screen.

We recommend viewing images on TV or the computer to recognize the effect.

When selecting NORMAL or HIGH SPEED

Recording continues up to the maximum number of still images during pressing PHOTO deeply.

Recording still images on "Memory Stick" - Memory Photo recording

Recording images with the flash

The POWER switch should be set to (MEMORY) or (CAMERA).



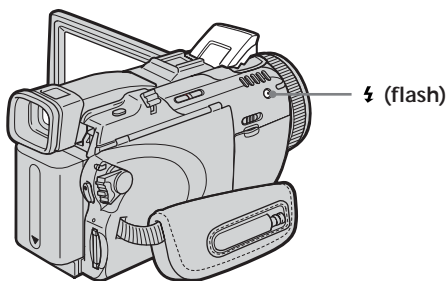

If you press PHOTO, the flash automatically pops up to strobe. The default setting is auto (no indicator). To change the flash mode, press  (flash) repeatedly until the flash mode indicator appears on the screen. You cannot use this function during recording moving pictures.







Each press of  (flash) changes the indicator as follows:

→  →  → AUTO (No indicator)

When you set RED EYE R in  to ON in the menu settings (p. 173), the indicator changes as follows:

→  →   → 

- | | |
|---|--|
|  Forced flash: | The flash fires regardless of the surrounding brightness. |
|  Auto red-eye reduction: | The flash fires before recording to reduce the red-eye. |
|   Forced red-eye reduction: | The flash fires before recording to reduce red-eye regardless of the surrounding brightness. |
|  No flash: | The flash does not fire. |

The amount of flash is automatically adjusted to the appropriate brightness. You can also change FLASH LVL to the desired brightness in the menu settings (p. 173). Try recording various images to find the most appropriate setting for FLASH LVL.

Recording still images on "Memory Stick" - Memory Photo recording

Notes

- Clean any dirt from the flash surface before use. With the heat from the flash firing, dirt can cause discoloration or stick to the flash surface so that the flash does not give off a sufficient amount of light.
- The recommended shooting distance using the built-in flash is 0.3 m to 2.5 m (31/32 feet to 8 1/3 feet).
- Attaching the lens hood (supplied) or a conversion lens (optional) causes lens shadow to appear.
- You cannot use an external flash (optional) and the built-in flash at the same time.
- Auto red-eye reduction (●) and Forced red-eye reduction (●⚡) may not produce the desired effect depending on individual differences, the distance to the subject, the subject not looking at the pre-recording flash or other conditions.
- The flash effect cannot be obtained easily when you use forced flash in a bright location.
- The flash charge lamp flashes while the power for firing is being charged. After charging is complete, the flash charge lamp lights up.
- When recording with the flash with the POWER switch set to CAMERA, it takes longer to prepare for image capture. This is because your camcorder starts to charge power for firing after the flash pops up.
- If it is not easy to focus on a subject automatically, for example, when recording in the dark, use HOLOGRAM AF (p. 113) or the focal distance information (p. 62) for focusing manually.

The flash does not fire even if you select auto and ● (auto red-eye reduction) during the following operations:

- NightShot
- SPOTLIGHT of PROGRAM AE
- SUNSETMOON of PROGRAM AE
- LANDSCAPE of PROGRAM AE
- Manual exposure
- Flexible Spot Meter

During recording images continuously

The flash does not work.

Recording still images on “Memory Stick” – Memory Photo recording

Shooting with an auxiliary light – HOLOGRAM AF

The POWER switch should be set to (MEMORY).

The HOLOGRAM AF is an auxiliary light source used for focusing on subjects in dark places.

Set HOLOGRAM F in  to AUTO in the menu settings. (The default setting is AUTO.)

When **MEMON** appears on the screen in a dark place, press PHOTO lightly. Then the auxiliary light will automatically emit until the subject is focused.

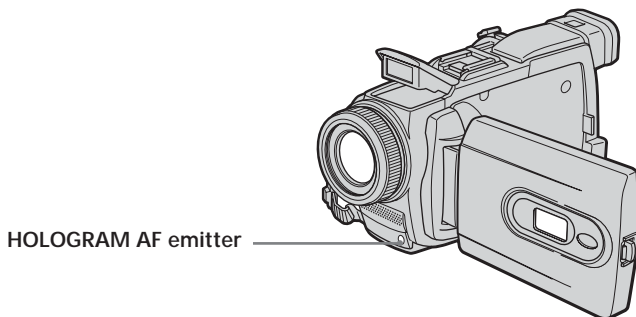

About HOLOGRAM AF

“HOLOGRAM AF (Auto-Focus),” an application of laser holograms, is a new AF optical system that enables still image shooting in dark places. Having gentler radiation than conventional high-brightness LEDs or lamps, the system satisfies Laser Class 1 (*) specification and thus maintains higher safety for human eyes.

No safety problems will be caused by directly looking into the HOLOGRAM AF emitter at a close range. However, it is not recommended to do so, because you may experience such effects like several minutes of image residual and dazzling, that you encounter after looking into a flashlight.

* HOLOGRAM AF satisfies Class 1 (time base 30,000 seconds), specified in all of JIS (Japan), IEC (EU), and FDA (US) industry standards.

Complying with these standards identifies the laser product to be safe, under a condition that a human looks at the laser light either directly or even through a lens for 30,000 seconds.

Notes

- A conversion lens (optional) may obstruct the HOLOGRAM AF light and make focusing difficult.
- If enough light does not reach the subject even if the HOLOGRAM AF emitter is emitted (recommended shooting distance is up to 2.5 m (8 1/3 feet)), the subject will not be focused.

The HOLOGRAM AF does not emit in the following cases:

- When the POWER switch is set to CAMERA
- NightShot
- Flash is set to  (no flash)
- SUNSETMOON of PROGRAM AE
- LANDSCAPE of PROGRAM AE
- Manual focus
- Spot Focus
- Continuous photo recording

Recording an image from tape as a still image

Your camcorder can read moving picture data recorded on a tape and record it as a still image on the "Memory Stick."
Image size is automatically set to 640 × 480.

Before operation

Insert the "Memory Stick" and the recorded tape into your camcorder.

The POWER switch should be set to **(VCR)**.
Operate by touching the panel.

- (1) Press . The picture recorded on the tape is played back.
- (2) Keep pressing PHOTO lightly and check the image. The picture from the tape freezes and the CAPTURE indicator appears on the screen. Recording does not start yet.
To change the still image, release PHOTO, select a still image again, and then press and hold PHOTO lightly.
- (3) Press PHOTO deeply. Recording is complete when the bar scroll indicator disappears. The image displayed on the screen when you pressed PHOTO deeply will be recorded on the "Memory Stick."

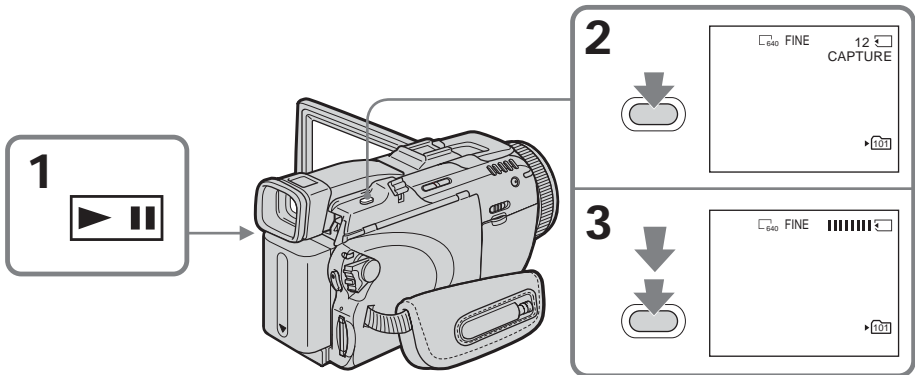

Sound recorded on the tape

You cannot record audio from the tape.

Title

You cannot record the titles.

Recording date/time

The date/time when it is recorded on the "Memory Stick" is recorded. Various settings are not recorded.

When you press PHOTO on the Remote Commander

Your camcorder immediately records the image that is on the screen when you press the button.

Recording an image from tape as a still image

Recording a still image from other equipment

You can use either A/V connecting cable or i.LINK cable. Connect the devices as illustrated on page 87.

When connecting with the A/V connecting cable, set DISPLAY in **ETC** to LCD in the menu settings. (The default setting is LCD.)

The POWER switch should be set to **VCR**.

- (1) Play back the recorded tape, or turn the TV on to see a desired program.
The image of the other equipment is displayed on the LCD screen or in the viewfinder.
- (2) At the point where you want to record, follow the step 2 and 3 on page 114.

Note

If recording from a tape in poor condition, such as one that has been reused often for recording, you may be unable to record still images, or the still images you do record may be distorted.

Superimposing a still image in “Memory Stick” on an image – MEMORY MIX

You can superimpose a still image you have recorded on the “Memory Stick” on top of the moving picture you are recording. (However you cannot superimpose a still image onto the moving picture you have finished recording.) You can record the superimposed images on the tape or the “Memory Stick.” (However, you can record only superimposed still images on the “Memory Stick.”)

M. CHROM (Memory Chroma key)

You can swap only the blue area of a still image such as an illustration or a frame with a moving picture.

M. LUMI (Memory Luminance key)

You can swap the brighter area of a still image (such as a handwritten illustration or a title) with a moving picture. To use this function, we recommend recording a title on the “Memory Stick” before a trip or event.

C. CHROM (Camera Chroma key)

You can superimpose a moving picture on top of a still image such as an image which can be used as background. Shoot the subject against a blue background. Only the blue area of the moving picture will be swapped with a still image.

M. OVERLAP (Memory Overlap)*

You can make a moving picture recording with your camcorder fade in on top of a still image recorded on the “Memory Stick.”

M. CHROM

M←CAM
CHROM

Still image



Blue

+

Moving picture



→



M. LUMI

M←CAM
LUMI

Still image



+

Moving picture



→



C. CHROM

CAM←M
CHROM

Still image

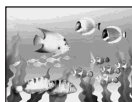

+

Moving picture



→

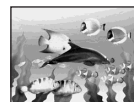

Blue

M. OVERLAP*

OVER-
LAP

Still image



→



→



Moving picture

Superimposing a still image in “Memory Stick” on an image – MEMORY MIX

The “Memory Stick” supplied with your camcorder stores 20 images:

- For M. CHROM: 18 images (such as a frame) 101-0001 to 101-0018
- For C. CHROM: two images (such as a background) 101-0019 to 101-0020

Sample images

Sample images stored in the “Memory Stick” supplied with your camcorder are protected (p. 135).

Notes

- You cannot use MEMORY MIX for moving pictures recorded on the “Memory Stick.”
- When the overlapping still image has a large amount of white, the thumbnail image of the picture may not be clear.
- In the mirror mode (p. 29), the picture on the LCD screen is not a mirror-image.

Image data modified on a computer

You may not be able to play modified images back with your camcorder.

Recording a superimposed image to the tape

Before operation

- Insert the “Memory Stick” recorded with still images into your camcorder.
- Insert the tape for recording into your camcorder.

The POWER switch should be set to **CAMERA**.

Operate by touching the panel.

- (1) Press FN and select PAGE2.
- (2) Press MEM MIX. The image recorded on the “Memory Stick” appears in the lower right corner of the screen.
- (3) Press – (to see the previous image)/+ (to see the next image) in the lower right corner of the screen to select the still image that you want to superimpose.
- (4) Press a desired mode. The still image is superimposed on the moving picture during recording standby.
- (5) Press –/+ in the lower left corner of the screen to adjust the effect, then press **OK** to return to PAGE2.

M. CHROM – The color (blue) scheme of the area in the still image which is to be swapped with a moving picture

M. LUMI – The color (bright) scheme of the area in the still image which is to be swapped with a moving picture

C. CHROM – The color (blue) scheme of the area in the moving picture which is to be swapped with a still image

M. OVERLAP* – No adjustment necessary

* You can select M. OVERLAP when the POWER switch is set to CAMERA.

- (6) Press EXIT to return to FN.
- (7) Press START/STOP to start recording.

Superimposing a still image in “Memory Stick” on an image - MEMORY MIX

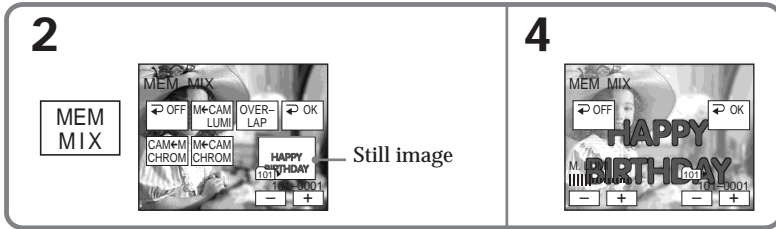

To change the still image to be superimposed

Press $-/+$ in the lower right corner before step 5.

To cancel MEMORY MIX

Press \rightarrow OFF to return to PAGE2.

Note

During recording you cannot reselect the mode. Press \rightarrow OFF to return to PAGE2.

When you select M. OVERLAP

You cannot change the still image or the mode.

During recording

You cannot change the mode.

Recording a superimposed image to the “Memory Stick” as a still image

Before operation

Insert the “Memory Stick” recorded with still images into your camcorder.

The POWER switch should be set to **(MEMORY)**.

Operate by touching the panel.

(1) Follow the step 1 to 6 on page 117.

(2) Press PHOTO deeply to start recording.

Recording is complete when the bar scroll indicator disappears. The image displayed on the screen when you pressed PHOTO deeply will be recorded on the “Memory Stick.”

To cancel MEMORY MIX

Press \rightarrow OFF to return to PAGE2.

Image size of still images

Image size is automatically set to 640×480 .

To record still images as-is to the tape

Press $-/+$ in the lower left corner of the screen in M. LUMI mode and keep going until the bar display on the right is full.



Interval Photo Recording

You can carry out a time-lapse recording by setting the camcorder to automatically record still images.

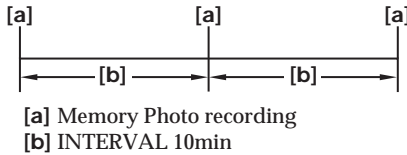
Example



The POWER switch should be set to **(MEMORY)**.
Operate by touching the panel.

- (1) Press FN to display PAGE1.
- (2) Press MENU to display the menu.
- (3) Select INT. R -STL in , then press EXEC (p. 177).
- (4) Select SET, then press EXEC.
- (5) Select INTERVAL, then press EXEC.
- (6) Select a desired interval time, then press EXEC.
- (7) Press  RET.
- (8) Set INT. R -STL to ON, then press EXEC.
- (9) Press EXIT to return to FN.

The INTERVAL MEM STILL indicator flashes on the screen.

- (10) Press PHOTO deeply.

Interval Photo Recording starts.

The INTERVAL MEM STILL indicator lights up on the screen during Interval Photo Recording.

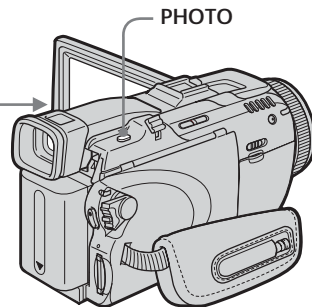
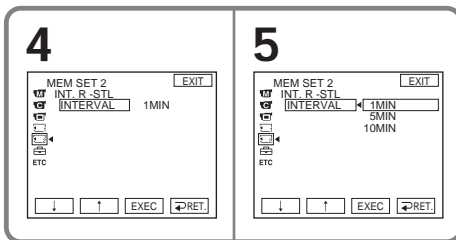

To cancel Interval Photo Recording

Set INT. R -STL to OFF in the menu settings.

Note

Interval Photo Recording is canceled if you press IMAGE TRANS during Interval Photo Recording.

Recording moving pictures on “Memory Stick” – MPEG MOVIE recording

The picture and sound are recorded up to the full capacity of the “Memory Stick” (MPEG MOVIE EX).

The POWER switch should be set to **MEMORY**.

Press **START/STOP**

Your camcorder starts recording. The camera recording lamp located on the front of your camcorder lights up.

The picture and sound are recorded up to the capacity of the “Memory Stick.” See page 106 for details of recording time.

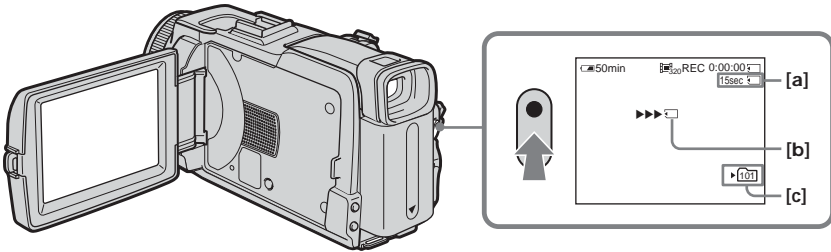

[a] Available recording time on the “Memory Stick”

[b] This indicator appears for five seconds after pressing **START/STOP**. This indicator is not recorded.

[c] Folder name to be recorded

To stop recording

Press **START/STOP**.

Recording moving pictures on “Memory Stick” – MPEG MOVIE recording

Note

Sound is recorded in monaural.

When the POWER switch is set to MEMORY

The following functions do not work:

- Digital zoom
- Super NightShot
- Color Slow Shutter
- Wide mode
- Fader
- Picture effect
- Digital effect
- SPORTS of PROGRAM AE (The indicator flashes.)
- Title
- SteadyShot

When using an external flash (optional)

Turn the power of the external flash off when recording moving pictures on the “Memory Stick.” Otherwise, the charging sound of the flash may be recorded.

Recording date/time

The date/time do not appear during recording. However, they are automatically recorded onto the “Memory Stick.” To display the recording date/time, press DATA CODE during playback. Various settings cannot be recorded (p. 38).

Self-timer recording

You can record moving pictures on the “Memory Stick” with the self-timer. See page 122 for details.

Self-timer recording

You can record still images and moving pictures on the “Memory Stick” with the self-timer. You can also use the Remote Commander for this operation.

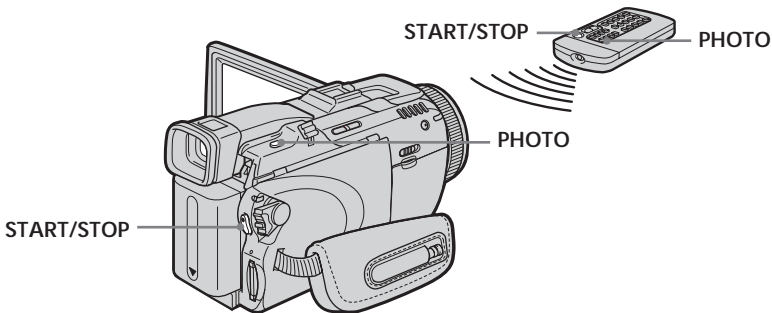

Recording a still image

The POWER switch should be set to **MEMORY**.
Operate by touching the panel.

- (1) Press FN and select PAGE2.
- (2) Press SELFTIMER.

The  (self-timer) indicator appears on the screen.

- (3) Press EXIT to return to FN.
- (4) Press PHOTO deeply.

The self-timer starts counting down from about 10 with a beep. In the last two seconds of the countdown, the beep gets faster, then recording starts automatically.

Recording a moving picture

The POWER switch should be set to **MEMORY**.
Operate by touching the panel.

- (1) Follow the step 1 to 3 in “Recording a still image.”
- (2) Press START/STOP.

The self-timer starts counting down from about 10 with a beep. In the last two seconds of the countdown, the beep gets faster, then recording starts automatically.

To stop the countdown for recording moving picture

Press START/STOP. To restart the countdown, press START/STOP again.

To cancel the self-timer

With your camcorder during standby, press SELFTIMER and the  (self-timer) indicator disappears from the screen. You cannot cancel the self-timer using the Remote Commander.

Note

The self-timer recording is automatically canceled when self-timer recording is finished.

Recording a picture from tape as a moving picture



Your camcorder can read moving picture data recorded on a tape and record it as a moving picture on the “Memory Stick.”

Before operation

Insert the recorded tape into your camcorder.

The POWER switch should be set to **(VCR)**.

Operate by touching the panel.

- (1) Press . The picture recorded on the tape is played back.
- (2) Press  again to pause playback at the scene where you want to start recording from.
- (3) Press START/STOP. Images and sound are recorded up to the remaining capacity of the “Memory Stick.” See page 106 for details of recording time.

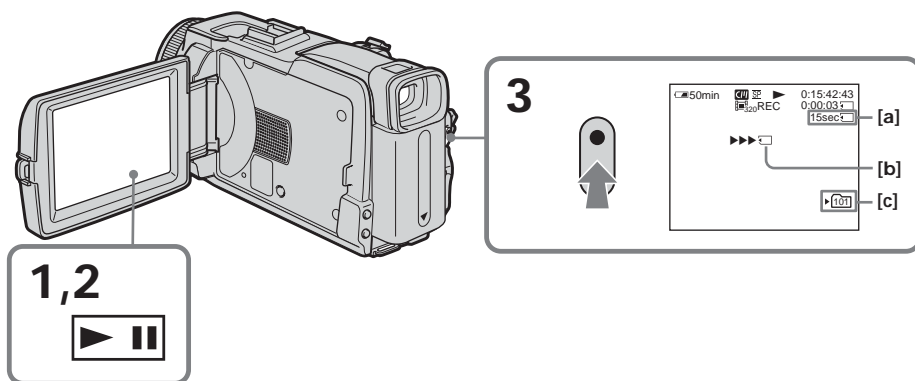

[a] Available recording time on the “Memory Stick”

[b] This indicator appears for five seconds after pressing START/STOP. This indicator is not recorded.

[c] Folder name to be recorded

To stop recording

Press START/STOP.

Notes

- Sound recorded in 48 kHz is converted to one in 32 kHz when recording images from the tape to the “Memory Stick.”
- Sound recorded in stereo is converted to monaural sound when recording from the tape.

Titles

You cannot record the titles.

If the  **AUDIO ERROR** indicator appears

Sound that cannot be recorded by your camcorder has been recorded. Connect the A/V connecting cable to input images played back on an external device (p. 124).

Recording date/time

The date/time when it is recorded on the “Memory Stick” are recorded. Various settings are not recorded.

Download from www.Somanuals.com. All Manuals Search And Download.

Recording a picture from tape as a moving picture

Recording a moving picture from other equipment

You can use either A/V connecting cable or i.LINK cable. Connect the devices as illustrated on page 87.

When connecting with the A/V connecting cable, set DISPLAY in  to LCD in the menu settings. (The default setting is LCD.)

The POWER switch should be set to .

(1) Play back the recorded tape on the VCR, or turn the TV on to see a desired program.

The image of the other equipment is displayed on the LCD screen or in the viewfinder.

(2) Press START/STOP at the scene where you want to start recording from.

Note

In the following instances, recording may stop in the middle, or distorted images may be recorded:

- If the tape has a blank portion
- If recording from a tape in a poor condition, such as one that has been reused often for recording
- If the input signal is cut off

Recording edited pictures from tape as a moving picture – Digital program editing (on “Memory Stick”)

You can duplicate selected scenes (programs) for editing onto the “Memory Stick.”

Making the program

The POWER switch should be set to **(VCR)**.
Operate by touching the panel.

- (1) Insert the tape for playback, and the “Memory Stick” for recording into your camcorder.
- (2) Press FN to display PAGE1.
- (3) Press MENU to display the menu.
- (4) Select VIDEO EDIT in **(ETC)**, then press EXEC (p. 182).
- (5) Select MEMORY, then press EXEC.
- (6) Repeat pressing IMAGESIZE to select a desired size. The image size changes when you press IMAGESIZE.
- (7) Follow the step 6 to 10 on page 84.

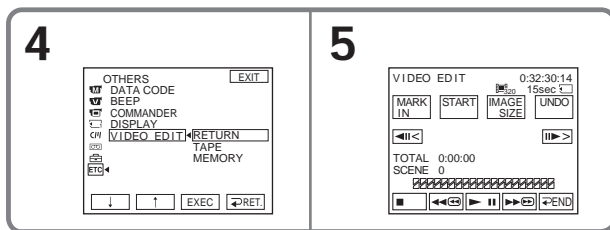

To finish making programs

Press **END**.

The program is stored in memory until the tape is ejected.

Notes

- You cannot dub the titles, display indicators, or the contents of Cassette Memory.
- You cannot operate recording during the Digital program editing on the “Memory Stick.”

On a blank portion of the tape

You cannot set IN or OUT on a blank portion of the tape.

If there is a blank portion between IN and OUT on the tape

The total time may not appear correctly.

During making a program

If you eject the cassette, the NOT READY indicator appears on the screen. The program will be erased.

Erasing the program you have set

See “Erasing the program you have set” on page 85.

Erasing all programs

- (1) Press FN to display PAGE1.
- (2) Press MENU to display the menu.
- (3) Select VIDEO EDIT in **(ETC)**, then press EXEC (p. 182).
- (4) Select MEMORY, then press EXEC.
- (5) Follow the step 2 to 4 on page 85.

Download from www.Somanuals.com. All Manuals Search And Download.

Recording edited pictures from tape as a moving picture - Digital program editing (on "Memory Stick")

Performing the program (Dubbing the "Memory Stick")

The POWER switch should be set to (VCR).
Operate by touching the panel.

- (1) Press FN to display PAGE1.
- (2) Press MENU to display the menu.
- (3) Select VIDEO EDIT in $\overline{\text{VCR}}$, then press EXEC (p. 182).
- (4) Select MEMORY, then press EXEC.
- (5) Press START.
- (6) Press EXEC.

Your camcorder searches for the beginning of the first program, then starts dubbing.

The program mark flashes.

The SEARCH indicator appears during searching, the EDITING indicator appears during writing of data on your camcorder, and the REC indicator appears during dubbing on the screen.

The program mark changes to light blue after dubbing is complete.

When the dubbing ends, your camcorder automatically stops.

To stop dubbing

Press CANCEL.

The program you made is recorded on the "Memory Stick" up to the place where you pressed CANCEL.

To end Digital program editing

Your camcorder stops when the dubbing ends. Then the display returns to VIDEO EDIT in the menu settings.

Press \leftarrow END to end Digital program editing.

Note

In the following instances, recording may stop in middle, or distorted images may be recorded:

- If the tape has a blank portion
- If recording from a tape in a poor condition, such as one that has been reused often for recording

The NOT READY indicator appears on the screen when:

- The program to operate Digital program editing has not been made.
- The "Memory Stick" is not inserted.
- The write-protect tab on the "Memory Stick" is set to LOCK.

When the available recording time of the "Memory Stick" is not enough

The LOW MEMORY indicator appears on the screen. However, you can record pictures up to the time indicated.

When the program has not been set

You cannot press START.

Changing the recording folder

You can create folders up to "999MSDCF" in the "Memory Stick."
The default setting is "101MSDCF" folder to record.

Creating a new folder

The POWER switch should be set to **(MEMORY)**.
Operate by touching the panel.

- (1) Press FN to display PAGE1.
- (2) Press MENU to display the menu.
- (3) Select NEW FOLDER in , then press EXEC (p. 176).

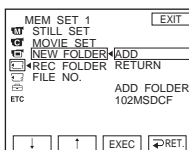

- (4) Select ADD, then press EXEC. A folder with the maximum number+1 will be created. A created folder is automatically set to the folder to record.

To return to FN

Press EXIT.

To cancel creating a new folder



Select RETURN, then press EXEC in step 4.

Choosing the recording folder

The POWER switch should be set to **(MEMORY)**.
Operate by touching the panel.

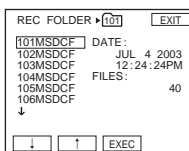
- (1) Press FN to display PAGE1.
- (2) Press MENU to display the menu.
- (3) Select REC FOLDER in , then press EXEC (p. 176).



- (4) Press / to select a folder you want to save to, then press EXEC.

To return to FN

Press EXIT.

Notes

- Up to 9999 image files can be recorded in each folder. When a folder is full, a new folder is automatically created.
- Once a folder is created, it cannot be deleted with your camcorder.
- The more folders you have created, the less the remaining capacity of the "Memory Stick" becomes.

Viewing a still image

- Memory Photo playback

You can play back still images recorded on the "Memory Stick."

You can also play back six images including moving pictures at a time arranged in the same order of recording on the "Memory Stick" by selecting the index screen. You can also use the Remote Commander for this operation.

The POWER switch should be set to **MEMORY**.

Operate by touching the panel.

(1) Press PLAY. The last recorded image is displayed.

(2) Press - (to see the previous image)/+ (to see the next image) on your camcorder to select a desired still image.

To cancel Memory Photo playback

Press CAM.

When no file is in the folder

The "NO FILE AVAILABLE" indicator appears.

Screen indicators during still image playback

To make screen indicators disappear, press DISPLAY/BATTERY INFO.

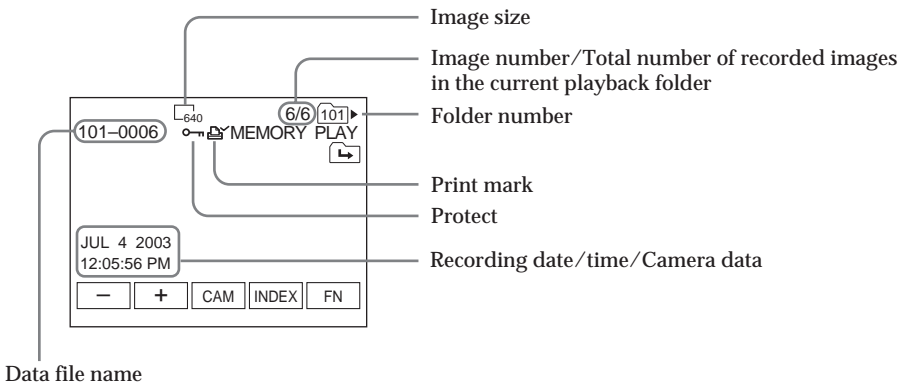

Recording data

To display the recording data (date/time or various settings when recorded), press DATA CODE during playback. You can also use the Remote Commander for this operation (p. 38).

Notes on the file name

- The folder may not appear and only the file name may appear if the structure of the folder does not conform to the DCF standard.
- The file name flashes on the screen if the file is corrupted or the file is unreadable.

When the "Memory Stick" contains multiple folders

The following icons appear on the screen on the first or last images in a folder.

: You can move to the previous folder.

: You can move to the next folder.

: You can move to both the previous and the next folders.

Viewing a still image – Memory Photo playback

Playing back six recorded images at a time (index screen)

This function is especially useful when searching for a particular image.

Press **INDEX** to display the index screen

A red ► mark appears above the image that appears before changing to the index screen mode.

← : To display the previous six images

→ : To display the next six images

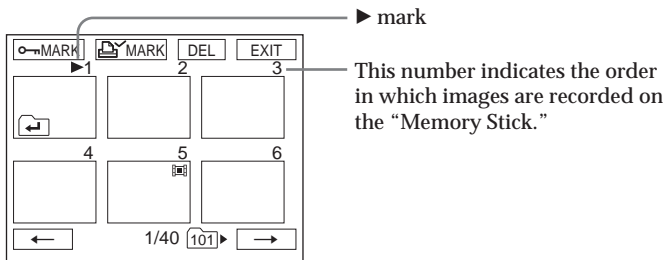

To return to FN

Press **EXIT**.

To return to the normal playback screen (single screen)

Press the image you want to display.

Viewing a moving picture – MPEG MOVIE playback

You can play back moving pictures recorded on the “Memory Stick.”

You can also play back six images including still images in order of recording on the “Memory Stick” at a time by selecting the index screen.

The POWER switch should be set to **MEMORY**.
Operate by touching the panel.

- (1) Press PLAY. The last recorded image appears.
- (2) Press – (to see the previous picture)/+ (to see the next picture) to select a desired moving picture.
- (3) Press MPEG ► || to start playback.
- (4) Adjust the volume following the steps below.
 - ① Press FN and select PAGE3.
 - ② Press VOL. The screen to adjust volume appears.
 - ③ Press – (to turn down the volume)/+ (to turn up the volume) to adjust the volume.
 - ④ Press ↵ OK to return to PAGE3.
 - ⑤ Press EXIT to return to FN.

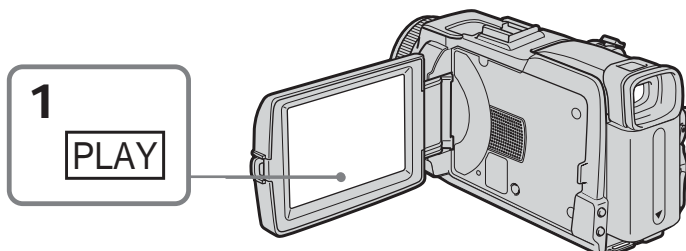

To cancel MPEG MOVIE playback

Press MPEG ► ||.

When no file is in the folder

The “NO FILE AVAILABLE” indicator appears.

Viewing a moving picture - MPEG MOVIE playback

Playback picture from desired part

The moving picture recorded on the “Memory Stick” is divided into parts. It is divided into a maximum of 60.

You can select every each one point and playback pictures.

The POWER switch should be set to (MEMORY).

Operate by touching the panel.

- (1) Follow the step 1 and 2 on page 130.
- (2) Press ← (to see previous part)/→ (to see next part) to select the point where you want to play back.

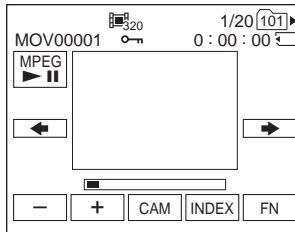

- (3) Follow the step 3 and 4 on page 130.

To cancel MPEG MOVIE playback

Press MPEG ► ||.

When recording time is too short

The moving picture may not be divided into parts.

Screen indicators during moving picture playback

To make screen indicators appear or disappear, press DISPLAY/BATTERY INFO.

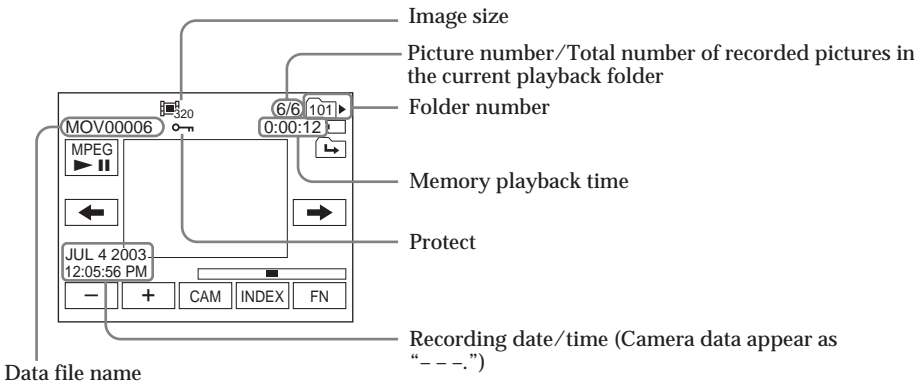

Recording date/time

To display the recording date/time, press DATA CODE during playback. You can also use the Remote Commander for this operation (p. 38).

Download from www.Somanuals.com. All Manuals Search And Download.

Choosing playback folder

You can change the folder currently chosen for playback. The currently chosen folder is displayed in the upper right on the screen.

The POWER switch should be set to **MEMORY**.

Operate by touching the panel.

- (1) Press FN to display to PAGE1.
- (2) Press PB FOLDR.
- (3) Press -/+ to select the folder number you want to play back, then press \Rightarrow END to return to PAGE1.

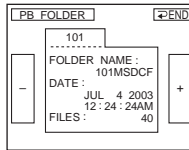

- : To select the previous folder

+ : To select the next folder

- (4) Press EXIT to play back the image.

Note

Your camcorder does not recognize folder names created or changed using the computer.

Current playback folder

The current playback folder is valid until the next recording is made. Once you record an image, the current folder to record becomes the current playback folder.

Enlarging still images recorded on "Memory Stick" – Memory PB ZOOM

You can enlarge still images recorded on the "Memory Stick."

The POWER switch should be set to (MEMORY).
Operate by touching the panel.

- (1) Play back the image to enlarge in the frame.
- (2) Press FN and select PAGE2.
- (3) Press PB ZOOM. The PB ZOOM screen appears.
- (4) Press the area you want to enlarge in the frame.
The area you pressed moves to the center of the screen, and the playback image is enlarged to about twice the size. If you then press another area, that area moves to the center of the screen.
- (5) Adjust the zoom ratio by the power zoom lever.
You can select the image from approximately 1.1 times up to 5 times its size.
W: Decrease the zoom ratio.
T: Increase the zoom ratio.

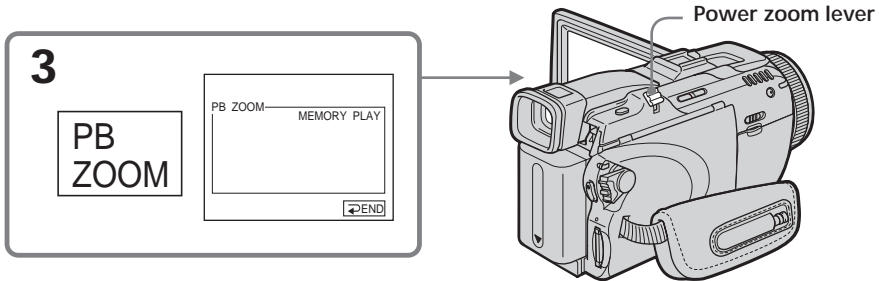

"Memory Stick" Operations

To cancel memory PB ZOOM

Press ↵ END.

Memory PB ZOOM is canceled when you press the following buttons on the Remote Commander:

- MEMORY PLAY
- MEMORY INDEX
- MEMORY +/-

In memory PB ZOOM

If you press DISPLAY/BATTERY INFO, the frame on the memory PB ZOOM screen disappears. You cannot move the part you pressed to the center of the screen.

Edge of an enlarged image

The edge of an enlarged image cannot be displayed in the center of the screen.

Moving pictures recorded on the "Memory Stick"

Memory PB ZOOM does not work.

To record images processed by memory PB ZOOM to the "Memory Stick"

Press PHOTO to record images during display. The image size will be 640 × 480.

Playing back images continuously

- Slide show

You can play back all the images in the “Memory Stick” or in the specified folder using slide show.

The POWER switch should be set to **(MEMORY)**.
Operate by touching the panel.

- (1) Press FN to display PAGE1.
- (2) Press MENU to display the menu.
- (3) Select SLIDE SHOW in , then press EXEC (p. 177).

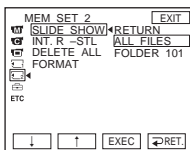

- (4) Select ALL FILES or FOLDER *, then press EXEC.
ALL FILES: To play back all of the images in the “Memory Stick”
FOLDER *: To play back the images in the folder selected with PB FOLDR
* The folder name is displayed in the .
- (5) Press START. Your camcorder plays back the images recorded on the “Memory Stick” in sequence. When all images are played back, slide show automatically stops.

To cancel slide show

Press  END.

To pause slide show

Press PAUSE.

To return to FN

Press  END to return to PAGE1, then press EXIT.

To start slide show from a particular image



Select a desired image using -/+ buttons before step 5.

Preventing accidental erasure

- Image protection

To prevent accidental erasure of important images, you can protect selected images.

The POWER switch should be set to (MEMORY).
Operate by touching the panel.

- (1) Press INDEX to display the index screen.
- (2) Press  MARK. The screen to protect the image appears.
- (3) Press the image you want to protect. The  indicator appears above the protected image.

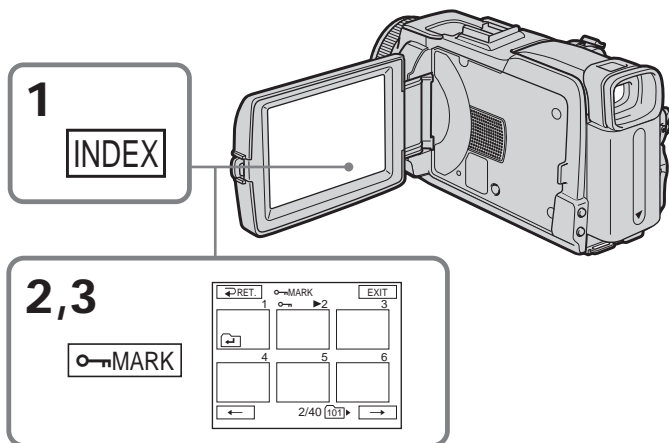

To return to FN

Press EXIT.

To cancel image protection

Press the image you want to cancel image protection in step 3 again.
The  indicator disappears from the image.

Note

Formatting erases all information on the "Memory Stick," including the protected image data. Check the contents of the "Memory Stick" before formatting.

If the write-protect tab on the "Memory Stick" is set to LOCK

You cannot carry out or cancel image protection.

Deleting images – DELETE

You can delete all images or selected images.

Deleting selected images

The POWER switch should be set to **MEMORY**.
Operate by touching the panel.

- (1) Play back the image you want to delete.
- (2) Press FN to display PAGE1.
- (3) Press DEL. The DELETE? indicator appears on the screen.
- (4) Press OK. The selected image is deleted.

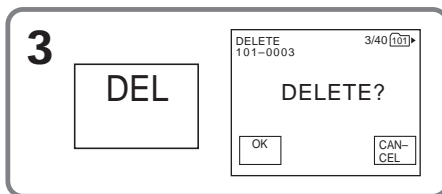

To return to FN

Press EXIT.

To cancel deleting an image

Press CANCEL in step 4.

Notes

- To delete a protected image, first cancel image protection.
- Once you delete an image, you cannot restore it. Check the images to delete carefully before deleting them.

If the write-protect tab on the "Memory Stick" is set to LOCK
You cannot delete images.

Deleting images – DELETE

Deleting selected images on the index screen

The POWER switch should be set to (MEMORY).
Operate by touching the panel.

- (1) Press INDEX to display the index screen.
- (2) Press DEL. Then press the image you want to delete. The number of the selected image is highlighted.
- (3) Press EXEC. The DELETE? indicator appears on the screen.
- (4) Press OK. The selected images are deleted.

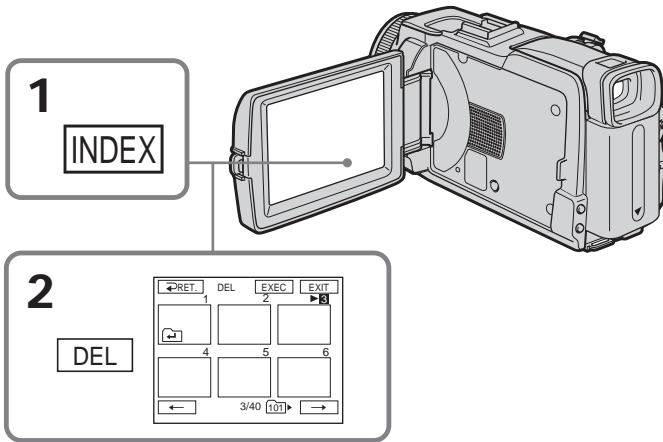

To return to FN

Press EXIT.

To cancel deleting an image

Press CANCEL in step 4.

Deleting images – DELETE

Deleting all the images

You can delete all the unprotected images in the “Memory Stick.”

The POWER switch should be set to **(MEMORY)**.
Operate by touching the panel.

- (1) Press FN to display PAGE1.
- (2) Press MENU to display the menu.
- (3) Select DELETE ALL in , then press EXEC (p. 177).

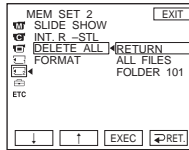

- (4) Select ALL FILES or FOLDER *, then press EXEC.
ALL FILES: To delete all of the images in the “Memory Stick”
FOLDER *: To delete the image in the folder selected with PB FOLDR
* The folder name is displayed in the .
- (5) Select OK, then press EXEC.
OK changes to EXECUTE.
- (6) Select EXECUTE, then press EXEC.
The DELETING indicator appears, then flashes on the screen.
When all the unprotected images are deleted, the COMPLETE indicator appears.

To return to FN

Press EXIT.

To cancel deleting all the images in the “Memory Stick”

Select RETURN in step 5 or 6, then press EXEC.

While the DELETING indicator appears

Do not turn the POWER switch or press any buttons.

Deleting all the images

You cannot delete the folders.

Changing image size – Resize

You can change the image size of recorded still images to 640×480 or 320×240 . Reducing the image size is convenient for use in attachments to e-mail. The original image is retained even after resizing.

The POWER switch should be set to **(MEMORY)**. Operate by touching the panel.

- (1) During memory playback, press FN and select PAGE2.
- (2) Press RESIZE.

The RESIZE screen appears.

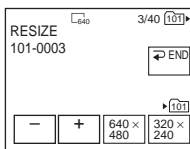

- (3) Press 640×480 or 320×240 .

The image is recorded as the most recently used file in the selected folder to record.

To change still images

Press $-/+$ before step 3.

To return to FN

Press \rightarrow END to return to PAGE2, then press EXIT.

Notes

- You cannot resize the picture recorded with MPEG MOVIE recording.
- You may not be able to change the size of an image recorded with another camcorder.
- You cannot choose the image quality when you resize the image.

Memory capacity after resizing

Image size	Memory capacity
640×480	About 150 KB
320×240	About 16 KB



Writing a print mark – Print mark

This function is useful for printing out still images later. (You cannot specify the number for printouts.)

Your camcorder conforms with the DPOF (Digital Print Order Format) standard for specifying the still images to print out.

The POWER switch should be set to (MEMORY).

Operate by touching the panel.

- (1) Press INDEX to display the index screen.
- (2) Press  MARK. The screen to write a print mark appears.
- (3) Press the image you want to write a print mark. The  appears on the selected image.

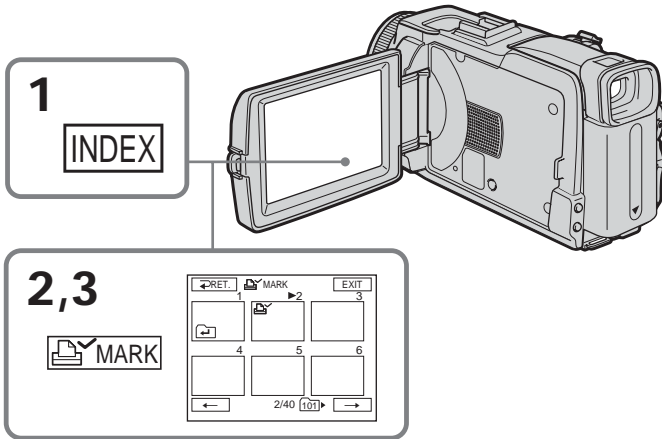

To return to FN

Press EXIT.

To cancel writing print marks

Press the image you want to cancel the print mark in step 3 again. The  disappears from the image.

If the write-protect tab on the "Memory Stick" is set to LOCK

You cannot write or cancel print marks on still images.

Moving pictures

You cannot write print marks on moving pictures.

Viewing images with a computer

- Introduction

There are following ways of connecting your camcorder to a computer in order to view images saved on the “Memory Stick” or recorded on the tape on a computer.

To view images on a computer which has a Memory Stick slot, first eject the “Memory Stick” from your camcorder, then insert it into your computer’s Memory Stick slot.

	Camcorder connection jack	Connection cable	Computer environment requirements	Reference pages	
				For Windows Users	For Macintosh Users
Tape image/ live from your camcorder	USB jack	USB cable (supplied)	USB port, editing software	144 – 146 148 – 149 154 – 157	—
	DV Interface	i.LINK cable (optional)	DV port, editing software	142	—
“Memory Stick” image	USB jack	USB cable (supplied)	USB port, editing software	144 – 147 150 161 – 163	164 – 166

When connecting to a computer with the USB port, complete installation of the USB driver before connecting your camcorder to the computer. If you connect your camcorder to the computer first, you will not be able to install the USB driver correctly.

For details about the computer’s ports and editing software, contact the computer manufacturer.

Viewing pictures recorded on the tape

When connecting to a computer with the USB port

See page 144 for details.

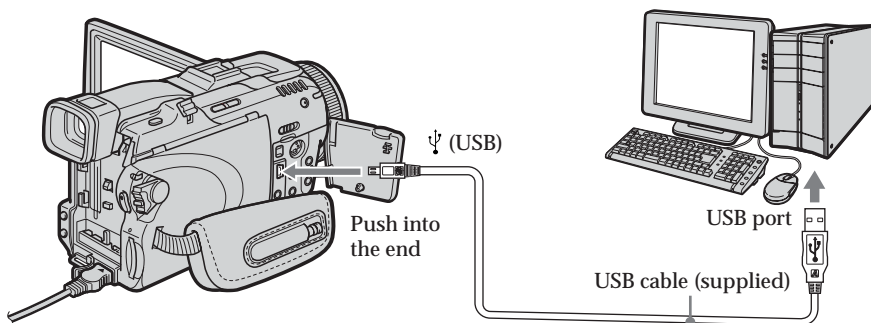

Viewing images with a computer – Introduction

When connecting to a computer with the DV port

The computer must have a DV port and editing software installed that can read video signals.

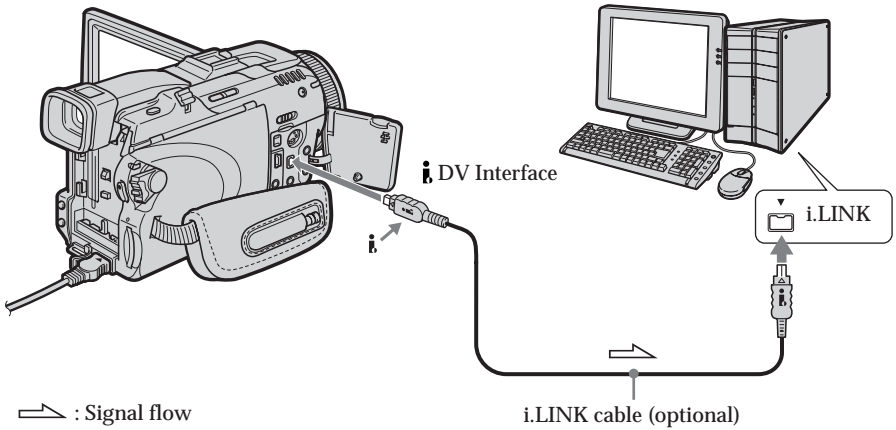

Viewing images recorded on the "Memory Stick"

When connecting to a computer with the USB port

See page 144 when using Windows and page 164 when using Macintosh.

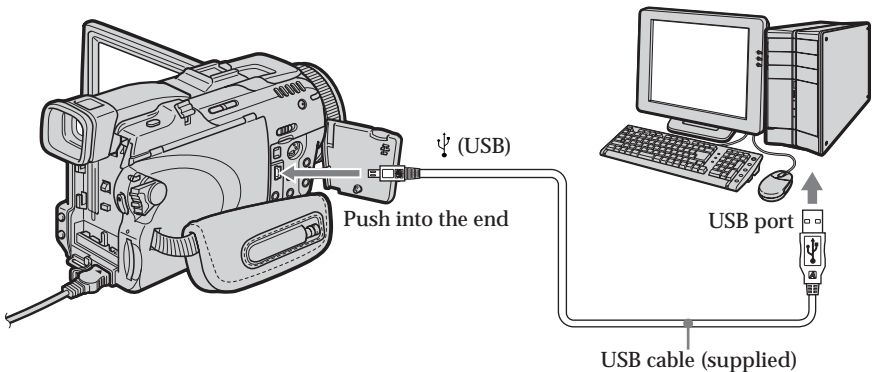

You can also use a "Memory Stick" Reader/Writer (optional).

When connecting to the computer without a USB port

Use an optional floppy disk adaptor for Memory Stick or a PC card adaptor for Memory Stick.

When purchasing an accessory, check its catalog beforehand for the recommended operating environment.

Notes on using a computer

“Memory Stick”

- “Memory Stick” operations on your camcorder cannot be assured if the “Memory Stick” formatted on a computer is used on your camcorder, or if the “Memory Stick” in your camcorder was formatted from the computer when the USB cable was connected.
- Do not compress the data on the “Memory Stick.” Compressed files cannot be played back on your camcorder.

Software

- Depending on your application software, the file size may increase when you open a still image file.
- When you load an image modified using retouching software from a computer to your camcorder or when you directly modify the image on your camcorder, the image format will differ so a file error indicator may appear and you may be unable to open the file.

Communications with a computer

Communications between your camcorder and a computer may not recover after recovering from Suspend, Resume, or Sleep.

Connecting your camcorder to a computer using the USB cable (For Windows users)

Complete installation of the USB driver before connecting your camcorder to a computer. If you connect your camcorder to a computer first, you will not be able to install the USB driver correctly.

When connecting to a computer with the USB port

You must install a USB driver onto the computer in order to connect your camcorder to the computer's USB port. The USB driver can be found on the CD-ROM supplied, along with the application software required for viewing images.

If you connect your camcorder and a computer using the USB cable, you can view pictures live from your camcorder and pictures recorded on the tape on a computer (USB Streaming function).

Furthermore, if you download pictures from your camcorder to a computer, you can process or edit them in image processing software and append them to e-mail.

You can view images recorded on the "Memory Stick" on a computer.

Recommended computer usage environment when connecting with the USB cable and viewing tape pictures on a computer

OS:

Microsoft Windows 98SE, Windows Me, Windows 2000 Professional, Windows XP Home Edition or Windows XP Professional

Standard installation is required.

However, operation is not assured if the above environment is an upgraded OS.

You cannot hear sound if a computer is running Windows 98, but you can read still images.

CPU:

Minimum 500 MHz Intel Pentium III or faster (800 MHz or faster recommended)

Application:

DirectX 8.0a or later

Sound system:

16 bit stereo sound card and stereo speakers

Memory:

64MB or more

Hard disk:

Available memory required for installation:

at least 250MB

Available hard disk memory recommended:

at least 1GB (depending on the size of the image files edited)

Display:

4MB VRAM video card, Minimum 800 × 600 dot High color (16 bit color, 65,000 colors), Direct Draw display driver capability (At 800 × 600 dot or less, 256 colors and less, this product will not operate correctly.)

Others:

This product is based on DirectX technology, so it is necessary to install DirectX.

The USB port must be provided as standard.

You cannot use this function in the Macintosh environment.

Connecting your camcorder to a computer using the USB cable (For Windows users)

Recommended computer usage environment when connecting with USB cable and viewing the "Memory Stick" images on a computer

Recommended Windows environment

OS:

Microsoft Windows 98, Windows 98SE, Windows Me, Windows 2000 Professional, Windows XP Home Edition or Windows XP Professional

Standard installation is required.

However, operation is not assured if the above environment is an upgraded OS.

CPU:

MMX Pentium 200 MHz or faster

Display:

Minimum 800 × 600 dot High color (16 bit color, 65,000 colors). (At 800 × 600 dot or less, 256 colors and less, the screen for installing USB driver is not displayed.)

Others:

The USB port must be provided as standard.

Windows Media Player must be installed (to play back moving pictures).

Notes

- Operations are not guaranteed for the Windows environment if you connect two or more USB equipment to a single computer at the same time, or when using a hub.
- Some equipment may not operate depending on the type of USB equipment that is used simultaneously.
- Operations are not guaranteed for all the recommended computer environments mentioned above.
- Windows and Windows Media are registered trademarks of Microsoft Corporation in the United States and/or other countries.
- Pentium is trademark or registered trademark of Intel Corporation.
- All other product names mentioned herein may be the trademarks or registered trademarks of their respective companies. Furthermore, "TM" and "®" are not mentioned in each case in this manual.

Connecting your camcorder to a computer using the USB cable (For Windows users)

Installing the USB driver

Start the following operation without connecting the USB cable to the computer.
Connect the USB cable according to "Making the computer recognize your camcorder."

If you are using Windows 2000, log in with permission of administrators.
If you are using Windows XP, log in with permission of computer administrators.

- (1) Turn on a computer and allow Windows to load.
- (2) Insert the supplied CD-ROM in the CD-ROM drive of the computer. The application software starts up.
If the screen does not appear, double-click "My Computer," then "ImageMixer" (CD-ROM Drive).
- (3) Select "Handycam" on the screen.

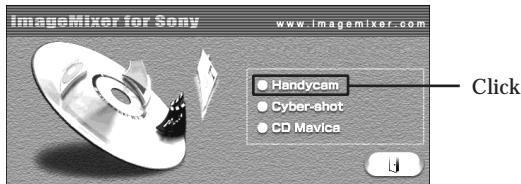

The title screen appears.

- (4) Move the cursor to "USB Driver" and click. This starts USB driver installation.



- (5) Follow the on-screen messages to install the USB driver.
- (6) Remove the CD-ROM, then restart the computer and follow the on-screen messages.

Notes

- If you connect the USB cable before USB driver installation is complete, the USB driver will not be properly registered. Carry out installation again following the on-screen messages.
- The title screen is not displayed if the screen size of the computer is set to less than 800 × 600 dots and 256 colors or less. See page 144, 145 about the recommended computer environment.

Connecting your camcorder to a computer using the USB cable (For Windows users)

Installing Image Transfer

Make sure USB driver installation is complete.

This function enables image data recorded on the “Memory Stick” to be automatically transferred (copied) to a computer.

If you are using Windows 2000, log in with permission of administrators.
If you are using Windows XP, log in with permission of computer administrators.

- (1) Turn on the computer and allow Windows to load.
- (2) Insert the supplied CD-ROM in the CD-ROM drive of the computer. The application software starts up.
- (3) Select “Handycam” on the screen.
The title screen appears.
- (4) Move the cursor to “Image Transfer” and click.



The Install Wizard program starts up and the “Choose Setup Language” screen appears.

- (5) Select the language for installation.
- (6) Follow the on-screen messages.
The installation screen disappears when installation is complete.

Connecting your camcorder to a computer using the USB cable (For Windows users)

Installing ImageMixer

Make sure USB driver installation is complete.

“ImageMixer Ver.1.5 for Sony” is an application that can capture or edit images, or create video CDs.

To install and use this software in Windows 2000, you must be authorized as administrators. For Windows XP, you must be authorized as computer administrators.

- (1) Turn on a computer and allow Windows to load.
- (2) Insert the supplied CD-ROM into the CD-ROM drive of the computer.
The application software starts up.
- (3) Select “Handycam” on the screen.
The title screen appears.
- (4) Move the cursor to “ImageMixer” and click.

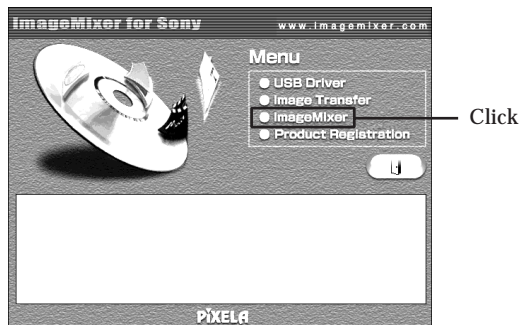

The Install Wizard program starts up and the “Choose Setup Language” screen appears.

- (5) Select the language for installation.
- (6) Follow the on-screen messages.
The installation screen disappears when installation is complete.
- (7) Follow the on-screen messages to install WinASPI.
- (8) If DirectX 8.0a or later is not installed on the computer, continue installation after installing ImageMixer.
Follow the on-screen messages to install DirectX 8.0a. After installation is complete, restart the computer.

Connecting your camcorder to a computer using the USB cable (For Windows users)

MEMORY MIX album

Once “ImageMixer” is installed, the MEMORY MIX album is created in “Album” of “ImageMixer” and sample images are stored in there.

Those sample images can be transferred from the MEMORY MIX album to a “Memory Stick” so that they can be used in MEMORY MIX (p. 116).

Refer to the on-line help for details on the operation procedure.

Replacing WinASPI



To be able to use the ImageMixer CD writing function, you need to install WinASPI. If a different writing application was previously installed, its writing function may not work correctly. If that happens, reinstall the original application and replace WinASPI. Note that the ImageMixer CD writing function may not work properly.

Making the computer recognize your camcorder

If you are using Windows 2000, log in with permission of administrators.

If you are using Windows XP, log in with permission of computer administrators.

Viewing pictures recorded on the tape

- (1) Connect the AC Adaptor, then set the POWER switch to VCR.
- (2) Press FN to display PAGE1.
- (3) Press MENU to display the menu.
- (4) Select USB STREAM in , then press EXEC (p. 180).
- (5) Select ON, then press EXEC.
- (6) Connect the  (USB) jack on your camcorder to the USB port on the computer using the supplied USB cable.

The computer recognizes your camcorder, and the Windows Add Hardware Wizard starts.

Viewing images with a computer

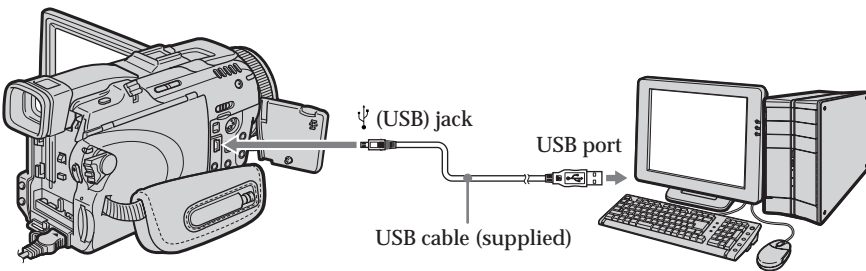

- (7) Follow the on-screen messages so that the Add Hardware Wizard recognizes that the USB drivers have been installed. Be sure to allow the installation to complete without interrupting it.

For Windows 2000, Windows XP users

When the dialog box to confirm the digital signature appears, select “Yes” if you use Windows 2000 or select “Continue Anyway” if you use Windows XP.

Connecting your camcorder to a computer using the USB cable (For Windows users)

Viewing images recorded on the “Memory Stick”

- (1) Insert the “Memory Stick” into your camcorder.
- (2) Connect the AC Adaptor, then set the POWER switch to MEMORY.
- (3) Connect the Ψ (USB) jack on your camcorder to the USB port on the computer using the supplied USB cable.

The USB MODE indicator appears on the LCD screen of your camcorder. The computer recognizes your camcorder, and the Add Hardware Wizard starts.

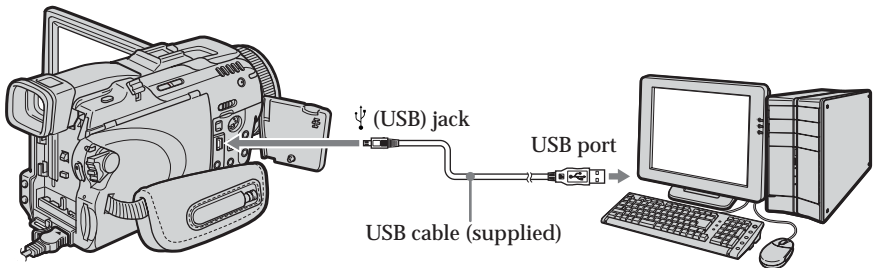

- (4) Follow the on-screen messages so that the Add Hardware Wizard recognizes that the USB drivers have been installed. The Add Hardware Wizard starts two times because two different USB drivers are installed. Be sure to allow the installation to complete without interrupting it.

You cannot install the USB driver if the “Memory Stick” is not in your camcorder. Be sure to insert the “Memory Stick” into your camcorder before installing the USB driver.

Connecting your camcorder to a computer using the USB cable (For Windows users)

If you cannot install the USB driver

The USB driver has been registered incorrectly as a computer was connected to your camcorder before installation of the USB driver was complete. Follow the procedure below to correctly install the USB driver.

Viewing pictures recorded on the tape

Step 1: Uninstall the incorrect USB driver

- ① Turn on the computer and allow Windows to load.
- ② Connect the AC Adaptor, then set the POWER switch to VCR.
- ③ Connect the USB port on the computer to the Ψ (USB) jack on your camcorder using the USB cable supplied.
- ④ Open the computer's "Device Manager."

Windows XP:

Select "Start" → "Control Panel" → "System" → "Hardware," and click the "Device Manager" button.

If there is no "System" inside "Pick a category" after clicking "Control Panel," click "Switch to classic view" instead.

Windows 2000:

Select "My Computer" → "Control Panel" → "System" → "Hardware" tab, and click the "Device Manager" button.

Windows 98SE/Windows Me:

Select "My Computer" → "Control Panel" → "System," and click "Device Manager."

- ⑤ Select and delete the underlined devices below.

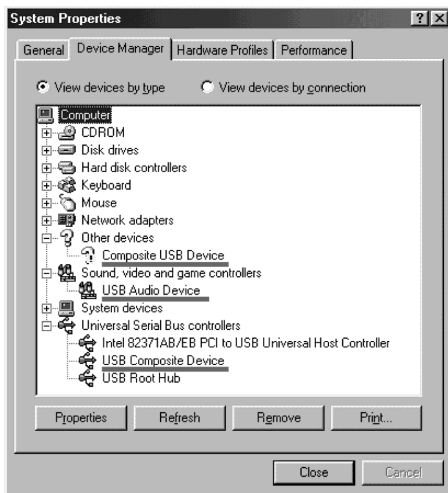

Windows 98SE

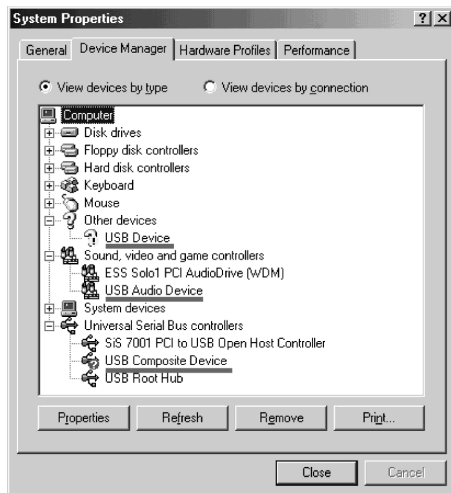

Windows Me

Connecting your camcorder to a computer using the USB cable (For Windows users)

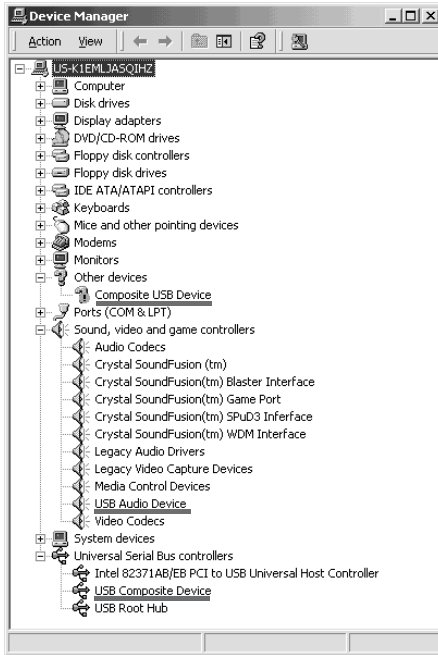

Windows 2000

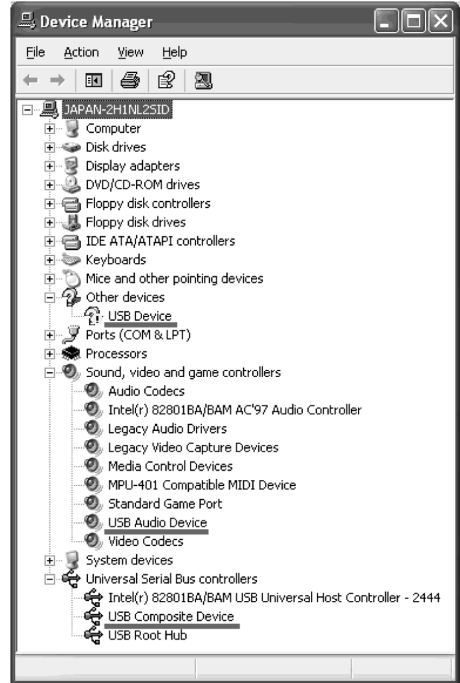

Windows XP

- ⑥ Set the POWER switch to OFF (CHG) on your camcorder, then disconnect the USB cable.
- ⑦ Restart the computer.

Step 2: Install the USB driver on the supplied CD-ROM

Follow the entire procedure in "Installing the USB driver" on page 146.

Connecting your camcorder to a computer using the USB cable (For Windows users)

Viewing images recorded on the “Memory Stick”

Step1: Uninstall the incorrect USB driver

- ① Turn on the computer and allow Windows to load.
- ② Insert the “Memory Stick” into your camcorder.
- ③ Connect the AC Adaptor, then set the POWER switch to MEMORY.
- ④ Connect the USB port on the computer to the Ψ (USB) jack on your camcorder using the USB cable supplied.
- ⑤ Open the computer’s “Device Manager.”

Windows XP:

Select “Start” → “Control Panel” → “System” → “Hardware” tab and click the “Device Manager” button.

If there is no “System” inside “Pick a category” after clicking “Control Panel,” click “Switch to classic view” instead.

Windows 2000:

Select “My Computer” → “Control Panel” → “System” → “Hardware,” and click the “Device Manager” button.

Other OS:

Select “My Computer” → “Control Panel” → “System,” and click “Device Manager.”

- ⑥ Select “Other devices.”
Select the device prefixed with the “?” mark and delete.
Ex: (?)Sony Handycam
- ⑦ Set the POWER switch to OFF (CHG) on your camcorder, then disconnect the USB cable.
- ⑧ Restart the computer.

Step2: Install the USB driver on the supplied CD-ROM

Follow the entire procedure in “Installing the USB driver” on page 146.

Viewing pictures recorded on tape on a computer

- USB Streaming (For Windows users)

Capturing images with "ImageMixer Ver.1.5 for Sony"

You need to install the USB driver and ImageMixer to view pictures recorded on the tape on a computer (p. 146, 148).

Viewing pictures recorded on the tape

- (1) Turn on the computer and allow Windows to load.
- (2) Connect the AC Adaptor, then insert the cassette into your camcorder.
- (3) Set the POWER switch to VCR.
- (4) Press FN to display PAGE1.
- (5) Press MENU to display the menu.
- (6) Select USB STREAM in , then press EXEC (p. 180).
- (7) Select ON, then press EXEC.
- (8) Select "Start" → "Programs" → "PIXELA" → "ImageMixer" → "ImageMixer Ver.1.5 for Sony."
The "ImageMixer Ver.1.5 for Sony" startup screen appears on the computer.
The title screen appears.

- (9) Click  on the screen.

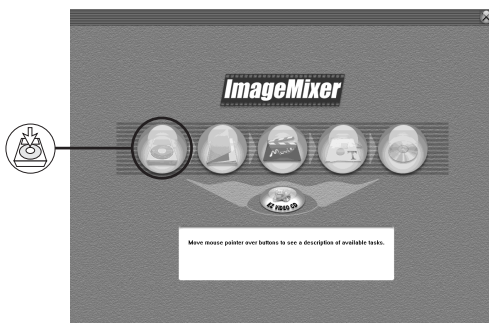

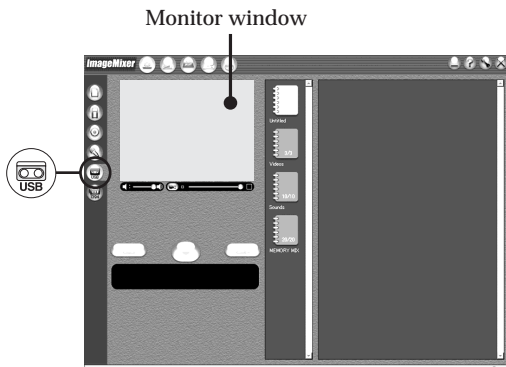

- (10) Click .

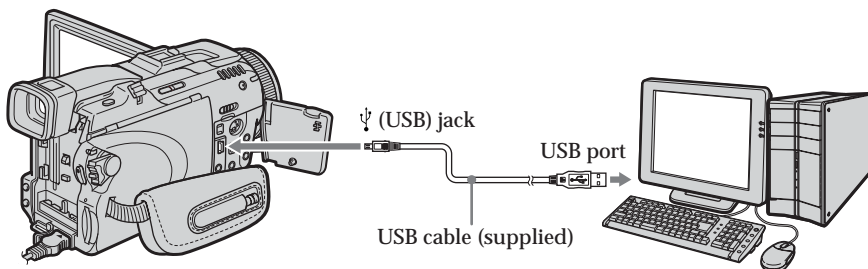

Viewing pictures recorded on tape on a computer - USB Streaming (For Windows users)

- (11) Connect the ψ (USB) jack on your camcorder to the USB port on the computer using the supplied USB cable.



- (12) Click  to start playback.

You can control video operations with the buttons on the screen.

The picture from the tape appears on the monitor window on the computer.

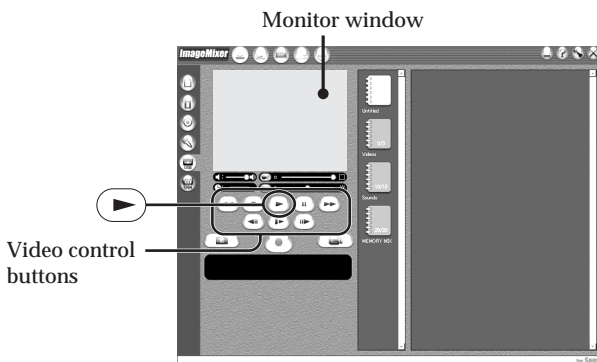

Viewing images with a computer

Viewing pictures live from your camcorder



- (1) Follow the step 1 and 2 on page 154.
- (2) Set the POWER switch to CAMERA.
- (3) Follow the step 4 to 11 on pages 154, 155.

The picture from your camcorder appears on the monitor window on the computer.

Viewing pictures recorded on tape on a computer - USB Streaming (For Windows users)

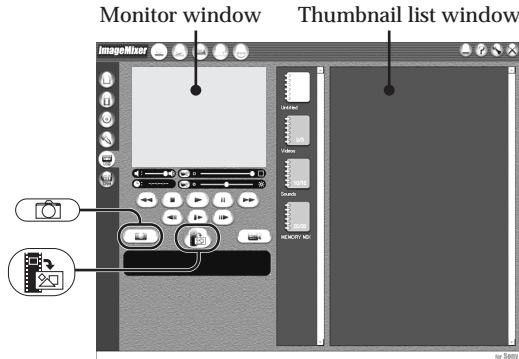





Capturing still images

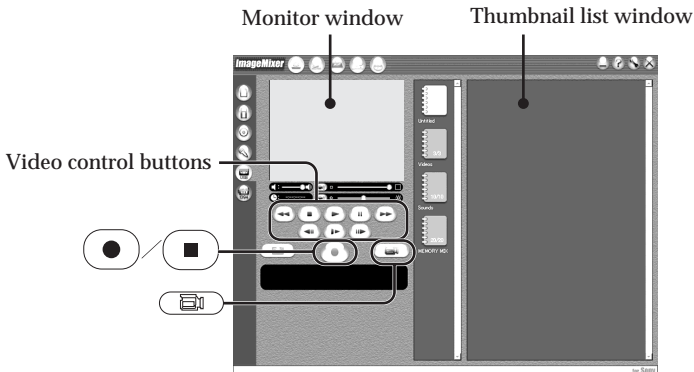

- (1) Click .
- (2) Looking at the monitor window, move the cursor to  and click it at the point you want to capture.
The still image on the screen is captured.
Captured images appear in the thumbnail list window.

Capturing moving pictures



- (1) Click .
- (2) Click  to start playback.
- (3) Looking at the monitor window, click  at the first scene of the movie you want to capture.  changes to .
- (4) Looking at the monitor window, click  at the last scene you want to capture.
The moving picture is captured. The captured images appear in the thumbnail list window.

Viewing pictures recorded on tape on a computer - USB Streaming (For Windows users)

To close "ImageMixer"

Click ⊗ in the upper right corner of the screen.

Notes

- When you view images on a computer with the USB connection, the following may occur. This is not a malfunction.
 - The image shakes up and down.
 - Some images are not displayed correctly due to noise, etc.
 - Some images are displayed with the cracking noise.
 - Images of different color systems to that of your camcorder are not displayed correctly.
- When your camcorder is during standby with a cassette inserted, it turns off automatically after five minutes.
- We recommend setting DEMO MODE to OFF in the menu settings when your camcorder is during standby, and no cassette is inserted.
- Indicators on the screen of your camcorder do not appear on images that are captured into the computer.
- If you capture a fast moving picture, the monitor window may not move smoothly. You can make the picture move more smoothly by shifting the upper right slider on the bottom of the monitor window to the left, although this reduces the picture quality.
- You cannot carry out any "Memory Stick" operations during the USB Streaming function.

If image data cannot be transferred by the USB connection

The USB driver has been registered incorrectly as the computer was connected to your camcorder before installation of the USB driver was complete. Reinstall the USB driver following the procedure on page 151.

If any trouble occurs

Close all running applications, then restart the computer.

Carry out the following operations after quitting the application:



- Disconnect the USB cable.
- Turn the POWER switch to the other position on your camcorder.

Viewing pictures recorded on tape on a computer - USB Streaming (For Windows users)

Making Video CDs – Easy Video CD

This function makes it simple to create a video CD by capturing images recorded on a tape or images live from your camcorder.

Capturing images recorded on a tape onto a CD-R

- (1) Follow the step 1 to 8 on page 154.
- (2) Press  after choosing the point on the tape from which you want to capture images onto the CD-R.
- (3) Click  .

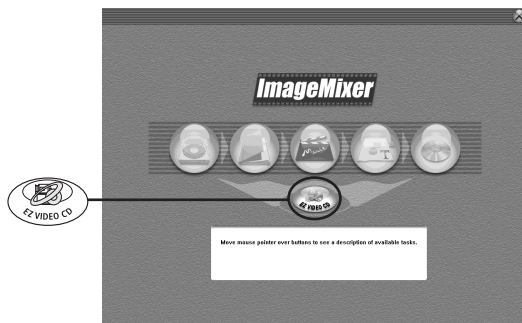

- (4) Connect the  (USB) jack on your camcorder to the USB port on the computer using the supplied USB cable.
- (5) Insert a new CD-R in the CD-R drive of the computer.
- (6) Click “Start.”



The tape is automatically played back. Easy Video CD automatically begins to capture images onto the CD-R to create a Video CD.

- (7) After the “Video CD successfully created.” message appears, click “Quit.”

Viewing pictures recorded on tape on a computer - USB Streaming (For Windows users)

Capturing images live from your camcorder onto a CD-R

Eject the cassette before operation. Your camcorder automatically turns off after about five minutes if the cassette is inserted.

- (1) Follow the step 1 and 2 on page 154.
- (2) Set the POWER switch to CAMERA on your camcorder.
- (3) Follow the step 4 to 8 on page 154.
- (4) Follow the step 3 to 7 in "Capturing images recorded on a tape onto a CD-R."

Notes

- A computer equipped with a CD-R drive is required.
- Do not press the buttons on your camcorder while creating a Video CD. If you press , only images up to that point are captured onto the Video CD and Easy Video CD is closed.
- Once a disc has been created you cannot add images to it.
- Select a hard disc with sufficient memory (at least 6GB) from the "Option" screen as a location for the "Location of work folder."

Playing back Video CDs

You can use a DVD player or a computer with a DVD drive to play back the Video CDs you create.

To play back Video CDs on a computer, you need to have Video CD software installed.

You can play back Video CDs with Windows Media Player. However you cannot use menu functions such as capturing function. You also may not be able to play back Video CDs in certain computer environment such as OS or hardware.

- (1) Start up Windows Media Player.

Windows XP:

Select "Start" → "All Programs" → "Accessory" → "Entertainment," and click "Windows Media Player."

Other OS:

Select "Start" → "Programs" → "Accessory" → "Entertainment," and click "Windows Media Player."

- (2) Select "My Computer" → "CD-R," and click "MPEGAV" folder, then drag and drop the "*.DAT" moving picture file onto the Media Player screen. The moving picture will be played back.

* The file name is displayed in the .

Created Video CDs

The maximum recording time is about one hour.

Capturing is divided into segments of about 10 minutes (approximately 4GB) due to the specifications of the AVI capturing format. As a result, recording includes segment links about every 10 minutes, at which point images are skipped for several seconds.

Seeing the on-line help (operating instructions) of ImageMixer

A “ImageMixer Ver.1.5 for Sony” on-line help site is available where you can find the detailed operating method of “ImageMixer Ver.1.5 for Sony.”

- (1) Click  located in the upper-right corner of the screen.
The ImageMixer’s Manual screen appears.
- (2) You can find the information you need from the list of contents.

To close on-line help

Click  at the top right of the screen.

If you have any questions about ImageMixer

“ImageMixer Ver.1.5 for Sony” is the product of PIXELA corporation. For details, refer to the operating instructions of the CD-ROM supplied with your camcorder.

Viewing images recorded on “Memory Stick” on a computer (For Windows users)

The image data recorded on the “Memory Stick” is automatically transferred (copied) to a computer with Image Transfer. You can view images with ImageMixer. You need to install the USB driver, Image Transfer and ImageMixer to view the “Memory Stick” images on a computer (p. 146 to 148).

- (1) Turn on the computer and allow Windows to load.
- (2) Insert the “Memory Stick” into your camcorder, then connect the AC Adaptor to your camcorder.
- (3) Set the POWER switch to MEMORY.
- (4) Connect the Ψ (USB) jack on your camcorder to the USB port on the computer using the supplied USB cable.
- (5) Image Transfer automatically starts up and the transfer of image data begins.

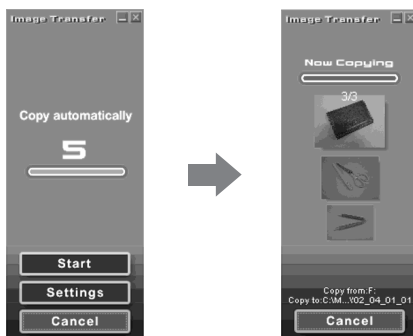

- (6) ImageMixer automatically starts up, enabling you to view the copied image.

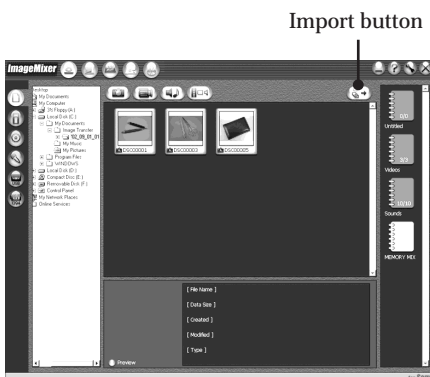

- (7) Select an album and the image, then press the import button. The image is added in your album, and you can edit the image.

Viewing images recorded on “Memory Stick” on a computer (For Windows users)

Viewing images without Image Transfer

Before operation

- You need to install the USB driver to view the “Memory Stick” images on a computer (p. 146).
- An application such as Windows Media Player must be installed to play back moving pictures in Windows environment.

- (1) Turn on the computer and allow Windows to load.
- (2) Insert the “Memory Stick” into your camcorder, then connect the AC Adaptor to your camcorder.
- (3) Set the POWER switch to MEMORY.
- (4) Connect the Ψ (USB) jack on your camcorder to the USB port on the computer using the supplied USB cable.

The USB MODE indicator appears on the screen of your camcorder.

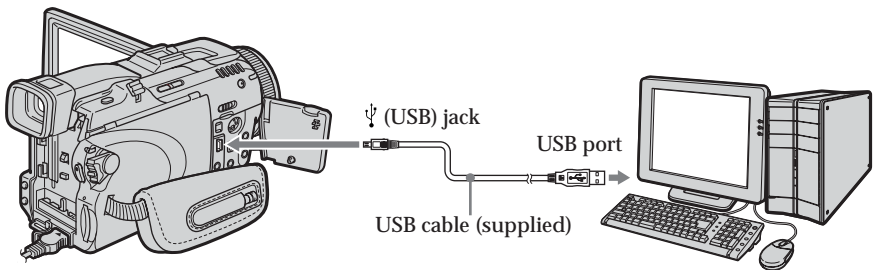

- (5) Open “My Computer” on Windows and double-click the newly recognized drive (Example: “Removable Disk (F:)”).

The folders inside the “Memory Stick” appear.

- (6) Double-click a desired image file from the folder in this order.

“DCIM” folder → “□□MSDCF” folder¹⁾ → Image file²⁾

See “Image file storage destinations and image files” (p. 163), for the detailed folder and file name.

¹⁾ □□□ stands for any number (within the range) from 101 to 999.

²⁾ Copying a file to the hard disk of the computer before viewing it is recommended. If you play back the file directly from the “Memory Stick,” the image and sound may break off.

Viewing images recorded on “Memory Stick” on a computer (For Windows users)

Image file storage destinations and image files

Image data recorded with your camcorder is stored in a folder in the “Memory Stick.” The meanings of the file names are as follows. □□□□ stands for any number within the range from 0001 to 9999.

Example: For Windows Me users (The drive recognizing your camcorder is [F:].)

Folder containing image files recorded using other camcorders without the folder creation function (for playback only)

Folder containing image files recorded with your camcorder
When no new folders have been created, this is only “101MSDCF”

Folder containing moving picture data recorded using other camcorders without the folder creation function (for playback only)

Viewing Images with a computer

Folder	File	Meaning
101MSDCF (up to 999MSDCF)	DSC0□□□□.JPG	Still image file
	MOV0□□□□.MPG	Moving picture file

Disconnect the USB cable and eject the “Memory Stick” or set the POWER switch to OFF (CHG)

For Windows 2000, Windows Me, Windows XP users

- (1) Move the cursor to the “Unplug or Eject Hardware” on the Task Tray and click to cancel the applicable drive.
- (2) After the “Safe to remove” message appears, disconnect the USB cable and eject the “Memory Stick” or set the POWER switch to OFF (CHG).

Connecting your camcorder to a computer using the USB cable (For Macintosh users)

When connecting to a computer with the USB cable

You must install a USB driver onto a computer in order to connect your camcorder to the computer's USB port. The USB driver can be found on the CD-ROM supplied, along with the application software required for viewing images.

Recommended Macintosh environment

Mac OS 8.5.1/8.6/9.0/9.1/9.2 or Mac OS X (v10.0/v10.1/v10.2) standard installation is required.

However, note that the update to Mac OS 9.0/9.1 should be used for the following models.

- iMac with the Mac OS 8.6 standard installation and a slot loading type CD-ROM drive
- iBook or Power Mac G4 with the Mac OS 8.6 standard installation

The USB port must be provided as standard.

QuickTime 3.0 or later must be installed to play back moving pictures.

Notes

- Operations are not guaranteed for the Macintosh environment if you connect two or more USB equipment to a single computer at the same time, or when using a hub.
- Some equipment may not operate depending on the type of USB equipment that is used simultaneously.
- Operations are not guaranteed for all the recommended computer environments mentioned above.
- Macintosh, Mac OS, iBook, Power Mac and QuickTime are trademarks of Apple Computer Inc.
- All other product names mentioned herein may be the trademarks or registered trademarks of their respective companies. Furthermore, "TM" and "®" are not mentioned in each case in this manual.

Connecting your camcorder to a computer using the USB cable (For Macintosh users)

Installing the USB driver

Do not connect the USB cable to a computer before installation of the USB driver is complete.

For Mac OS 8.5.1/8.6/9.0 users

- (1) Turn on the computer and allow the Mac OS to load.
- (2) Insert the supplied CD-ROM in the CD-ROM drive of the computer.
The application software screen appears.
- (3) Select "Handycam" on the screen.
The title screen appears.
- (4) Click the "USB Driver" to open the folder containing the six files related to "Driver."

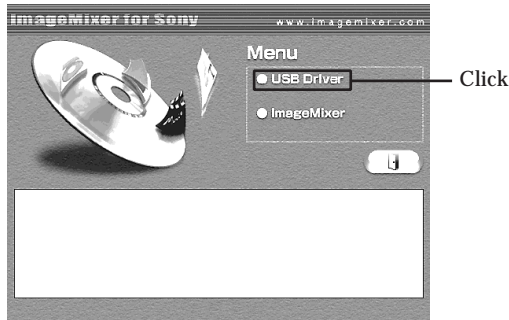

- (5) Select the following two files, and drag and drop them into the System Folder.
 - Sony Camcorder USB Driver
 - Sony Camcorder USB Shim

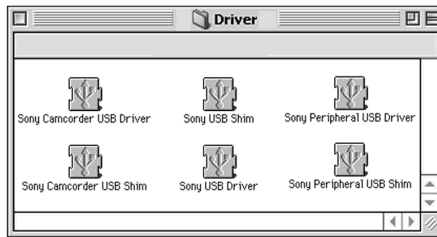

- (6) When the message appears, click "OK."
The USB driver is installed on the computer.
- (7) Remove the CD-ROM from the computer.
- (8) Restart the computer.

For Mac OS 9.1/9.2/Mac OS X (v10.0/v10.1/v10.2)

The USB driver need not be installed. Your camcorder is automatically recognized as a drive just by connecting your Mac using the USB cable.

Viewing images recorded on “Memory Stick” on a computer (For Macintosh users)

Viewing images

Before operation

- You need to install the USB driver to view the “Memory Stick” images on a computer (p. 165).
- QuickTime 3.0 or later must be installed to play back moving pictures.

- (1) Turn on the computer and allow Mac OS to load.
- (2) Insert the “Memory Stick” into your camcorder, then connect the AC Adaptor to your camcorder.
- (3) Set the POWER switch to MEMORY.
- (4) Connect the Ψ (USB) jack on your camcorder to the USB port on the computer using the supplied USB cable.
The USB MODE indicator appears on the screen of your camcorder.
- (5) Double-click the “Memory Stick” icon on the desktop.
The folders inside the “Memory Stick” are displayed.
- (6) Double-click a desired image file from the folder in this order.
“DCIM” folder → “□□□MSDCF” folder¹⁾ → Image file²⁾

¹⁾ □□□ stands for any number (within the range) from 101 to 999.

²⁾ Copying a file to the hard disk of a computer before viewing it is recommended. If you play back the file directly from the “Memory Stick,” the image and sound may break off.

Disconnect the USB cable and eject the “Memory Stick” or set the POWER switch to OFF (CHG)

- (1) Close all running applications.
Make sure that the access lamp of your camcorder is not lit.
- (2) Drag the “Memory Stick” icon into the “Trash.” Alternatively, select the “Memory Stick” icon by clicking on it, then select “Eject disk” from the “Special” menu at the top left of the screen.
- (3) Disconnect the USB cable and eject the “Memory Stick” or set the POWER switch to OFF (CHG).

For Mac OS X (v10.0) users

Shut down the computer, then disconnect the USB cable and eject the “Memory Stick” or set the POWER switch to OFF (CHG).

Capturing images from an analog video unit on a computer

- Signal convert function

You can capture images and sound from an analog video unit connected to a computer which has the DV port to your camcorder.

Before operation

Set DISPLAY in **[ETC]** to LCD in the menu settings. (The default setting is LCD.)

The POWER switch should be set to **(VCR)**.

Operate by touching the panel.

- (1) Press FN to display PAGE1.
- (2) Press MENU to display the menu.
- (3) Select A/V → DV OUT in **[V]**, then press EXEC (p. 175).
- (4) Select ON, then press EXEC.
- (5) Start playback on the analog video unit.
- (6) Start capturing procedures on the computer.

The operation procedures depend on the computer and the software which you use.

For details of how to capture images, refer to the operating instructions of the computer and software.

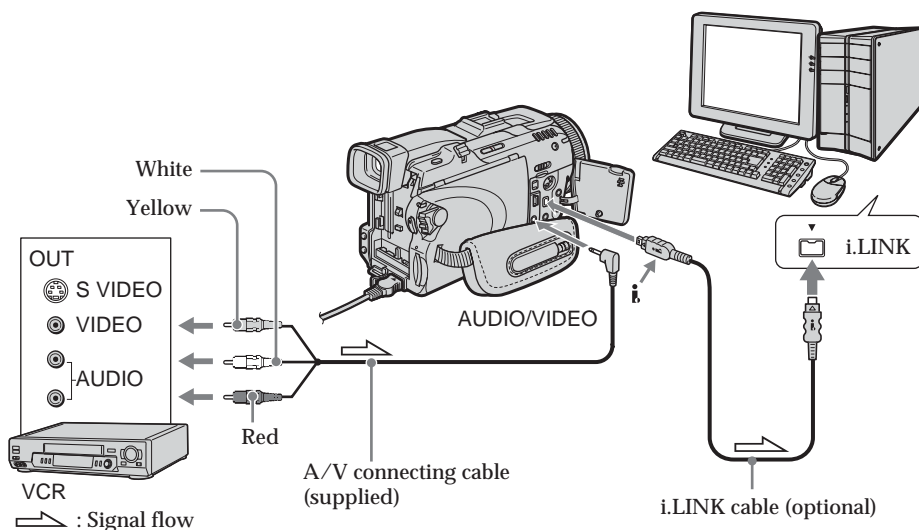

After capturing images and sound

Stop capturing procedures on the computer, and stop playback on the analog video unit.

Capturing images from an analog video unit on a computer - Signal convert function

Notes

- You need the software and computer that support the exchange of digital video signals.
- Depending on the condition of the analog video signals, the computer may not be able to output the images correctly when you convert video signals into digital video signals via your camcorder. Depending on the analog video unit, the image may contain noise or incorrect colors.
- You cannot record or capture the video output via your camcorder when the video tape include copyright protection signals such as the ID-2 system.

If the computer has a USB port

You can connect using a USB cable, but images may not be transferred smoothly.

If your VCR has an S video jack

Pictures can be reproduced more faithfully by using an S video cable (optional).

With this connection, you do not need to connect the yellow (video) plug of the A/V connecting cable.

Connect an S video cable (optional) to the S video jacks of both your camcorder and the VCR.

Accessing the network

– DCR-TRV80 only

You can access the Internet using a Bluetooth device (optional) or a dedicated accessory that serves as a USB Network Adaptor (optional) etc.

Once the access is made, you can view a Web page, send/receive your e-mail, etc. This section describes only how to open the network menu.

The POWER switch should be set to **MEMORY/NETWORK**. Operate by touching the panel.

Press **NETWORK**.

The network menu appears.

For details, refer to the Network Function/Application Operating Instructions supplied with your camcorder.

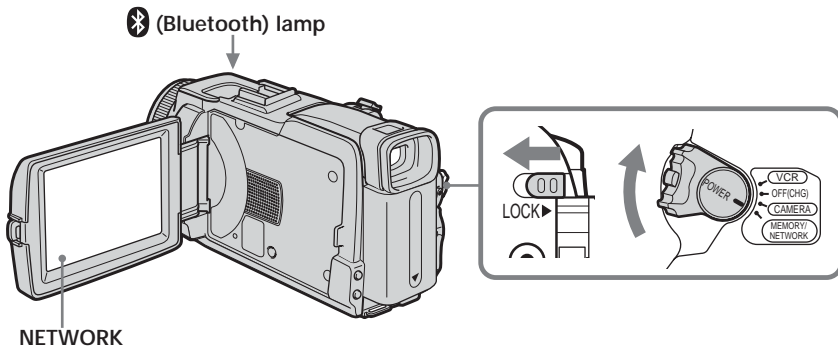

Notes

- Make sure that your camcorder is during standby with the POWER switch set to **MEMORY/NETWORK**.
- Do not remove the power source while operating the network functions or your network settings may be erased. Also, close the network function before you turn the POWER switch.

On trademarks

- The Bluetooth trademarks are owned by their proprietor and used by Sony Corporation under license.
- All other product names mentioned herein may be the trademarks or registered trademarks of their respective companies. Furthermore, "TM" and "®" are not mentioned in each case in this manual.

Accessing the network

How to hold your camcorder when operating network functions

Hold your camcorder with your hand through the grip belt to keep from dropping it. The operation buttons needed for network functions appear on the LCD screen. Press the buttons with the stylus supplied.

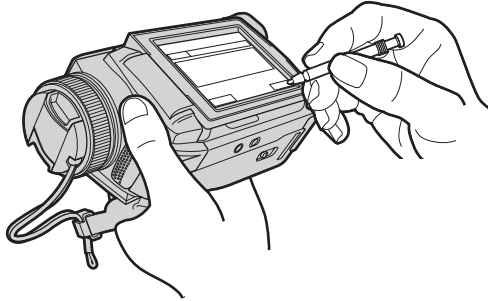

After using the stylus

Put it back in the stylus holder. Hold the stylus correctly as illustrated and insert it until it clicks.

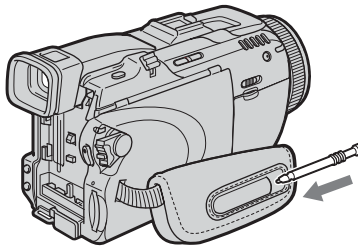

Note

While operating the network functions, do not cover the part as shown in the illustration or radio waves may be blocked.

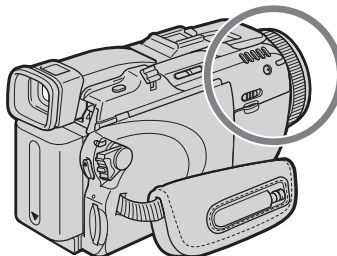

Using applications

- DCR-TRV80 only

Using your camcorder as a Remote Camera, you can operate your camcorder remotely from a computer or a PDA with Bluetooth (optional) etc. You can also transfer a still image (Image Transport) between your camcorder and a computer or a PDA with Bluetooth (optional) etc.

Using as a Remote Camera

The POWER switch should be set to **CAMERA**.
Operate by touching the panel.

- (1) Press FN and select PAGE3.
- (2) Press RMT CAM.

Your camcorder is set to connecting standby.

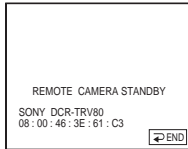

For details, refer to the Network Function/Application Operating Instructions supplied with your camcorder.

Image Transport

The POWER switch should be set to **MEMORY**.
Operate by touching the panel.

- (1) Press FN and select PAGE3.
- (2) Press IMAGE TRANS.

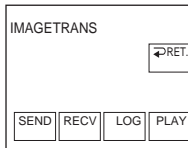

For details, refer to the Network Function/Application Operating Instructions supplied with your camcorder.

Changing the menu settings

To change the mode settings in the menu settings, select the menu items with ↓/↑. The default settings can be partially changed. First, select the icon, then the menu item and the mode.

The POWER switch should be set to **CAMERA**, **VCR** or **MEMORY**. Operate by touching the panel.

- (1) Press FN to display PAGE1.
- (2) Press MENU to display the menu.
- (3) Press ↓/↑ to select a desired icon, then press EXEC.
- (4) Press ↓/↑ to select a desired item, then press EXEC.
- (5) Press ↓/↑ to select a desired setting, then press EXEC.
- (6) Repeat step 3 to 5 if you want to change other items. Press ↵ RET. to return to step 3.

See “Selecting the mode setting of each item” for details (p. 173).

2

CAMERA

MANUAL SET [EXIT]

AREA SET

PROGRAM AE

RED EYE R

FLASH LVL

WHT BAL

SHARPNESS

etc. AUTO SHTR

[DOWN] [UP] [EXEC] [RET]

VCR

MANUAL SET [EXIT]

MP EFFECT

[DOWN] [UP] [EXEC] [RET]

MEMORY

MANUAL SET [EXIT]

PROGRAM AE

RED EYE R

FLASH LVL

WHT BAL

SHARPNESS

etc.

[DOWN] [UP] [EXEC] [RET]

3

OTHERS [EXIT]

AREA SET

DST SET

BEEP

COMMANDER

DISPLAY

REC LAMP

ETC

[DOWN] [UP] [EXEC] [RET]

OTHERS [EXIT]

AREA SET

DST SET

BEEP

COMMANDER

DISPLAY

REC LAMP

ETC

AREA26

NewYork

Bogota

GMT-5.0

JUL 4 2003

12:24:24PM

[DOWN] [UP] [EXEC] [RET]

4

OTHERS [EXIT]

AREA SET

DST SET

BEEP

COMMANDER

DISPLAY

REC LAMP

ETC

[DOWN] [UP] [EXEC] [RET]

OTHERS [EXIT]

AREA SET

DST SET

BEEP

COMMANDER

DISPLAY

REC LAMP

ETC

ON

OFF

[DOWN] [UP] [EXEC] [RET]

5

OTHERS [EXIT]

AREA SET

DST SET

BEEP

COMMANDER

DISPLAY

REC LAMP

ETC

[DOWN] [UP] [EXEC] [RET]

OTHERS [EXIT]

AREA SET

DST SET

BEEP

COMMANDER

DISPLAY

REC LAMP

ETC

ON

OFF

[DOWN] [UP] [EXEC] [RET]

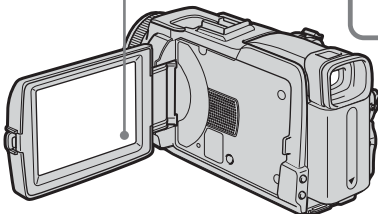











To return to FN

Press EXIT.

Download from www.Somanuals.com. All Manuals Search And Download.















Changing the menu settings

Menu items are displayed as the following icons:

-  MANUAL SET
-  CAMERA SET
-  VCR SET
-  LCD/VF SET
-  MEM SET 1
-  MEM SET 2
-  CM SET
-  TAPE SET
-  SETUP MENU
-  OTHERS

Selecting the mode setting of each item ● is the default setting.

Menu items differ depending on the position of the POWER switch.
The screen shows only the items you can operate at the moment.

Icon/item	Mode	Meaning	POWER switch
 MANUAL SET			
PROGRAM AE	---	To suit your specific shooting requirement (p. 57)	 
P EFFECT	---	To add special effects like those in movies or on the TV to images (p. 53, 69)	 
RED EYE R	● OFF ON	Red-eye reduction does not function. Preliminary flash before recording prevents red-eye.	 
FLASH LVL	HIGH ● NORMAL LOW	To make the flash level higher than normal To use the normal setting To make the flash level lower than normal	 
WHT BAL	---	To adjust the white balance (p. 47)	 
SHARPNESS	---	To adjust the sharpness of the image outline with ↑/↓.	 
			
AUTO SHTR	● ON OFF	To automatically activate the electronic shutter* when shooting in bright conditions To not automatically activate the electronic shutter* even when shooting in bright conditions	

* The electronic shutter is the function used to adjust the shutter speed automatically.

Note on RED EYE R and FLASH LVL

You cannot adjust RED EYE R and FLASH LVL if the external flash (optional) is not compatible.

(continued on the following page)

Changing the menu settings

Icon/item	Mode	Meaning	POWER switch
📷 CAMERA SET			
D ZOOM	● OFF	To deactivate the digital zoom. Up to 10× zoom is carried out.	(CAMERA)
	20×	To activate the digital zoom. More than 10× to 20× zoom is performed digitally (p. 31).	
	120×	To activate the digital zoom. More than 10× to 120× zoom is performed digitally.	
EXPANDED F	● OFF	To not activate the expanded focus	(MEMORY)
	ON	While focusing manually, the center of the screen is displayed at twice the size (p. 61).	
16:9WIDE	● OFF	To not record a 16:9 wide picture	(CAMERA)
	ON	To record a 16:9 wide picture (p. 48)	
STEADYSHOT	● ON	To compensate for camera-shake	(CAMERA)
	OFF	To cancel SteadyShot. Natural pictures are produced when shooting a stationary subject with a tripod.	
HOLOGRAM F	● AUTO	The HOLOGRAM AF emits when focusing on subjects is difficult in dark places (p. 113)	(MEMORY)
	OFF	The HOLOGRAM AF does not emit.	
N.S. LIGHT	● ON	To use the NightShot Light (p. 33)	(CAMERA)
	OFF	To cancel the NightShot Light	(MEMORY)
RMTCAM SET*			
PAN/TILT	● ON	To use PAN/TILT	(CAMERA)
	OFF	To not use PAN/TILT	
CAM INFO	● DSPL ON	To display the status of your camcorder on the screen of a device you want to connect to	(CAMERA)
	DSPL OFF	To not display the status of your camcorder on the screen of a device you want to connect to	

* DCR-TRV80 only



Notes on SteadyShot

- SteadyShot will not correct excessive camera-shake.
- Attachment of a conversion lens (optional) may influence SteadyShot.

If you cancel SteadyShot

The  (SteadyShot off) indicator appears. Your camcorder prevents excessive compensation for camera-shake.

Changing the menu settings

Icon/item	Mode	Meaning	POWER switch
VCR SET			
HiFi SOUND	<input checked="" type="radio"/> STEREO	To play back the stereo tape or dual sound track tape with main and sub sound (p. 195)	(VCR)
	1	To play back the stereo tape with the left sound or the dual sound track tape with main sound	
	2	To play back the stereo tape with the right sound or the dual sound track tape with sub sound	
AUDIO MIX	---	To adjust the balance between stereo 1 and stereo 2 (p. 94)	(VCR)
			
A/V → DV OUT	<input checked="" type="radio"/> OFF	To output digital images and sound in analog format using your camcorder	(VCR)
	ON	To output analog images and sound in digital format using your camcorder (p. 167)	
LCD/VF SET			
LCD B.L.	<input checked="" type="radio"/> BRT NORMAL	To set the brightness on the LCD screen normal	(VCR)
	BRIGHT	To brighten the LCD screen	(CAMERA) (MEMORY)
LCD COLOR	---	To adjust the color on the LCD screen with ↓/↑	(VCR) (CAMERA) (MEMORY)
			
VF B.L.	<input checked="" type="radio"/> BRT NORMAL	To set the brightness on the viewfinder screen to normal	(VCR)
	BRIGHT	To brighten the viewfinder screen	(CAMERA) (MEMORY)

Notes on LCD B.L. and VF B.L.

- When you select BRIGHT, battery life is reduced by about 10 percent during recording.
- When you use power sources other than the battery pack, BRIGHT is automatically selected.

Even if you adjust LCD B.L., LCD COLOR and VF B.L.

The recorded picture will not be affected.

(continued on the following page)

Changing the menu settings

Icon/item	Mode	Meaning	POWER switch
MEM SET 1			
STILL SET			
BURST	● OFF	Not to record continuously	(MEMORY)
	NORMAL	To record from 4 to 25 images continuously (p. 109)	
	HIGH SPEED	To record up to 32 images continuously fast	
	EXP BRKTG	To record three images continuously with different exposure	
QUALITY	● FINE	To record still images in the fine image quality mode (p. 103)	(VCR) (MEMORY)
	STANDARD	To record still images in the standard image quality mode	
IMAGESIZE	● 1600 × 1200	To record still images in 1600 × 1200 size (p. 104)	(MEMORY)
	640 × 480	To record still images in 640 × 480 size	
MOVIE SET			
IMAGESIZE	● 320 × 240	To record moving pictures in 320 × 240 size (p. 105)	(VCR) (MEMORY)
	160 × 112	To record moving pictures in 160 × 112 size	
REMAIN	● AUTO	To display the remaining capacity of the “Memory Stick” in the following cases: <ul style="list-style-type: none"> • For five seconds after setting the POWER switch to VCR and inserting the “Memory Stick” • When the remaining capacity of the “Memory Stick” is less than two minutes after setting the POWER switch to MEMORY • For five seconds from the start of moving picture recording • For five seconds after completing moving picture recording 	(VCR) (MEMORY)
	ON	To always display the remaining capacity of the “Memory Stick”	
NEW FOLDER	● ADD	To create a new folder (p. 127)	(MEMORY)
	RETURN	To cancel creating a new folder	
REC FOLDER	—	To choose a recording folder (p. 127)	(MEMORY)
FILE NO.	● SERIES	To assign file numbers in sequence even when the “Memory Stick” is changed However, the file numbering is reset if you create a new folder or change the recording folder.	(VCR) (MEMORY)
	RESET	To assign file numbers starting with 0001 to each “Memory Stick”	

When you select image quality

The number of images you can shoot in the currently selected image quality appears on the screen.

Changing the menu settings

Icon/item	Mode	Meaning	POWER switch
 MEM SET 2			
SLIDE SHOW	RETURN	To cancel slide show	(MEMORY)
	● ALL FILES	To play back all the images on the “Memory Stick” executing slide show (p. 134)	
	FOLDER □□□*	To play back all the images in the playback folder you are selecting executing slide show	
INT. R -STL	ON	To activate Interval Photo Recording (p. 119)	(MEMORY)
	● OFF	To deactivate Interval Photo Recording	
	SET	To set INTERVAL for Interval Photo Recording	
DELETE ALL	● RETURN	To cancel deleting all the image	(MEMORY)
	ALL FILES	To delete all the unprotected images (p. 138)	
	FOLDER □□□*	To delete all the images in the playback folder you are selecting	
FORMAT	● RETURN	To cancel formatting	(MEMORY)
	OK	To format the inserted “Memory Stick” Formatting erases all information on the “Memory Stick.” Check the contents of the “Memory Stick” before formatting. 1. Select FORMAT, then press EXEC. 2. Select OK, then press EXEC. 3. After the EXECUTE indicator appears, press EXEC. The FORMATTING indicator flashes during formatting. The COMPLETE indicator appears when formatting is complete.	

* The folder name is displayed in the □□□.

Notes on formatting



- Do not do any of the following while the FORMATTING indicator appears:
 - Turn the POWER switch to the other position
 - Operate buttons
 - Eject the “Memory Stick”
- The “Memory Stick” supplied with your camcorder has been formatted at factory. Formatting with your camcorder is not required.
- You cannot format the “Memory Stick” if the write-protect tab on the “Memory Stick” is set to LOCK.
- Format the “Memory Stick” if the “ FORMAT ERROR” indicator appears.
- Formatting erases sample images on the “Memory Stick.”
- Formatting erases protected image data on the “Memory Stick.”
- Formatting erases newly created folders.

(continued on the following page)

Changing the menu settings

Icon/item	Mode	Meaning	POWER switch
 CM SET			
TITLE	---	To superimpose a title or make your own title (p. 95, 97)	<input type="radio"/> VCR <input type="radio"/> CAMERA
TITLEERASE	---	To erase the title you have superimposed (p. 96)	<input type="radio"/> VCR <input type="radio"/> CAMERA
TITLE DSPL	<input checked="" type="radio"/> ON	To display the title you have superimposed	<input type="radio"/> VCR
	<input type="radio"/> OFF	To not display the title	
CM SEARCH	<input checked="" type="radio"/> ON	To search using Cassette Memory (p. 73, 74)	<input type="radio"/> VCR
	<input type="radio"/> OFF	To search without using Cassette Memory	
TAPE TITLE	---	To label the cassette (p. 98)	<input type="radio"/> VCR <input type="radio"/> CAMERA
ERASE ALL	<input checked="" type="radio"/> RETURN	To cancel erasing all	<input type="radio"/> VCR
	<input type="radio"/> OK	To erase all the data in Cassette Memory (p. 99)	<input type="radio"/> CAMERA

Changing the menu settings

Icon/item	Mode	Meaning	POWER switch
 TAPE SET			
REC MODE	● SP	To record in the SP (Standard Play) mode	(VCR)
	LP	To increase the recording time to 1.5 times the SP mode	(CAMERA)
AUDIO MODE	● 12BIT	To record in the 12-bit mode (two stereo sounds)	(VCR)
	16BIT	To record in the 16-bit mode (the one stereo sound with high quality)	(CAMERA)
 REMAIN	● AUTO	To display the remaining tape: <ul style="list-style-type: none"> • For about eight seconds after setting the POWER switch to VCR or CAMERA and inserting a cassette, then your camcorder calculates the remaining amount of tape • For about eight seconds after setting the POWER switch to VCR and  is pressed 	(VCR) (CAMERA)
	ON	To always display the remaining tape indicator	
FRAME REC	● OFF	To deactivate frame recording	(CAMERA)
	ON	To activate frame recording (p. 65)	
INT. REC	ON	To activate Interval Recording (p. 64)	(CAMERA)
	● OFF	To deactivate Interval Recording	
	SET	To set INTERVAL and REC TIME for Interval Recording	

Notes on the LP mode

- When you record the tape in the LP mode on your camcorder, we recommend playing back the tape on your camcorder. When you play back the tape on other camcorders or VCRs, noise may occur in pictures or sound.
- When you record in the LP mode, we recommend using a Sony Excellence/Master mini DV cassette so that you can get the most out of your camcorder.
- You cannot make audio dubbing on the tape recorded in the LP mode. Use the SP mode for the tape to be audio dubbed.
- When you record in the SP and LP modes on one tape or you record some scenes in the LP mode, the playback picture may be distorted or the time code may not be written properly between scenes.

Notes on AUDIO MODE

- You cannot dub audio sound on the tape recorded in the 16-bit mode.
- When playing back the tape recorded in the 16-bit mode, you cannot adjust the balance in AUDIO MIX.

(continued on the following page)

Changing the menu settings

Icon/item	Mode	Meaning	POWER switch
 SETUP MENU			
CLOCK SET	---	To set the date or time (p. 20)	(CAMERA) (MEMORY)
USB STREAM	● OFF	To deactivate the USB Streaming function	(VCR)
	ON	To activate the USB Streaming function	(CAMERA)
LANGUAGE	● ENGLISH	To display the information indicators in English	(VCR)
	FRANÇAIS	To display the information indicators in French	(CAMERA)
	ESPAÑOL	To display the information indicators in Spanish	(MEMORY)
	PORTUGUÊS	To display the information indicators in Portuguese	
	中文	To display the information indicators in Chinese	
	한국어	To display the information indicators in Korean	
DEMO MODE	● ON	To make the demonstration appear	(CAMERA)
	OFF	To cancel the demonstration mode	

Notes on DEMO MODE

- You cannot select DEMO MODE when the cassette or the “Memory Stick” is inserted in your camcorder.
- When NIGHTSHOT is slid to ON, the “NIGHTSHOT” indicator appears on the screen and you cannot select DEMO MODE in the menu settings.
- If you press the touch panel during the demonstration, the demonstration stops for a while, then it starts again after about 10 minutes.
- DEMO MODE is set to STBY (Standby) at the default setting and the demonstration starts about 10 minutes after you have set the POWER switch to CAMERA without the cassette and the “Memory Stick” inserted.

To cancel the demonstration, insert the cassette or “Memory Stick,” set the POWER switch to the position other than CAMERA, or set DEMO MODE to OFF in the menu settings. To set to STBY (Standby) again, leave the DEMO MODE at ON in the menu settings, set the POWER switch OFF (CHG), then back to CAMERA.

Changing the menu settings

Icon/item	Mode	Meaning	POWER switch
ETC OTHERS			
DATA CODE (On the Remote Commander)	● DATE/CAM	To display date, time and various settings during playback when you press DATA CODE on the Remote Commander (p. 38)	(VCR) (MEMORY)
	DATE	To display date and time during playback when you press DATA CODE on the Remote Commander	
AREA SET	---	Temporarily change the area where you are using your camcorder	(CAMERA) (MEMORY)
DST SET*	● OFF	Not during daylight saving time	(CAMERA)
	ON	During daylight saving time	(MEMORY)
BEEP	● MELODY	To output the melody when you start/stop recording or when an unusual condition occurs on your camcorder	(VCR) (CAMERA) (MEMORY)
	NORMAL	To output the beep instead of the melody	
	OFF	To cancel melody, the beep sound and shutter sound	
COMMANDER	● ON	To activate the Remote Commander supplied with your camcorder	(VCR) (CAMERA)
	OFF	To deactivate the Remote Commander to avoid remote control misoperation caused by other VCR's remote control	(MEMORY)
DISPLAY	● LCD	To show the display on the LCD screen and viewfinder	(VCR) (CAMERA)
	V-OUT/LCD	To show the display on the TV screen, LCD screen and viewfinder	(MEMORY)

* Instead of DST, SUMMERTIME appears on the screen for some models.

Note

If you press DISPLAY/BATTERY INFO with DISPLAY set to V-OUT/LCD in the menu settings, the picture from a TV or VCR will not appear on the LCD screen even when your camcorder is connected to the output jacks on the TV or VCR.

(continued on the following page)

Changing the menu settings

Icon/item	Mode	Meaning	POWER switch
ETC) OTHERS			
REC LAMP	● ON	To light up the camera recording lamp at the front of your camcorder	(CAMERA) (MEMORY)
	OFF	To turn the camera recording lamp off so that the person is not aware of the recording	
VIDEO EDIT	● RETURN	To cancel Digital program editing	(VCR)
	TAPE	To make programs and perform Digital program editing on the tape (p. 78)	
	MEMORY	To make programs and perform Digital program editing on the "Memory Stick" (p. 125)	

When recording a close subject

When REC LAMP is set to ON, the red camera recording lamp on the front of your camcorder may reflect on the subject if it is close. In this case, we recommend you set REC LAMP to OFF.

In more than five minutes after removing the power source

The PROGRAM AE, FLASH LVL, WHT BAL, HiFi SOUND, AUDIO MIX and COMMANDER items are returned to their default settings.

Other menu items are held in memory even when the power source is removed.

Types of trouble and how to correct trouble

If you run into any problem using your camcorder, use the following table to troubleshoot the problem. If the problem persists, disconnect the power source and contact your Sony dealer. If “C:□□:□□” appears on the screen, the self-diagnosis display function has activated. See page 191.

During recording

Symptom	Cause and/or Corrective Actions
START/STOP does not operate.	<ul style="list-style-type: none"> • The POWER switch is not set to CAMERA. → Set it to CAMERA (p. 25). • Your camcorder automatically turns off to prevent the battery pack from running out and to protect the tape when your camcorder has been during recording standby for more than five minutes. → Set the POWER switch to OFF (CHG) and then to CAMERA. • The tape has run out. → Rewind the tape or insert a new one (p. 8, 38). • The write-protect tab is set to expose the red mark. → Use a new cassette or slide the tab (p. 195). • The tape is stuck to the drum (moisture condensation). → Eject the cassette and leave your camcorder for at least one hour to acclimatize (p. 202).
The power goes off.	<ul style="list-style-type: none"> • Your camcorder automatically turns off to prevent the battery pack from running out and to protect the tape when your camcorder has been during recording standby for more than five minutes. → Set the POWER switch to OFF (CHG) and then to CAMERA. • The battery pack is dead or nearly dead. → Install a fully charged battery pack.
The picture in the viewfinder is not clear.	<ul style="list-style-type: none"> • The viewfinder lens is not adjusted. → Adjust the viewfinder lens (p. 30).
SteadyShot does not work.	<ul style="list-style-type: none"> • STEADYSHOT is set to OFF in the menu settings. → Set it to ON (p. 174).
The autofocusing function does not work.	<ul style="list-style-type: none"> • The setting is the manual focus. → Press FOCUS to set to the autofocus (p. 61). • Shooting conditions are not suitable for autofocus. → Adjust to focus manually (p. 61).
The picture does not appear in the viewfinder.	<ul style="list-style-type: none"> • The LCD panel is open. → Close the LCD panel (p. 28).
A vertical band appears when you shoot a subject such as lights or a candle flame against a dark background.	<ul style="list-style-type: none"> • The contrast between the subject and background is too high. This is not a malfunction.
A vertical band appears when you shoot a very bright subject.	<ul style="list-style-type: none"> • This is not a malfunction.
Some tiny spots in white, red, blue or green appear on the screen.	<ul style="list-style-type: none"> • SLOW SHTR, Super NightShot or Color Slow Shutter is activated. This is not a malfunction.

(continued on the following page)

Types of trouble and how to correct trouble

Symptom	Cause and/or Corrective Actions
An unknown picture appears on the screen.	<ul style="list-style-type: none"> • If 10 minutes elapse after you set the POWER switch to CAMERA or DEMO MODE is set to ON in the menu settings without a cassette and the “Memory Stick” inserted, your camcorder automatically starts the demonstration. → Insert a cassette/the “Memory Stick” or press the LCD screen. The demonstration stops. You can also set DEMO MODE to OFF in the menu settings (p. 180).
The picture is recorded in incorrect or unnatural colors.	<ul style="list-style-type: none"> • NIGHTSHOT is slid to ON. → Slide it to OFF (p. 32).
Picture appears too bright, and the subject does not appear on the screen.	<ul style="list-style-type: none"> • NIGHTSHOT is slid to ON in a bright place. → Slide it to OFF (p. 32). • The back light function is active. → Set it off (p. 32).
The click of the shutter does not sound.	<ul style="list-style-type: none"> • BEEP is set to OFF in the menu settings. → Set it to MELODY or NORMAL (p. 181).
Black bands appear when you record a TV screen or computer screen.	<ul style="list-style-type: none"> → Set STEADYSHOT to OFF in the menu settings (p. 174).
An external flash (optional) does not work.	<ul style="list-style-type: none"> • The power of the external flash (optional) is off or the power source is not installed. → Turn on the external flash (optional) or install the power source. • Two or more external flashes (optional) are attached. → Only one external flash (optional) can be attached.
Flickering or changes in color occurs.	<ul style="list-style-type: none"> • Phenomena that appear when recording in the PORTRAIT or SPORTS mode of PROGRAM AE in light from a discharge tube such as a fluorescent lamp, sodium lamp or mercury lamp are not due to a malfunction. → Set PROGRAM AE to AUTO in the menu settings.

Types of trouble and how to correct trouble



During playback

Symptom	Cause and/or Corrective Actions
Playback is not possible.	<ul style="list-style-type: none"> The tape has run out. → Rewind the tape (p. 38).
There are horizontal lines on the picture or the playback picture is not clear or does not appear.	<ul style="list-style-type: none"> The video head may be dirty. → Clean the head using the cleaning cassette (optional) (p. 203).
No sound or only a low sound is heard when playing back the tape.	<ul style="list-style-type: none"> The stereo tape is played back with HiFi SOUND set to 2 in the menu settings. → Set HiFi SOUND to STEREO (p. 175). Volume is turned to minimum. → Turn up the volume (p. 37). AUDIO MIX is set to the ST2 side in the menu settings. → Adjust AUDIO MIX (p. 175).
The sound breaks off.	<ul style="list-style-type: none"> The video head may be dirty. → Clean the head using the cleaning cassette (optional) (p. 203).
Displaying the record date, date search does not work.	<ul style="list-style-type: none"> The cassette has no Cassette Memory. → Use a cassette with Cassette Memory (p. 74). CM SEARCH is set to OFF in the menu settings. → Set it to ON (p. 178). The tape has a blank portion in the recorded portion (p. 75).
Title search does not work.	<ul style="list-style-type: none"> The cassette has no Cassette Memory. → Use a cassette with Cassette Memory (p. 73). CM SEARCH is set to OFF in the menu settings. → Set it to ON (p. 178). There is no title in the tape. → Superimpose the titles (p. 95). The tape has a blank portion in the recorded portion (p. 73).
New sound added to the recorded tape is not heard.	<ul style="list-style-type: none"> AUDIO MIX is set to the ST1 side in the menu settings. → Adjust AUDIO MIX (p. 175).
The title is not displayed.	<ul style="list-style-type: none"> TITLE DSPL is set to OFF in the menu settings. → Set it to ON (p. 178).
Noise appears on the screen followed by a PAL indicator.	<ul style="list-style-type: none"> The TV color system of the recorded tape is different to the one of your camcorder.

(continued on the following page)

Types of trouble and how to correct trouble

During recording and playback

Symptom	Cause and/or Corrective Actions
The power does not turn on.	<ul style="list-style-type: none"> The battery pack is not installed, or is dead or nearly dead. → Install a charged battery pack (p. 15, 16). The AC Adaptor is not connected to a wall outlet. → Connect the AC Adaptor to a wall outlet (p. 19).
End search does not work.	<ul style="list-style-type: none"> The cassette was ejected after recording when using a cassette without Cassette Memory (p. 35). You have not recorded on the new cassette yet (p. 35).
End search does not work correctly.	<ul style="list-style-type: none"> The tape has a blank portion in the beginning or middle (p. 35).
The battery pack is quickly discharged.	<ul style="list-style-type: none"> The temperature of the environment is too low. The battery pack is not fully charged. → Charge the battery pack fully again (p. 16). The battery pack is completely dead, and cannot be recharged. → Replace with a new battery pack (p. 15).
The remaining battery time indicator does not indicate the correct time.	<ul style="list-style-type: none"> You have used the battery pack in an extremely hot or cold environment for a long time. The battery pack is completely dead, and cannot be recharged. → Replace with a new battery pack (p. 15). The battery pack is not fully charged. → Install a fully charged battery pack (p. 15, 16). A deviation has occurred in the remaining battery time. → Charge the battery pack fully again so that the indication on the remaining battery time indicator is correct (p. 16).
The power goes off although the remaining battery time indicator indicates that the battery pack has enough power to operate.	<ul style="list-style-type: none"> A deviation has occurred in the remaining battery time. → Charge the battery pack fully again so that the indication on the remaining battery time indicator is correct (p. 16).
The cassette cannot be ejected from the compartment.	<ul style="list-style-type: none"> The power source is disconnected. → Connect it firmly (p. 15, 19). The battery pack is dead. → Use a charged battery pack (p. 15, 16).
The  and  indicators flash and no functions except for cassette ejection work.	<ul style="list-style-type: none"> Moisture condensation has occurred. → Remove the cassette and leave your camcorder for at least one hour to acclimatize (p. 202).
The C// indicator does not appear when using the cassette with Cassette Memory.	<ul style="list-style-type: none"> The gold-plated connector of the tape is dirty or dusty. → Clean the gold-plated connector (p. 196).
The remaining tape indicator is not displayed.	<ul style="list-style-type: none">  REMAIN is set to AUTO in the menu settings. → Set it to ON to always display the remaining tape indicator (p. 179).

Types of trouble and how to correct trouble

When operating using the "Memory Stick"

Symptom	Cause and/or Corrective Actions
The "Memory Stick" does not function.	<ul style="list-style-type: none">• The POWER switch is not set to MEMORY. → Set it to MEMORY (p. 107).• The "Memory Stick" is not inserted. → Insert the "Memory Stick" (p. 102).
Recording does not function.	<ul style="list-style-type: none">• The "Memory Stick" has already been recorded to its full capacity. → Delete unnecessary images and record again (p. 136).• The "Memory Stick" formatted incorrectly is inserted. → Format the "Memory Stick" using your camcorder or use another "Memory Stick" (p. 102, 177).• The write-protect tab on the "Memory Stick" is set to LOCK. → Release the lock (p. 100).• You cannot record data in the 100MSDCF folder. It is only for playing back data.
The HOLOGRAM AF light from the HOLOGRAM AF emitter deviates from the center of the image.	<ul style="list-style-type: none">• The HOLOGRAM AF light is not reaching the subject.
The HOLOGRAM AF light from the HOLOGRAM AF is blurred making focusing difficult.	<ul style="list-style-type: none">→ Wipe the HOLOGRAM AF emitter with a dry cloth.
The image cannot be deleted.	<ul style="list-style-type: none">• The image is protected. → Cancel image protection (p. 135).• The write-protect tab on the "Memory Stick" is set to LOCK. → Release the lock (p. 100).• You try to delete images more than 100 images. → You can only choose the image to delete for up to 100 images at one time.
You cannot format the "Memory Stick."	<ul style="list-style-type: none">• The write-protect tab on the "Memory Stick" is set to LOCK. → Release the lock (p. 100).
Deleting all the images cannot be carried out.	<ul style="list-style-type: none">• The write-protect tab on the "Memory Stick" is set to LOCK. → Release the lock (p. 100).
You cannot protect the image.	<ul style="list-style-type: none">• The write-protect tab on the "Memory Stick" is set to LOCK. → Release the lock (p. 100).• The index screen does not appear. → Press INDEX to display the index screen, then protect the image (p. 135).

(continued on the following page)

Types of trouble and how to correct trouble

Symptom	Cause and/or Corrective Actions
You cannot write a print mark on the still image.	<ul style="list-style-type: none">• The write-protect tab on the “Memory Stick” is set to LOCK. → Release the lock (p. 100).• The index screen does not appear. → Press INDEX to display the index screen, then write a print mark (p. 140).• You are trying to write a print mark on a moving picture. → Print marks cannot be written to a moving picture.• A print mark is written on 999 files. → A print mark can only be written on up to 999 files.
You cannot play back images in actual size.	<ul style="list-style-type: none">• You may not be able to play back images in actual size when you try to play back images recorded by other equipment. This is not a malfunction.
You cannot play back image data.	<ul style="list-style-type: none">• Your camcorder may not be able to play back some images processed with a computer or whose folder or file names have been changed with the computer.• If you record images with any other equipment, the images may not be played back normally on your camcorder.

Types of trouble and how to correct trouble

Others

Symptom	Cause and/or Corrective Actions
A title is not recorded.	<ul style="list-style-type: none">• The cassette has no Cassette Memory.<ul style="list-style-type: none">→ Use the cassette with Cassette Memory (p. 95).• The Cassette Memory is full.<ul style="list-style-type: none">→ Erase unnecessary title (p. 96).• The cassette is set to prevent accidental erasure.<ul style="list-style-type: none">→ Slide the write-protect tab so that red portion is not visible (p. 195).• The tape has a blank portion in the recorded portion.<ul style="list-style-type: none">→ Superimpose the title to the recorded position (p. 95).
A cassette label is not recorded.	<ul style="list-style-type: none">• The cassette has no Cassette Memory.<ul style="list-style-type: none">→ Use the cassette with Cassette Memory (p. 98).• The Cassette Memory is full.<ul style="list-style-type: none">→ Erase unwanted data (p. 96).• The tape is set to prevent accidental erasure.<ul style="list-style-type: none">→ Slide the write-protect tab so that red portion is not visible (p. 195).
Digital program editing to the tape does not function.	<ul style="list-style-type: none">• The input selector on the VCR is not set correctly.<ul style="list-style-type: none">→ Set the selector correctly, then check the connection between the VCR and your camcorder (p. 79).• Your camcorder is connected to DV equipment of other than Sony using the i.LINK cable.<ul style="list-style-type: none">→ Set it to IR (p. 79).• Setting program on a blank portion of the tape is attempted.<ul style="list-style-type: none">→ Set the program again on a recorded portion (p. 84).• The synchronization of your camcorder and the VCR is not adjusted.<ul style="list-style-type: none">→ Adjust the synchronization of the VCR (p. 82).• The IR SETUP code is not correct.<ul style="list-style-type: none">→ Set the correct code (p. 81).
Digital program editing to the "Memory Stick" does not function.	<ul style="list-style-type: none">• Setting program on a blank portion of the tape is attempted.<ul style="list-style-type: none">→ Set the program again on a recorded portion (p. 125).
The Remote Commander supplied with your camcorder does not work.	<ul style="list-style-type: none">• COMMANDER is set to OFF in the menu settings.<ul style="list-style-type: none">→ Set it to ON (p. 181).• Something is blocking the infrared rays.<ul style="list-style-type: none">→ Remove the obstacle.• The batteries are inserted in the battery holder with the + - polarities incorrectly matching the + - marks.<ul style="list-style-type: none">→ Insert the batteries with the correct polarity (p. 215).• The batteries are dead.<ul style="list-style-type: none">→ Insert new ones (p. 215).
The picture from a TV or VCR does not appear even when your camcorder is connected to the outputs on the TV or VCR.	<ul style="list-style-type: none">• DISPLAY is set to V-OUT/LCD in the menu settings.<ul style="list-style-type: none">→ Set it to LCD (p. 181).

(continued on the following page)

Types of trouble and how to correct trouble

Symptom	Cause and/or Corrective Actions
The melody or beep sounds for five seconds.	<ul style="list-style-type: none"> • Moisture condensation has occurred. <ul style="list-style-type: none"> → Eject the cassette and leave your camcorder for at least one hour to acclimatize (p. 202). • Some troubles have occurred in your camcorder. <ul style="list-style-type: none"> → Eject the cassette and insert it again, then operate your camcorder.
No function works though the power is on.	<ul style="list-style-type: none"> → Disconnect the AC Adaptor from a wall outlet or remove the battery pack, then reconnect it in about one minute. Turn the power on. If the functions still do not work, press the RESET button using a sharp-pointed object. (If you press the RESET button, all the settings (DCR-TRV80: except the network settings) including the date and time return to the default) (p. 15, 19, 210).
When you set the POWER switch to VCR or OFF (CHG), if you move your camcorder, you may hear a clattering sound from inside your camcorder.	<ul style="list-style-type: none"> • This is because some functions use a linear mechanism. This is not a malfunction.
While charging the battery pack, no indicator appears.	<ul style="list-style-type: none"> • The battery pack is not properly installed. <ul style="list-style-type: none"> → Install it properly (p. 15).
You cannot charge the battery pack.	<ul style="list-style-type: none"> • The POWER switch is not set to OFF (CHG). <ul style="list-style-type: none"> → Set it to OFF (CHG) (p. 16).
The power runs out quickly, even though the remaining battery time indicator is full.	<ul style="list-style-type: none"> → Charge the battery pack fully again (p. 16).
While charging the battery pack, the indicator flashes in the display window.	<ul style="list-style-type: none"> • The battery pack is not properly installed. <ul style="list-style-type: none"> → Install it properly (p. 15). • Something is wrong with the battery pack. <ul style="list-style-type: none"> → Please contact your Sony dealer or local authorized Sony service facility.
The buttons do not appear on the touch panel.	<ul style="list-style-type: none"> • DISPLAY/BATTERY INFO is pressed. <ul style="list-style-type: none"> → Press the LCD screen lightly. → Press DISPLAY/BATTERY INFO on your camcorder or DISPLAY on the Remote Commander (p. 38).
The buttons on the LCD screen do not work.	<ul style="list-style-type: none"> → Adjust the screen (CALIBRATION) (p. 204).
Image data cannot be transferred to a computer by the USB connection.	<ul style="list-style-type: none"> • The USB cable was connected before installation of the USB driver was complete. <ul style="list-style-type: none"> → Uninstall the incorrect USB driver and reinstall the USB driver (p. 151). • USB STREAM is set to OFF in the menu settings. <ul style="list-style-type: none"> → Set it to ON (p. 180).
The cassette cannot be ejected even if the cassette lid is open.	<ul style="list-style-type: none"> • Moisture condensation has started to condense in your camcorder (p. 202).
The cassette cannot be ejected.	<ul style="list-style-type: none"> → Remove the battery pack, then install it again (p. 15).

Self-diagnosis display

Your camcorder has a self-diagnosis display function.

This function displays the current condition of your camcorder as a 5-digit code (a combination of a letter and figures) on the LCD screen, viewfinder or display window. If a 5-digit code appears, check the following code chart. The last two digits (indicated by □□) will differ depending on the state of your camcorder.

LCD screen, Viewfinder or display window

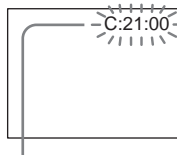

Self-diagnosis display

- C:□□:□□
You can service your camcorder yourself.
- E:□□:□□
Contact your Sony dealer or local authorized Sony service facility.

5-digit display	Cause and/or Corrective Actions
C:04:□□	<ul style="list-style-type: none"> • You are using a battery pack that is not an "InfoLITHIUM" battery pack. → Use an "InfoLITHIUM" battery pack (p. 197).
C:21:□□	<ul style="list-style-type: none"> • Moisture condensation has occurred. → Eject the cassette and leave your camcorder for at least one hour to acclimatize (p. 202).
C:22:□□	<ul style="list-style-type: none"> • The video heads are dirty. → Clean the heads using the cleaning cassette (optional) (p. 203).
C:31:□□ C:32:□□	<ul style="list-style-type: none"> • A malfunction other than the above that you can service has occurred. → Eject the cassette and insert it again, then operate your camcorder. Do not perform this operation if moisture starts to condense (p. 202). → Disconnect the power cord of the AC Adaptor or remove the battery pack. After reconnecting the power source, operate your camcorder. → Replace the cassette.
E:20:□□ E:61:□□ E:62:□□ E:91:□□	<ul style="list-style-type: none"> • A malfunction that you cannot service has occurred. → Contact your Sony dealer or local authorized Sony service facility and inform them of the 5-digit code. (e.g. E:61:10)

If you are unable to rectify the problem even if you try corrective actions a few times, contact your Sony dealer or local authorized Sony service facility.

Warning indicators

If indicators appear on the screen, check the following:
See the page in parentheses “ () ” for details.

101-0001 Warning indicator as to file

Slow flashing:

- The file is corrupted.
- The file is unreadable.
- You are trying to carry out MEMORY MIX on moving pictures (p. 117).

C:21:00 Self-diagnosis display (p. 191)

The battery pack is dead or nearly dead

Slow flashing:

- The battery pack is nearly dead.
Depending on operational, environmental or battery conditions the  indicator may flash, even if there are approximately 5 to 10 minutes remaining.

Moisture condensation has occurred*

Fast flashing:

- Eject the cassette, set the POWER switch to OFF (CHG), and leave it for about one hour with the cassette lid open (p. 202).

Warning indicator as to Cassette Memory*

Slow flashing:

- No cassette with Cassette Memory is inserted (p. 194).

Warning indicator as to the “Memory Stick”

Slow flashing:

- No “Memory Stick” is inserted.

Fast flashing:

- The image cannot be recorded on the “Memory Stick.”*

Warning indicator as to the “Memory Stick” formatting*

Fast flashing:

- The “Memory Stick” data is corrupted (p. 100).
- The “Memory Stick” is not formatted correctly (p. 177).

Warning indicator as to incompatible

“Memory Stick”*

Slow flashing:

- An incompatible “Memory Stick” is inserted.

Warning indicator as to the tape

Slow flashing:

- The tape is near the end.
- No cassette is inserted.*
- The write-protect tab of the cassette is effective (red) (p. 195).*

Fast flashing:

- The tape has run out.*

You need to eject the cassette*

Slow flashing:

- The write-protect tab on the cassette is effective (red) (p. 195).

Fast flashing:

- Moisture condensation has occurred (p. 202).
- The tape has run out.
- The self-diagnosis display function is activated (p. 191).

The image is protected*

Slow flashing:

- The image is protected (p. 135).

Warning indicator as to the flash

Slow flashing:

- During charging

Fast flashing:

- The self-diagnosis display function is activated (p. 191).*
- There is something wrong with the built-in flash or the external flash (optional).

Warning indicator as to still image recording





















Slow flashing:

- The still image cannot be recorded on the “Memory Stick” (p. 45).

* You hear the melody or beep sound.

Warning messages

If messages appear on the screen, check the following. See the page in parentheses “()” for details.

- **CLOCK SET** Set the date and time (p. 20).
- **FOR "InfoLITHIUM" BATTERY ONLY** Use an "InfoLITHIUM" battery pack (p. 197).
-  **CLEANING CASSETTE** The video heads are dirty (p. 203). The  indicator and "CLEANING CASSETTE" message appear one after another on the screen.
- **COPY INHIBIT** You tried to record a picture that has a copyright control signal (p. 194).¹⁾
-  **FULL** The Cassette Memory is full.¹⁾
-  **16BIT** AUDIO MODE is set to 16BIT.¹⁾ You cannot dub new sound (p. 179).
-  **REC MODE** REC MODE is set to LP.¹⁾ You cannot dub new sound onto a tape recorded on equipment of a different TV color system to that of your camcorder (p. 179).
-  **TAPE** There is no recorded portion on the tape.¹⁾ You cannot dub new sound.
-  **"i.LINK" CABLE** i.LINK cable is connected.¹⁾ You cannot dub new sound (p. 94).
-  **FULL** The "Memory Stick" is full (p. 110).¹⁾
-  **LOCK** The write-protect tab on the "Memory Stick" is set to LOCK (p. 100).¹⁾
-  **NO FILE** No image is recorded or recognized on the "Memory Stick."¹⁾
-  **NO MEMORY STICK** No "Memory Stick" is inserted.¹⁾
-  **AUDIO ERROR** You are trying to record an image with sound that cannot be recorded by your camcorder on the "Memory Stick" (p. 123).¹⁾
-  **MEMORY STICK ERROR** The "Memory Stick" data is corrupted (p. 102).¹⁾
-  **FORMAT ERROR** The "Memory Stick" is not recognized (p. 177).¹⁾ Check the format.
-  **PLAY ERROR** The image is distorted and cannot be played back.^{1) 2)}
-  **REC ERROR** Turn the POWER switch on again.¹⁾
-  **INCOMPATIBLE MEMORY STICK** The "Memory Stick" inserted is not compatible with your camcorder.¹⁾
- **READ-ONLY MEMORY STICK** A read-only "Memory Stick" is inserted.¹⁾
-   **TAPE END** The tape has reached the end of the tape.¹⁾
-  **NO TAPE** Insert a cassette.¹⁾
- **DELETING** You press PHOTO on your camcorder while deleting data in the "Memory Stick."¹⁾
- **FORMATTING** You press PHOTO on your camcorder while formatting the "Memory Stick."¹⁾
- **FOLDER NO. FULL** You have reached the maximum number of folders that can be created.¹⁾
- **USB STREAMING ON GOING** You are using USB Streaming function.
-  **NOW CHARGING** Charging a built-in flash or an external flash (optional) does not work correctly.¹⁾

¹⁾ You hear the melody or beep sound.

²⁾ Reinsert the "Memory Stick" and play back.

DCR-TRV80 only

Refer to the Network Function/Application Operating Instruction supplied with your camcorder about warning messages in the network function.

Usable cassettes

Selecting cassette types

You can use the mini DV  cassette only.* You cannot use any other 8 mm , Hi8 , Digital8 , VHS , VHSC , S-VHS , S-VHSC , Betamax , ED Betamax , DV  or MICROMV  cassette.

* There are two types of mini DV cassettes: with Cassette Memory and without Cassette Memory.

Cassettes with Cassette Memory have  (Cassette Memory) mark.
We recommend that you use cassettes with Cassette Memory.

IC memory is mounted on this type of cassette. Your camcorder can read and write data such as dates of recording or titles, etc. to this memory.

The functions using the Cassette Memory require successive signals recorded on the tape. If the tape has a blank portion at the beginning or between recorded portions, titles may not be displayed properly or the search functions may not work properly. Perform the following to prevent a blank portion from being made on the tape.

Press END SCH to go to the end of the recorded portion before you begin the next recording if you operate the following:

- You have ejected the cassette during recording.
- You have played back the tape.
- You have used edit search.

If there is a blank portion or discontinuous signal on the tape, re-record from the beginning to the end of the tape as described above.

The same result may occur when you record using a digital video camera recorder without Cassette Memory on the tape recorded by one with the Cassette Memory.

4K mark on the cassette

The memory capacity of the tape marked with 4K is 4K bits. Your camcorder can accommodate up to 16K bits. 16K bits tape is marked with 16K.

 This is the Mini DV mark.

 This is the Cassette Memory mark.

These are trademarks.

Copyright signal

When you play back

If the tape you play back on your camcorder contains copyright signals, you cannot copy it with another video camera connected to your camcorder.

When you record

You cannot record software on your camcorder that contains copyright control signals for copyright protection of software.

The COPY INHIBIT indicator appears on the screen, or on the TV screen if you try to record such software. Your camcorder does not record copyright control signals on the tape when it records.

Usable cassettes

Audio mode

12-bit mode: The original sound can be recorded in stereo 1, and the new sound in stereo 2 in 32 kHz. The balance between stereo 1 and stereo 2 can be adjusted by selecting AUDIO MIX in the menu settings during playback. Both sounds can be played back.

16-bit mode: A new sound cannot be recorded but the original sound can be recorded in high quality. Moreover, it can also play back sound recorded in 32 kHz, 44.1 kHz or 48 kHz. When playing back the tape recorded in the 16-bit mode, the 16BIT indicator appears on the screen.

When you play back the dual sound track tape

When you play back the dual sound track tape recorded in a stereo system, set HiFi SOUND in to a desired mode in the menu settings (p. 175).

Sound from speaker

HiFi Sound Mode	Playing back the stereo tape	Playing back the dual sound track tape
STEREO	Stereo	Main sound and sub sound
1	Lch	Main sound
2	Rch	Sub sound

You cannot record dual sound programs on your camcorder.

Notes on the cassette

To prevent accidental erasure

Slide the write-protect tab on the cassette to expose the red mark.

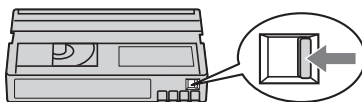

When affixing a label on the cassette

Be sure to affix a label only on the locations as illustrated below [a] so as not to cause malfunction of your camcorder.

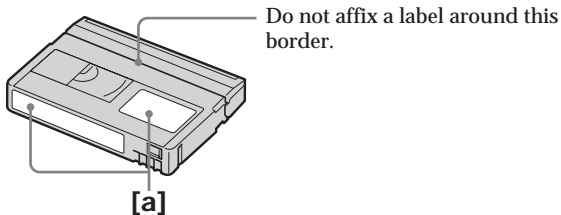

After using the cassette

Rewind the tape to the beginning, put the cassette in its case, and store it in an upright position.

Usable cassettes

When the Cassette Memory function does not work

Reinsert a cassette. The gold-plated connector of mini DV cassettes may be dirty or dusty.

Cleaning gold-plated connector

If the gold-plated connector on the cassette is dirty or dusty, the remaining tape indicator sometimes does not appear correctly, and you may not be able to operate functions using Cassette Memory.

Clean up the gold-plated connector with a cotton-wool swab, about every 10 times ejection of a cassette. **[b]**

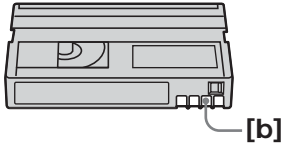

About the “InfoLITHIUM” battery pack

This unit is compatible with the “InfoLITHIUM” battery pack (M series). Your camcorder operates only with the “InfoLITHIUM” battery pack. “InfoLITHIUM” M series battery packs have the  mark.

What is the “InfoLITHIUM” battery pack?

The “InfoLITHIUM” battery pack is a lithium-ion battery pack that has functions for communicating information related to operating conditions between your camcorder and an optional AC adaptor/charger.

The “InfoLITHIUM” battery pack calculates the power consumption according to the operating conditions of your camcorder, and displays the remaining battery time in minutes. With an AC adaptor/charger (optional), the remaining battery time and charging time appear.

Charging the battery pack

- Be sure to charge the battery pack before you start using your camcorder.
- We recommend charging the battery pack in an ambient temperature of between 10°C to 30°C (50°F to 86°F) until the FULL indicator appears in the display window, indicating that the battery pack is fully charged. If you charge the battery outside of this temperature range, you may not be able to efficiently charge the battery pack.
- After charging is complete, either disconnect the cable from the DC IN jack on your camcorder or remove the battery pack.

Effective use of the battery pack

- Battery pack performance decreases in 10°C (50°F) or below surroundings. So, the time that the battery pack can be used becomes shorter. We recommend the following to use the battery pack longer:
 - Put the battery pack in a pocket to warm it up, and insert it in your camcorder immediately before you start taking shots.
 - Use the large capacity battery pack (NP-FM70/QM71/QM71D/FM91/QM91/QM91D, optional).
- Frequently using the LCD screen or frequently operating playback, fast forward or rewind wears out the battery pack faster. We recommend using the large capacity battery pack (NP-FM70/QM71/QM71D/FM91/QM91/QM91D, optional).
- Be certain to set the POWER switch to OFF (CHG) when not taking shots or playing back on your camcorder. The battery pack is also consumed when your camcorder is during tape recording standby or playback pause.
- Have spare battery packs handy for two or three times the expected recording time, and make trial recordings before taking the actual recording.
- Do not expose the battery pack to water. The battery pack is not water resistant.

Remaining battery time indicator

- If the power goes off although the remaining battery time indicator indicates that the battery pack has enough power to operate, charge the battery pack fully again so that the indication on the remaining battery time indicator is correct. Note, however, that the correct battery indication sometimes will not be restored if it is used in high temperatures for a long time or left in a fully charged state, or the battery pack is frequently used. Regard the remaining battery time indication as the approximate shooting time.
- The  mark indicating little remaining battery time sometimes flashes depending on the operating conditions or ambient temperature and environment even if the remaining battery time is about 5 to 10 minutes.

About the “InfoLITHIUM” battery pack

How to store the battery pack

- If the battery pack is not used for a long time, do the following procedure once per year to maintain proper function.
 1. Fully charge the battery pack.
 2. Discharge on your electronic equipment.
 3. Remove the battery pack from the equipment and store it in a dry, cool place.
- To use the battery pack up on your camcorder, leave your camcorder during tape recording standby until the power goes off without a cassette inserted.

Battery life

- The battery life is limited. Battery capacity drops little by little as you use it more and more, and as time passes. When the available battery time is shortened considerably, a probable cause is that the battery pack has reached the end of its life. Please buy a new battery pack.
- The battery life varies depending on how it is stored and operating conditions and environment for each battery pack.

“InfoLITHIUM” is a trademark of Sony Corporation.

About i.LINK

The DV Interface on this unit is an i.LINK-compliant DV Interface. This section describes the i.LINK standard and its features.

What is i.LINK?

i.LINK is a digital serial interface for handling digital video, digital audio and other data in two directions between equipment having the i.LINK, and for controlling other equipment.

i.LINK-compatible equipment can be connected by a single i.LINK cable. Possible applications are operations and data transactions with various digital AV equipment. When two or more i.LINK-compatible equipment are connected to this unit in a daisy chain, operations and data transactions are possible with not only the equipment that this unit is connected to but also with other devices via the directly connected equipment.

Note, however, that the method of operation sometimes varies according to the characteristics and specifications of the equipment to be connected, and that operations and data transactions are sometimes not possible on some connected equipment.

Note

Normally, only one piece of equipment can be connected to this unit by the i.LINK cable. When connecting this unit to i.LINK-compatible equipment having two or more DV Interfaces, refer to the operating instructions of the equipment to be connected.

About the name "i.LINK"

i.LINK is a more familiar term for IEEE 1394 data transport bus proposed by Sony, and is a trademark approved by many corporations. IEEE 1394 is an international standard standardized by the Institute of Electrical and Electronics Engineers.

i.LINK baud rate

i.LINK's maximum baud rate varies according to the equipment. Three maximum baud rates are defined:

S100 (approx. 100Mbps*)

S200 (approx. 200Mbps)

S400 (approx. 400Mbps)

The baud rate is listed under "Specifications" in the operating instructions of each equipment. It is also indicated near the i.LINK on some equipment.

The maximum baud rate of equipment on which it is not indicated such as this unit is "S100."

When units are connected to equipment having a different maximum baud rate, the baud rate sometimes differs from the indicated baud rate.

*What is Mbps?

Mbps stands for megabits per second, or the amount of data that can be sent or received in one second. For example, a baud rate of 100Mbps means that 100 megabits of data can be sent in one second.

i.LINK functions on this unit

For details on how to dub when this unit is connected to other video equipment having DV Interface, see page 76 and 87.

This unit can also be connected to other i.LINK (DV Interface) compatible equipment made by Sony (e.g. VAIO series personal computer) other than video equipment. Before connecting this unit to a computer, make sure that application software supported by this unit is already installed on a computer.

Even if a video device such as a digital TV, DVD or MICROMV has an i.LINK, it may not support digital video. Confirm digital video compatibility before connecting. For details on precautions when connecting this unit, also refer to the operating instructions for the equipment to be connected.

Required i.LINK cable

Use the Sony i.LINK 4-pin-to-4-pin cable (during DV dubbing).

i.LINK and  are trademarks.

Using your camcorder abroad

Using your camcorder abroad

Countries and areas where you can use network functions are restricted. For details, refer to the separate Network Function/Application Operating Instructions. (DCR-TRV80 only)

You can use your camcorder in any country or area with the AC Adaptor supplied with your camcorder within 100 V to 240 V AC, 50/60 Hz.

Use a commercially available AC plug adaptor [a], if necessary, depending on the design of the wall outlet [b].

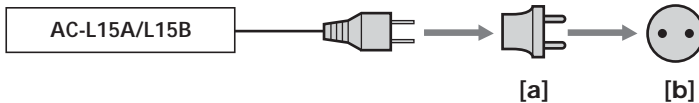

Your camcorder is an NTSC system-based camcorder. If you want to view the playback picture on a TV, it must be an NTSC system-based TV with the AUDIO/VIDEO input jack.

The following shows TV color systems used overseas.

NTSC system

Bahama Islands, Bolivia, Canada, Central America, Chile, Colombia, Ecuador, Guyana, Jamaica, Japan, Korea, Mexico, Peru, Surinam, Taiwan, the Philippines, the U.S.A., Venezuela, etc.

PAL system

Australia, Austria, Belgium, China, Czech Republic, Denmark, Finland, Germany, Holland, Hong Kong, Hungary, Italy, Kuwait, Malaysia, New Zealand, Norway, Poland, Portugal, Singapore, Slovak Republic, Spain, Sweden, Switzerland, Thailand, United Kingdom etc.

PAL-M system

Brazil

PAL-N system



Argentina, Paraguay, Uruguay

SECAM system



Bulgaria, France, Guiana, Iran, Iraq, Monaco, Russia, Ukraine, etc.

Maintenance information and precautions

Moisture condensation

If your camcorder is brought directly from a cold place to a warm place, moisture may condense inside your camcorder, on the surface of the tape, or on the lens. In this condition, the tape may stick to the head drum and be damaged or your camcorder may not operate correctly. If there is moisture inside your camcorder, the beep sounds and the  indicator flashes. When the  indicator flashes at the same time, the cassette is inserted in your camcorder. If moisture condenses on the lens, the indicator will not appear.

If moisture condensation has occurred

None of the functions except cassette ejection will work. Eject the cassette, turn off your camcorder, and leave it for about one hour with the cassette lid open. Your camcorder can be used again if the  or  indicator does not appear when the power is turned on again.

If moisture starts to condense, your camcorder sometimes cannot detect condensation. If this happens, the cassette is sometimes not ejected for 10 seconds after the cassette lid is opened. This is not a malfunction. Do not close the cassette lid until the cassette is ejected.

Note on moisture condensation

Moisture may condense when you bring your camcorder from a cold place into a warm place (or vice versa) or when you use your camcorder in a hot place as follows:

- You bring your camcorder from a ski slope into a place warmed up by a heating device.
- You bring your camcorder from an air-conditioned car or room into a hot place outside.
- You use your camcorder after a squall or a shower.
- You use your camcorder in a high temperature and humidity place.

How to prevent moisture condensation



When you bring your camcorder from a cold place into a warm place, put your camcorder in a plastic bag and tightly seal it. Remove the bag when the air temperature inside the plastic bag has reached the surrounding temperature (after about one hour).

Maintenance information and precautions

Maintenance information

Cleaning the video head

To ensure normal recording, clear pictures and sound, clean the video head. The video head may be dirty when:

- Mosaic-pattern noise appears on the playback picture.
- Playback pictures do not move.
- Playback pictures do not appear or the sound breaks off.
- The  indicator and “ CLEANING CASSETTE” message appear one after another or the  indicator flashes on the screen during recording.

If the above problem, [a], [b] or [c] occurs, clean the video heads for 10 seconds with the Sony DVM-12CLD cleaning cassette (optional). Check the picture and if the above problem persists, repeat cleaning.

[a]



[b]



[c]

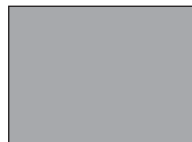

If the video heads get dirtier, the entire screen becomes blue [c].

Note on the video head

The video head suffers from wear after long use. If you cannot obtain a clear image even after using a cleaning cassette, it might be because the video head is worn. Please contact your Sony dealer or local authorized Sony service facility to have the video head replaced.

Cleaning the LCD screen

If fingerprints or dust make the LCD screen dirty, we recommend using a cleaning cloth (supplied) to clean the LCD screen. When you use the LCD Cleaning Kit (optional), do not apply the cleaning liquid directly to the LCD screen. Clean the LCD screen with cleaning paper moistened with the liquid.

Charging the built-in rechargeable battery

Your camcorder has a built-in rechargeable battery so that the date, time and other settings are retained even when the POWER switch is set to OFF (CHG). The built-in rechargeable battery is always charged as long as you are using your camcorder. The battery, however, will get discharged gradually if you do not use your camcorder. It will be completely discharged in **about three months** if you do not use your camcorder at all. Even if the built-in rechargeable battery is not charged, it will not affect your camcorder operation. To retain the date and time, etc., charge the battery if the battery is discharged.

Charging the built-in rechargeable battery

- Connect your camcorder to the house current using the AC Adaptor supplied with your camcorder, and leave your camcorder with the POWER switch set to OFF (CHG) for more than 24 hours.
- Or install the fully charged rechargeable battery pack on your camcorder, and leave your camcorder with the POWER switch set to OFF (CHG) for more than 24 hours.

Adjusting the LCD screen (CALIBRATION)

The buttons on the touch panel may not work correctly. If this happens, follow the procedure below.

- (1) Set the POWER switch to OFF (CHG).
- (2) Eject the tape from your camcorder, then disconnect any connecting cable from your camcorder.
- (3) Set the POWER switch to VCR while pressing DISPLAY/BATTERY INFO on your camcorder, then keep pressing DISPLAY/BATTERY INFO for about five seconds.
- (4) Touch **X** displayed on the screen with your finger or the supplied stylus (DCR-TRV80 only).
The position of **X** changes.

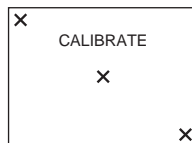

Notes

- If you do not press the right spot, start from step 4 again.
- You cannot calibrate the LCD screen when you close the LCD panel with the LCD screen facing out.

Precautions

Camcorder operation

- Operate your camcorder on 7.2 V (battery pack) or 8.4 V (AC Adaptor).
- For DC or AC operation, use the accessories recommended in this operating instructions.
- If any solid object or liquid get inside the casing, unplug your camcorder and have it checked by a Sony dealer before operating it any further.
- Avoid rough handling or mechanical shock. Be particularly careful of the lens.
- Keep the POWER switch setting to OFF (CHG) when you are not using your camcorder.
- Do not wrap your camcorder with a towel, for example, and operate it. Doing so might cause heat to build up inside.
- Keep your camcorder away from strong magnetic fields or mechanical vibration.
- Do not press the LCD screen with a sharp objects other than the supplied stylus. (DCR-TRV80 only)
- If your camcorder is used in a cold place, a residual image may appear on the LCD screen. This is not a malfunction.
- While using your camcorder, the back of the LCD screen may heat up. This is not a malfunction.

On handling the tape

- Do not insert anything into the small holes on the rear of the cassette. These holes are used to sense the type and thickness of the tape and if the recording tab is in or out.
- Do not open the tape protect cover or touch the tape.
- Avoid touching or damaging the terminals. To remove dust, clean the terminals with a soft cloth.

Camcorder care

- Eject the tape, and periodically turn on the power, operate the CAMERA and VCR sections and play back the tape for about three minutes when your camcorder is not to be used for a long time.
- Clean the lens with a soft brush to remove dust. If there are fingerprints on the lens, remove them with a soft cloth.
- Clean your camcorder body with a dry soft cloth, or a soft cloth lightly moistened with a mild detergent solution. Do not use any type of solvent which may damage the finish.
- Do not let sand get into your camcorder. When you use your camcorder on a sandy beach or in a dusty place, protect it from the sand or dust. Sand or dust may cause your camcorder to malfunction, and sometimes this malfunction cannot be repaired.

AC Adaptor

- Unplug the unit from a wall outlet when you are not using the unit for a long time. To disconnect the power cord, pull it out by the plug. Never pull the power cord itself.
- Do not operate the unit with a damaged cord or if the unit has been dropped or damaged.
- Do not bend the power cord forcibly, or place a heavy object on it. This will damage the cord and may cause fire or electrical shock.
- Prevent metallic objects from coming into contact with the metal parts of the connecting section. If this happens, a short may occur and the unit may be damaged.
- Always keep metal contacts clean.
- Do not disassemble the unit.
- Do not apply mechanical shock or drop the unit.
- While the unit is in use, particularly during charging, keep it away from AM receivers and video equipment because it will disturb AM reception and video operation.
- The unit becomes warm during use. This is not a malfunction.
- Do not place the unit in locations that are:
 - Extremely hot or cold
 - Dusty or dirty
 - Very humid
 - Vibrating

About care and storage of the lens

- Wipe the surface of the lens clean with a soft cloth in the following instance:
 - When there are fingerprints on the lens surface
 - In hot or humid locations
 - When the lens is used in environments such as the seaside
- Store the lens in a well-ventilated location subject to little dirt or dust.

To prevent mold from occurring, periodically perform the above.

We recommend turning on and operating your camcorder about once per month to keep your camcorder in an optimum state for a long time.

Rechargeable battery pack

- Use only the specified charger or video equipment with the charging function.
- To prevent an accident from a short circuit, do not allow metal objects to come into contact with the battery terminals.
- Keep the rechargeable battery pack away from fire.
- Never expose the rechargeable battery pack to temperatures above 60°C (140°F), such as in a car parked in the sun or under direct sunlight.
- Store the rechargeable battery pack in a cool, dry place.
- Do not expose the rechargeable battery pack to any mechanical shock.
- Do not disassemble nor modify the rechargeable battery pack.
- Install the rechargeable battery pack to the video equipment securely.
- Charging while some capacity remains does not affect the original battery capacity.

Maintenance information and precautions

Note on dry batteries

To avoid possible damage from battery leakage or corrosion, observe the following:

- Be sure to insert the batteries with the + - polarities matched to the + - marks.
- Dry batteries are not rechargeable.
- Do not use a combination of new and old batteries.
- Do not use different types of batteries.
- Current flows from batteries when you are not using them for a long time.
- Do not use leaking batteries.

If batteries are leaking

- Wipe off the liquid in the battery compartment carefully before replacing the batteries.
- If you touch the liquid, wash it off with water.
- If the liquid get into your eyes, wash your eyes with a lot of water and then consult a doctor.

If any problem occurs, unplug your camcorder and contact your nearest Sony dealer.

Specifications

Video camera recorder

System

Video recording system

2 rotary heads

Helical scanning system

Audio recording system

Rotary heads, PCM system

Quantization: 12 bits (Fs 32 kHz, stereo 1, stereo 2), 16 bits (Fs 48 kHz, stereo)

Video signal

NTSC color, EIA standards

Usable cassette

Mini DV cassette with the  mark printed

Tape speed

SP: Approx. 18.81 mm/s

LP: Approx. 12.56 mm/s

Recording/playback time

(using cassette DVM60)

SP: 1 hour

LP: 1.5 hours

Fastforward/rewind time

(using cassette DVM60)

Approx. 2 min. and 40 seconds

Viewfinder

Electric viewfinder (color)

Image device

5.0 mm (1/3.6 type) CCD (Charge Coupled Device)

Gross: Approx. 2 110 000 pixels

Effective (still):

Approx. 1 920 000 pixels

Effective (moving):

Approx. 1 080 000 pixels

Lens

Carl Zeiss Vario-Sonnar T*

Combined power zoom lens

Filter diameter: 37 mm

(1 1/2 in.)

10× (Optical), 120× (Digital)

F = 1.8 – 2.1

Focal length

4.5 – 45 mm (3/16 – 1 13/16 in.)

When converted to a 35 mm still camera

In CAMERA:

52 – 520 mm (2 1/8 – 20 1/2 in.)

In MEMORY:

39 – 390 mm (1 9/16 – 15 3/8 in.)

Color temperature

Auto, HOLD, INDOOR (3 200 K),

OUTDOOR (5 800 K)

Minimum illumination

7 lx (lux) (F 1.8)

0 lx (lux) (in NightShot)*

* Objects unable to be seen due to the dark can be shot with infrared lighting.

Input/Output connectors

S video input/output

4-pin mini DIN

Luminance signal: 1 Vp-p,

75 Ω (ohms), unbalanced

Chrominance signal: 0.286 Vp-p,

75 Ω (ohms), unbalanced

Audio/Video input/output

AV MINI JACK, 1 Vp-p,

75 Ω (ohms), unbalanced

327 mV, (at output impedance

more than 47 kΩ (kilohms))

Output impedance with less than

2.2 kΩ (kilohms)/Stereo minijack (ø 3.5 mm)

Input impedance more than

47 kΩ (kilohms)

DV input/output

4-pin connector

Headphone jack

Stereo minijack (ø 3.5 mm)

LANC jack

Stereo mini-minijack (ø 2.5 mm)

USB jack

DCR-TRV75:

mini-B

DCR-TRV80:

mini-AB

MIC jack

Minijack, 0.388 mV low impedance

with 2.5 to 3.0 V DC, output

impedance 6.8 kΩ (kilohms)

(ø 3.5 mm)

Stereo type

LCD screen

Picture

8.8 cm (3.5 type)

Total dot number

184 000 (840 × 220)

Wireless communications

(DCR-TRV80 only)

Communications system

Bluetooth standard Ver.1.1

Max. baud rate¹⁾²⁾

Approx. 723 kbps

Output

Bluetooth standard Power Class 2

Communications distance²⁾

Max. wireless distance

Approx. 10 m (393 3/4 in.) (When

connecting to BTA-NW1/NW1A)

Compatible Bluetooth profile³⁾

Generic Access Profile

Dial-up Networking Profile

Basic Image Profile

(Image Push Initiator, Image Push

Responder, Remote Camera

Responder)

Operating frequency band

2.4 GHz band (2.400 GHz – 2.483 5 GHz)

¹⁾ Max. baud rate of Bluetooth standard Ver.1.1

²⁾ Varies according to the distance between communicating devices, presence of obstacles, radiowave conditions, and other factors.

³⁾ This is a specification matched to specific usage requirements between Bluetooth compatible devices. It is laid down in the Bluetooth standards.

Specifications

General

Power requirements

7.2 V (battery pack)

8.4 V (AC Adaptor)

Average power consumption

(when using the battery pack)

During camera recording using

LCD

5.1 W

Viewfinder

4.1 W

Operating temperature

0°C to 40°C (32°F to 104°F)

Storage temperature

-20°C to + 60°C

(-4°F to + 140°F)

Dimensions (approx.)

73 × 93 × 169 mm

(2 7/8 × 3 3/4 × 6 3/4 in.) (w/h/d)

Mass (approx.)

720 g (1 lb 9 oz)

main unit only

820 g (1 lb 12 oz)

including the rechargeable battery

pack NP-FM50, cassette DVM60

and lens cap

Supplied accessories

See page 14.

AC Adaptor AC-L15A/L15B

Power requirements

100 – 240 V AC, 50/60 Hz

Current consumption

0.35 – 0.18 A

Power consumption

18 W

Output voltage

DC OUT: 8.4 V, 1.5 A

Operating temperature

0°C to 40°C (32°F to 104°F)

Storage temperature

-20°C to + 60°C

(-4°F to + 140°F)

Dimensions (approx.)

56 × 31 × 100 mm

(2 1/4 × 1 1/4 × 4 in.) (w/h/d)

excluding projecting parts

Mass (approx.)

190 g (6.7 oz)

excluding power cord

Rechargeable battery pack NP-FM50

Maximum output voltage

DC 8.4 V

Output voltage

DC 7.2 V

Capacity

8.5 Wh (1 180 mAh)

Dimensions (approx.)

38.2 × 20.5 × 55.6 mm

(1 9/16 × 13/16 × 2 1/4 in.)

(w/h/d)

Mass (approx.)

76 g (2.7 oz)

Type

Lithium ion

“Memory Stick”

Memory

Flash memory

8MB: MSA-8A

Operating voltage

2.7 – 3.6 V

Power consumption

Approx. 45 mA during operation
mode

Approx. 130 µA during tape

recording standby

Dimensions (approx.)

50 × 2.8 × 21.5 mm

(2 × 1/8 × 7/8 in.) (w/h/d)

Mass (approx.)

4 g (0.14 oz)

Design and specifications are

subject to change without notice.

Identifying parts and controls

Camcorder

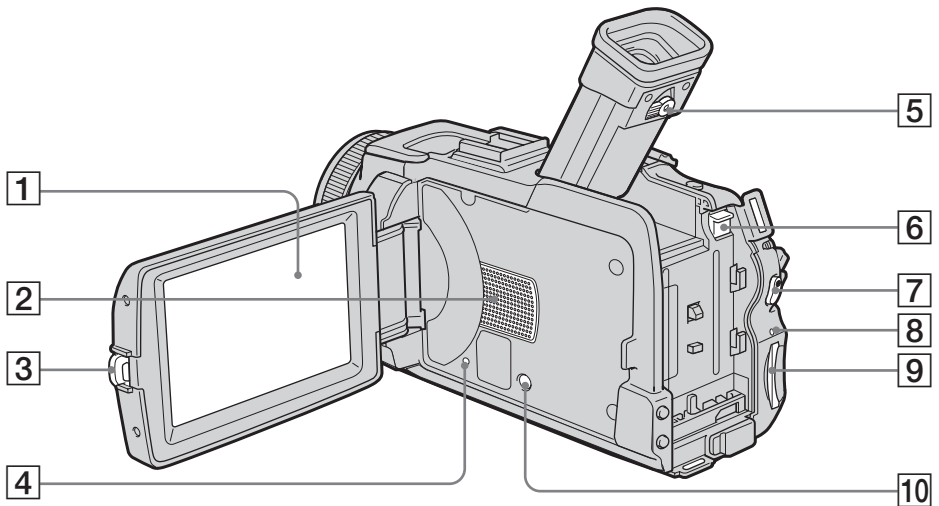

1 LCD/Touch panel screen (p. 23, 28, 29)

2 Speaker

3 OPEN button (p. 25)

4 RESET button

If you press RESET, all the settings (DCR-TRV80: except the network settings) including the date and time return to the default.

5 Viewfinder lens adjustment lever (p. 30)

6 BATT release button (p. 15)

7 START/STOP button (p. 25)

8 Access lamp

9 "Memory Stick" slot (p. 102)

10 DISPLAY/BATTERY INFO button (p. 18, 38)

Identifying parts and controls

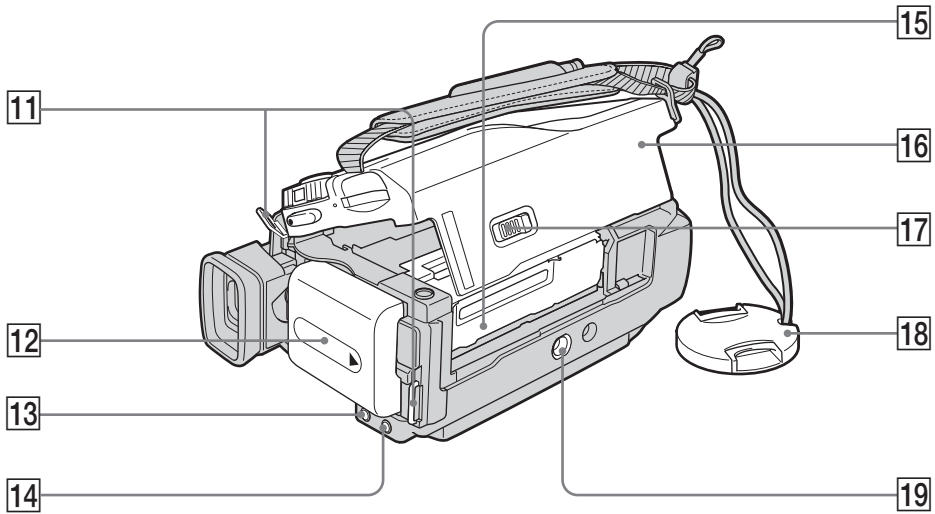

- 11 Hooks for shoulder strap
- 12 Battery pack (p. 15)
- 13 FOCUS button (p. 61)
- 14 BACK LIGHT button (p. 32)

- 15 Cassette compartment
- 16 Cassette lid (p. 8)
- 17  OPEN/EJECT lever (p. 8)
- 18 Lens cap (p. 25)
- 19 Tripod receptacle
Make sure that the length of the tripod screw is less than 5.5 mm (7/32 inch). Otherwise, you cannot attach the tripod securely, and the screw may damage your camcorder.

Identifying parts and controls

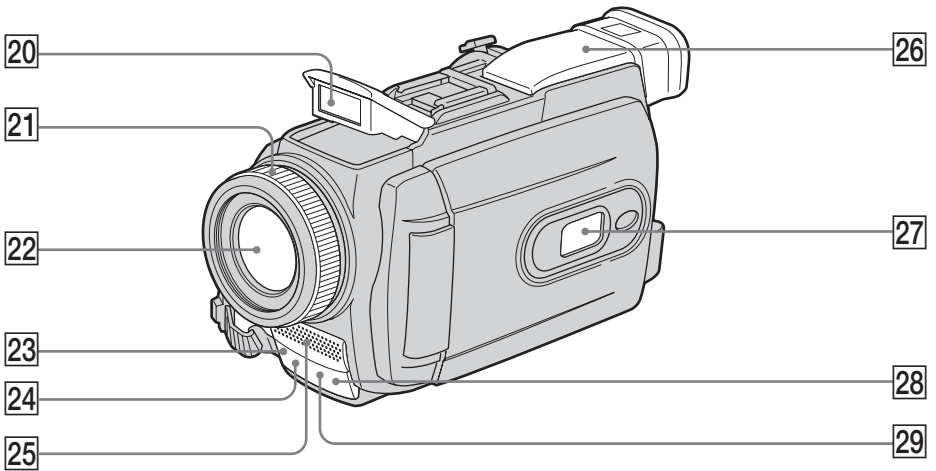

20 Flash (p. 111)

21 Focus ring (p. 61)

22 Lens

23 Camera recording lamp (p. 25)

24 Infrared rays emitter (p. 32, 80)

25 Microphone

26 Viewfinder (p. 30)

27 Display window (p. 16)

28 HOLOGRAM AF emitter (p. 113)

29 Remote sensor

Note on the Carl Zeiss lens

Your camcorder is equipped with a Carl Zeiss lens which can reproduce fine images. The lens for your camcorder was developed jointly by Carl Zeiss, in Germany, and Sony Corporation. It adopts the MTF[#] measurement system for video camera and offers a quality as the Carl Zeiss lens.

The lens for your camcorder is also T*-coated to suppress unwanted reflection and faithfully reproduce colors.

[#] MTF Stands for Modulation Transfer Function.

The value number indicates the amount of light of a subject coming into the lens.

Identifying parts and controls

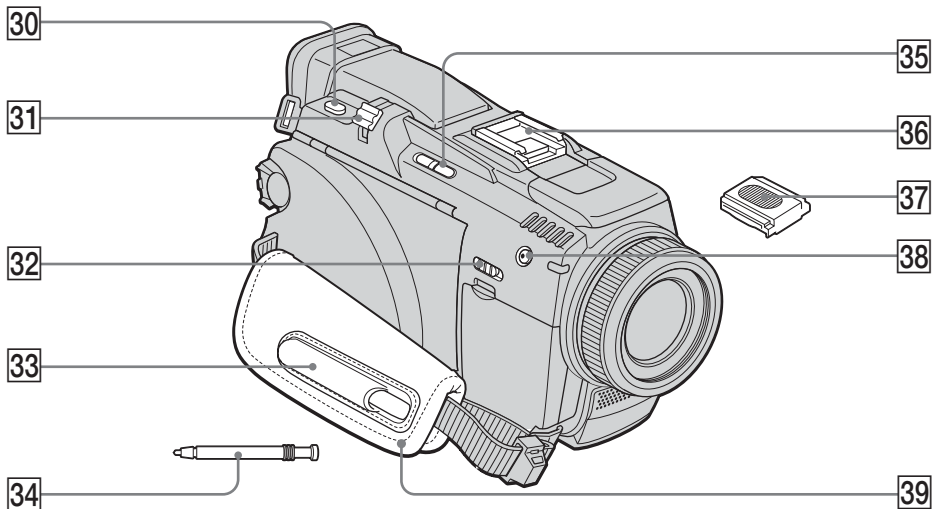

- | | |
|--|--|
| 30 PHOTO button (p. 44, 107, 114) | 35 EDITSEARCH button (p. 35) |
| 31 Power zoom lever (p. 31, 71, 133) | 36 Intelligent accessory shoe (p. 92) |
| 32 NIGHTSHOT switch (p. 32) | 37 Shoe cover (p. 92) |
| 33 Stylus holder (DCR-TRV80 only)
(p. 170) | 38 ⚡ (flash) button (p.111) |
| 34 Stylus (DCR-TRV80 only) (p. 170) | 39 Grip belt |



Notes on the intelligent accessory shoe

- The intelligent accessory shoe supplies power to optional accessories such as a video light or microphone.
- The intelligent accessory shoe is linked to the POWER switch, allowing you to turn the power supplied by the shoe on and off. Refer to the operating instructions of the accessory for details.
- The intelligent accessory shoe has a safety device for fixing the installed accessory securely. To connect an accessory, press down and push it to the end, and then tighten the screw.
- To remove an accessory, loosen the screw, and then press down and pull out the accessory.

Identifying parts and controls

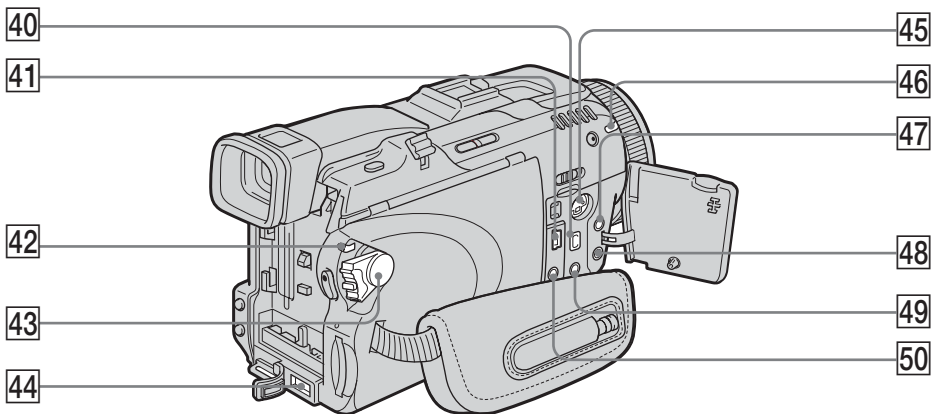

40  DV Interface (p. 76, 87, 167)

The  DV Interface is i.LINK compatible.

41  (USB) jack (p. 141)

42 LOCK switch (p. 26)

43 POWER switch (p. 25)

44 DC IN jack (p. 16)

45 S VIDEO jack (p. 42)

46  (Bluetooth) lamp (DCR-TRV80 only)
(p. 169)

47  (LANC) jack (blue)

48 MIC (PLUG IN POWER) jack (red)
Connect an external microphone (optional). This jack also accepts a “plug-in-power” microphone. When the external microphone is connected, it takes precedence.

49  (headphones) jack (green)
When you use headphones, the speaker on your camcorder is silent.

50 AUDIO/VIDEO jack (p. 42, 76, 87, 167)

About (Bluetooth) lamp (DCR-TRV80 only)

The blue lamp lights up when your camcorder is exchanging data with a device which has Bluetooth function.

Identifying parts and controls

Remote Commander

The buttons that have the same name on the Remote Commander as on your camcorder function identically to the buttons on your camcorder.

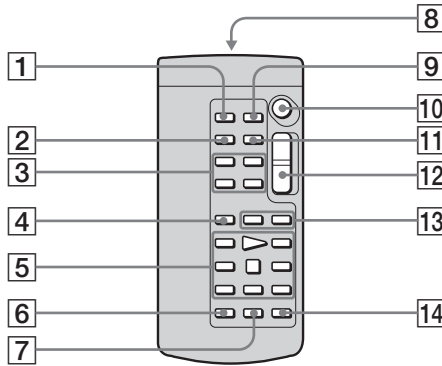

- | | |
|---|---|
| 1 PHOTO button (p. 44, 107, 114) | 8 Transmitter
Point toward the remote sensor to control your camcorder after turning on your camcorder. |
| 2 DISPLAY button (p. 38) | 9 ZERO SET MEMORY button (p. 72) |
| 3 Memory control buttons | 10 START/STOP button (p. 25) |
| 4 SEARCH MODE button (p. 73, 74) | 11 DATA CODE button (p. 38) |
| 5 Video control buttons (p. 40) | 12 Power zoom button (p. 31, 71, 133) |
| 6 REC button | 13 ◀▶ buttons (p. 73, 74) |
| 7 MARK button (p. 84) | 14 AUDIO DUB button (p. 93) |

To prepare the Remote Commander

Insert two size AA (R6) batteries by matching the + and - on the batteries to the + and - in the battery compartment.

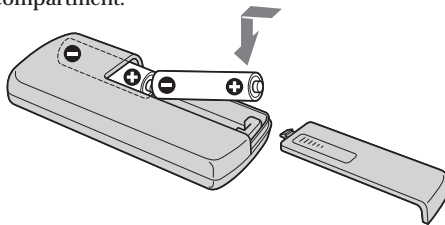

Notes on the Remote Commander

- Point the remote sensor away from strong light sources such as direct sunlight or overhead lighting. Otherwise, the Remote Commander may not function properly.
- Your camcorder works in the Commander mode VTR 2. Commander modes 1, 2 and 3 are used to distinguish your camcorder from other Sony VCRs to avoid erroneous remote control operation. If you use another Sony VCR in the Commander mode VTR 2, we recommend changing the Commander mode or covering the sensor of the VCR with black paper.

Identifying parts and controls

Operation indicators

LCD screen and Viewfinder

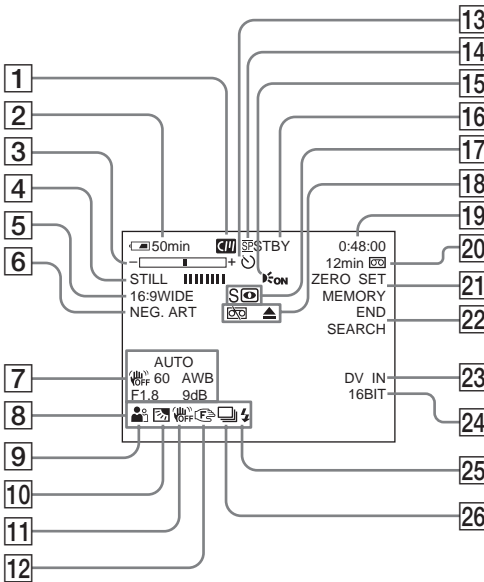

Display window

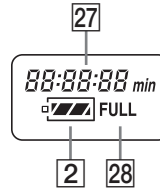

- 1 Cassette Memory (p. 12, 194)
- 2 Remaining battery time (p. 27)
- 3 Zoom (p. 31)/Exposure (p. 59)/
Data file name (p. 128)
- 4 Digital effect (p. 54, 70)/MEMORY MIX
(p. 116)/Fader (p. 50)
- 5 16:9WIDE (p. 48)
- 6 Picture effect (p. 53, 69)
- 7 Data code (p. 39)
- 8 Volume (p. 37)/Date (p. 27)/Time
(p. 27)
- 9 PROGRAM AE (p. 57)
- 10 Back light (p. 32)
- 11 SteadyShot off (p. 174)
- 12 Manual focus/Expanded focus (p. 61)
- 13 Self-timer (p. 46, 122)
- 14 Recording mode (p. 27)
- 15 HOLOGRAM AF (p. 113)
- 16 STBY/REC (p. 27)/Video control mode
(p. 40)/Image size (p. 104)/Image
quality (p. 103)
- 17 NIGHTSHOT (p. 32)/SUPER NIGHTSHOT
(p. 33)/COLOR SLOW SHUTTER (p. 33)
- 18 Warning (p. 192)
- 19 Time code (p. 27)/Tape counter
(p. 27, 39)/Self-diagnosis (p. 191)/Photo
recording (p. 44, 107)/Image number
(p. 128)/Playback folder (p. 132)
- 20 Remaining tape (p. 27)/Memory
playback (p. 128)
- 21 ZERO SET MEMORY (p. 72)
- 22 END SEARCH (p. 35)
- 23 A/V → DV (p. 167)/DV IN (p. 88)
- 24 Audio mode (p. 179)/Recording folder
(p. 127)
- 25 Flash (p. 111)
This indicator appears only when the
flash is in use.
- 26 Continuous photo recording (p. 109)
- 27 Remaining battery time (p. 27)/Tape
counter (p. 27, 39)/Image number/
Memory capacity/Time code (p. 27)/
Self-diagnosis (p. 191)
- 28 FULL charge (p. 16)

Index

A, B

AC Adaptor	16
Adjusting the viewfinder	30
Audio dubbing	91
AUDIO MIX	175
AUDIO MODE	179
Auto red-eye reduction	111
AUTO SHTR	173
A/V connecting cable	42, 76, 87, 167
BACK LIGHT	32
Battery Info	18
Battery pack	15
BEEP	181
BOUNCE	50

C, D

CALIBRATION	204
Cassette Memory	12, 194
C. CHROM	116
Charging battery pack	16
Charging built-in rechargeable battery	204
CLEANING CASSETTE	203
Clock set	20
Color Slow Shutter	33
Continuous photo recording	109
Data code	38
Date search	74
DEMO MODE	180
Digital effect	54, 70
Digital program editing	78, 125
DISPLAY	38
DOT	50
Dual sound track tape	195

E

Edit search	36
End search	35
Expanded focus	61
EXP BRKTG	109

F, G, H

Fader	50
Flash	111
FLASH	54
Flexible Spot Meter	60
Format	177
Frame recording	65
Full charge	16
Grip belt	213
⦿ (headphone) jack	214
Heads	203
HiFi SOUND	175
HIGH SPEED	109

HOLOGRAM AF	113
-------------------	-----

I, J, K, L

i.LINK	199
i.LINK cable	76, 87, 167
Image protection	135
Image quality	103
Image size	104
Image Transport	171
Index screen	129
“InfoLITHIUM” battery pack	197
Infrared rays emitter	32, 80
Insert editing	89
Intelligent accessory shoe	92, 213
Interval Recording	64
Interval Photo Recording	119
JPEG	100
Labeling a cassette	98
LANC jack	214
LUMI	54

M, N

Main sound	195
Manual exposure	59
Manual focus	61
M. CHROM	116
M. LUMI	116
MEMORY MIX	116
Memory PB ZOOM	133
Memory Photo recording	107
“Memory Stick”	100
“Memory Stick” capacity	104, 106
Menu settings	172
Mirror mode	29
Moisture condensation	202
MONOTONE	50
MOSC. FADER	50
M. OVERLAP	116
MPEG	100
Network function	169
NIGHTSHOT	32
NORMAL	109
NORM. FADER	50
NTSC system	201

O, P, Q

OLD MOVIE	54
OVERLAP	50
Operation indicators	216
PB FOLDR	132
Picture effect	53, 69
Picture search	40
Playback time	18
Print mark	140

Progressive Recording Mode	66
PROGRAM AE	57

R

REC FOLDER	127
Recording time	17
Rec Review	36
Remaining battery time indicator	27
Remaining tape indicator	27
Remote Camera	171
Remote Commander	215
Remote sensor	212
RESET	210
Resize	139

S

Self-diagnosis display	191
Self-timer recording	46, 122
SHARPNESS	173
Signal convert function	167
Skip scan	40
Slide show	134
SLOW SHTR	54
SPOT FOCUS	63
STEADYSHOT	174
Stereo tape	195
STILL	54
Sub sound	195
Super NightShot	33
S VIDEO jack	42

T, U, V

Tape counter	27
Tape PB ZOOM	71
Telephoto	31
Time code	27
Title	95
Title search	73
Touch panel	23
TRAIL	54
Transition	26
TV color systems	201
USB jack	141
USB Streaming	154

W, X, Y, Z

Warning indicators	192
Warning messages	193
White balance	47
Wide-angle	31
Wide mode	48
WIPE	50
Write-protect tab	100
Zero set memory	72
Zoom	31

<http://www.sony.net/>



Printed on 100% recycled paper using
VOC (Volatile Organic Compound)-free
vegetable oil based ink.

Printed in Japan



3 0 8 0 1 6 2 1 2

Download from [Www.Somanuals.com](http://www.Somanuals.com). All Manuals Search And Download.

Free Manuals Download Website

<http://myh66.com>

<http://usermanuals.us>

<http://www.somanuals.com>

<http://www.4manuals.cc>

<http://www.manual-lib.com>

<http://www.404manual.com>

<http://www.luxmanual.com>

<http://aubethermostatmanual.com>

Golf course search by state

<http://golfingnear.com>

Email search by domain

<http://emailbydomain.com>

Auto manuals search

<http://auto.somanuals.com>

TV manuals search

<http://tv.somanuals.com>