

- ▶ Operation Search
- ▶ Before use
- ▶ Getting started
- ▶ Recording
- ▶ Playback
- ▶ Playing images on a TV
- ▶ Saving images with a computer
- ▶ Using the Wi-Fi function
- ▶ Customizing your camcorder
- ▶ Troubleshooting
- ▶ Maintenance and precautions

[→ Contents list](#)

HDR-MV1

Music Video Recorder User Guide

Use this manual if you encounter any problems, or have any questions about the camcorder.



[▲ Back to top](#)

Copyright 2013 Sony Corporation

▶ **Operation Search**

▶ Before use

▶ Getting started

▶ Recording

▶ Playback

▶ Playing images on a TV

▶ Saving images with a computer

▶ Using the Wi-Fi function

▶ Customizing your camcorder

▶ Troubleshooting

▶ Maintenance and precautions

[→ Contents list](#)

Operation Search

Operation Search

[Search by operation](#)

[▲ Back to top](#)

Copyright 2013 Sony Corporation

- ▶ Operation Search
- ▶ **Before use**
- ▶ Getting started
- ▶ Recording
- ▶ Playback
- ▶ Playing images on a TV
- ▶ Saving images with a computer
- ▶ Using the Wi-Fi function
- ▶ Customizing your camcorder
- ▶ Troubleshooting
- ▶ Maintenance and precautions

[→ Contents list](#)

Before use

How to use this User Guide

[How to use this User Guide](#)

Parts and controls/Screen indicators

[Parts and controls](#)

[Screen indicators](#)

About language setting

[About language setting](#)

Operating your camcorder

[Selecting items on the LCD screen](#)

[▲ Back to top](#)

Copyright 2013 Sony Corporation

- ▶ Operation Search
- ▶ Before use
- ▶ Getting started
- ▶ Recording
- ▶ Playback
- ▶ Playing images on a TV
- ▶ Saving images with a computer
- ▶ Using the Wi-Fi function
- ▶ Customizing your camcorder
- ▶ Troubleshooting
- ▶ Maintenance and precautions

[→ Contents list](#)

Getting started

Checking the supplied items

[Supplied items](#)

Power supply

[Attaching the battery pack](#)

[Charging the battery using your computer](#)

[Charging the battery using the AC Adaptor \(sold separately\)](#)

[Using the camcorder while supplying it with power](#)

Turning the power on, and setting the date and time

[Turning the power on, and setting the date and time](#)

Preparing the recording media

[Inserting a memory card](#)

[▲ Back to top](#)

Copyright 2013 Sony Corporation

- ▶ Operation Search
- ▶ Before use
- ▶ Getting started
- ▶ Recording
- ▶ Playback
- ▶ Playing images on a TV
- ▶ Saving images with a computer
- ▶ Using the Wi-Fi function
- ▶ Customizing your camcorder
- ▶ Troubleshooting
- ▶ Maintenance and precautions

[→ Contents list](#)

Recording

Recording

[Shooting movies](#)

[Recording sound](#)

[Screen indicators during recording](#)

Useful functions for recording

[Intelligent Auto](#)

[Audio monitoring](#)

[▲ Back to top](#)

Copyright 2013 Sony Corporation

▶ Operation Search

▶ Before use

▶ Getting started

▶ Recording

▶ Playback

▶ Playing images on a TV

▶ Saving images with a computer

▶ Using the Wi-Fi function

▶ Customizing your camcorder

▶ Troubleshooting

▶ Maintenance and precautions

[→ Contents list](#)

Playback

Playback

[▶ Playing movies/audio files](#)

[▲ Back to top](#)

Copyright 2013 Sony Corporation

- ▶ Operation Search
- ▶ Before use
- ▶ Getting started
- ▶ Recording
- ▶ Playback
- ▶ **Playing images on a TV**
- ▶ Saving images with a computer
- ▶ Using the Wi-Fi function
- ▶ Customizing your camcorder
- ▶ Troubleshooting
- ▶ Maintenance and precautions

[→ Contents list](#)

Playing images on a TV

Playing images on a high definition TV

[Connecting the camcorder to a high definition TV](#)

Playing images on a TV supporting "BRAVIA" Sync

[Using "BRAVIA" Sync](#)

[▲ Back to top](#)

Copyright 2013 Sony Corporation

- ▶ Operation Search
- ▶ Before use
- ▶ Getting started
- ▶ Recording
- ▶ Playback
- ▶ Playing images on a TV
- ▶ Saving images with a computer
- ▶ Using the Wi-Fi function
- ▶ Customizing your camcorder
- ▶ Troubleshooting
- ▶ Maintenance and precautions

[→ Contents list](#)

Saving images with a computer

Saving contents with a computer

[What you can do using a computer](#)

[Checking the computer system](#)

[Installing the editing/management software in your computer](#)

[Starting the editing/management software](#)

[Importing files to your computer without using software](#)

[▲ Back to top](#)

Copyright 2013 Sony Corporation

- ▶ Operation Search
- ▶ Before use
- ▶ Getting started
- ▶ Recording
- ▶ Playback
- ▶ Playing images on a TV
- ▶ Saving images with a computer
- ▶ Using the Wi-Fi function
- ▶ Customizing your camcorder
- ▶ Troubleshooting
- ▶ Maintenance and precautions

→ [Contents list](#)

Using the Wi-Fi function

Using the Wi-Fi function

[What you can do using the Wi-Fi function](#)

Control your camcorder via smartphone

[Using your smartphone or tablet as a remote control without using NFC](#)

[Using your smartphone or tablet as a remote control using NFC](#)

Sending movies to the smartphone

[Transferring movies to your smartphone or tablet without using NFC](#)

[Transferring movies to your smartphone or tablet using NFC](#)

Connecting a smartphone

[Connecting to your Android smartphone or tablet](#)

[Connecting to your iPhone or iPad](#)

[Connecting to your NFC-compatible Android smartphone or tablet](#)

Installing the PlayMemories Mobile

[On the "PlayMemories Mobile" software](#)

[▲ Back to top](#)

- ▶ Operation Search
- ▶ Before use
- ▶ Getting started
- ▶ Recording
- ▶ Playback
- ▶ Playing images on a TV
- ▶ Saving images with a computer
- ▶ Using the Wi-Fi function
- ▶ Customizing your camcorder
- ▶ Troubleshooting
- ▶ Maintenance and precautions

[→ Contents list](#)

Customizing your camcorder

Using menu items

[Setting up menu items](#)

Recording Mode

[Movie](#)

[Audio](#)

Camera/Audio

[White Balance](#)

[Exposure](#)

[Low Lux](#)

[Scene Selection](#)

[Fader](#)

[Auto Back Light](#)

[Face Detection](#)

[Audio Format](#)

[Low Cut Filter](#)

[Int. Mic. Rec. Level](#)

[Ext. Mic. Rec. Level](#)

[Audio Output Timing](#)

[Volume](#)

[Ext. Audio Input Set](#)

[Ctrl with Smartphone](#)

[My Button](#)

[Grid Line](#)

[Display Setting](#)

[Audio Level Display](#)

[Auto Monitor Off](#)

Image Quality/Size

[REC Mode](#)

Playback Function

[Playback Function](#)

Edit/Copy

Send to Smartphone

Delete

Protect

Setup

Media Info

Format

Repair Img. DB F.

File Number

Edit Device Name

SSID/PW Reset

HDMI Resolution

CTRL FOR HDMI (Control for HDMI)

USB Connect

USB Power Supply

USB LUN Setting

Beep

Monitor Brightness

Language Setting

Airplane Mode

Power Save

Initialize

Date & Time Setting

Area Setting

[▲ Back to top](#)

Copyright 2013 Sony Corporation

- ▶ Operation Search
- ▶ Before use
- ▶ Getting started
- ▶ Recording
- ▶ Playback
- ▶ Playing images on a TV
- ▶ Saving images with a computer
- ▶ Using the Wi-Fi function
- ▶ Customizing your camcorder
- ▶ Troubleshooting
- ▶ Maintenance and precautions

[→ Contents list](#)

Troubleshooting

If you have problems

[If you have problems](#)

Troubleshooting

[Overall operations](#)

[Batteries/power sources](#)

[LCD screen](#)

[Memory card](#)

[Recording](#)

[Playback](#)

[Playback on the TV](#)

[Connecting to a computer](#)

[Wi-Fi](#)

[Self-diagnosis display/Warning indicators](#)

[Self-diagnosis display](#)

[Warning Indicators](#)

[▲ Back to top](#)

- ▶ [Operation Search](#)
- ▶ [Before use](#)
- ▶ [Getting started](#)
- ▶ [Recording](#)
- ▶ [Playback](#)
- ▶ [Playing images on a TV](#)
- ▶ [Saving images with a computer](#)
- ▶ [Using the Wi-Fi function](#)
- ▶ [Customizing your camcorder](#)
- ▶ [Troubleshooting](#)
- ▶ [Maintenance and precautions](#)

[→ Contents list](#)

Maintenance and precautions

Maintenance and precautions

[About the memory card](#)

[About the battery pack](#)

About handling of your camcorder

[On use and care](#)

[On moisture condensation](#)

[On charging the pre-installed rechargeable battery](#)

[Note on disposal/transfer of the memory card](#)

Recording time of movies/sound

[Charging time](#)

[Expected time of recording and playback with the battery pack](#)

[Expected shooting time of movies](#)

[Expected recording time of sound](#)

Using your camcorder abroad

[Using your camcorder abroad](#)

On trademarks

[On trademarks](#)

License

[Notes on the License](#)

Specifications

[Specifications](#)

[▲ Back to top](#)

- ▶ Operation Search
- ▶ Before use
- ▶ Getting started
- ▶ Recording
- ▶ Playback
- ▶ Playing images on a TV
- ▶ Saving images with a computer
- ▶ Using the Wi-Fi function
- ▶ Customizing your camcorder
- ▶ Troubleshooting
- ▶ Maintenance and precautions

[→ Contents list](#)

Contents list

Operation Search

Operation Search

[Search by operation](#)

[▲ Back to top](#)

Before use

How to use this User Guide

[How to use this User Guide](#)

Parts and controls/Screen indicators

[Parts and controls](#)

[Screen indicators](#)

About language setting

[About language setting](#)

Operating your camcorder

[Selecting items on the LCD screen](#)

[▲ Back to top](#)

Getting started

Checking the supplied items

[Supplied items](#)

Power supply

[Attaching the battery pack](#)

[Charging the battery using your computer](#)

[Charging the battery using the AC Adaptor \(sold separately\)](#)

[Using the camcorder while supplying it with power](#)

Turning the power on, and setting the date and time

[Turning the power on, and setting the date and time](#)

Preparing the recording media

[Inserting a memory card](#)

Recording

Recording

[Shooting movies](#)

[Recording sound](#)

[Screen indicators during recording](#)

Useful functions for recording

[Intelligent Auto](#)

[Audio monitoring](#)

[▲ Back to top](#)

Playback

Playback

[Playing movies/audio files](#)

[▲ Back to top](#)

Playing images on a TV

Playing images on a high definition TV

[Connecting the camcorder to a high definition TV](#)

Playing images on a TV supporting "BRAVIA" Sync

[Using "BRAVIA" Sync](#)

[▲ Back to top](#)

Saving images with a computer

Saving contents with a computer

[What you can do using a computer](#)

[Checking the computer system](#)

[Installing the editing/management software in your computer](#)

[Starting the editing/management software](#)

[Importing files to your computer without using software](#)

[▲ Back to top](#)

Using the Wi-Fi function

Using the Wi-Fi function

[What you can do using the Wi-Fi function](#)

Control your camcorder via smartphone

[Using your smartphone or tablet as a remote control without using NFC](#)

[Using your smartphone or tablet as a remote control using NFC](#)

Sending movies to the smartphone

[Transferring movies to your smartphone or tablet without using NFC](#)

[Transferring movies to your smartphone or tablet using NFC](#)

Connecting a smartphone

[Connecting to your Android smartphone or tablet](#)

[Connecting to your iPhone or iPad](#)

[Connecting to your NFC-compatible Android smartphone or tablet](#)

Installing the PlayMemories Mobile

[On the “PlayMemories Mobile” software](#)

[▲ Back to top](#)

Customizing your camcorder

Using menu items

[Setting up menu items](#)

Recording Mode

[Movie](#)

[Audio](#)

Camera/Audio

[White Balance](#)

[Exposure](#)

[Low Lux](#)

[Scene Selection](#)

[Fader](#)

[Auto Back Light](#)

[Face Detection](#)

[Audio Format](#)

[Low Cut Filter](#)

[Int. Mic. Rec. Level](#)

[Ext. Mic. Rec. Level](#)

[Audio Output Timing](#)

[Volume](#)

[Ext. Audio Input Set](#)

[Ctrl with Smartphone](#)

- My Button
- Grid Line
- Display Setting
- Audio Level Display
- Auto Monitor Off
- Image Quality/Size
 - REC Mode
- Playback Function
 - Playback Function
- Edit/Copy
 - Send to Smartphone
 - Delete
 - Protect
- Setup
 - Media Info
 - Format
 - Repair Img. DB F.
 - File Number
 - Edit Device Name
 - SSID/PW Reset
 - HDMI Resolution
 - CTRL FOR HDMI (Control for HDMI)
 - USB Connect
 - USB Power Supply
 - USB LUN Setting
 - Beep
 - Monitor Brightness
 - Language Setting
 - Airplane Mode
 - Power Save
 - Initialize
 - Date & Time Setting
 - Area Setting

[▲ Back to top](#)

| Troubleshooting

If you have problems

[If you have problems](#)

Troubleshooting

[Overall operations](#)

[Batteries/power sources](#)

[LCD screen](#)

[Memory card](#)

[Recording](#)

[Playback](#)

[Playback on the TV](#)

[Connecting to a computer](#)

[Wi-Fi](#)

Self-diagnosis display/Warning indicators

[Self-diagnosis display](#)

[Warning Indicators](#)

[▲ Back to top](#)

| Maintenance and precautions

Maintenance and precautions

[About the memory card](#)

[About the battery pack](#)

About handling of your camcorder

[On use and care](#)

[On moisture condensation](#)

[On charging the pre-installed rechargeable battery](#)

[Note on disposal/transfer of the memory card](#)

Recording time of movies/sound

[Charging time](#)

[Expected time of recording and playback with the battery pack](#)

[Expected shooting time of movies](#)

[Expected recording time of sound](#)

Using your camcorder abroad

[Using your camcorder abroad](#)

On trademarks

[On trademarks](#)

License

[Notes on the License](#)
Specifications
[Specifications](#)

[▲ Back to top](#)

Copyright 2013 Sony Corporation

[▶ Operation Search](#)[▶ Before use](#)[▶ Getting started](#)[▶ Recording](#)[▶ Playback](#)[▶ Playing images on a TV](#)[▶ Saving images with a computer](#)[▶ Using the Wi-Fi function](#)[▶ Customizing your camcorder](#)[▶ Troubleshooting](#)[▶ Maintenance and precautions](#)[→ Contents list](#)

Search by operation

Setting the date and time

[Date & Time Setting](#)[Area Setting](#)

Identifying part names

[Parts and controls](#)

Recording audio files

[Recording sound](#)

Selecting the suitable setting automatically for the recording situation

[Useful functions for recording](#)

Recording people clearly

[Face Detection](#)[Scene Selection \(Spotlight\)](#)

Selecting a movie shooting mode

[REC Mode](#)

Changing the audio recording format

[Audio Format](#)

Adjusting the internal microphone level

[Int. Mic. Rec. Level](#)

Reducing low frequency sound such as noise from air conditioners

[Low Cut Filter](#)

Monitoring sound

[Audio monitoring](#)

Synchronizing the monitored sound with the LCD screen or with movies output via HDMI

[Audio Output Timing](#)

Using an external MTR or microphone

[Ext. Audio Input Set](#)

Shooting movies in a dim place

[Low Lux](#)

Recording faces of people on a stage clearly

[Scene Selection \(Spotlight\)](#)

Saving battery power

[Power Save](#)

Recording without worrying about the remaining battery power

[Using the camcorder while supplying it with power](#)

Playing images on a TV

[Connecting the camcorder to a high definition TV](#)

Deleting files

[Delete](#)

[▲ Back to top](#)

Copyright 2013 Sony Corporation

[Top page](#) > [Before use](#) > [How to use this User Guide](#) > [How to use this User Guide](#)

Guide

- ▶ Operation Search
- ▶ Before use
- ▶ Getting started
- ▶ Recording
- ▶ Playback
- ▶ Playing images on a TV
- ▶ Saving images with a computer
- ▶ Using the Wi-Fi function
- ▶ Customizing your camcorder
- ▶ Troubleshooting
- ▶ Maintenance and precautions

→ [Contents list](#)

How to use this User Guide

- ▼ [Selecting a topic to display](#)
- ▼ [Searching a topic by keyword](#)
- ▼ [Returning to a previous page](#)
- ▼ [Printing out a page](#)
- ▼ [Marks and notations used in this User Guide](#)

This User Guide explains how to use each function of the camcorder, how to change settings, and how to troubleshoot a problem.

Selecting a topic to display

The following illustrations take Internet Explorer 7 as an example.

1. Click a title in the side bar on the left of the browser window.
A list of topic titles appears in the right pane.
2. Click a topic title in the list.

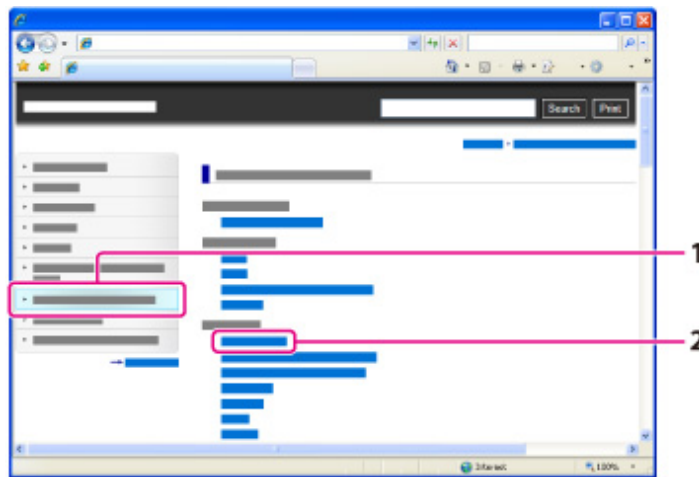

Descriptions appear in the right pane.

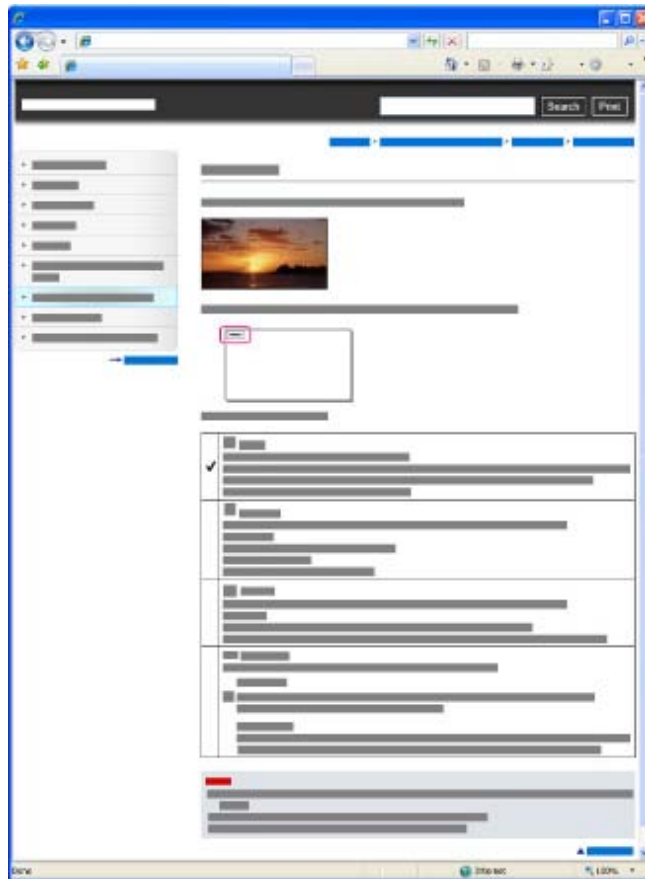

Changing the font size

Change the font size by changing the setting of your web browser. For how to change the font size setting, refer to the Help of your web browser.

Searching a topic by keyword

Enter the keyword in the search window, then click the [Search] button.

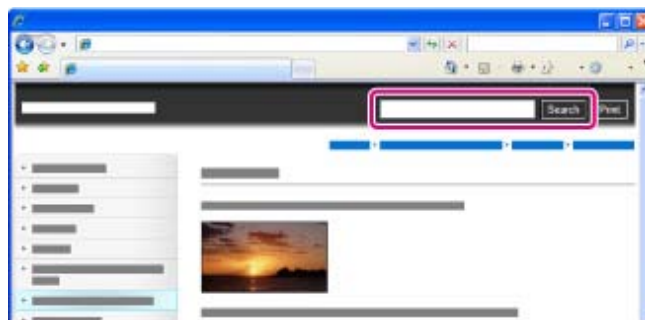

Returning to a previous page

Use the back button of your web browser or the breadcrumb trail navigation (A) to return to a page you previously viewed.

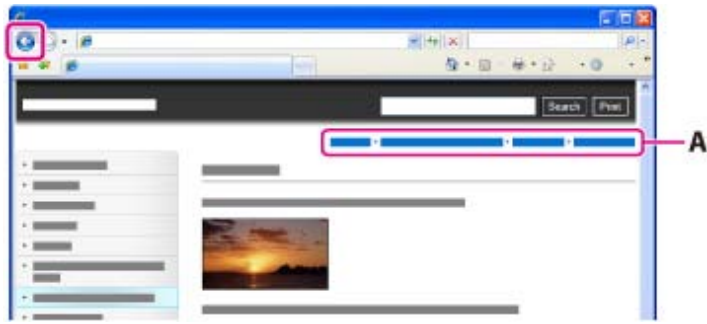

Printing out a page

Click the [Print] button to print out a page you are viewing.

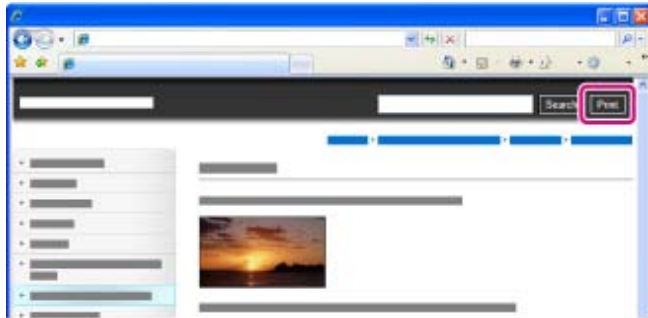

Marks and notations used in this User Guide

In this User Guide, the sequence of operations is shown by arrows (→) (A). Operate the camcorder in the order indicated.

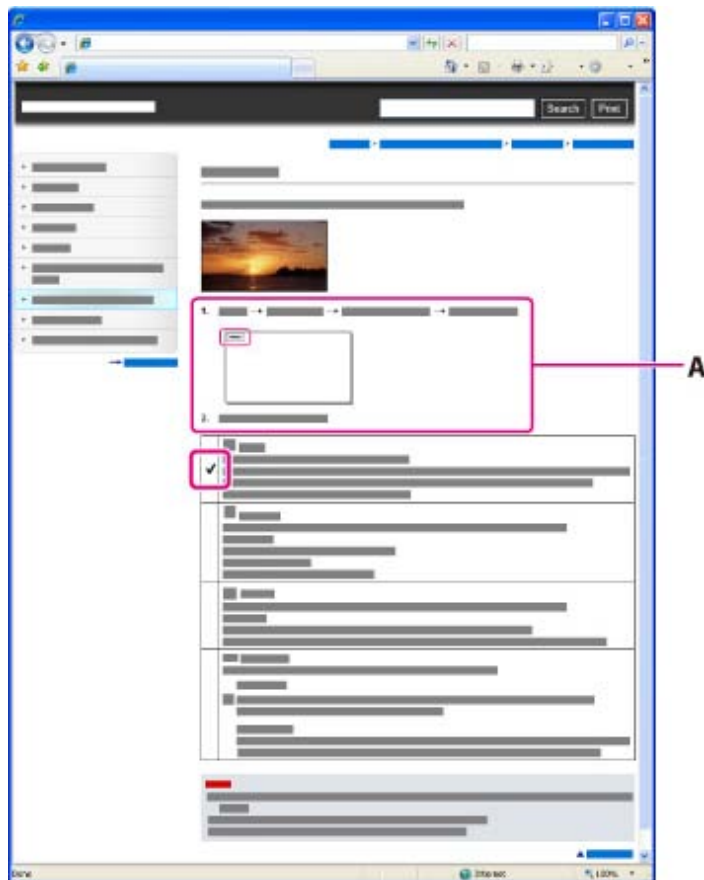

- Icons in the operating procedure sentences appear when the camcorder is in its default settings.
- The default setting is indicated by ✓.

[▲ Back to top](#)

Copyright 2013 Sony Corporation

[Top page](#) > [Before use](#) > [Parts and controls/Screen indicators](#) > [Parts and controls](#)

- ▶ Operation Search
- ▶ Before use
- ▶ Getting started
- ▶ Recording
- ▶ Playback
- ▶ Playing images on a TV
- ▶ Saving images with a computer
- ▶ Using the Wi-Fi function
- ▶ Customizing your camcorder
- ▶ Troubleshooting
- ▶ Maintenance and precautions

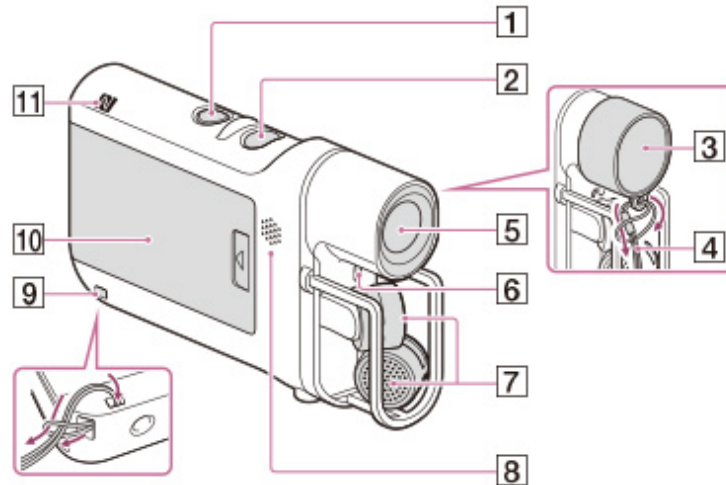

[→ Contents list](#)

Parts and controls

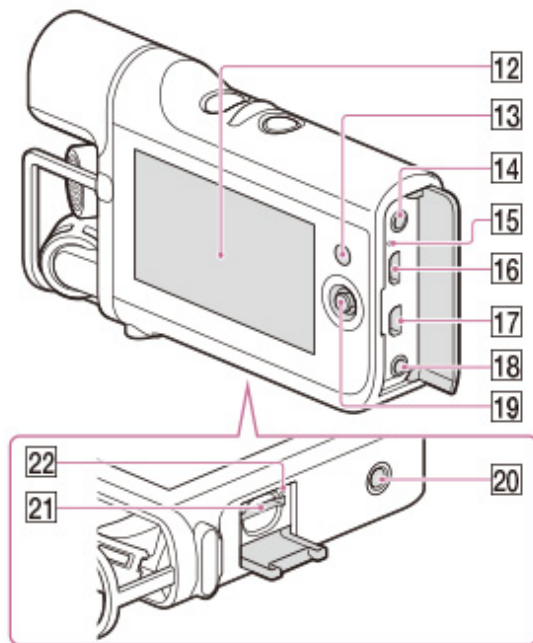

- 1** START/STOP button
- 2** POWER button
- 3** Lens cap
- 4** Cap string
- 5** Lens
- 6** Recording lamp
- 7** Microphones
- 8** Speaker
- 9** Loop for the cap string/the strap
- 10** Battery cover
- 11** **N** (N mark)
NFC: Near Field Communication



- 12** LCD screen
- 13**  (Playback) button
- 14**  (headphones) jack
- 15** CHG (charge) lamp
- 16** Multi/Micro USB Terminal
Supports Micro USB compatible devices.
- 17** Micro HDMI OUT jack
- 18** LINE IN jack/  (microphone) jack (PLUG IN POWER)
- 19** Multi-selector
- 20** Tripod receptacle
Attach a tripod (sold separately: the length of the screw must be less than 5.5 mm (7/32 in.)).
Depending on the specifications of the tripod, your camcorder may not attach in the proper direction.
- 21** Memory card slot
- 22** Memory card access lamp

[▲ Back to top](#)

Copyright 2013 Sony Corporation

- ▶ Operation Search
- ▶ Before use
- ▶ Getting started
- ▶ Recording
- ▶ Playback
- ▶ Playing images on a TV
- ▶ Saving images with a computer
- ▶ Using the Wi-Fi function
- ▶ Customizing your camcorder
- ▶ Troubleshooting
- ▶ Maintenance and precautions

[→ Contents list](#)

Screen indicators

The following indicators appear when you change the settings. Check also for the indicators that appear during recording or playing.

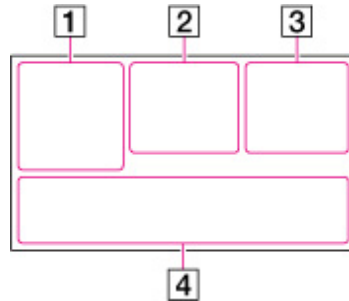













1

| Indicator | Meaning |
|-----------|---|
| | MENU button |
| | NFC |
| | Fader |
| | Face Detection |
| | Scene Selection |
| | White Balance |
| | Destination |
| | Intelligent Auto (face detection/scene detection) |
| | Airplane Mode |

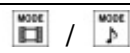
2

| Indicator | Meaning |
|-----------|---------------|
| | Warning |
| | Playback mode |

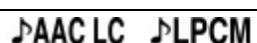
| Indicator | Meaning |
|---|---|
|  720 | Recording image quality (MP4), shooting mode (1080/720) |
|  | Remaining battery |
|  | Recording/playback/editing media |
| 0:00:00 | Counter (hour:minute:second) |
| 00min | Estimated remaining recording time |
| 100/112 | Current playing movie or audio file number/Number of total recorded movies or audio files |

| Indicator | Meaning |
|--|--|
|  | Low Lux |
|  | Exposure |
|  | Intelligent Auto |
|  | Mode switching |
|  101-0005 | Data file type/name |
|  | Audio level meter |
|  | Audio input settings (internal microphone/external microphone/other devices) |
|  | Audio Format |
|  | Low Cut Filter |
|  | Protect |

- Indicators and their positions are approximate and may differ from what you actually see.
- Some indicators may not appear, depending on your camcorder model.

[▲ Back to top](#)

Copyright 2013 Sony Corporation

[Top page](#) > [Before use](#) > [About language setting](#) > [About language setting](#)

- ▶ Operation Search
- ▶ Before use
- ▶ Getting started
- ▶ Recording
- ▶ Playback
- ▶ Playing images on a TV
- ▶ Saving images with a computer
- ▶ Using the Wi-Fi function
- ▶ Customizing your camcorder
- ▶ Troubleshooting
- ▶ Maintenance and precautions

[→ Contents list](#)

About language setting

Change the screen language before using the camcorder if necessary. The on-screen displays in each local language are used for illustrating the operating procedures. [\[Details\]](#)

Select **MENU** → [Setup] → [ General Settings] → [Language Setting] → a desired language.

[▲ Back to top](#)

Copyright 2013 Sony Corporation

[Top page](#) > [Before use](#) > [Operating your camcorder](#) > [Selecting items on the LCD screen](#)

- ▶ Operation Search
- ▶ Before use
- ▶ Getting started
- ▶ Recording
- ▶ Playback
- ▶ Playing images on a TV
- ▶ Saving images with a computer
- ▶ Using the Wi-Fi function
- ▶ Customizing your camcorder
- ▶ Troubleshooting
- ▶ Maintenance and precautions

[→ Contents list](#)

Selecting items on the LCD screen

1. Move the multi-selector towards **▼ / ▲ / ◀ / ▶** to select the desired item.
2. Press the center of the multi-selector to enter.

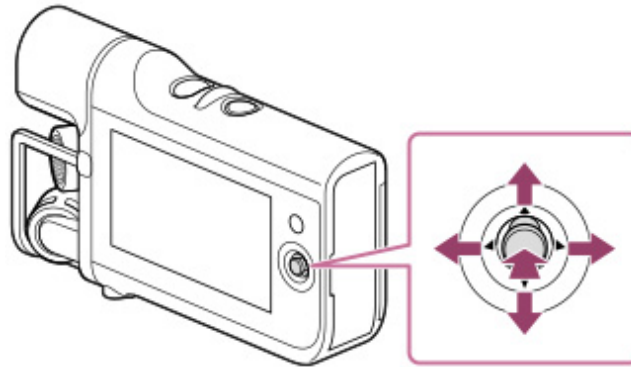

[▲ Back to top](#)

Copyright 2013 Sony Corporation

- ▶ Operation Search
- ▶ Before use
- ▶ Getting started
- ▶ Recording
- ▶ Playback
- ▶ Playing images on a TV
- ▶ Saving images with a computer
- ▶ Using the Wi-Fi function
- ▶ Customizing your camcorder
- ▶ Troubleshooting
- ▶ Maintenance and precautions

[→ Contents list](#)

Supplied items

The numbers in () indicate the supplied quantity.

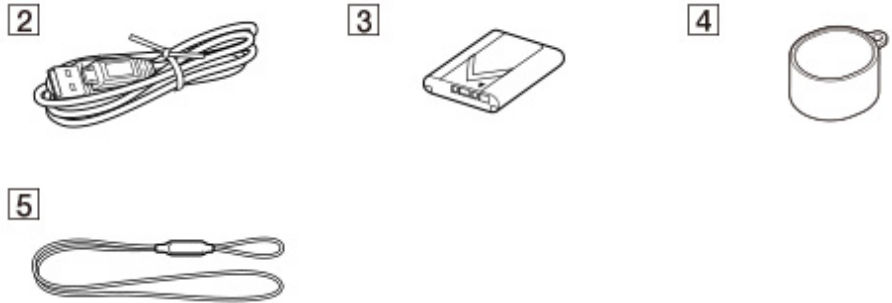

- 1** Camcorder (1)
- 2** USB cable (Micro USB cable) (1)
- 3** Rechargeable battery pack NP-BX1 (1)
- 4** Lens cap (1)
- 5** Cap string (1)
- 6** "Operating Guide" (1)

Notes

- The editing/management software can be downloaded from the Sony website. [\[Details\]](#)

[▲ Back to top](#)

Copyright 2013 Sony Corporation

- ▶ Operation Search
- ▶ Before use
- ▶ Getting started
- ▶ Recording
- ▶ Playback
- ▶ Playing images on a TV
- ▶ Saving images with a computer
- ▶ Using the Wi-Fi function
- ▶ Customizing your camcorder
- ▶ Troubleshooting
- ▶ Maintenance and precautions

[→ Contents list](#)

Attaching the battery pack

1. Remove the battery cover.

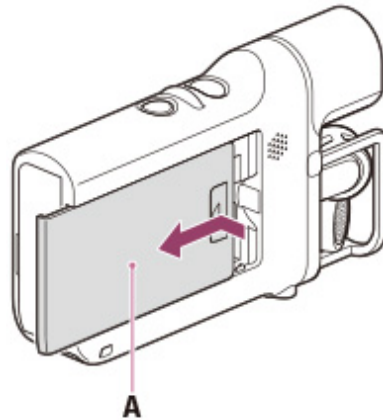

A: Battery cover

2. Attach the battery pack in the direction of the arrows.

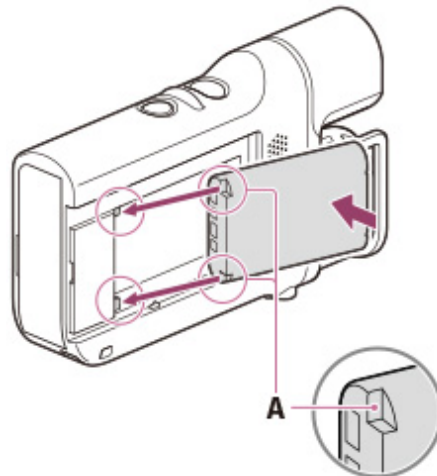

A: Notch

3. Attach the battery cover.

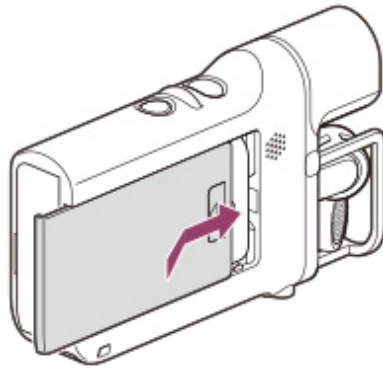

Notes

- You can use only NP-BX1 (supplied) with your camcorder.
- In the default setting, the camcorder turns itself off not to consume the battery power when no operations are performed for about 5 minutes ([Power Save]).
- To prevent staining the terminal, short-circuiting, etc., be sure to use a plastic bag to keep away from metal materials when carrying or storing the battery pack.

To remove the battery pack

Turn off your camcorder, remove the battery cover, and then remove the battery pack.

- Be careful not to drop the battery pack.

To check the remaining battery power

An icon indicating the remaining battery power is displayed.

| | | | | |
|------|---|-----|-------|--|
| | | | | |
| High | → | Low | Empty | |

- It will take approximately 1 minute to display the correct remaining battery power.
- The remaining battery power may not be displayed correctly depending on ambient conditions and the environment in which you are using your camcorder.
- Your camcorder cannot display the remaining battery life in minutes using the "InfoLITHIUM" battery.

[▲ Back to top](#)

Copyright 2013 Sony Corporation

[Top page](#) > [Getting started](#) > [Power supply](#) > [Charging the battery using your computer](#)

▶ Operation Search

▶ Before use

▶ Getting started

▶ Recording

▶ Playback

▶ Playing images on a TV

▶ Saving images with a computer

▶ Using the Wi-Fi function

▶ Customizing your camcorder

▶ Troubleshooting

▶ Maintenance and precautions

→ [Contents list](#)

Charging the battery using your computer

1. Attach the battery pack. [\[Details\]](#)
2. When the camcorder is on, press the POWER button to turn it off.

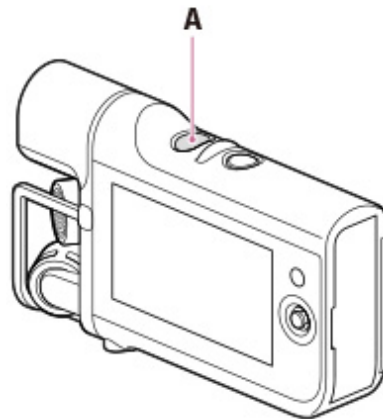

A: POWER button

3. Open the jack cover, and then connect the camcorder to a running computer using the USB cable (supplied).

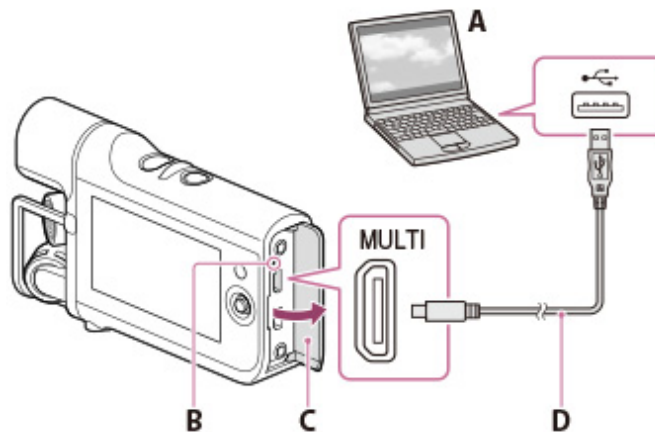

A: USB jack (computer)

B: CHG (charge) lamp

C: Jack cover

D: USB cable (supplied)

- The CHG (charge) lamp is lit.
- The CHG (charge) lamp turns off when the battery pack is fully charged. Disconnect the USB cable (supplied) from your camcorder.

Charging time

Approximately 245 minutes are required to fully charge a fully discharged battery pack.

- The charging time is measured when charging the camcorder at a room temperature of 25 °C (77 °F). It is recommended that you charge the battery in a temperature range of 10 °C to 30 °C (50 °F to 86 °F).

[▲ Back to top](#)

Copyright 2013 Sony Corporation

[Top page](#) > [Getting started](#) > [Power supply](#) > [Charging the battery using the AC Adaptor \(sold separately\)](#)

- ▶ Operation Search
- ▶ Before use
- ▶ Getting started
- ▶ Recording
- ▶ Playback
- ▶ Playing images on a TV
- ▶ Saving images with a computer
- ▶ Using the Wi-Fi function
- ▶ Customizing your camcorder
- ▶ Troubleshooting
- ▶ Maintenance and precautions

[→ Contents list](#)

Charging the battery using the AC Adaptor (sold separately)

1. Attach the battery pack. [\[Details\]](#)
2. When the camcorder is on, press the POWER button to turn it off.

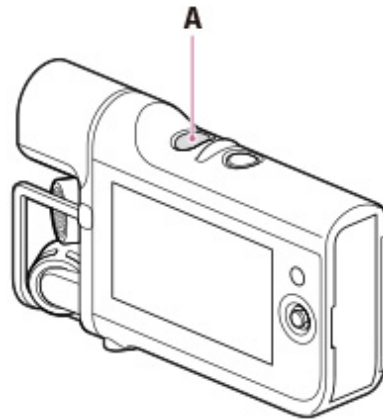

A: POWER button

3. Open the jack cover, and then connect the camcorder to a wall outlet (wall socket) using the USB cable (supplied) and AC-UD10 AC Adaptor (sold separately).

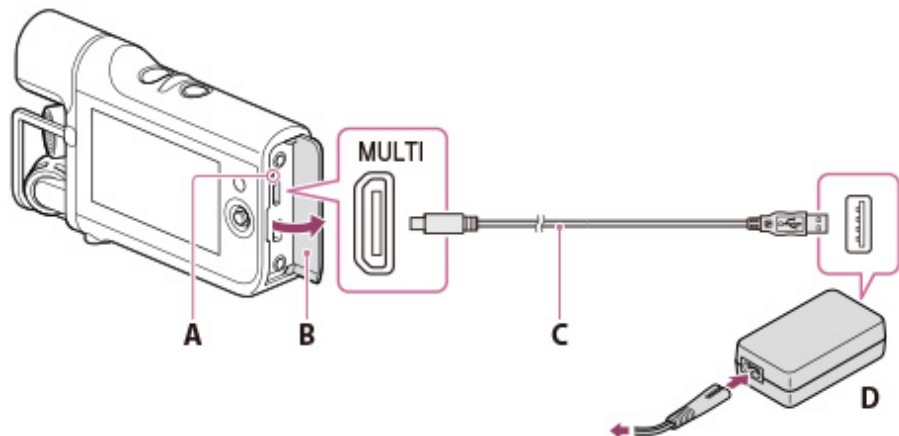

A: CHG (charge) lamp
 B: Jack cover
 C: USB cable (supplied)
 D: AC-UD10 (sold separately)

Charging time

Approximately 155 minutes are required to fully charge a fully discharged battery pack.

- The charging time is measured when charging the camcorder at a room temperature of 25 °C (77 °F). It is recommended that you charge the battery in a temperature range of 10 °C to 30 °C (50 °F to 86 °F).

[▲ Back to top](#)

Copyright 2013 Sony Corporation

- ▶ Operation Search
- ▶ Before use
- ▶ Getting started
- ▶ Recording
- ▶ Playback
- ▶ Playing images on a TV
- ▶ Saving images with a computer
- ▶ Using the Wi-Fi function
- ▶ Customizing your camcorder
- ▶ Troubleshooting
- ▶ Maintenance and precautions

→ [Contents list](#)

[Top page](#) > [Getting started](#) > [Power supply](#) > [Using the camcorder while supplying it with power](#)

Using the camcorder while supplying it with power

You can use the camcorder while supplying power by connecting the AC-UD10 AC Adaptor (sold separately) to the camcorder.

1. Attach the battery pack. [\[Details\]](#)
2. Open the jack cover, and then connect the camcorder to a wall outlet (wall socket) using the USB cable (supplied) and AC-UD10 AC Adaptor (sold separately).

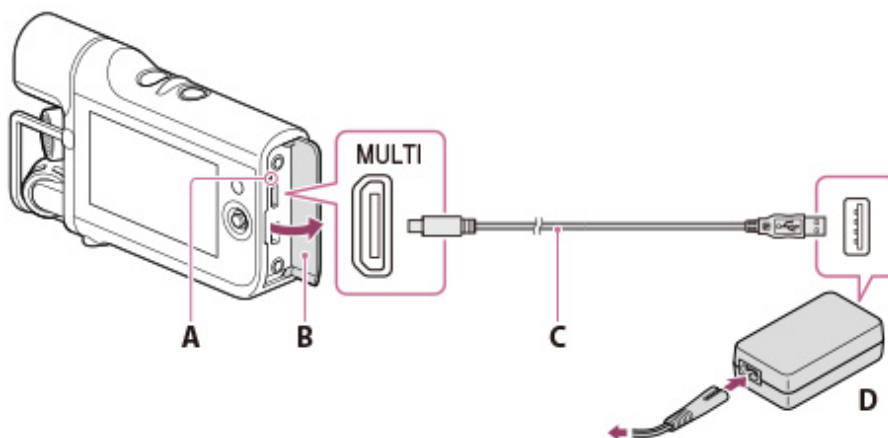

- A: CHG (charge) lamp
- B: Jack cover
- C: USB cable (supplied)
- D: AC-UD10 (sold separately)

3. Press the POWER button to turn on the camcorder for using it.

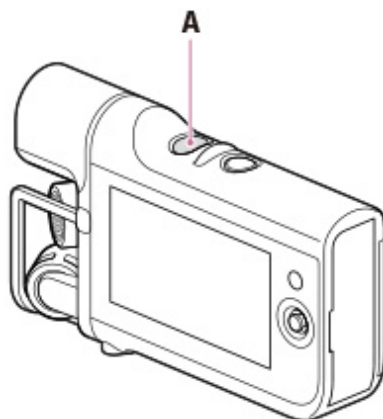

- A: POWER button

Notes

- You may not be able to supply power to the camcorder without the battery pack attached.

Supplying power to the camcorder from a computer

By connecting the camcorder to a computer using the USB cable (supplied), you can play back or import files to the computer while supplying power to the camcorder.

Notes

- The recording function is not available while supplying power from the computer.
- When you connect the camcorder to a computer using the USB cable during playback, the USB connection screen appears. It will turn to the playback screen if you select → [yes].

[▲ Back to top](#)

Copyright 2013 Sony Corporation

[Top page](#) > [Getting started](#) > [Turning the power on, and setting the date and time](#) > [Turning the power on, and setting the date and time](#)

- ▶ Operation Search
- ▶ Before use
- ▶ Getting started
- ▶ Recording
- ▶ Playback
- ▶ Playing images on a TV
- ▶ Saving images with a computer
- ▶ Using the Wi-Fi function
- ▶ Customizing your camcorder
- ▶ Troubleshooting
- ▶ Maintenance and precautions

[→ Contents list](#)

Turning the power on, and setting the date and time

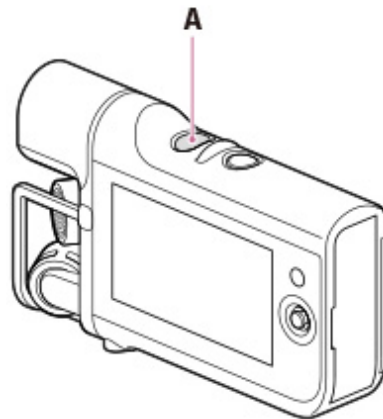

1. Turn on the camcorder by pressing the POWER button.







A: POWER button

2. Select the desired language, using the multi-selector.

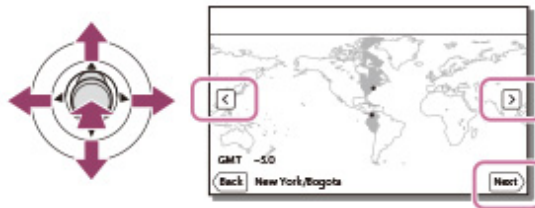

3. Select the desired geographical area with  / , then select [Next].



4. Set [Daylight Savings] or [Summer Time], select the date format and the date and time.
 - If you set [Daylight Savings] or [Summer Time] to [On], the clock advances 1 hour.
 - When you select the date and time, select one of the items and adjust the value with  / .
 - When you select , the date and time setting operation is complete.

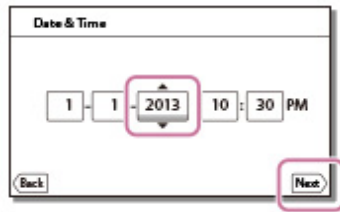

| To change the language setting

You can change the on-screen displays to show messages in a specified language. Select **MENU** → [Setup] → [General Settings] → [Language Setting] → a desired language.

| To turn off the power

Press the POWER button.

Related topics

To set the date and time again: [[Date & Time Setting](#)]

[▲ Back to top](#)

Copyright 2013 Sony Corporation

- ▶ Operation Search
- ▶ Before use
- ▶ Getting started
- ▶ Recording
- ▶ Playback
- ▶ Playing images on a TV
- ▶ Saving images with a computer
- ▶ Using the Wi-Fi function
- ▶ Customizing your camcorder
- ▶ Troubleshooting
- ▶ Maintenance and precautions

→ [Contents list](#)

[Top page](#) > [Getting started](#) > [Preparing the recording media](#) > [Inserting a memory card](#)

Inserting a memory card

1. Open the memory card cover.
2. Install a memory card straight in the direction illustrated.
3. Close the memory card cover.

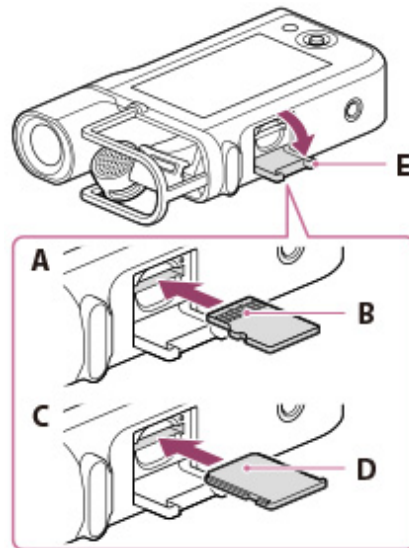

- A: When inserting a microSD memory card
 B: Terminal
 C: When inserting "Memory Stick Micro" media
 D: Printed surface
 E: Memory card cover

Notes

- The [Preparing image database file. Please wait.] screen appears if you insert a new memory card. Wait until the screen disappears.
- Insert the memory card straight in the right direction so that the camcorder can recognize it.
- Make sure any warning message related to the memory card is not displayed. [\[Details\]](#)
- If you insert a memory card in the wrong direction or at an angle, you cannot use it.
- Do not insert more than 1 memory card.
- To ensure stable operation of the memory card, it is recommended to format the memory card with your camcorder before the first use. Formatting the memory card will erase all the data stored on it and the data will be irrecoverable. Save your important data on your computer, etc.
- If [Failed to create a new Image Database File. It may be possible that there is not enough free space.] is displayed, format the memory card. [\[Details\]](#)

- Confirm the direction of the memory card. If you forcibly insert the memory card in the wrong direction, the memory card, memory card slot, or recorded files may be damaged.
- Insert a memory card that fits the memory card slot size. Otherwise, it will cause a malfunction.
- When inserting or ejecting the memory card, be careful so that the memory card does not pop out and drop.

Types of memory card you can use with your camcorder

| | Capacity (operation verified) | SD Speed Class | Described in this manual |
|---------------------------------------|-------------------------------------|----------------------|-------------------------------|
| microSD memory card | Up to 32 GB | Class 4 or faster | microSD card |
| microSDHC memory card | | | |
| microSDXC memory card | Up to 64 GB | | |
| “Memory Stick Micro” media (Mark2) | Up to 16 GB | — | “Memory Stick Micro” media |

- Operation with all memory cards is not assured.

Notes

- Movies saved on the microSDXC memory cards cannot be imported to or played back on computers or AV devices not supporting the exFAT* file system by connecting the camcorder to these devices with the USB cable. Confirm in advance that the connecting equipment is supporting the exFAT system. If you connect an equipment not supporting the exFAT system and the format screen appears, do not perform the format. All the data saved will be lost.

* The exFAT is a file system that is used for the microSDXC memory cards.

To eject the memory card

Open the memory card cover and lightly push the memory card in once.

Related topics

Confirming the recording media: [Screen indicators during recording](#)
[Expected shooting time of movies](#)

[▲ Back to top](#)

Copyright 2013 Sony Corporation

- ▶ Operation Search
- ▶ Before use
- ▶ Getting started
- ▶ **Recording**
- ▶ Playback
- ▶ Playing images on a TV
- ▶ Saving images with a computer
- ▶ Using the Wi-Fi function
- ▶ Customizing your camcorder
- ▶ Troubleshooting
- ▶ Maintenance and precautions

[→ Contents list](#)

Shooting movies

Movies are shot in the MP4 format ([Audio Format] is [AAC LC] in the default setting).

1. Press the POWER button to turn on the camcorder.

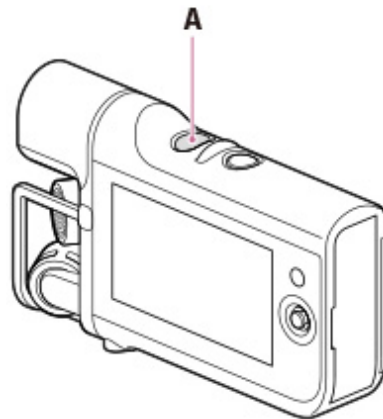

A: POWER button

2. Press START/STOP to start shooting.

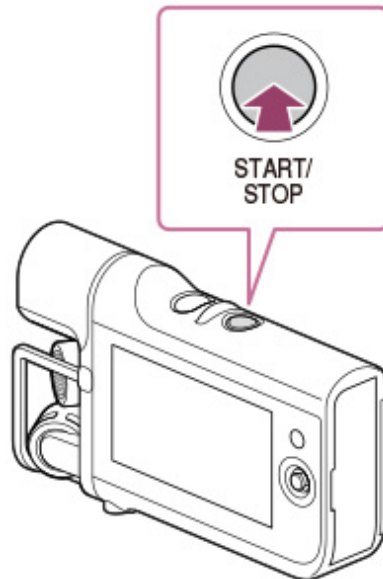

- The LCD screen will be dimmed about 3 seconds after starting shooting (in the default setting).
- To stop shooting, press START/STOP again.

Notes

- The maximum continuous shooting time of movies is about 13 hours.

- When a movie file exceeds 4 GB, the next movie file is created automatically.
- The following states will be indicated if data is still being written onto the recording media after shooting has finished. During this time, do not apply shock or vibration to the camcorder, or remove the battery pack or AC Adaptor (sold separately).
 - Access lamp is lit or flashing
 - The media icon in the upper right of the LCD screen is on
- The LCD screen of your camcorder can display shooting movies across the entire screen (full pixel display). However, this may cause slight trimming of the top, bottom, right, and left edges of movies when played back on a TV which is not compatible with full pixel display. It is recommended you shoot movies with [Grid Line] set to [On] and using the outer frame of [Grid Line] as a guide.
- Since the camcorder is equipped with a high-sensitivity microphone, noise or operation sound may be recorded in the following situations.
 - When shooting by holding the camcorder
 - When operating the multi-selector

Related topics

[Expected shooting time of movies](#)

To hide items on the LCD screen: [[Display Setting](#)]

Recordable time, remaining capacity: [[Media Info](#)]

Changing the audio recording format: [[Audio Format](#)]

Canceling the LCD screen automatic lights-out function: [[Auto Monitor Off](#)]

Recording sound: [[Recording sound](#)]

[▲ Back to top](#)

Copyright 2013 Sony Corporation

- ▶ Operation Search
- ▶ Before use
- ▶ Getting started
- ▶ Recording
- ▶ Playback
- ▶ Playing images on a TV
- ▶ Saving images with a computer
- ▶ Using the Wi-Fi function
- ▶ Customizing your camcorder
- ▶ Troubleshooting
- ▶ Maintenance and precautions

[→ Contents list](#)

Recording sound

Sound is recorded as a WAV file.

1. Press the POWER button to turn on the camcorder.

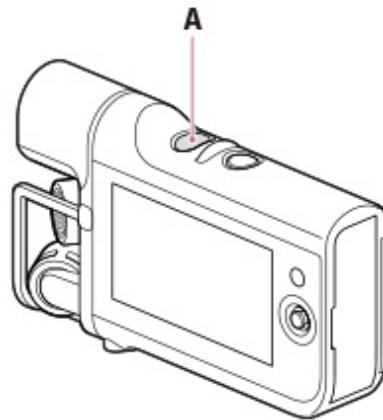

A: POWER button

2. Select the  button.
The camcorder enters sound recording mode.



3. Press START/STOP to start recording sound.

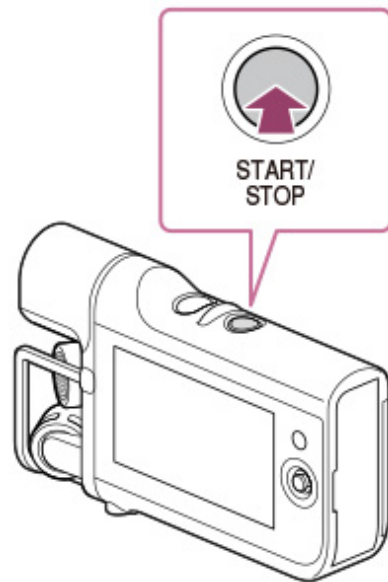

- To stop recording, press START/STOP again.

Notes

- When the file size exceeds 2 GB (approximately 2 hours 50 minutes when recording continuously), recording stops.

Functions available in sound recording mode

The following functions are available.

- [Ctrl with Smartphone]
- [Low Cut Filter]
- [Int. Mic. Rec. Level]
- [Ext. Mic. Rec. Level]
- [Volume]
- [Ext. Audio Input Set]
- [My Button]
- [Display Setting]
- [Audio Level Display]
- [Auto Monitor Off]

Functions available for audio files

The following functions are available.

- [Delete]
- [Protect]

Related topics

[Expected recording time of sound](#)

[▲ Back to top](#)

Copyright 2013 Sony Corporation

- ▶ Operation Search
- ▶ Before use
- ▶ Getting started
- ▶ Recording
- ▶ Playback
- ▶ Playing images on a TV
- ▶ Saving images with a computer
- ▶ Using the Wi-Fi function
- ▶ Customizing your camcorder
- ▶ Troubleshooting
- ▶ Maintenance and precautions

[→ Contents list](#)

Screen indicators during recording

Described here are icons for both movie shooting and sound recording modes.

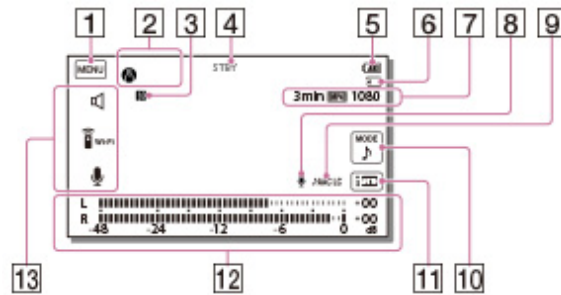

- 1** MENU button
- 2** Status detected by Intelligent Auto
- 3** NFC connection
- 4** Recording status ([STBY]/[REC])
- 5** Remaining battery
- 6** Counter (hour: minute: second), Recording media
- 7** Estimated recording remaining time, Recording format, Movie size
- 8** Audio input settings
- 9** Audio recording format for movies
- 10** Mode switching button
- 11** Intelligent Auto button
- 12** Audio level meter
- 13** My Button (you can assign your favorite functions to icons displayed in this area)

[▲ Back to top](#)



Copyright 2013 Sony Corporation

- ▶ Operation Search
- ▶ Before use
- ▶ Getting started
- ▶ Recording
- ▶ Playback
- ▶ Playing images on a TV
- ▶ Saving images with a computer
- ▶ Using the Wi-Fi function
- ▶ Customizing your camcorder
- ▶ Troubleshooting
- ▶ Maintenance and precautions

[→ Contents list](#)

Intelligent Auto





Your camcorder shoots movies after selecting the most suitable setting for the subjects or the situation automatically. ([On] is the default setting.)

1. Select  → [On] →  on the shooting screen.



2. Point the camcorder toward the subject and start shooting.
The icons that correspond to the conditions detected are displayed.



Scene detection:  (Backlight),  (Night Scene),  (Spotlight),  (Low light)

To cancel the Intelligent Auto function, select  → [Off] on the shooting screen.

Notes

- The camcorder may not detect the expected scene or subject, depending on the shooting conditions.

Related topics

[\[Low Lux\]](#)

[▲ Back to top](#)

Copyright 2013 Sony Corporation

[▶ Operation Search](#)[▶ Before use](#)[▶ Getting started](#)[▶ Recording](#)[▶ Playback](#)[▶ Playing images on a TV](#)[▶ Saving images with a computer](#)[▶ Using the Wi-Fi function](#)[▶ Customizing your camcorder](#)[▶ Troubleshooting](#)[▶ Maintenance and precautions](#)[→ Contents list](#)

Audio monitoring

1. Connect headphones (sold separately) to the  (headphones) jack.

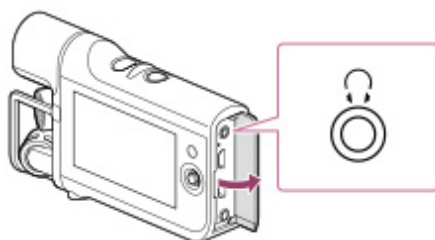

- To adjust the volume from the headphones, in recording standby mode, select  on the LCD screen.

[▲ Back to top](#)

Copyright 2013 Sony Corporation

- ▶ Operation Search
- ▶ Before use
- ▶ Getting started
- ▶ Recording
- ▶ Playback
- ▶ Playing images on a TV
- ▶ Saving images with a computer
- ▶ Using the Wi-Fi function
- ▶ Customizing your camcorder
- ▶ Troubleshooting
- ▶ Maintenance and precautions

[→ Contents list](#)

Playing movies/audio files

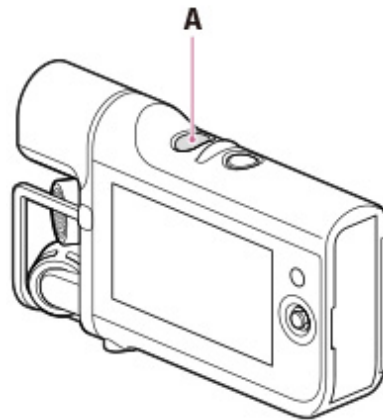

1. Press the POWER button to turn on the camcorder.

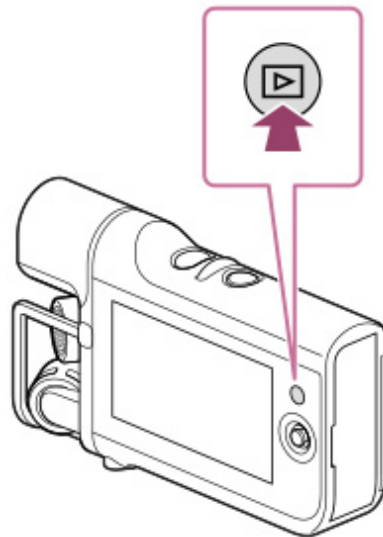

A: POWER button

2. Press  (Playback) to enter playback mode.



3. Select  → the desired type of file ([ MOVIE] or [ AUDIO]).

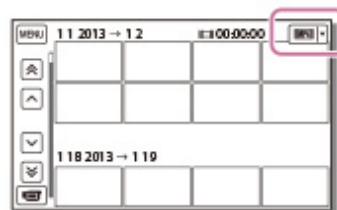

4. Select your desired file.

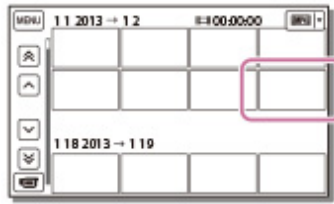

- The camcorder plays from the selected file to the last file.

5. Select the appropriate buttons on the LCD screen for various playback operations.



| | | | |
|---|---------------|---|---------------------------|
| | Volume | / | Fast-reverse/fast-forward |
| | Delete | / | Play/Pause |
| | Stop | | Repeat an audio file |
| / | Previous/Next | | |

- Some buttons described above may not appear, depending on the file being played back.
- As you repeat selecting / during playback, files are played as fast as about 5 times → about 10 times → about 30 times → about 60 times.
- Select / during pause to play movies slowly.

Playback screen

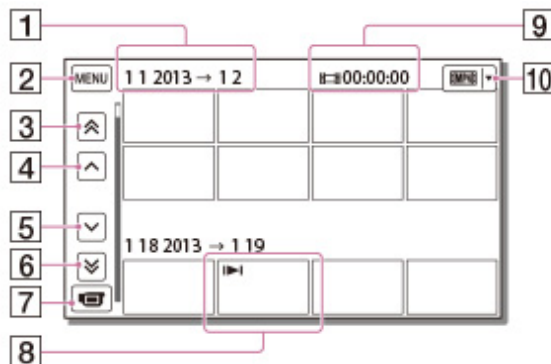

- 1** : Date
2 : MENU

- 3 : To the previous event
 - 4 : Previous
 - 5 : Next
 - 6 : To the next event
 - 7 : To the movie/sound recording screen
 - 8 : Last played file
 - 9 : Total recorded time in the Event
 - 10 : Switch the type of playback file (movie/audio)
- Reduced-size images which enable you to view many images at the same time on an index screen are called “thumbnails.”
 - On the audio file index screen, the file format, recorded time and file number appear.

To play back files with other devices

- You may not be able to play back files recorded on your camcorder with other devices normally. Also, you may not be able to play back files recorded on other devices with your camcorder.

Notes

- To prevent your file data from being lost, save all your recorded files on external media periodically.

[▲ Back to top](#)

Copyright 2013 Sony Corporation

[Top page](#) > [Playing images on a TV](#) > [Playing images on a high definition TV](#) > [Connecting the camcorder to a high definition TV](#)

- ▶ Operation Search
- ▶ Before use
- ▶ Getting started
- ▶ Recording
- ▶ Playback
- ▶ Playing images on a TV
- ▶ Saving images with a computer
- ▶ Using the Wi-Fi function
- ▶ Customizing your camcorder
- ▶ Troubleshooting
- ▶ Maintenance and precautions

[→ Contents list](#)

Connecting the camcorder to a high definition TV

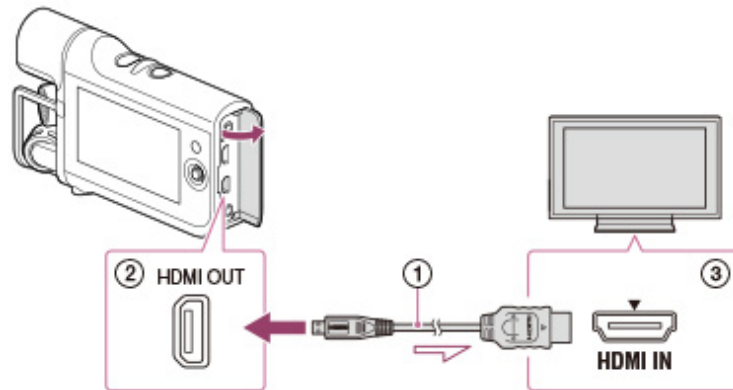

:Signal flow

1. Switch the input on the TV to the connected jack.
2. Connect the HDMI cable (① sold separately) to the HDMI OUT jack (②) on the camcorder and to the HDMI IN jack (③) on the TV.
3. Play a movie on the camcorder.

On an HDMI cable (sold separately)

- Using an authorized HDMI cable with the HDMI logo or a Sony HDMI cable is recommended.
- Use an HDMI micro connector on one end (for the camcorder), and a plug suitable for connecting your TV on the other end.
- Copyright-protected images are not output from the HDMI OUT jack of your camcorder.
- Some TVs may not function correctly (e.g., no sound or image) with this connection.
- Do not connect the camcorder HDMI OUT jack to an external device HDMI OUT jack, as malfunction may result.
- HDMI (High-Definition Multimedia Interface) is an interface to send both video/audio signals. The HDMI OUT jack outputs high quality images and digital audio.

Notes

- Refer to the instruction manuals of the TV as well.

[▲ Back to top](#)

[Top page](#) > [Playing images on a TV](#) > [Playing images on a TV supporting "BRAVIA" Sync](#) > [Using "BRAVIA" Sync](#)

- ▶ Operation Search
- ▶ Before use
- ▶ Getting started
- ▶ Recording
- ▶ Playback
- ▶ **Playing images on a TV**
- ▶ Saving images with a computer
- ▶ Using the Wi-Fi function
- ▶ Customizing your camcorder
- ▶ Troubleshooting
- ▶ Maintenance and precautions

[→ Contents list](#)

Using "BRAVIA" Sync

You can operate your camcorder with the remote commander of your TV by connecting your camcorder to a "BRAVIA" Sync compatible TV launched in 2008 or later with the HDMI cable (sold separately).

Notes

- There may be some operations you cannot do with the remote commander.
- Set [CTRL FOR HDMI] to [On].
- Also set your TV accordingly. Refer to the instruction manual of the TV for details.
- The operation of "BRAVIA" Sync differs according to each model of BRAVIA. Refer to the instruction manual of your TV for details.
- If you turn off the TV, your camcorder is turned off simultaneously.

[▲ Back to top](#)

Copyright 2013 Sony Corporation

[Top page](#) > [Saving images with a computer](#) > [Saving contents with a computer](#) > [What you can do using a computer](#)

- ▶ Operation Search
- ▶ Before use
- ▶ Getting started
- ▶ Recording
- ▶ Playback
- ▶ Playing images on a TV
- ▶ Saving images with a computer
- ▶ Using the Wi-Fi function
- ▶ Customizing your camcorder
- ▶ Troubleshooting
- ▶ Maintenance and precautions

[→ Contents list](#)

What you can do using a computer

You can edit your recorded files and post your movie files to video-file sharing sites using the editing/management software.

Visit the following website to download the software.

www.sony.net/pm/mvr/

Notes

- An Internet connection is required to install the software.

[▲ Back to top](#)

Copyright 2013 Sony Corporation

[Top page](#) > [Saving images with a computer](#) > [Saving contents with a computer](#) > [Checking the computer system](#)

- ▶ Operation Search
- ▶ Before use
- ▶ Getting started
- ▶ Recording
- ▶ Playback
- ▶ Playing images on a TV
- ▶ Saving images with a computer
- ▶ Using the Wi-Fi function
- ▶ Customizing your camcorder
- ▶ Troubleshooting
- ▶ Maintenance and precautions

[→ Contents list](#)

Checking the computer system

You can check the system requirements for software at the following URL.

www.sony.net/pm/mvr/

[▲ Back to top](#)

Copyright 2013 Sony Corporation

[Top page](#) > [Saving images with a computer](#) > [Saving contents with a computer](#) > [Installing the editing/management software in your computer](#)

- ▶ Operation Search
- ▶ Before use
- ▶ Getting started
- ▶ Recording
- ▶ Playback
- ▶ Playing images on a TV
- ▶ Saving images with a computer
- ▶ Using the Wi-Fi function
- ▶ Customizing your camcorder
- ▶ Troubleshooting
- ▶ Maintenance and precautions

[→ Contents list](#)

Installing the editing/management software in your computer

1. Access the following download page using an Internet browser on your computer, and then install the software following the on-screen instructions.
www.sony.net/pm/mvr/

[▲ Back to top](#)

Copyright 2013 Sony Corporation

[Top page](#) > [Saving images with a computer](#) > [Saving contents with a computer](#) > [Starting the editing/management software](#)

- ▶ [Operation Search](#)
- ▶ [Before use](#)
- ▶ [Getting started](#)
- ▶ [Recording](#)
- ▶ [Playback](#)
- ▶ [Playing images on a TV](#)
- ▶ [Saving images with a computer](#)
- ▶ [Using the Wi-Fi function](#)
- ▶ [Customizing your camcorder](#)
- ▶ [Troubleshooting](#)
- ▶ [Maintenance and precautions](#)

[→ Contents list](#)

Starting the editing/management software

Windows

1. Double-click the software icon on the desktop.
 - When using Windows 8, select the software icon from the start screen.

Mac

1. Double-click the software icon in the Applications folder.

The editing/management software starts.

[▲ Back to top](#)

Copyright 2013 Sony Corporation

[Top page](#) > [Saving images with a computer](#) > [Saving contents with a computer](#) > [Importing files to your computer without using software](#)

- ▶ Operation Search
- ▶ Before use
- ▶ Getting started
- ▶ Recording
- ▶ Playback
- ▶ Playing images on a TV
- ▶ Saving images with a computer
- ▶ Using the Wi-Fi function
- ▶ Customizing your camcorder
- ▶ Troubleshooting
- ▶ Maintenance and precautions

[→ Contents list](#)

Importing files to your computer without using software

When the AutoPlay Wizard appears on the computer screen after making a USB connection between the camera and a computer, click [Open folder to view files] → [OK] → one of the folders on the table below, and then copy your desired files to your computer.

About file names

| File type | Memory card | Folder | File name |
|-----------|--------------------|---------------|-------------------|
| MP4 | microSD | MP_ROOT | MAH0 □ □ □ □ .MP4 |
| | Memory Stick Micro | | |
| WAV | microSD | PRIVATE/AUDIO | WAAV □ □ □ □ .WAV |
| | Memory Stick Micro | AUDIO | |

- □ □ □ □ stands for file numbers (0001 to 9999).

[▲ Back to top](#)

- ▶ Operation Search
- ▶ Before use
- ▶ Getting started
- ▶ Recording
- ▶ Playback
- ▶ Playing images on a TV
- ▶ Saving images with a computer
- ▶ Using the Wi-Fi function
- ▶ Customizing your camcorder
- ▶ Troubleshooting
- ▶ Maintenance and precautions

[→ Contents list](#)

[Top page](#) > [Using the Wi-Fi function](#) > [Using the Wi-Fi function](#) > [What you can do using the Wi-Fi function](#)

What you can do using the Wi-Fi function

The Wi-Fi function of your camcorder allows you to do the following operations.

Transferring movies to your smartphone or tablet

Prepare your smartphone or tablet.

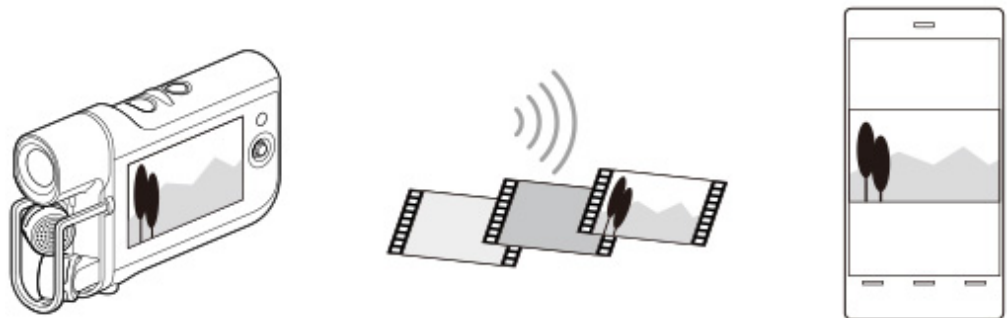

Operating the camcorder with your smartphone or tablet

Prepare your smartphone or tablet.

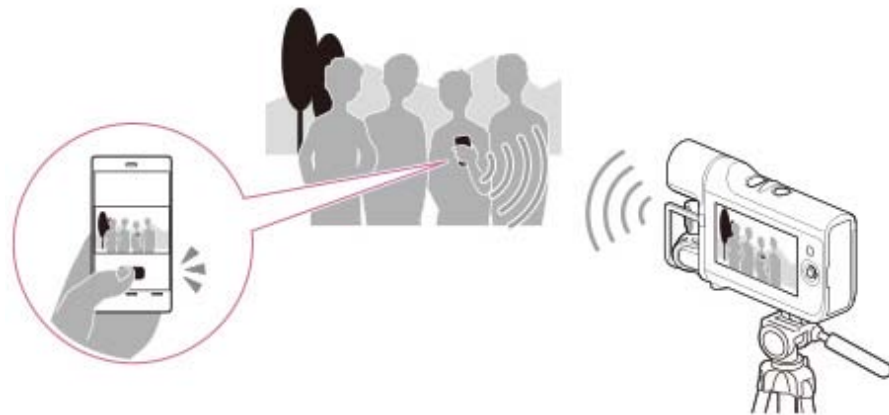

Notes

- You cannot save recorded files on your computer or transfer audio files to your smartphone or tablet using the Wi-Fi function of your camcorder.
- You cannot use the Wi-Fi function of your camcorder to connect to a public wireless network.
- Wi-Fi functions introduced in this User Guide are not guaranteed to work on all smartphones or tablets.
- The information on supported OS versions is as of September 1, 2013.

Related topics

[Transferring movies to your smartphone or tablet without using NFC](#)

[Transferring movies to your smartphone or tablet using NFC](#)

[Using your smartphone or tablet as a remote control without using NFC](#)

[Using your smartphone or tablet as a remote control using NFC](#)

[▲ Back to top](#)

Copyright 2013 Sony Corporation



- ▶ Operation Search
- ▶ Before use
- ▶ Getting started
- ▶ Recording
- ▶ Playback
- ▶ Playing images on a TV
- ▶ Saving images with a computer
- ▶ Using the Wi-Fi function
- ▶ Customizing your camcorder
- ▶ Troubleshooting
- ▶ Maintenance and precautions

➔ [Contents list](#)

[Top page](#) > [Using the Wi-Fi function](#) > [Control your camcorder via smartphone](#) > [Using your smartphone or tablet as a remote control without using NFC](#)

Using your smartphone or tablet as a remote control without using NFC

You can operate the camcorder using your smartphone or tablet as a remote control.

1. Install “PlayMemories Mobile” onto your smartphone or tablet.
 - If the “PlayMemories Mobile” software is already installed on your smartphone or tablet, upgrade it to the latest version.
 - Refer to the “PlayMemories Mobile” support web page (<http://www.sony.net/pmm/>) for the latest information of supported OS.
 - “PlayMemories Mobile” is not guaranteed to work on all smartphones or tablets.
2. Select  on the recording screen of the camcorder.
 - You can also enter the recording mode, and then select **MENU** → [Camera/Audio] → [ Recording Assist] → [Ctrl with Smartphone].
 - The SSID and password appear and the camcorder will be connectable from your smartphone or tablet.



A: SSID

B: Password

3. Connect the smartphone or tablet to the camcorder by making operations on the smartphone or tablet.
 - When you use an Android smartphone, on the smartphone, start up the “PlayMemories Mobile,” then select the SSID displayed on the camcorder, and then enter the password displayed on the camcorder.
 - When you use an iPhone or iPad, select [Settings] → [Wi-Fi] → the SSID displayed on the camcorder, and then start up “PlayMemories Mobile.”
 - You are only required to enter the password the first time.
4. Operate the camcorder using the smartphone or tablet.

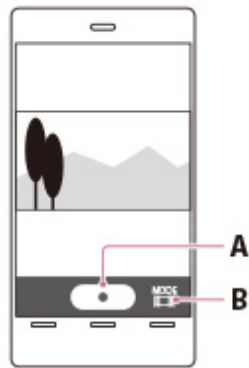

A: START/STOP button

B: File type

Notes

- Files will be saved not on the smartphone or tablet but on the camcorder.
- The application operation method and screen display are subject to change due to future updates.

Related topics

[On the “PlayMemories Mobile” software](#)

[Connecting to your Android smartphone or tablet](#)

[Connecting to your iPhone or iPad](#)

[▲ Back to top](#)

Copyright 2013 Sony Corporation



- ▶ Operation Search
- ▶ Before use
- ▶ Getting started
- ▶ Recording
- ▶ Playback
- ▶ Playing images on a TV
- ▶ Saving images with a computer
- ▶ Using the Wi-Fi function
- ▶ Customizing your camcorder
- ▶ Troubleshooting
- ▶ Maintenance and precautions

→ [Contents list](#)

[Top page](#) > [Using the Wi-Fi function](#) > [Control your camcorder via smartphone](#) > [Using your smartphone or tablet as a remote control using NFC](#)

Using your smartphone or tablet as a remote control using NFC

You can operate the camcorder using your NFC-compatible Android smartphone or tablet as a remote control.

1. Install "PlayMemories Mobile" onto your smartphone or tablet.
 - If the "PlayMemories Mobile" software is already installed on your smartphone or tablet, upgrade it to the latest version.
 - Refer to the "PlayMemories Mobile" support web page (<http://www.sony.net/pmm/>) for the latest information of supported OS.
 - "PlayMemories Mobile" is not guaranteed to work on all smartphones or tablets.
2. Select [Settings] on the smartphone, then select [More...] and place a checkmark next to [NFC].
3. In recording mode, touch  on the camcorder to  on your smartphone or tablet.

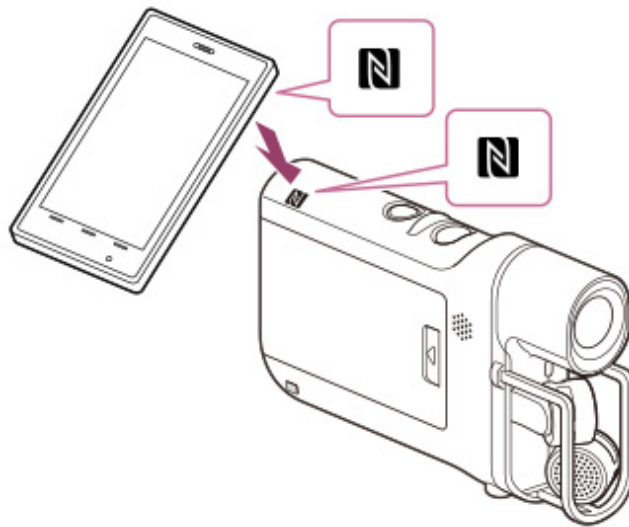

- Cancel the sleep function and screen-lock on your smartphone or tablet in advance.
 - Make sure that  is displayed on the LCD screen of the camcorder.
 - Keep the smartphone or tablet in contact with the camcorder for one or two seconds until "PlayMemories Mobile" starts.
 - If the connection is not established using NFC, try to establish the connection following the procedure in "Connecting to your Android smartphone or tablet." [\[Details\]](#)
4. Operate the camcorder using the smartphone or tablet.

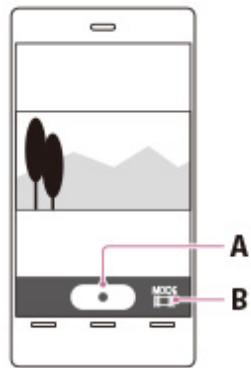

A: START/STOP button

B: File type

Notes

- Files will be recorded not on the smartphone or tablet but on the camcorder.
- The application operation method and screen display are subject to change due to future updates.

Related topics

[On the “PlayMemories Mobile” software](#)

[Connecting to your NFC-compatible Android smartphone or tablet](#)

[▲ Back to top](#)

Copyright 2013 Sony Corporation

[Top page](#) > [Using the Wi-Fi function](#) > [Sending movies to the smartphone](#) > [Transferring movies to your smartphone or tablet without using NFC](#)

Transferring movies to your smartphone or tablet without using NFC

You can transfer movies to your smartphone or tablet.

1. Install “PlayMemories Mobile” onto your smartphone or tablet.
 - If the “PlayMemories Mobile” software is already installed on your smartphone or tablet, upgrade it to the latest version.
 - Refer to the “PlayMemories Mobile” support web page (<http://www.sony.net/pmm/>) for the latest information of supported OS.
 - “PlayMemories Mobile” is not guaranteed to work on all smartphones or tablets.
2. Press  (Playback) to enter playback mode.

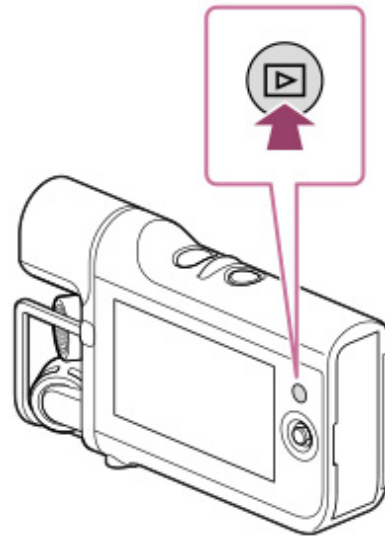

- Select [ MOVIE] as the file type to play back. [\[Details\]](#)

3. Select MENU → [Edit/Copy] → [Send to Smartphone] → [Select on This Device].

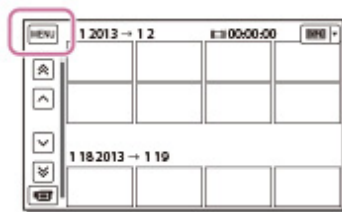

- When [Select on Smartphone] is selected, all movies saved on the memory card will be displayed on the smartphone.

4. Add a check mark to the desired movie, and then select OK → OK.

- ▶ Operation Search
- ▶ Before use
- ▶ Getting started
- ▶ Recording
- ▶ Playback
- ▶ Playing images on a TV
- ▶ Saving images with a computer
- ▶ Using the Wi-Fi function
- ▶ Customizing your camcorder
- ▶ Troubleshooting
- ▶ Maintenance and precautions

[→ Contents list](#)

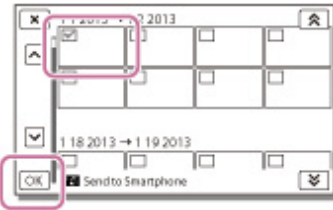

- The SSID and password appear and the camcorder will be connectable from your smartphone or tablet.



A: SSID

B: Password

5. Connect the smartphone or tablet to the camcorder by making operations on the smartphone or tablet.
 - When you use an Android smartphone, on the smartphone, start up the “PlayMemories Mobile,” then select the SSID displayed on the camcorder, and then enter the password displayed on the camcorder.
 - When you use an iPhone or iPad, select [Settings] → [Wi-Fi] → the SSID displayed on the camcorder, and then start up “PlayMemories Mobile.”
 - You are only required to enter the password the first time.
 - Movies stored on the camcorder will be transferred to the smartphone or tablet.
 - Transferred movies will be stored in Gallery/Album on an Android smartphone/tablet or in Album on an iPhone/iPad.

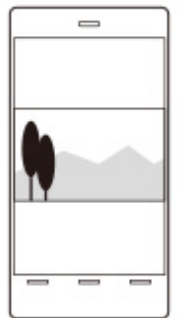

Notes

- You cannot transfer audio files to your smartphone or tablet.
- If any movies are not recorded on your camcorder, [Send to Smartphone] does not work.

Related topics

[On the “PlayMemories Mobile” software](#)

[Connecting to your Android smartphone or tablet](#)

[Connecting to your NFC-compatible Android smartphone or tablet](#)

[Connecting to your iPhone or iPad](#)

Top page > Using the Wi-Fi function > Sending movies to the smartphone > Transferring movies to your smartphone or tablet using NFC

▸ Operation Search

▸ Before use

▸ Getting started

▸ Recording

▸ Playback

▸ Playing images on a TV

▸ Saving images with a computer

▸ Using the Wi-Fi function

▸ Customizing your camcorder

▸ Troubleshooting

▸ Maintenance and precautions

➔ Contents list

Transferring movies to your smartphone or tablet using NFC

You can transfer movies to your NFC-compatible Android smartphone or tablet.

1. Install "PlayMemories Mobile" onto your smartphone or tablet.
 - If the "PlayMemories Mobile" software is already installed on your smartphone or tablet, upgrade it to the latest version.
 - Refer to the "PlayMemories Mobile" support web page (<http://www.sony.net/pmm/>) for the latest information of supported OS.
 - "PlayMemories Mobile" is not guaranteed to work on all smartphones or tablets.
2. Press  (Playback) to enter playback mode, and then play back your desired movie.
3. Select [Settings] on the smartphone, then select [More...] and place a checkmark next to [NFC].

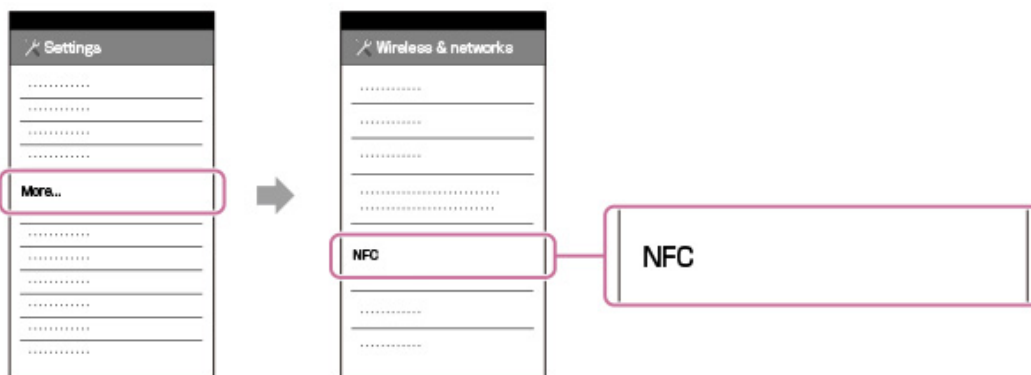

4. Touch  on the camcorder to  on your smartphone or tablet.

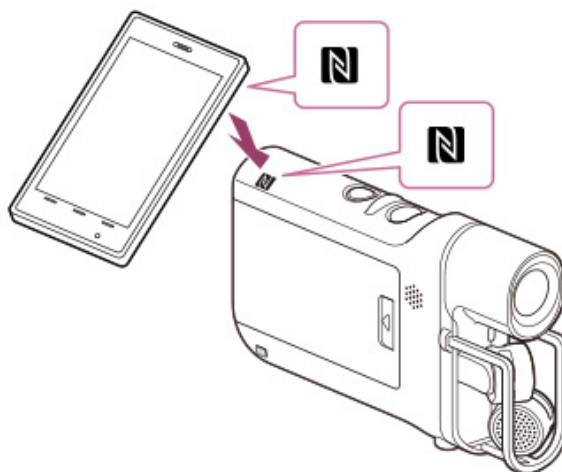

- Cancel the sleep function and screen-lock on your smartphone or tablet in advance.
- Make sure that  is displayed on the LCD screen of the camcorder.

- Keep the smartphone or tablet in contact with the camcorder for one or two seconds until “PlayMemories Mobile” starts.
 - If the connection is not established using NFC, try to establish the connection following the procedure in “Transferring movies to your smartphone or tablet without using NFC.” [\[Details\]](#)
5. Movies stored on the camcorder will be transferred to the smartphone or tablet.
- Transferred movies will be stored on Android Gallery.

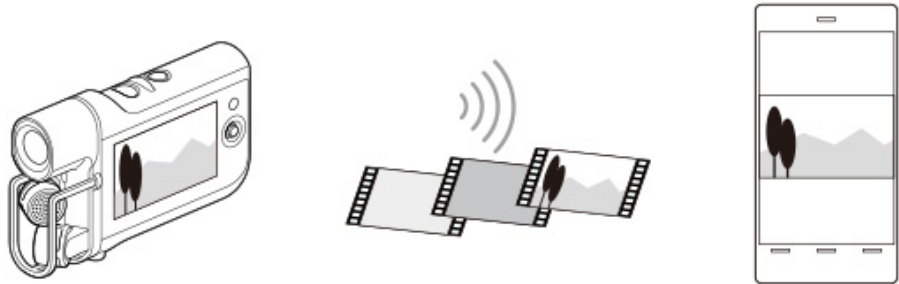

Notes

- You cannot transfer audio files to your smartphone or tablet.
- If any movies are not recorded on your camcorder, [Send to Smartphone] does not work.

Related topics

[On the “PlayMemories Mobile” software](#)

[Connecting to your NFC-compatible Android smartphone or tablet](#)

[Connecting to your Android smartphone or tablet](#)

[Transferring movies to your smartphone or tablet without using NFC](#)

[▲ Back to top](#)

Copyright 2013 Sony Corporation

- ▶ Operation Search
- ▶ Before use
- ▶ Getting started
- ▶ Recording
- ▶ Playback
- ▶ Playing images on a TV
- ▶ Saving images with a computer
- ▶ Using the Wi-Fi function
- ▶ Customizing your camcorder
- ▶ Troubleshooting
- ▶ Maintenance and precautions

[→ Contents list](#)

[Top page](#) > [Using the Wi-Fi function](#) > [Connecting a smartphone](#) > [Connecting to your Android smartphone or tablet](#)

Connecting to your Android smartphone or tablet

You can connect your Android smartphone or tablet to your camcorder as shown below. From [Send to Smartphone] or [Ctrl with Smartphone], display the password and the SSID on the LCD screen of the camcorder.

1. Start up "PlayMemories Mobile."



2. On your smartphone, select the SSID (device name) displayed on the camcorder.



3. On your smartphone, enter the password displayed on the camcorder.



Related topics

[On the “PlayMemories Mobile” software](#)

[Transferring movies to your smartphone or tablet without using NFC](#)

[Using your smartphone or tablet as a remote control without using NFC](#)

[▲ Back to top](#)

Copyright 2013 Sony Corporation

- ▶ Operation Search
- ▶ Before use
- ▶ Getting started
- ▶ Recording
- ▶ Playback
- ▶ Playing images on a TV
- ▶ Saving images with a computer
- ▶ Using the Wi-Fi function
- ▶ Customizing your camcorder
- ▶ Troubleshooting
- ▶ Maintenance and precautions

[➔ Contents list](#)

Connecting to your iPhone or iPad

You can connect your iPhone or iPad to your camcorder as shown below. From [Send to Smartphone] or [Ctrl with Smartphone], display the password and the SSID on the LCD screen of the camcorder.

1. Open the settings menu of your iPhone.

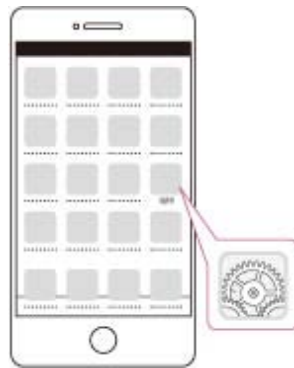

2. Select Wi-Fi.

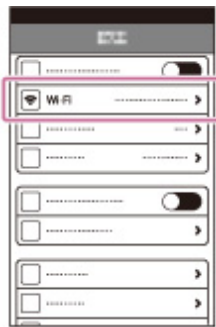

3. On your iPhone, select the SSID (device name) displayed on the camcorder.

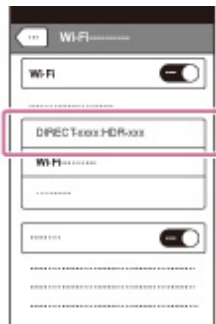

4. On your iPhone, enter the password displayed on the camcorder.



5. Confirm that your iPhone is connected to the SSID displayed on the camcorder.



6. Return to Home and start up "PlayMemories Mobile."

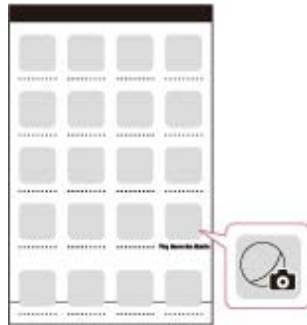

Related topics

[On the "PlayMemories Mobile" software](#)

[Transferring movies to your smartphone or tablet without using NFC](#)

[Using your smartphone or tablet as a remote control without using NFC](#)

[▲ Back to top](#)

Copyright 2013 Sony Corporation



- ▶ Operation Search
- ▶ Before use
- ▶ Getting started
- ▶ Recording
- ▶ Playback
- ▶ Playing images on a TV
- ▶ Saving images with a computer
- ▶ Using the Wi-Fi function
- ▶ Customizing your camcorder
- ▶ Troubleshooting
- ▶ Maintenance and precautions

[→ Contents list](#)

[Top page](#) > [Using the Wi-Fi function](#) > [Connecting a smartphone](#) > [Connecting to your NFC-compatible Android smartphone or tablet](#)

Connecting to your NFC-compatible Android smartphone or tablet

You can connect your NFC-compatible Android smartphone or tablet to your camcorder easily.

1. Touch  on the camcorder to  on your smartphone or tablet to connect them.

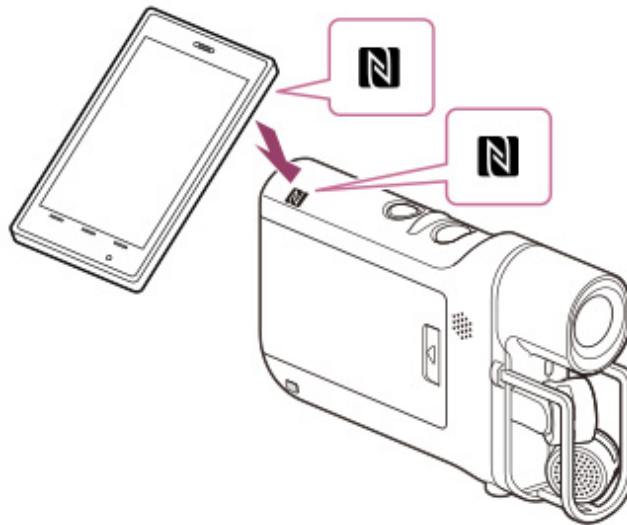

- Cancel the sleep function and screen-lock on your smartphone or tablet in advance.
- Make sure that  is displayed on the LCD screen of the camcorder.
- Keep the smartphone or tablet in contact with the camcorder for one or two seconds until "PlayMemories Mobile" starts.
- If the connection is not established using NFC, try to establish the connection following the procedure in "Connecting to your Android smartphone or tablet." [\[Details\]](#)

What you can do via NFC connection

Operations available by touching the camcorder with your NFC-compatible smartphone differ depending on the conditions of the camcorder.

- When the camcorder is in recording mode
[Ctrl with Smartphone] starts up.
- When the camcorder is in movie playback mode
[Send to Smartphone] starts up.

Notes

-

- To use the one-touch functions of the camcorder, an NFC-compatible smartphone or tablet is required.
- NFC (Near Field Communication) is an international standard for short-range wireless communication technology.

Related topics

[On the “PlayMemories Mobile” software](#)

[Transferring movies to your smartphone or tablet using NFC](#)

[Using your smartphone or tablet as a remote control using NFC](#)

[Connecting to your Android smartphone or tablet](#)

[▲ Back to top](#)

Copyright 2013 Sony Corporation

[Top page](#) > [Using the Wi-Fi function](#) > [Installing the PlayMemories Mobile](#) > [On the “PlayMemories Mobile” software](#)

- ▶ Operation Search
- ▶ Before use
- ▶ Getting started
- ▶ Recording
- ▶ Playback
- ▶ Playing images on a TV
- ▶ Saving images with a computer
- ▶ Using the Wi-Fi function
- ▶ Customizing your camcorder
- ▶ Troubleshooting
- ▶ Maintenance and precautions

[→ Contents list](#)

On the “PlayMemories Mobile” software

To perform the operations such as [Ctrl with Smartphone] and [Send to Smartphone], “PlayMemories Mobile” is necessary. Install it from the application store of your smartphone or tablet. If the “PlayMemories Mobile” software is already installed on your smartphone or tablet, upgrade it to the latest version. For details on “PlayMemories Mobile,” refer to the “PlayMemories Mobile” support page (<http://www.sony.net/pmm/>).

[▲ Back to top](#)

Copyright 2013 Sony Corporation







- ▶ Operation Search
- ▶ Before use
- ▶ Getting started
- ▶ Recording
- ▶ Playback
- ▶ Playing images on a TV
- ▶ Saving images with a computer
- ▶ Using the Wi-Fi function
- ▶ Customizing your camcorder
- ▶ Troubleshooting
- ▶ Maintenance and precautions

[→ Contents list](#)

[Top page](#) > [Customizing your camcorder](#) > [Using menu items](#) > [Setting up menu items](#)

Setting up menu items

The camcorder has various menu items under each of 6 menu categories.

-  Recording Mode (Items for selecting a recording mode)
-  Camera/Audio (Items for customized recording)
-  Image Quality/Size (Items for setting up image quality or size)
-  Playback Function (Items for playback)
-  Edit/Copy (Items for editing images such as transferring to a smartphone or protecting)
-  Setup (Other setup items)

1. Select **MENU**.



2. Select a category.

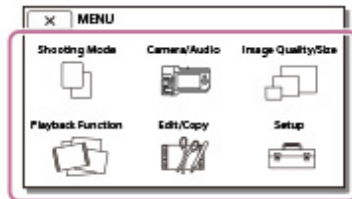

3. Select your desired menu item.

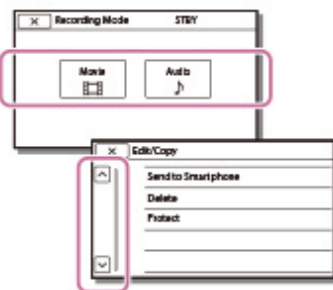

Notes

- Select **X** to finish setting the menu or to return to the previous screen.

| To find a menu item quickly

The [Camera/Audio] and [Setup] menus have sub-categories. Select the sub-category icon so that the LCD screen displays the list of menus in the sub-category selected.

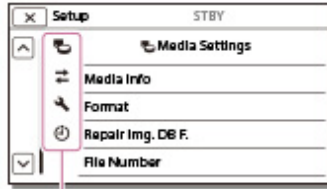

A

A: Sub-category icons

When you cannot select a menu item

Grayed out menu items or settings are not available.

Your camcorder displays the reason why you cannot select the menu item or the instruction of under which condition you can set the menu item.

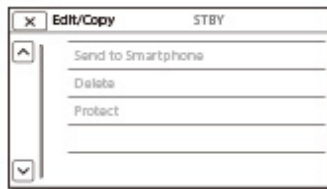

[▲ Back to top](#)

Copyright 2013 Sony Corporation

- ▶ Operation Search
- ▶ Before use
- ▶ Getting started
- ▶ Recording
- ▶ Playback
- ▶ Playing images on a TV
- ▶ Saving images with a computer
- ▶ Using the Wi-Fi function
- ▶ Customizing your camcorder
- ▶ Troubleshooting
- ▶ Maintenance and precautions

[→ Contents list](#)

Movie

Enters the movie shooting mode. The settings can be done with  on the recording screen as well.

1.  → [Recording Mode] → [Movie].

[▲ Back to top](#)

- ▶ [Operation Search](#)
- ▶ [Before use](#)
- ▶ [Getting started](#)
- ▶ [Recording](#)
- ▶ [Playback](#)
- ▶ [Playing images on a TV](#)
- ▶ [Saving images with a computer](#)
- ▶ [Using the Wi-Fi function](#)
- ▶ [Customizing your camcorder](#)
- ▶ [Troubleshooting](#)
- ▶ [Maintenance and precautions](#)

[→ Contents list](#)

Audio

Records sound (WAV file). The settings can be done with  on the recording screen as well.

1.  → [Recording Mode] → [Audio].



Related topics

[Recording sound](#)

[▲ Back to top](#)

Copyright 2013 Sony Corporation

- ▶ Operation Search
- ▶ Before use
- ▶ Getting started
- ▶ Recording
- ▶ Playback
- ▶ Playing images on a TV
- ▶ Saving images with a computer
- ▶ Using the Wi-Fi function
- ▶ Customizing your camcorder
- ▶ Troubleshooting
- ▶ Maintenance and precautions

[→ Contents list](#)

White Balance

You can adjust the color balance to the shooting environment.



1. MENU → [Camera/Audio] → [WB Manual Settings] → [White Balance].



2. Select the desired item.

| | |
|--|---|
| | <p>(Auto)</p> <p>The white balance is adjusted automatically.</p> <p>✓ If you have changed the battery pack while [Auto] was selected, or taken your camcorder outdoors after inside use (or vice versa), aim your camcorder at a nearby white object for about 10 seconds for better color balance adjustment.</p> |
| | <p>(Outdoor)</p> <p>The white balance is appropriately adjusted for the following shooting conditions:</p> <ul style="list-style-type: none"> • Outdoors • Night views, neon signs and fireworks • Sunrise or sunset • Under daylight fluorescent lamps |
| | <p>(Indoor)</p> <p>The white balance is appropriately adjusted for the following shooting conditions:</p> <ul style="list-style-type: none"> • Indoors • At party scenes or studios where the lighting conditions change quickly • Under video lamps in a studio, or under sodium lamps or incandescent-like color lamps |
| | <p>(One Push)</p> <p>The white balance will be adjusted according to the ambient light.</p> <p>① Select [].</p> |

② Keep framing white object such as a piece of paper, to fill the screen under the same lightning conditions as you will shoot the subject.

③ Select [ SET].

If the lighting conditions changed by bringing your camcorder outdoors from inside the house, or vice versa, you need to redo the [One Push] procedure to readjust the white balance.

Notes

- Set [White Balance] to [Auto] or adjust the color in [One Push] under white or cool white fluorescent lamps.
- While you are shooting a movie,  (One Push) cannot be set.
- If you set [White Balance], [Scene Selection] is set to [Auto].

[▲ Back to top](#)

Copyright 2013 Sony Corporation

- ▶ Operation Search
- ▶ Before use
- ▶ Getting started
- ▶ Recording
- ▶ Playback
- ▶ Playing images on a TV
- ▶ Saving images with a computer
- ▶ Using the Wi-Fi function
- ▶ Customizing your camcorder
- ▶ Troubleshooting
- ▶ Maintenance and precautions

[→ Contents list](#)

Exposure

You can fix the brightness of a movie manually. Adjust the brightness when the subject is too bright or too dark.

1. → [Camera/Audio] → [Manual Settings] → [Exposure].



2. Select the desired item.

| | |
|-------------------------------------|---|
| <input checked="" type="checkbox"/> | <p>Auto The exposure is adjusted automatically.</p> |
| | <p>Manual Select <input type="button" value="+"/> if the subject is white or the backlight is bright, or select <input type="button" value="-"/> if the subject is black or the light is dim.</p> <div style="text-align: center;"> </div> |

[▲ Back to top](#)

- ▶ Operation Search
- ▶ Before use
- ▶ Getting started
- ▶ Recording
- ▶ Playback
- ▶ Playing images on a TV
- ▶ Saving images with a computer
- ▶ Using the Wi-Fi function
- ▶ Customizing your camcorder
- ▶ Troubleshooting
- ▶ Maintenance and precautions

[➔ Contents list](#)

Low Lux

You can shoot bright color movies, even in dim light.

1. **MENU** → [Camera/Audio] → [**M** Manual Settings] → [Low Lux].



2. Select the desired item.

| | |
|---|--|
| ✓ | Off The Low Lux function is not used. |
| | On (🔒) The Low Lux function is used. |

[▲ Back to top](#)

- ▶ Operation Search
- ▶ Before use
- ▶ Getting started
- ▶ Recording
- ▶ Playback
- ▶ Playing images on a TV
- ▶ Saving images with a computer
- ▶ Using the Wi-Fi function
- ▶ Customizing your camcorder
- ▶ Troubleshooting
- ▶ Maintenance and precautions

[→ Contents list](#)

Scene Selection



You can shoot movies effectively in various situations.

1. MENU → [Camera/Audio] → [Camera Settings] → [Scene Selection].



2. Select the desired item.

| | | |
|---|--|--|
| ✓ | (Auto) Adjusts image quality automatically. | |
| | (Night Scene) Maintains the darkening atmosphere of the distant surroundings in night scenes. | |
| | (Sunrise&Sunset) Reproduces the atmosphere of scenes such as sunsets or sunrises. | |
| | (Fireworks) Takes spectacular shots of fireworks. | |
| | (Landscape) Shoots subjects adjusting the color according to the sky or greenery color. | |
| | (Spotlight) Prevents people's faces from appearing excessively white when subjects are lit by strong light. | |
| | (Beach) | |

| | | |
|--|---|---|
| | Takes the vivid blue of the ocean or a lake. |  |
| |  (Snow) Takes bright movies of a white landscape. |  |

Notes

- If you set [Scene Selection], the [White Balance] setting is canceled.

[▲ Back to top](#)

Copyright 2013 Sony Corporation

- ▶ Operation Search
- ▶ Before use
- ▶ Getting started
- ▶ Recording
- ▶ Playback
- ▶ Playing images on a TV
- ▶ Saving images with a computer
- ▶ Using the Wi-Fi function
- ▶ Customizing your camcorder
- ▶ Troubleshooting
- ▶ Maintenance and precautions

[→ Contents list](#)

Fader







You can shoot a transition with the following effects adding to the interval between scenes.

Select the desired effect in [STBY] (to fading in) or [REC] (to fading out) mode.

- MENU → [Camera/Audio] → [ Camera Settings] → [ Fader].



- Select the desired item.

| | |
|-------------------------------------|---|
| <input checked="" type="checkbox"/> | <p>Off Does not use an effect.</p> |
| | <p>White Fader () Fades in/out with the white effect. Out  In</p> <div style="text-align: center;">  </div> |
| | <p>Black Fader () Fades in/out with the black effect. Movies shot using the [Black Fader] effect may appear dark on the index screen. Out  In</p> <div style="text-align: center;">  </div> |

Notes

- When you press START/STOP, the setting is cleared.

- ▶ Operation Search
- ▶ Before use
- ▶ Getting started
- ▶ Recording
- ▶ Playback
- ▶ Playing images on a TV
- ▶ Saving images with a computer
- ▶ Using the Wi-Fi function
- ▶ Customizing your camcorder
- ▶ Troubleshooting
- ▶ Maintenance and precautions

[→ Contents list](#)

Auto Back Light

Your camcorder adjusts the exposure for backlit subjects automatically.

1. **MENU** → [Camera/Audio] → [ Camera Settings] → [Auto Back Light].



2. Select the desired item.

| | |
|---|--|
| ✓ | On The exposure for backlit subjects is adjusted automatically. |
| | Off Does not adjust the exposure for backlit subjects. |

[▲ Back to top](#)

- ▶ Operation Search
- ▶ Before use
- ▶ Getting started
- ▶ Recording
- ▶ Playback
- ▶ Playing images on a TV
- ▶ Saving images with a computer
- ▶ Using the Wi-Fi function
- ▶ Customizing your camcorder
- ▶ Troubleshooting
- ▶ Maintenance and precautions

[→ Contents list](#)



Face Detection

You can set the camcorder to detect a face automatically. Your camcorder adjusts the color/exposure automatically for the face of the selected subject.

1. MENU → [Camera/Audio] → [ Face] → [Face Detection].



2. Select the desired item.

| | |
|---|---|
| ✓ | Auto Detects faces without distinction between adults and children. |
| | Child Priority () Gives faces of children priority. |
| | Adult Priority () Gives faces of adults priority. |
| | Off () Does not detect faces. |

Shooting conditions for better face detection performance

- Shoot in a sufficiently bright place.
- The subject is not wearing glasses, a hat or mask.
- The subject faces directly towards the camcorder.

Notes

- Faces may not be detected depending on shooting conditions.

[▲ Back to top](#)

- ▶ Operation Search
- ▶ Before use
- ▶ Getting started
- ▶ Recording
- ▶ Playback
- ▶ Playing images on a TV
- ▶ Saving images with a computer
- ▶ Using the Wi-Fi function
- ▶ Customizing your camcorder
- ▶ Troubleshooting
- ▶ Maintenance and precautions

[→ Contents list](#)

Audio Format

You can select your desired audio format for movie shooting.

1. MENU → [Camera/Audio] → [Audio] → [Audio Format].



2. Select the desired item.

| | |
|---|--|
| ✓ | Linear PCM (LPCM) Records in the Linear PCM format. |
| ✓ | AAC LC (AAC LC) Records in the AAC LC format which is suitable for file sharing. |

Notes

- MP4 movies shot with [Audio Format] set to [Linear PCM] cannot be played back on some equipment or services, including Blu-ray Disc players (including Sony products). For detailed information, check the camcorder support page before use.

[▲ Back to top](#)

- ▶ Operation Search
- ▶ Before use
- ▶ Getting started
- ▶ Recording
- ▶ Playback
- ▶ Playing images on a TV
- ▶ Saving images with a computer
- ▶ Using the Wi-Fi function
- ▶ Customizing your camcorder
- ▶ Troubleshooting
- ▶ Maintenance and precautions

[→ Contents list](#)

Low Cut Filter

This function allows you to cut noise in the low frequency range during recording. Use this function to reduce noise from fixtures such as air conditioners or projector fans or when recording in a small music venues surrounded by concrete walls.

1. **MENU** → [Camera/Audio] → [🎵Audio] → [Low Cut Filter].



2. Select the desired item.

| | |
|---|--|
| ✓ | Off Records low frequency sound without reducing noise. |
| | On () Reduces noise in the low frequency range during recording. |

[▲ Back to top](#)

- ▶ Operation Search
- ▶ Before use
- ▶ Getting started
- ▶ Recording
- ▶ Playback
- ▶ Playing images on a TV
- ▶ Saving images with a computer
- ▶ Using the Wi-Fi function
- ▶ Customizing your camcorder
- ▶ Troubleshooting
- ▶ Maintenance and precautions

[→ Contents list](#)

[Top page](#) > [Customizing your camcorder](#) > [Camera/Audio](#) > [Int. Mic. Rec. Level](#)

Int. Mic. Rec. Level

You can adjust recording sensitivity when using the internal microphone.

1. **MENU** → [Camera/Audio] → [Audio] → [Int. Mic. Rec. Level].



2. Press **+** to boost the recording level and **-** to lower the recording level.
 - ± appears next to the internal microphone () indicator.
 - Select [RESET] to restore to the default setting.

Notes

- When connecting an external device such as an MTR or external microphone to the LINE IN/  (microphone) jack (PLUG IN POWER), you cannot adjust the recording level of the internal microphone.
- We recommend that you check and adjust the recording level wearing headphones.
- When continuously recording loud sound, lower the recording level in advance to record dynamic sound.
- Regardless of the setting value of the recording level, the limiter is always available.

[▲ Back to top](#)

Copyright 2013 Sony Corporation

- ▶ Operation Search
- ▶ Before use
- ▶ Getting started
- ▶ Recording
- ▶ Playback
- ▶ Playing images on a TV
- ▶ Saving images with a computer
- ▶ Using the Wi-Fi function
- ▶ Customizing your camcorder
- ▶ Troubleshooting
- ▶ Maintenance and precautions

[→ Contents list](#)

Ext. Mic. Rec. Level

You can adjust recording sensitivity when using an external microphone.

1. **MENU** → [Camera/Audio] → [♪Audio] → [Ext. Mic. Rec. Level].



2. Press **+** to boost the recording level and **-** to lower the recording level.
 - ± appears next to the external microphone () indicator.
 - Select [RESET] to restore to the default setting.

Notes

- The setting will not be activate when [Ext. Audio Input Set] is set to [Other Device].
- We recommend that you check and adjust the recording level wearing headphones.
- When continuously recording loud sound, lower the recording level in advance to record dynamic sound.
- Regardless of the setting value of the recording level, the limiter is always available.
- If an external microphone or the like is not connected to the LINE IN/  (microphone) jack (PLUG IN POWER), you cannot adjust the recording level.

[▲ Back to top](#)

Copyright 2013 Sony Corporation

- ▶ Operation Search
- ▶ Before use
- ▶ Getting started
- ▶ Recording
- ▶ Playback
- ▶ Playing images on a TV
- ▶ Saving images with a computer
- ▶ Using the Wi-Fi function
- ▶ Customizing your camcorder
- ▶ Troubleshooting
- ▶ Maintenance and precautions

[→ Contents list](#)

Audio Output Timing

You can set the timing to output sound when shooting a movie.

1. MENU → [Camera/Audio] → [🎵Audio] → [Audio Output Timing].



2. Select the desired item.

| | |
|---|--|
| ✓ | <p>Live Outputs the sound without delaying during recording.</p> |
| | <p>Lip Sync Synchronizes sound to the movie during shooting and outputs.</p> |

[▲ Back to top](#)

- ▶ Operation Search
- ▶ Before use
- ▶ Getting started
- ▶ Recording
- ▶ Playback
- ▶ Playing images on a TV
- ▶ Saving images with a computer
- ▶ Using the Wi-Fi function
- ▶ Customizing your camcorder
- ▶ Troubleshooting
- ▶ Maintenance and precautions

[→ Contents list](#)

Volume

You can adjust the sound volume during playback.

1. **MENU** → [Camera/Audio] → [♪Audio] → [Volume].



2. Adjust the volume by pressing **◀** / **▶**.

[▲ Back to top](#)

- ▶ Operation Search
- ▶ Before use
- ▶ Getting started
- ▶ Recording
- ▶ Playback
- ▶ Playing images on a TV
- ▶ Saving images with a computer
- ▶ Using the Wi-Fi function
- ▶ Customizing your camcorder
- ▶ Troubleshooting
- ▶ Maintenance and precautions

[→ Contents list](#)

Ext. Audio Input Set

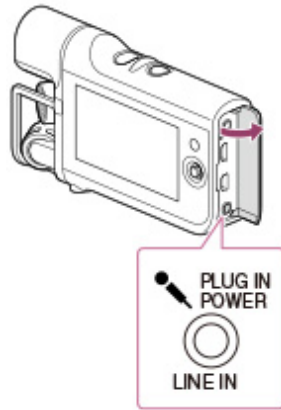

You can set the suitable sound for the connected device.

1. Connect an external device to the LINE IN/ (microphone) jack (PLUG IN POWER).



- The [Ext. Audio Input Set (Ext. Audio Input Set)] screen appears.
- If the [Ext. Audio Input Set (Ext. Audio Input Set)] screen does not appear, select **MENU** → [Camera/Audio] → [ Audio] → [Ext. Audio Input Set].

2. Select the connected external device.

| | |
|---|---|
| | External Microphone () Suitable setting for an external microphone. Allows you to set [Ext. Mic. Rec. Level]. |
| ✓ | Other Device () Suitable setting for devices other than a microphone. |

Related topics

[\[Ext. Mic. Rec. Level\]](#)

[▲ Back to top](#)

- ▶ Operation Search
- ▶ Before use
- ▶ Getting started
- ▶ Recording
- ▶ Playback
- ▶ Playing images on a TV
- ▶ Saving images with a computer
- ▶ Using the Wi-Fi function
- ▶ Customizing your camcorder
- ▶ Troubleshooting
- ▶ Maintenance and precautions

[➔ Contents list](#)

Ctrl with Smartphone

You can operate the camcorder using your smartphone or tablet as a remote control.

1. In recording mode, select **MENU** → [Camera/Audio] → [ Recording Assist] → [Ctrl with Smartphone].



Related topics

[Using your smartphone or tablet as a remote control without using NFC](#)

[Using your smartphone or tablet as a remote control using NFC](#)

[▲ Back to top](#)

- ▶ Operation Search
- ▶ Before use
- ▶ Getting started
- ▶ Recording
- ▶ Playback
- ▶ Playing images on a TV
- ▶ Saving images with a computer
- ▶ Using the Wi-Fi function
- ▶ Customizing your camcorder
- ▶ Troubleshooting
- ▶ Maintenance and precautions

[→ Contents list](#)

My Button

You can assign functions that you frequently use when recording to one of the My Buttons.

1. **MENU** → [Camera/Audio] → [Recording Assist] → [My Button].



2. Select the menu item that you want to assign to a My Button.



3. Select one of the My Buttons to which the menu item will be assigned.

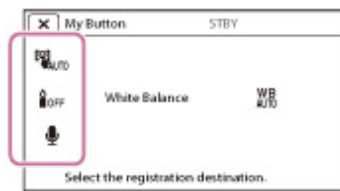

4. Select **OK**.

[▲ Back to top](#)

Copyright 2013 Sony Corporation

- ▶ Operation Search
- ▶ Before use
- ▶ Getting started
- ▶ Recording
- ▶ Playback
- ▶ Playing images on a TV
- ▶ Saving images with a computer
- ▶ Using the Wi-Fi function
- ▶ Customizing your camcorder
- ▶ Troubleshooting
- ▶ Maintenance and precautions

[→ Contents list](#)

Grid Line

You can display the lines and check that the subject is horizontal or vertical. Positioning the subject at the cross point of the grid lines makes a balanced composition. The lines is not recorded.

1. **MENU** → [Camera/Audio] → [ Recording Assist] → [Grid Line].



2. Select the desired item.

| | |
|---|---|
| ✓ | Off Does not display the grid lines. |
| | On Displays the grid lines.  |

Notes

- The outer frame of grid lines shows the display area of a TV which is not compatible with full pixel display.

[▲ Back to top](#)

Copyright 2013 Sony Corporation

- ▶ Operation Search
- ▶ Before use
- ▶ Getting started
- ▶ Recording
- ▶ Playback
- ▶ Playing images on a TV
- ▶ Saving images with a computer
- ▶ Using the Wi-Fi function
- ▶ Customizing your camcorder
- ▶ Troubleshooting
- ▶ Maintenance and precautions

[→ Contents list](#)

Display Setting

You can set the duration of displaying the icons or indicators on the LCD screen while recording.

1. **MENU** → [Camera/Audio] → [ Recording Assist] → [Display Setting].



2. Select the desired item.

| | |
|---|---------------------------------------|
| | Auto Displays for about 3 seconds. |
| ✓ | On Always displays. |

Notes

- You cannot change the setting of the icons or indicators on the LCD screen while in playback mode.

[▲ Back to top](#)

Copyright 2013 Sony Corporation

- ▶ Operation Search
- ▶ Before use
- ▶ Getting started
- ▶ Recording
- ▶ Playback
- ▶ Playing images on a TV
- ▶ Saving images with a computer
- ▶ Using the Wi-Fi function
- ▶ Customizing your camcorder
- ▶ Troubleshooting
- ▶ Maintenance and precautions

[→ Contents list](#)

Audio Level Display

You can select whether or not to display the audio level meter.

1. MENU → [Camera/Audio] → [ Recording Assist] → [Audio Level Display].



2. Select the desired item.

| | |
|---|--|
| ✓ | <p>On Displays audio level meter.</p>  |
| | <p>Off Does not display the audio level meter.</p> |

[▲ Back to top](#)

- ▶ Operation Search
- ▶ Before use
- ▶ Getting started
- ▶ Recording
- ▶ Playback
- ▶ Playing images on a TV
- ▶ Saving images with a computer
- ▶ Using the Wi-Fi function
- ▶ Customizing your camcorder
- ▶ Troubleshooting
- ▶ Maintenance and precautions

[→ Contents list](#)

Auto Monitor Off

The LCD screen goes off automatically after you start recording.

1. **MENU** → [Camera/Audio] → [ Recording Assist] → [Auto Monitor Off].



2. Select the desired item.

| | |
|---|---|
| ✓ | On Dims the LCD screen about 3 seconds after starting recording. |
| | Off Does not dim the LCD screen automatically. |

[▲ Back to top](#)

- ▶ Operation Search
- ▶ Before use
- ▶ Getting started
- ▶ Recording
- ▶ Playback
- ▶ Playing images on a TV
- ▶ Saving images with a computer
- ▶ Using the Wi-Fi function
- ▶ Customizing your camcorder
- ▶ Troubleshooting
- ▶ Maintenance and precautions

[→ Contents list](#)

REC Mode

You can select the image quality.

1. **MENU** → [Image Quality/Size] → [ REC Mode].



2. Select the desired shooting mode.

| | |
|---|---------------------------------|
| ✓ | 1080 1920 × 1080/30p quality |
| | 720 1280 × 720/30p quality |

[▲ Back to top](#)

[Top page](#) > [Customizing your camcorder](#) > [Playback Function](#) > [Playback Function](#)

- ▶ [Operation Search](#)
- ▶ [Before use](#)
- ▶ [Getting started](#)
- ▶ [Recording](#)
- ▶ [Playback](#)
- ▶ [Playing images on a TV](#)
- ▶ [Saving images with a computer](#)
- ▶ [Using the Wi-Fi function](#)
- ▶ [Customizing your camcorder](#)
- ▶ [Troubleshooting](#)
- ▶ [Maintenance and precautions](#)

[→ Contents list](#)

Playback Function

You can display the Playback Index screen.

1. **MENU** → [Playback Function].



Related topics

[Playing movies/audio files](#)

[▲ Back to top](#)

Copyright 2013 Sony Corporation

[Top page](#) > [Customizing your camcorder](#) > [Edit/Copy](#) > [Send to Smartphone](#)

- ▶ Operation Search
- ▶ Before use
- ▶ Getting started
- ▶ Recording
- ▶ Playback
- ▶ Playing images on a TV
- ▶ Saving images with a computer
- ▶ Using the Wi-Fi function
- ▶ Customizing your camcorder
- ▶ Troubleshooting
- ▶ Maintenance and precautions

[→ Contents list](#)

Send to Smartphone

You can transfer movies shot with the camcorder to your smartphone.

1. On the playback screen, select **MENU** → [Edit/Copy] → [Send to Smartphone].



Related topics

[Transferring movies to your smartphone or tablet without using NFC](#)

[Transferring movies to your smartphone or tablet using NFC](#)

[▲ Back to top](#)

Copyright 2013 Sony Corporation

- ▶ Operation Search
- ▶ Before use
- ▶ Getting started
- ▶ Recording
- ▶ Playback
- ▶ Playing images on a TV
- ▶ Saving images with a computer
- ▶ Using the Wi-Fi function
- ▶ Customizing your camcorder
- ▶ Troubleshooting
- ▶ Maintenance and precautions

[→ Contents list](#)

Delete

1. **MENU** → [Edit/Copy] → [Delete].



2. Select the desired type of file ([MP4 MOVIE] or [AUDIO]).
3. Add check marks ✓ to the desired files, and then select **OK** → **OK**.

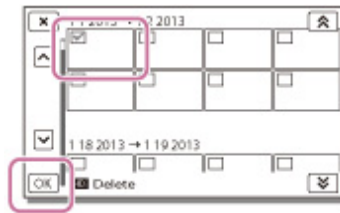

Notes

- You cannot restore files once they are deleted. Save important files in advance.
- Do not remove the battery pack or the AC Adaptor (sold separately) from your camcorder while deleting the files. It may damage the recording media.
- Do not eject the memory card while deleting files from the memory card.

Related topics

Release protection: [\[Protect\]](#)

[\[Format\]](#)

[▲ Back to top](#)

Copyright 2013 Sony Corporation

- ▶ Operation Search
- ▶ Before use
- ▶ Getting started
- ▶ Recording
- ▶ Playback
- ▶ Playing images on a TV
- ▶ Saving images with a computer
- ▶ Using the Wi-Fi function
- ▶ Customizing your camcorder
- ▶ Troubleshooting
- ▶ Maintenance and precautions

[→ Contents list](#)

Protect

Protect files to avoid deleting them by mistake.
⊙→ will be displayed on the protected files.

1. **MENU** → [Edit/Copy] → [Protect].



2. Select the desired type of files ([MP4 MOVIE] or [AUDIO]).
Add check marks ✓ to the desired files, and then select **OK** → **OK**.

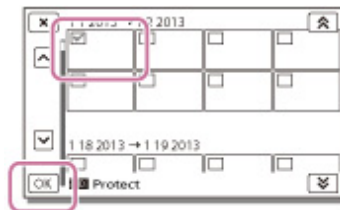

- You can select multiple files.
- Select the file with ✓ so that the ✓ mark disappears and you can remove the protection.

[▲ Back to top](#)

Copyright 2013 Sony Corporation

- ▶ Operation Search
- ▶ Before use
- ▶ Getting started
- ▶ Recording
- ▶ Playback
- ▶ Playing images on a TV
- ▶ Saving images with a computer
- ▶ Using the Wi-Fi function
- ▶ Customizing your camcorder
- ▶ Troubleshooting
- ▶ Maintenance and precautions

[→ Contents list](#)

Media Info

You can check the remaining recordable time and the approximate free and used media storage space of the recording media.

1. **MENU** → [Setup] → [ Media Settings] → [Media Info].



Notes

- Since there is a management file area, the used space is not displayed as 0% even if you perform [Format]. [\[Details\]](#)

[▲ Back to top](#)

- ▶ Operation Search
- ▶ Before use
- ▶ Getting started
- ▶ Recording
- ▶ Playback
- ▶ Playing images on a TV
- ▶ Saving images with a computer
- ▶ Using the Wi-Fi function
- ▶ Customizing your camcorder
- ▶ Troubleshooting
- ▶ Maintenance and precautions

[➔ Contents list](#)

Format

Formatting deletes all the files to recover recordable free space.

1. **MENU** → [Setup] → [ Media Settings] → [Format].



2. Select **OK**.

Notes

- To avoid the loss of important files, you should save them before formatting the recording media.
- Protected files will also be deleted.
- Make sure not to do the following while [Executing...] is displayed.
 - Operate buttons on the camcorder.
 - Eject the memory card from your camcorder.
 - Disconnect the AC Adaptor (sold separately).

[▲ Back to top](#)

Copyright 2013 Sony Corporation

- ▶ Operation Search
- ▶ Before use
- ▶ Getting started
- ▶ Recording
- ▶ Playback
- ▶ Playing images on a TV
- ▶ Saving images with a computer
- ▶ Using the Wi-Fi function
- ▶ Customizing your camcorder
- ▶ Troubleshooting
- ▶ Maintenance and precautions

[→ Contents list](#)

Repair Img. DB F.

The camcorder may be able to repair the damaged database file using this menu item.

1. **MENU** → [Setup] → [ Media Settings] → [Repair Img. DB F.].



2. Select **OK**.

[▲ Back to top](#)

- ▶ Operation Search
- ▶ Before use
- ▶ Getting started
- ▶ Recording
- ▶ Playback
- ▶ Playing images on a TV
- ▶ Saving images with a computer
- ▶ Using the Wi-Fi function
- ▶ Customizing your camcorder
- ▶ Troubleshooting
- ▶ Maintenance and precautions

[→ Contents list](#)

File Number

You can select the way to assign file numbers.

1. MENU → [Setup] → [ Media Settings] → [File Number].



2. Select the desired item.

| | |
|---|---|
| ✓ | <p>Series</p> <p>Assigns file numbers in sequence.</p> <p>The file number becomes larger each time you record files. Even if the memory card is replaced with another one, the file number is assigned in sequence.</p> |
| | <p>Reset</p> <p>Assigns file numbers in sequence, following the largest file number existing on the recording medium.</p> <p>When the memory card is replaced with another one, the file number is assigned for each memory card.</p> |

[▲ Back to top](#)

- ▶ Operation Search
- ▶ Before use
- ▶ Getting started
- ▶ Recording
- ▶ Playback
- ▶ Playing images on a TV
- ▶ Saving images with a computer
- ▶ Using the Wi-Fi function
- ▶ Customizing your camcorder
- ▶ Troubleshooting
- ▶ Maintenance and precautions

[→ Contents list](#)

Edit Device Name

You can change the device name.

1. Select MENU → [Setup] → [↔Connection] → [Edit Device Name].



2. Select the input box, input the device name, and then select OK.

How to use the keyboard

A keyboard is displayed on the screen when text needs to be entered.

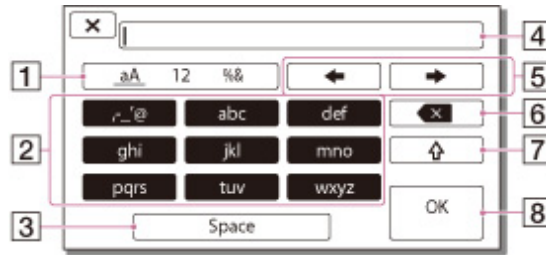

| | Screen names | Functions |
|---|------------------------|---|
| 1 | Switch character types | Each time you press the key, the type of character to be input switches between letters, numerals and symbols. |
| 2 | Keyboard | Each time you press the key, the displayed character switches between the choices available. For example: If you want to enter "abd" Press abc once to display "a" → Press → to move the cursor 5 → Press abc twice to display "b" → Press def once to display "d." |
| 3 | Space | Enters a space. A device name cannot include spaces. |
| 4 | Input box | The characters you entered are displayed. If you try to input more characters than allowed, ◀ is displayed on the screen. |
| 5 | Move | Moves the cursor in the input box to the right or left. |

| | | |
|----------|---|---|
| | cursor | |
| 6 | Delete | Deletes the character preceding the cursor. |
| 7 |  | Switches the next character to a capital or small letter. |
| 8 | Fix | Finalizes the entry. |

- To cancel text entry, select .

[▲ Back to top](#)

Copyright 2013 Sony Corporation

- ▶ Operation Search
- ▶ Before use
- ▶ Getting started
- ▶ Recording
- ▶ Playback
- ▶ Playing images on a TV
- ▶ Saving images with a computer
- ▶ Using the Wi-Fi function
- ▶ Customizing your camcorder
- ▶ Troubleshooting
- ▶ Maintenance and precautions

[→ Contents list](#)

SSID/PW Reset

The camcorder shares the SSID/password for [Send to Smartphone] and [Ctrl with Smartphone] with a device that has permission to connect. If you want to change the device that is permitted to connect to the camcorder, reset the SSID/password by the following procedure.

1. Select **MENU** → [Setup] → [ Connection] → [SSID/PW Reset] → **OK**.



Notes

- After resetting the SSID/password, you must set the smartphone again.

[▲ Back to top](#)

- ▶ Operation Search
- ▶ Before use
- ▶ Getting started
- ▶ Recording
- ▶ Playback
- ▶ Playing images on a TV
- ▶ Saving images with a computer
- ▶ Using the Wi-Fi function
- ▶ Customizing your camcorder
- ▶ Troubleshooting
- ▶ Maintenance and precautions

[➔ Contents list](#)

HDMI Resolution

Select the output image resolution when connecting your camcorder to a TV with an HDMI cable.

1. MENU → [Setup] → [ Connection] → [HDMI Resolution].



2. Select the desired item.

| | |
|---|--|
| ✓ | Auto Normal setting (outputs the signal according to the TV automatically.) |
| | 1080p Outputs the 1080p signal. |
| | 1080i Outputs the 1080i signal. |
| | 720p Outputs the 720p signal. |
| | 480p Outputs the 480p signal. |
| | 480i Outputs the 480i signal. |

[▲ Back to top](#)

- ▶ Operation Search
- ▶ Before use
- ▶ Getting started
- ▶ Recording
- ▶ Playback
- ▶ Playing images on a TV
- ▶ Saving images with a computer
- ▶ Using the Wi-Fi function
- ▶ Customizing your camcorder
- ▶ Troubleshooting
- ▶ Maintenance and precautions

[→ Contents list](#)

[Top page](#) > [Customizing your camcorder](#) > [Setup](#) > [CTRL FOR HDMI \(Control for HDMI\)](#)

CTRL FOR HDMI (Control for HDMI)

When connecting your camcorder to a “BRAVIA” Sync compatible TV with a HDMI cable (sold separately), you can play back movies on your camcorder by aiming the TV’s Remote Commander at the TV. [\[Details\]](#)

1. MENU → [Setup] → [Connection] → [CTRL FOR HDMI].



2. Select the desired item.

| | |
|---|---|
| ✓ | On Operates your camcorder using the TV’s Remote Commander. |
| | Off Does not operate your camcorder using the TV’s Remote Commander. |

[▲ Back to top](#)

- ▶ Operation Search
- ▶ Before use
- ▶ Getting started
- ▶ Recording
- ▶ Playback
- ▶ Playing images on a TV
- ▶ Saving images with a computer
- ▶ Using the Wi-Fi function
- ▶ Customizing your camcorder
- ▶ Troubleshooting
- ▶ Maintenance and precautions

[→ Contents list](#)

USB Connect

Select this item when a USB connection does not start even when you connect the camcorder to an external device with the USB cable.

1. **MENU** → [Setup] → [ Connection] → [USB Connect].

[▲ Back to top](#)

- ▶ Operation Search
- ▶ Before use
- ▶ Getting started
- ▶ Recording
- ▶ Playback
- ▶ Playing images on a TV
- ▶ Saving images with a computer
- ▶ Using the Wi-Fi function
- ▶ Customizing your camcorder
- ▶ Troubleshooting
- ▶ Maintenance and precautions

[→ Contents list](#)

USB Power Supply

Set whether to use the USB power supplied function when the camcorder is connected to a computer or a USB device using the USB cable.

1. MENU → [Setup] → [Connection] → [USB Power Supply].



2. Select the desired item.

| | |
|---|---|
| ✓ | On Power is supplied when connected using the USB cable. |
| | Off Disables USB power supplied function even if you connect the camcorder to a device such as a computer using a USB cable. |

Notes

- If you changed this setting while the USB cable was connected to the camcorder, disconnect the USB cable and connect it again.
- The setting of [USB Power Supply] is effective only when the camcorder is connected to a USB device that is compatible with the 500 mA or more power supply standard.
- Only the playback functions are available while the camcorder is connected to a USB device that is compatible with the 500 mA power supply standard.
- To record files using the [USB Power Supply] function, use an AC-UD10 AC Adaptor (sold separately) with the battery pack attached to the camcorder.

[▲ Back to top](#)

- ▶ Operation Search
- ▶ Before use
- ▶ Getting started
- ▶ Recording
- ▶ Playback
- ▶ Playing images on a TV
- ▶ Saving images with a computer
- ▶ Using the Wi-Fi function
- ▶ Customizing your camcorder
- ▶ Troubleshooting
- ▶ Maintenance and precautions

[→ Contents list](#)

USB LUN Setting

Improves compatibility with external devices by limiting the functions of the USB connection.

1. **MENU** → [Setup] → [Connection] → [USB LUN Setting].



2. Select the desired item.

| | |
|---|--|
| ✓ | Multi Use this setting for ordinary operations. |
| | Single Try this setting only if you cannot connect to an external device. |

[▲ Back to top](#)

Copyright 2013 Sony Corporation

- ▶ Operation Search
- ▶ Before use
- ▶ Getting started
- ▶ Recording
- ▶ Playback
- ▶ Playing images on a TV
- ▶ Saving images with a computer
- ▶ Using the Wi-Fi function
- ▶ Customizing your camcorder
- ▶ Troubleshooting
- ▶ Maintenance and precautions

[→ Contents list](#)

Beep

You can turn on or off the operation sound.

1. MENU → [Setup] → [General Settings] → [Beep].



2. Select the desired item.

| | |
|----------|---|
| On | An operation sound is heard when you start/stop recording, or operate your camcorder. |
| ✓ Off | Cancels the operation sound. |

[▲ Back to top](#)

- ▶ Operation Search
- ▶ Before use
- ▶ Getting started
- ▶ Recording
- ▶ Playback
- ▶ Playing images on a TV
- ▶ Saving images with a computer
- ▶ Using the Wi-Fi function
- ▶ Customizing your camcorder
- ▶ Troubleshooting
- ▶ Maintenance and precautions

[→ Contents list](#)

Monitor Brightness

You can adjust the brightness of the LCD screen.

1. **MENU** → [Setup] → [ General Settings] → [Monitor Brightness].



2. Select the desired item.

| | |
|---|---|
| ✓ | Normal Normal setting (normal brightness). |
| | Bright Select this when the LCD screen is not bright enough. This adjustment does not affect the shooting in any way. |

[▲ Back to top](#)

- ▶ Operation Search
- ▶ Before use
- ▶ Getting started
- ▶ Recording
- ▶ Playback
- ▶ Playing images on a TV
- ▶ Saving images with a computer
- ▶ Using the Wi-Fi function
- ▶ Customizing your camcorder
- ▶ Troubleshooting
- ▶ Maintenance and precautions

[→ Contents list](#)

Language Setting

You can select the language to be used on the LCD screen.

1. **MENU** → [Setup] → [ General Settings] → [Language Setting].



2. Select the desired language.

[▲ Back to top](#)

- ▶ Operation Search
- ▶ Before use
- ▶ Getting started
- ▶ Recording
- ▶ Playback
- ▶ Playing images on a TV
- ▶ Saving images with a computer
- ▶ Using the Wi-Fi function
- ▶ Customizing your camcorder
- ▶ Troubleshooting
- ▶ Maintenance and precautions

[→ Contents list](#)

Airplane Mode

When you board an airplane, you can deactivate the Wi-Fi and NFC functions temporarily.

1. Select **MENU** → [Setup] → [ Connection] → [Airplane Mode].



2. Select the desired item.

| | |
|---|---|
| ✓ | Off Normal setting. |
| | On (↑) Set to [On] when you board an airplane. |

[▲ Back to top](#)

- ▶ Operation Search
- ▶ Before use
- ▶ Getting started
- ▶ Recording
- ▶ Playback
- ▶ Playing images on a TV
- ▶ Saving images with a computer
- ▶ Using the Wi-Fi function
- ▶ Customizing your camcorder
- ▶ Troubleshooting
- ▶ Maintenance and precautions

[⇒ Contents list](#)

Power Save

When [Power Save] is on, the camcorder turns off automatically if you do not attempt to operate it for more than about 5 minutes.

1. **MENU** → [Setup] → [ General Settings] → [Power Save].



2. Select the desired item.

| | |
|---|---|
| ✓ | On The camcorder turns off automatically. |
| | Off The camcorder does not turn off automatically. |

Notes

- The camcorder does not turn off automatically while power is being supplied via USB connection.

[▲ Back to top](#)

- ▶ Operation Search
- ▶ Before use
- ▶ Getting started
- ▶ Recording
- ▶ Playback
- ▶ Playing images on a TV
- ▶ Saving images with a computer
- ▶ Using the Wi-Fi function
- ▶ Customizing your camcorder
- ▶ Troubleshooting
- ▶ Maintenance and precautions

[→ Contents list](#)

Initialize

All the settings return to the default.

Even if you use this function, all movie/audio files are retained.

1. **MENU** → [Setup] → [ General Settings] → [Initialize].



2. Select **OK**.

[▲ Back to top](#)

- ▶ Operation Search
- ▶ Before use
- ▶ Getting started
- ▶ Recording
- ▶ Playback
- ▶ Playing images on a TV
- ▶ Saving images with a computer
- ▶ Using the Wi-Fi function
- ▶ Customizing your camcorder
- ▶ Troubleshooting
- ▶ Maintenance and precautions

[→ Contents list](#)

Date & Time Setting

1. **MENU** → [Setup] → [Clock Settings] → [Date & Time Setting].



2. Select the desired item ([Date & Time Format], [Daylight Savings]/[Summer Time], or [Date & Time]).

Date & Time Format

You can select one from 4 types of date and time format.

Daylight Savings / Summer Time

You can change this setting without stopping the clock.

| | |
|---|--|
| ✓ | Off Does not set the summertime. |
| | On Sets the summertime. The clock is set to move the time forward 1 hour. |

Date & Time

You can set the clock.

[▲ Back to top](#)

Copyright 2013 Sony Corporation

- ▶ Operation Search
- ▶ Before use
- ▶ Getting started
- ▶ Recording
- ▶ Playback
- ▶ Playing images on a TV
- ▶ Saving images with a computer
- ▶ Using the Wi-Fi function
- ▶ Customizing your camcorder
- ▶ Troubleshooting
- ▶ Maintenance and precautions

[→ Contents list](#)

Area Setting

You can adjust a time difference without stopping the clock. Select your local area when using the camcorder in other time zones.

1. **MENU** → [Setup] → [Clock Settings] → [Area Setting].



2. Select the desired item.

| | |
|---|--|
| ✓ | Home Select this item when you are going to use the camcorder in the area where you are living. |
| | Destination (🚶) Select this item when you want to use the camcorder with the area setting set to another place. |

3. Select your desired country/region.
4. Select an area with **</>**, and then select **OK**.
 - You can set [Daylight Savings] or [Summer Time] by selecting **OFF**.

Related topics

[World time difference](#)

[▲ Back to top](#)

Copyright 2013 Sony Corporation

[Top page](#) > [Troubleshooting](#) > [If you have problems](#) > [If you have problems](#)

- ▶ Operation Search
- ▶ Before use
- ▶ Getting started
- ▶ Recording
- ▶ Playback
- ▶ Playing images on a TV
- ▶ Saving images with a computer
- ▶ Using the Wi-Fi function
- ▶ Customizing your camcorder
- ▶ Troubleshooting
- ▶ Maintenance and precautions

[→ Contents list](#)

If you have problems

If you run into any problems using your camcorder, follow the steps below.

1. Check the items under “Troubleshooting,” and inspect your camcorder.
If a code such as “C:(or E:) □ □ : □ □ ” appears on the screen, see “[Self-diagnosis display](#).”
2. Disconnect the power source, attach the power source again after about 1 minute, and turn the camcorder on.
3. Select **MENU** → [Setup] → [ General Settings] → [Initialize].
 - If you select [Initialize], all settings, including the clock setting, are reset.
4. Contact your Sony dealer or local authorized Sony service facility.

[▲ Back to top](#)

Copyright 2013 Sony Corporation

- ▶ Operation Search
- ▶ Before use
- ▶ Getting started
- ▶ Recording
- ▶ Playback
- ▶ Playing images on a TV
- ▶ Saving images with a computer
- ▶ Using the Wi-Fi function
- ▶ Customizing your camcorder
- ▶ Troubleshooting
- ▶ Maintenance and precautions

[→ Contents list](#)

Overall operations

The power does not turn on.

- Attach a charged battery pack to the camcorder. [\[Details\]](#)
- Connect the AC Adaptor (sold separately) to a wall outlet (wall socket). [\[Details\]](#)

The camcorder does not operate even when the power is set to on.

- It takes a few seconds for your camcorder to be ready to record after the power is turned on. This is not a malfunction.
- Disconnect the power supply (battery pack or AC Adaptor) from the camcorder, then supply the power again after about 1 minute.

The menu settings have been changed automatically.

- While Intelligent Auto is active, some menu settings related to image quality will be changed automatically.
- The following menu item returns to the default setting when you switch between movie shooting, sound recording and playback modes.
 - [ Fader]

The camcorder gets warm.

- Your camcorder may become warm during operation. This is not a malfunction.

Intelligent Auto is canceled.

- The Intelligent Auto setting is canceled if you change the following settings:
 - [White Balance]
 - [Exposure]
 - [Low Lux]
 - [Scene Selection]
 - [Auto Back Light]
 - [Face Detection]

[▲ Back to top](#)

- ▶ Operation Search
- ▶ Before use
- ▶ Getting started
- ▶ Recording
- ▶ Playback
- ▶ Playing images on a TV
- ▶ Saving images with a computer
- ▶ Using the Wi-Fi function
- ▶ Customizing your camcorder
- ▶ Troubleshooting
- ▶ Maintenance and precautions

→ [Contents list](#)

Batteries/power sources

The power abruptly turns off.

- Use the AC Adaptor (sold separately).
- In the default setting, the camcorder turns itself off when no operations are performed for about 5 minutes ([Power Save]). Change the setting of [Power Save], or turn on the power again. [\[Details\]](#)
- Charge the battery pack. [\[Details\]](#)

The CHG (charge) lamp does not light while the battery pack is being charged.

- Attach the battery pack to the camcorder correctly. [\[Details\]](#)
- When using an AC Adaptor (sold separately), connect the plug to the wall outlet (wall socket) properly.
- Connect the USB cable (supplied) properly when charging the battery pack using a computer.
- The battery charge is completed. [\[Details\]](#)

The CHG (charge) lamp flashes while the battery pack is being charged.

- When the battery is being charged using the USB cable (supplied), disconnect the USB cable (supplied) and connect it again.
- If the temperature of the battery pack is too high or too low, you may not be able to charge it. [\[Details\]](#)
- Attach the battery pack to the camcorder correctly. If the problem persists, disconnect the plug from the camcorder and contact your Sony dealer. The battery pack may be damaged. [\[Details\]](#)

The remaining battery power is not displayed correctly.

- The ambient temperature is too high or too low. This is not a malfunction.
- The battery pack has not been charged enough. Fully charge the battery again. If the problem persists, replace the battery pack with a new one. [\[Details\]](#)
- The indicated remaining battery power may not be correct depending on the environment in which the camcorder is used.

The battery pack is quickly discharged.

- The ambient temperature is too high or low. This is not a malfunction.
- The battery pack has not been charged enough. Fully charge the battery again. If the problem persists, replace the battery pack with a new one. [\[Details\]](#)

[▲ Back to top](#)

Copyright 2013 Sony Corporation

- ▶ Operation Search
- ▶ Before use
- ▶ Getting started
- ▶ Recording
- ▶ Playback
- ▶ Playing images on a TV
- ▶ Saving images with a computer
- ▶ Using the Wi-Fi function
- ▶ Customizing your camcorder
- ▶ Troubleshooting
- ▶ Maintenance and precautions

[→ Contents list](#)

LCD screen

Menu items are grayed out.

- You cannot select grayed out items in the current recording/playback situation.
- There are some functions you cannot activate simultaneously.

The buttons do not appear on the LCD screen.

- Operate the multi-selector.

The buttons on the LCD screen quickly disappear.

- If you set [Display Setting] to [On], the buttons do not disappear from the LCD screen while in recording mode. [\[Details\]](#)

There are dots in the shape of a grid on the LCD screen.

- These dots are a normal result of the manufacturing process of the screen and do not affect the shooting in any way.

The backlight of the LCD screen turns off if you do not attempt to operate your camcorder a short while after starting recording.

- In the default setting, the backlight of the LCD screen dims automatically if you do not attempt to operate your camcorder for more than about 3 seconds ([Auto Monitor Off]). [\[Details\]](#)

[▲ Back to top](#)

Copyright 2013 Sony Corporation

- ▶ Operation Search
- ▶ Before use
- ▶ Getting started
- ▶ Recording
- ▶ Playback
- ▶ Playing images on a TV
- ▶ Saving images with a computer
- ▶ Using the Wi-Fi function
- ▶ Customizing your camcorder
- ▶ Troubleshooting
- ▶ Maintenance and precautions

[➔ Contents list](#)

Memory card

Operations using the memory card cannot be performed.

- If you use the memory card formatted on a computer, format it again on your camcorder. [\[Details\]](#)

Files stored on the memory card cannot be deleted.

- The maximum number of files that you can delete on the editing screen at one time is 100.
- You cannot delete the protected files.

The data file name is not indicated correctly or flashes.

- The file is damaged.
- The file format is not supported by your camcorder. [\[Details\]](#)

Images cannot be played back or the memory card is not recognized.

- The playback device does not support playing back memory cards. [\[Details\]](#)
- If you insert the memory card upside down or at an angle, the camcorder does not recognize it. Make sure you insert the memory card properly. [\[Details\]](#)

[▲ Back to top](#)

Copyright 2013 Sony Corporation

- ▶ Operation Search
- ▶ Before use
- ▶ Getting started
- ▶ Recording
- ▶ Playback
- ▶ Playing images on a TV
- ▶ Saving images with a computer
- ▶ Using the Wi-Fi function
- ▶ Customizing your camcorder
- ▶ Troubleshooting
- ▶ Maintenance and precautions

→ [Contents list](#)

Recording

Refer also to "[Memory card.](#)"

Pressing START/STOP does not record files.

- The playback screen is displayed. Stop playback, and then select **MENU** → [Recording Mode] → [Movie] or [Audio].
- Your camcorder is recording the file you have just recorded on the recording media. You cannot make new recording during this period.
- The recording media is full. Delete unnecessary files. [\[Details\]](#)
- Total number of movie scenes exceeds the recordable capacity of your camcorder [\[Details\]](#). Delete unnecessary movies [\[Details\]](#).
- Total number of audio files exceeds the recordable capacity of your camcorder [\[Details\]](#). Delete unnecessary audio files [\[Details\]](#).

The access lamp remains lit or flashing even if recording has stopped.

- Your camcorder is recording the file you have just recorded on the memory card.

The imaging field looks different.

- The imaging field may look different depending on the condition of your camcorder. This is not a malfunction.

The actual shooting time for movies is less than the expected shooting time of the recording media.

- Depending on the shooting conditions, the time available for shooting may be shorter, for example when shooting a fast moving object, etc. [\[Details\]](#).

The camcorder stops operating.

- If you keep applying vibration on the camcorder, recording may stop.

There is a slight time lag between the moment when START/STOP is pressed and the actual movie shooting starts or stops.

- On your camcorder, there may be a slight time difference between the moment

when you press START/STOP and when the actual movie shooting starts/stops. This is not a malfunction.

Files cannot be recorded or played back correctly.

- If you record and delete files repeatedly for a long time, the files on the recording media may become fragmented and files cannot be recorded or played back correctly. After backing up the files on other media such as a computer, format the recording media on your camcorder. [\[Details\]](#)
-

The subjects passing across the camcorder very fast appear crooked.

- This is called the focal plane phenomenon. This is not a malfunction. Because of the way the image device (CMOS sensor) reads out image signals, the subjects passing by the lens rapidly might appear crooked depending on the shooting conditions.
-

Horizontal stripes appear on the images.

- This occurs when shooting movies under a fluorescent lamp, sodium lamp, or mercury lamp. This is not a malfunction.
-

LCD brightness cannot be adjusted.

- You cannot adjust LCD brightness when using the AC Adaptor (sold separately).
-

Sound is not recorded correctly.

- If you connect or disconnect an external microphone, etc. while recording movies/sound, the sound may not be recorded correctly. The sound will be recorded correctly by restoring the microphone connection at the start of recording.
-

[▲ Back to top](#)

Copyright 2013 Sony Corporation

- ▶ Operation Search
- ▶ Before use
- ▶ Getting started
- ▶ Recording
- ▶ Playback
- ▶ Playing images on a TV
- ▶ Saving images with a computer
- ▶ Using the Wi-Fi function
- ▶ Customizing your camcorder
- ▶ Troubleshooting
- ▶ Maintenance and precautions

[→ Contents list](#)

Playback



Files cannot be played back.

- Files recorded on other devices may not be played back or may not be played back in a right size. This is not a malfunction.

 appears on a thumbnail.

- This may appear on a file recorded on other devices, edited on a computer, etc.
- You removed the AC Adaptor (sold separately) or the battery pack while the recording media icon at the top right corner of the screen is lit, or before the access lamp is turned off after recording. This may damage your file data and  is displayed.

 appears on a thumbnail.

- The image data base file may be damaged. Check the data base file by selecting **MENU** → [Setup] → [ Media Settings] → [Repair Img. DB F.] → the recording medium. If it still appears, delete the file with . [\[Details\]](#)

No sound or only a quiet sound is heard during playback.

- Turn up the volume. [\[Details\]](#)
- When you record sound with [Int. Mic. Rec. Level] or [Ext. Mic. Rec. Level] set to low, the recorded sound may be difficult to hear. [\[Details\]](#) [\[Details\]](#)

[▲ Back to top](#)

Copyright 2013 Sony Corporation

- ▶ Operation Search
- ▶ Before use
- ▶ Getting started
- ▶ Recording
- ▶ Playback
- ▶ Playing images on a TV
- ▶ Saving images with a computer
- ▶ Using the Wi-Fi function
- ▶ Customizing your camcorder
- ▶ Troubleshooting
- ▶ Maintenance and precautions

[→ Contents list](#)

Playback on the TV

Neither movie nor sound is played on the connected TV.

- Movies are not output from the HDMI OUT jack, if copyright protection signals are recorded in the movies.

The top, bottom, right, and left edges of images are trimmed slightly on a connected TV.

- The LCD screen of your camcorder can display shooting images across the entire screen (full pixel display). However, this may cause slight trimming of the top, bottom, right, and left edges of images when played back on a TV which is not compatible with full pixel display.
- It is recommended you shoot images using the outer frame of [Grid Line] as a guide. [\[Details\]](#)

[▲ Back to top](#)

Copyright 2013 Sony Corporation

- ▶ Operation Search
- ▶ Before use
- ▶ Getting started
- ▶ Recording
- ▶ Playback
- ▶ Playing images on a TV
- ▶ Saving images with a computer
- ▶ Using the Wi-Fi function
- ▶ Customizing your camcorder
- ▶ Troubleshooting
- ▶ Maintenance and precautions

[→ Contents list](#)

Connecting to a computer

The editing/management software cannot be installed.

- An Internet connection is required to install the editing/management software.
- Check the computer environment or installation procedure required to install the editing/management software.

The editing/management software does not work correctly.

- Quit the editing/management software and restart your computer.

The camcorder is not recognized by the computer.

- Disconnect all USB devices from the USB jack of your computer except the keyboard, mouse, and your camcorder.
- Disconnect the USB cable (supplied) from the computer and restart the computer, then connect the computer and your camcorder again in the correct order.

[▲ Back to top](#)

- ▶ Operation Search
- ▶ Before use
- ▶ Getting started
- ▶ Recording
- ▶ Playback
- ▶ Playing images on a TV
- ▶ Saving images with a computer
- ▶ Using the Wi-Fi function
- ▶ Customizing your camcorder
- ▶ Troubleshooting
- ▶ Maintenance and precautions

[→ Contents list](#)

Wi-Fi

[Send to Smartphone] is interrupted.

- If the battery level is low, shooting with [Send to Smartphone] may terminate prematurely. Charge the battery pack before use.

The movie shooting screen is not displayed smoothly. The connection is cut off.

- Depending on the radio wave conditions, communication between the smartphone and camcorder may not work correctly. Close the distance between the camcorder and smartphone.

Shooting with [Ctrl with Smartphone] terminate prematurely.

- If the battery level is low, shooting with [Ctrl with Smartphone] may terminate prematurely. Charge the battery pack before use.

The NFC connection does not work.

- Change the position of the compatible device to reduce the distance between the N mark on the smartphone and N mark on the camcorder. If this still does not solve the problem, move the smartphone a few millimeters, or move the smartphone away from the camcorder and wait for 10 seconds or more before touching again.
- The camcorder is in the airplane mode. Deactivate the airplane mode.
- Make sure that the smartphone is ready for communication. Refer to the instruction manual of your smartphone for details.
- Do not put any metal products other than the smartphone close to the N mark on the camcorder.
- Do not touch the N mark on the camcorder with 2 or more smartphones at the same time.
- When running another application that uses the NFC function on your smartphone, close the application.

[▲ Back to top](#)

- ▶ Operation Search
- ▶ Before use
- ▶ Getting started
- ▶ Recording
- ▶ Playback
- ▶ Playing images on a TV
- ▶ Saving images with a computer
- ▶ Using the Wi-Fi function
- ▶ Customizing your camcorder
- ▶ Troubleshooting
- ▶ Maintenance and precautions

[→ Contents list](#)

Self-diagnosis display

If indicators appear on the LCD screen, check the following.

If the problem persists even after you have tried to fix a couple of times, contact your Sony dealer or local authorized Sony service facility. When you contact them, give them the complete error code beginning with C or E displayed on the screen.

- You may hear a melody when an important warning indicator appears on the screen.



C:(or E:) □ □ : □ □ (Self-diagnosis display)

C:06: □ □

- The battery pack temperature is high. Change the battery pack or place it in a cool place.

C:13: □ □ / C:32: □ □

- Remove the power source. Reconnect it and operate your camcorder again.

E: □ □ : □ □

- Follow the steps from 2 on "[If you have problems](#)".

 (Battery level warning)

- The battery pack is nearly used up.
- Depending on the operating environment or battery conditions,  may flash even with about 20 minutes of power remaining.

 (Warning indicator pertaining to battery pack temperature)

- The battery pack temperature is high. Change the battery pack or place it in a cool place.

 (Warning indicator pertaining to memory card)

Slow flashing

- Free spaces for recording files are running out. For the type of memory card you can use with your camcorder, see “[Types of memory card you can use with your camcorder](#)”.
- No memory card is inserted. [\[Details\]](#)

Fast flashing

- There is not enough free spaces for recording files. After storing the files on other media, delete unnecessary files [\[Details\]](#), or format the memory card [\[Details\]](#).
- The image data base file may be damaged.
Check the data base file by selecting **MENU** → [Setup] → [ Media Settings] → [Repair Img. DB F.] → the recording medium.
- The memory card is damaged.

(Warning indicators pertaining to memory card formatting)

- The memory card is damaged.
- The memory card is not formatted correctly. [\[Details\]](#)

(Warning indicator pertaining to incompatible memory card)

- Incompatible memory card is inserted. [\[Details\]](#)

(Warning indicator pertaining to the write-protect of the memory card)

- Access to the memory card was restricted on another device.

[▲ Back to top](#)

Copyright 2013 Sony Corporation

- ▶ Operation Search
- ▶ Before use
- ▶ Getting started
- ▶ Recording
- ▶ Playback
- ▶ Playing images on a TV
- ▶ Saving images with a computer
- ▶ Using the Wi-Fi function
- ▶ Customizing your camcorder
- ▶ Troubleshooting
- ▶ Maintenance and precautions

→ [Contents list](#)

[Top page](#) > [Troubleshooting](#) > [Self-diagnosis display/Warning indicators](#) > [Warning Indicators](#)

Warning Indicators

If messages appear on the screen, follow the instructions.

Data error.

- An error occurred during reading or writing files to the memory card.
- This may occur when you keep applying shock to the camcorder.
- Files recorded on other devices may not be played back.

The Image Database File is damaged. Do you want to create a new file?

- The management file is damaged. When you select [Yes], a new management file is created. The old recorded files on the media cannot be played back (Image files are not damaged). If you execute [Repair Img. DB F.] after creating new information, playing back the old recorded files may become possible.

There is no Image Database File Movies cannot be recorded or played Create a new file?

- You cannot shoot or play back movies because no movie management information exists. If you select [Yes], new management information is created and you can shoot or play back movies.

Inconsistencies found in image database file. Do you want to repair the image database file?

The Image Database File is damaged. Do you want to repair the Image Database File?

- You cannot record because the management file is damaged. Repair it by selecting .

Buffer overflow. Writing to the media was not completed in time.

- You have performed recording and erasing operations repeatedly, or a memory card that has been formatted by other device is used. Copy and take data backup to other device (such as a computer), and then format the memory card on the camcorder. [\[Details\]](#)

- The inserted memory card is not efficient enough for copying the file(s). Use the recommended memory card. [\[Details\]](#)
-

Restoring data...

- Your camcorder tries to recover data automatically if the data writing was not performed properly.
-

Cannot recover data.

- Writing data onto the media of the camcorder has failed. Attempts were made to recover the data, but they were unsuccessful.
-

Reinsert the memory card.

- Reinsert the memory card a few times. If the indicator continues to flash even after reinserting, the memory card could be damaged. Try with another memory card.
 - Insert the memory card in the right direction.
-

Reinsert the memory card. Verify the positioning of the memory card.

- Insert the memory card in the right direction.
-

Cannot recognize this memory card. Format and use again.

- Format the memory card. Note that when you format the memory card, all the recorded files are deleted. [\[Details\]](#)
-

This memory card may not be able to record or play movies.

This memory card may not be able to record or play images correctly.

- Use a memory card recommended for your camcorder. [\[Details\]](#)
-

Do not eject the memory card during writing. Data may be damaged.

- Reinsert the memory card.
-

Number of audio files full. Cannot record audio files.

- The number of audio files exceeds the recordable capacity of the memory card.
- Change the memory card or format the memory card after copying and taking data backup to a hard disk drive such as a computer.

Others

Maximum number of images already selected.

- You can select only 100 saved files at one time for:
 - Deleting saved files
 - Protecting saved files, or releasing the protection
-

Data protected.

- You tried to delete protected data. Release the protection of the data.

[▲ Back to top](#)

Copyright 2013 Sony Corporation

- ▶ Operation Search
- ▶ Before use
- ▶ Getting started
- ▶ Recording
- ▶ Playback
- ▶ Playing images on a TV
- ▶ Saving images with a computer
- ▶ Using the Wi-Fi function
- ▶ Customizing your camcorder
- ▶ Troubleshooting
- ▶ Maintenance and precautions

[➔ Contents list](#)

About the memory card

- A memory card formatted by a computer (Windows OS/Mac OS) is not guaranteed to be compatible with your camcorder.
- Data read/write speed may vary depending on the combination of the memory card and memory card compliant product you use.
- Data may be damaged or lost in the following cases (the data will not be compensated for):
 - If you eject the memory card, or turn off your camcorder while your camcorder is reading or writing files on the memory card (while the access lamp is lit or flashing)
 - If you use the memory card near magnets or magnetic fields
- It is recommended that you make a back-up of important data on the hard disk of a computer.
- Do not attach a label or the like on memory card or memory card adaptor.
- Do not touch, or allow metallic objects to come into contact with the terminals.
- Do not bend, drop or apply strong force to the memory card.
- Do not disassemble or modify the memory card.
- Do not allow the memory card to get wet.
- Keep the memory card out of the reach of small children. There is danger that a child might swallow it.
- Do not insert anything other than the compliant size of memory card into the memory card slot. Doing so may cause a malfunction.
- Do not use or keep the memory card in the following locations:
 - Places subject to extremely high temperature, such as a car parked outside in the sun
 - Places under direct sunlight
 - Places with extremely high humidity or subject to corrosive gases

About the "Memory Stick" media

| Types of "Memory Stick" media | Recording/Playback |
|------------------------------------|--------------------|
| "Memory Stick Micro" media | — |
| "Memory Stick Micro" media (Mark2) | ✓ |

- This product cannot record or play back data that uses "MagicGate" technology. "MagicGate" is a copyright protection technology that records and transfers the contents in an encrypted format.

[▲ Back to top](#)

- ▶ Operation Search
- ▶ Before use
- ▶ Getting started
- ▶ Recording
- ▶ Playback
- ▶ Playing images on a TV
- ▶ Saving images with a computer
- ▶ Using the Wi-Fi function
- ▶ Customizing your camcorder
- ▶ Troubleshooting
- ▶ Maintenance and precautions

→ [Contents list](#)

[Top page](#) > [Maintenance and precautions](#) > [Maintenance and precautions](#) > [About the battery pack](#)

About the battery pack

To charge the battery pack

- Be sure to charge the battery pack before you start using your camcorder.
- We recommend that you charge the battery pack in an ambient temperature range of 10 °C to 30 °C (50 °F to 86 °F) until the CHG (charge) lamp turns off. If you charge the battery pack outside of this temperature range, you may not be able to charge it efficiently.
- The CHG (charge) lamp flashes during charging under the following conditions.
 - The battery pack is not attached correctly.
 - The battery pack is damaged.
 - The temperature of the battery pack is low.
Remove the battery pack from your camcorder and put it in a warm place.
 - The temperature of the battery pack is high.
Remove the battery pack from your camcorder and put it in a cool place.

To use the battery pack effectively

- Battery pack performance decreases when the ambient temperature is 10 °C (50 °F) or below, and the length of time you can use the battery pack becomes shorter. If that happens, one of the following is recommended to enable longer use of the battery pack:
 - Put the battery pack in a pocket to warm it up, and install it on your camcorder immediately before you start recording.
- Frequent use of the LCD screen or a frequent playback, fast forward or reverse operation wears out the battery pack faster.
- Be sure to turn off the camcorder when not recording or playing back on your camcorder. The battery pack is also consumed when your camcorder is in recording standby or playback pause.
- Have spare battery packs ready for 2 or 3 times the expected recording time, and make trial recordings before making the actual recording.
- Do not expose the battery pack to water. The battery pack is not water resistant.

About the remaining battery power indicator

- When the power goes off even though the remaining battery power indicator indicates that the battery pack has enough power to operate, charge the battery pack fully again. The battery level will be indicated correctly. Note, however, that the battery indication will not be restored if it is used in high temperatures for a long time, or if left in a fully charged state, or when the battery pack is frequently used.

About storage of the battery pack

- If the battery pack is not used for a long time, fully charge the battery pack and use it up on your camcorder once a year to maintain proper function. To store the battery pack, remove it from your camcorder and put it in a dry, cool place.

- To discharge the battery pack on your camcorder completely, select **MENU** → [Setup] → [ General Settings] → [Power Save] → [Off], and leave your camcorder in recording standby until the power goes off. [\[Details\]](#)

About battery life

- Battery capacity decreases over time and through repeated use. If the interval between charges becomes significantly short, the battery pack may need to be replaced with a new one.
- Each battery's life depends on storage, operating and environmental conditions.

[▲ Back to top](#)

Copyright 2013 Sony Corporation

[Top page](#) > [Maintenance and precautions](#) > [About handling of your camcorder](#) > [On use and care](#)

- ▶ [Operation Search](#)
- ▶ [Before use](#)
- ▶ [Getting started](#)
- ▶ [Recording](#)
- ▶ [Playback](#)
- ▶ [Playing images on a TV](#)
- ▶ [Saving images with a computer](#)
- ▶ [Using the Wi-Fi function](#)
- ▶ [Customizing your camcorder](#)
- ▶ [Troubleshooting](#)
- ▶ [Maintenance and precautions](#)

[→ Contents list](#)

On use and care

- ▼ [On recording](#)
- ▼ [Notes on use](#)
- ▼ [LCD screen](#)
- ▼ [About this manual, illustrations and on-screen displays](#)
- ▼ [On use and care](#)
- ▼ [When not using your camcorder for a long time](#)
- ▼ [Note on the camcorder/battery pack temperature](#)
- ▼ [Notes on charging through the USB cable](#)
- ▼ [When the camcorder is connected to a computer or accessories](#)
- ▼ [Notes on optional accessories](#)
- ▼ [About care of the battery pack](#)
- ▼ [About care of the LCD screen](#)
- ▼ [On handling the LCD screen](#)
- ▼ [About care and storage of the lens](#)

On recording

- Before starting to record, test the recording function to make sure the image and sound are recorded without any problems.
- Compensation for the contents of recordings cannot be provided, even if recording or playback is not possible due to a malfunction of the camcorder, recording media, etc.
- Television programs, films, video tapes, and other materials may be copyrighted. Unauthorized recording of such materials may be contrary to the copyright laws.

Notes on use

- Do not do any of the following. If any of those are done, the recording media may be damaged, saved images may be impossible to play back or may be lost, or other malfunctions could occur.
 - Ejecting the memory card when the access lamp is lit or flashing
 - Removing the battery pack or AC Adaptor (sold separately) from the camcorder, or applying mechanical shock or vibration to the camcorder when the camcorder is on or the access lamp is lit or flashing
- When the camcorder is connected to other devices through a USB connection and the power of the camcorder is turned on, do not turn off the camcorder. The image data that has been shot may be lost.
- Use the camcorder in accordance with local regulations.
- Be careful not to swallow the screw which fixed the camcorder to the box at the

time of purchase.

LCD screen

- The LCD screen is manufactured using extremely high-precision technology, so over 99.99% of the pixels are operational for effective use. However, there may be some tiny black points and/or bright points (white, red, blue, or green in color) that appear constantly on the LCD screen. These points are normal results of the manufacturing process and do not affect the shooting in any way.

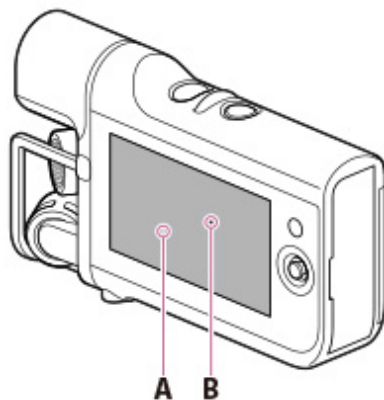

- A: White, red, blue or green points
- B: Black points

About this manual, illustrations and on-screen displays

- Design and specifications of your camcorder and accessories are subject to change without notice.
- In this manual, the memory card is called “recording media.”

On use and care

- The camcorder is not dustproofed, dripproofed or waterproofed.
- Do not hold the camcorder by the jack cover.
- Do not aim the camcorder at the sun. Doing so might cause your camcorder to malfunction. Take images of the sun only in low light conditions, such as at dusk.
- Do not use or store the camcorder and accessories in the following locations:
 - Anywhere extremely hot, cold or humid. Never leave them exposed to temperatures above 60 °C (140 °F), such as under direct sunlight, near heaters or in a car parked in the sun. They may malfunction or become deformed.
 - Near strong magnetic fields or mechanical vibration. The camcorder may malfunction.
 - Near strong radio waves or radiation. The camcorder may not be able to record properly.
 - Near tuner devices such as TVs or radio. Noise may occur.
 - On a sandy beach or anywhere dusty. If sand or dust gets in your camcorder, it may malfunction. Sometimes this malfunction cannot be repaired.
 - Near windows or outdoors, where the LCD screen or the lens may be exposed to direct sunlight. This damages the LCD screen.
- For AC operation, use the accessories recommended in these operating instructions.
- Do not let your camcorder get wet, for example, from rain or sea water. If your

camcorder gets wet, it may malfunction. Sometimes this malfunction cannot be repaired.

- If any solid object or liquid gets inside the casing, unplug your camcorder and have it checked by a Sony dealer before operating it any further.
- Avoid rough handling, disassembling, modifying, physical shock, or impact such as hammering, dropping or stepping on the product. Be particularly careful with the lens.
- Do not operate your camcorder with it wrapped in an object such as a towel.
- When disconnecting the power cord (mains lead), pull it by the plug and not the cord.
- Do not damage the power cord (mains lead) such as by placing anything heavy on it.
- Do not use a deformed or damaged battery pack.
- Keep metal contacts clean.
- If the battery electrolytic liquid has leaked:
 - Consult your local authorized Sony service facility.
 - Wash off any liquid that may have contacted your skin.
 - If any liquid gets in your eyes, wash with plenty of water and consult a doctor.

When not using your camcorder for a long time

- To keep your camcorder in optimum state for a long time, turn it on and let it run by recording and playing back images about once a month.
- Use up the battery pack completely before storing it.

Note on the camcorder/battery pack temperature

- When the temperature of the camcorder or battery pack becomes extremely high or extremely low, you may not be able to record or play back on the camcorder, due to the protection features of the camcorder being activated in such situations. In this case, an indicator appears on the LCD screen.

Notes on charging through the USB cable

- Charging may not be possible with all computers.
- If you connect the camcorder to a laptop computer that is not connected to a power source, the battery of the laptop computer will continue to use up its charge. Do not leave the camcorder connected to a computer in this manner.
- Charging with a personally assembled computer, with a converted computer, or through a USB hub are not guaranteed. The camcorder may not function correctly depending on the USB device which is used with the computer.

When the camcorder is connected to a computer or accessories

- Do not try to format the recording media of the camcorder with a computer. If you do so, your camcorder may not operate correctly.
- When connecting the camcorder to another device with communication cables, be sure to insert the connector plug in the correct way. Pushing the plug forcibly into the terminal will damage the terminal and may result in a malfunction of the camcorder.

Notes on optional accessories

- We recommend using genuine Sony accessories.
- Genuine Sony accessories may not be available in some countries/regions.

About care of the battery pack

- You may not be able to turn on the camcorder or the battery pack may not be effectively charged if the terminal section of the battery is dirty. In this case, wipe any dust off lightly using a soft cloth or a cotton swab to clean the battery.

About care of the LCD screen

- If you leave fingerprints, hand cream, etc. on the LCD screen, the coating of the LCD screen will come off easily. Wipe those off as soon as possible.
- If you wipe the LCD screen strongly with a tissue, etc., the coating of the LCD screen may be scratched.
- If the LCD screen becomes dirty with fingerprints or dust, it is recommended that you gently remove those from the screen then clean it with a soft cloth, etc.

On handling the LCD screen

- Do not apply excessive pressure on the LCD screen, as it may cause uneven color and other damage.
- If your camcorder is used in a cold place, a residual image may appear on the LCD screen. This is not a malfunction.
- While using your camcorder, the periphery of the LCD screen may heat up. This is not a malfunction.

About care and storage of the lens

- Wipe the surface of the lens clean with a soft cloth in the following instances:
 - When there are fingerprints on the lens surface
 - In hot or humid locations
 - When the lens is exposed to salty air such as at the seaside
- Store in a well-ventilated location subject to little dirt or dust.
- To prevent mold, periodically clean and store the lens as described above.

[▲ Back to top](#)

Copyright 2013 Sony Corporation

[Top page](#) > [Maintenance and precautions](#) > [About handling of your camcorder](#) > [On moisture condensation](#)

- ▶ Operation Search
- ▶ Before use
- ▶ Getting started
- ▶ Recording
- ▶ Playback
- ▶ Playing images on a TV
- ▶ Saving images with a computer
- ▶ Using the Wi-Fi function
- ▶ Customizing your camcorder
- ▶ Troubleshooting
- ▶ Maintenance and precautions

[→ Contents list](#)

On moisture condensation

If your camcorder is brought directly from a cold place to a warm place, moisture may condense inside your camcorder. This may cause a malfunction to your camcorder.

- If moisture condensation occurs, leave your camcorder for about 1 hour without turning it on.
- Note on moisture condensation
Moisture may condense when you bring your camcorder from a cold place into a warm place (or vice versa) or when you use your camcorder in a humid place as follows:
 - You bring your camcorder from a ski slope into a place warmed up by a heating device.
 - You bring your camcorder from an air conditioned car or room into a hot place outside.
 - You use your camcorder after a squall or a rain.
 - You use your camcorder in a hot and humid place.

- How to prevent moisture condensation

When you bring your camcorder from a cold place into a warm place, put your camcorder in a plastic bag and seal it tightly. Remove the bag when the air temperature inside the plastic bag has reached the surrounding temperature (after about 1 hour).

[▲ Back to top](#)

Copyright 2013 Sony Corporation

[Top page](#) > [Maintenance and precautions](#) > [About handling of your camcorder](#) > [On charging the pre-installed rechargeable battery](#)

- ▶ Operation Search
- ▶ Before use
- ▶ Getting started
- ▶ Recording
- ▶ Playback
- ▶ Playing images on a TV
- ▶ Saving images with a computer
- ▶ Using the Wi-Fi function
- ▶ Customizing your camcorder
- ▶ Troubleshooting
- ▶ Maintenance and precautions

[→ Contents list](#)

On charging the pre-installed rechargeable battery

Your camcorder has a pre-installed rechargeable battery to retain the date, time, and other settings even when the camcorder is turned off. The pre-installed rechargeable battery is always charged while your camcorder is connected to the wall outlet (wall socket) via the AC Adaptor or while the battery pack is attached. The rechargeable battery will be fully discharged in about 3 months if you do not use your camcorder at all. Charge the pre-installed rechargeable battery before you start using your camcorder.

However, even if the pre-installed rechargeable battery is not charged, the camcorder operation other than date recording will not be affected.

How to charge the pre-installed rechargeable battery

Connect your camcorder to a wall outlet (wall socket) using the AC-UD10 AC Adaptor or attach the fully charged battery pack, and leave it with the camcorder turned off for more than 24 hours.

[▲ Back to top](#)

Copyright 2013 Sony Corporation

[Top page](#) > [Maintenance and precautions](#) > [About handling of your camcorder](#) > [Note on disposal/transfer of the memory card](#)

- ▶ Operation Search
- ▶ Before use
- ▶ Getting started
- ▶ Recording
- ▶ Playback
- ▶ Playing images on a TV
- ▶ Saving images with a computer
- ▶ Using the Wi-Fi function
- ▶ Customizing your camcorder
- ▶ Troubleshooting
- ▶ Maintenance and precautions

[→ Contents list](#)

Note on disposal/transfer of the memory card

Even if you delete data in the memory card or format the memory card on your camcorder or a computer, you may not delete data from the memory card completely. When you give the memory card to somebody, it is recommended that you delete data completely using data deletion software on a computer. Also, when you dispose of the memory card, it is recommended that you destroy the actual body of the memory card.

[▲ Back to top](#)

Copyright 2013 Sony Corporation

[Top page](#) > [Maintenance and precautions](#) > [Recording time of movies/sound](#) > [Charging time](#)

- ▶ Operation Search
- ▶ Before use
- ▶ Getting started
- ▶ Recording
- ▶ Playback
- ▶ Playing images on a TV
- ▶ Saving images with a computer
- ▶ Using the Wi-Fi function
- ▶ Customizing your camcorder
- ▶ Troubleshooting
- ▶ Maintenance and precautions

[→ Contents list](#)

Charging time

Approximate time (min.) required when you fully charge a fully discharged battery pack.

| Battery pack | Charging time | |
|-------------------|-----------------------------------|--------------------------------------|
| | USB cable (when using a computer) | AC-UD10 AC Adaptor (sold separately) |
| NP-BX1 (supplied) | 245 | 155 |

- The charging times shown in the table above are measured when charging the camcorder at a temperature of 25 °C (77 °F). It is recommended that you charge the battery in a temperature range of 10 °C to 30 °C (50 °F to 86 °F).

[▲ Back to top](#)

Copyright 2013 Sony Corporation

[Top page](#) > [Maintenance and precautions](#) > [Recording time of movies/sound](#) > [Expected time of recording and playback with the battery pack](#)

- ▶ Operation Search
- ▶ Before use
- ▶ Getting started
- ▶ Recording
- ▶ Playback
- ▶ Playing images on a TV
- ▶ Saving images with a computer
- ▶ Using the Wi-Fi function
- ▶ Customizing your camcorder
- ▶ Troubleshooting
- ▶ Maintenance and precautions

[→ Contents list](#)

Expected time of recording and playback with the battery pack

▼ Recording time

▼ Playing time

Recording time

Approximate time available when you use a fully charged battery pack.
(unit: minute)

| Battery pack | Continuous recording time | | Typical recording time | |
|-------------------|---------------------------|-------|------------------------|-------|
| | Movie | Audio | Movie | Audio |
| NP-BX1 (supplied) | 130 | 345 | 75 | 205 |

- Each movie recording time is measured when [ REC Mode] is set to [1080] and [Audio Format] is set to [AAC LC].
- Typical recording time shows the time when you repeat recording start/stop and switching the [Recording Mode].
- Times measured when using the camcorder at 25 °C (77 °F). 10 °C to 30 °C (50 °F to 86 °F) is recommended.
- The recording and playback time will be shorter, depending on the conditions under which you use your camcorder, such as when use your camcorder in low temperatures.

Playing time

Approximate time available when you use a fully charged battery pack.
(unit: minute)

| Battery pack | | |
|-------------------|-------|-------|
| File type | Movie | Audio |
| NP-BX1 (supplied) | 210 | 255 |

[Top page](#) > [Maintenance and precautions](#) > [Recording time of movies/sound](#) > [Expected shooting time of movies](#)

- ▶ Operation Search
- ▶ Before use
- ▶ Getting started
- ▶ Recording
- ▶ Playback
- ▶ Playing images on a TV
- ▶ Saving images with a computer
- ▶ Using the Wi-Fi function
- ▶ Customizing your camcorder
- ▶ Troubleshooting
- ▶ Maintenance and precautions

→ [Contents list](#)

Expected shooting time of movies

▼ Expected shooting time of movies

▼ Bit-rate and recording pixels

Expected shooting time of movies

When [Audio Format] is [AAC LC]

(unit: minute)

| Recording mode | 16 GB | 32 GB | 64 GB |
|----------------|--------------|--------------|----------------|
| [1080] | 125 (125) | 250 (250) | 505 (505) |
| [720] | 320 (320) | 650 (650) | 1305 (1305) |

When [Audio Format] is [Linear PCM]

(unit: minute)

| Recording mode | 16 GB | 32 GB | 64 GB |
|----------------|--------------|--------------|----------------|
| [1080] | 110 (110) | 230 (230) | 460 (460) |
| [720] | 265 (265) | 535 (535) | 1080 (1080) |

- When using a Sony memory card.

Notes

- The shooting time may vary depending on the shooting and subject conditions, [REC Mode] or [Audio Format]. [\[Details\]](#)
- The number in () is the minimum shooting time.
- You can shoot movies of a maximum of 40,000 scenes.
- The maximum continuous shooting time of movies is approximately 13 hours.
- Your camcorder uses the VBR (Variable Bit Rate) format to automatically adjust image quality to suit the shooting scene. This technology causes fluctuations in the shooting time of the media. Movies containing quickly moving and complex images are shot at a higher bit-rate, and this reduces the overall shooting time.

Bit-rate and recording pixels

Bit-rate of movies (movie + sound etc.), pixels, aspect ratio and audio format

- Approx. 16.2 Mbps (average) 1,920 × 1,080 pixels/30p, 16:9, audio format: AAC
- Approx. 6.2 Mbps (average) 1,280 × 720 pixels/30p, 16:9, audio format: AAC
- Approx. 17.6 Mbps (average) 1,920 × 1,080 pixels/30p, 16:9, audio format: Linear PCM
- Approx. 7.6 Mbps (average) 1,280 × 720 pixels/30p, 16:9, audio format: Linear PCM

[▲ Back to top](#)

Copyright 2013 Sony Corporation

[Top page](#) > [Maintenance and precautions](#) > [Recording time of movies/sound](#) > [Expected recording time of sound](#)

- ▶ Operation Search
- ▶ Before use
- ▶ Getting started
- ▶ Recording
- ▶ Playback
- ▶ Playing images on a TV
- ▶ Saving images with a computer
- ▶ Using the Wi-Fi function
- ▶ Customizing your camcorder
- ▶ Troubleshooting
- ▶ Maintenance and precautions

[→ Contents list](#)

Expected recording time of sound

Expected recording time of sound

(unit: minute)

| 16 GB | 32 GB | 64 GB |
|----------------|----------------|----------------|
| 1115 (1115) | 2235 (2235) | 4485 (4485) |

- When using a Sony memory card.

Notes

- The number in () is the minimum recordable time.
- You can record a maximum of 9,999 audio files.
- The maximum continuous recording time for sound is about 2 hours 50 minutes.
- Playing files recorded on other devices is not guaranteed.

[▲ Back to top](#)

Copyright 2013 Sony Corporation

- ▶ Operation Search
- ▶ Before use
- ▶ Getting started
- ▶ Recording
- ▶ Playback
- ▶ Playing images on a TV
- ▶ Saving images with a computer
- ▶ Using the Wi-Fi function
- ▶ Customizing your camcorder
- ▶ Troubleshooting
- ▶ Maintenance and precautions

→ [Contents list](#)

[Top page](#) > [Maintenance and precautions](#) > [Using your camcorder abroad](#) > [Using your camcorder abroad](#)

Using your camcorder abroad

Power supply

You can use your camcorder in any countries/regions using the AC-UD10 AC Adaptor within the AC 100 V to 240 V, 50 Hz/60 Hz range.

Viewing high definition image quality (HD) movies

In countries/regions where high definition image quality (HD) broadcasts are supported, you can view shot movies on a TV at the same high definition image quality (HD) as they were shot with the camcorder.

To view images at the same high definition image quality (HD) as they were shot with the camcorder, you need an HDMI cable and a high definition TV (or monitor) that supports the signal format for your camcorder and is equipped with an HDMI jack.

Setting to the local time

You can easily set the clock to the local time by setting a time difference when using your camcorder abroad. Select **MENU** → [Setup] → [⌚ Clock Settings] → [Date & Time Setting] → [Daylight Savings] or [Summer Time] [\[Details\]](#), and **MENU** → [Setup] → [⌚ Clock Settings] → [Area Setting] [\[Details\]](#).

World time difference

| Time-zone differences | Area setting |
|-----------------------|----------------------------|
| GMT | Lisbon/London |
| +01:00 | Berlin/Paris |
| +02:00 | Helsinki/Cairo/Istanbul |
| +03:00 | Nairobi |
| +03:30 | Tehran |
| +04:00 | Moscow/Abu Dhabi/Baku |
| +04:30 | Kabul |
| +05:00 | Karachi/Islamabad |
| +05:30 | Kolkata/New Delhi |
| +06:00 | Almaty/Dhaka |
| +06:30 | Yangon |
| +07:00 | Bangkok/Jakarta |
| +08:00 | HongKong/Singapore/Beijing |

| | |
|--------|-----------------------|
| +09:00 | Tokyo/Seoul |
| +09:30 | Adelaide/Darwin |
| +10:00 | Melbourne/Sydney |
| +11:00 | Solomon Is |
| +12:00 | Fiji/Wellington |
| -11:00 | Midway Island |
| -10:00 | Hawaii |
| -09:00 | Alaska |
| -08:00 | LosAngeles/Tijuana |
| -07:00 | Denver/Arizona |
| -06:00 | Chicago/MexicoCity |
| -05:00 | New York/Bogota |
| -04:00 | Santiago |
| -03:30 | St. John's |
| -03:00 | Brasilia/Montevideo |
| -02:00 | Fernando de Noronha |
| -01:00 | Azores/Cape Verde Is. |



[▲ Back to top](#)

Copyright 2013 Sony Corporation

- ▶ Operation Search
- ▶ Before use
- ▶ Getting started
- ▶ Recording
- ▶ Playback
- ▶ Playing images on a TV
- ▶ Saving images with a computer
- ▶ Using the Wi-Fi function
- ▶ Customizing your camcorder
- ▶ Troubleshooting
- ▶ Maintenance and precautions

[→ Contents list](#)

On trademarks

- “Memory Stick,” “,” “Memory Stick Duo,” “**MEMORY STICK DUO**,” “Memory Stick PRO Duo,” “**MEMORY STICK PRO DUO**,” “Memory Stick PRO-HG Duo,” “**MEMORY STICK PRO-HG DUO**,” “Memory Stick Micro,” “MagicGate,” “**MAGIC GATE**,” “MagicGate Memory Stick” and “MagicGate Memory Stick Duo” are trademarks or registered trademarks of Sony Corporation.
- “BIONZ” is a trademark of Sony Corporation.
- “BRAVIA” is a trademark of Sony Corporation.
- “PlayMemories Mobile” and the “PlayMemories Mobile” logo are trademarks of Sony Corporation.
- The terms HDMI and HDMI High-Definition Multimedia Interface, and the HDMI Logo are trademarks or registered trademarks of HDMI Licensing LLC in the United States and other countries.
- Microsoft, Windows, Windows Vista, and DirectX are either registered trademarks or trademarks of Microsoft Corporation in the United States and/or other countries.
- Mac, Mac OS and App Store are registered trademarks of Apple Inc. in the U.S. and other countries.
- Intel, Intel Core, and Pentium are trademarks or registered trademarks of Intel Corporation or its subsidiaries in the United States and other countries.
- “” and “PlayStation” are registered trademarks of Sony Computer Entertainment Inc.
- microSDXC logo is a trademark of SD-3C, LLC.
- Facebook and the “f” logo are trademarks or registered trademarks of Facebook, Inc.
- YouTube and the YouTube logo are trademarks or registered trademarks of Google Inc.
- Android and Google Play are trademarks or registered trademarks of Google Inc.
- iOS is a registered trademark or trademark of Cisco Systems, Inc. and/or its affiliates in the United States and certain other countries.
- Wi-Fi, the Wi-Fi logo, Wi-Fi PROTECTED SET-UP are registered trademarks of the Wi-Fi Alliance.
- The N mark is a trademark or registered trademark of NFC Forum, Inc. in the United States and in other countries.

All other product names mentioned herein may be the trademarks or registered trademarks of their respective companies. Furthermore, ™ and ® are not mentioned in each case in this manual.



Add further enjoyment with your PlayStation 3 by downloading the application for PlayStation 3 from PlayStation Store (where available.)

The application for PlayStation 3 requires PlayStation Network account and application download.

Accessible in areas where the PlayStation Store is available.

[▲ Back to top](#)

Copyright 2013 Sony Corporation

- ▶ Operation Search
- ▶ Before use
- ▶ Getting started
- ▶ Recording
- ▶ Playback
- ▶ Playing images on a TV
- ▶ Saving images with a computer
- ▶ Using the Wi-Fi function
- ▶ Customizing your camcorder
- ▶ Troubleshooting
- ▶ Maintenance and precautions

➔ [Contents list](#)

Notes on the License

THIS PRODUCT IS LICENSED UNDER THE AVC PATENT PORTFOLIO LICENSE FOR THE PERSONAL USE OF A CONSUMER OR OTHER USES IN WHICH IT DOES NOT RECEIVE REMUNERATION TO

(i) ENCODE VIDEO IN COMPLIANCE WITH THE AVC STANDARD (“AVC VIDEO”) AND/OR

(ii) DECODE AVC VIDEO THAT WAS ENCODED BY A CONSUMER ENGAGED IN A PERSONAL ACTIVITY AND/OR WAS OBTAINED FROM A VIDEO PROVIDER LICENSED TO PROVIDE AVC VIDEO.

NO LICENSE IS GRANTED OR SHALL BE IMPLIED FOR ANY OTHER USE. ADDITIONAL INFORMATION MAY BE OBTAINED FROM MPEG LA, L.L.C. SEE <[HTTP://WWW.MPEGLA.COM](http://www.mpegla.com)>

We provide the software in your camcorder based on license agreements with the owners of the respective copyrights. Based on requests by the owners of copyright of these software applications, we have an obligation to inform you of the following. Please read the following sections.

Copies of the licenses (in English) are stored in the internal memory of your camcorder. Establish a Mass Storage connection between your camcorder and a computer, and read the files in the “LICENSE” folder in “PMHOME.”

On GNU GPL/LGPL applied software

The software that is eligible for the following GNU General Public License (hereinafter referred to as “GPL”) or GNU Lesser General Public License (hereinafter referred to as “LGPL”) are included in the camcorder.

This informs you that you have a right to have access to, modify, and redistribute source code for these software programs under the conditions of the supplied GPL/LGPL.

Source code is provided on the web. Use the following URL to download it. When downloading the source code, select HDR-MV1 as the model for your camcorder. <http://www.sony.net/Products/Linux/>

We would prefer you do not contact us about the contents of source code. Copies of the licenses (in English) are stored in the internal memory of your camcorder. Establish a Mass Storage connection between your camcorder and a computer, and read the files in the “LICENSE” folder in “PMHOME.”

▲ [Back to top](#)

Copyright 2013 Sony Corporation

- ▶ Operation Search
- ▶ Before use
- ▶ Getting started
- ▶ Recording
- ▶ Playback
- ▶ Playing images on a TV
- ▶ Saving images with a computer
- ▶ Using the Wi-Fi function
- ▶ Customizing your camcorder
- ▶ Troubleshooting
- ▶ Maintenance and precautions

[→ Contents list](#)

Specifications

System

Signal format:

Digital HDTV specification

Movie file recording format:

Movie recording format: MPEG-4 AVC/H.264

Audio recording format: AAC LC 48kHz 128kbps

Linear PCM (WAV) 48kHz 16bit

Audio file recording format:

Linear PCM (WAV)

Recording media

Memory Stick Micro (Mark2) media

microSD memory card (Class 4 or faster)

Image device:

7.77 mm (1/2.3 type) CMOS sensor

Recording pixels:

Gross: Approx. 16 800 000 pixels

Effective (movie, 16:9): Approx. 8 400 000 pixels

Lens: Carl Zeiss Tessar

F2.8

f=2.5 mm

When converted to a 35 mm still camera

For movies:

f=18.2 mm (16:9)

Color temperature: [Auto], [One Push], [Indoor], [Outdoor]

Minimum illumination:

9 lx (lux) (in default setting, shutter speed 1/30 second)

4.5 lx (lux) ([Low Lux] is set to [On], shutter speed 1/30 second)

Input/Output connectors

HDMI OUT jack: HDMI micro connector

LINE IN/MIC input jack: 3.5 mm stereo mini jack

Headphone jack: 3.5 mm stereo mini jack

Multi/Micro USB terminal*

* You can connect devices which support the Micro USB standard.

LCD screen

Screen size: 6.7 cm (2.7 type, aspect ratio 16:9)

Total number of pixels: 230 400 (960 × 240)

General

Power requirements: DC 3.6 V (battery pack), DC 5.0 V 1 500 mA (AC Adaptor (sold separately))

USB charging (Multi/Micro USB terminal): DC 5 V 800 mA

Average power consumption: 2.1 W
(During movie shooting in the default setting)
Operating temperature: 0 °C to 40 °C (32 °F to 104 °F)
Storage temperature: -20 °C to +60 °C (-4 °F to +140°F)

Dimensions (approx.):

116.5 mm × 70.5 mm × 27 mm (4 5/8 in. × 2 7/8 in. × 1 1/8 in.) (w/h/d) including the projecting parts, and the supplied rechargeable battery pack attached

Mass (approx.):

140 g (5.0 oz) main unit only

165 g (5.9 oz) including the supplied rechargeable battery pack

Wireless LAN

Supported standard: IEEE 802.11 b/g/n

Frequency: 2.4 GHz

Supported security protocols: WPA-PSK/WPA2-PSK

NFC: NFC Forum Type 3 Tag compliant

Rechargeable battery pack NP-BX1

Type: Li-ion

Maximum output voltage: DC 4.2 V

Output voltage: DC 3.6 V

Capacity: 4.5 Wh (1 240 mAh)

Design and specifications of your camcorder and accessories are subject to change without notice.

[▲ Back to top](#)

Copyright 2013 Sony Corporation

Free Manuals Download Website

<http://myh66.com>

<http://usermanuals.us>

<http://www.somanuals.com>

<http://www.4manuals.cc>

<http://www.manual-lib.com>

<http://www.404manual.com>

<http://www.luxmanual.com>

<http://aubethermostatmanual.com>

Golf course search by state

<http://golfingnear.com>

Email search by domain

<http://emailbydomain.com>

Auto manuals search

<http://auto.somanuals.com>

TV manuals search

<http://tv.somanuals.com>