



Hard Disk Recorder

SVR-S500

Operating Instructions



To find out useful hints, tips and information about Sony products and services please visit: www.sony-europe.com/myproduct



© 2006 Sony Corporation

Important Information

Should you experience a problem with this recorder, please refer to the trouble shooting section on page 47. If you are unable to rectify the problem, contact the Sony Customer Information Centre at

08705 111 999

(Monday-Friday from 9:00am to 6:00pm)

Please ensure you have the following information available before calling the helpline:

Date of purchase:

Serial number:

Model name:

Post code:

Detailed fault description:

Signal strength and signal quality:

Notes:

- You can check the signal strength and signal quality of this recorder, see page 46. The serial number and the model name are located under the recorder.
- This recorder is only designed for use in the United Kingdom. Compliance with digital terrestrial TV broadcast standards in other countries is not guaranteed.

WARNING

To reduce the risk of fire or electric shock, do not expose this apparatus to rain or moisture.



To avoid electrical shock, do not open the cabinet. Refer servicing to qualified personnel only.



Disposal of Old Electrical & Electronic Equipment (Applicable in the European Union and other European countries with separate collection systems)

This symbol on the product or on its packaging indicates that this product shall not be treated as household waste. Instead it shall be handed over to the applicable collection point for the recycling of electrical and electronic equipment. By ensuring this product is disposed of correctly, you will help prevent potential negative consequences for the environment and human health, which could otherwise be caused by inappropriate waste handling of this product. The recycling of materials will help to conserve natural resources. For more detailed information about recycling of this product, please contact your local Civic Office, your household waste disposal service or the shop where you purchased the product.

Notice for customers in the United Kingdom and Republic of Ireland

A moulded plug complying with BS1363 is fitted to this equipment for your safety and convenience. Should the fuse in the plug supplied need to be replaced, a 5 AMP fuse approved by ASTA or BSI to BS1362, (i.e., marked with  or ) must be used.

If the plug supplied with this equipment has a detachable fuse cover, be sure to attach the fuse cover after you change the fuse. Never use the plug without the fuse cover. If you should lose the fuse cover, please contact your nearest Sony service station.

Precautions

- The supplied AC adaptor must be used to power this recorder. Check that the AC adaptor operating voltage is identical with your local power supply.
- To prevent fire or shock hazard, do not place objects filled with liquids, such as vases, on the apparatus.
- Install this system so that the mains lead can be unplugged from the wall socket immediately in the event of trouble.

Precautions

This equipment has been tested and found to comply with the limits set out in the EMC Directive using a connection cable shorter than 3 metres.

On safety

Should any solid object or liquid fall into the cabinet, unplug the recorder and have it checked by qualified personnel before operating it any further.

About the hard disk drive

The hard disk has a high storage density, which enables long recording durations and quick access to the written data. However, it can easily be damaged by shock, vibration or dust, and should be kept away from magnets. To avoid losing important data, observe the following precautions.

- Do not apply a strong shock to the recorder.
- Do not place the recorder in a location subject to mechanical vibrations or in an unstable location.
- Do not place the recorder on top of a hot surface, such as a VCR or amplifier (receiver).
- Do not use the recorder in a place subject to extreme changes in temperature (temperature gradient less than 10 °C/hour).
- Do not move the recorder with its mains lead connected.
- Do not disconnect the mains lead while the power is on.
- When disconnecting the mains lead, turn off the power and make sure that the hard disk drive is not operating (the clock is displayed in the front panel display and all recording or dubbing has stopped).
- Do not move the recorder for one minute after you have unplugged the mains lead.
- Do not attempt to replace or upgrade the hard disk by yourself, as this may result in malfunction.

If the hard disk drive should malfunction, you cannot recover lost data. The hard disk drive is only a temporary storage space.

About repairing the hard disk drive

- The contents of the hard disk drive may be checked in case of repair or inspection during a malfunction or modification. However, the contents will not be backed up or saved by Sony.

- If the hard disk needs to be formatted or replaced, it will be done at the discretion of Sony. All contents of the hard disk drive will be erased, including contents that violate copyright laws.

On power sources

- The recorder is not disconnected from the AC power source (mains) as long as it is connected to the wall outlet, even if the recorder itself has been turned off.
- If you are not going to use the recorder for a long time, be sure to disconnect the recorder from the wall outlet. To disconnect the AC power cord (mains lead), grasp the plug itself; never pull the cord.
- Before disconnecting the AC power cord (mains lead), check that the recorder's hard disk is not operating (recording or dubbing) on the front panel display.

On placement

- Place the recorder in a location with adequate ventilation to prevent heat build-up in the recorder.
- Do not place the recorder on a soft surface such as a rug that might block the ventilation holes.
- Do not place the recorder in a confined space such as a bookshelf or similar unit.
- Do not place the recorder in a location near heat sources, or in a place subject to direct sunlight, excessive dust, or mechanical shock.
- Do not place the recorder in an inclined position. It is designed to be operated in a horizontal position only.
- Keep the recorder and discs away from equipment with strong magnets, such as microwave ovens, or large loudspeakers.
- Do not place heavy objects on the recorder.

On recording

Make trial recordings before making the actual recording.

On compensation for lost recordings

Sony is not liable and will not compensate for any lost recordings or relevant losses, including when recordings are not made due to reasons including recorder failure, or when the contents of a recording are lost or damaged as a result of recorder failure or repair undertaken to the recorder. Sony will not restore, recover, or replicate the recorded contents under any circumstances.

Copyrights

- Television programmes, films, video tapes, discs, and other materials may be copyrighted. Unauthorized recording of such material may be contrary to the provisions of the copyright laws. Also, use of this recorder with cable television transmission may require authorization from the cable television transmitter and/or programme owner.

IMPORTANT NOTICE

Caution: This recorder is capable of holding a still video image or on-screen display image on your television screen indefinitely. If you leave the still video image or on-screen display image displayed on your TV for an extended period of time you risk permanent damage to your television screen. Plasma display panels and projection televisions are especially susceptible to this.

If you have any questions or problems concerning your recorder, please consult your nearest Sony dealer.

About this manual

- In this manual, the internal hard disk drive is written as "HDD," unless otherwise specified by the text or illustrations.
- Instructions in this manual describe the controls on the remote. You can also use the controls on the recorder if they have the same or similar names as those on the remote.
- The on-screen display illustrations used in this manual may not match the graphics displayed on your TV screen.
- All recording and storage times referred to in this manual are approximate and are dependent on the channels and content recorded. Any claims relating to storage capacity assume a mix of programming is recorded (ie. TV and Radio).

Notes About This Recorder

On operation

- If the recorder is brought directly from a cold to a warm location, or is placed in a very damp room, moisture may condense inside the recorder. Should this occur, the recorder may not operate properly. In this case, if the recorder is on, leave it on (if it is off, leave it off) for about an hour until the moisture evaporates.
- When you move the recorder, protect it from any shock. If you don't, the hard disk drive may be damaged.

On the Hard Disk

- A hard disk drive is built in to the recorder to enable you to record and store programming so you no longer need to record to video tapes. The hard disk drive in this recorder is 80GB, allowing you to store 80 hours of programming depending on the compression technology.
- The amount of hard disk space available is displayed in the Hard Disk Usage bar. See page 16. This indicates the amount of free, used and reserved space for scheduled recordings currently available.

On the compression technology

- You can increase the capacity of the hard disk by compressing the broadcast to maximise storage space. When recording a programme on the hard disk, you can select your preferred recording mode, equivalent to VCR recording modes. These range from SP (Standard Play – the normal recording speed) offering highest quality recordings using maximum hard disk capacity, LP (Long Play), to EP (Extended Play), creating lowest quality recording using minimum hard disk capacity.
- Recorded programmes can be compressed to create additional storage space, either when the recording is set (page 26) or once the recording has been made (page 39). When this occurs, additional disk space is required to perform the operation. It may be necessary to delete existing recordings stored in the Title List to allow for the compression to take place.

On adjusting volume

Do not turn up the volume while listening to a section with very low level inputs or no audio signals. If you do, the speakers may be damaged when a peak level section is played.

On cleaning

Clean the cabinet, panel, and controls with a soft cloth slightly moistened with a mild detergent solution. Do not use any type of abrasive pad, scouring powder or solvent such as alcohol or benzene.

About repairing the hard disk drive

- It may be necessary to access data stored on the hard disk for testing purposes; there is no intention to copy or store the data, titles or any other information.
- If replacement or initialization (format) is required, the hard disk will be formatted at our discretion. In this case, please note that all of the contents recorded there will be erased (including any data found to violate copyright law).

Table of Contents

Important Information	2
WARNING	2
Precautions	3
Notes About This Recorder	4

Hookups and Settings	7
Hooking Up the Recorder	7
Step 1: Connecting the Aerial Cable	7
Step 2: Connecting the Video Cords	8
Connecting your TV	8
Connecting a VCR or Similar Device	9
Step 3: Connecting the Audio Cords	10
Step 4: Connecting the Mains Lead	10
Step 5: Preparing the Remote	11
Controlling TVs with the remote	11
If you have more than one Sony Hard Disk Recorder	12
Step 6: Auto Tuning (Full Channel Scan)	13

Four Basic Operations— Getting to Know Your Hard Disk Recorder

1. Changing Channels	14
Using the PROG +/- buttons	14
Using the Number buttons	14
Using the PROG LIST button	14
2. Pausing a TV Broadcast (TV Pause)	15
3. Recording a Programme (One Touch Recording)	16
Checking the hard disk status	16
4. Playing the Recorded Programme (Title List)	17
Displaying the Playing Time and Play Information	19

Guide to Digital Services	20
TV GUIDE (Electronic Programme Guide)	20
Viewing the TV listing (GUIDE)	20
Displaying the programme information box	21
Favourites	21
Setting a Favourite List	21
Ordering your favourite channels	22
Watching or listening to a favourite channel	22
Viewing a digital text service	23
Selecting digital text from dedicated digital teletext channels	23
Selecting digital text from other channels	24
Setting TV programme reminders	24

Timer Recording	26
Before Recording	26
Timer Recording (Standard/TV Guide)	26
Setting the timer manually (Standard)	26
Recording TV programmes using the TV Guide application	28
Checking/Changing/Canceling Timer Settings (Timer List)	29
<hr/>	
Playback	31
Playing	31
Playback options	32
Playing a paused TV Broadcast (TV Pause)	33
Playing from the beginning of the programme you are recording (Chasing Playback)	33
Playing a previous recording while making another (Simultaneous Rec and Play)	33
Playing titles from a programme category folder	34
Adding new category folders	34
Changing category folders name (Rename)	34
Moving recordings to a programme category folder	35
<hr/>	
Erasing and Editing	36
Before Editing	36
Erasing and Editing a Title	36
Erasing a Title/Scene	37
Erasing sections of a title (Crop Editing)	37
Copying Title/Section	38
Creating and Editing a Playlist	38
Increasing recording capacity	39
<hr/>	
Settings and Adjustments	40
Digital TV settings (DTV Settings)	40
Favourites	40
Parental Lock	40
Auto Tune	41
Video and Audio Settings (Options)	42
Recording/Hard Disk Recorder and Remote Control Settings/Factory Settings (Features)	43
Technical Information (Technical Info)	45
Manufacturer Information	45
Signal Strength	46
<hr/>	
Additional Information	47
Troubleshooting	47
Specifications	49
Guide to Parts and Controls	50
Index	53

Hooking Up the Recorder

Follow steps 1 through 6 to hook up and adjust the settings of the recorder. Do not connect the mains lead until you reach “Step 4: Connecting the Mains Lead” on page 10.

Notes

- See “Specifications” (page 49) for a list of supplied accessories.
- Plug cords securely to prevent unwanted noise.
- Refer to the instructions supplied with the components to be connected.
- You cannot connect this recorder to a TV that does not have a SCART or video input jack.
- Be sure to disconnect the mains lead of each component before connecting.

Step 1: Connecting the Aerial Cable

Connect the aerial cable by following the steps below.

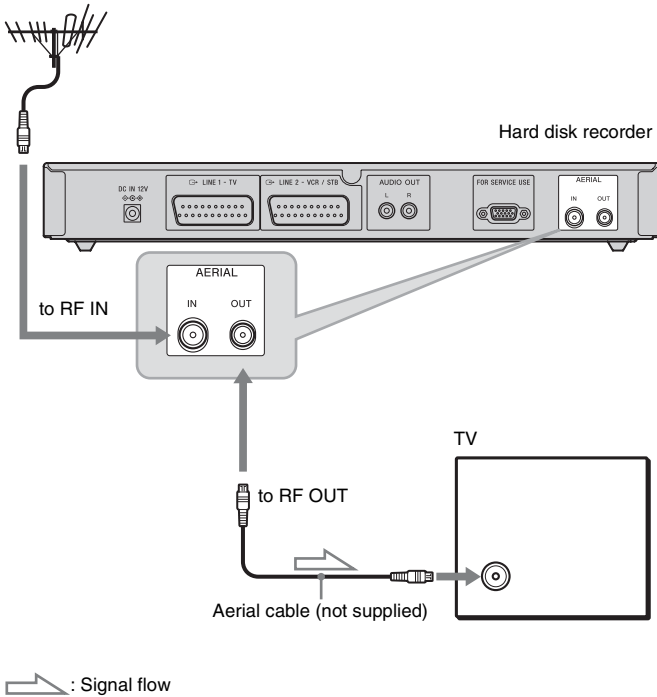



- 1** Disconnect the aerial cable from your TV and connect it to AERIAL IN on the rear panel of the recorder.
- 2** Connect AERIAL OUT of the recorder to the aerial input of your TV, using an optional aerial cable.

Step 2: Connecting the Video Cords

Connecting your TV

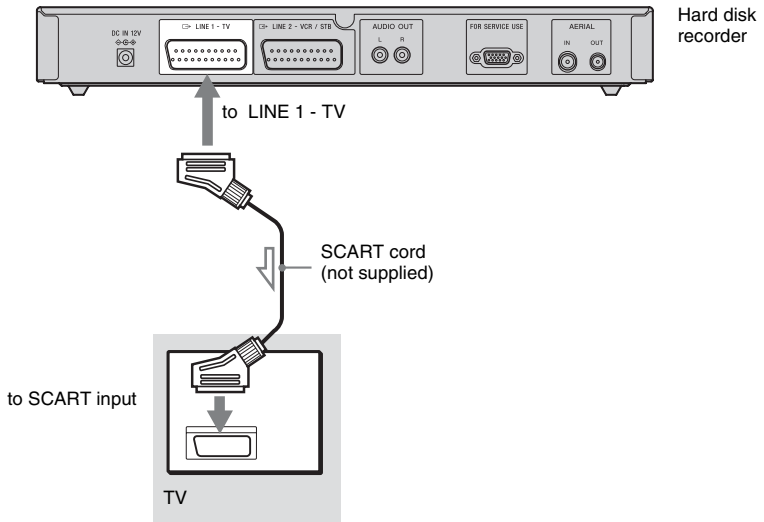
Connect LINE 1 - TV on the recorder and the Scart (EURO-AV) connector on the TV with the optional SCART cord.



 : Signal flow

When playing “wide screen” images

Some recorded images may not fit your TV screen. To change the picture size, see page 42.

Note

When you connect the recorder to your TV via the SCART jacks, the TV's input source is set to the recorder automatically when you turn on the recorder. If necessary, press TV/VIDEO to switch the input source of your TV to the recorder, see “Controlling TVs with the remote” on page 11.

Connecting a VCR or Similar Device

After disconnecting the mains lead from the mains, connect a VCR or similar recording device to the LINE 2 - VCR / STB jack of this recorder.

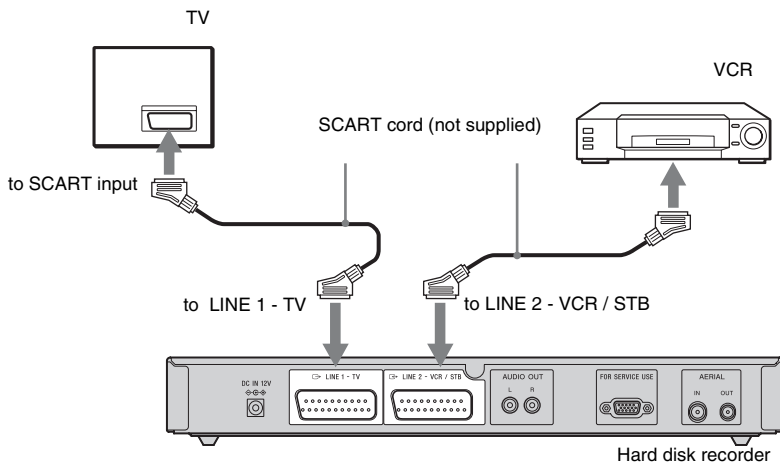

Notes

- Be sure to connect your VCR to the Hard disk recorder and your TV in the order shown below. To watch video tapes, watch the tapes through a second line input on your TV.

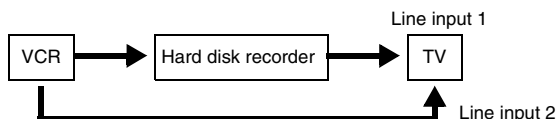

If your TV is not featured with a second line input, you can pass the VCR signal via the Hard Disk recorder to watch video tapes on the TV. If necessary, press the INPUT SELECT button on your remote to switch the recorder's input to the LINE 2 - VCR / STB line to enable the VCR video signal to pass through the Hard Disk recorder.

- This recorder cannot record the contents from the connected VCR, STB or similar device.
- If you disconnect the recorder's mains lead, you will not be able to view the signals from the connected VCR on the TV.

Step 3: Connecting the Audio Cords

You can improve sound quality by connecting a stereo system to the AUDIO OUT R-L jacks as shown below.

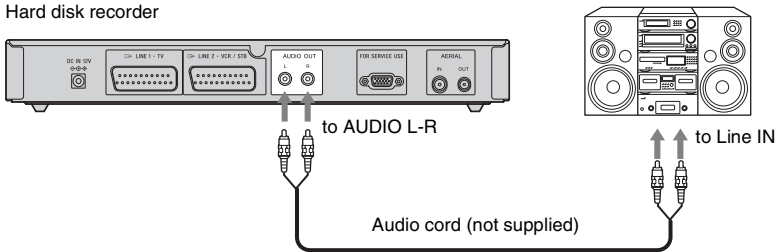

Hint

For correct speaker location, see the operating instructions supplied with the connected components.

Step 4: Connecting the Mains Lead

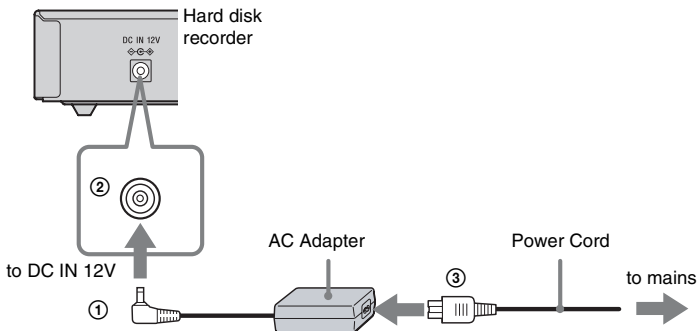

- 1** Plug the cable attached to the AC adapter ① into the DC In connector ② on the recorder.
- 2** Plug one end of the power cord ③ into the AC adapter.
- 3** Plug the other end of the power cord into the mains.
Then plug the recorder and TV mains leads (power cords) into the mains.

After you connect the mains lead, **you must wait for a short while before operating the recorder.** You can operate the recorder once the front panel display lights up and the recorder enters standby mode.

If you connect additional equipment to this recorder (page 9), be sure to connect the mains lead after all connections are complete.

Step 5: Preparing the Remote

You can control the recorder using the supplied remote. Insert two R6 (size AA) batteries by matching the ⊕ and ⊖ ends on the batteries to the markings inside the battery compartment. When using the remote, point it at the remote sensor  on the recorder.

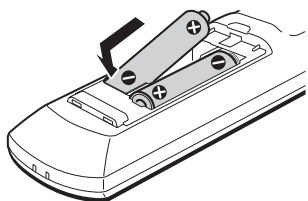

⚡ Notes

- If the supplied remote interferes your other Sony Hard Disk recorder, change the command mode number for this recorder (page 12).
- Use the batteries correctly to avoid possible leakage and corrosion. Do not touch the liquid with bare hands should leakage occur. Observe the following:
 - Do not use a new battery with an old battery, or batteries of different manufacturers.
 - Do not attempt to recharge the batteries.
 - If you do not intend to use the remote for an extended period of time, remove the batteries.
 - If battery leakage occurs, wipe out any liquid inside the battery compartment, and insert new batteries.
- Do not expose the remote sensor (marked  on the front panel) to strong light, such as direct sunlight or lighting apparatus. The recorder may not respond to the remote.

Controlling TVs with the remote

You can adjust the remote's signal to control your TV.

⚡ Notes

- Depending on the connected unit, you may not be able to control your TV with some or all of the buttons below.
- If you enter a new code number, the code number previously entered will be erased.
- When you replace the batteries of the remote, the code number may be reset to the default setting. Set the appropriate code number again.

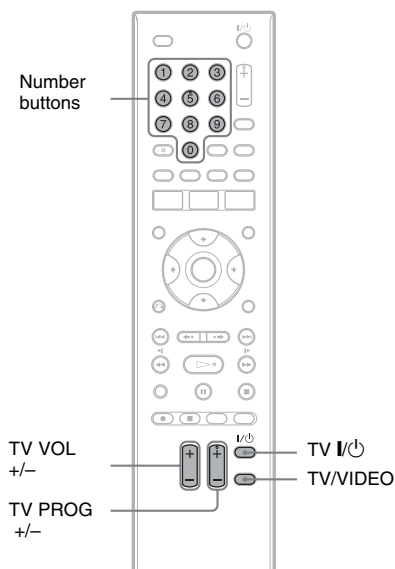

1 Hold down the TV dedicated I/⏻ button located at the bottom of the remote.

Do not press the I/⏻ button at the top of the remote.

2 With the TV I/⏻ button pressed down, enter the TV's manufacturer code using the number buttons.

For instance, to enter "09," press "0" then "9." After you enter the last number, release the TV I/⏻ button.

Code numbers of controllable TVs

If more than one code number is listed, try entering them one at a time until you find the one that works with your TV.

Manufacturer	Code number
Sony	01 (default)
Hitachi	24
JVC	33
Panasonic	17, 49
Philips	06, 08
Samsung	71
Sanyo	25
Thomson	43
Toshiba	38

The remote performs the following:

Buttons	Operations
TV I/⏻	Turns your TV on or off
TV VOL +/-	Adjusts the volume of your TV
TV PROG +/-	Selects the programme position on your TV
TV/VIDEO	Switches your TV's input source

To operate the TV/VIDEO button

The TV/VIDEO button switches the input source on your TV. Point your remote at the TV when using this button.

When you connect the recorder to the TV via the SCART jacks, the input source for the TV is set to the recorder automatically when you turn on the recorder. To watch another source, press the TV/VIDEO button to switch the TV's input source.

If you have more than one Sony Hard Disk Recorder

If the supplied remote interferes with your other Sony Hard Disk recorder, set the command mode number for this recorder and the supplied remote to one that differs from the other Sony Hard Disk recorder after you have completed "Step 6: Auto Tuning (Full Channel Scan)" (page 13).

The default command mode setting for this recorder and the supplied remote is HDD 1.

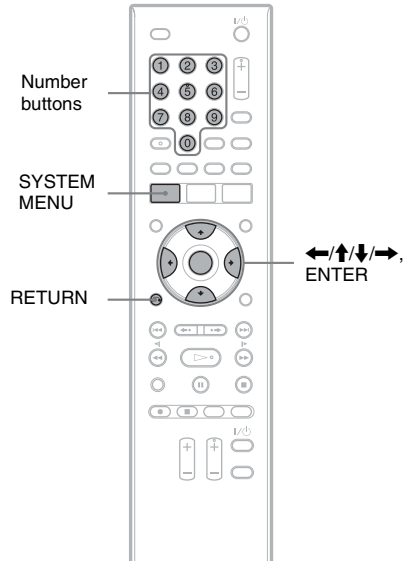

1 Check that "Step 6: Auto Tuning (Full Channel Scan)" on page 13 has been finished.

2 Press SYSTEM MENU.

The System Menu appears.

3 Select "SETUP," and press ENTER.

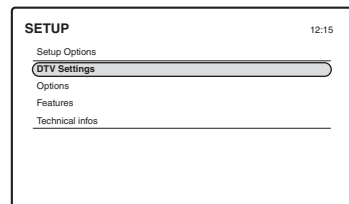

4 Select "Features," and press ENTER.

5 Select "Command Mode."

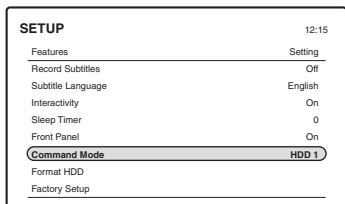

6 Press ←/→ to select the desired mode (HDD 1, HDD 2, or HDD 3).

A message appears and indicates that the Command Mode has changed.

7 Set the Command Mode for the remote so it matches the Command Mode for the recorder you set above.

Follow the steps below to set the Command Mode on the remote.

- 1 Hold down ENTER.
- 2 While holding down ENTER, enter the Command Mode code number using the number buttons.

Command Mode	Code number
HDD 1	1
HDD 2	2
HDD 3	3

- 3 Hold down both the number and ENTER buttons at the same time for more than three seconds.

If the Command Mode for the recorder has not been changed, set the Command Mode for the remote to the default setting of HDD 1. If the Command Mode for the remote is changed to HDD 2 or HDD 3, you will be unable to operate this recorder.

Step 6: Auto Tuning (Full Channel Scan)

Once the Sony Hard Disk recorder has been connected to the mains for the first time, follow the on-screen instructions to enable the recorder to start searching for all of the receivable TV and Radio channels in your local area.

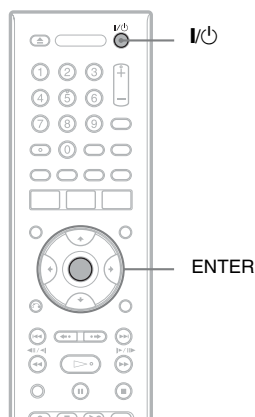

1 Turn on the recorder and switch the input selector on your TV so that the signal from the recorder appears on your TV screen.

The welcome message about the initial settings appears.

- If this message does not appear, select "DTV Settings" from "SETUP" in the System Menu to run "Auto Tune". See page 41.

2 Press ENTER.

The recorder will automatically capture and store the available TV and Radio channels.

3 Press ENTER when "Scan Done" appears on the front panel display.

Auto Tuning is finished.

Hint

If a new channel is launched or your aerial is realigned you may need to re-store channels. In this case repeat the steps above.

Four Basic Operations

— Getting to Know Your Hard Disk Recorder

1. Changing Channels

This section introduces the basic operation to view all the current available programmes that have been tuned to your Hard Disk Recorder. Before starting, make sure that “Step 6: Auto Tuning (Full Channel Scan)” on page 13 has been completed.

Turn on the recorder and switch the input selector on your TV so that the signal from the recorder appears on your TV screen.

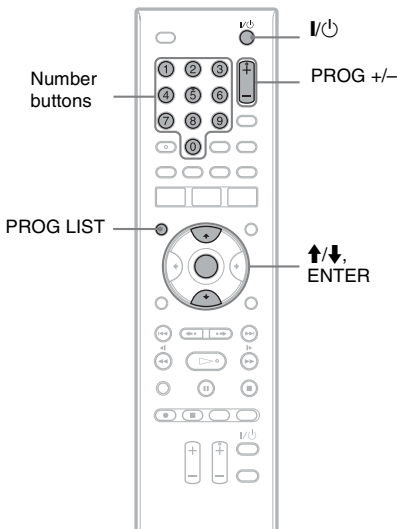

Using the PROG +/- buttons

Press **PROG +/-** on your remote control.

The Hard Disk Recorder tunes to the next channel, and the programme ID and channel name appear in the upper part of your TV screen.

Using the Number buttons

You can also change channels by entering the channel number using the 0–9 buttons.

The Hard Disk Recorder tunes to that channel, and the programme ID and channel name appear in the upper part of your TV screen.

Using the PROG LIST button

The programme list provides a quick and easy way to:

- View the list of all available channels.
- Move to another channel.

1 Press PROG LIST to display the programme list screen.

The Program List display appears.

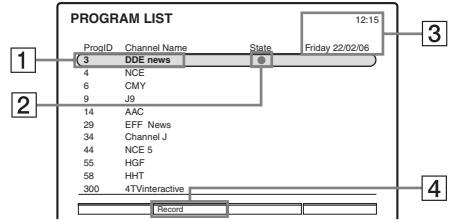

1 Indicates the Programme ID and Channel Name

2 State:

● (green): Indicates the current viewed programme.

● (red): Indicates that the programme is currently being recorded or that a timer recording has been set.

○ (white): Indicates that the programme has been paused.

3 Indicates the current time and date.

4 Allows you to set a timer recording for the selected channel (page 26).

The recording option is not available when you select a channel broadcasting only a digital text service.

2 Press the **↑/↓** buttons to move to other channels.

3 Once highlighted, press the **ENTER** button to exit the information display and view the selected programme.

2. Pausing a TV Broadcast (TV Pause)

When the recorder is switched on, it automatically stores in a buffer memory the last 30 minutes of the channel it has been tuned to.

You can pause a current TV broadcast, and then continue watching the programme at a later time. This is useful when you receive an unexpected phone call or visitor while watching TV.

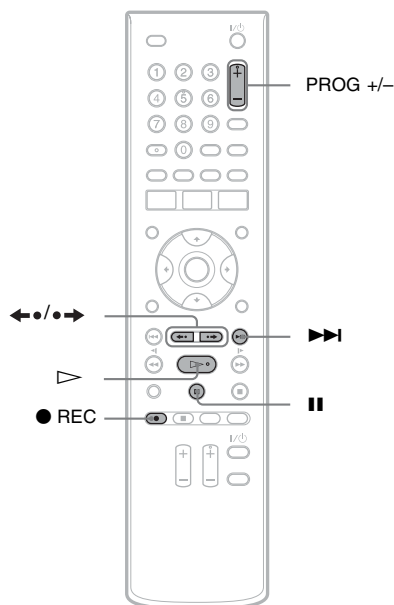

1 While viewing a TV broadcast with this recorder, press **||**.

The picture pauses. You can pause the picture for up to 30 minutes.



TV pause

2 Press **▷** to resume watching the programme from the point at which you pressed **||**.

To fast rewind or fast forward TV pause

Press **◀••/••▶** while a broadcast is paused or after you resumed playback. Pressing this buttons repeatedly doubles the fast rewind and fast forward speed as indicated on screen (up to x64 max).

To skip directly to live TV

Press **▶▶** while a broadcast is paused or after you resumed playback to skip directly to live TV.

To record paused broadcasts

Paused broadcasts are not saved to the HDD. To record the paused programme, press **● REC** while in TV pause mode, see “3. Recording a Programme (One Touch Recording)” on page 16.

⚡ Notes

- This function may be cancelled when:
 - PROG +/- is pressed.
 - TITLE LIST is pressed.
 - GUIDE (Electronic Programme Guide) is pressed.
 - the recorder is turned off.
 - a timer recording is started.

3. Recording a Programme (One Touch Recording)

This section introduces the basic operation to record the current TV programme to the hard disk (HDD). For an explanation of how to make timer recordings, see page 26.

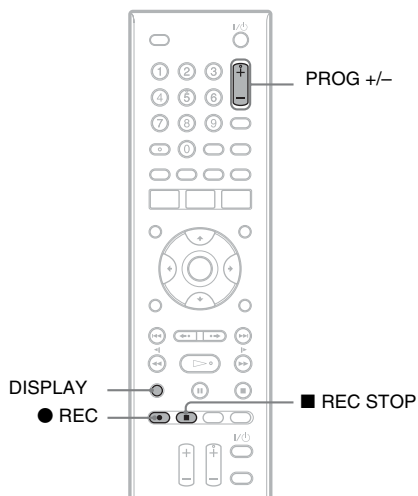

1 Press PROG +/- to select the programme position you want to record.

2 Press ● REC.

Recording starts.

Recording stops automatically when the recorded programme ends or when the HDD is full.

To stop recording

Press ■ REC STOP.

Note that it may take a few seconds for the recorder to stop recording.

To watch another TV programme while recording

Press PROG +/- to move to another channel.

To playback a previous recorded title while recording

While recording, you can simultaneously play another title already registered on your hard disk, see “4. Playing the Recorded Programme (Title List)” on page 17.

To record two programmes at the same time

Once you have set a recording, select another channel and follow Step 1 above to simultaneously record a second programme.

💡 Hint

- If you do not want to watch TV while recording, you can turn off the TV.
- If you have set two simultaneous recordings, you can either watch one of these channels or playback a previous recording from the Title List.

🔔 Notes

- One Touch Recording is not possible if no TV Guide information is available for the particular programme. In this case you can record the programme by setting the timer manually, see page 26.
- One Touch Recording is not possible if the programme overlaps with two other timer settings.
- After pressing ● REC, it may take a short while to start recording.
- If you press ■ REC STOP while two recordings are running, you will have to select which recording to stop in the TIMER LIST setup menu.
- If there is a power failure, the programme you are recording may be erased.

Checking the hard disk status

You can check the remaining hard disk space available for recording.

Press DISPLAY.

The HDD Usage information box showing the used and reserved space for scheduled recording/total hard disk capacity appears on top of the live TV picture displayed in the background.

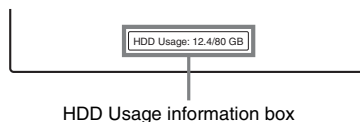

The information box disappears automatically after a few seconds.

🔔 Note

The HDD Usage information does not appear when a Playback or TV Pause progress bar is displayed.

4. Playing the Recorded Programme (Title List)

To play a recorded title, select the title from the Title List.

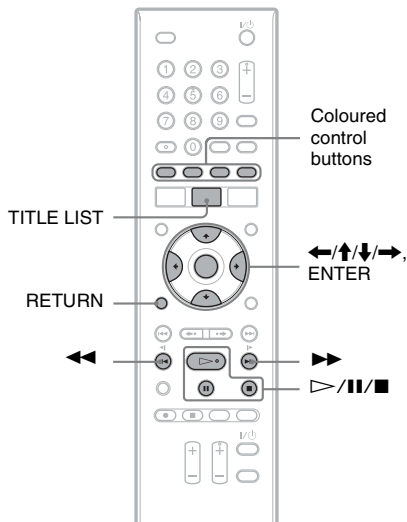

1 Press TITLE LIST.

The Title List display appears showing the recordings stored on your Hard Disk recorder, with the most recent recording appearing first. Example of Title List:

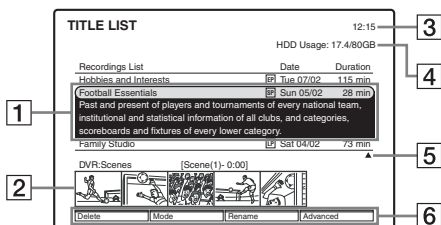

1 Title information:

Displays the title name, recording mode, recording date, recording duration and a detailed description of the recorded programme.

2 Scenes:

When recordings are stored to the hard disk, thumbnail pictures are automatically generated at 5 minute intervals throughout the programme and displayed in the Title List display for enhanced navigation. Each snapshot displayed represents the beginning of a 5 minute scene.

3 Indicates the current time

4 Hard Disk usage

Indicates the used and reserved space for scheduled recording/total hard disk capacity.

5 Scroll indicator:

Appears when all of the titles do not fit on the list. To view the hidden titles, press **↑/↓**.

6 Erasing and editing options:

For details, see “Erasing and Editing” on page 36.

2 Select a title using the **↑/↓** buttons and press **ENTER**.

Playback starts from the selected title.

To stop playback

Press **■ STOP**.

To start playback from a specific scene

1 After Step 1 above, select a title.

2 Once highlighted, press **←/→** to select the desired scene.

The selected scene is identified by a white frame around the thumbnail picture, and the scene number and duration into each programme are indicated.

3 Press **ENTER** to start playback from the selected scene.

To delete scenes

For more accurate navigation, you can delete the scenes snapshots from the Title List display. Deleting scene does not delete any part of the programme, only the thumbnail pictures will be deleted.

1 After Step 2 above, press Red on your remote control. The “Delete” options menu appears.

2 Press **YELLOW** to delete the selected scene.

To add new scenes

You can add new scenes during the playback of a recording to create further indexing for more accurate navigation.

- 1 Press **TITLE LIST** in stop mode.
- 2 Select a title to which you want to add a new scene thumbnail picture, and press **ENTER**. Playback starts.
- 3 While watching the playback picture, press **▷**, **II**, or **◀◀/▶▶** to select the picture you want to set for a scene thumbnail picture, and press **ENTER**.
The “Add scene or mark” sub menu appears asking for confirmation.
- 4 Press **GREEN** “Scene” to confirm.
The new scene will be displayed the next time you enter the Title List menu.

To turn off the Title List

Press **TITLE LIST** or **RETURN**.

Hints

You can select “TITLE LIST” from the System Menu.

Notes

- The title name and programme description may not appear if no TV Guide information was available for the particular recording.
- After recording, the first picture of the recording is automatically set as the first scene thumbnail picture.
- It may take a few seconds for the thumbnail pictures to be displayed.
- The maximum number of scenes automatically generated within a single recording (title) cannot exceed 44 thumbnail pictures.
- The maximum number of scenes to be manually created within a single recording (title) cannot exceed 60 thumbnail pictures.
- If a single recording (title) exceeds 220 minutes, the scenes duration may vary according to the total recording duration.

To change the title name (Rename)

You can label a title by entering up to 101 characters.

The steps below explain how to change the name of the recorded programme.

- 1 While the Title List menu is turned on, select a title for which you want to change the name.

- 2 Press **YELLOW** “Rename”.
The “Rename Recording” menu appears.

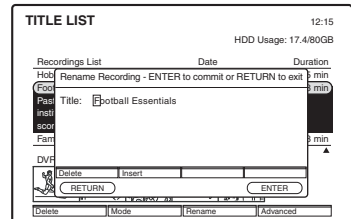

- 3 Press **←/→** to move the cursor to the left or right of the title.
- 4 Press **RED** to delete characters.
- 5 Press **GREEN** to insert a character or to extend the title name.
To insert a character, move the cursor to the right of the point where you want to insert the character and press **GREEN**.
- 6 Press **↑/↓** to select the characters.
The characters changes as follows:
9 ↔ ... ↔ 0 ↔ z ↔ ... ↔ a ↔
Z ↔ ... ↔ A ↔ ! ↔ ? ↔ ; ↔ : ↔
, ↔ . ↔ (blank space) ↔ 9.
- 7 Repeat steps 3 to 6 to enter the remaining characters, then finally press **ENTER** to confirm.

To change the title order (Order)

This option allows you to change the title order in the Title List menu.

- 1 While the Title List menu is turned on, press **BLUE**.
The “Advanced” menu appears.
- 2 Press **↑/↓** to select the title you want to move, and press **YELLOW**.
The title name and description characters changes into red, indicating the title is ready to be swapped.
- 3 Press **↑/↓** to select a new location within the Title List.
- 4 Press **YELLOW** to move the title to it’s new position.

Displaying the Playing Time and Play Information

You can view the playing time and title information of the current playback on the TV screen.

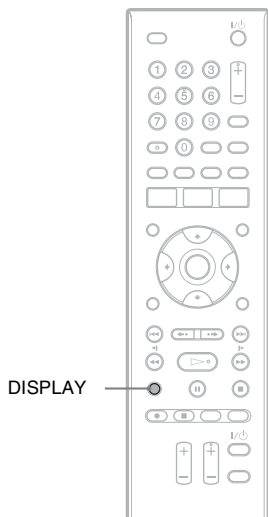

Press DISPLAY during playback.

The play time and title timeline appears on top of the background pictures:

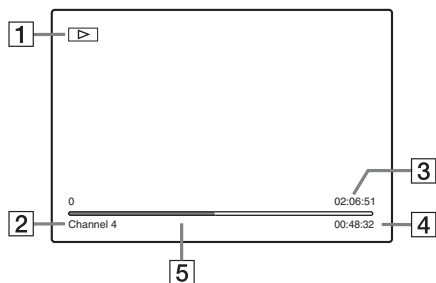

- 1 Play mode
- 2 Title name
- 3 Total duration of the title
- 4 Playing time
- 5 Playing status bar

Guide to Digital Services

Important Notice

- Digital Services availability depends on the broadcaster.
- Digital Services are not instantly available when the recorder is first turned on.
- Your Hard Disk Recorder needs to be in standby every night for the latest TV listings to be downloaded. If the recorder is disconnected from the mains over night, TV listings will not be updated.
- Channel “4TVInteractive” must appear in your channel line-up in order for you to receive weekly TV listings.

TV GUIDE (Electronic Programme Guide)

The TV GUIDE provides a quick and easy way to:

- View the latest TV listings for all your preferred digital channels.

For further explanation on how to select your preferred channels, see “Favourites” on page 21.

- Set a programme to be recorded (page 28).
- Set a TV programme reminder (page 24).

Viewing the TV listing (GUIDE)

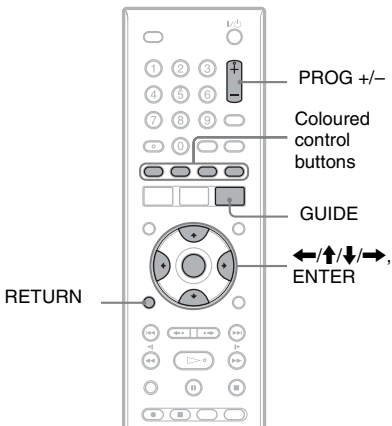

1 Press the **GUIDE** button to display the TV listing (Electronic Programme Guide).

This displays your custom list of channels and shows programme information.

Example of TV Guide (GUIDE) display:

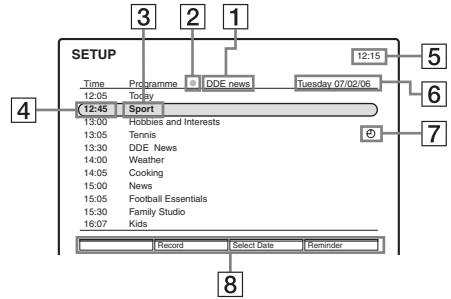

- 1 Channel name
- 2 ● (green): indicates the current viewed channel.
- 3 Programme title
- 4 Indicates the programme broadcast start time
- 5 Indicates the current time
- 6 Indicates the date corresponding to the displayed TV programme
- 7 ⌚ Indicates if a TV programme reminder is associated with the event (page 24)
- 8 Coloured Control buttons for enhanced navigation, recording options and TV programme reminder setting.

2 Press the **↑/↓** buttons to view the listing of programme broadcast schedule on the current channel.

3 Press the **←/→** buttons to view the TV programme listing on other channels.

4 Press the **YELLOW** button to view the next or previous days programme schedule.

Once the “Set EPG Date” menu displayed, press **←/→** to select the date, then press **ENTER** to view the corresponding programme broadcast schedule.

- 5** Select the current time broadcasted programme you wish to view, then press the ENTER button to exit the TV GUIDE display and view the programme.

To set a timer recording

See “Recording TV programmes using the TV Guide application” on page 28.

To set a programme reminder

See “Setting TV programme reminders” on page 24.

Displaying the programme information box

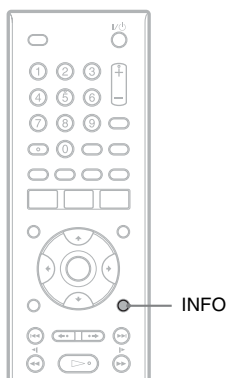

While watching a TV channel, press the INFO button to display the programme information box.

The Information box appears on top of live TV showing the current programme ID and channel name.

Programme information box

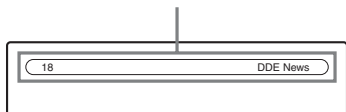

The information box disappears automatically after a few seconds.

Favourites

The Favourite application gives you the option to:

- Select and store your preferred channels to be displayed in the GUIDE (Electronic Programme Guide) TV listing.
- Add or delete channels to the Favourite List.
- Quickly display a favourite channel on screen and avoid browsing channels that you don't wish to view.

Setting a Favourite List

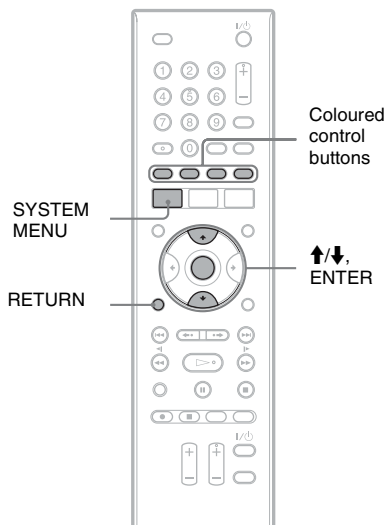

- 1 Press SYSTEM MENU.**
The System Menu Display appears.
- 2 Select “SETUP,” and press ENTER.**
The Setup Display appears.
- 3 Select “DTV Settings,” and press ENTER.**

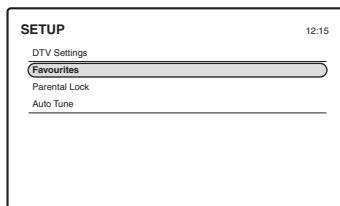

4 Select "Favourites," and press ENTER

The DTV Settings- Favourites setup display appears.

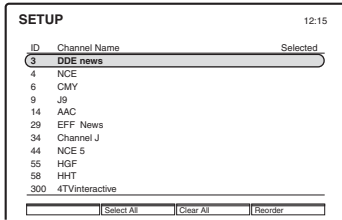

This display shows all the TV or Radio channels available to you.

5 Press the \uparrow/\downarrow buttons to highlight a channel you want to add as a favourite, then press the ENTER button.

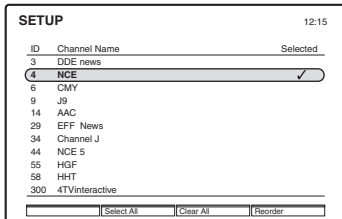

A tick ✓ icon appears next to the channel name indicating it has been selected as a favourite.

- To clear the tick, press ENTER again.
- To "Select All" channels at once, press GREEN.
- To "Clear All" (clear all ticks) at once, press YELLOW.

6 When you have stored all your favourite channels, press the RETURN button repeatedly to come back to normal operation.

Ordering your favourite channels

This option allows to change the channel order so that your preferred channels appear first in the Favourite List or when you move through the channels in the TV listing GUIDE (Electronic Programme Guide).

- 1 While the DTV Settings- Favourites setup display is turned on, press \uparrow/\downarrow to select the channel you want to move.
- 2 Press BLUE to "Reorder".
The characters of the programme ID and channel name lights up in green, indicating the channel is ready to be swapped.
- 3 Press \uparrow/\downarrow to select a new location within the list.
- 4 Press BLUE to move the channel to its new position.

Watching or listening to a favourite channel

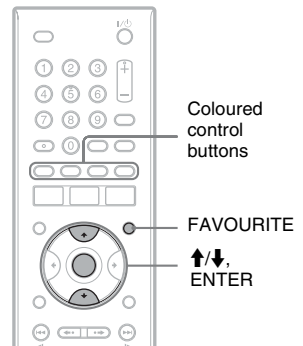

- 1 While in normal operation mode, press the FAVOURITE button on the remote control. The Favourite List display appears.

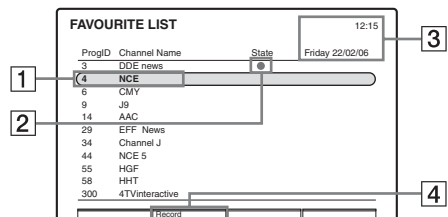

- 1 Indicates the Programme ID and Channel Name
 - 2 State:
 - (green): Indicates the current viewed programme.
 - (red): Indicates that the programme is currently being recorded or that a timer recording has been set.
 - (white): Indicates that the programme has been paused.
 - 3 Indicates the current time and date.
 - 4 Allows you to set a timer recording for the selected channel.
The recording option is not available when you select a channel broadcasting only a digital text service.
- 2 Press the \uparrow/\downarrow button to highlight the channel you wish to view, then press ENTER to view the programme.**

Viewing a digital text service

Many digital TV channels broadcast information via their text service. This digital service includes high quality digital text and graphics along with advanced navigation options. Additionally, this recorder has access to dedicated text channels transmitted by the broadcasters.

Before starting, make sure that “Interactivity” is set to “On” in “Recording/Hard Disk Recorder and Remote Control Settings/Factory Settings (Features)”, on page 44.

Note

- The appearance, content and navigation methods of all digital text services are decided by the broadcaster.
- Digital text services cannot be recorded on this recorder.

Selecting digital text from dedicated digital teletext channels

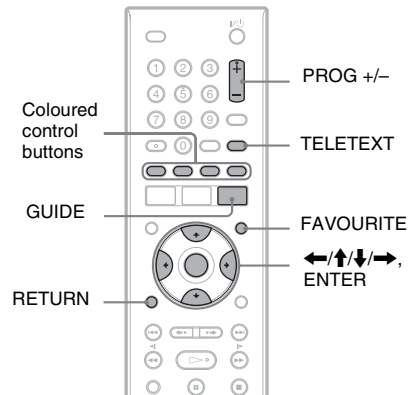

1 Select a dedicated channel that is broadcasting digital text.

If you do not know the number of a dedicated digital text channel, you can use the ‘Electronic Programme Guide’ by pressing the GUIDE button to find one (page 20).

- 2 Once the text page is displayed (this may take some time), follow the on-screen instructions to obtain your required selection.

On some pages the TV programme may also be displayed on the text screen. On-screen instructions will inform you how to change the displayed programme.

- 3 If you are instructed to press 'OK' or 'Select' when viewing the text pages, press the ENTER button.
- 4 When you have finished viewing the text service, follow the on screen instructions, or press the PROG +/- button to exit.

Selecting digital text from other channels

Digital text services may also be available on other digital channels. This is sometimes indicated by a small symbol on your TV screen, superimposed on the programme you are watching.

- 1 Select a channel.
- 2 Press the TELETEXT (Text) button, RED button or the button indicated on screen by the broadcaster.
- 3 Once the text information is displayed, you can access required information by using the ←/↑/↓/→ buttons, the coloured control buttons and/or the numbered buttons on the remote control.
If you are instructed to press 'OK' or 'Select' when viewing the text pages, press the ENTER button on your remote control.
- 4 When you have finished viewing the text service displays, follow the on screen instructions, or press the PROG +/- button to exit.

Setting TV programme reminders

You can set TV reminders so you don't miss your preferred TV programmes.

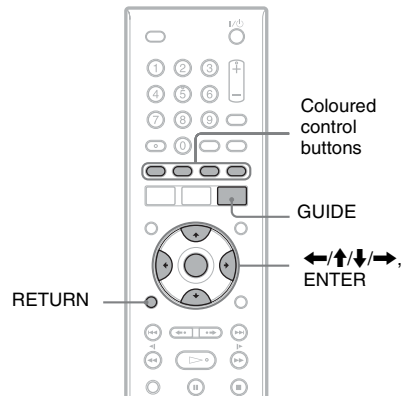

- 1 Press the GUIDE button to display the TV Guide showing today's programmes.
- 2 Press the ←/↑/↓/→ buttons to highlight the programme for which you wish to set a reminder, then press BLUE.

The "Programme Reminder" pop-up screen appears.

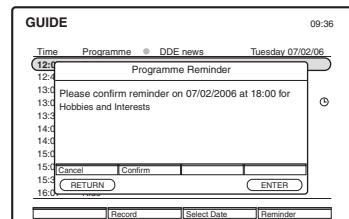

- 3 Press GREEN to confirm.
A programme reminder icon (🕒) appears in the TV Guide display and a pop-up box will appear with the TV reminder asking you to change channels just before the programme is scheduled to start

To delete a programme reminder

- 1 Select the programme having an associated programme reminder in the TV Guide display, then press BLUE.

- 2 Once the “Programme Reminder” pop-up screen appears, press YELLOW to delete the programme reminder.

Before Recording

Before you start recording...

- Check that the HDD has enough available space for the recording (page 16). You can free up disk space by erasing titles (page 37).
- Adjust the recording picture quality if necessary (page 27).

Hint

Timer recordings will be made regardless whether or not the recorder is turned on. You can turn off the recorder without affecting the recording even after recording starts.

Notes

- Any recordings made with “Record subtitles” set to “On” cannot be compressed, see page 43.
- Recordings made with “Record subtitles” set to “On” will take more disk space than those made without, see page 43.
- Digital text services cannot be recorded on this recorder.

Timer Recording (Standard/TV Guide)

There are two methods to set the timer: Standard method and TV Guide method.

- **Standard:** Set the date, time, and programme position of the programme manually. Using this method, you can set the timer up to one month in advance.
- **TV Guide:** Set a programme to be recorded based on the information provided by the TV Listings GUIDE (Electronic Programme Guide) (page 20).

Setting the timer manually (Standard)

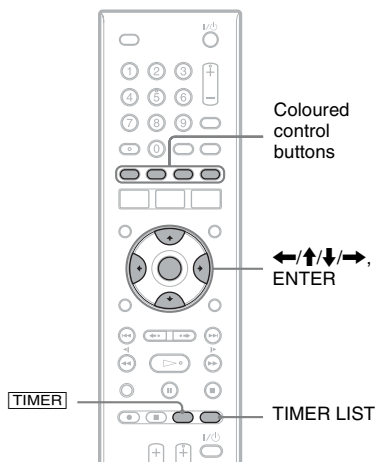

1 Press **TIMER**.

The New Timer setting display appears.

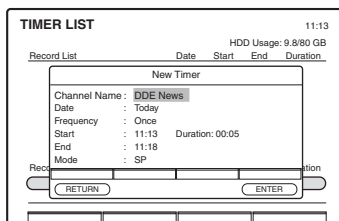

2 Select an item using \uparrow/\downarrow and adjust using \leftarrow/\rightarrow and the coloured control buttons displayed on you remote control.

“Channel Name”: Sets the Channel Name

“Date”: Sets the date.

The item changes as follows:

Today \leftrightarrow Tomorrow \leftrightarrow \leftrightarrow Thu

28.10 (1 month later) \leftrightarrow Today.

“Frequency”: Sets the recording frequency.

The item changes as follows:

Once \leftrightarrow Daily \leftrightarrow Weekly \leftrightarrow Once

“Start”: Sets the start time.

Press the coloured buttons on you remote control to set the desired start time.

“End”: Sets the stop time.

Press the coloured buttons on you remote control to set the desired stop time.

“Mode”: Selects the recording mode.

The item changes as follows:

SP \leftrightarrow LP \leftrightarrow EP

Select a recording mode according to the time and picture quality you need. For example:

- If picture quality is your priority, select the Standard Play mode (SP).
- If recording time is your priority, Long Play mode (LP) or Extended Play mode (EP) can be a possible choice.

Please note that the recording compression process is not instantly performed at the time of the recording. The compression process takes approximately 4 hours for each hour of programming when the hard disk recorder is in standby mode.

3 Press ENTER to confirm your settings.

The Timer List (page 29) appears showing the settings to be added to the Timer List.

4 Press GREEN to confirm

The selected manual timer moves into the Record List and the TIMER indicator (page 51) lights up on the front panel indicating that the recorder is ready to start recording.

To confirm, change, or cancel timer recording

See “Checking/Changing/Cancelling Timer Settings (Timer List)” on page 29.

To stop recording during timer recording

- 1 Press TIMER LIST on your remote. The TIMER LIST display appears.
- 2 Press \uparrow/\downarrow to highlight the programme being recorded you want to stop.
- 3 Press GREEN to stop recording.

To simultaneously record two programmes within the same time range

Once you have set a recording, proceed as of Step 1 of “Setting the timer manually (Standard)” on page 26 to simultaneously record a second programme.

If the timer settings overlap

Only two programmes can be recorded simultaneously.

Overlapped timer settings are highlighted in the TIMER LIST display as follows.

TIMER LIST		11:23			
		HDD Usage: 26.9/80 GB			
Record List	Date	Start	End		
DDE news	Wed 08/02	11:20	13:25		
NCE	Mon 13/02	10:17	12:22		
CMY	Mon 13/02	11:39	14:20		
		12:25	125 min		
		14:20	161 min		
Add Timer Freq Mode Start End Duration					
DDE News	Once	SP	11:23	12:28	65 min
This programme overlaps another programme					
					Clear

To add the New Timer as shown in the TIMER LIST, you will have first to change or cancel a previous timer recording that has been set within the same time range, see “Checking/Changing/Cancelling Timer Settings (Timer List)” on page 29.

To clear the New Timer that overlaps, press the Blue button on your remote control.

If insufficient disk space for the recording

You can free up disk space by erasing titles (page 37).

💡 Hint

You can play the recorded programme by selecting the programme title in the Title List.

⚡ Notes

- Before you start recording, check that the HDD has enough available space for the recording (page 16).
- Even if the timer is set for the same daily or weekly programme, the timer recording cannot be confirmed if it overlaps with two other timer recordings scheduled at the same time.

Recording TV programmes using the TV Guide application

The TV Guide (Electronic Programme Guide) application is a feature that simplifies setting the timer. Just select the programme you wish to record in the TV Guide display. The date, time, and channel of that programme are set automatically.

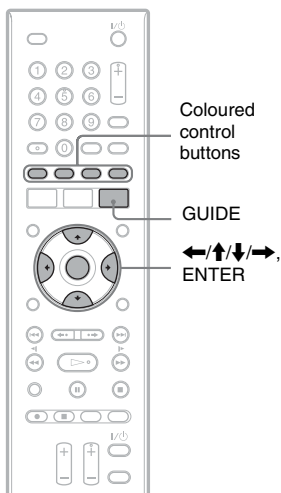

- 1 Press the **GUIDE** button on your remote control to display the TV Guide listing.
- 2 Press the **←/↑/↓/→** buttons to move around the listing.

Time	Programme	DDE news	Tuesday 07/02/06
12:05	Today		
12:45	Sport		
13:00	Hobbies and Interests		
13:05	Tennis		
13:30	DDE News		
14:00	Weather		
14:05	Cooking		
15:00	News		
15:05	Football Essentials		
15:30	Family Studio		
16:07	Kids		

To know more about the navigation options in the TV Guide application, see page 20.

- 3 Select a current time TV/radio broadcast or a future programme you wish to record. Once highlighted, press the **GREEN** button.

The Timer List appears showing the timer settings corresponding to the programme you have chosen.

TIMER LIST		12:15			
Record List	Date	Start	End	Duration	HDD Usage: 26.9/80 GB
DDE news	Wed 08/02	11:20	13:25	125 min	
NCE	Mon 13/02	10:17	12:22	125 min	
CMY	Mon 13/02	11:39	14:20	161 min	

Add Timer	Freq	Mode	Start	End	Duration
The Hits	Weekly	SP	17:23	18:23	60 min

- 4 Press **GREEN** to confirm

The selected timer moves into the Record List and the **TIMER** indicator lights up on the front panel indicating that the recorder is ready to start recording.

In case of a current broadcast timer setting, your recorder will immediately start recording.

To stop recording during timer recording

See page 27.

If the timer settings overlap

See page 27.

To confirm, change, or cancel timer recording

See “Checking/Changing/Cancelling Timer Settings (Timer List)” (page 29).

If insufficient disk space for the recording

You can free up disk space by erasing titles (page 37).

To simultaneously record two programmes within the same time range

Once you have set a recording, follow Step 1 above.

Notes

- The TV Guide programme start and end time are determined by the broadcaster. It is advisable to slightly increase the duration of the recording to allow for minor changes to the schedule.
- If the time of the broadcast changes, the recorder will still record at the time and day originally specified. It cannot automatically adjust the recording to the new programme time.

Checking/Changing/ Cancelling Timer Settings (Timer List)

You can check, change, or cancel timer settings using the Timer List.

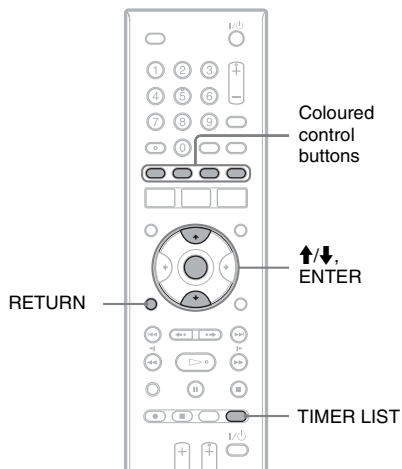

- 1 Press **TIMER LIST** on your remote control. The Timer List appears.

TIMER LIST		12:15		
		HDD Usage: 26.9/80 GB		
Record List	Date	Start	End	Duration
DDE news	Wed 08/02	11:20	13:25	125 min
NCE	Mon 13/02	10:17	12:22	125 min
CMY	Mon 13/02	11:39	14:20	161 min

Add Timer	Freq	Mode	Start	End	Duration
Add		Edit		Clear	

Timer information displays the channel name, recording frequency, recording mode, date, time, etc.

[D]: Indicates that the timer is set for daily recording.

[W]: Indicates that the timer is set for weekly recording.

[SP], **[LP]**, **[EP]**: Indicates the recording mode (page 27).

● (red): Indicates the setting currently being recorded.

- 2 Press **↑/↓** to highlight the timer setting you want to cancel/check/change.

TIMER LIST		12:15		
		HDD Usage: 26.9/80 GB		
Record List	Date	Start	End	Duration
DDE news	Wed 08/02	11:20	13:25	125 min
NCE	Mon 13/02	10:17	12:22	125 min
CMY	Mon 13/02	11:39	14:20	161 min

Add Timer	Freq	Mode	Start	End	Duration
Delete		Show Info		Edit	

- 3 Press the **RED** button on your remote control to delete the timer.
- 4 Press **YELLOW** to display the programme information.

The programme description may not appear if no TV Guide information was available for the particular timer setting.

- 5 Press **BLUE** to edit the timer, then press **YELLOW** and change the settings in the "New Timer" setting display.

See page 27 for detailed timer setting information.

- 6 Press **ENTER** to confirm your new settings.

The Timer List appears showing the new settings to be added to the Timer List.

- 7 Press **GREEN** to confirm

The selected manual timer setting moves into the Record List and the **TIMER** indicator lights up on the front panel indicating that the recorder is ready to start recording.

When the timer settings overlap

See page 27.

When there is not enough available disk space for the recording

You can free up disk space by erasing titles (page 37).

To turn off the Timer List

Press **TIMER LIST** or **RETURN**.

💡 Hint

If you have scheduled two recordings at the same time, you can either watch one of these channels or playback a previous recording from the Title List.

Notes

- While recording, you cannot modify the timer setting for the current recording.
- Even if the timer is set for the same daily or weekly programme, the timer recording cannot be confirmed if it overlaps with two other timer recordings scheduled at the same time.
- Deleting any occurrence of a repeat recording from the Timer List will cancel any future repeat recordings for that programme.

Playing

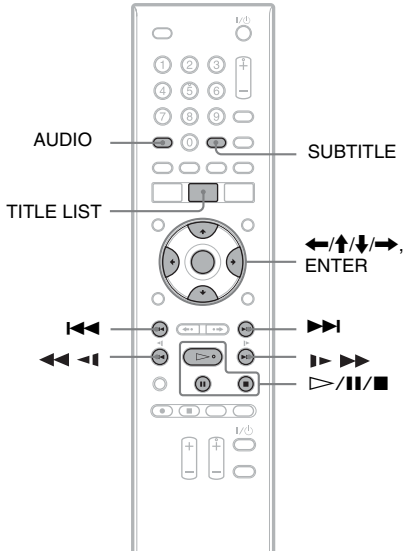

To stop playback

Press ■.

To start playback from a specific scene

- 1 After Step 1 above, select a title.
- 2 Once highlighted, press ◀/▶ to select the desired scene.
The selected scene is identified by a white frame around the thumbnail picture, and the scene number and duration into each programme are indicated.
- 3 Press ENTER to start playback from the selected scene.

1 Turn on the recorder and switch the input selector on your TV so that the signal from the recorder appears on your TV screen.

2 Press TITLE LIST.

For details about the Title List, see “4. Playing the Recorded Programme (Title List)” on page 17.
Example:

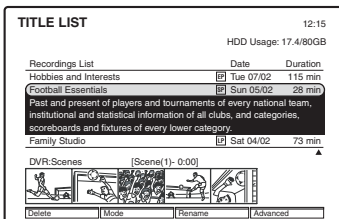

3 Select a title using the ↑/↓ buttons and press ENTER.

Playback starts from the selected title.

Playback options

To check the position of the buttons below, see the illustration on page 31.

Buttons	Operations																
AUDIO The AUDIO button has a tactile dot*.	Select your preferred audio language provided that optional languages were broadcasted at the time of the recording, see “Audio Language” on page 43.																
SUBTITLE	Displays the subtitles, provided that the subtitle recording option has been enabled and that subtitles were broadcasted at the time of the recording, see “Record Subtitles” on page 43 and “Subtitle Language” on page 44.																
◀◀ (previous)/ ▶▶ (next)	Goes to the beginning of the previous / next scene (page 17).																
◀◀◀◀/▶▶▶▶ (fast reverse/fast forward)	Fast reverses/fast forwards the HDD when pressed during playback. Search speed changes as follows: <div style="text-align: center; margin: 10px 0;"> <table style="margin: auto;"> <tr> <td style="text-align: center;">fast reverse</td> <td style="text-align: center;">fast forward</td> </tr> <tr> <td style="text-align: center;">◀◀◀◀</td> <td style="text-align: center;">▶▶▶▶</td> </tr> <tr> <td style="text-align: center;">◀◀◀◀x2</td> <td style="text-align: center;">▶▶▶▶x2</td> </tr> <tr> <td style="text-align: center;">◀◀◀◀x4</td> <td style="text-align: center;">▶▶▶▶x4</td> </tr> <tr> <td style="text-align: center;">◀◀◀◀x8</td> <td style="text-align: center;">▶▶▶▶x8</td> </tr> <tr> <td style="text-align: center;">◀◀◀◀x16</td> <td style="text-align: center;">▶▶▶▶x16</td> </tr> <tr> <td style="text-align: center;">◀◀◀◀x32</td> <td style="text-align: center;">▶▶▶▶x32</td> </tr> <tr> <td style="text-align: center;">◀◀◀◀x64</td> <td style="text-align: center;">▶▶▶▶x64</td> </tr> </table> </div>	fast reverse	fast forward	◀◀◀◀	▶▶▶▶	◀◀◀◀x2	▶▶▶▶x2	◀◀◀◀x4	▶▶▶▶x4	◀◀◀◀x8	▶▶▶▶x8	◀◀◀◀x16	▶▶▶▶x16	◀◀◀◀x32	▶▶▶▶x32	◀◀◀◀x64	▶▶▶▶x64
fast reverse	fast forward																
◀◀◀◀	▶▶▶▶																
◀◀◀◀x2	▶▶▶▶x2																
◀◀◀◀x4	▶▶▶▶x4																
◀◀◀◀x8	▶▶▶▶x8																
◀◀◀◀x16	▶▶▶▶x16																
◀◀◀◀x32	▶▶▶▶x32																
◀◀◀◀x64	▶▶▶▶x64																
◀◀◀◀◀◀/▶▶▶▶▶▶ (slow)	Plays in slow motion when pressed in pause mode. Slow motion speed changes as follows: <div style="text-align: center; margin: 10px 0;"> <table style="margin: auto;"> <tr> <td style="text-align: center;">◀◀◀◀◀◀ ÷4</td> <td style="text-align: center;">▶▶▶▶▶▶ ÷4</td> </tr> <tr> <td style="text-align: center;">◀◀◀◀◀◀ ÷2</td> <td style="text-align: center;">▶▶▶▶▶▶ ÷2</td> </tr> </table> </div>	◀◀◀◀◀◀ ÷4	▶▶▶▶▶▶ ÷4	◀◀◀◀◀◀ ÷2	▶▶▶▶▶▶ ÷2												
◀◀◀◀◀◀ ÷4	▶▶▶▶▶▶ ÷4																
◀◀◀◀◀◀ ÷2	▶▶▶▶▶▶ ÷2																
⏏ (pause)	Pauses playback. Plays one frame at a time when pressed briefly in pause mode.																

To resume normal playback, press ▷.

The ▷ button has a tactile dot*

* Use the tactile dot as a reference when operating the recorder.

Playing a paused TV Broadcast (TV Pause)

You can pause a current TV broadcast, and then continue watching the programme at a later time. See page 15.

Playing from the beginning of the programme you are recording (Chasing Playback)

“Chasing Playback” allows you to view the recorded part of a programme while the recording is being made. You do not need to wait until the recording finishes.

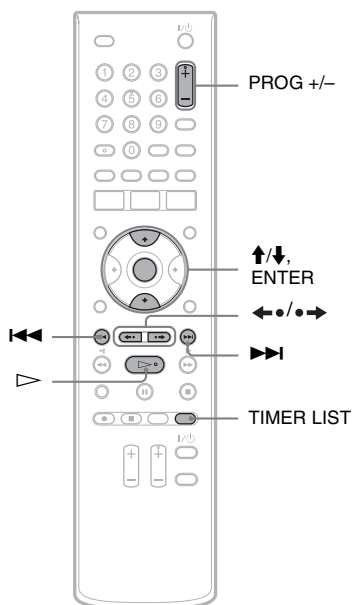

- 1 Press **TIMER LIST** on your remote control. The Timer List appears.
- 2 Press **↑/↓** to highlight a current timer recording in the “Record List”. Programmes currently being recorded are indicated by a ● (red) icon next to the programme name.
- 3 Press **▷ PLAY** to move to the selected channel (live TV).

- 4 Press **◀◀** to skip back to the beginning of the recording.
- 5 Press **◀•/•▶** to fast rewind or fast forward the recording. Pressing this buttons repeatedly doubles the fast rewind and fast forward speed as indicated on screen (up to x64 max).
- 6 Press **▶▶** to skip directly to live TV.

To switch to live TV programmes viewing

Press **PROG +/-**.

⚡ Notes

- The picture on your TV screen holds for a few seconds when you fast forward/fast reverse or instant replay/advance the recording.
- Chasing Playback is possible from one minute or more after recording starts.
- Even if you fast forward the recorded programme, there will always be a time difference of about one minute or more between the recorded programme and the current TV broadcast.

Playing a previous recording while making another (Simultaneous Rec and Play)

“Simultaneous Rec and Play” allows you to view a previously recorded programme while recording programmes. Playback continues even if a timer recording starts.

- 1 While recording, press **TITLE LIST** to display the Recordings List.
- 2 Select the title you want to play, and press **ENTER**. Playback starts from the selected title.

💡 Hint

If you have set two simultaneous recordings, you can either watch one of these channels or playback a previous recording from the Title List.

Playing titles from a programme category folder

You can play titles stored in the Title List programme category folders.

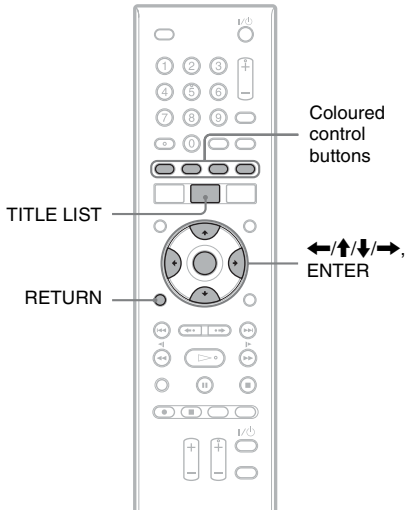

- 1 Press **TITLE LIST**, then press **BLUE** twice. The Title List_Folders menu appears showing the list of pre-defined programme types folders.

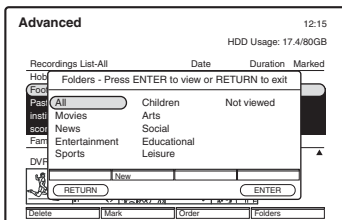

- 2 Press **←/↑/↓/→** to select the category from which you want to play a title, and press **ENTER**. The dedicated Recordings List appears.
- 3 Press **↑/↓** to highlight the desired title, then press **ENTER** to start playback.

Adding new category folders

You can create your own folders containing your selection of recordings.

- 1 After Step 1 above, press **GREEN** to add a new category folder. A new folder appears in the Title List_Folders menu.

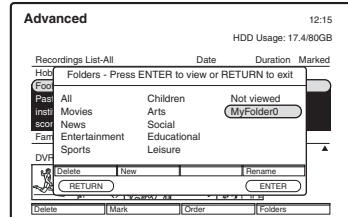

- 2 Press **BLUE** to rename the folder. You can rename the category folder by entering up to 16 characters. See below.
- 3 Press **RETURN** to come back to the Title List_Recording List display.

Changing category folders name (Rename)

- 1 While Title List_Folders menu is displayed, select a folder for which you want to change the name.
- 2 Press **BLUE**. The "Renaming folder" menu appears.

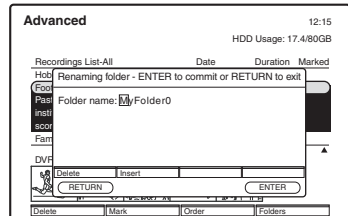

- 3 Press **←/→** to move the cursor to the left or right of the title.
- 4 Press **RED** to delete characters.
- 5 Press **GREEN** to insert a character or to extend the title name.

To insert a character, move the cursor to the right of the point where you want to insert the character and press GREEN.

6 Press **↑/↓** to select the characters.

The characters changes as follows:

9 ↔ ... ↔ 0 ↔ z ↔ ... ↔ a ↔
 Z ↔ ... ↔ A ↔ ! ↔ ? ↔ ; ↔ : ↔
 , ↔ . ↔ (blank space) ↔ 9.

7 Repeat steps 3 to 6 to enter the remaining characters, then finally press **ENTER** to confirm.

Notes

- Pre-defined programme type folders names cannot be renamed.
- You can rename the category folder by entering up to 16 characters.

Moving recordings to a programme category folder

For more accurate navigation, you can move recordings to a category list containing your selection of titles.

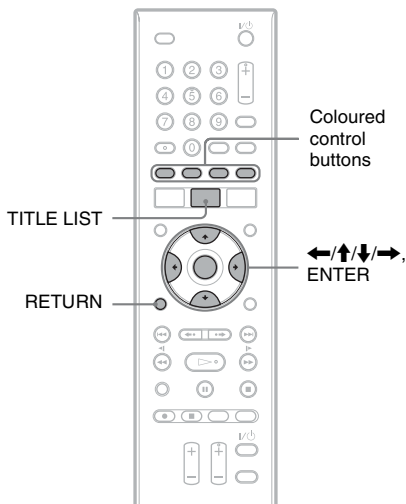

1 Press **TITLE LIST**, then press **BLUE**.

The Title List_Advanced menu appears showing the list of the titles recorded to the HDD.

2 Press **↑/↓** to highlight the title you want to move to a specific category folder.

3 Press **GREEN** to “Mark” the title.

A tick ✓ icon appears next to the selected title indicating that the title is ready to be moved.

- To remove the mark, press GREEN again.

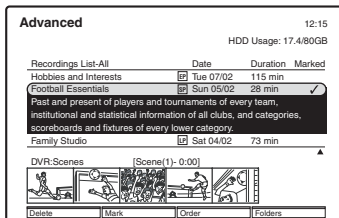

4 Press **BLUE** to display the category folders.

5 Press **←/↑/↓/→** to select the category to which you want to move the title, and press **YELLOW** to “Place” the title.

The dedicated Recordings List appears containing the title you just moved.

6 Press **RETURN** to return to the Title List_Recording List display.

Before Editing

This recorder offers various edit options for the HDD: editing either the original recording (called the “original”), or the playback information created from the original (called a “Playlist”). Since each is different in nature and offers different merits, read the following and select the one that better suits your needs.

Editing original titles

Edits made to the original titles are final. If you plan to retain an unaltered original recording, make a copy of the title or a section of the title, see “Copying Title/Section” on page 38 before editing.

Creating and editing Playlist titles

Set-up a Playlist to play all the recordings in a category folder for editing purposes. When you create a Playlist, the original titles are left unaltered.

Notes

- The Playlist title calls up data from the original titles for playback.
- If a message appears and indicates “Insufficient free space”, erase unnecessary titles.

Erasing and Editing a Title

This section explains the basic edit functions. Note that editing is irreversible. To edit titles without changing the original recordings, make a copy of the title or a section of the title, see page 38.

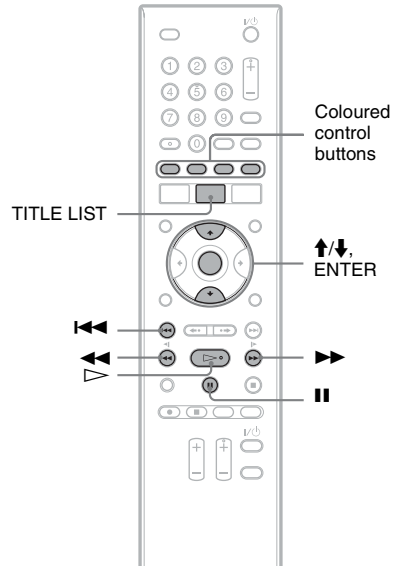

- 1 Press **TITLE LIST**.
- 2 Select a title within the Recordings List using the **↑/↓** buttons.
- 3 Press the **Coloured Button** that corresponds to the desired Erase or Editing option.

You can make the following edits to the title:
 “Delete”(RED): Deletes Titles or Scenes (page 37).

“Mode” (GREEN): Increases the recording capacity by compressing titles recorded to the HDD (page 39).

“Rename” (YELLOW): Changes the name of the title (page 18).

“Advanced” (BLUE): Allows you to:

- change the title order (Order) (page 18).
- create and edit Playlists (page 38).
- make a copy of a title or section of a title (page 38).
- crop a section of a title (page 37).

Erasing a Title/Scene

You can permanently erase recordings stored to the hard disk or the scene thumbnail pictures that are displayed in the Title List display for enhanced navigation.

Note that erasing a title cannot be undone.

- 1 After step 1 above, select a title within the Recordings List using the \uparrow/\downarrow buttons and press RED (Delete).

The “Delete” sub-menu appears with the following options.

“Cancel”(RED): Returns to your Recordings List.

“Recording” (GREEN): Erases the selected title.

“Scene” (YELLOW): Deletes the selected scene thumbnail pictures from the Title List display, see page 17.

- 2 Press the Coloured Button that corresponds to the desired “Delete” option.

Erasing sections of a title (Crop Editing)

You can permanently delete the sections of a title which are before the start and after the end crop marks.

- 1 Press TITLE LIST, then select a title within the “Recordings List” using the \uparrow/\downarrow buttons.

- 2 Press ENTER to start playback.

- 3 While watching the playback picture, press \triangleright , \blacksquare , or $\blacktriangleleft/\blacktriangleright$ to select the point (picture) at which you want to start the crop and press ENTER.

The “Add scene or mark” sub menu appears asking for confirmation.

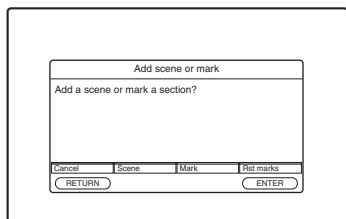

- 4 Press YELLOW “Mark” to confirm the start marker.

A time line appears with a marker showing the start position of the crop.

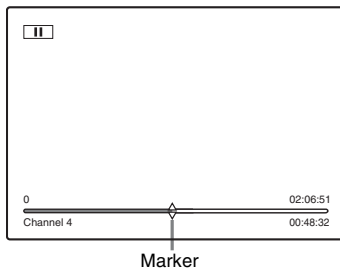

- 5 Press \triangleright , \blacksquare , or $\blacktriangleleft/\blacktriangleright$ to select the point (picture) at which you want to end the crop, then press ENTER.

The display asks for confirmation.

- To reset either the start and end point, press BLUE “Rst marks,” and go to step 2.

- 6 Press YELLOW “Mark” to confirm the end marker.

- 7 Press ENTER

The “Edit” sub menu appears.

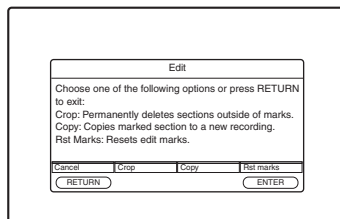

- 8 Press GREEN to crop the title.

The cropped title will be displayed when you next enter the Title List menu.

Hint

To return to the beginning of the title, press \blacksquare and then press \blacktriangleleft repeatedly.

Copying Title/Section

You can copy a title or a section of a title for further editing or playlist creation.

1 Proceed as from Step 1 to Step 7 of “Erasing sections of a title (Crop Editing)” above, to set the start and end marks of the whole title or the section you want to copy.

2 Once the “Edit” sub menu appears, press **YELLOW** to “Copy” the marked section to a new title.

Copying starts.

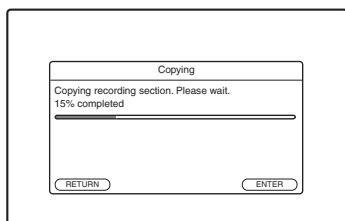

Note that the copying process takes a while depending on the section duration. The copied title will be displayed the next time you enter the Title List menu.

💡 Hints

- You can rename the new created title. See page 18.
- You can add new thumbnail pictures. See page 18.

Creating and Editing a Playlist

Playlist setup allows you to play all the titles from a category folder once, or repeatedly play all the recordings in a folder one after the other until manually stopped.

🔔 Note

Creating and editing a playlist does not delete any of the titles from the TITLE LIST folders.

1 Press **TITLE LIST**, then press **BLUE** twice.

The Title List_Folders menu appears showing the list of the programmes types folders.

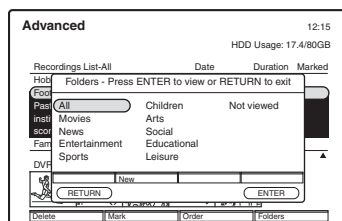

2 Press **←/↑/↓/→** to select the folder from which you want to set a playlist, and press **ENTER**.

The dedicated Recordings List appears.

3 Press **↑/↓** to highlight a title, then press **ENTER** to select the playback option.

The “Play” sub-menu appears with the following options:

“Cancel”(RED): Returns to your folder list.

“Play one” (GREEN): Plays only the highlighted title.

“Play all”(YELLOW): Plays all the titles displayed in the folder.

“Repeat all”(BLUE): Plays repeatedly all the titles displayed in the folder until **■ STOP** is pressed.

4 Press the Coloured Button that corresponds to the desired “Play” option.

The title starts to play.

To stop playback, press **■ STOP**.

Increasing recording capacity

Before you start recording a broadcast or editing a title, check the remaining/total disk space using the HDD Usage information display. See page 16.

To free up disk space you can either delete titles, (see “Erasing a Title/Scene” on page 37) or compress titles to maximise storage space.

This recorder allows you to increase the capacity of the hard disk by selecting the recording mode at the time you set a timer recording. See “Timer Recording (Standard/TV Guide)” on page 26 to chose the compression mode according to the required time, disk space and picture quality.

This section explains how to compress titles once the recording has been made.

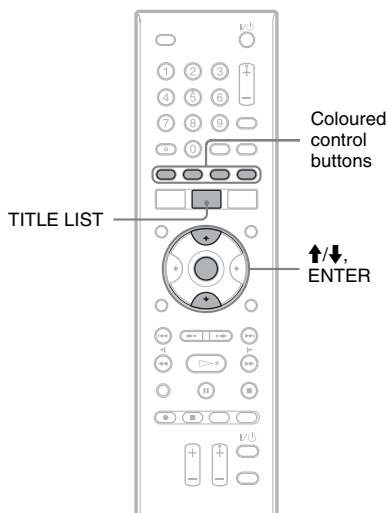

- 1** Press **TITLE LIST**.
- 2** Select a title within the Recordings List using the **↑/↓** buttons.

- 3** Press **GREEN “Mode”** repeatedly to set the **compression mode**.

Each time you press GREEN, the item changes as follows:

SP ↔ LP ↔ EP ↔ SP

Select a compression mode according to the time and picture quality you need (page 27).

You can change the compression mode either from SP → LP, SP → EP or LP → EP.

- 4** Press **ENTER** to confirm the **compression mode**.

The compression process takes approximately 4 hours for each hour of programming when the hard disk recorder is in standby mode.

Notes

- When compressing a previously recorded title, additional disk space is required to perform the operation. It may be necessary to delete existing recordings stored in the TITLE LIST to allow for the compression to take place.
- The quality of the recording will decrease after the programme has been compressed.
- Audio programming (e.g. radio stations) can not be compressed.
- Any recordings made with “Record subtitles” set to “On” cannot be compressed. See page 43.
- Recordings made with “Record subtitles” set to “On” will take more disk space than those made without. See page 43.

Digital TV settings (DTV Settings)

The DTV Settings Setup enables you to take full advantage of Digital TV Broadcasting services, such as favourites channels setting, or to prevent children's viewing unsuitable channels and programmes.

- 1** Press **SYSTEM MENU** while the recorder is in stop mode.
- 2** Select **"SETUP,"** and press **ENTER.**
- 3** Select **"DTV Settings,"** and press **ENTER.**
The DTV Settings Setup Display appears with the following options.

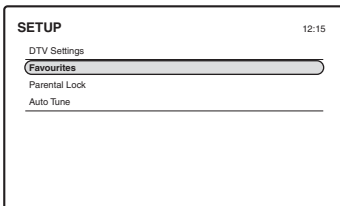

Favourites

The Favourites Display allows you to store and organize your favourite channels. Please refer to page 21 for detailed Favourites channel settings.

Parental Lock

The Parental Lock Menu enables you to lock all available channels for a specified time period (e.g. from 9PM until 6AM).

- 1** After step 3 above, select **"Parental Lock,"** and press **ENTER.**
The display for entering the Personal Identification Number (PIN) appears.

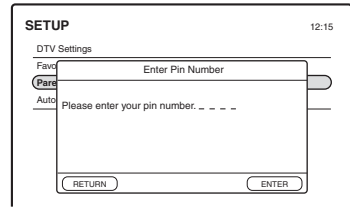

- 2** Enter your four-digit password using the number buttons and press **ENTER.**
The default PIN number for this recorder is 1111. You should change the default PIN to an easily memorised 4 digit number of your choice before setting the Child Lock.
 - The Parental Lock menu appears

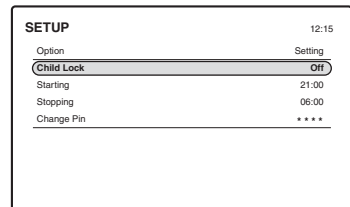

◆ To change the password (Change Pin)

- 1** After Step 2 above, select **"Change Pin,"** using the **↑/↓** buttons and press **ENTER.**
- 2** Once the Pin Number Change display appears, enter the new PIN and press **ENTER.** Then re-enter the new PIN again and press **ENTER** to confirm.
- 3** Press the **RETURN** button to return to the Parental Lock menu.

⚡ Note

If you forget your password, you will have to reset it by entering the following PIN: 2580.

◆ To lock channels (Child Lock)

- 1** Once the Parental Lock menu displayed, press the **↑/↓** buttons to highlight **"Child Lock."**
- 2** Press the **←/→** buttons to select **"On."**

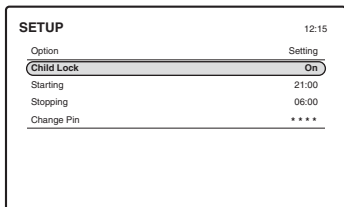

3 Press the RETURN button to return to the Parental Lock menu.

◆ **To unlock channels (release Child Lock)**

1 In Step 2 above, press the ◀/▶ buttons to select “Off.”

2 Press the RETURN button to come back to the Parental Lock menu.

◆ **To set the Child Lock time period**

1 Once the Parental Lock menu displayed, select “Starting.”

2 Press the ◀/▶ buttons to set the desired starting time.

Each press reduces or advances the time in increments of 15 minutes.

3 Select “Stopping,” then set the stop time using the ◀/▶ buttons.

4 Press the RETURN button to come back to the Parental Lock menu.

⚡ **Notes**

- Once the Child Lock is activated, a Personal Identification Number (PIN) must be entered to view the TV channels during the specified time period.
- Any recording made within a child lock period (assuming Child Lock is turned on) will require PIN entry in order to view the recording.

Auto Tune

This option allows you to capture and store automatically in numerical order all available TV and Radio channels.

1 Follow steps 1 to 3 of “Digital TV settings (DTV Settings)” on page 40, then select “Auto Tune,” and press ENTER. The Auto Tune Start Display appears.

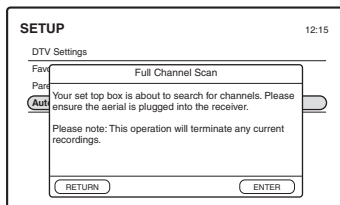

2 Press ENTER to start Auto Tuning. The Full Channel Scan display appears showing a tuning progress bar.

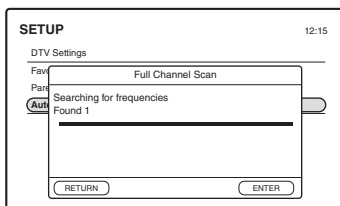

When Auto Tune has ended, a completion display appears indicating the number of TV and Radio channels that have been found and stored.

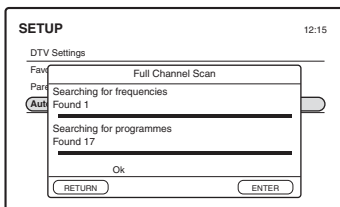

3 Press the ENTER button to close the display.

Video and Audio Settings (Options)

The “Options” setup allows you to adjust the items related to the image size, colour and sound, such as language and audio output level.

Choose the settings according to the type of TV, VCR or similar device connected to the Hard Disk Recorder.

1 Press **SYSTEM MENU** while the recorder is in stop mode.

2 Select “**SETUP**,” and press **ENTER**.

3 Select “**Options**,” and press **ENTER**.

The “Options” setup appears with the following options. The default settings are underlined.

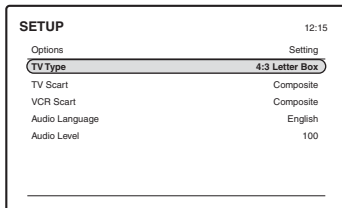

TV Type

Select the playback picture size according to the type of connected TV (wide-screen/wide mode TV or conventional 4:3 screen TV).

<u>4:3 Letter Box</u>	Select this when connecting to a 4:3 screen TV. Displays a wide picture with bands on the upper and lower portions of the screen.
4:3 Pan Scan	Select this when connecting to a 4:3 screen TV. Automatically displays a wide picture on the entire screen and cuts off the portions that do not fit.
16:9 Wide Screen	Select this when connecting to a wide-screen TV or TV with a wide mode function.

4:3 Letter Box



4:3 Pan Scan



16:9



TV Scart

Selects a method of outputting video signals for the LINE 1 – TV scart.

<u>RGB</u>	Outputs RGB signals.
<u>Composite</u>	Outputs composite video signals (CVBS).
S Video	Outputs S-video signals.

Note

If your TV does not accept S-video or RGB signals, black and white picture or no picture appears on the TV screen even if you select “S Video” or “RGB.” See the instructions supplied with your TV.

VCR Scart

Selects a method of inputting / outputting video signals for the LINE 2 - VCR / STB scart.

<u>Composite</u>	Outputs composite video signals (CVBS).
S Video	Outputs S-video signals.

Notes

- If your TV or VCR does not accept S-video, black and white picture or no picture appears on the TV screen or black and white picture or no picture will be recorded on your VCR if you select “S Video”. See the instructions supplied with your TV or VCR.
- The mute and volume control function do not operate on LINE 2 - VCR / STB output.
- To be able to view the signals from the connected VCR on the TV via the Hard disk recorder’s LINE 2 - VCR / STB (line through feature), you may press the INPUT SELECT button on your remote to switch the recorder’s input to enable the VCR video signal to pass through the Hard Disk recorder.
- This recorder cannot record the contents from the connected VCR, STB or similar device.

Audio Language

You can set your Hard Disk Recorder to play the audio track in the language you prefer if that language is available.

- 1 Follow steps 1 to 3 of “Video and Audio Settings (Options)” on page 42, then select “Audio Language.”
- 2 Press the **←/→** buttons to set the desired language.
Each time you press the buttons, the setting on the TV screen changes as follows.

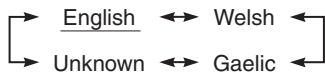

- 3 Press the RETURN button to return to the Options menu.

Note

If the programme broadcast carries the optional audio language you have chosen, you will hear that language. Otherwise, you will only be able to listen in the default language.

Audio Level

The following setup adjusts the audio signal output level when you connect a component such as TV or an audio amplifier.

This function affects the output of the following jacks:

- AUDIO OUT L-R jacks
- LINE 1 – TV jack

- 1 Follow steps 1 to 3 of “Video and Audio Settings (Options)” on page 42, then select “Audio Level.”
- 2 Press the **←/→** buttons to set the desired output level.
You can adjust from step 100 (full audio output) to 0. Each press reduces or advances the audio level in increments of 5 units.
- 3 Press the RETURN button to return to the Options menu.

Recording/Hard Disk Recorder and Remote Control Settings/Factory Settings (Features)

The “Features” setup allows you to set up operational settings for the unit such as Subtitle Language and Command Mode.

- 1 Press **SYSTEM MENU** while the recorder is in stop mode.
- 2 Select “**SETUP**,” and press **ENTER**.
- 3 Select “**Features**,” and press **ENTER**.

The “Features” setup appears with the following options. The default settings are underlined.

SETUP		12:15
Features	Setting	
<u>Record Subtitles</u>	<u>Off</u>	
Subtitle Language	English	
Interactivity	On	
Sleep Timer	0	
Front Panel	On	
Command Mode	HDD 1	
Format HDD		
Factory Setup		

Record Subtitles

Press the **←/→** buttons to set the desired option.

On	Allows you to record the subtitles broadcasted by a digital channel (when available).
<u>Off</u>	Turns off the subtitle recording function.

When you select “On,” a warning message appears. Press **ENTER** to confirm subtitle recording, otherwise press **RETURN** to escape.

Notes

- Any recordings made with “Record subtitles” set to “On” cannot be compressed.
- Recordings made with “Record subtitles” set to “On” will take more disk space than those made without.
- When changing the “Record subtitles” setting, you will clear the Pause/Rewind TV buffer.
- Not all programmes have subtitle information and some interactive services may not operate while displaying subtitles.

Subtitle Language

Selects your preferred subtitle language.

Press the \leftarrow/\rightarrow buttons to set the desired language. Each time you press the buttons, the setting on the TV screen changes as follows.

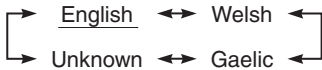

Note

- If the programme broadcast carries the optional subtitle language you have chosen, subtitles will be viewed in that language. Otherwise, you will only be able to view in the default language.

Interactivity

Interactive services are currently available on some channels. See page 23.

If you do not wish to operate interactive services through your receiver, press the \leftarrow/\rightarrow buttons to turn this function off.

<u>On</u>	Allows you to operate interactive services (when available).
Off	Turns off the access to interactive services on a permanent basis.

Sleep Timer

Sets the Hard Disk Recorder to turn itself off.

Press the \leftarrow/\rightarrow buttons to adjust the settings in 5 minute periods (up to 2 hours).

Notes

- To cancel the Sleep Timer, reset the value to "0".
- Once Sleep Timer is set, a warning message will be displayed in the last 30 seconds before the Hard Disk Recorder shuts down to allow you to cancel.
- The Sleep Timer may also turn off your TV if it is directly connected to the Hard Disk Recorder via SCART.

Front Panel

Adjusts the lighting of the front panel display.

<u>On</u>	Bright lighting.
Dimmed	Low lighting.
Off	Turns off the lighting.

Command Mode

Changes the Command Mode of the recorder if another Sony Hard Disk recorder is assigned the same Command Mode. Be sure to match the Command Mode on the remote to the setting made

here. For details, see "If you have more than one Sony Hard Disk Recorder" on page 12.

<u>HDD 1</u>	The default Command Mode of the recorder.
HDD 2	Select this if the default Command Mode conflicts with other Sony Hard Disk recorders.
HDD 3	Select this if the default Command Mode conflicts with other Sony Hard Disk recorders.

Format HDD

Deletes all saved programming on your Hard Disk recorder. Note that all of your previous channel listing, favourite channels, recordings and timer settings will be erased.

- 1 Select "Format HDD" in "Features," and press ENTER
The display for entering the Personal Identification Number (PIN) appears.
- 2 Enter your four-digit password using the number buttons and press ENTER.
- 3 Once the warning message display appears, press ENTER again to format the Hard Disk.
- 4 The recorder reboots automatically after a few seconds to complete HDD format.
Follow the on-screen instructions to enable the recorder to start searching for all of the receivable TV and Radio channels in your local area. See "Step 6: Auto Tuning (Full Channel Scan)" on page 13.

Note

If you forget your password, you will have to reset it by selecting "Parental Lock" in "DTV Settings" setup (page 40).

Factory Setup

Allows you return all the settings to their default position and to keep your channel listing, favourite channels and all recordings stored on the hard disk. Note that all of your previous settings will be lost.

- 1 Select "Factory Setup" in "Features," and press ENTER
The display for entering the Personal Identification Number (PIN) appears.
- 2 Enter your four-digit password using the number buttons and press ENTER.

- 3 Once the warning message display appears, press ENTER again to confirm.

Note

If you forget your password, you will have to reset it by selecting "Parental Lock" in "DTV Settings" setup (page 40).

Technical Information (Technical Info)

Select this to check the technical settings.

- 1 Press **SYSTEM MENU** while the recorder is in stop mode.
- 2 Select **"SETUP,"** and press **ENTER.**
- 3 Select **"Technical Info,"** and press **ENTER.**

The "Technical Info" display appears with the following options.

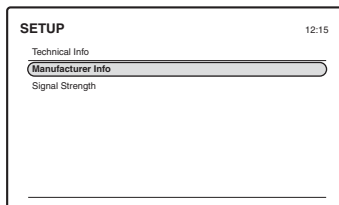

Manufacturer Information

This information screen shows the current version of software and hardware installed in your recorder.

- 1 Select "Manufacturer Info," in the Technical Information display and press ENTER.
- 2 After viewing the information, press the RETURN button to come back to the Technical Information menu.

Signal Strength

This information screen shows the signal strength of the broadcasts you are watching.

- 1 Select "Signal Strength," in the Technical Information display and press ENTER.

The Signal Strength display appears showing both Tuner 1 and Tuner 2 signal strengths along with the name of your local transmitter and the tuned UHF channel.

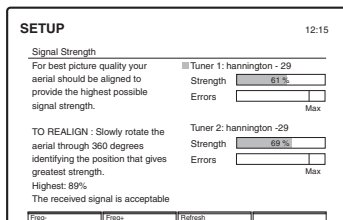

The coloured bars indicates the signal quality.

- 2 Press the \uparrow/\downarrow buttons to toggle the position of the green cursor between the description of Tuner 1 and Tuner 2 signal strength.

If the signal strength is low you may need to realign your aerial and / or to adjust the UHF frequency.

We strongly recommend that you ask your professional installer to arrange for the aerial installation and frequency setting.

- 3 After viewing the information displayed, press the RETURN button to come back to the Technical Information menu.

Additional Information

Troubleshooting

If you experience any of the following difficulties while using the recorder, use this troubleshooting guide to help remedy the problem before requesting repairs. Should any problem persist, contact the Sony Customer Information Centre at

08705 111 999

(Monday-Friday from 9:00am to 6:00pm)

Power

The power does not turn on.

- ➔ Check that the mains lead is connected securely.

Tuner

The channel is not found or stored or missed.

- ➔ Make sure that your aerial is properly connected to the recorder.
- ➔ Confirm with your dealer that you are in an area that can receive a digital signal.
- ➔ Check your aerial installation.

Picture

There is no picture.

- ➔ Re-connect all connecting cords securely.
- ➔ The connecting cords are damaged.
- ➔ Check the connection to your TV (page 7).
- ➔ Switch the input selector on your TV (such as to "VCR") so that the signal from the recorder appears on the TV screen.
- ➔ Check that Scart Setting in "Video and Audio Settings (Options)" setup is set to the appropriate item that conforms to your system (page 42).
- ➔ This recorder cannot record NTSC signals.
- ➔ A scrambled channel is selected.

Picture noise appears.

- ➔ Noise may appear in the pictures recorded on the HDD, which is due to the characteristics of HDD, and is not a malfunction.

Picture breaks up

- ➔ Signal strength low.
- ➔ Check aerial installation.

TV programme pictures are distorted.

- ➔ Reorient or upgrade the TV aerial.
- ➔ Adjust the picture (see the TV's instruction manual).
- ➔ Place the recorder and TV farther apart.
- ➔ Place the TV and any bunched aerial cables farther apart.
- ➔ The RF cable is connected to the AERIAL OUT jack on the recorder. Connect the cable to the AERIAL IN jack.

TV channels cannot be changed.

- ➔ A timer recording started, which changed the channels.
- ➔ The Parental Lock is activated (page 40).

The picture from equipment connected to the recorder's LINE 2 - VCR / STB input jack does not appear on the TV screen.

- ➔ Press the INPUT SELECT button on your remote to switch the recorder's input to the LINE 2 - VCR / STB line to enable the VCR video signal to pass through the Hard Disk recorder.

The playback picture or TV programme from the equipment connected through the recorder is distorted.

- ➔ If the playback picture output from a DVD player, VCR, or tuner goes through your recorder before reaching your TV, the copy-protection signal applied to some programmes could affect picture quality. Disconnect the playback equipment in question and connect it directly to your TV.

The picture does not fill the screen.

- ➔ Set "TV Type" in "Video and Audio Settings (Options)" setup in accordance with the screen size of your TV (page 42).

The picture is black and white.

- ➔ Check that Scart Setting in "Video and Audio Settings (Options)" setup is set to the appropriate item that conforms to your system (page 42).
- ➔ If you are using a SCART cord, be sure to use one that is fully wired (21 pins).

Sound

There is no sound.

- ➔ Re-connect all connections securely.
- ➔ The connecting cord is damaged.
- ➔ The input source setting on the amplifier or the connection to the amplifier is incorrect.
- ➔ The recorder is in reverse play, fast-forward, slow motion, or pause mode.
- ➔ A scrambled channel is selected.
- ➔ The volume MUTING button has been pressed.

The sound volume is low.

- ➔ Check and adjust the audio output level in “Video and Audio Settings (Options)” setup (page 43).

Sound break up

- ➔ Signal strength low.
- ➔ Check aerial installation.

Playback

The recorder does not play.

- ➔ Moisture has condensed inside the recorder. Leave the recorder turned on for about half an hour until the moisture evaporates.

The language for the sound track cannot be changed.

- ➔ Not all broadcasts carry multilingual language tracks. In that case you can only listen in the default language.

TV Pause does not work.

- ➔ Two simultaneous programmes are currently recording to the HDD or the HDD is full.

Recording/Timer recording/ Editing

The programme position cannot be changed from the programme position you are recording.

- ➔ Set the TV’s input source to “TV.”
- ➔ When two simultaneous programmes are currently recording to the HDD, you can only watch one of these two channels or play a title from the Title List.

Nothing was recorded even though you set the timer setting correctly.

- ➔ There was a power failure during recording.
- ➔ Disconnect the mains lead from the mains for at least 10 seconds, and connect it again.
- ➔ There is not enough disk space for the recording.
- ➔ A scrambled or teletext channel was selected.
- ➔ Parental Lock has been activated (page 40).

Recording does not stop after you press ■.

- ➔ You may have to press ■ REC STOP.

Timer recording is not complete or did not start from the beginning.

- ➔ There was a power failure during recording. If the power recovers when there is a timer recording, the recorder resumes recording.
- ➔ Disk space was not enough.
- ➔ The broadcast schedule changed.

One Touch Recording does not start after you press ● REC

- ➔ One Touch Recording is not possible if no TV Guide information is available for the particular programme. In this case you can record the programme by setting the timer manually (page 26).
- ➔ There is not enough disk space for the recording.
- ➔ The programme overlaps with two other timer settings.

Display

The TIMER REC indicator is flashing.

- ➔ The HDD does not have enough space.

The clock does not appear in the front panel display.

- ➔ The front panel lighting has been set to “Off” (page 44).

Remote control

The remote does not function.

- ➔ Batteries are weak.
- ➔ The remote is too far from the recorder.
- ➔ The remote’s manufacturer code returned to the default setting when you replaced the batteries. Reset the code (page 11).

- ➔ Turn on the recorder.
- ➔ The remote is not pointed at the remote sensor on the recorder.
- ➔ Different command modes are set for the recorder and remote. Set the same command mode (page 12). The default command mode setting for this recorder and the supplied remote is HDD 1.

Other Sony equipment responds to the remote.

- ➔ The same command mode is set for both the equipment and recorder. Set a different command mode for the recorder (page 12).

Others

The recorder does not operate properly.

- ➔ Restart the recorder.
- ➔ When static electricity, etc., causes the recorder to operate abnormally, turn off the recorder. Then, unplug the recorder from the mains and after leaving it off for a while (10 seconds minimum), plug it in again.
- ➔ Check that the vent under the recorder is not blocked. Then, immediately disconnect the mains lead. Leave the recorder off for a while, then re-connect the mains lead, and press  on the recorder.

“OAD” or “EPG” appears in the front panel display.

- ➔ This happens at night time around 3:00. If the recorder remains at this state for more than two hours, the unit may have experienced a problem in downloading a programme guide or software update. Turn off the recorder, unplug the recorder from the mains, and after leaving it off for a while (10 seconds minimum), plug it in again.

Mechanical sound is heard when the recorder is off.

- ➔ The unit contains both a Hard Disk Drive and a cooling fan which runs continuously. Therefore, operational noise may be heard, even when the power is off. This is not a malfunction.

Specifications

System

Transmission standards: DVB-T



Channel coverage: UHF channels B21 - B69

The above channel coverage merely ensures the channel reception within these ranges. It does not guarantee the ability to receive signals in all circumstances.

Aerial out: 75-ohm asymmetrical aerial socket

Video recording format: MPEG Video

Inputs and outputs

LINE 1 - TV: 21-pin

CVBS/S-Video/RGB OUT

LINE 2 - VCR / STB: 21-pin

CVBS IN/OUT

S-Video IN/OUT

RGB IN

AUDIO OUT: Phono stereo jack L/R

General

Power requirements:

Mains adapter input: 110-240 V AC, 50/60 Hz

Recorder input: DC 12 V , 1,8A

Power consumption: 30 W (maximum)

Dimensions (approx.): 362 × 52 × 252 mm
(width/height/depth) incl. projecting parts

Hard disk drive capacity: 80 GB (approx.)

Mass (approx.): 2.5 Kg

Operating temperature: 5°C to 35°C

Operating humidity: 25% to 80%

Supplied accessories:

AC power adapter (1)

Power cord (1)

Remote commander (remote) (1)

R6 (size AA) batteries (2)

Specifications and design are subject to change without notice.

Guide to Parts and Controls

For more information, see the pages in parentheses.

Remote

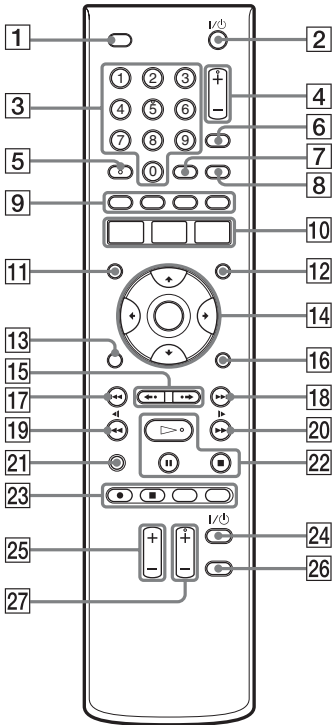

- 1** **MUTING** button
Mutes the volume. Press again to restore the volume. To operate your TV, you must first setup the remote control (11)
- 2** **I/O** (on/standby) button (13)
- 3** **Number** buttons (14)
The number 5 button has a tactile dot*.
- 4** **PROG** (programme) +/- buttons (16)
The + button has a tactile dot*.
- 5** **AUDIO** button (32)
- 6** **INPUT SELECT** button (9)

- 7** **SUBTITLE** button (32)
- 8** **TELETEXT** button (24)
- 9** **Coloured multimedia applications & interactive services control** buttons (20)
- 10** **SYSTEM MENU** button (12, 40)
TITLE LIST button (17, 31)
GUIDE (TV Guide) button (20)
- 11** **PROG LIST** button (14)
- 12** **FAVOURITE** button (22)
- 13** **RETURN** button (29)
- 14** **←/↑/↓/→/ENTER** button (12)
- 15** **←••** (instant replay)/**••→** (instant advance) buttons (15, 33)
- 16** **INFO** button (21)
- 17** **◀◀** (previous) button (32)
- 18** **▶▶** (next) button (32)
- 19** **◀◀◀** (search) buttons (32)
- 20** **▶▶▶** (search) buttons (32)
- 21** **DISPLAY** button (16, 19)
- 22** **▷** (play) button (31)
|| (pause) button (32)
■ (stop) button (31)
The ▷ button has a tactile dot*.
- 23** **●** **REC** button (16)
■ **REC STOP** button (16)
TIMER button (26)
TIMER LIST button (29)
- 24** **I/O** (TV on/standby) button (11)
- 25** **VOL** (TV volume) +/- buttons (11)
- 26** **TV/VIDEO** button (11)
- 27** **PROG** (TV programme) +/- buttons (11)
The PROG button has a tactile dot*.

* Use the tactile dot as a reference when operating the recorder.

Front panel

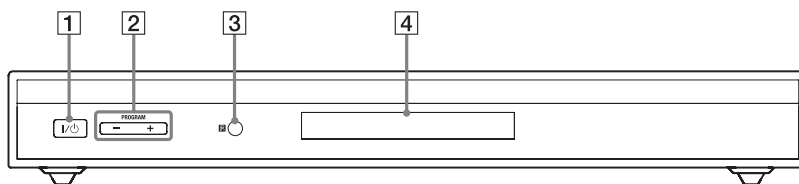

- 1 (on/standby) button (13)
- 2 PROGRAM +/- buttons (16)
- 3 (remote sensor) (11)
- 4 Front panel display (51).

Front panel display

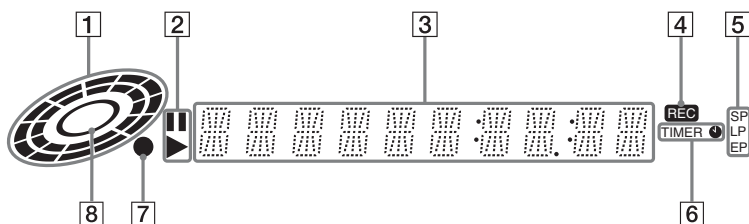

- 1 Recording status segments:
Single rotating star = only one tuner is recording.
Dual rotating star = both tuners are recording.
- 2 TV Pause/Play indicators
- 3 Displays the following:
 - Clock/Channel number while watching live TV
 - Playback mode/Channel name while in playback mode
 - Current menu option
- 4 Indicates that the Hard Disk Recorder is currently recording.
- 5 Recording mode (27)
- 6 TIMER indicator (27)
Indicates that Timer Recordings have been set.
- 7 Indicates that the Hard Disk Recorder is in standby mode
- 8 Indicates remote control activity.

Hint

You can turn off the front panel display when the recorder is turned on by setting "Front Panel" to "Off" (page 44).

Rear panel

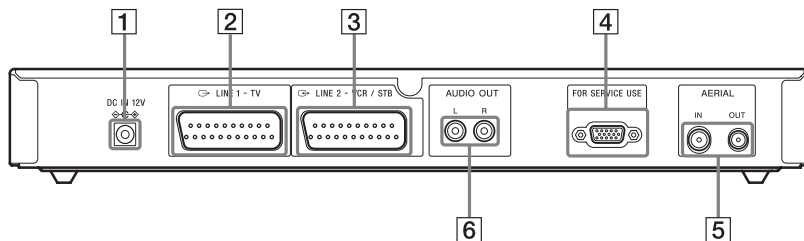

- 1** Power DC IN plug (10)
- 2** LINE 1 - TV jack (8)
- 3** LINE 2 - VCR / STB jack (9)
- 4** SERIAL port, for factory and service use only
- 5** AERIAL IN/OUT jacks (7)
- 6** AUDIO L/R OUT (jacks) (10)

Index

Words in quotations appear in the on-screen displays.

Numerics

- 16:9 42
- 4:3 Letter Box 42
- 4:3 Pan Scan 42

A

- “Advanced” 36
- Aerial 7
- AUDIO 32
- Audio cord 10
- “Audio Language” 43
- “Audio Level” 43
- Audio Settings 42
- Auto Tune 13, 41

C

- Category folders 34
- “Change Pin” 40
- Changing category folders name 34
- Chasing Playback 33
- Checking the hard disk status 16
- Checking/changing/canceling timer settings (Timer List) 29
- “Child Lock” 40
- “Command Mode” 13, 44
- “Composite” 42
- Compression mode 4, 39
- Connecting 8
 - the aerial cable 7
 - the audio cords 10
 - the video cords 8
- Controlling TVs with the remote 11
- Copying Title/Section 38

D

- “Delete” 36
- Digital Services
 - Digital Text viewing 23
 - Favourites 21
 - Setting TV programme reminders 24
 - TV Listing GUIDE 20
- DISPLAY 16, 19
- Display
 - front panel display 51

E

- Editing 36
- Electronic Programme Guide 20
- Erasing a Title/Scene 37
- Erasing and Editing a Title 36
- Erasing sections of a title (Crop Editing) 37

F

- “Factory Setup” 44
- FAVOURITE 22, 50
- Favourites
 - Reorder your favourite channels 22
 - Setting a favourite list 21
 - Watching or listening to a favourite channel 22
- “Features” 43
- “Format HDD” 44
- “Front Panel” 44
- Front panel 51
- Front panel display 51

G

- GUIDE 20, 50

H

- HDD Usage 39
- HDD Usage information box 16

I

- Increasing recording capacity 39
- “Interactivity” 44

L

- “LINE 2 - VCR / STB” 9, 42
- “LINE 1 - TV” 8, 42

M

- Mains Lead 10
- Manufacturer Information 45
- “Mode” 36
- Moving recordings to a programme category folder 35

O

- One Touch Recording 16
- “Order” 18
- Ordering your favourite channels 22
- Original 36

P

- Parental Lock 40
- Password 40
- “Play all” 38
- “Play one” 38
- Playback 19, 31, 32
 - fast forward 32
 - fast reverse 32
 - slow-motion play 32
- Playing status bar 19
- Playing Time and Play Information 19
- Playing titles from a programme category folder 34
- Playlist 36, 38
- PROG LIST 14, 50
- Programme information box 21

R

- Rear panel 52
 - REC 16
 - “Record Subtitles” 43
 - “Recording” 37
 - Recording 43
 - HDD Usage 16
 - Increasing recording capacity 39
 - One Touch Recording 16
 - record paused TV broadcasts 15
 - record two programmes simultaneously 16, 27, 28
 - recording mode 27
 - while playing a previous recorded title 16
 - while watching another programme 16
 - Recording capacity 39
 - Remote 50
 - “Rename” 18, 34, 36
 - “Repeat all” 38
 - “RGB” 42
- ## S
- “S Video” 42
 - “Scart Setting” 42
 - “Scene” 37
 - Scenes 17
 - add new scenes 18
 - delete scenes 17, 37
 - start playback from a specific scene 17
 - Searching
 - fast reverse/fast forward 32
 - locating the beginning of the previous/next scene 32
 - Setting TV programme reminders 24
 - Signal Strength 46
 - Simultaneous Rec and Play 33
 - “Sleep Timer” 44
 - Slow-motion play 32

- Sort
 - favourite channels 22
 - titles 18
- Specifications 49
- SUBTITLE 32, 50
- “Subtitle Language” 44
- Subtitle recording 43

T

- Technical Information 45
- TELETEXT 24, 50
- TIMER 26
- Timer List 29, 33
- Timer recording
 - check/change/cancel 29
 - manual setting 26
 - TV Guide timer setting 28
- Title information 17
- TITLE LIST 17, 31, 36, 50
- Title List
 - Sort 18
- Troubleshooting 47
- TV Listing GUIDE 20
- TV Pause 15, 33
 - record paused TV broadcasts 15
 - skip to live TV 15
- TV programme reminder 24
- “TV Scart” 42
- “TV Type” 42

V

- “VCR Scart” 42
- Video cord 8
- Video Settings 42



2-689-634-11(1)

Free Manuals Download Website

<http://myh66.com>

<http://usermanuals.us>

<http://www.somanuals.com>

<http://www.4manuals.cc>

<http://www.manual-lib.com>

<http://www.404manual.com>

<http://www.luxmanual.com>

<http://aubethermostatmanual.com>

Golf course search by state

<http://golfingnear.com>

Email search by domain

<http://emailbydomain.com>

Auto manuals search

<http://auto.somanuals.com>

TV manuals search

<http://tv.somanuals.com>