

SONY

Digital 4K Video Camera Recorder

FDR-AX30/AX33/AXP33/AXP35

How to Use

Before use

Model Information

- [Model Information \[1\]](#)

Parts and controls

- [Parts and controls \(front/top\) \[2\]](#)
- [Parts and controls \(LCD monitor\) \[3\]](#)
- [Parts and controls \(side\) \[4\]](#)
- [Parts and controls \(back/bottom\) \[5\]](#)

Screen indicators

- [Screen indicators \[6\]](#)

Movie recording format

- [Recording formats available with this product and their features \[7\]](#)

Getting started

Checking the supplied items

- [Supplied items \[8\]](#)

Power source preparations

- [Attaching the battery pack \[9\]](#)
- [Charging the battery pack using the AC Adaptor \[10\]](#)
- [Charging the battery pack using your computer \[11\]](#)
- [Turning the power on \[12\]](#)
- [Using this product supplying power from a wall outlet \(wall socket\) \[13\]](#)

Initial setup

- [Setting the language, date and time \[14\]](#)
- [Adjusting the angle of the LCD monitor for easier viewing \[15\]](#)
- [Adjusting the angle of the viewfinder for easier viewing \(models with the viewfinder\) \[16\]](#)
- [Displaying items on the LCD monitor \[17\]](#)

Preparing a memory card

- [Inserting a memory card \[18\]](#)
- [Types of memory card you can use with this product \[19\]](#)

Recording

Recording movies/photos

- [Recording movies \[20\]](#)
- [Shooting photos \[21\]](#)

Changing the brightness manually for recording

- [Controlling the image settings manually with the MANUAL ring \[22\]](#)
- [Assigning frequently-used functions to the MANUAL button or MANUAL ring \[23\]](#)

Useful functions for recording

- [Zooming \[24\]](#)
- [Capturing photos during movie recording \(Dual Capture\) \[25\]](#)
- [Recording in mirror mode \[26\]](#)

- [Intelligent Auto \[27\]](#)
- [Decreasing the voice volume of the person recording the movie \(My Voice Canceling\) \[28\]](#)
- [Recording the selected subject clearly \(Lock-on AF\) \[29\]](#)

Playback

Playing images using Event View

- [Playing movies and photos from the Event View screen \[30\]](#)
- [Screen display on the Event View screen \[31\]](#)

Creating a highlight movie

- [About Highlight Movie Maker \[32\]](#)
- [Creating a highlight movie \(MP4 format\) with Highlight Movie Maker \[33\]](#)
- [Adding a highlight point during recording \[34\]](#)
- [Playing highlight movies \[35\]](#)

Playing MP4 movies (HD movie) (switching the movie format)

- [Playing MP4 movies \(HD movie\) \(switching the movie format\) \[36\]](#)

Editing images from the playback screen

- [Notes on editing \[37\]](#)
- [Deleting the selected images \[38\]](#)
- [Deleting by date \[39\]](#)
- [Dividing a movie \[40\]](#)
- [Capturing a photo from a movie \(models with the internal memory or models with the USB IN/OUT jacks\) \[41\]](#)
- [Viewing trajectory of a moving object \(Motion Shot Video\) \[42\]](#)

Using the built-in projector

- [Notes on using the projector \(models with the projector\) \[43\]](#)
- [Using the built-in projector \(models with the projector\) \[44\]](#)

- [Using the projector for your computer or smartphone \(models with the projector\) \[45\]](#)

Playing images on a 4K TV

- [Viewing images on a 4K TV \[46\]](#)
- [Enlarging a part of an XAVC S 4K movie on the screen during playback on TV \(Trimming Playback\) \[47\]](#)

Playing images on a high definition TV

- [Connecting this product to a high definition TV \[48\]](#)
- [Enjoying 5.1ch surround sound \[49\]](#)
- [Using BRAVIA Sync \[50\]](#)
- [On Photo TV HD \[51\]](#)
- [On the HDMI cable \[52\]](#)
- [Enlarging a part of an XAVC S 4K movie on the screen during playback on TV \(Trimming Playback\) \[53\]](#)

Playing images on a non-high-definition TV

- [Connecting this product to a non-high-definition TV \[54\]](#)

Saving images with an external device

How to save movies

- [Saving movies \[55\]](#)

Using the PlayMemories Home software

- [Using the PlayMemories Home software \[56\]](#)
- [Checking the computer system \[57\]](#)
- [Installing the PlayMemories Home software in your computer \[58\]](#)
- [Disconnecting this product from the computer \[59\]](#)
- [About the dedicated software for this product \[60\]](#)
- [Creating a Blu-ray disc \[61\]](#)

Saving images on an external media device

- [Notes on use of the external media \[62\]](#)
- [Saving images on an external media device \[63\]](#)
- [Saving the desired images in this product to the external media device \[64\]](#)
- [Playing back images in the external media device on this product \[65\]](#)
- [Deleting images in the external media device \[66\]](#)

Creating a disc with a recorder

- [Creating a disc with a recorder \[67\]](#)

Using the Wi-Fi function

What you can do with the Wi-Fi function

- [What you can do with the Wi-Fi function \[68\]](#)

Controlling via a smartphone

- [Using your smartphone or tablet as a wireless remote commander \[69\]](#)
- [Using your smartphone or tablet as a wireless remote commander using the NFC function \(NFC one-touch remote\) \[70\]](#)

Transferring images to a smartphone

- [Transferring movies \(MP4\) and photos to your smartphone or tablet \[71\]](#)
- [Transferring movies \(MP4\) and photos to your smartphone or tablet using the NFC function \(NFC one-touch sharing\) \[72\]](#)

Transferring images to a computer

- [Send to Computer \[73\]](#)

Transferring images to a TV

- [Playing images on a TV \(View on TV\) \[74\]](#)

Connecting a smartphone

- [Connecting to an Android smartphone or tablet \[75\]](#)
- [Connecting to an iPhone or iPad \[76\]](#)
- [Connecting to an NFC-enabled smartphone or tablet \[77\]](#)

Installing PlayMemories Mobile

- [About the PlayMemories Mobile software \[78\]](#)

Live Streaming

- [About Live Streaming \[79\]](#)
- [Preparing Live Streaming \[80\]](#)
- [Performing Live Streaming \[81\]](#)
- [Restrictions for Live Streaming \[82\]](#)

Controlling other cameras through this product

- [Shooting with this product and other cameras with Multi Camera Control \[83\]](#)
- [Connecting this product to one camera with Multi Camera Control \(Single Connection\) \[84\]](#)
- [Connecting this product to more than one camera with Multi Camera Control \(Multi Connection\) \[85\]](#)
- [Editing images recorded with several cameras \[86\]](#)

Menu operations

Using menu items

- [Setting up menu items \[87\]](#)
- [How to use the keyboard \[88\]](#)

Shooting Mode

- [Movie \[89\]](#)
- [Photo \[90\]](#)
- [Smth Slw REC \[91\]](#)

[Golf Shot \[92\]](#)

- [High Speed REC \[93\]](#)

Camera/Mic

- [White Balance \[94\]](#)
- [Spot Meter/Fcs \[95\]](#)
- [Spot Meter \[96\]](#)
- [Spot Focus \[97\]](#)
- [Exposure \[98\]](#)
- [Focus \[99\]](#)
- [IRIS \[100\]](#)
- [Shutter Speed \[101\]](#)
- [AGC Limit \[102\]](#)
- [AE Shift \[103\]](#)
- [White Balance Shift \[104\]](#)
- [Low Lux \[105\]](#)
- [Scene Selection \[106\]](#)
- [Picture Effect \[107\]](#)
- [Cinematone \[108\]](#)
- [Fader \[109\]](#)
- [Self-Timer \[110\]](#)
- [SteadyShot \(Movie\) \[111\]](#)
- [SteadyShot \(Photo\) \[112\]](#)
- [Digital Zoom \[113\]](#)
- [Auto Back Light \[114\]](#)
- [Manual Ring Setting \[115\]](#)
- [NIGHTSHOT Light \[116\]](#)
- [Face Detection \[117\]](#)
- [Smile Shutter \[118\]](#)
- [Smile Sensitivity \[119\]](#)
- [Flash \(Only when connecting an external flash\) \[120\]](#)
- [Flash Level \(Only when connecting an external flash\) \[121\]](#)
- [Red Eye Reduction \(Only when connecting an external flash\) \[122\]](#)

- [My Voice Canceling \[123\]](#)
- [Blt-in Zoom Mic \[124\]](#)
- [Auto Wind NR \[125\]](#)
- [Audio Mode \[126\]](#)
- [Audio Rec Level \[127\]](#)
- [My Button \[128\]](#)
- [Focus Magnifier \[129\]](#)
- [Grid Line \[130\]](#)
- [Display Setting \[131\]](#)
- [Zebra \[132\]](#)
- [Peaking \[133\]](#)
- [Audio Level Display \[134\]](#)

Image Quality/Size

- [REC Mode \[135\]](#)
- [Frame Rate \[136\]](#)
- [Dual Video REC \[137\]](#)
- [File Format \[138\]](#)
- [Image Size \[139\]](#)

Wireless

- [Ctrl with Smartphone \[140\]](#)
- [Multi Camera Control \[141\]](#)
- [Live Streaming \[142\]](#)
- [Send to Smartphone \[143\]](#)
- [Send to Computer \[144\]](#)
- [View on TV \[145\]](#)
- [Airplane Mode \[146\]](#)
- [Multi Camera Ctrl Set \[147\]](#)
- [Vid REC during strm. \[148\]](#)
- [WPS Push \[149\]](#)
- [Access point settings \[150\]](#)

- [Edit Device Name \[151\]](#)
- [Disp MAC Address \[152\]](#)
- [SSID/PW Reset \[153\]](#)
- [Network Info Reset \[154\]](#)

Playback Function

- [Event View \[155\]](#)

Edit/Copy

- [Delete \[156\]](#)
- [Protect \[157\]](#)
- [Copy \[158\]](#)
- [Direct Copy \[159\]](#)

Setup

- [Media Select \(Models with the internal memory\) \[160\]](#)
- [Media Info \[161\]](#)
- [Format \[162\]](#)
- [Empty \(Models with the internal memory\) \[163\]](#)
- [Repair Img. DB F. \[164\]](#)
- [File Number \[165\]](#)
- [Data Code \[166\]](#)
- [Volume \[167\]](#)
- [Motion Interval ADJ \[168\]](#)
- [Download Music \(Models with the USB IN/OUT jacks\) \[169\]](#)
- [Empty Music \(Models with the USB IN/OUT jacks\) \[170\]](#)
- [TV Type \[171\]](#)
- [HDMI Resolution \[172\]](#)
- [CTRL FOR HDMI \[173\]](#)
- [USB Connect \[174\]](#)
- [USB Connect Setting \[175\]](#)
- [USB LUN Setting \[176\]](#)

- [Beep \[177\]](#)
- [Monitor Brightness \[178\]](#)
- [Auto Keystone ADJ \(Models with the projector\) \[179\]](#)
- [REC Lamp \[180\]](#)
- [Power ON w/monitor \(FDR-AX30\) \[181\]](#)
- [Language Setting \[182\]](#)
- [24p Mode \(1080 50i-compatible device\) \[183\]](#)
- [Cancel 24p Mode \(1080 50i-compatible device\) \[184\]](#)
- [Calibration \[185\]](#)
- [Battery Info \[186\]](#)
- [Power Save \[187\]](#)
- [Initialize \[188\]](#)
- [Demo Mode \[189\]](#)
- [Version \[190\]](#)
- [Date & Time Setting \[191\]](#)
- [Area Setting \[192\]](#)

Charging time/recording time of movies/number of recordable photos

Check the charging time

- [Charging time \[193\]](#)

Expected recording and playback times for individual batteries

- [Expected recording time with each battery pack \[194\]](#)
- [Expected playback time with each battery pack \[195\]](#)

Expected movie recording time and number of recordable photos for the internal memory

- [Notes on recording movies \[196\]](#)
- [Expected recording time of movies \(models with the internal memory\) \[197\]](#)
- [Expected number of recordable photos \(models with the internal memory\) \[198\]](#)

Expected movie recording time and number of recordable photos for memory cards

- [Notes on recording movies \[199\]](#)
- [Expected recording time of movies \[200\]](#)
- [Expected number of recordable photos \[201\]](#)

Bit-rate for each recording mode

- [Bit-rate and recording pixels \[202\]](#)

Pixels recorded at each image size of photos

- [Recording pixels and aspect ratio \[203\]](#)

Additional information

Precautions

- [About the AVCHD format \[204\]](#)
- [About the memory card \[205\]](#)
- [About the InfoLITHIUM battery pack \[206\]](#)

Handling of this product

- [On use and care \[207\]](#)
- [On connecting to a computer or accessory etc. \[208\]](#)
- [Notes on optional accessories \[209\]](#)
- [On moisture condensation \[210\]](#)
- [Notes on disposal/transfer the ownership of this product \(models equipped with the internal memory\) \[211\]](#)
- [Note on disposal/transfer of the memory card \[212\]](#)

Maintenance

- [On handling the LCD monitor \[213\]](#)
- [To clean the casing and the projector lens surface \(models with the projector\) \[214\]](#)

- [About care and storage of the lens \[215\]](#)

Using this product abroad

- [Using this product abroad \[216\]](#)

Trademarks

- [On trademarks \[217\]](#)

License

- [Notes on the License \[218\]](#)

Zoom magnifications

- [Zoom magnifications \[219\]](#)

Using this product after a long time

- [Using this product after a long time \[220\]](#)
-

Troubleshooting

Troubleshooting

If you have problems

- [If you have problems \[221\]](#)

Overall operations

- [The power does not turn on. \[222\]](#)
- [This product does not operate even when the power is set to on. \[223\]](#)
- [The menu settings have been changed automatically. \[224\]](#)
- [This product gets warm. \[225\]](#)

- A rattling noise is heard when this product is shaken. [226]
- Intelligent Auto is canceled. [227]

Batteries/power sources

- The power abruptly turns off. [228]
- The POWER/CHG (charge) lamp does not light while the battery pack is being charged. [229]
- The POWER/CHG (charge) lamp flashes while the battery pack is being charged. [230]
- The remaining battery power is not displayed correctly. [231]
- The battery pack is quickly discharged. [232]

Monitor

- Menu items are grayed out. [233]
- The buttons do not appear on the LCD monitor. [234]
- The buttons on the touch panel do not work correctly or do not work at all. [235]
- The buttons on the LCD monitor quickly disappear. [236]
- There are dots in the shape of a grid on the monitor. [237]
- The backlight of the LCD monitor turns off if you do not attempt to operate this product for a while. [238]

Viewfinder

- The image in the viewfinder is not clear (models with the viewfinder). [239]
- The image in the viewfinder is no-longer displayed (models with the viewfinder). [240]

Memory card

- Operations using the memory card cannot be performed. [241]
- Images stored on the memory card cannot be deleted. [242]
- The data file name is not indicated correctly or flashes. [243]
- Images cannot be played back or the memory card is not recognized. [244]

Recording

- Pressing START/STOP or PHOTO does not record images. [245]

- Photos cannot be recorded. [246]
- The access lamp remains lit or flashing even if recording has stopped. [247]
- The imaging field looks different. [248]
- The actual recording time for movies is less than the expected recording time of the recording media. [249]
- This product stops recording. [250]
- There is a slight time lag between the moment when START/STOP is pressed and the actual movie recording starts or stops. [251]
- The auto focus does not function. [252]
- SteadyShot does not function. [253]
- Images cannot be recorded or played back correctly. [254]
- The subjects passing across this product very fast appear crooked. [255]
- Horizontal stripes appear on the images. [256]
- [Monitor Brightness] cannot be set. [257]
- Sound is not recorded correctly. [258]
- Photos are recorded automatically. [259]

Playback

- Images cannot be played back. [260]
- Photos cannot be played back. [261]
- The movie freezes. [262]
- An icon appears on a thumbnail. [263]
- No sound or only a quiet sound is heard during playback. [264]
- Left and right sound is heard unbalanced when playing back movies on computers or other devices. [265]

Wi-Fi

- The wireless access point you want to connect to does not appear. [266]
- [WPS Push] does not work. [267]
- [Ctrl with Smartphone], [Send to Smartphone], [Send to Computer] or [View on TV] terminates prematurely. [268]
- Cannot transfer movies to your smartphone. [269]
- The shooting screen does not display smoothly. The connection is cut off. [270]

- The shooting screen during Multi Camera Control does not display smoothly. The connection is cut off. [271]
- The NFC connection does not work. [272]

Editing movies/photos on this product

- Unable to edit. [273]
- A movie cannot be divided. [274]
- The demonstration movies cannot be deleted. (models with the internal memory) [275]

Playback on a TV

- Neither image nor sound is played on the connected TV. [276]
- The top, bottom, right, and left edges of images are trimmed slightly on a connected TV. [277]
- The image appears distorted on the 4:3 TV. [278]
- Black bands appear at the top and bottom of the LCD monitor of the 4:3 TV. [279]

Copying/Connecting to other devices

- Images are not copied correctly. [280]

Connecting to a computer

- PlayMemories Home cannot be installed. [281]
- PlayMemories Home does not work correctly. [282]
- This product is not recognized by the computer. [283]

Self-diagnosis display/Warning indicators

Self-diagnosis display/Warning indicators

- Self-diagnosis display [284]

Error messages during Live Streaming

- Error messages during Live Streaming [285]

Warning messages

Warning messages

- [Warning Indicators \[286\]](#)

[1] How to Use | Before use | Model Information

Model Information

In this Help Guide, the differences in the specifications for each model are described together.

If you find the description like “Models with ... ” as below, confirm in this chapter whether the description applies to this product.

- (models with the internal memory)
- (1080 60i-compatible device)
- (1080 50i-compatible device)

To confirm the model name of this product

See the bottom of this product.

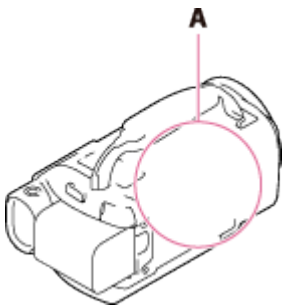

A: Model name (FDR-AX30/AX33/AXP33/AXP35)

Differences in functions

Models with the internal memory: FDR-AX30/AXP35

Models with the projector: FDR-AXP33/AXP35

Models with the Viewfinder: FDR-AX33/AXP33/AXP35

1080 60i-compatible device: See the bottom of this product.

1080 50i-compatible device: See the bottom of this product.

Models with the USB IN/OUT jacks: Except models for Europe.

Models with the USB Output only jack: Models for Europe only.



Note

- For the following items, the descriptions are explained with the model name.
 - Parts and controls
 - Menu items
 - Expected recording time of movies
 - Expected number of recordable photos

[2] How to Use | Before use | Parts and controls

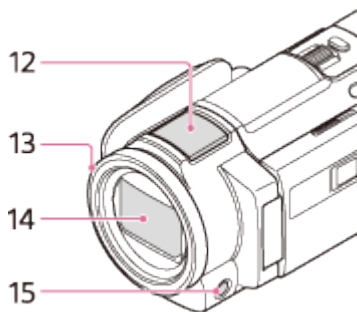
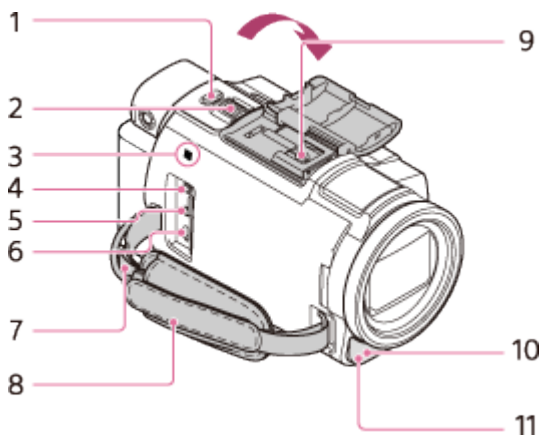
Parts and controls (front/top)



1. PHOTO button
2. Power zoom lever
3. N mark
NFC: Near Field Communication
4.  (microphone) jack (PLUG IN POWER)
5.  (headphones) jack
6. Multi/Micro USB Terminal
Supports Micro USB compatible devices.
This terminal does not support VMC-AVM1 Adaptor Cable (sold separately). You cannot use accessories via an A/V remote connector.
7. Loop for a shoulder belt
8. Grip belt

9. Multi interface shoe



For details on compatible accessories of the Multi interface shoe, visit the Sony website in your area, or consult your Sony dealer or local authorized Sony service facility.

Operations with other manufacture's accessories are not guaranteed.

If you use a shoe adaptor (sold separately), you can also use accessories compatible with an Active Interface Shoe.

To prevent failure, do not use a commercially available flash with high-voltage synchro terminals or with reverse polarity.

10. NIGHTSHOT light

11. Camera recording lamp

12. Built-in microphone

13. MANUAL ring

Manual functions can be assigned to the button and the ring.

14. Lens (ZEISS lens)

15. MANUAL button

[3] How to Use | Before use | Parts and controls

Parts and controls (LCD monitor)

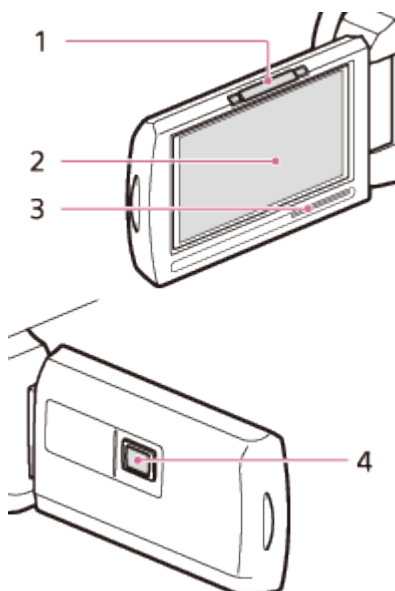

1. PROJECTOR FOCUS lever (FDR-AXP33/AXP35)

2. LCD monitor/Touch panel

If you rotate the LCD panel 180 degrees, you can close the LCD monitor with the screen facing out. This is convenient during playback operations.





3. Speaker

4. Projector lens (FDR-AXP33/AXP35)

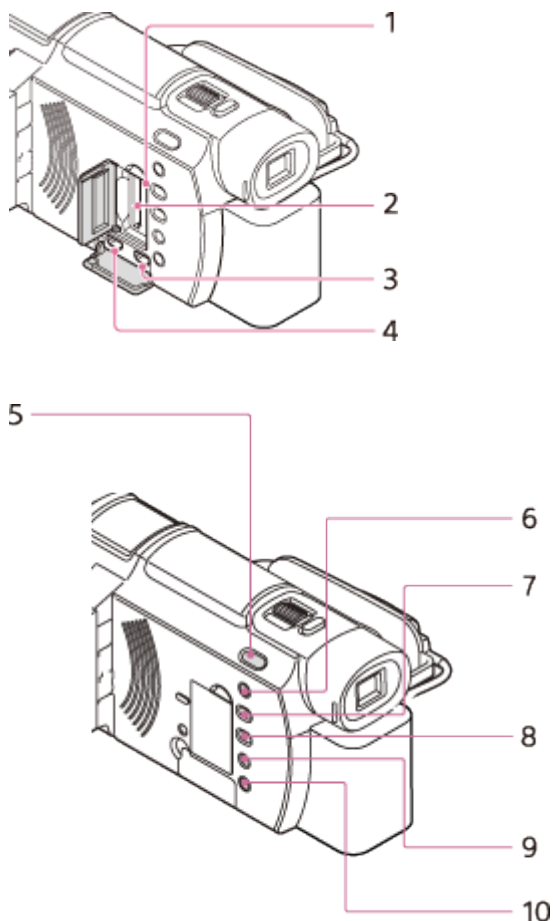
[4] How to Use | Before use | Parts and controls

Parts and controls (side)



1. Memory card access lamp
While the lamp is lit or flashing, this product is reading or writing data.
2. Memory card slot
3. HDMI OUT jack
4. PROJECTOR IN jack (FDR-AXP33/AXP35)
5.  (Shooting Mode) button (FDR-AX33/AXP33/AXP35)
6.  (My Voice Canceling) button
Suppresses the voice of the person recording the movie.
7. PROJECTOR button (FDR-AXP33/AXP35)
8.  (View Images) button
9. NIGHTSHOT button
10.  (ON/STANDBY) button

Parts and controls (back/bottom)

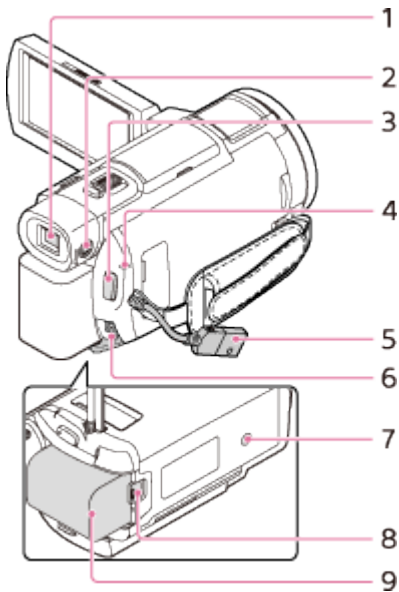

1. Viewfinder (FDR-AX33/AXP33/AXP35)

This product is turned on when the viewfinder is pulled out.

2. Viewfinder lens adjustment dial (FDR-AX33/AXP33/AXP35)

If the indications in the viewfinder appear blurred, adjust the viewfinder lens adjustment dial.

3. START/STOP button

4. POWER/CHG (charge) lamp

5. Built-in USB Cable

6. DC IN jack

7. Tripod receptacle

Attach a tripod (sold separately: the length of the screw must be less than 5.5 mm (7/32 in.)). Depending on the specifications of the tripod, this product may not attach in the proper direction.

8. BATT (battery) release lever

9. Battery pack

To fasten the grip belt

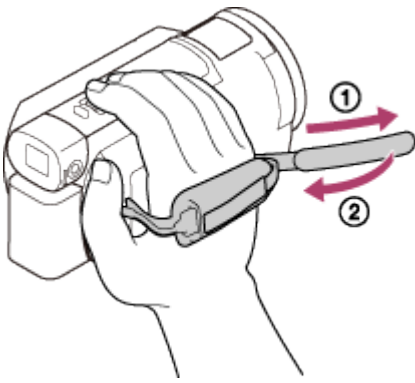

[6] How to Use | Before use | Screen indicators

Screen indicators

The following indicators appear when you change the settings.

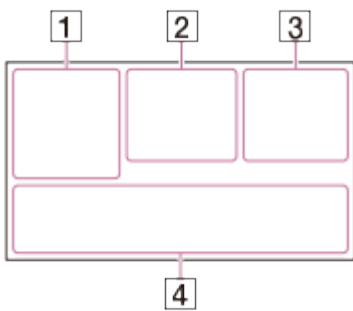

On the left side of the screen (1)

- MENU button
- Self-timer recording
- [Airplane Mode] set to [On]
- Fader
- [Face Detection] set to [Off]
- [Smile Shutter]
- Manual focus
- Scene Selection
- White Balance
- SteadyShot off
- White Balance Shift
- Zebra
- Peaking
- Cinematone
- Intelligent Auto
- Picture Effect

At the center of the screen (2)

 Slideshow Set

     Warning

 Playback mode





REC /STBY Recording mode

 AE/AF lock

 NFC

 Wi-Fi

On the right side of the screen (3)

   60i  Frame rate (30p/60p/50p/60i/50i/24p/25p), recording mode (PS/FX/FH/HQ/LP) and movie size



   Dual Video REC

60 min  Remaining battery

  Recording/playback/editing media

0:00:00 Counter (hour:minute:second)

00min Estimated recording time

9999   20.6M Approximate number of recordable photos and photo size

 101 Folder of the memory card

100/112 Current playing movie or photo/Number of total recorded movies or photos

 Connection to the external media device

At the bottom of the screen (4)

 Audio Rec Level

 [Auto Wind NR] set to [Off]

 [My Voice Canceling] set to [On]

 Blt-in Zoom Mic

  Audio Mode

 Low Lux

 AGC Limit

 Spot Meter/Fcs/Spot Meter/Exposure

 Audio Level Display

EV AE Shift

10000 Shutter Speed

F1.8 IRIS

 Intelligent Auto

 Data file name

 Protect

Note

- Indicators and their positions are approximate and may differ from what you actually see.

- Some indicators may not appear, depending on the model.

[7] How to Use | Before use | Movie recording format

Recording formats available with this product and their features

This product supports XAVC S 4K, XAVC S HD and AVCHD. The image quality of XAVC S 4K is 4-times greater than the conventional high definition image quality.

XAVC S 4K

Recording pixels:

3,840 × 2,160 dots

Bit-rate:

60 Mbps, 100 Mbps

Feature:

Records in 4K. Even if you do not have a 4K TV, recording in 4K format is recommended for future purpose.

XAVC S HD

Recording pixels:

1,920 × 1,080 dots

Bit-rate:

50 Mbps

Feature:

Allows you to record clearer images since XAVC S HD has more information compared with AVCHD.

AVCHD

Recording pixels:

1,920 × 1,080 dots

Bit-rate:

Max. 28 Mbps

Feature:

Allows you to save images on devices other than computers.



Hint

- Bit-rate refers to the data amount recordable over a certain period of time.

[8] How to Use | Getting started | Checking the supplied items

Supplied items

The numbers in () indicate the supplied quantity.

Camcorder (1)

AC Adaptor (1)



HDMI cable (1)

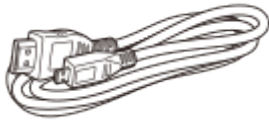

USB connection support cable (1)

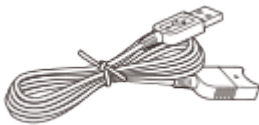

Power cord (mains lead) (1)



Rechargeable battery pack NP-FV70 (1)



- When using this product while connected to a wall outlet (wall socket), such as while charging, make sure to attach the battery pack to this product.

“Operating Guide” (1)



Hint

- The USB connection support cable is designed for use with this product only. Use this cable when the Built-in USB Cable of this product is too short for connection.

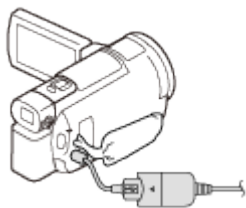

[9] How to Use | Getting started | Power source preparations

Attaching the battery pack

Attach the battery pack to this product.

1. Close the LCD monitor and retract the viewfinder (models with the Viewfinder), and then attach the battery pack (①).
 - Align the indentation on this product and projection on the battery pack, then slide the battery pack upwards.
 - When the viewfinder (models with the Viewfinder) is pulled out, retract it.

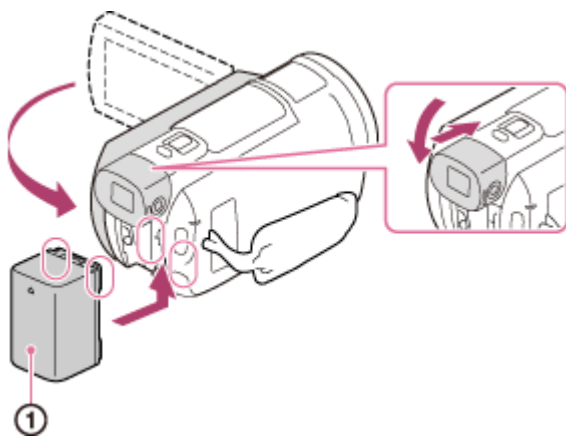

To remove the battery pack

Turn off this product. Slide the battery release lever (①) and remove the battery pack (②).

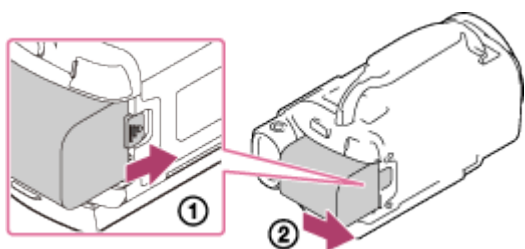

Note

- You cannot use any InfoLITHIUM battery pack other than the V series to this product.
- You cannot use the NP-FV30 InfoLITHIUM battery pack with this product.
- In the default setting, the power turns off automatically if you leave this product without any operation for about 2 minutes, to save battery power (Power Save).

[10] How to Use | Getting started | Power source preparations

Charging the battery pack using the AC Adaptor

Charge the battery pack using the supplied AC Adaptor. Attach the battery pack in advance.

1. Close the LCD monitor.
 - When the viewfinder (models with the Viewfinder) is pulled out, retract it.

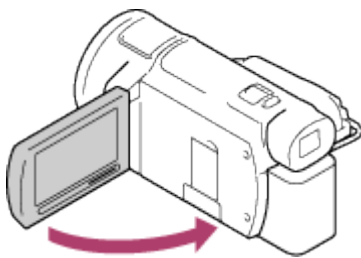

2. Connect the AC Adaptor and the power cord (mains lead) to this product and a wall outlet (wall socket).
 - The POWER/CHG (charge) lamp lights orange.
 - The POWER/CHG (charge) lamp turns off when the battery pack is fully charged. Disconnect the AC Adaptor from the DC IN jack of this product.

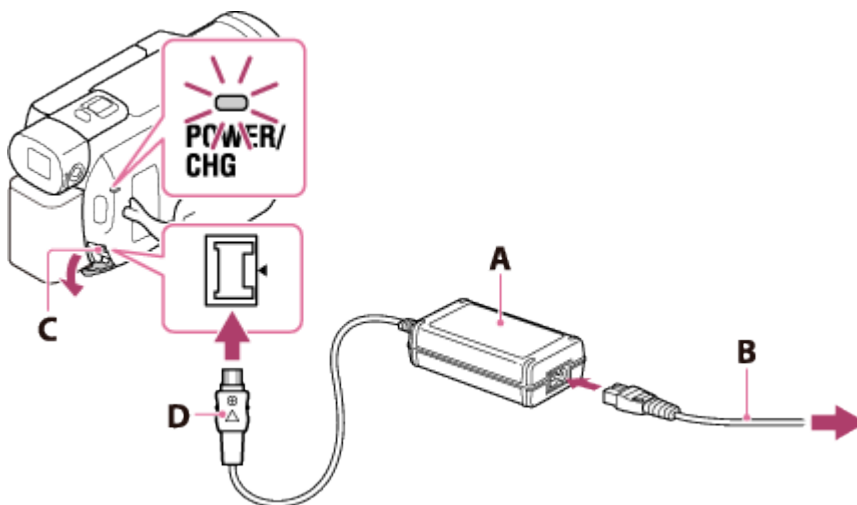

- A: AC Adaptor
B: Power cord (mains lead)
C: DC IN jack

D: Align the ▲ mark on the DC plug

Note

- Be aware of the following notes on using the AC Adaptor.
 - Use a nearby wall outlet (wall socket) when using the AC Adaptor. Disconnect the AC Adaptor from the wall outlet (wall socket) immediately if any malfunction occurs while using this product.
 - Do not use the AC Adaptor placed in a narrow space, such as between a wall and furniture.
 - Do not short-circuit the DC plug of the AC Adaptor or battery terminal with any metallic objects. This may cause a malfunction.

Hint

- It is recommended that you charge the battery in a temperature range of 10 °C to 30 °C (50 °F to 86 °F).

[11] How to Use | Getting started | Power source preparations

Charging the battery pack using your computer

Charge the battery pack by connecting this product and your computer with the Built-in USB Cable. Attach the battery pack in advance.

1. Close the LCD monitor.
 - When the viewfinder (models with the Viewfinder) is pulled out, retract it.

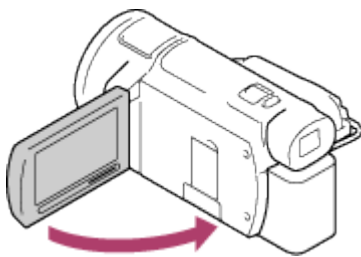

2. Pull out the Built-in USB Cable from this product.

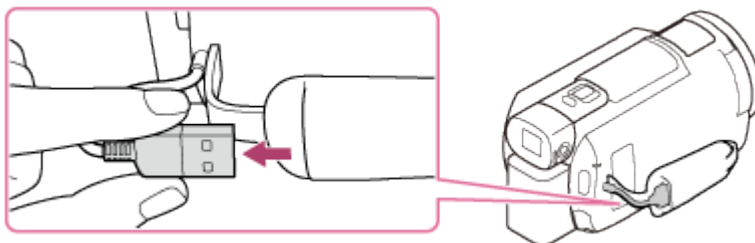

3. Connect this product to a running computer using the Built-in USB Cable.
 - The POWER/CHG (charge) lamp turns orange.

- The POWER/CHG (charge) lamp turns off when the battery pack is fully charged. Disconnect the Built-in USB Cable from the computer, and then store it in the pocket on the grip belt.
- If the Built-in USB Cable is not long enough for the connection, use the USB connection support cable.

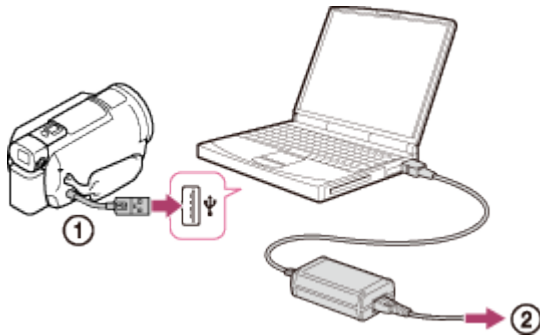

- ①: Built-in USB Cable
②: To a wall outlet (wall socket)

To put the Built-in USB Cable away

Put the Built-in USB Cable back in the pocket on the grip belt after use.

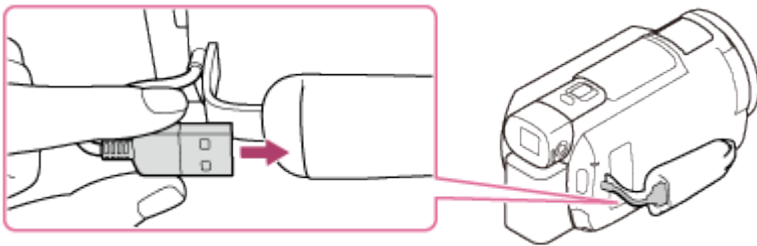

Hint

- It is recommended that you charge the battery in a temperature range of 10 °C to 30 °C (50 °F to 86 °F).

[12] How to Use | Getting started | Power source preparations

Turning the power on

Turn on this product.

1. Open the LCD monitor of this product and turn the power on.
 - You can also turn on this product by pressing  (ON/STANDBY) button or by pulling out the viewfinder (models with the viewfinder).

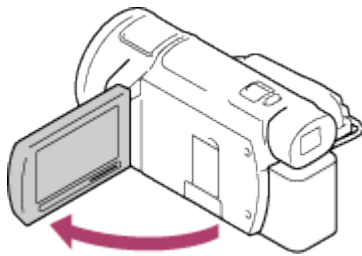

To turn off the power

Close the LCD monitor.

- You can also turn off this product by pressing  (ON/STANDBY) button.
- If the viewfinder (models with the viewfinder) is pulled out, retract the viewfinder as shown in the illustration below.

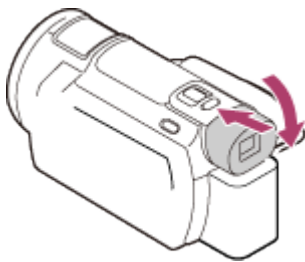

On turning this product on or off using the LCD monitor or the viewfinder (models with the viewfinder)

The power of this product is turned on or off depending on the status of the LCD monitor or the viewfinder.

LCD monitor: Open, Viewfinder: Retracted

Power On

LCD monitor: Open, Viewfinder: Pulled out

Power On

LCD monitor: Closed, Viewfinder: Retracted

Power Off

LCD monitor: Closed, Viewfinder: Pulled out

Power On

Note

- Even if the LCD monitor is closed, if the viewfinder (models with the viewfinder) is pulled out, this product is not turned off. When you turn off the power of this product, make sure that the viewfinder (models with the viewfinder) is retracted to the original position.

Using this product supplying power from a wall outlet (wall socket)

Supply power to this product using the AC Adaptor.

1. Make the same connections as shown in “Charging the battery pack using the AC Adaptor” to use this product.
 - Even if the battery pack is attached, it will not be discharged.

[14] How to Use | Getting started | Initial setup

Setting the language, date and time

Set the language, date and time when using this product for the first time.

1. Open the LCD monitor of this product and turn the power on.
2. Select the desired language, then select [Next].

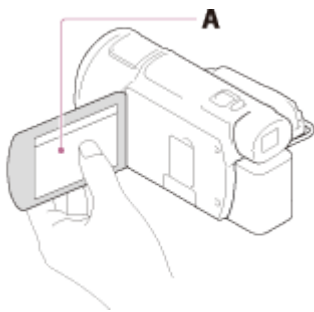

A: Touch the LCD monitor

3. Select the desired geographical area with / , then select [Next].



4. Set [Daylight Savings] or [Summer Time], select the date format and the date and time.
 - If you set [Daylight Savings] or [Summer Time] to [On], the clock advances 1 hour.
 - When you select the date and time, select one of the items and adjust the value with / .

- When you select **OK** - **X**, the date and time setting operation is complete.

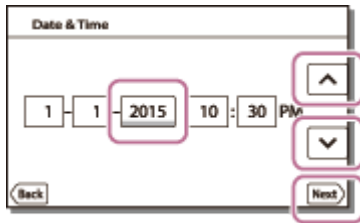

Hint

- The date and time are recorded automatically and can be displayed only during playback. To display them, select **MENU** - [Setup] - [**▶** Playback Settings] - [Data Code] - [Date/Time].

[15] How to Use | Getting started | Initial setup

Adjusting the angle of the LCD monitor for easier viewing

You can adjust the angle of the LCD monitor for easier viewing.

1. First open the LCD monitor 90 degrees to this product (①), and then adjust the angle (②).

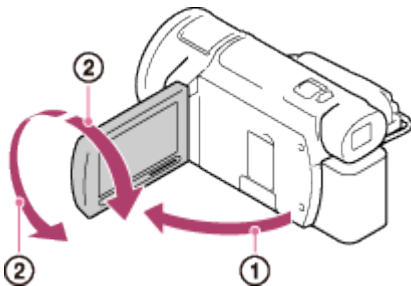

[16] How to Use | Getting started | Initial setup

Adjusting the angle of the viewfinder for easier viewing (models with the viewfinder)

You can adjust the angle of the viewfinder for easier viewing.

1. Close the LCD monitor.
2. Pull out the viewfinder (①) then adjust the angle you want (②).

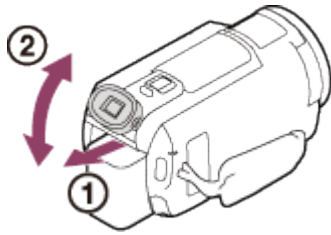

3. Move your eye close to the viewfinder.
 - If the indicators on the viewfinder appear blurred, adjust it using the viewfinder lens adjustment dial located on the side of the viewfinder.

Note

- If this product is not operated for a certain period, the power will turn off and the screen in the viewfinder will disappear. To display the screen again, perform steps 1 and 2.

[17] How to Use | Getting started | Initial setup

Displaying items on the LCD monitor

Items on the LCD monitor disappear if you do not operate this product for a few seconds after you turn this product on or switch between the movie recording and photo shooting modes. To display items on the LCD monitor again, touch anywhere on the LCD monitor other than buttons.

Hint

- To keep the LCD monitor active, use [Display Setting] to change the setting.

[18] How to Use | Getting started | Preparing a memory card

Inserting a memory card

Insert a memory card into this product.

1. Open the cover and insert the memory card until it clicks.

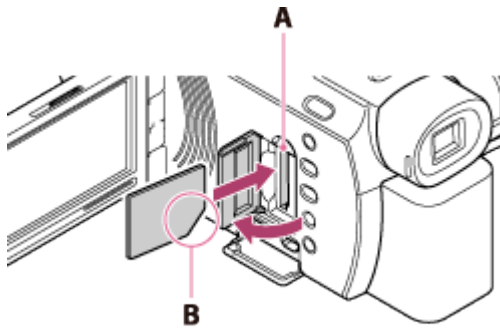

A: Access lamp

B: Insert the card with the notched edge in the direction as illustrated.

Note

- To ensure stable operation of the memory card, it is recommended to format the memory card with this product before the first use. Formatting the memory card will erase all the data stored on it and the data will be irrecoverable. Save your important data on your PC, etc.
- If [Failed to create a new Image Database File. It may be possible that there is not enough free space.] is displayed, format the memory card.
- Confirm the direction of the memory card. If you forcibly insert the memory card in the wrong direction, the memory card, memory card slot, or image data may be damaged.
- Do not insert any memory card other than those that fit into the memory card slot. Doing so may cause a malfunction.
- When inserting or ejecting the memory card, be careful so that the memory card does not pop out and drop.
- Memory card will not be recognized by this product unless it is inserted straight in the correct direction.
- If [Preparing image database file. Please wait.] is displayed, wait until the message disappears.

Hint

- To eject the memory card, open the cover and lightly push the memory card in once.

[19] How to Use | Getting started | Preparing a memory card

Types of memory card you can use with this product

The following types of memory cards can be used with this product.

Types of Memory Stick media you can use with this product

In this Help Guide, the following types of Memory Stick media you can use with this product are called Memory Stick PRO Duo media.

- Memory Stick PRO Duo media (*)
- Memory Stick PRO-HG Duo media (*)
- Memory Stick XC-HG Duo media (**)

*Memory Stick PRO Duo media with a capacity up to 32 GB have been confirmed to operate properly with this product.

**Memory Stick PRO Duo media with a capacity up to 64 GB have been confirmed to operate properly with this product.

Types of SD memory card you can use with this product

In this Help Guide, the following types of SD cards you can use with this product are called “SD card.”

- SD memory card
- SDHC memory card
- SDXC memory card

Note

- When recording images in AVCHD format, use the card of Class 4 or faster.
- When recording images in XAVC S format, use an SDXC memory card of Class 10 or faster. However, an SDXC memory card of UHS-I Speed Class 3 (U3) or faster is required for recording in XAVC S 4K (100 Mbps).
- SD memory cards with a capacity up to 128 GB have been confirmed to operate properly with this product.

[20] How to Use | Recording | Recording movies/photos

Recording movies

Record movies.

1. Open the LCD monitor of this product and turn the power on.
 - You can also turn on this product by pressing  (ON/STANDBY) button or by pulling out the viewfinder (models with the viewfinder).

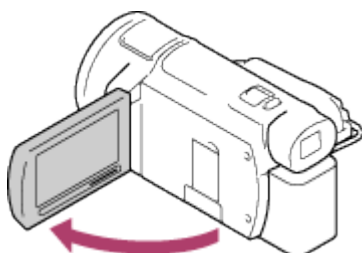

2. Press START/STOP to start recording.

- To stop recording, press START/STOP again.

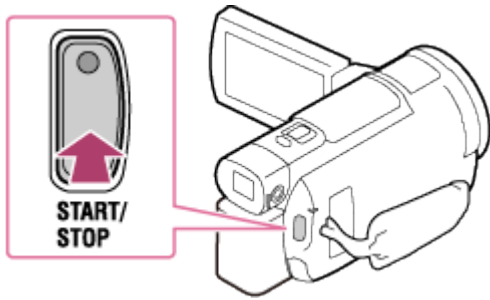

Note

- If you close the LCD monitor while recording movies, this product stops recording (only when the viewfinder is retracted, models with the Viewfinder).
- The maximum continuous recordable time of a movie is about 13 hours.
- When an AVCHD movie file exceeds 2 GB, the next movie file is created automatically.
- When an MP4 movie file exceeds 4 GB, the next movie file is created automatically.
- The following states will be indicated if data is still being written onto the recording media after recording has finished. During this time, do not apply shock or vibration to this product, or remove the battery pack or AC Adaptor.
 - Access lamp is lit or flashing
 - The media icon in the upper right of the LCD monitor is flashing
- The LCD monitor of this product can display recording images across the entire monitor (full pixel display). However, this may cause slight trimming of the top, bottom, right, and left edges of images when played back on a TV which is not compatible with full pixel display. It is recommended you record images with [Grid Line] set to [On] using the outer frame of [Grid Line] as a guide.
- Check the subject on the LCD monitor, and then start recording.
- If the lens cover does not fully open, only a black screen and sound may be recorded.
- While recording XAVC S 4K movies, you cannot output movies to an external monitor via an HDMI/video connection.

Hint

- When [Dual Video REC] is set to [On], this product records an XAVC S movie and an MP4 movie simultaneously, or records an AVCHD movie and an MP4 movie simultaneously.
- In the default setting, [Dual Video REC] is set to [Off].

Shoot photos.

1. Open the LCD monitor of this product to turn the power on.

- You can also turn on this product by pressing  (ON/STANDBY) button or by pulling out the viewfinder (models with the viewfinder).

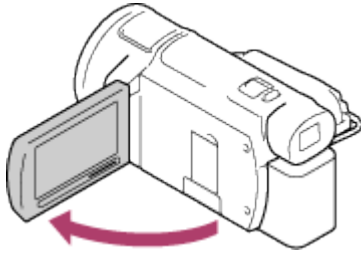

2. Press the  (Shooting Mode) button to select the photo recording mode (models with the viewfinder).

- You can also select the photo recording mode by selecting [MODE] on the LCD monitor (models with the viewfinder).

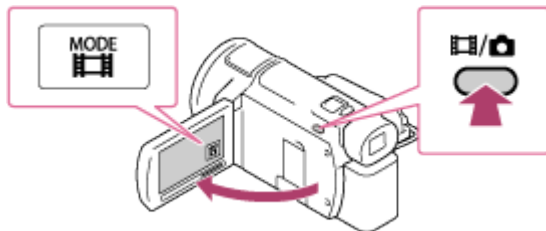

3. Press PHOTO lightly to adjust the focus, then press it fully.

- When the focus is adjusted properly, the AE/AF lock indicator appears on the LCD monitor.

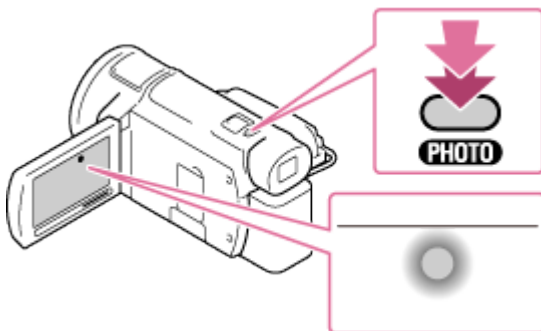

Note

- The following states will be indicated if data is still being written onto the recording media after recording has finished. During this time, do not apply shock or vibration to this product, or remove the battery pack or AC Adaptor.
 - Access lamp is lit or flashing
 - The media icon in the upper right of the LCD monitor is flashing

Controlling the image settings manually with the MANUAL ring

Use the functions assigned to the MANUAL button or MANUAL ring.

1. Press the MANUAL button to switch to the manual operation mode.
 - Pressing the MANUAL button switches the operation mode between manual and automatic.

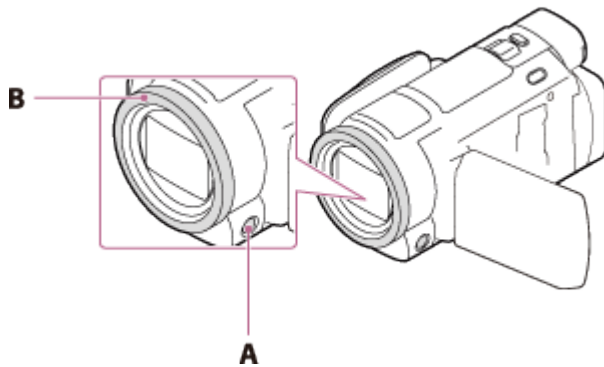

A: MANUAL button

B: MANUAL ring

2. Rotate the MANUAL ring to make adjustments.

Note

- Manual settings will be retained even if you change the assigned item of the MANUAL ring. However, if you set [Exposure] after setting [AE Shift] manually, [Exposure] will override [AE Shift].
- If you set either one of [Exposure], [IRIS], or [Shutter Speed], the settings of other 2 items are canceled.
- The MANUAL ring is not available while using the Live Streaming function.
- The MANUAL ring is not available while using the Multi Camera Control function.

Assigning frequently-used functions to the MANUAL button or MANUAL ring

You can register your desired functions to the MANUAL button or MANUAL ring.

1. Press and hold the MANUAL button down for a few seconds.
 - The [Manual Ring Setting] screen is displayed.
2. Rotate the MANUAL ring and select the item to be assigned.
Select [RESET] to reset the items adjusted manually to the default settings.

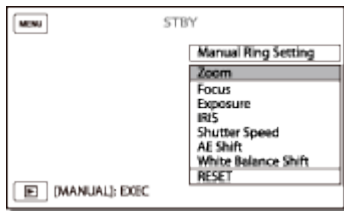

3. Press the MANUAL button to confirm.

Items you can control with the MANUAL ring

- [Zoom]
- [Focus]
- [Exposure]
- [IRIS]
- [Shutter Speed]
- [AE Shift]
- [White Balance Shift]

Hint

- The camera data that appears on the LCD monitor will differ, depending on the recording settings of this product. The settings will be displayed with the following icons.
 - **AUTO**: Automatic
 - **MANUAL**: Exposure is set manually.

[24] How to Use | Recording | Useful functions for recording

Zooming

You can record an image with the subject magnified.

1. Move the power zoom lever to magnify or reduce the size of the image.

W:

Wider range of view (Wide angle)

T:

Close view (Telephoto)

- Move the power zoom lever slightly for a slower zoom. Move it further for a faster zoom.

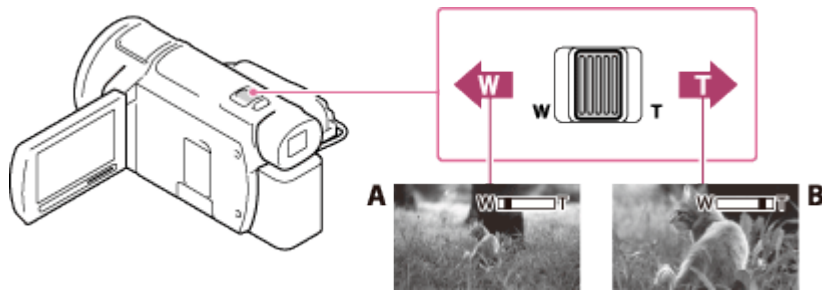

A: Wide angle

B: Telephoto

Note

- Be sure to keep your finger on the power zoom lever. If you move your finger off the power zoom lever, the operation sound of the power zoom lever may also be recorded.
- You cannot change the zoom speed with the W/T button on the LCD monitor.
- The minimum possible distance between this product and subject while maintaining sharp focus is about 1 cm (about 13/32 in.) for wide angle and about 80 cm (about 31 1/2 in.) for telephoto.

[25] How to Use | Recording | Useful functions for recording

Capturing photos during movie recording (Dual Capture)

You can shoot photos during movie recording.

1. Press PHOTO during movie recording to capture still photos.

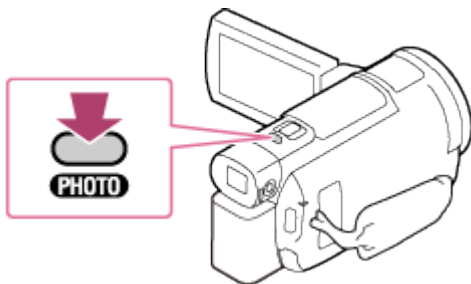

Note

- You cannot capture photos during movie recording in the following situation(s):
 - When [REC Mode] is set to 60p Quality **PS**], [Highest Quality **FX**].

- When an item of [Picture Effect] is selected.
- When [File Format] is set to [4K] XAVC S 4K and [REC Mode] is set to [100Mbps100].
- When [File Format] is set to [4K] XAVC S 4K and [Dual Video REC] is set to [On].

[26] How to Use | Recording | Useful functions for recording

Recording in mirror mode

You can rotate the LCD monitor 180 degrees so the LCD monitor faces toward you to record yourself.

1. Open the LCD monitor 90 degrees to this product (①), then rotate it 180 degrees to the lens side (②), and then start recording.

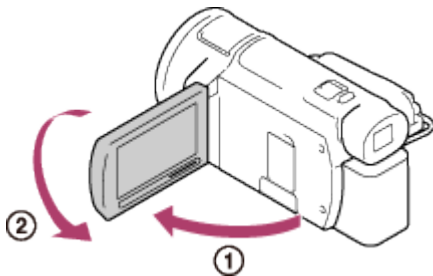





Hint

- A mirror-image of the subject appears on the LCD monitor, but the image will be normal when recorded.

[27] How to Use | Recording | Useful functions for recording

Intelligent Auto

This product records images after selecting the most suitable setting for the subjects or the situation automatically.

1. Select  - [On] -  on the recording screen of movies or photos.
 - To cancel the Intelligent Auto function, select  - [Off] - .



2. Point this product toward the subject and start recording.
 - The icons that correspond to the conditions detected are displayed.



About the detectable scenes

Face detection: 👤 (Portrait), 👶 (Baby)

Scene detection: 🌅 (Backlight), 🏞️ (Landscape), 🌙 (Night Scene), 🎯 (Spotlight), 📶 (Low light), 🌸 (Macro)

Camera-shake detection: 🚶 (Walk), 📵 (Tripod)

Sound detection: 🗣️ (Voice), 🌬️ (Auto Wind NR)

Note

- This product may not detect the expected scene or subject, depending on the recording conditions.

[28] How to Use | Recording | Useful functions for recording

Decreasing the voice volume of the person recording the movie (My Voice Canceling)

You can record movies decreasing the voice volume of the person recording the movie.

1. Press the 🗣️ button.
 - When [My Voice Canceling] is set to [On], 🗣️ is displayed.

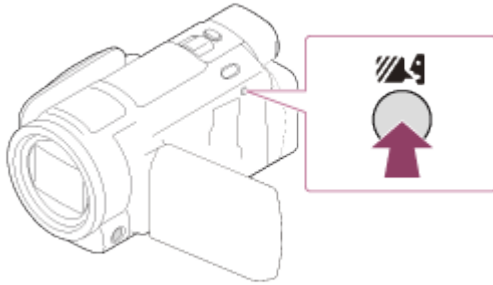

Note

- Set [My Voice Canceling] to [Off] if you want to record a movie without decreasing the voice volume of the person recording the movie.
- Depending on the recording condition, you cannot decrease the voice volume of the person recording the movie as expected.
- The [My Voice Canceling] function does not activate while an external microphone is connected to this product.

Hint

- You can also set [My Voice Canceling] from the menu.

[29] How to Use | Recording | Useful functions for recording

Recording the selected subject clearly (Lock-on AF)

This product can track a subject you select and adjust the focus automatically.

1. Touch the subject you want to track while recording.
 - To cancel the Lock-on AF function, select .

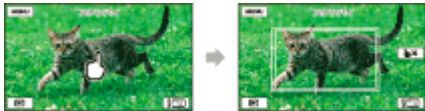

Note

- The Lock-on AF function is not available when [File Format] is set to [4K] XAVC S 4K and [Dual Video REC] is set to [On].





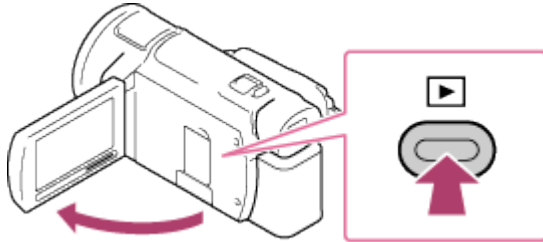

[30] How to Use | Playback | Playing images using Event View

Playing movies and photos from the Event View screen

You can search for recorded images by date and time of recording (Event View).

1. Open the LCD monitor and press  (View Images) to enter the playback mode.
 - You can also operate by selecting  (View Images) on the LCD monitor.



2. Select  /  to move the desired event to the center (①) and then select it (②).
 - This product displays recorded images as an event automatically, based on the date and time.
 - Only movies saved in the format selected in [ File Format] will appear. You can change the displayed movies by selecting the format from [MENU] - [Image Quality/Size] - [ File Format].
 - When you select [ XAVC S 4K], change the [ Frame Rate] setting according to the movie you want to play as well (1080 60i-compatible device).
[ Frame Rate]:
When you select 30p, 24p movies will not appear.
When you select 24p, 30p movies will not appear.

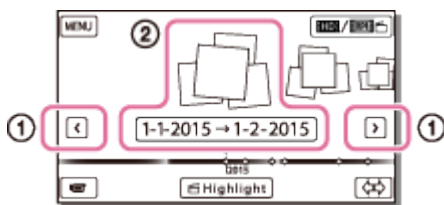

3. Select the image.
 - This product plays from the selected image to the last image in the event.

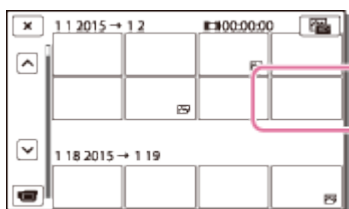

4. Select the appropriate buttons on the LCD monitor for various playback operations.

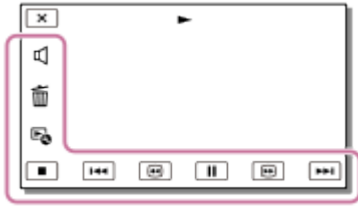

Buttons for playback operations

: Volume

: Previous/Next

: Delete

: Fast-reverse/fast-forward

: Context

: Pause/Play

: Stop

: Play/stop slide show

• To start playing slide show, select  PHOTO from  in step 3.





: Motion shot video

: Motion Interval ADJ

Note

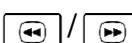
- To prevent your image data from being lost, save all your recorded images on external media periodically.
- Some buttons described above may not appear, depending on the image being played back.
- In the default setting, a protected demonstration movie is pre-recorded (models with the internal memory).

Hint

- As you repeat selecting  during playback, movies are played as fast as about 5 times - about 10 times - about 30 times - about 60 times.
- Select  during pause to play movies slowly.
- To repeat Slideshow, select  - [Slideshow Set] when  is selected with the Switch Image Type button.

[31] How to Use | Playback | Playing images using Event View

Screen display on the Event View screen

Explains items displayed on the Event View screen.

Event View screen

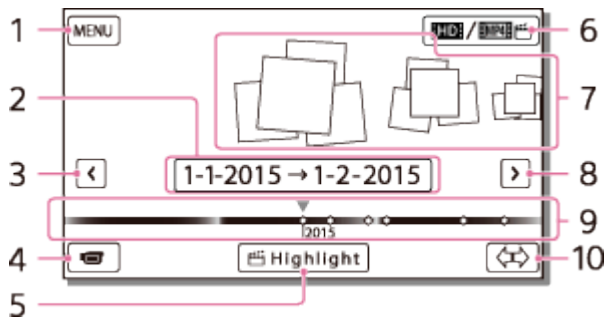

1. To the MENU screen
2. Event name
3. To the previous event
4. To the movie/photo recording mode
5. Highlight Movie Maker (*)
 - * Highlight Movie Maker will be displayed when Movie format is set to AVCHD. It will not be displayed when an external media device is connected to this product.
6. To switch movie format (XAVC S 4K/XAVC S HD/AVCHD/MP4)
The displayed icon differs depending on the [File Format] setting.
7. Events
8. To the next event
9. Time-line bar
10. To change Event Scale (approx. 3 months/1.5 years)

Index screen

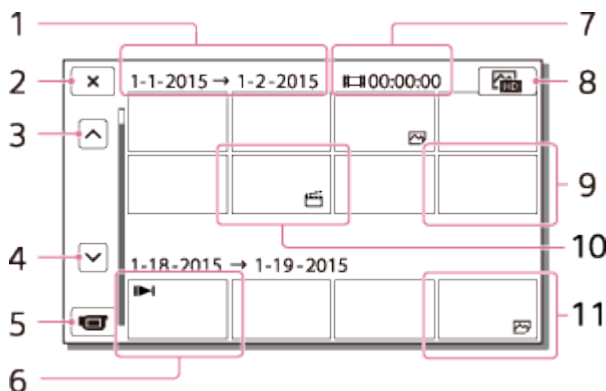

1. Event name
2. To close the index screen
3. To the previous event
4. To the next event
5. To the movie/photo recording mode
6. Last played image
7. Recorded time/number of photos
8. To switch between the movie/photo playback screen (VISUAL INDEX)
Select the image type (MOVIE, PHOTO, MOVIE/PHOTO) you want to play.

- 9. Movie
- 10. Highlight Movie
- 11. Photo

Note

- Displayed icons may differ, depending on the model.

Hint

- Reduced-size images which enable you to view many images at the same time on an index screen are called “thumbnails.”

[32] How to Use | Playback | Creating a highlight movie

About Highlight Movie Maker

Highlight Movie Maker on this product creates highlight movies (MP4 format) from a number of movies (AVCHD format) you have recorded, freeing you from complicated editing work.

Highlight movies created with Highlight Movie Maker are edited to match the background music you select allowing you to share moving scenes by viewing together with your friends and family or uploading to a video sharing site.

You can create a highlight movie that suits your preference more by setting scenes to be used with Highlight Movie Maker, setting highlight points during recording, or changing the background music.

Highlight movies are saved with the date they were created on and can be played back in the same way as recorded movies.



[33] How to Use | Playback | Creating a highlight movie

Creating a highlight movie (MP4 format) with Highlight Movie Maker



Highlight Movie Maker can create highlight movies from a movies (AVCHD format).

You can customize the editing range of Highlight Movie Maker and the background music for highlight movies according to your preference.

It is recommended that you use the AC Adaptor when creating highlight movies with Highlight Movie Maker.

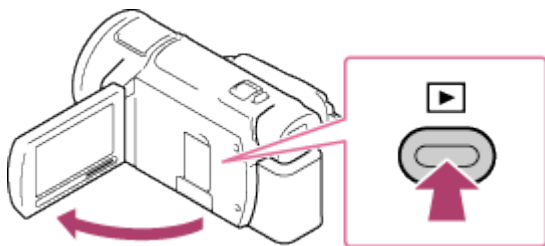
1. Open the LCD monitor and press  (View Images) to enter the playback mode.
 - You can also operate by selecting  (View Images) on the LCD monitor.
 - The Event View screen is displayed.



2. Display the desired event at the center of the Event View, and select  [Highlight].
 -  [Highlight] will not be displayed when only movies recorded in the AVCHD format are selected.



3. To change the settings, select , change the settings according to your preference on the displayed setting screen then select .

4. On the setting confirmation screen, select - . The highlight movie is created.
 - The time required to create a highlight movie is about twice the total duration of the movie being created.
 - The created highlight movie is saved in MP4 format.

5. Select the desired operation when creation of the highlight movie is completed.

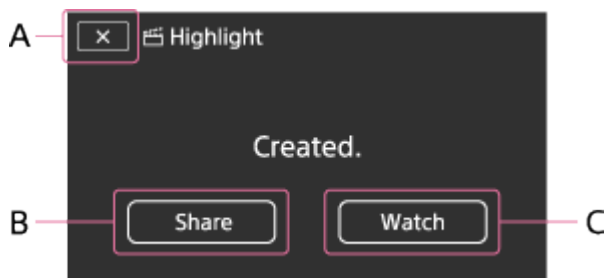

A: To exit.

B: A screen where you can choose to share the created highlight movie on a smartphone or computer is displayed. You will need a Wi-Fi connection or USB connection to share the highlight movie.

C: To play back the created highlight movie to check the content.

Menu items that you can set

[Selection Range]

You can change the date range (starting date/ending date) of the highlight movie to be created.

[Movie Length]

You can set the length of the highlight movie.

[Transition Effect]

You can set the effect of the transition between scenes in the highlight movie.

[Transition Speed]

You can set the speed of the transition between scenes in the highlight movie.

[Music]



You can select your preferred background music for the highlight movie.

[Audio mix]

The balance of recorded sound and background music is adjusted.

[Highlight Point]

You can select scenes to be included in the highlight movie.

To add highlight points, play back a movie, select  to suspend playback, then select  .

To clear the set highlight points of a movie, select  - [Clear All Points].

Hint

- You can also edit the highlight movie with "Playmemories Home."
- You can replace background music files on this product using Music Transfer of "PlayMemories Home."
 - Connect the product with your computer using a USB cable.
 - Start "PlayMemories Home" installed on your computer, then select Music Transfer from the menu bar.
- To transfer a highlight movie to a smartphone or a computer, select  displayed on the playback screen of the highlight movie.

Note

- Select an AVCHD movie whose recording time is 5 seconds or longer.
- If the duration of the selected movie is shorter than the time selected in [Movie Length] or that of the background music, a highlight movie cannot be created.
- The bit-rate of highlight movies created with [Highlight Movie Maker] is 12Mbps.
- The created highlight movie cannot be saved if its file size exceeds the free space of the memory.
- Up to 10 highlight points can be set for a movie. If the number of set highlight points has reached 10 points, no more highlight points can be set. To set a new highlight point, clear all set highlight points and set them again.
- When no highlight points are set, the highlight movie is edited with the points this product

selects.

- There is a possibility that some of the highlight points you have set will not be used in the highlight movie.
- If the highlight movie cannot be played back due to corrupted background music file, select [MENU] - [Setup] - [▶ Playback Settings] - [Empty Music], then transfer the background music file to this product. Background music files pre-installed to this product can be recovered with Music Transfer of "PlayMemories Home."
- The sound of the highlight movie is converted to 2ch stereo audio.
- Only AVCHD movies (except 24p movies) can be used for a highlight movie.

[34] How to Use | Playback | Creating a highlight movie

Adding a highlight point during recording

You can specify highlight points (scenes to be included in a highlight movie) during recording.

1. On the movie recording screen, select  at the bottom right corner when a scene you want to include in the highlight movie appears.



Note

- Up to 10 highlight points can be set. If the number of set highlight points has reached 10 points, no more highlight points can be set. To set a new highlight point, set it when creating the highlight movie.
- Highlight points can be set only on AVCHD movies (except 24p movies) during recording.
- Highlight points you set are not always used for the highlight movie.





[35] How to Use | Playback | Creating a highlight movie

Playing highlight movies

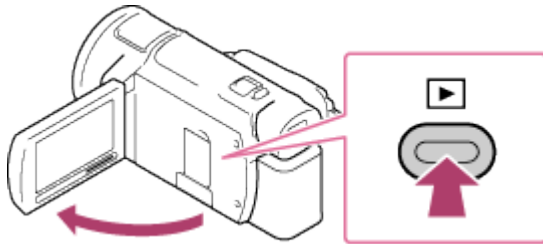
You can play movies created in the Highlight Movie Maker.

1. Open the LCD monitor and press  (View Images) to enter the playback mode.
 - You can also operate by selecting  (View Images) on the LCD monitor.



2. Select  at the top right corner of the screen -  MP4 - .
3. Select  /  to move the desired event to the center (①) and then select it (②).
 - Highlight movies are saved with the date it was created on.

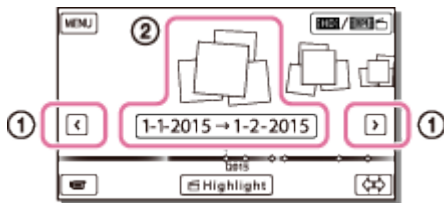

4. Select the image.
 - This product plays from the selected image to the last image in the event.
 -  is displayed in the lower right corner of the highlight movie thumbnail.

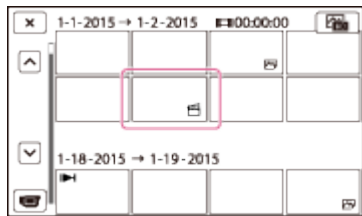





Note

- To prevent your image data from being lost, save all your highlight movies on external media periodically.

[36] How to Use | Playback | Playing MP4 movies (HD movie) (switching the movie format)

Playing MP4 movies (HD movie) (switching the movie format)

The format of a movie to be played or edited can be changed on the Event View screen.

1. Press  (View Images) to enter the playback mode.
2. Select the movie format you want to play from  at the top right corner of the LCD monitor.
 - An icon other than  may be displayed depending on the [ File Format] setting and playback movie format setting.

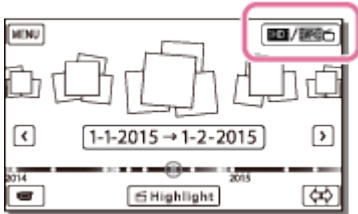

- The format of a movie to be played or edited will be switched.

[37] How to Use | Playback | Editing images from the playback screen

Notes on editing



- Some basic editing operations can be done on this product. If you want to do advanced editing operations, install and use the PlayMemories Home software.
- You cannot restore images once they are deleted. Save important movies and photos before deleting.
- Do not remove the battery pack or the AC Adaptor from this product while deleting or dividing the images. Doing so may damage the recording media.
- Do not eject the memory card while deleting or dividing images saved on the memory card.

[38] How to Use | Playback | Editing images from the playback screen

Deleting the selected images

Select and delete unnecessary images.

1. Press the  button on this product to enter the playback mode.

- On the Event View screen, select , and then select the movie format you want to delete.
 - An icon other than  may be displayed depending on the [File Format] setting and playback movie format setting.

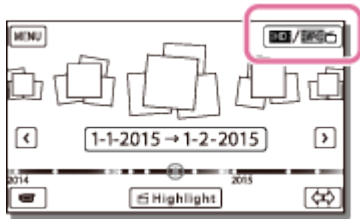

-  - [Edit/Copy] - [Delete].
- Select [Multiple Images], and then select the type of image you want to delete.



- Add check marks to the movies or photos to be deleted and select .

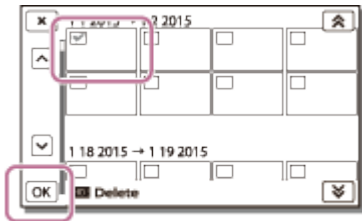

Hint

- You cannot delete protected images (). Release the protection of the data before deleting.
- To delete the unwanted part of a movie, divide the movie and then delete that part.

[39] How to Use | Playback | Editing images from the playback screen

Deleting by date

Select unnecessary images by date of recording and delete them.

- Press the  button on this product to enter the playback mode.
- On the Event View screen, select , and then select the movie format you want to delete.

- Another icon may appear instead of **[HD]** depending on the **[File Format]** setting and the movie playback format.

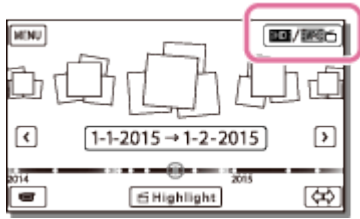

3. **[MENU]** - **[Edit/Copy]** - **[Delete]**.
4. Select **[All In Event]**.
5. Select the date you want to delete using **[↑]** / **[↓]**, and then select **[OK]**.

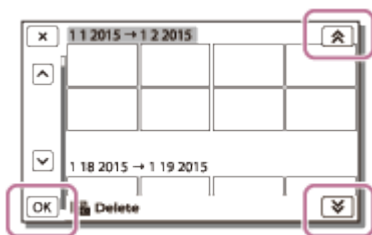

[40] How to Use | Playback | Editing images from the playback screen

Dividing a movie

Split a recorded movie at your desired point.

- This function is available only when **[File Format]** is set to **[HD] AVCHD**.

1. Select **[Divide]** on the movie playback screen.



2. Select the point where you want to divide the movie into scenes using **[▶]** / **[⏸]**, and then select **[OK]**.

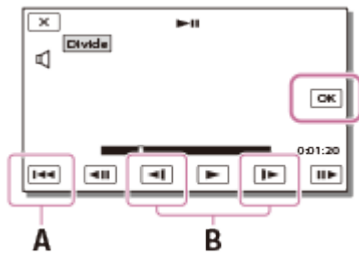

A: Returns to the beginning of the selected movie

B: Adjusts the dividing point with more precision

Note

- A slight difference may occur from the point where you select and the actual dividing point, as this product selects the dividing point based on about half-second increments.
- An XAVC S movie or an MP4 movie cannot be divided.

[41] How to Use | Playback | Editing images from the playback screen

Capturing a photo from a movie (models with the internal memory or models with the USB IN/OUT jacks)

You can capture images from movies recorded with this product.

1. Select  - [Photo Capture] that appears on the playback screen of a movie.

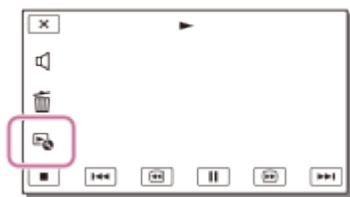

2. Select the scene you want to capture a photo using  / , and then select .

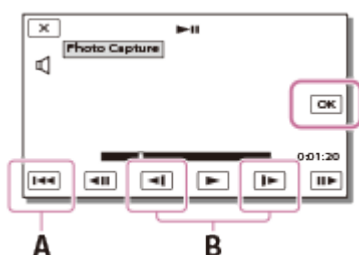

- The image size of the photo is as follows:

- XAVC S 4K format: [8.3 M]
- XAVC S HD/AVCHD format: [2.1 M].

A: Returns to the beginning of the selected movie

B: Adjusts the capturing point with more precision

Note

- You cannot capture photos from a movie saved on a memory card. (models with the USB output only jack)



Hint

- The recording date and time of captured photos are the same as the recording date and time of the movies.
- If the movie you are capturing from has no data code, the recording date and time of the photo will be the date and time you captured from the movie.

[42] How to Use | Playback | Editing images from the playback screen

Viewing trajectory of a moving object (Motion Shot Video)

You can view the trajectory of a fast-moving object.

1. On the Event View screen, play your desired movie, and then select  .
To stop [Motion Shot Video] playback, select  .



Note

- XAVC S 4K movies are not compatible with Motion Shot Video.
- [Motion Shot Video] cannot be saved as movies.
- Trajectories of a moving object may not be created properly if the object is moving slowly or almost not at all.

Hint

- If this function does not work well, you can use  to change the interval of trajectories to be created.
- You can capture photos from your favorite scene of a [Motion Shot Video] ([Photo Capture]).

Notes on using the projector (models with the projector)

- The LCD monitor turns off while an image is being projected.
- Be careful of the following operations or situations while using the projector.
 - Make sure not to project images towards the eyes.
 - Make sure not to touch the projector lens.
 - The LCD monitor and the projector lens become hot while in use.
 - Using the projector shortens battery life (using the supplied AC Adaptor is recommended).
- The following operations are unavailable while you are using the projector.
 - Operation of this product with the LCD monitor closed
 - Several other functions
- When the projected images contain a lot of black, faint color unevenness may appear. This is caused by light reflection in the projector lens and is not a malfunction.

Using the built-in projector (models with the projector)

You can use a flat surface such as a wall as a screen to view recorded images using the built-in projector.

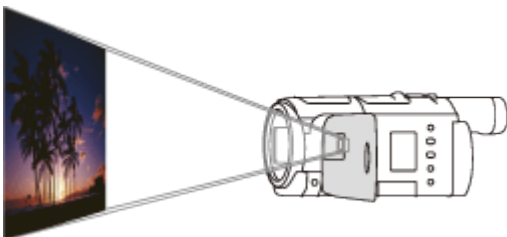

1. Face the projector lens towards a surface, such as a wall, and then press PROJECTOR.

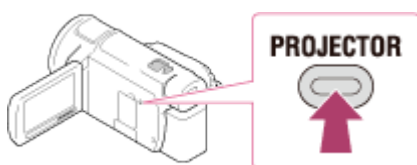

2. Select [Image Shot on This Device] on the LCD monitor.
3. Select [Project] on the LCD monitor.



- This screen appears the first time you use the built-in projector after this product is turned on.

4. Adjust the focus of the projected image using the PROJECTOR FOCUS lever.

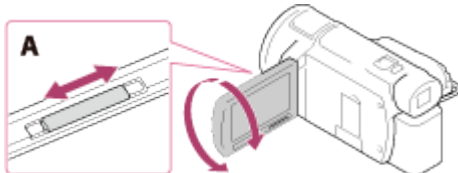

A: PROJECTOR FOCUS lever

- The projected image is larger when the distance between this product and the reflecting surface increase.
- It is recommended that you place this product further than 0.5 m (1.6 feet) away (approximate distance) from the surface that the images are to be projected onto.

5. Use the power zoom lever to move the selection frame that appears on the projection screen, and then press the PHOTO button.

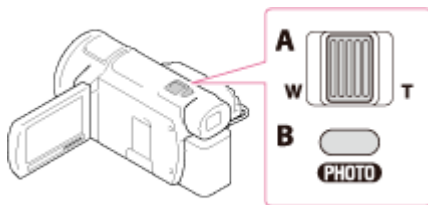

A: Power zoom lever

B: PHOTO button

- For details on playback, see “Playing movies and photos from the Event View screen.”
- Press PROJECTOR to turn off the projector.

[45] How to Use | Playback | Using the built-in projector

Using the projector for your computer or smartphone (models with the projector)

You can project images from a computer or smartphone using the built-in projector.

1. Connect the PROJECTOR IN jack of this product to an HDMI output jack of the other device using the HDMI cable (supplied).

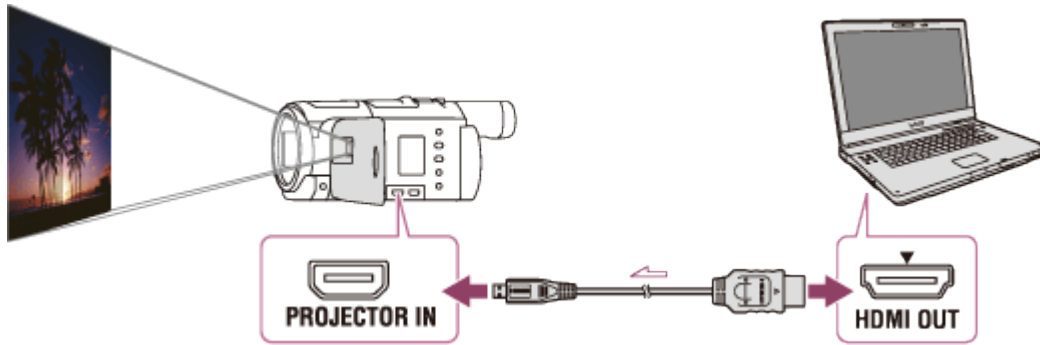

2. Face the projector lens towards a surface, such as a wall, and then press PROJECTOR.
3. Select [Image from External Device] on the LCD monitor.
4. Select [Project] on the LCD monitor.



- This screen appears the first time you use the built-in projector after this product is turned on.

5. Adjust the focus of the projected image using the PROJECTOR FOCUS lever.

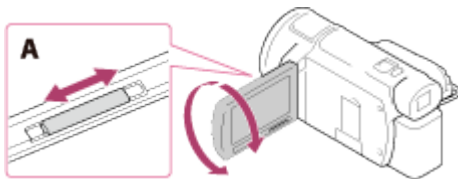

A: PROJECTOR FOCUS lever

- The further you position this product from the wall, the larger the screen will be.
- It is recommended that you place this product further than 0.5 m (1.6 feet) away (approximate distance) from the surface that the images are to be projected onto.

6. Select the image you want to view using your computer or smartphone.
 - To turn off the projector, press PROJECTOR.

Note

- You can only operate the PROJECTOR FOCUS lever while projecting images.

Hint

- If the terminal of the device connected is not compatible with the HDMI cable (supplied), use an HDMI plug adaptor (sold separately). For details, refer to the instruction manual supplied with the external media device.

[46] How to Use | Playback | Playing images on a 4K TV

Viewing images on a 4K TV

You can play images recorded in the movie format [4K] XAVC S 4K], in high definition image quality by connecting this product to a TV with an HDMI jack.

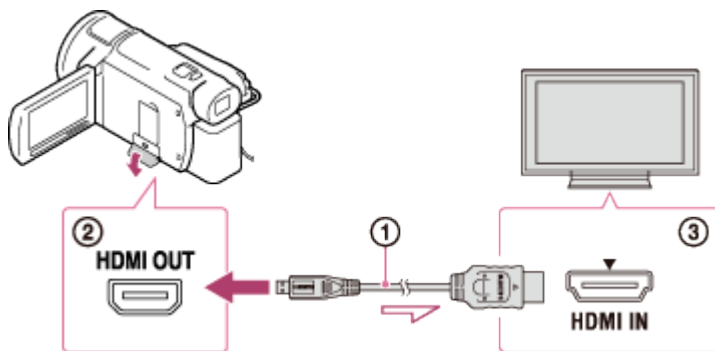

1. Switch the input on the TV to the connected jack.

- [MENU] - [Setup] - [↔ Connection] - [HDMI Resolution] - desired setting.

The playback image quality differs, depending on the [HDMI Resolution] setting value.

When [HDMI Resolution] is set to [Auto] or [2160p/1080p]

Playback image quality: 4K

When [HDMI Resolution] is set to [1080p], [1080i] or [720p]

Playback image quality: High definition image quality

2. Connect the HDMI cable (①) (supplied) to the HDMI OUT jack (②) on this product and to the HDMI input jack (③) on the TV.

Note

- Refer to the instruction manuals of the TV as well.
- Use the supplied AC Adaptor as the power source.

[47] How to Use | Playback | Playing images on a 4K TV

Enlarging a part of an XAVC S 4K movie on the screen during playback on TV (Trimming Playback)

You can enlarge a desired part of the image while a movie recorded in [4K] XAVC S 4K] format is being played back on TV. The enlarged part is played back in high definition image quality.

Photos are also trimmed and enlarged if you play back images in the event with both movies and photos.

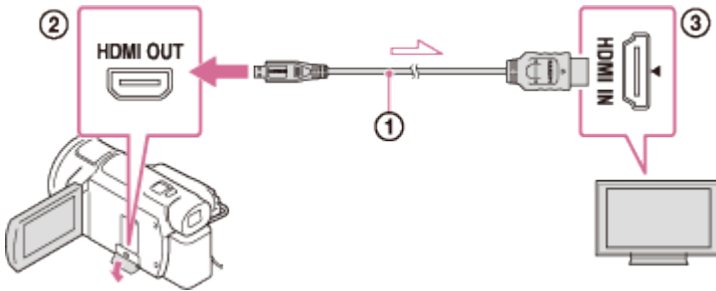

1. Switch the setting of this product according to the resolution of the connected 4K or high definition TV.

- [MENU] - [Setup] - [↔ Connection] - [HDMI Resolution] - desired setting.

HDMI Resolution:

4K TV: [Auto](*), [2160p/1080p] (*), [1080p], [1080i], [720p]

High definition TV: [Auto], [1080p], [1080i], [720p]

* A black screen appears for several seconds when the Trimming Playback function is turned on or off.



2. Connect the HDMI cable (①) (supplied) to the HDMI OUT jack (②) on this product and to the HDMI input jack (③) on the TV.
3. Play a desired movie saved on this product.
4. Touch the  (Trimming Playback) button on the LCD monitor of this product during movie playback.

The trimming playback frame appears.

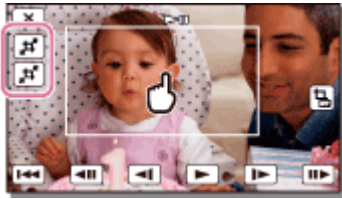

5. Touch the area you want to enlarge on the LCD monitor of this product.



The size of the trimmed image can be adjusted with the  (zoom in)/ (zoom out) buttons. You can also adjust the image size with the power zoom lever.

Note

- Enlarged images cannot be played back on the LCD monitor of this product.
- The  (Trimming Playback) button is not displayed on the LCD monitor of this product in the following cases:
 - When this product is connected to a TV that is not 4K or high definition
 - When a movie recorded in XAVC S HD or AVCHD format is played back
 - When only photos are played back
- The trimming playback frame may not appear if you touch the periphery of the playback screen.

[48] How to Use | Playback | Playing images on a high definition TV

Connecting this product to a high definition TV

You can play images recorded in XAVC S or AVCHD movie format, in high definition image quality by connecting this product to a TV with an HDMI jack.

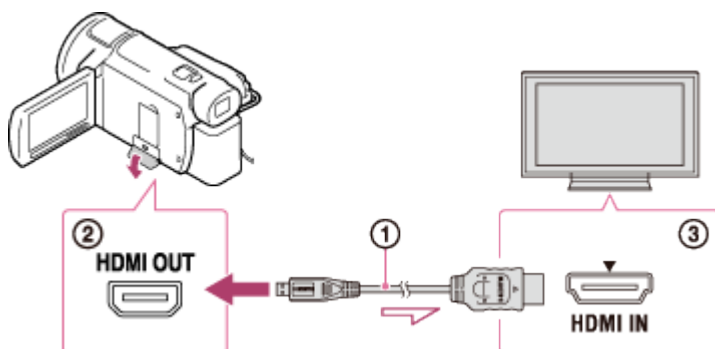

1. Switch the input on the TV to the connected jack.

- **[MENU]** - **[Setup]** - **[↔ Connection]** - **[HDMI Resolution]** - desired setting.

The playback image quality differs, depending on the **[HDMI Resolution]** setting value.

When the movie format is XAVC S 4K

HDMI Resolution:

[Auto], [1080p], [1080i], [720p]

Playback image quality:

High definition image quality

HDMI Resolution:

[2160p/1080p]

Playback image quality:

4K (You cannot view images on a high definition TV.)

When the movie format is XAVC S HD or AVCHD**HDMI Resolution:**

[Auto], [2160p/1080p], [1080p], [1080i], [720p]

Playback image quality:

High definition image quality, 4K(*)

* Signals output to the TV depend on the HDMI resolution setting on this product.

2. Connect the HDMI cable (①) (supplied) to the HDMI OUT jack (②) on this product and to the HDMI input jack (③) on the TV.
3. Play a movie or a photo on this product.



Note

- Refer to the instruction manuals of the TV as well.
- Use the supplied AC Adaptor as the power source.
- If the TV does not have an HDMI input jack, use an AV cable (sold separately). Images are output in standard definition.
- If you connect this product to the TV using more than one type of cable to output images, HDMI input takes priority on the TV.

[49] How to Use | Playback | Playing images on a high definition TV

Enjoying 5.1ch surround sound

You can record Dolby Digital 5.1ch surround sound with the built-in microphone. Realistic sound can be enjoyed when playing a movie on devices that support 5.1ch surround sound input.

- This function is available only when [ File Format] is set to [ AVCHD].



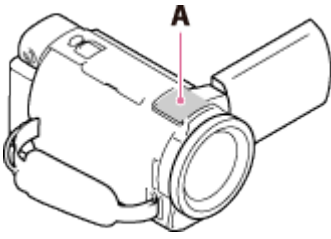

A: Built-in microphone

Note

- The sound of XAVC S and MP4 movies are recorded in 2ch sound.
- The built-in speaker does not output 5.1ch surround sound even if you play back a movie recorded with 5.1ch surround sound on this product.
- To enjoy the 5.1ch surround sound of the movies recorded in 5.1ch sound, you need a device compatible with 5.1ch surround.
- When you connect this product with the supplied HDMI cable, the sound of movies recorded in 5.1ch sound is automatically output in 5.1ch sound.

[50] How to Use | Playback | Playing images on a high definition TV

Using BRAVIA Sync

You can operate this product with the remote commander of your TV by connecting this product to a BRAVIA Sync compatible TV launched in 2008 or later with the HDMI cable.

You can operate the menu of this product by pressing the SYNC MENU button of the remote commander of your TV. You can display the LCD monitor of this product such as Event View, play selected movies or display selected photos by pressing up/down/left/right/enter buttons of the remote commander of your TV.

Note

- There may be some operations you cannot do with the remote commander.
- Set [CTRL FOR HDMI] to [On].
- Also set your TV accordingly. Refer to the instruction manual of the TV for details.
- The operation of BRAVIA Sync differs according to each model of BRAVIA. Refer to the instruction manual of your TV for details.
- If you turn off the TV, this product is turned off simultaneously.

[51] How to Use | Playback | Playing images on a high definition TV

On Photo TV HD

This product is compatible with the Photo TV HD standard. Photo TV HD allows for highly-detailed, photo-like depiction of subtle textures and colors. By connecting Sony's Photo TV HD-compatible devices using the HDMI cable(*), a whole new world of photos can be enjoyed in breathtaking HD quality.

* The TV will automatically switch to the appropriate mode when displaying photos.

[52] How to Use | Playback | Playing images on a high definition TV

On the HDMI cable

- Use the supplied HDMI cable or an HDMI cable with the HDMI logo.
 - Use an HDMI cable with an HDMI micro connector on one end (this product) and a plug suitable for connecting to a TV on the other end.
 - Copyright-protected images are not output from the HDMI OUT jack of this product.
 - Some TVs may not function correctly (e.g., no sound or image) with this connection.
 - Do not connect the HDMI OUT jack of this product to an external device HDMI OUT jack, as malfunction may result.
 - HDMI (High-Definition Multimedia Interface) is an interface to send both video/audio signals. The HDMI OUT jack outputs high quality images and digital audio.
-

[53] How to Use | Playback | Playing images on a high definition TV

Enlarging a part of an XAVC S 4K movie on the screen during playback on TV (Trimming Playback)

You can enlarge a desired part of the image while a movie recorded in [4K] XAVC S 4K] format is being played back on TV. The enlarged part is played back in high definition image quality.

Photos are also trimmed and enlarged if you play back images in the event with both movies and photos.

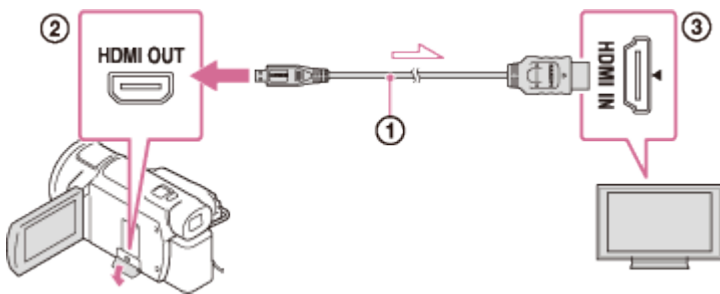

1. Switch the setting of this product according to the resolution of the connected 4K or high definition TV.

- [MENU] - [Setup] - [↔ Connection] - [HDMI Resolution] - desired setting.

HDMI Resolution:

4K TV: [Auto](*), [2160p/1080p] (*), [1080p], [1080i], [720p]

High definition TV: [Auto], [1080p], [1080i], [720p]

* A black screen appears for several seconds when the Trimming Playback function is turned on or off.

2. Connect the HDMI cable (①) (supplied) to the HDMI OUT jack (②) on this product and to the HDMI input jack (③) on the TV.

3. Play a desired movie saved on this product.



4. Touch the  (Trimming Playback) button on the LCD monitor of this product during movie playback.

The trimming playback frame appears.

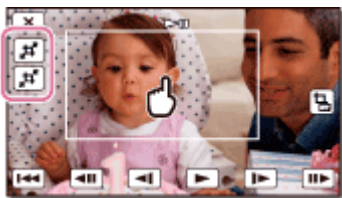

5. Touch the area you want to enlarge on the LCD monitor of this product.



The size of the trimmed image can be adjusted with the  (zoom in)/ (zoom out) buttons. You can also adjust the image size with the power zoom lever.

Note

- Enlarged images cannot be played back on the LCD monitor of this product.
- The  (Trimming Playback) button is not displayed on the LCD monitor of this product in the following cases:

- When this product is connected to a TV that is not 4K or high definition
- When a movie recorded in XAVC S HD or AVCHD format is played back
- When only photos are played back
- The trimming playback frame may not appear if you touch the periphery of the playback screen.

[54] How to Use | Playback | Playing images on a non-high-definition TV

Connecting this product to a non-high-definition TV

Play back images with this product connected to a TV by an AV cable (sold separately).

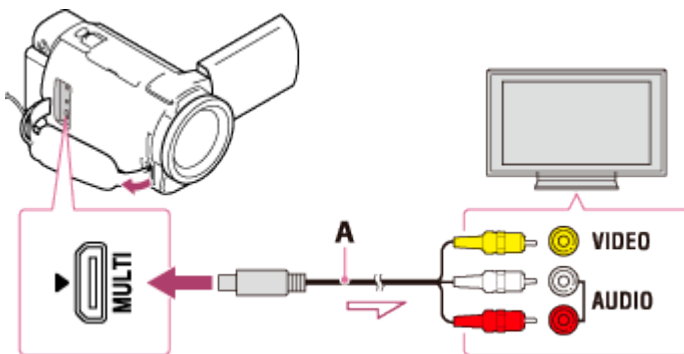

A: AV cable (sold separately)

1. Switch the input on the TV to the connected jack.
2. Connect the Multi/Micro USB terminal of this product and the VIDEO/AUDIO jack of your TV using an AV cable (sold separately).
3. Play a movie or a photo on this product.

Note

- Refer to the instruction manuals of the TV as well.
- Use the supplied AC Adaptor as the power source.

[55] How to Use | Saving images with an external device | How to save movies

Saving movies

How to save images in each format is as follows.

XAVC S 4K

How to save:

Save images on external media or on your computer using the PlayMemories Home software.

Saving format:

XAVC S 4K

XAVC S HD

How to save:

Save images on external media or on your computer using the PlayMemories Home software.

Saving format:

XAVC S HD

AVCHD

How to save:

Save images on external media or on your computer using the PlayMemories Home software.

Saving format:

AVCHD

Hint

- For the latest storage environment, visit the following website.
<http://www.sony.net/>
- You may also save by connecting a recorder with an AV cable (sold separately). The image quality will be standard definition.

To transfer images to your smartphone

Connect this product and your smartphone via Wi-Fi to transfer MP4 movies to the smartphone. MP4 is a movie format suitable for uploading to websites. This product records an MP4 movie simultaneously while recording a movie.

[56] How to Use | Saving images with an external device | Using the PlayMemories Home software

Using the PlayMemories Home software

You can import movies and still images to your computer to use them in a variety of ways. PlayMemories Home is necessary to import XAVC S or AVCHD movies to your computer.

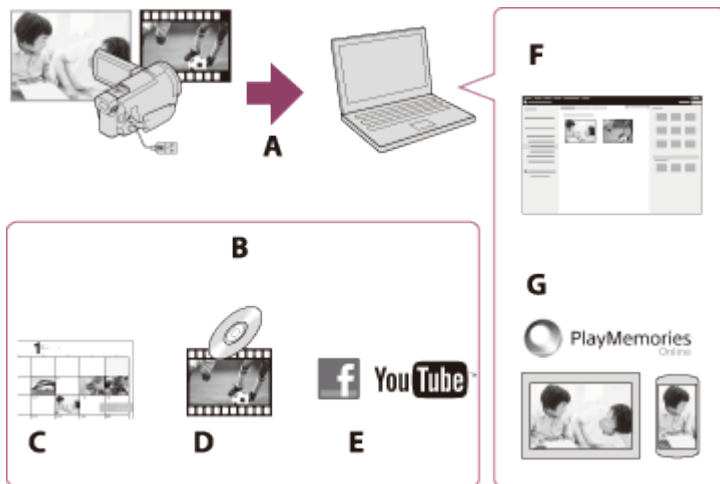

A: Import images from this product

B: The functions below are also available on a Windows PC

C: View images in a calendar

D: Create a movie disc

E: Upload images to online services

F: Play the imported images

G: Share images on PlayMemories Online

Installing the PlayMemories Home software in your computer

PlayMemories Home can be downloaded from the following URL.

www.sony.net/pm/

[57] How to Use | Saving images with an external device | Using the PlayMemories Home software

Checking the computer system

You can check the system requirements for software at the following URL.

www.sony.net/pcenv/

[58] How to Use | Saving images with an external device | Using the PlayMemories Home software

Installing the PlayMemories Home software in your

computer

Installing the PlayMemories Home software on your computer enables you to make use of your recorded images.

1. Access the following download page using an Internet browser on your computer to download the PlayMemories Home software.

www.sony.net/pm/

- Install the software according to the on-screen instructions.
- When the installation has completed, PlayMemories Home starts.
- If the PMB (Picture Motion Browser) software is installed on your computer, it will be overwritten by the PlayMemories Home software. Use PlayMemories Home, the successor software of PMB.

2. Connect this product and your computer with the Built-in USB Cable.

- If the PlayMemories Home software is already installed on your computer, connect this product to your computer. Functions that can be used with this product will then be available.

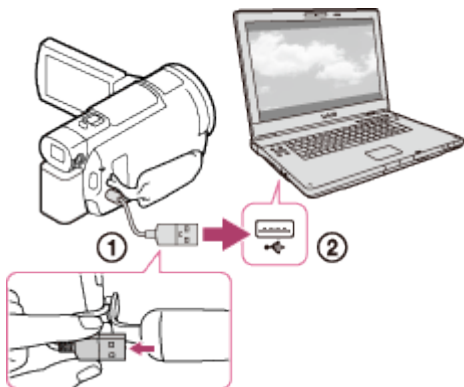

① Built-in USB Cable

② To the USB jack of your computer

Note



- Log on to your computer as an administrator.
- You may need to restart your computer. When prompted to restart, follow the on-screen instructions.
- Depending on the usage environment, DirectX can then be installed.

Hint

- For details on PlayMemories Home, refer to the help of PlayMemories Home.

Disconnecting this product from the computer

Disconnect this product from the computer connected with the Built-in USB Cable.

1. Click  in the task tray, and then click .
 - If you use a Windows Vista computer, click  in the task tray.
2. Click the message displayed on the computer screen.
3. Select - on the LCD monitor, and then disconnect the Built-in USB Cable.

Note

- If you use a Mac computer, drag and drop the memory card or the drive icon to the Trash before disconnecting. The connection with the computer is released.
- If you use a Windows 7 or Windows 8 computer, a disconnection icon may not be displayed. In this case, you can release the connection without performing the above operations.

About the dedicated software for this product

You can download the dedicated software from the Sony website.

Windows:

www.sony.co.jp/imsoft/Win/

Mac:

www.sony.co.jp/imsoft/Mac/

Note

- The software that can be used with this product will differ, depending on the countries/regions.

Creating a Blu-ray disc

You can create a Blu-ray disc with an AVCHD movie previously imported to a computer.

To create a Blu-ray disc, the “BD Add-on Software” must be installed.

<http://support.d-imaging.sony.co.jp/BDUW/>

- Your computer must support the creation of Blu-ray discs.
 - BD-R (unrewritable) and BD-RE (rewritable) media are available for creating Blu-ray discs. You cannot add contents to either type of disc after creating the disc.
 - To play back a Blu-ray disc that has been created with a movie that was recorded in [**HDI** AVCHD]/[60p Quality **PS**] (1080 60i-compatible device) / [50p Quality **PS**] (1080 50i-compatible device) image quality, you need a device that complies with the AVCHD Ver. 2.0 format.
 - You cannot save MP4 or XAVC S images onto a Blu-ray disc.
-

Notes on use of the external media

Read the precautions when using external media.

Note

- For this operation, you need the USB Adaptor Cable VMC-UAM2 (sold separately).
- Connect the AC Adaptor to this product, and then connect the AC Adaptor to a wall outlet (wall socket).
- Refer to the instruction manual supplied with the external media device.
- You may not be able to use external media devices with a code function.
- The file systems this product recognizes are FAT32/exFAT/NTFS. To use an external media device formatted with a file system that this product cannot recognize, format it on your computer, etc. in advance. Before formatting, make sure that you have no important data saved on the external media device as formatting will delete the data.
- Operation is not guaranteed with all devices satisfying the operating requirements.
- The number of scenes you can save on the external media device is as follows. However, even if the external media device has free space, you cannot save scenes exceeding the following number.
 - XAVC S movies: Max. 9,999

- AVCHD movies: Max. 3,999
- The total of photos and MP4 movies: Max. 40,000
- The number of scenes may be smaller depending on the type of images recorded.
- If this product does not recognize the external media device, try the following operations.
 - Reconnect the USB Adaptor Cable to this product.
 - If the external media device has the AC power cord (mains lead), connect it to a wall outlet (wall socket).
- You cannot copy images from an external media device to this product.

Devices that cannot be used as an external media device

- The following devices cannot be used as an external media device:
 - ordinary disc drive such as CD or DVD drive
 - media devices connected via a USB hub
 - media devices with a built-in USB hub
 - card reader

[63] How to Use | Saving images with an external device | Saving images on an external media device

Saving images on an external media device

Easily save movies and photos to external media devices such as an external hard disk drive.

1. Connect this product to the external media device using a USB Adaptor Cable (sold separately).

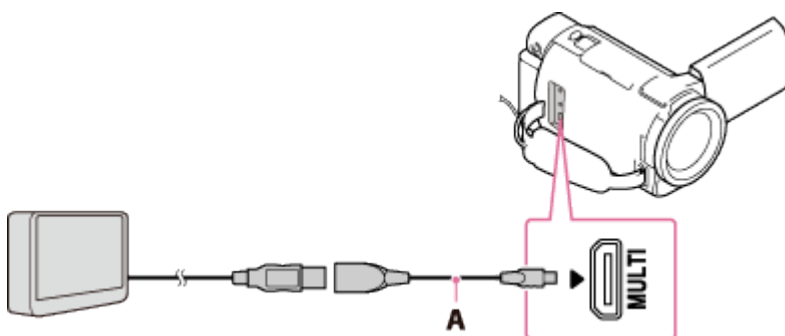

A: USB Adaptor Cable (sold separately)

- Make sure not to disconnect the Built-in USB Cable while [Preparing image database file. Please wait.] is displayed on the LCD monitor.
- If [Repair Img. DB F.] is displayed on the LCD monitor of this product, select .

2. Select [Copy.] on the LCD monitor of this product.

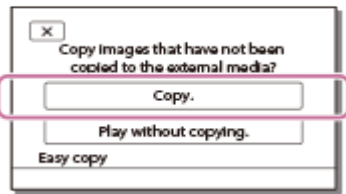

- Movies and photos that are stored on the recording media, and that have not yet been saved on to an external media device can be saved on the connected media device at this time.
- This operation is available only when there are newly recorded images in this product.
- To disconnect the external media device, select  while either Event View or Event Index is displayed.

[64] How to Use | Saving images with an external device | Saving images on an external media device

Saving the desired images in this product to the external media device

Save selected movies and photos on an external media device such as an external hard disk drive.

1. Connect this product to the external media device using a USB Adaptor Cable (sold separately).

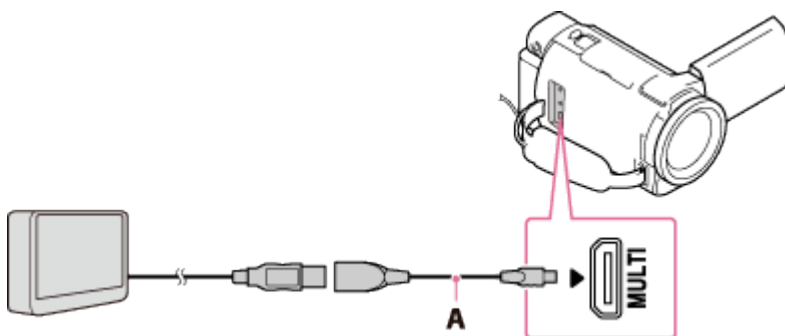

A: USB Adaptor Cable (sold separately)

- Make sure not to disconnect the Built-in USB Cable while [Preparing image database file. Please wait.] is displayed on the LCD monitor.
- If [Repair Img. DB F.] is displayed on the LCD monitor of this product, select .

2. Select [Play without copying.].

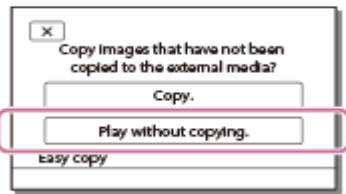

3. Select [MENU] - [Edit/Copy] - [Copy], and then follow the on-screen instructions to save images.

Hint

- If you want to copy images that have not yet been copied, select [MENU] - [Edit/Copy] - [Direct Copy] while this product is connected to the external media device.

[65] How to Use | Saving images with an external device | Saving images on an external media device

Playing back images in the external media device on this product

Play back images saved on an external media device on this product.

1. Connect this product to the external media device using a USB Adaptor Cable (sold separately).

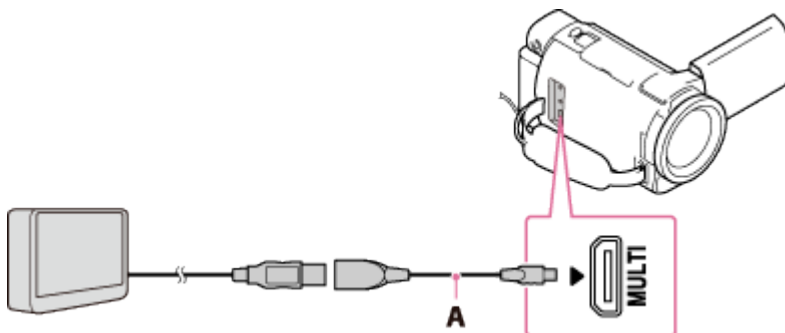

A: USB Adaptor Cable (sold separately)

2. Select [Play without copying.], and then select the image you want to view.

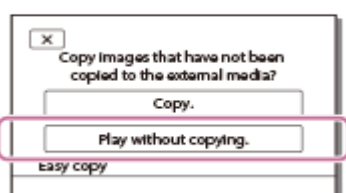

Hint

- You can also view images on a TV connected to this product.
- When an external media device is connected,  will appear on the Event View screen.
- To play back the images saved on an external media device using your computer, select the drive that represents the external media device on the PlayMemories Home software, and then play movies.

[66] How to Use | Saving images with an external device | Saving images on an external media device

Deleting images in the external media device

Delete images saved on an external media device.

1. Connect this product to the external media device using a USB Adaptor Cable (sold separately).

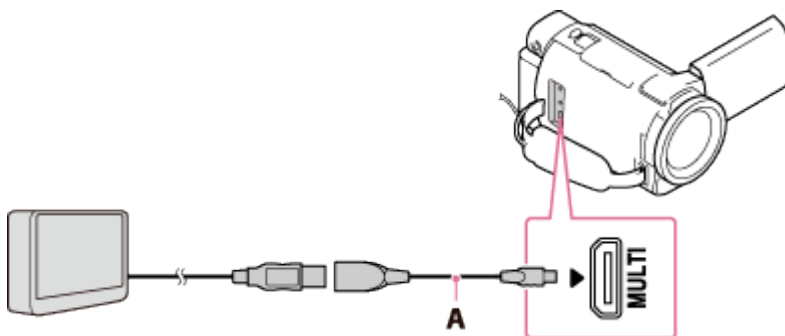

A: USB Adaptor Cable (sold separately)

2. Select [Play without copying.].

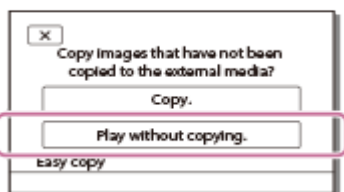

3. Select **MENU** - [Edit/Copy] - [Delete], and then follow on-screen instructions to delete images.

[67] How to Use | Saving images with an external device | Creating a disc with a recorder

Creating a disc with a recorder

You can copy images on this product onto a disc or video cassette. Connect this product to a disc recorder with an AV cable (sold separately).

Note

- Connect the AC Adaptor to this product, and then connect the AC Adaptor to a wall outlet (wall socket).
- Refer to the instruction manual supplied with the device connected.

1. Insert the recording medium in the recording device (a disc recorder, etc.).
 - If your recording device has an input selector, set it to the input mode.
2. Connect this product to the recording device with an AV cable (sold separately).
 - Connect this product to the input jacks of the recording device.

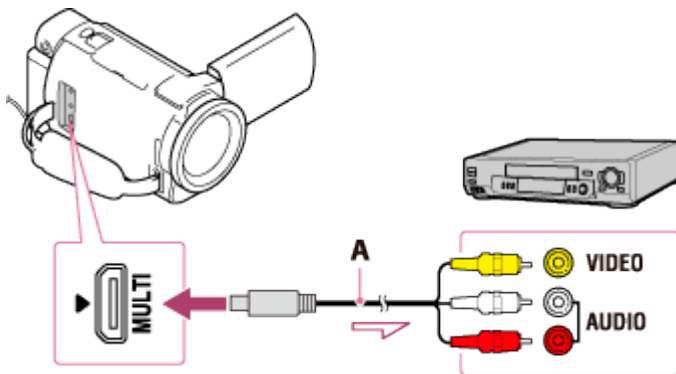

A: AV cable (sold separately)

3. Start playback on this product, and record it on the recording device.
4. When dubbing is finished, stop the recording device, and then this product.

Note

- You cannot copy images to recorders connected with the HDMI cable.
- Since copying is performed via analog data transfer, the image quality may deteriorate.
- Images will be copied with standard definition image quality.
- When you connect a monaural device, connect the yellow plug of an AV cable (sold separately) to the video input jack, and the white (left channel) or the red (right channel) plug to the audio input jack on the device.

Hint

- Change the [Data Code] setting if you want to copy the date and time and the camera setting data information.
- Set [TV Type] to [4:3] if the screen size of your display device such as TV is 4:3.

What you can do with the Wi-Fi function

Explains what you can do using the Wi-Fi function of this product.

Saving movies and photos to your computer

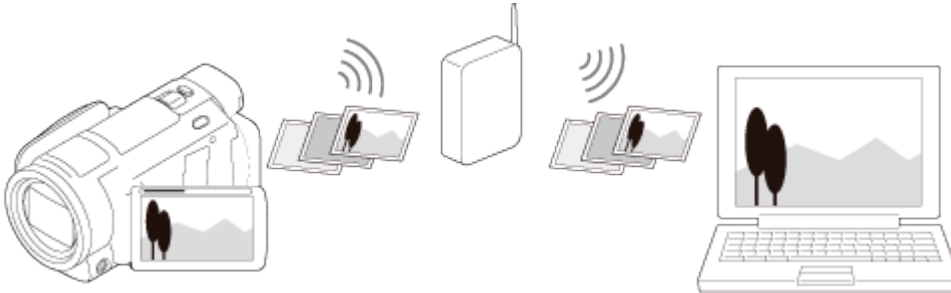

Transferring movies (MP4) and photos to your smartphone or tablet

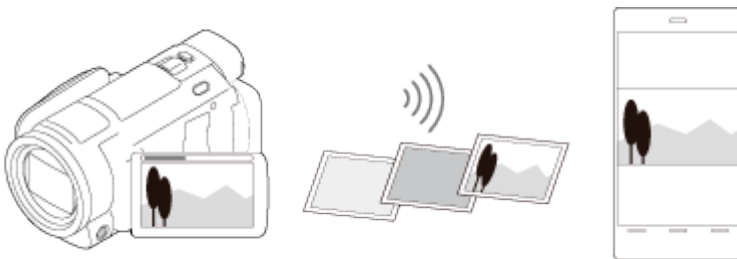

Using your smartphone or tablet as a wireless remote commander

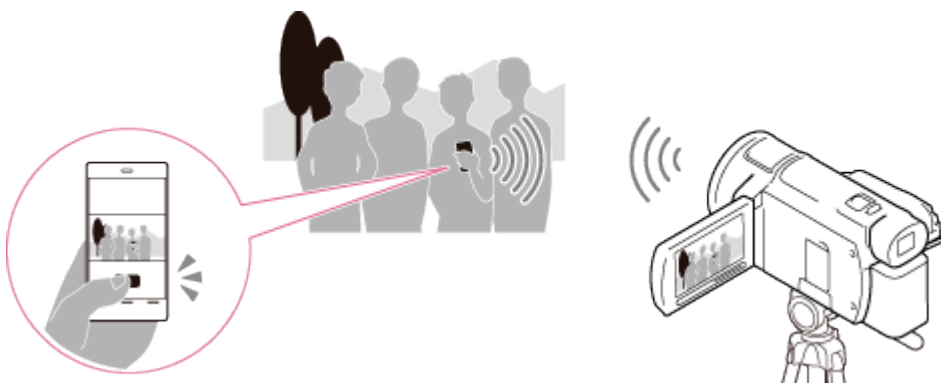

Playing images on a TV

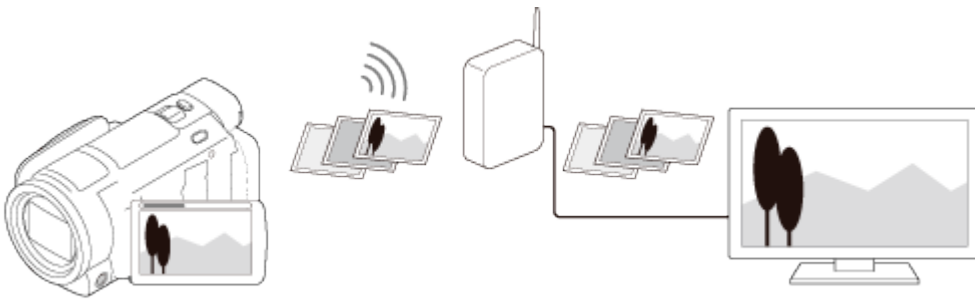

Live Streaming



Multi Camera Control



Note

- The Wi-Fi function of this product cannot be used by connecting to a public wireless network.
- PlayMemories Mobile is not guaranteed to work on all smartphones and tablets.

[69] How to Use | Using the Wi-Fi function | Controlling via a smartphone

Using your smartphone or tablet as a wireless remote commander

You can operate this product using your smartphone or tablet as a wireless remote commander.

1. Install PlayMemories Mobile on your smartphone.
 - If PlayMemories Mobile is already installed in your smartphone, update the software to the latest version.
2. On the LCD monitor of this product, select **MENU** - [Wireless] -  [Function] - [Ctrl with Smartphone].
 - The SSID and password are displayed on the LCD monitor of this product. This product is now ready to be operated using your smartphone.



A: SSID

B: Password

3. Start PlayMemories Mobile, then on the smartphone screen, select the SSID displayed on the LCD monitor of this product, and then enter the password displayed on the LCD monitor of this product.
 - Connect to this product using your smartphone.
4. Operate this product using your smartphone.

Note

- The photo size stored on the smartphone is [2M] except when the image size is [**4:3** S (VGA)].
- Movies are recorded on this product and are not stored on the smartphone.
- The operation methods and display screens for the application are subject to change without notice by future upgrades.
- This application is not guaranteed to work on all smartphones and tablets.

Hint

- For the latest supported OS, refer to the download page of PlayMemories Mobile.



commander using the NFC function (NFC one-touch remote)

You can operate this product using your NFC-enabled smartphone or tablet as a wireless remote commander.

Note

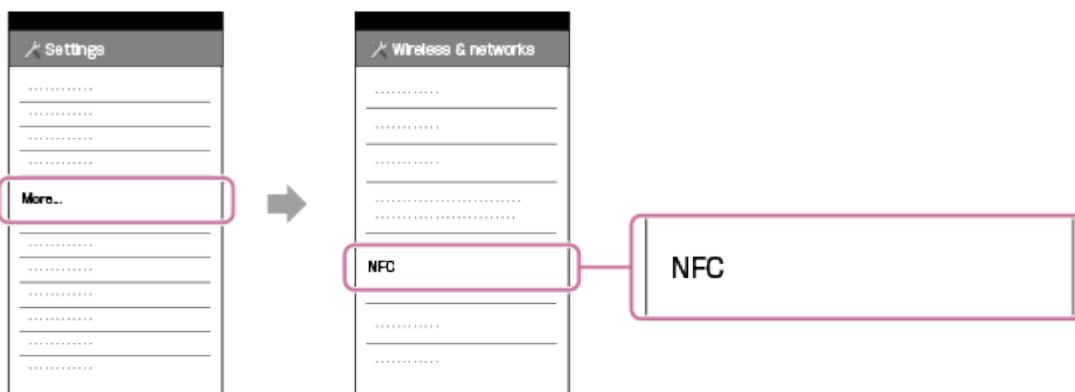
- Make sure that your smartphone is not in sleep mode and the screen is unlocked in advance.
1. Install PlayMemories Mobile on your smartphone.
 - If PlayMemories Mobile is already installed in your smartphone, update the software to the latest version.
 2. Select [Settings] on the smartphone, then select [More...] and place a checkmark next to [NFC].



3. Enter the recording mode, and then touch  (N mark) of this product to  (N mark) of your smartphone.

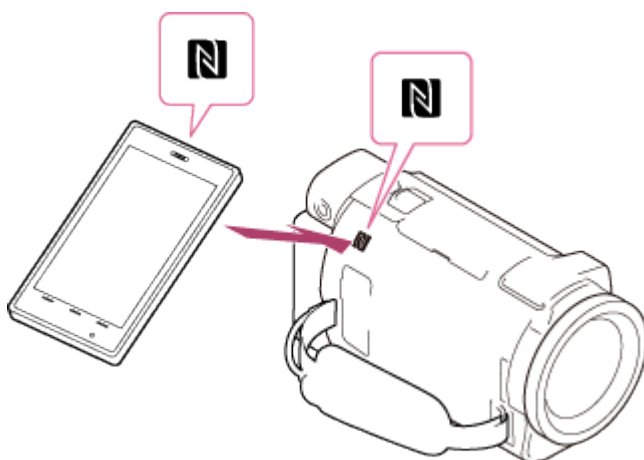

- Make sure that  (N mark) is displayed on the LCD monitor of this product.
- Hold this product and your smartphone together and keep them still for about 1-2 seconds until PlayMemories Mobile starts up on your smartphone.

4. Operate this product using your smartphone.

Note

- The photo size stored on the smartphone is [2M] except when the image size is [4:3 S (VGA)].
- Movies are recorded on this product and are not stored on the smartphone.
- The operation methods and display screens for the application are subject to change without notice by future upgrades.
- This application is not guaranteed to work on all smartphones and tablets.
- If the connections is not made successfully, try the procedures shown in “Connecting to an Android smartphone or tablet.”



Hint

- For the latest supported OS, refer to the download page of PlayMemories Mobile.

[71] How to Use | Using the Wi-Fi function | Transferring images to a smartphone

Transferring movies (MP4) and photos to your smartphone or tablet

Transfer images to your smartphone or tablet.

1. Install PlayMemories Mobile on your smartphone.
 - If PlayMemories Mobile is already installed in your smartphone, update the software to the latest version.
2. Press the  button on this product to enter the playback mode.
3. On the LCD monitor of this product, select **MENU** - [Wireless] -  Function] - [Send to Smartphone] - [Select on This Device].
 - If you select [Select on Smartphone], all images stored in the internal memory of this product (models with the internal memory) or on the memory card are displayed on the smartphone screen.
4. Select the type of image you want to transfer.



5. Select the image you want to transfer, and add ✓ mark, and then select - .

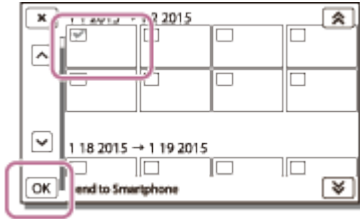

- The SSID and a password are displayed on the LCD monitor of this product. This product is now ready to be connected from your smartphone.



A: SSID

B: Password

6. Start PlayMemories Mobile, then on the smartphone screen, select the SSID displayed on the LCD monitor of this product, and then enter the password displayed on the LCD monitor of this product.
7. The images are transferred from this product to the smartphone.
- Transferred images will be stored in Gallery/Album on an Android smartphone/tablet or Album on an iPhone/iPad.

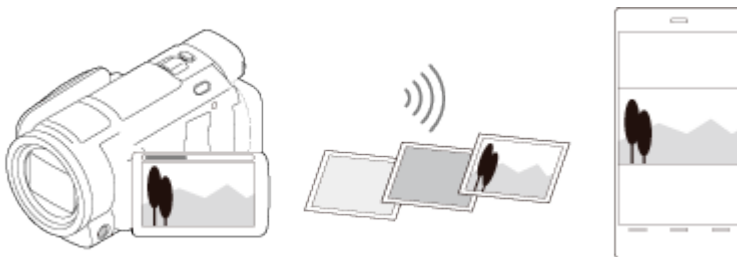

Note

- You cannot transfer XAVC S movies or AVCHD movies.
- [Send to Smartphone] is not available when MP4 movies or still images have not been saved on this product.
- To select MP4 movies when playing back a movie, see "Playing MP4 movies (HD movie) (switching the movie format)" and switch the movie format.
- If you want to import images recorded on a memory card, insert the memory card to this product, and then select the memory card in [Media Select] (models with the internal memory).
- This application is not guaranteed to work on all smartphones and tablets.

Hint

- For the latest supported OS, refer to the download page of PlayMemories Mobile.

[72] How to Use | Using the Wi-Fi function | Transferring images to a smartphone



Transferring movies (MP4) and photos to your smartphone or tablet using the NFC function (NFC one-touch sharing)

Transfer images to your NFC-enabled Android smartphone or tablet.

Note

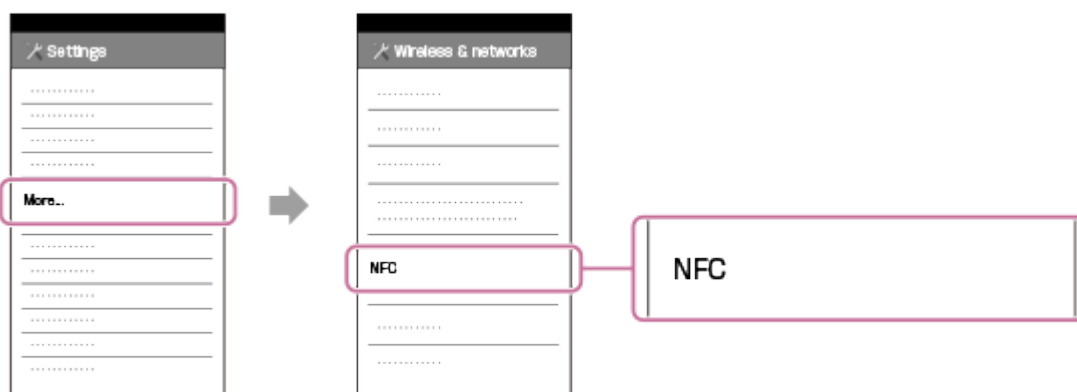
- Make sure that your smartphone is not in sleep mode and the screen is unlocked in advance.
1. Install PlayMemories Mobile on your smartphone.
 - If PlayMemories Mobile is already installed in your smartphone, update the software to the latest version.
 2. Select [Settings] on the smartphone, then select [More...] and place a checkmark next to [NFC].



3. Press the  button on this product to enter the playback mode, and then display the image you want to transfer on the LCD monitor of this product.
4. Touch  (N mark) of this product to  (N mark) of your smartphone.

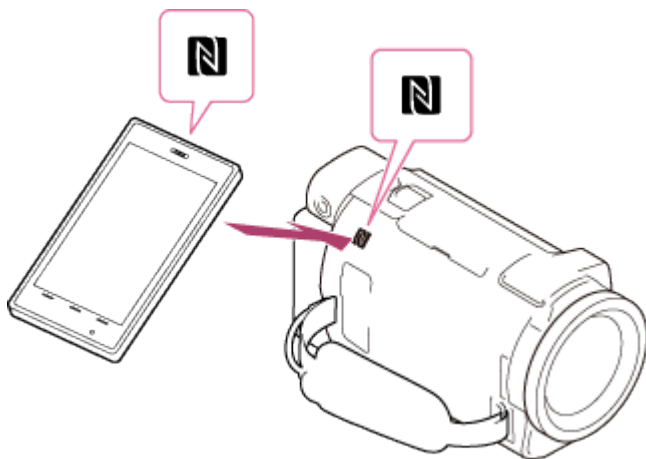

- Hold this product and your smartphone together and keep them still for about 1-2 seconds until PlayMemories Mobile starts up on your smartphone.
- Make sure that **N** (N mark) is displayed on the LCD monitor of this product.

5. The images are transferred from this product to the smartphone.

- Transferred images will be stored in Gallery/Album on an Android smartphone/tablet or Album on an iPhone/iPad.



Note

- You cannot transfer XAVC S movies or AVCHD movies.
- [Send to Smartphone] is not available when MP4 movies or still images have not been saved on this product.
- Select “Switch Movie Format button” in “Playing MP4 movies (HD movie) (switching the movie format)”, to select MP4 movies when you play back movies.
- If you want to import images recorded on a memory card, insert the memory card to this product, and then select the memory card in [Media Select] (models with the internal memory).
- This application is not guaranteed to work on all smartphones and tablets.
- If the connections is not made successfully, try the procedures shown in “Connecting to an Android smartphone or tablet.”

Hint

- For the latest supported OS, refer to the download page of PlayMemories Mobile.

Send to Computer

You can transfer and save movies and photos to your computer.

1. Install the software on your computer.

For Windows: PlayMemories Home

<http://www.sony.net/pm/>

For Mac: Wireless Auto Import



<http://www.sony.co.jp/imsoft/Mac/>

- If connecting this product to your computer for the first time after installing the software, set [USB Connect Setting] to [Mass Storage] on this product, and then connect this product to your computer with the Built-in USB Cable.
- If the software is already installed in your computer, update the software to the latest version.

2. Connect this product to the wireless network access point.

- If your access point does not support the WPS push button, refer to “Access point settings”.
- If your access point supports the WPS push button, refer to “WPS Push”.
- Settings for steps 1 and 2 are required only the first time.

3. Press the  button on this product to enter the playback mode.

4. On the LCD monitor of this product, select  - [Wireless] -  [Function] - [Send to Computer].

- Images are automatically transferred to and saved on the computer.
- Only newly recorded images are transferred.



Note

- Do not close the LCD monitor while transferring files. Transferring will be interrupted.
- You must turn on the computer to execute [Send to Computer].
- Depending on the settings of the application on the computer, this product may turn off automatically after saving images.
- If you want to import images recorded on a memory card, insert the memory card to this product in advance (models with the internal memory).
- Importing movies and multiple still images may take time.



Playing images on a TV (View on TV)

You can view images on your TV connected to the network by transferring images from this product without connecting this product and TV with a cable.

Operations may be required on your TV before playing depending on the TV you use. Refer to the instruction manuals of the TV as well.

1. Connect this product to a wireless network access point.
 - If your access point does not support the WPS push button, refer to “Access point settings”.
 - If your access point supports the WPS push button, refer to “WPS Push”.
 - Step 1 can be skipped from the second time.
2. Press the  button on this product to enter the playback mode.
3. Select  - [Wireless] -  Function] - [View on TV] - the type of image you want to transfer.
4. Play a movie or a photo on the TV.

Note

- This function is not available for [ XAVC S 4K] (models with the 4K functionality) and [ XAVC S HD] movies.
- This function is available with the DLNA player compatible TVs.
- You can view images only on TVs that are compatible with the network function (including wired network).
- It may take time until the images are played on the TV.
- This function is not available when using an access point without a security setting (WEP/WPA/WPA2) to protect from prying eyes.
- Select the access point you registered with this product when connecting your TV.
- To enjoy viewing movies comfortably, use a wired network connection for your TV. Depending on the wireless network environment, movies may not be played smoothly.
- Depending on the settings of the recorded movie, it may not play smoothly.

Connecting to an Android smartphone or tablet

Shows how to connect this product to your Android smartphone or tablet. Display the SSID and password in advance by selecting [Send to Smartphone] or [Ctrl with Smartphone] on this product.

1. Start up PlayMemories Mobile on the smartphone.



2. Select the SSID displayed on this product.



3. Enter the password displayed on this product.



Shows how to connect this product to your iPhone or iPad. Display the SSID and password in advance by selecting [Send to Smartphone] or [Ctrl with Smartphone] on this product.

1. Open the settings menu.



2. Select Wi-Fi.

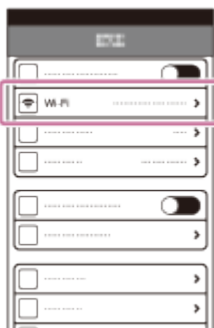

3. Select the SSID displayed on this product.



4. Enter the password displayed on this product.



5. Confirm that the SSID displayed on this product is selected.

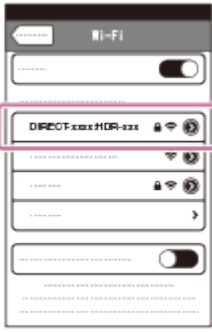

6. Go back to Home and start up PlayMemories Mobile.

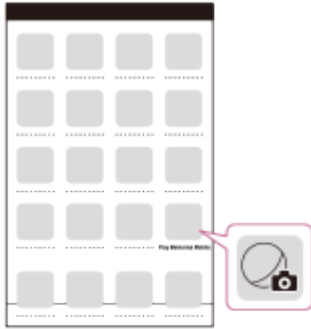



[77] How to Use | Using the Wi-Fi function | Connecting a smartphone

Connecting to an NFC-enabled smartphone or tablet

You can easily connect this product to your NFC-enabled Android smartphone or tablet.

Note

- Make sure that your smartphone is not in sleep mode and the screen is unlocked in advance.
1. Touch  (N mark) of this product to  (N mark) of your smartphone.
 - Make sure that  (N mark) is displayed on the LCD monitor of this product.
 - Hold this product and your smartphone together and keep them still for about 1-2 seconds until PlayMemories Mobile starts up on your smartphone.

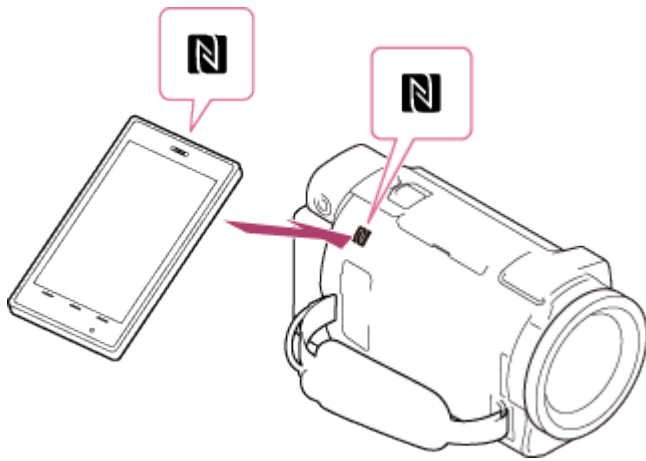

What you can do with the NFC connection

Operations available when you touch this product to an NFC-enabled smartphone differs depending on the status of this product.

When this product is in movie/photo recording mode

[Ctrl with Smartphone] starts up.

When images are being played back on this product

[Send to Smartphone] starts up and images being played back are transferred.

Note

- To use the one-touch functions of this product, an NFC-enabled smartphone or tablet is required.
- NFC (Near Field Communication) is an international standard for short-range wireless communication technology.
- If the connection is not made successfully, try the procedures shown in “Connecting to an Android smartphone or tablet.”

[78] How to Use | Using the Wi-Fi function | Installing PlayMemories Mobile

About the PlayMemories Mobile software

To perform operations such as [Ctrl with Smartphone] and [Send to Smartphone], the PlayMemories Mobile application for smartphone is required. Install the application from the applications store for your smartphone.

If PlayMemories Mobile is already installed in your smartphone, update the application to the latest version.

For details on PlayMemories Mobile, visit the PlayMemories Mobile support page (www.sony.net/pmm/).

About Live Streaming

Live Streaming is a function to stream real-time video to a video sharing site such as USTREAM, and can be accomplished by using this product with a Wi-Fi router or smartphone capable of tethering.

You can also send messages to your registered SNS (Facebook, Twitter, etc.) to announce that you have started Live Streaming of video.*

* Registration to a video sharing site or SNS is required.

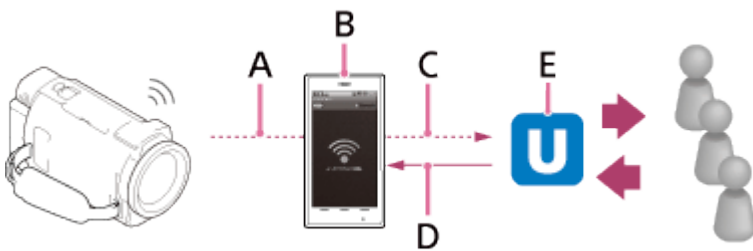

A: Wi-Fi

B: Tethering mode

C: 3G/LTE

D: Comments from viewers

E: Video sharing site such as USTREAM

To perform Live Streaming, the following preparations are required.

Set the following settings for streaming in the Live Streaming settings of this product.

- User registration to video sharing site (such as USTREAM)
- A smartphone (capable of tethering) or a Wi-Fi network environment
- Live Streaming feature is dependent upon the Third Party Internet Provider's service and terms in your region. The feature may not be available due to your region's broadband and internet service restriction.
- For the tethering settings of your smartphone or the Wi-Fi network settings of your router, refer to the instructions manual of your smartphone or your Wi-Fi router. For more details about the Wi-Fi network settings, consult the network service provider.

Preparing Live Streaming

Configure the network settings on this product and register the video sharing site account and SNS settings using the dedicated application "PlayMemories Home" installed on your computer, in advance.

You can download "PlayMemories Home" from the following support site.

www.sony.net/pm/

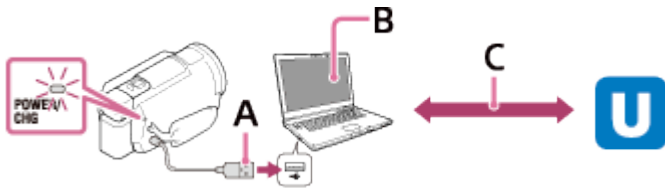

A: USB

Connect to your computer with Mass Storage

B: PlayMemories Home

Start "PlayMemories Home" by selecting it from Tools in the MENU bar.

For details, see <http://www.sony.net/guide/nst/>.

C: Obtaining OAuth authenticated channel ID

Log in to USTREAM and perform authentication using "PlayMemories Home."

Network settings on the computer

Check the following settings before connecting this product to your computer.

- Select **MENU** - [Setup] - [↔ Connection] - [USB Connect Setting], and [Mass Storage] is selected.
- Select **MENU** - [Setup] - [↔ Connection] - [USB LUN Setting] and confirm that [Multi] is selected.

You can set the following with the live streaming settings of "PlayMemories Home."

Select "PlayMemories Home" - [Tools] - [Network Settings Tool].

For details, see <http://www.sony.net/guide/nst/>.

- Streaming settings: You can set the streaming method and information of videos.
 - Streaming site, channel, image quality, and saving settings of the streaming site
 - Title and description of streaming video
- SNS settings: By configuring this setting, you can post a comment through social networking services when starting streaming video.
 - Connection settings for Twitter or Facebook
 - Comments you post

Live streaming settings of this product

Connect this product to the access point. For details, see "Access point settings" or "WPS Push".

Note

- Your personal information (information required when logging in to USTREAM, Twitter or Facebook) is set in this product. Be sure to reset the settings of this product when you transfer or dispose of it.

Hint

- USTREAM is a video sharing site through which you can stream and view videos with the Live Streaming function of this product. For details of USTREAM, see the following site. (<http://www.ustream.tv/>).

[81] How to Use | Using the Wi-Fi function | Live Streaming

Performing Live Streaming



You can start Live Streaming after the preparation is complete.

When Live Streaming for the first time, it is recommended that you rehearse streaming in a prepared environment after setting up with a “PlayMemories Home” on your computer in advance.

Set your smartphone to tethering mode or turn on your Wi-Fi router before performing Live Streaming.

1. On the movie/photo recording screen, select **MENU** - [Wireless] -  Function] - [Live Streaming].
2. Press the START/STOP button to start streaming.
 - [Connecting...] and the registered SSID are displayed during streaming preparation then **LIVE** is displayed when Live Streaming starts.
3. Press the START/STOP button again to stop streaming.
 - **LIVE** is flashing until Live Streaming finished.

Note

- For some languages, the onscreen-displays might change to English while using the Live Streaming function.
- The frame rate of the movie that is Live Streaming is fixed to 30p or 60i.
- There may be time lag of 10 - 30 seconds between the start of Live Streaming on this product and video streaming on the video sharing site.
- The following are not available during Live Streaming
 -  (My Voice Canceling)
 -  Fader
 - Dual Video REC

Hint

- You can record a movie that is Live Streaming into the memory of this product. The movie is recorded either in the internal memory (internal memory equipped model only) or the memory card based on the setting.
- If the internal memory (internal memory equipped model only) or the memory card becomes full, recording stops automatically without stopping streaming.
- When you want to perform only Live Streaming without recording a movie into the internal memory (models with the internal memory) or a memory card, select [Wireless] -  [Setting] - [Vid REC during strm.] - [Off].

[82] How to Use | Using the Wi-Fi function | Live Streaming

Restrictions for Live Streaming

There are restrictions when performing Live Streaming.

Restrictions for USTREAM

- There are some restrictions for video streaming on USTREAM. For details, see the USTREAM site.

Network connection

- Use a smartphone capable of tethering or Wi-Fi router for Live Streaming. However, proper operation with all smartphones or Wi-Fi routers is not guaranteed. Public wireless LANs cannot be used as connections for Live Streaming.

Simultaneous Live Streaming with multiple cameras

- You cannot live stream videos simultaneously using the same account on more than 1 camera. You need to connect using another account.

Effects due to wireless communication conditions

- When connected using the tethering function of a smartphone or via a Wi-Fi router, images and sounds may be interrupted, or the communication may be cut off due to wireless communication conditions.

Connection for Live Streaming

- The communication time you can use for Live Streaming is limited according to the contract of your smartphone or Wi-Fi router. Confirm it in advance.

Continuous streaming time

- Continuous Live Streaming using this product is limited to about 13 hours.

Restrictions of network connections

- In some countries, you cannot connect to Live Streaming sites. Use this function in accordance with the laws of that country.

[83] How to Use | Using the Wi-Fi function | Controlling other cameras through this product

Shooting with this product and other cameras with Multi Camera Control

This function enables you to record images using this product and several cameras simultaneously by connecting them to Wi-Fi. You can also perform some basic operations of the connected cameras, such as configuring the settings, from this product. Recorded images can be edited with PlayMemories Home, including editing such as creating a PinP (Picture in Picture; an image with an inset window of another image) clip.



1. Connect this product and other cameras via Wi-Fi.
 - For details on the connection method, see “[Connecting this product to one camera with Multi Camera Control \(Single Connection\)](#)” and “[Connecting this product to more than one camera with Multi Camera Control \(Multi Connection\)](#).”



A: This product



B: Shooting modes ( Movie、  Still Image、  Interval Shoot、  Audio) of connected cameras

C: Various settings of connected cameras

2. Select the displayed icons such as  ,  or those in B in the figure above, select  , then configure the desired settings for each connected camera.
 - Among the menu items described in “Menu items that you can set” below, only the items that can be configured on the connected camera will be displayed.
 - The status of the selected camera can be checked on the LCD monitor of this

product.

3. Press the START/STOP button of this product.

- All devices are connected to this product will start recording.  is displayed on the icons of this product and the cameras that are recording movies.
- By selecting ,  or icons displayed in B in the figure above during shooting, you can check the image being recorded with the connected camera on the LCD monitor of this product.
- PHOTO or the zoom lever can be used even during shooting with Multi Camera Control.

4. Press the START/STOP button of this product.

- Recording ends.

Menu items that you can set

[Connect Device Swt] (displayed when one camera is connected)

Disconnects the currently connected camera and selects another device.

[Connect Device Reg] (displayed when several cameras are connected)

Registers cameras that have not been registered before.

[Shooting Mode]

Selects the shooting mode of the connected camera (for one camera when only one camera is connected and for all cameras when several cameras are connected).

[ Movie]: Records movies.

[ Still Image]: Records photos.

[ Interval Shoot]: Continues to record photos at regular intervals.

[ Audio]: Records sound only

[Shooting Settings]

Movie shooting settings (displayed when one camera is connected and the Shooting Mode is set to [Movie])

You can configure settings for movie shooting of the connected camera.

[Recording Mode]: Sets the movie image quality

[ SteadyShot]: Sets to activate the camera-shake reduction.

[ Shooting Angle]: Sets the shooting angle.

[Flip]: Sets whether to record images upside down.

[ File Format]: Sets the file format for recording movies

Still image shooting settings (displayed when one camera is connected and the Shooting Mode is set to [Still Image])

You can configure settings for photo shooting of the connected camera.

[Flip]: Sets whether to record images upside down.

[ Drive Mode]: Sets the continuous shooting method.

[ Shooting Interval]: Sets the interval of continuous shooting.

[ Self-Timer]: Sets self-timer.

Interval shooting settings (displayed when one camera is connected and the Shooting Mode is set to [Interval Shoot])

You can set the interval period for consecutive recordings of the interval photo recording

[Flip]: Sets whether to record images upside down.

[ Shooting Interval]: Sets the interval period for in how many seconds a photo is recorded.



Connecting device settings (displayed when one camera is connected)



You can configure the settings of the connected camera.



[Beep]: Sets whether to emit operation beeps.

Note



- Icons displayed differ according to the status of the connected cameras.
- Depending on the connected camera, its LCD monitor may turn off, or its operations may become unavailable.
- Menu items that can be configured on the connected camera will be displayed.
- Even if this product is turned off while the connected camera is shooting, the connected camera continues shooting.
- On both this product and the connected camera,  (View Images) or [MODE] cannot be selected during connection.
- Images recorded on the connected camera cannot be output from the audio output or HDMI output terminal.
- If the connection between this product and other cameras is disconnected during shooting, the connection is re-established automatically. Even if you finish shooting on this product before the reconnection is complete, the reconnected camera will continue shooting.
- Photo shooting mode can be selected on the connected camera, but not on this product.
- When PHOTO of this product is pressed, other connected cameras that are set to photo shooting mode will record a photo. You cannot record photos with this product.
- This function works via a Wi-Fi network; therefore there is a slight time difference between the moment this product starts/stops movie recording and the moment the connected devices start/stop movie recording.
- The upper limit of the recording time for this function is as follows.

When [ File Format] is set to [ XAVC S 4K], [ Frame Rate] is set to [30p] : 3 h 23 m

When [ File Format] is set to [ XAVC S HD], [ Frame Rate] is set to [30p] : 6 h 31 m

When [ File Format] is set to [ XAVC S HD], [ Frame Rate] is set to [60p] : 3 h 15 m



Hint

- The status of the connected camera is displayed on the LCD monitor of this product in real-time.
- You can operate zoom of the camera selected with ,  or icons displayed in (B) using the zoom lever of this product.

[84] How to Use | Using the Wi-Fi function | Controlling other cameras through this product

Connecting this product to one camera with Multi Camera Control (Single Connection)

You can connect this product with another camera via Wi-Fi. By connecting via Wi-Fi, you can control another camera with this product.



1. Turn on the power of the camera you want to connect and set it in a state ready for Wi-Fi connection.
 - For details on the operation, refer to the instructions manual of the camera.
2. Turn on this product, then select **MENU** - [Wireless] -  Setting] - [Multi Camera Ctrl Set] - [Single Connection].
3. Select **MENU** - [Wireless] -  Function] - [Multi Camera Control].
 - A list of SSIDs that can be connected is displayed.
4. Select the SSID of the camera you want to connect.
 - The registration is complete.

Note

- This product displays a character string deleting "DIRECT-" from the SSID of the camera you want to connect to as the SSID of the camera.
- When using the Multi Camera Control Function on this product, this product should only be connected to the camera you want to connect to via Wi-Fi and not other Wi-Fi access points. If you choose to connect this product to other Wi-Fi access points, then you do so at your own risk. This product may be subject to unauthorized access and any content communicated may be at risk of interception.

Connecting this product to more than one camera with Multi Camera Control (Multi Connection)

You can connect this product with other cameras via Wi-Fi. By connecting via Wi-Fi, you can control other cameras with this product.

1. Turn on the power of the cameras you want to connect and set them in a state ready for Wi-Fi connection.
 - For details on the operation, refer to the instructions manual of the cameras.
2. Turn on this product, then select **MENU** - [Wireless] -  [Setting] - [Multi Camera Ctrl Set] - [Multi Connection].
3. Select **MENU** - [Wireless] -  [Function] - [Multi Camera Control].
4. Select .
5. Select [Connect Device Reg].
 - This product enters registration waiting status (registration waiting status ends in about 2 minutes).
6. Perform connecting operation on the camera you want to connect with this product.
 - For details on the Wi-Fi connection, refer to the instruction manuals of the cameras.
7. Select [OK] when it is displayed on the screen of the product to finish the registration.
8. Repeat steps 4 to 7 for each camera you want to connect.

Note

- A maximum of five cameras (compatible with Multi Camera Control) can be registered to this product.
- The operations in step 4 - 8 are necessary only for the first-time registration.
- Change the settings of the camera you want to connect to before the registration waiting status of this product ends.
- This product displays a character string deleting "DIRECT-" from the SSID of the camera you want to connect to as the SSID of the camera.

Editing images recorded with several cameras

By importing images recorded with several cameras to a computer, you can edit PinP (Picture in Picture; an image with an inset window of another image) clips, etc.

Installing PlayMemories Home

To edit PinP clips, etc., you need to install PlayMemories Home on your computer. PlayMemories Home can be installed from the following URL.

<http://www.sony.net/pm/>

Setting up menu items

This product has various menu items under each of 7 menu categories.

1. Select **MENU**.



2. Select a category.

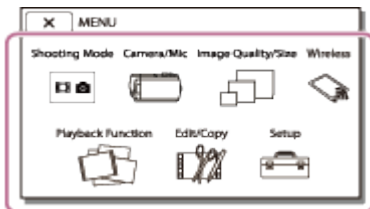

3. Select your desired menu item.



Note

- Select  to finish setting the menu or to return to the previous screen.

To find a menu item quickly

The [Camera/Mic], [Wireless] and [Setup] menus have sub-categories. Select the sub-category icon so that you can select your desired menu item.

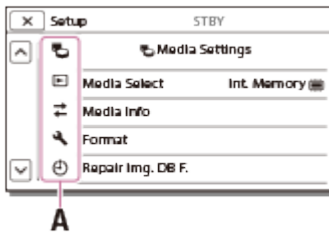

A: Sub-category icons

When you cannot select a menu item

Some menu items or settings are not available, depending on the settings of this product. When you select grayed out menu items or settings, this product displays the reason why you cannot select the menu item.

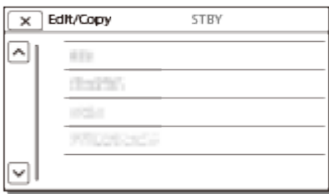

[88] How to Use | Menu operations | Using menu items

How to use the keyboard

A keyboard is displayed on the LCD monitor when text needs to be entered.

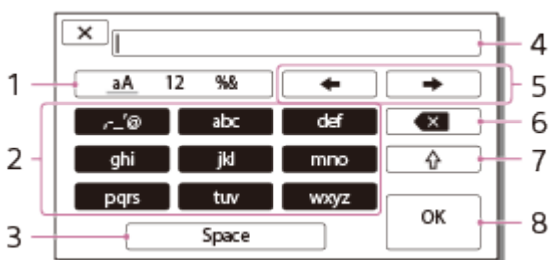

1. Switch character types.

Each time you touch the key, the type of character to be input switches between letters,

numerals and symbols.

2. Keyboard

Each time you touch the key, the displayed character switches between the choices available.

For example: If you want to enter "abd"

Select [abc], touching it once to display "a" touch  - select [abc], touching it twice to display "b" - select [def] touching it once to display "d."

3. Space

Enters a space.

4. Input box

The characters you entered are displayed. ◀ indicates the limit to text length.

5. Move cursor

Moves the cursor in the input box to the right or left.

6. Delete

Deletes the character preceding the cursor.

7.

Switches the next character to a capital or small letter.

8. Fix

Finalizes the entry.

To cancel text entry, select .

[89] How to Use | Menu operations | Shooting Mode

Movie

You can select the movie recording mode.

1.  - [Shooting Mode] - [Movie].

[90] How to Use | Menu operations | Shooting Mode



Photo

You can select the photo shooting mode.

1.  - [Shooting Mode] - [Photo].

Smth Slw REC

This product records approximately 3-second-long fast actions or motions as an approximately 12-second-long slow-motion movie.

1. [MENU] - [Image Quality/Size] - [File Format] - [AVCHD].
2. [MENU] - [Shooting Mode] - [Smth Slw REC].
3. Select  /  to change the timing at which this product starts recording.



[3sec After] (default setting):

This product records a movie of approximately 3 seconds after the START/STOP button is pressed.

[3sec Before]:

This product records a movie of approximately 3 seconds before the START/STOP button is pressed.

4. Press the START/STOP button.
 - [Recording...] disappears when recording is finished.

Note

- You cannot record sound.
- Image quality is not as good as that of normal recording.
- [REC Mode] will be set to [Standard HQ] automatically.

Golf Shot

Divides 2 seconds of fast movement into frames which are then recorded as a movie and photos. You can view a series of movement when playing back, which is convenient in cases such as checking golf swing or tennis form.

1. [MENU] - [Image Quality/Size] - [REC] File Format] - [HDMI] AVCHD].
2. [MENU] - [Shooting Mode] - [Golf Shot].
3. Frame the subject in the white grid in the center of the LCD monitor, then press START/STOP right after the subject has taken a swing.



- The moment when the largest sound is detected within the first second after START/STOP is pressed is assumed as the moment that a club hit a ball, and the period of time adjusted automatically according to the detected moment will be recorded.

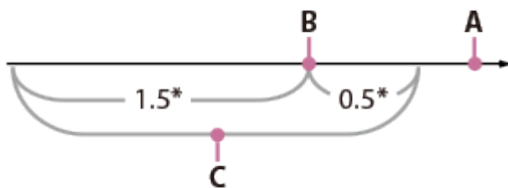

* seconds

A: The point when you press START/STOP

B: The sound of a club hitting the ball



C: This product records images in this 2 second period.

Note

- If this product cannot detect the sound of a club hitting the ball, this product automatically sets the impact point at 0.5 second before the START/STOP button has been pressed, and records a movie in the time period between 1.5 seconds before the impact point to 0.5 second after the impact point.
- The size of photos becomes 1,920×1,080.
- You cannot record sound.
- Image quality is not as good as that of normal recording.
- [REC Mode] will be set to [Standard HQ] automatically.
- Impact sound may be detected by the built-in microphone even when an external microphone is attached.
- The image recorded may be noisy when this product has failed to analyze the shot properly because there may be movement in background of the recording screen. It is

recommended that you record images under stable conditions (for example, using a tripod).



Hint

- You can check your form using self-timer. Select [] / [] - [On], this product starts countdown of the timer after you press the START/STOP button. The point when the count reaches 0 is assumed as the moment of impact and motion before and after 0 is recorded.



[93] How to Use | Menu operations | Shooting Mode

High Speed REC

When you record [ XAVC S HD] movies, you can use the high-speed recording function.

1. [MENU] - [Image Quality/Size] - [ File Format] - [ XAVC S HD].
2. [MENU] - [Shooting Mode] - [High Speed REC].

Note

- When you set [ File Format] to [ XAVC S 4K] or [ AVCHD], this function is not available.
- Image quality is not as good as that of normal recording.

[94] How to Use | Menu operations | Camera/Mic

White Balance

You can adjust the color balance to the recording environment.

1. [MENU] - [Camera/Mic] - [ Manual Settings] - [White Balance] - desired setting.

Descriptions of menu items

(Auto) (default setting):

The white balance is adjusted automatically.

If you have changed the battery pack while [Auto] was selected, or taken this product outdoors after inside use (or vice versa), aim this product at a nearby white object for about

10 seconds for better color balance adjustment.

(Outdoor):

The white balance is appropriately adjusted for the following recording conditions:

- Outdoors
- Night views, neon signs and fireworks
- Sunrise or sunset
- Under daylight fluorescent lamps



(Indoor):

The white balance is appropriately adjusted for the following recording conditions:

- Indoors
- At party scenes or studios where the lighting conditions change quickly
- Under video lamps in a studio, or under sodium lamps or incandescent-like color lamps

(One Push):

The white balance will be adjusted according to the ambient light.

1. Select .
2. Keep framing white object such as a piece of paper, to fill the LCD monitor under the same lighting conditions as you will shoot the subject.
3. Select .

If the lighting conditions changed by bringing this product outdoors from inside the house, or vice versa, you need to redo the [One Push] procedure to readjust the white balance.

Hint

- You can check the currently selected color balance on the LCD monitor with the color chart.

Note

- Set [White Balance] to [Auto] or adjust the color in [One Push] under white or cool white fluorescent lamps.
- While you are recording a movie,  cannot be set.
- If you set [White Balance], [Scene Selection] is set to [Auto].

[95] How to Use | Menu operations | Camera/Mic

Spot Meter/Fcs

Exposure and focus can be adjusted for the selected subject automatically.

1. **MENU** - [Camera/Mic] -  Manual Settings] - [Spot Meter/Fcs].

2. Touch the subject which you want to adjust the exposure and focus of.
 - To adjust the brightness and focus automatically, select [Auto].

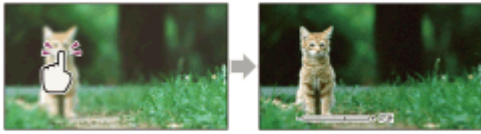

Note

- [Exposure] and [Focus] are automatically set to [Manual].

[96] How to Use | Menu operations | Camera/Mic

Spot Meter

Exposure can be adjusted and set for the selected subject automatically. This function is useful when there is strong contrast between the subject and the background, such as subjects in the spotlight on stage.

1. [MENU] - [Camera/Mic] - [Manual Settings] - [Spot Meter].
2. Touch the subject which you want to adjust the exposure.
 - To return the setting to automatic exposure, select [Auto].

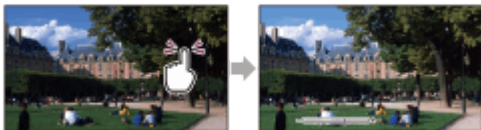

Note

- [Exposure] is automatically set to [Manual].

[97] How to Use | Menu operations | Camera/Mic

Spot Focus

Focus can be adjusted automatically for the subject selected.

1. - [Camera/Mic] - [ Manual Settings] - [Spot Focus].
2. Touch the subject which you want to adjust the focus.
 - To adjust the focus automatically, select [Auto].



Note

- [Focus] is automatically set to [Manual].

[98] How to Use | Menu operations | Camera/Mic

Exposure

You can fix the brightness of an image manually. Adjust the brightness when the subject is too bright or too dark.

1. - [Camera/Mic] - [ Manual Settings] - [Exposure] - desired setting.

Descriptions of menu items

Auto (default setting):

The exposure is adjusted automatically.

Manual:

Select if the subject is white or the backlight is bright, or select if the subject is black or the light is dim.

[99] How to Use | Menu operations | Camera/Mic

Focus

You can adjust the focus manually. You can select this function also when you want to focus on a certain subject intentionally.

1. - [Camera/Mic] - [ Manual Settings] - [Focus] - desired setting.





Descriptions of menu items

Auto (default setting):

The focus is adjusted automatically.

Manual:

 appears.

Adjust the focus using  (nearby subject) or  (distant subject).  appears when the focus cannot be adjusted any closer, and  appears when the focus cannot be adjusted farther away.

Note

- The minimum possible distance between this product and subject while maintaining sharp focus is about 1 cm (about 13/32 in.) for wide angle and about 80 cm (about 31 1/2 in.) for telephoto.



Hint

- It is easier to focus on the subject by moving the power zoom lever towards T (telephoto) to adjust the focus, then towards W (wide angle) to adjust the zoom for recording. When you want to record a subject at close range, move the power zoom lever to W (wide angle), then adjust the focus.
- This product displays the focal distance information for a few seconds when [Focus] is set to [Manual] or when you set the focus manually. You can use this information as a guide when the subject is dark and focus adjustment is difficult.

[100] How to Use | Menu operations | Camera/Mic

IRIS

You can shoot images with the IRIS priority mode. Changing IRIS parameter changes the focus range. You can change the IRIS parameter depending on what type of images you want to shoot, either to sharpen the subject with its background blurred or sharpen the whole image.



1.  - [Camera/Mic] - [ Manual Settings] - [IRIS] - desired setting.

Descriptions of menu items

Auto (default setting):

The IRIS is adjusted automatically.

Manual:

Adjust the iris by selecting  to sharpen the whole image (increase the IRIS parameter), and  to sharpen the subject with its background blurred (decrease the IRIS parameter).

[101] How to Use | Menu operations | Camera/Mic

Shutter Speed

You can shoot images with the Shutter Speed priority mode. You can express the movement of a moving subject in various way by adjusting the shutter speed.



1.  - [Camera/Mic] -  Manual Settings] - [Shutter Speed] - desired setting.

Descriptions of menu items

Auto (default setting):

The shutter speed is adjusted automatically.

Manual:

Adjust the shutter speed using  to get a fast shutter speed, and  to get a slow shutter speed.

Hint

- Moving objects you record will look different depending on the shutter speed. Set the shutter speed faster to record a fast-moving object clearly without blurring, and set the shutter speed slower to emphasize the movement of a moving object.
- You can set the shutter speed as follows.

1080 60i-compatible device

- between 1/8 and 1/10,000 seconds in movie recording at 60p/30p
- between 1/6 and 1/10,000 seconds in movie recording at 24p
- between 1/8 and 1/250 seconds in photo recording mode

1080 50i-compatible device

- between 1/6 and 1/10,000 seconds in movie recording at 50p/25p
- between 1/6 and 1/215 seconds in photo recording mode

- Focusing automatically is difficult at lower shutter speed. It is recommended that manual focusing be performed with this product attached to a tripod.
- The range of shutter speed you can adjust manually is as follows:

1080 60i-compatible device

- When recording using [Smth Slw REC], it changes to 1/250 - 1/10,000 seconds.
- When recording using [High Speed REC], it changes to 1/125 - 1/10,000 seconds.

1080 50i-compatible device

- When recording using [Smth Slw REC], it changes to 1/215 - 1/10,000 seconds.
- When recording using [High Speed REC], it changes to 1/120 - 1/10,000 seconds.
- When recording under fluorescent lamps, sodium lamps, mercury lamps, or LED light, horizontal bands may appear on the LCD monitor. You may be able to improve the situation by adjusting the shutter speed.

[102] How to Use | Menu operations | Camera/Mic

AGC Limit

You can select the upper limit for the AGC (Auto Gain Control).

1. **MENU** - [Camera/Mic] - [ Manual Settings] - [AGC Limit] - desired setting.

Descriptions of menu items

Off (default setting):

The gain is automatically adjusted.

21dB/18dB/15dB/12dB/9dB/6dB/3dB/0dB (**AGC↑**):

The gain is automatically adjusted up to the selected limit.

Note

- At a higher gain, the brightness becomes more appropriate in dim scenes, but the noise increases. At a lower gain, the noise decreases, but the shutter speed becomes slower to compensate for the lack of brightness, causing camera shake or subject blur.
- When recording using [Smth Slw REC], the upper limit of [AGC Limit] is [15dB].

[103] How to Use | Menu operations | Camera/Mic

AE Shift

You can adjust the exposure according to your preference.

1. **MENU** - [Camera/Mic] - [ Manual Settings] - [AE Shift] - desired setting.

Descriptions of menu items

Off (default setting):

The exposure is adjusted automatically.

On (Adjusted number and EV):

Adjust the automatic exposure level using when the subject is white or the background is bright, and when the subject is dark or the light is dim.

[104] How to Use | Menu operations | Camera/Mic

White Balance Shift

You can adjust the white balance according to your preference.

1. - [Camera/Mic] - [Manual Settings] - [White Balance Shift] - desired setting.

Descriptions of menu items

Off (default setting):

The white balance is adjusted automatically.

On (and adjusted number):

Adjust the white balance using when the images appear bluish, and when the images appear reddish.

[105] How to Use | Menu operations | Camera/Mic

Low Lux

You can record bright color images, even in dim light.

1. - [Camera/Mic] - [Manual Settings] - [Low Lux] - desired setting.

Descriptions of menu items

Off (default setting):

The Low Lux function is not used.

On ():

The Low Lux function is used.

Scene Selection

You can record images effectively in various situations.

1. **MENU** - [Camera/Mic] - [ Camera Settings] - [Scene Selection] - desired setting.

Descriptions of menu items

 **(Auto)(default setting):**

Adjusts image quality automatically.

 **(Night Scene)(*):**

Using a tripod (sold separately) allows you to shoot beautiful night scenes.



 **(Sunrise&Sunset)(*):**

Reproduces the atmosphere of scenes such as sunsets or sunrises.



 **(Fireworks)(*):**

Takes spectacular shots of fireworks.



 **(Landscape)(*):**

Shoots distant subjects clearly. This setting also prevents this product from focusing on glass or metal mesh in windows between this product and the subject.



 **(Portrait):**

Brings out the subject such as people or flowers while creating a soft background.



 **(Spotlight):**

Prevents people's faces from appearing excessively white when subjects are lit by strong light.



 **(Beach):**

Takes the vivid blue of the ocean or a lake.



 **(Snow):**

Takes bright pictures of a white landscape.



* Adjusted to focus on subjects farther away only.

Note

- If you set [Scene Selection], the following settings are canceled.
 - White Balance
 - IRIS

- Shutter Speed
-  Cinematone

[107] How to Use | Menu operations | Camera/Mic

Picture Effect

Allows you to shoot more impressive images by selecting the desired effect.

1.  - [Camera/Mic] - [ Camera Settings] - [Picture Effect] - desired setting.

Descriptions of menu items

Off (default setting):

Does not use the Picture Effect.

(Toy Camera):

Allows you to shoot an image having a unique color tone with its surrounding colors dark. Select the effect you want with [OPTION].

(Pop Color):

Allows you to shoot a pop art-like colorful image with emphasis on the color tone.

(Posterization):

Creates a high contrast, abstract look by heavily emphasizing primary colors, or in black and white. Select the effect you want with [OPTION].

(Retro Photo):

Creates the look of an aged photo with sepia color tones and faded contrast.

(Soft High-key):

Allows you to shoot soft, clear images with an emphasis on brightness.

(Partial Color):

Allows you to shoot an image that makes a strong impression by leaving a specified color on portions of a monochrome image. Select the effect you want with [OPTION].

(High Contrast Mono.):

Creates an intense, high-contrast image in black and white.

Note

- When you select a [Picture Effect] item, the following functions are not available.
 - Recording photos in the movie recording mode
 - Some other functions

Cinematone

This product automatically adjusts the image quality of the movie to resemble the atmosphere of film camera images.

1. [MENU] - [Camera/Mic] - [ Camera Settings] - [ Cinematone] - desired setting.

Descriptions of menu items



Off (default setting):

Does not use the Cinematone function.

On :

Uses the Cinematone function.

Note

- When you switch this function on or off, the image will be paused temporarily.
- When [ Cinematone] is set to [On], the [Scene Selection] setting changes to [Auto].
- When [ Cinematone] is set to [On], the [Picture Effect] setting changes to [Off].

Fader

You can record a transition with the following effects adding to the interval between scenes. Select the desired effect in [STBY] (to fading in) or [REC] (to fading out) mode.

1. [MENU] - [Camera/Mic] - [ Camera Settings] - [ Fader] - desired setting.

Descriptions of menu items

Off (default setting):

Does not use an effect.

White Fader():

Fades in/out with the white effect.



A: Out

B: In

Black Fader():

Fades in/out with the black effect.

Images recorded using the [Black Fader] effect may appear dark on the index screen.



A: Out

B: In



Note

- When you press START/STOP, the setting is cleared.

[110] How to Use | Menu operations | Camera/Mic

Self-Timer

Press PHOTO to start the count down. A photo is recorded after about 10 seconds.

1.  - [Camera/Mic] - [ Camera Settings] - [ Self-Timer] - desired setting.

Descriptions of menu items

Off (default setting):

Cancels the self-timer.

On ():

Starts the self-timer recording. To cancel the recording, select .

Hint

- The Self-Timer does operate in photo recording mode.

SteadyShot (Movie)

This product has a balanced optical SteadyShot function that allows you to reduce the camera-shake when shooting with zooming, as well as when shooting with a wide-angle shot.

1.  - [Camera/Mic] -  Camera Settings] -  SteadyShot] - desired setting.

Descriptions of menu items

Active:

Records a movie using a more effective SteadyShot function.



Standard (default setting):

This product reduces camera shake using the SteadyShot function in wide-angle shooting.

Off ():

This product does not use the SteadyShot function.

Note

- The angle of view will be changed after changing the settings of the  SteadyShot] function.
- When you set  SteadyShot] to [Active], the zoom magnification is 20x when recording an HD movie and 15x when recording a 4K movie.

SteadyShot (Photo)

You can compensate for camera shake. Set  SteadyShot] to [Off] when using a tripod (sold separately), then the image becomes natural.

1.  - [Camera/Mic] -  Camera Settings] -  SteadyShot] - desired setting.

Descriptions of menu items

On (default setting):

The SteadyShot function is used.

Off ():

The SteadyShot function is not used.

Digital Zoom

You can select the maximum zoom level. Note that the image quality decreases when you use the digital zoom.

1. **MENU** - [Camera/Mic] - [ Camera Settings] - [Digital Zoom] - desired setting.

Descriptions of menu items

Off (default setting):

Digital zoom cannot be used.

120:

Up to 120 zoom is performed digitally.

Auto Back Light

This product adjusts the exposure for backlit subjects automatically.

1. **MENU** - [Camera/Mic] - [ Camera Settings] - [Auto Back Light] - desired setting.

Descriptions of menu items

On (default setting):



The exposure for backlit subjects is adjusted automatically.

Off:

Does not adjust the exposure for backlit subjects.

Manual Ring Setting

You can assign one menu item you often use to the MANUAL ring.

1.  - [Camera/Mic] - [ Camera Settings] - [Manual Ring Setting] - desired setting.



Menu items that you can set

Zoom/Focus/Exposure/IRIS/Shutter Speed/AE Shift/White Balance Shift

[116] How to Use | Menu operations | Camera/Mic

NIGHTSHOT Light

When recording in a dark place with the NightShot function, you can change the infrared light setting.

1.  - [Camera/Mic] - [ Camera Settings] - [NIGHTSHOT Light] - desired setting.

Descriptions of menu items

On (default setting):

Emits infrared light.



Off :

Does not emit infrared light.

[117] How to Use | Menu operations | Camera/Mic

Face Detection

You can set this product to detect a face automatically. This product adjusts the focus/color/exposure automatically for the face of the selected subject.

1.  - [Camera/Mic] - [ Face] - [Face Detection] - desired setting.

Descriptions of menu items

Auto (default setting):

Detects faces.

Off ([OFF]): 

Does not detect faces.

Note

- Faces may not be detected depending on recording conditions.

Hint

- Recording conditions for better face detection performance are as follows.
 - Shoot in a sufficiently bright place.
 - The subject is not wearing glasses, a hat or mask.
 - The subject faces directly towards the camera.

[118] How to Use | Menu operations | Camera/Mic

Smile Shutter

The shutter is released automatically when this product detects a smile. If you do not want to take photos automatically, select [Off].

1. [MENU] - [Camera/Mic] - [ Face] - [Smile Shutter] - desired setting.

Descriptions of menu items

Dual Capture ([]): 

Only during movie recording, the shutter is released automatically, when this product detects a smile.

Always On ([]): 

The shutter is released when this product detects a smile whenever this product is in recording mode.

Off (default setting):

Smiles are not detected, so photos are not recorded automatically.

Note

- Smiles may not be detected depending on recording conditions, subject conditions, and the setting of this product.

[119] How to Use | Menu operations | Camera/Mic

Smile Sensitivity

Sets the smile detection sensitivity for using the Smile Shutter function.

1. **MENU** - [Camera/Mic] - [ Face] - [Smile Sensitivity] - desired setting.

Descriptions of menu items

Big Smile:

Detects a big smile.

Normal Smile (default setting):

Detects a normal smile.

Slight Smile:

Detects even a slight smile.

[120] How to Use | Menu operations | Camera/Mic

Flash (Only when connecting an external flash)

Select the flash setting.

Select the desired flash setting when you record photos using an external flash (sold separately) compatible with this product.

1. **MENU** - [Camera/Mic] - [ Flash] - [Flash] - desired setting.

Descriptions of menu items

Auto (default setting):

Automatically flashes when there is insufficient ambient light.

On ():

Always uses the flash regardless of the surrounding brightness.

Off ():

Records without flash.

Note

- The flash does not operate in the movie recording mode.

Hint

- Particles (dust, pollen, etc.) floating close to the lens are accentuated by a flash, and they appear as white circular spots. To reduce this phenomenon, brighten the recording place and record the subject without a flash.

[121] How to Use | Menu operations | Camera/Mic

Flash Level (Only when connecting an external flash)

You can select the brightness of the flash light.

Select the desired brightness when you record photos using an external flash (sold separately) compatible with this product.

1. **MENU** - [Camera/Mic] - [ Flash] - [Flash Level] - desired setting.

Descriptions of menu items

High:

Makes the flash level higher.

Normal (default setting):

Normal flash level

Low:

Makes the flash level lower.

[122] How to Use | Menu operations | Camera/Mic

Red Eye Reduction (Only when connecting an external flash)

Prevent redevye by activating the pre-flash before the flash operates.

Set this function when you record photos using an external flash (sold separately) compatible with this product.

1. **MENU** - [Camera/Mic] - [ Flash] - [Red Eye Reduction] - desired setting.

Descriptions of menu items

Off (default setting):

Does not use Red Eye Reduction to prevent redevye.

On ():

Uses Red Eye Reduction to prevent redeye.

Note

- The redeye reduction may not produce the desired effect due to individual differences and other conditions.
- The redeye function does not work with automatic recording by [Smile Shutter].

[123] How to Use | Menu operations | Camera/Mic

My Voice Canceling

You can record the voice of the subject clearly by decreasing the voice volume of the person recording the movie.

1.  - [Camera/Mic] - [ Microphone] - [My Voice Canceling].

Descriptions of menu items

Off (default setting):

Does not decrease the voice volume of the person recording the movie.

On ():

Decreases the voice volume of the person recording the movie and records the voice of the subject clearly.

Note

- Set [My Voice Canceling] to [Off] if you want to record a movie without decreasing the voice volume of the person recording the movie.
- Depending on the recording condition, you cannot decrease the voice volume of the person recording the movie as expected.
- The [My Voice Canceling] function does not activate while an external microphone is connected to this product.

[124] How to Use | Menu operations | Camera/Mic

Blt-in Zoom Mic

You can record a movie with vivid sound appropriate to the zoom position.

1. **MENU** - [Camera/Mic] - [ Microphone] - [Blt-in Zoom Mic] - desired setting.

Descriptions of menu items

Off (default setting):

The microphone does not record sound following zooming in or out.

On ():

The microphone records sound following zooming in or out.

Note

- When you set [Audio Rec Level] to [Manual], [Blt-in Zoom Mic] is set to [Off] automatically.

[125] How to Use | Menu operations | Camera/Mic

Auto Wind NR

This function automatically cuts the low-range wind noise according to the noise level when recording using the built-in microphone.

1. **MENU** - [Camera/Mic] - [ Microphone] - [Auto Wind NR] - desired setting.

Descriptions of menu items

Off ():

Does not reduce the wind noise.

On (default setting):

Reduces the wind noise.

Note

- When you set [Auto Wind NR] to [Off], Intelligent Auto is set to [Off].
- [Auto Wind NR] will not function while an external microphone is attached to this product.

[126] How to Use | Menu operations | Camera/Mic

Audio Mode

You can change the recording sound format.

1. - [Camera/Mic] - [ Microphone] - [Audio Mode] - desired setting.

Descriptions of menu items



5.1ch Surround () (default setting):

Records sound in 5.1ch surround.

2ch Stereo ():

Records sound in 2ch stereo.

Note

- [5.1ch Surround] is available when [ File Format] is set to [ AVCHD].
- The recording sound format of XAVC S movies is automatically set to [2ch Stereo] and cannot be changed.

[127] How to Use | Menu operations | Camera/Mic

Audio Rec Level

You can adjust the audio recording level.

1. - [Camera/Mic] - [ Microphone] - [Audio Rec Level] - desired setting.

Descriptions of menu items

Auto (default setting):

The audio recording level is adjusted automatically.

Manual ():

Adjust the audio recording level with to raise the audio recording level and to lower the audio recording level.

Note

- The manually set value will be reset each time you switch between [Auto] and [Manual].
- When [Audio Rec Level] is set to [Manual], BIt-in Zoom Mic will switch to [Off].
- It is recommended that you wear headphones to operate while checking the level.
- When continuously recording loud sound, lower the recording level in advance to record dynamic sound.
- The limiter is always active regardless of the setting value of the recording level.

- When you are using a dedicated microphone that is connected with the Multi interface shoe, the recording level setting will be invalid, and you will not be able to adjust the recording level.
- After setting [My Voice Canceling] to [On], you cannot change the audio recording level anymore.

[128] How to Use | Menu operations | Camera/Mic

My Button

You can assign functions that you frequently use when recording to one of the My Buttons.

1. **MENU** - [Camera/Mic] - [ Shooting Assist] - [My Button].
2. Select the menu item that you want to assign to a My Button using **^** / **v**.

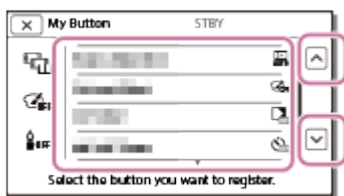

3. Select one of the My Buttons to which the menu item will be assigned.

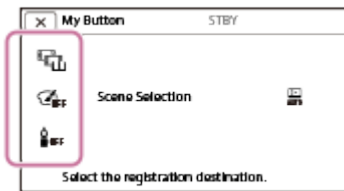

4. Select **OK**.

[129] How to Use | Menu operations | Camera/Mic

Focus Magnifier

You can magnify an image that appears at the center of the LCD monitor by about 2.0 times to confirm the sharpness of the focus.

1. **MENU** - [Camera/Mic] - [ Shooting Assist] - [Focus Magnifier] - desired setting.

Descriptions of menu items

Off (default setting):

Does not magnify images.

On:

Magnify images.

Note

- Even though the image displayed on this product has been magnified, the recorded image is not magnified.
- The image that is output to an external device is not magnified.

[130] How to Use | Menu operations | Camera/Mic

Grid Line

You can display the lines and check that the subject is horizontal or vertical.

1. **MENU** - [Camera/Mic] - [ Shooting Assist] - [Grid Line] - desired setting.

Descriptions of menu items

Off (default setting):

Does not display the grid lines.

On:

Displays the grid lines.

Hint

- Positioning the subject at the cross point of the grid lines makes a balanced composition.
- The lines are not recorded.
- The outer frame of grid lines shows the display area of a TV which is not compatible with full pixel display.

[131] How to Use | Menu operations | Camera/Mic

Display Setting

You can set the duration of displaying the icons or indicators on the LCD monitor while

recording.

1. **MENU** - [Camera/Mic] - [ Shooting Assist] - [Display Setting] - desired setting.

Descriptions of menu items

Auto (default setting):

Displays for about 3 seconds.

The rec and zoom buttons on the LCD monitor are displayed.

On:

Always displays. The rec and zoom buttons on the LCD monitor are not displayed.

Note

- You cannot change the setting of the icons or indicators on the LCD monitor while in playback mode.

[132] How to Use | Menu operations | Camera/Mic

Zebra

You can display a zebra pattern as a guide for adjusting brightness.

1. **MENU** - [Camera/Mic] - [ Shooting Assist] - [Zebra] - desired setting.

Descriptions of menu items

Off (default setting):

Does not display the zebra pattern.

70 (70):

Displays the zebra pattern over the part of an image that exceeds the brightness level of about 70 IRE.

100 (100):

Displays the zebra pattern over the part of an image that exceeds the brightness level of about 100 IRE.

IRE (Institute of Radio Engineers) is a measure of the video signal level that is used as the bases of brightness; the reference level (pedestal level) is set to 0 (%) and the maximum level (completely white level) is set to 100 (%).

Note

With a subject that exceeds a brightness level of 100 IRE, the image may become overexposed.

Hint

- The zebra pattern will not be recorded with the image.

[133] How to Use | Menu operations | Camera/Mic

Peaking

You can display an image on the LCD monitor with its outlines enhanced with colors. This function helps you to adjust the focus.

1. **MENU** - [Camera/Mic] - [ Shooting Assist] - [Peaking] - desired setting.

Descriptions of menu items

Off (default setting):

Does not display the enhanced outlines.

(White)

Displays the enhanced outlines in white.

(Red)

Displays the enhanced outlines in red.

(Yellow)

Displays the enhanced outlines in yellow.

Note

- The enhanced outlines may not appear in a dark location.

Hint

- The enhanced outlines will not be recorded on the image.

[134] How to Use | Menu operations | Camera/Mic

Audio Level Display

You can select whether or not to display the audio level meter. Shape of the audio level meter differs depending on the [Audio Mode] setting.

1. **MENU** - [Camera/Mic] - [ Shooting Assist] - [Audio Level Display] - desired setting.

Descriptions of menu items

On (default setting):

Displays audio level meter.

Off:

Does not display the audio level meter.





[135] How to Use | Menu operations | Image Quality/Size

REC Mode



You can select your desired image quality for AVCHD movies. The recording time or the type of media device to which the images can be copied may differ, depending on the movie quality selected.

1. **MENU** - [Image Quality/Size] - [ REC Mode] - desired setting.

Descriptions of menu items

When [ File Format] is set to [ XAVC S 4K], [60Mbps ] or [100Mbps ] can be selected.

When [ File Format] is set to [ XAVC S HD], [50Mbps ] is fixed for [REC mode].

When [ File Format] is set to [ AVCHD]:

Highest Quality :

Records a movie in the highest quality possible for this product (when in 60i (*)/50i (**)/24p (*)/25p (**)).

High Quality :

Records a higher quality movie (when in 60i (*)/50i (**)/24p (*)/25p (**)).

Standard :

Records a standard quality movie (when in 60i (*)/50i (**)).

Long Time :

Records a long movie (when in 60i (*)/50i (**)).

60p Quality (*)/50p Quality (**)

Records a movie in 60p (*)/50p (**).

* 1080 60i-compatible device

**

Hint



- Types of media that images can be saved on will depend on the image quality selected.
 - 60p Quality **PS** (*)/50p Quality **PS** (**)/Highest Quality **FX** :
Memory card, External media, Blu-ray discs
 - High Quality **FH**/Standard **HQ**/Long Time **LP** :
Memory card, External media, Blu-ray discs, AVCHD recording discs

* 1080 60i-compatible device: [60p Quality **PS**] can be set only when the [ Frame Rate] is set to [60p].

** 1080 50i-compatible device: [50p Quality **PS**] can be set only when the [ Frame Rate] is set to [50p].

[136] How to Use | Menu operations | Image Quality/Size

Frame Rate

You can select the frame rate to be used to record XAVC S 4K movies, XAVC S HD movies or AVCHD movies. Set [ Frame Rate] first, before setting [ REC Mode].

1. **MENU** - [Image Quality/Size] - [ Frame Rate] - desired setting.
 - Available frame rate settings vary depending on the recording format. See the following.

Available frame rate settings

XAVC S 4K:

30p(*)/25p(**)(default setting)

24p(*)

XAVC S HD:

60p(*)/50p(**)(default setting)

30p(*)/25p(**)

24p(*)

AVCHD :

60p(*)/50p(**)

60i(*)/50i(**) (default setting)

24p(*)

Descriptions of menu items

60i(*)/50i(**) (default setting):

This is an ordinary setting for recording AVCHD movies.

60p(*)/50p():**

You can record movies with a data volume twice that of 60i(*) or 50i(**)/30p(*) or 25p(**) per unit time. When you play a movie recorded with this setting on a TV, the TV must be compatible with 60p(*) or 50p(**) movie playback and you have to set [HDMI Resolution] to 1080p.

30p(*):

It is recommended that you use a tripod when recording movies with this setting.

24p(*)/25p():**

You can record movies which provide an atmosphere closer to that of film images with this setting. It is recommended that you record movies with this setting using a tripod.

* 1080 60i-compatible device

** 1080 50i-compatible device

Note

- The media that the recorded images can be saved on will depend on the setting of [REC Mode].

[137] How to Use | Menu operations | Image Quality/Size

Dual Video REC

You can set the dual recording mode (recording an MP4 movie during movie recording) to on or off.

1. [MENU] - [Image Quality/Size] - [Dual Video REC] - desired setting.

Descriptions of menu items

On :

Records an MP4 movie while recording a 4K or HD movie.

Off (default setting):

Does not record an MP4 movie while recording a 4K or HD movie.

Note

- When any of the following conditions are met, [Dual Video REC] will be set to [Off].
 - When [REC Mode] is set to [60p Quality PS (1080 60i-compatible device)]/[50p Quality PS (1080 50i-compatible device)].

- When [File Format] is set to [XAVC S HD] and [Frame Rate] is set to 60p (1080 60i-compatible device)/50p (1080 50i-compatible device).
- During [Live Streaming]
- During [Multi Camera Control]
- The following functions cannot be used when [Dual Video REC] is set to [On].
 - Dual Capture (When [File Format] is set to [XAVC S 4K].)
 - Lock-on AF (When [File Format] is set to [XAVC S 4K].)
 - Face Detection (When [File Format] is set to [XAVC S 4K].)

[138] How to Use | Menu operations | Image Quality/Size

File Format

Set the recording format for recording and playback.

1. [MENU] - [Image Quality/Size] - [File Format] - desired setting.

Descriptions of menu items

[4K] XAVC S 4K (default setting):

Records 4K images in XAVC S format.

This setting is suitable for watching on a 4K TV. Both recording and playback switches.

Movies you can play are also switched according to the [Frame Rate] setting value.

[HD] XAVC S HD:

Records HD (high definition) images in XAVC S format.

This setting is suitable for watching on an HD (high definition) TV. Both recording and playback switches.

[HD] AVCHD:

Records HD (high definition) images in AVCHD format.

This setting is suitable for watching on an HD (high definition) TV and Blu-ray disc recording. Both recording and playback switches.

[139] How to Use | Menu operations | Image Quality/Size

Image Size

You can select a size for the photos you are going to shoot. The number of photos you can

shoot differs, depending on the image size selected.

1. **MENU** - [Image Quality/Size] - [ Image Size] - desired setting.
 - The image size is set according to the format selected as [ File Format].

16:9 L (20.6M) (*)

4:3 L (15.4M) (*)

16:9 M (10.3M)

4:3 M (7.7M) (*)

16:9 S (2.1M)

4:3 S (VGA) (*)

* Cannot be selected in movie recording mode. (L, if selected, will be changed to M.)

Note

- The image size selected with this setting is also applied to photos taken by the Dual Capture function.
- The By Pixel Super Resolution technology is used for recording size L photos and size M photos (recorded by the Dual Capture function during AVCHD/XAVC S HD movie recording).

[140] How to Use | Menu operations | Wireless

Ctrl with Smartphone

You can use your smartphone as a wireless remote commander.

1. **MENU** - [Wireless] - [ Function] - [Ctrl with Smartphone].

[141] How to Use | Menu operations | Wireless

Multi Camera Control

You can control other cameras connected to this product via Wi-Fi.
For details, see “Related Topic.”



Live Streaming

You can live stream videos being shot with this product to a video sharing site such as USTREAM through a Wi-Fi router or smartphone capable of tethering.

For details, see “Related Topic.”

Send to Smartphone

Transfer images recorded with this product to your smartphone.



1. Press the  button on this product to enter the playback mode.
2. **MENU** - [Wireless] -  [Function] - [Send to Smartphone].

Note

- Do not close the LCD monitor while transferring files. Transferring will be interrupted.
-

Send to Computer

Transfer images recorded with this product to your computer.

1. Press the  button on this product to enter the playback mode.
2. **MENU** - [Wireless] -  [Function] - [Send to Computer].

Note

- Do not close the LCD monitor while transferring files. Transferring will be interrupted.
-

View on TV

You can view images on your TV that is compatible with the network function by transferring images from this product without connecting this product and TV with a cable. Operations may be required on your TV before playing depending on the TV you use. For details, refer to the instruction manuals of the TV.

1. Press  on this product to enter the playback mode.
2. **MENU** - [Wireless] -  Function] - [View on TV].

Note

- Do not close the LCD monitor while transferring files. Transferring will be interrupted.

Airplane Mode

When you board an airplane, you can deactivate the Wi-Fi function temporarily.

1. **MENU** - [Wireless] -  Setting] - [Airplane Mode] - desired setting.

Descriptions of menu items

Off (default setting):

Normal setting.

On (✈):

Use the setting when you are on board an airplane.

Multi Camera Ctrl Set

You can set the connection method for Multi Camera Control.

1. **MENU** - [Wireless] -  Setting] - [Multi Camera Ctrl Set] - desired setting.

Descriptions of menu items

Single Connection (default setting):

Operates one camera.

Multi Connection :

Operates multiple cameras.

[148] How to Use | Menu operations | Wireless

Vid REC during strm.

While videos shot with this product are Live Streaming to a video sharing site such as USTREAM, the video can be recorded on the recording media of this product.

1. **MENU** - [Wireless] -  Setting] - [Vid REC during strm.] - desired setting.

Descriptions of menu items

On (default setting):

Records videos on the recording media of this product during Live Streaming.

Off:

Does not record videos on the recording media of this product during Live Streaming.

Note

- If the internal memory or the memory card becomes full, recording stops automatically without stopping streaming.

[149] How to Use | Menu operations | Wireless

WPS Push

If your access point has a WPS button, you can register the access point to this product easily.

1. **MENU** - [Wireless] -  Setting] - [WPS Push].

2. Press the WPS button on the access point you want to register.

Note

- [WPS Push] requires that the security of the access point be WPA or WPA2 and that the WPS push button method is supported. If the security of your access point is set to WEP or your access point does not support the WPS push button method, register the access point manually.
- For details on the supported functions and settings for your access point, refer to the manual of your access point or contact the administrator of your access point.
- Depending on the surrounding conditions such as obstacles between this product and access point, signal condition and the materials of the wall, etc., connections may not be established or the communication distance may be shorter. Move this product or decrease the distance between this product and the access point.

[150] How to Use | Menu operations | Wireless

Access point settings

You can register your access point manually. Before starting the procedure, check the SSID name, security mode, and password of the access point. The password may be preset in some devices. For details, see the access point operating instructions or contact the administrator.

1. [MENU] - [Wireless] - [Setting] - [Access point settings].
2. Select the access point you want to register.

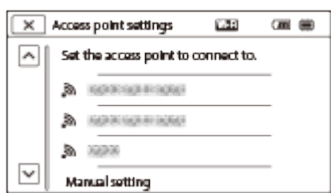

The desired access point is displayed:

Select the access point.

The desired access point is not displayed:

Select [Manual setting], then enter the SSID name of the access point, and then select the security mode.

3. Enter the password, and then select [Next] - [Register].

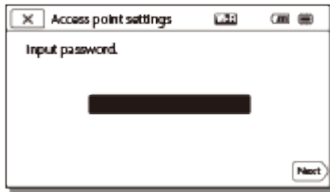

- Access points without the  icon do not require a password to be entered.

Other setting items

Depending on the status or the setting method of your access point, there may be more setting items.

WPS PIN:

Displays the PIN to enter to the connected device.

IP address setting:

Select [Auto] or [Manual].

IP address:

If you are entering the IP address manually, enter the fixed address.

Subnet mask/Default gateway:

When you set [IP address setting] to [Manual], enter the IP address and subnet mask to match your network environment.

Priority Connection:

Select [On] or [Off].

Note

- To give the registered access point priority, set [Priority Connection] to [On].



Hint

- For input method, see “How to use the keyboard.”

[151] How to Use | Menu operations | Wireless

Edit Device Name

You can change the device name for Wi-Fi Direct etc.

1.  - [Wireless] -  Setting] - [Edit Device Name].
2. Select the input box, input the device name, and then select .

Hint

- For input method, see “How to use the keyboard.”

[152] How to Use | Menu operations | Wireless

Disp MAC Address

Display the MAC address of this product.

1. **MENU** - [Wireless] -  Setting] - [Disp MAC Address].
 - The MAC address is displayed.

[153] How to Use | Menu operations | Wireless

SSID/PW Reset

This product shares the SSID/password for [Multi Connection] of [Multi Camera Ctrl Set], [Send to Smartphone] and [Ctrl with Smartphone] with a device that has permission to connect. If you want to change the device that is permitted to connect to this product, reset the SSID/password by the following procedure.

1. **MENU** - [Wireless] -  Setting] - [SSID/PW Reset] - **OK** .

Note

- After resetting the SSID/password, you must set the smartphone again.

[154] How to Use | Menu operations | Wireless

Network Info Reset

In addition to the SSID/password, you can also reset the information of the access point, [Single Connection] of [Multi Camera Ctrl Set], [Streaming Setting], and [SNS Settings] configured on “PlayMemories Home,” etc.

1. **MENU** - [Wireless] -  Setting] - [Network Info Reset].

Note

- After resetting the connection information, you must set the smartphone or the access point again.
- When performing Live Streaming, you have to re-configure the settings with “PlayMemories Home”.

[155] How to Use | Menu operations | Playback Function

Event View





You can play back recorded images by date of recording (Event View).

1. **MENU** - [Playback Function].

[156] How to Use | Menu operations | Edit/Copy

Delete

You can delete unnecessary images.

1. Press the  button on this product to enter the playback mode.
2. On the Event View screen, select , and then select the movie format you want to delete.
 - An icon other than  may be displayed depending on the [ File Format] setting and playback movie format setting.
3. **MENU** - [Edit/Copy] - [Delete] - desired setting.

Descriptions of menu items

Multiple Images:

You can select images to be deleted. Select the type of image you want to delete, then add  to the desired images, and then select **OK**.

All In Event:

You can delete all images in the selected date at one time. Select the date you want to delete using / , and then select .

[157] How to Use | Menu operations | Edit/Copy

Protect

Protect movies and photos to avoid deleting them by mistake.  will be displayed on the protected images.

1. Press the  button on this product to enter the playback mode.
2. On the Event View screen, select / , and then select the movie format you want to protect.
 - An icon other than may be displayed depending on the [File Format] setting and playback movie format setting.
3. - [Edit/Copy] - [Protect] - desired setting.

Descriptions of menu items

Multiple Images:

You can select images to be protected. Select the type of image you want to protect, then add to the desired images, and then select .

Set All In Event:

You can protect all images in the selected date at one time. Select the date you want to protect using / , and then select .

Remove All In Event:

You can remove the protection from all images in the selected date at one time. Select the date you want to remove the protection using / , and then select .

Note

- You cannot select multiple dates.

[158] How to Use | Menu operations | Edit/Copy

Copy

You can copy images stored on the recording media of this product. The original copy of the image will not be deleted after the copy operation has been completed. After you select [Copy], a display asking you to select the source and the destination for the images to be copied appears. Select the desired item.

1. - [Edit/Copy] - [Copy] - desired source and desired destination for the images - desired setting.

Descriptions of menu items

Multiple Images:

You can select images to be copied.

Select the type of image you want to copy, then add to the desired images, and then select .

All In Event:

You can copy all images in the selected date at one time.

Select the date you want to copy using / , and then select .

Note

- Do not close the LCD monitor while copying files. Copying will be interrupted.
- You can copy [XAVC S 4K] movies only at the currently selected frame rate. To copy movies at other frame rates, you should set the frame rate before copying them.
- When you record an image on the memory card for the first time, create the image database file by selecting [Repair Img. DB F.] - [Memory Card].
- Connect this product to a wall outlet (wall socket) using the supplied AC Adaptor to prevent this product from running out of power during copy.

[159] How to Use | Menu operations | Edit/Copy

Direct Copy

You can save images on an external media device manually while the device is connected to this product.

1. Press (View Images).
2. - [Edit/Copy] - [Direct Copy].

Note

- You can perform this operation when this product is connected to an external device.

[160] How to Use | Menu operations | Setup

Media Select (Models with the internal memory)

You can select your desired medium for recording, playback and editing.

1. **MENU** - [Setup] - [ Media Settings] - [Media Select] - desired recording medium.

Descriptions of menu items

Int. Memory (default setting):

Records, plays or edits images on the internal memory.

Memory Card:

Records, plays or edits images on a memory card.

Note

- You cannot select a different recording medium for movies and for photos.

[161] How to Use | Menu operations | Setup

Media Info

You can check the remaining recordable time and the approximate free and used space of the recording media.

1. **MENU** - [Setup] - [ Media Settings] - [Media Info] - recording medium you want to display.

Note

- Since there is a management file area, the used space is not displayed as 0% even if you perform [Format].

[162] How to Use | Menu operations | Setup

Format

Formatting deletes all the movies and photos to recover recordable free space.

1. **MENU** - [Setup] - [ Media Settings] - [Format] - desired recording medium, and select **OK**.

Note

- Connect this product to a wall outlet (wall socket) using the supplied AC Adaptor for this operation.
- To avoid the loss of important images, you should save them before formatting the recording media.
- Protected movies and photos will also be deleted.
- Make sure not to do the following while [Executing...] is displayed.
 - Open/Close the LCD monitor.
 - Operate buttons on this product.
 - Eject the memory card from this product.
 - Disconnect the AC Adaptor.
 - Remove the battery pack.

Hint

- Perform [Empty] to prevent data on the internal memory from being recovered. (Models with the internal memory)

[163] How to Use | Menu operations | Setup

Empty (Models with the internal memory)

It is recommended that you perform [Empty] before disposing of or transferring this product to another party to prevent leakage of your personal information.

1. Connect the AC Adaptor to this product.
2. **MENU** - [Setup] - [ Media Settings] - [Format] - [Int. Memory] - [Empty].

Note

- You cannot perform [Empty] unless you connect the AC Adaptor to the wall outlet (wall socket).

To avoid the loss of important images, they should be saved on a computer or other devices before performing [Empty].

- Disconnect all cables except the AC Adaptor. Do not disconnect the AC Adaptor during the operation.
- If you stop performing [Empty] while [Executing...] appears, be sure to complete the operation by performing [Format] or [Empty] before you use this product next time.

[164] How to Use | Menu operations | Setup

Repair Img. DB F.

Repair the image database file when necessary, such as when the image database repair message appears.

1. - [Setup] - [ Media Settings] - [Repair Img. DB F.] - desired recording medium, and select .

[165] How to Use | Menu operations | Setup

File Number

You can select the way to assign file number of photos/MP4 movies.

1. - [Setup] - [ Media Settings] - [File Number] - desired setting.

Descriptions of menu items

Series (default setting):

Assigns file numbers of photos/MP4 movies in sequence. The file number becomes larger each time you record a photo/MP4 movie.

Even if the memory card is replaced with another one, the file number is assigned in sequence.

Reset:

Assigns file numbers in sequence, following the largest file number existing on the recording medium. When the memory card is replaced with another one, the file number is assigned for each memory card.

Data Code

During playback, this product displays the information recorded automatically at the time of recording. You can check the following information.

1. [MENU] - [Setup] - [▶ Playback Settings] - [Data Code] - desired setting.

Descriptions of menu items

Off (default setting):

Data code is not displayed.

Date/Time:

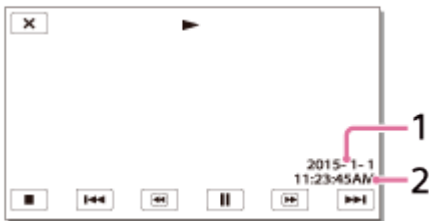

- 1 Date
- 2 Time

Camera Data:

Movie

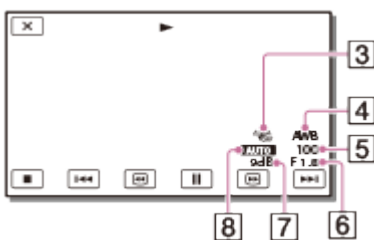

Photo

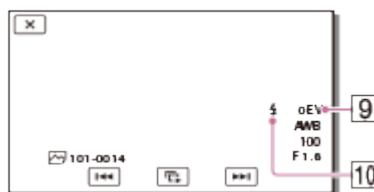

- 3 SteadyShot off
- 4 White Balance
- 5 Shutter Speed
- 6 F-stop

- 7 Gain
- 8 Brightness
- 9 Exposure
- 10 Flash

Note

- The data code is displayed on the TV screen if you connect this product to a TV.
- Depending on the recording media condition, [-- -- --] may appear.

[167] How to Use | Menu operations | Setup

Volume

You can adjust the volume of playback sound.

1. - [Setup] - [Playback Settings] - [Volume] - adjust the volume using / .

[168] How to Use | Menu operations | Setup

Motion Interval ADJ

Adjusts the residual image intervals of a motion shot video.

1. - [Setup] - [Playback Settings] - [Motion Interval ADJ].
2. Adjust the setting value of the residual image intervals with / .
3. Select .

[169] How to Use | Menu operations | Setup

Download Music (Models with the USB IN/OUT jacks)

You can transfer music files from audio CDs etc., to this product by connecting this product

to a computer.

1. [MENU] - [Setup] - [▶ Playback Settings] - [Download Music].

[170] How to Use | Menu operations | Setup

Empty Music (Models with the USB IN/OUT jacks)

You can delete all music files stored on this product.

1. [MENU] - [Setup] - [▶ Playback Settings] - [Empty Music].

[171] How to Use | Menu operations | Setup

TV Type

You need to convert the signal depending on the horizontal to vertical ratio of the TV connected.

1. [MENU] - [Setup] - [↔ Connection] - [TV Type] - desired setting.

Descriptions of menu items

16:9 (default setting):

Select this to view your movies on a 16:9 (wide) TV.

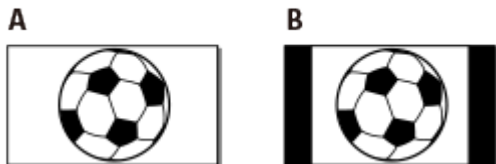

A: Images recorded in 16:9 (wide) mode

B: Images recorded in 4:3 mode

4:3:

Select this to view your movies and photos on a 4:3 standard TV.

A



B



A: Images recorded in 16:9 (wide) mode

B: Images recorded in 4:3 mode

[172] How to Use | Menu operations | Setup

HDMI Resolution

Select the output image resolution when connecting this product to a TV with the HDMI cable.

1. **MENU** - [Setup] - [Connection] - [HDMI Resolution] - desired setting.

Descriptions of menu items

Auto (default setting):

Outputs the signal according to the TV automatically.

2160p/1080p:

Outputs 4K movies at 2160p and HD movies at 1080p.

1080p:

Outputs the 1080p signal. 4K movies are down-converted to HD before outputting.

1080i:

Outputs the 1080i signal. 4K movies are down-converted to HD before outputting.

720p:

Outputs the 720p signal. 4K movies are down-converted to HD before outputting.

[173] How to Use | Menu operations | Setup

CTRL FOR HDMI

When connecting this product to a BRAVIA Sync compatible TV with an HDMI cable, you can play back movies on this product by aiming the TV's Remote Commander at the TV.

1. **MENU** - [Setup] - [ Connection] - [CTRL FOR HDMI] - desired setting.

Descriptions of menu items

On (default setting):

Operates this product using the TV's Remote Commander.

Off:

Does not operate this product using the TV's Remote Commander.

[174] How to Use | Menu operations | Setup

USB Connect

Select this item if a USB connection does not start even when you connect this product to an external device with the Built-in USB Cable.

1. **MENU** - [Setup] - [ Connection] - [USB Connect].

[175] How to Use | Menu operations | Setup

USB Connect Setting

You can set the USB transfer mode for connecting this product to a computer or other USB device.

1. **MENU** - [Setup] - [ Connection] - [USB Connect Setting] - desired setting.

Descriptions of menu items

Auto (default setting):

This product automatically selects the USB transfer mode depending on the connected device.

MTP:

This is a USB transfer mode compatible with certain types of computers.

Mass Storage:

This is a USB transfer mode compatible with many types of USB devices.

Note

- When this product is connected to an external device in the [MTP] mode, image files will be displayed with the recorded date, however, some information included in the image files cannot be displayed on the connected device. To import images from this product to your computer, use the PlayMemories Home software.
- If the “Device Stage*” window does not open when you connect this product to a computer equipped with Windows 7 or Windows 8, set [USB Connect Setting] to [Auto].

*“Device Stage” is a menu of Windows 7 or Windows 8, that is used to manage devices (camcorder, camera, etc.) that are connected to the computer.

[176] How to Use | Menu operations | Setup

USB LUN Setting

Improves compatibility with external devices by limiting the functions of the USB connection.

1. **MENU** - [Setup] - [ Connection] - [USB LUN Setting] - desired setting.

Descriptions of menu items

Multi (default setting):

Use this setting for ordinary operations.

Single:

Try this setting only if you cannot connect to an external device.

[177] How to Use | Menu operations | Setup

Beep

You can turn on or off the melody which sounds when you start/stop recording, or operate this product.

1. **MENU** - [Setup] - [ General Settings] - [Beep] - desired setting.

Descriptions of menu items

On (default setting):

A melody sounds.

Off:

Cancels the melody.

[178] How to Use | Menu operations | Setup

Monitor Brightness

You can adjust the brightness of the LCD monitor.

1. **MENU** - [Setup] - [ General Settings] - [Monitor Brightness] - desired setting.

Descriptions of menu items

Normal (default setting):

Normal setting (normal brightness).

Bright:

Select this when the LCD monitor is not bright enough. This adjustment does not affect the recorded images in any way.

- When using the AC Adaptor, [Monitor Brightness] is set to [Bright] automatically.
-

[179] How to Use | Menu operations | Setup

Auto Keystone ADJ (Models with the projector)

The automatic keystone correction function corrects distorted images (up and down) to display the projection screen in a square shape.

1. **MENU** - [Setup] - [ General Settings] - [Auto Keystone ADJ] - desired setting.

Descriptions of menu items

On (default setting):

Automatically corrects the vertical keystone distortion.

Off:

Does not correct the distortion. Select this setting when projecting images on a tilted screen.

Note

- Depending on angle to project at, vertical keystone distortion may not be corrected well.

[180] How to Use | Menu operations | Setup

REC Lamp

You can make the camera recording lamp on the front of this product not to turn on.

1. **MENU** - [Setup] - [ General Settings] - [REC Lamp] - desired setting.

Descriptions of menu items

On (default setting):

The camera recording lamp lights up.

Off:

The camera recording lamp does not light up.

[181] How to Use | Menu operations | Setup

Power ON w/monitor (FDR-AX30)

Set whether you turn on/off the product by opening/closing the LCD monitor or not.

1. **MENU** - [Setup] - [ General Settings] - [Power ON w/monitor] - desired setting.

Descriptions of menu items

On (default setting):

Turns on/off this product when opening/closing the LCD monitor.

Off:

Select this setting when you want to close the LCD monitor during recording.

[182] How to Use | Menu operations | Setup

Language Setting

You can select the language to be used on the LCD monitor.

1. **MENU** - [Setup] - [ General Settings] - [Language Setting] - desired language.

[183] How to Use | Menu operations | Setup

24p Mode (1080 50i-compatible device)

You can record 24p movies with changing the signal format.

1. **MENU** - [Setup] - [ General Settings] - [24p Mode] - **OK**
If you want to return the system to 50i mode, select **OK** in the [Cancel 24p Mode] screen.

Note

- This product reboots each time you change the setting.
- When you change the setting, formatting the recording media is required.
- When you select [24p Mode], the following settings will be limited.
 - The movie recording format is limited to AVCHD 24p (FX, FH).
 - Depending on the connected TV, images may not be played back normally because the video signal output from this product is in the NTSC format.
 - You cannot set [ Frame Rate].

[184] How to Use | Menu operations | Setup

Cancel 24p Mode (1080 50i-compatible device)

Return the system to 50i mode by canceling 24p mode.

1. **MENU** - [Setup] - [ General Settings] - [Cancel 24p Mode] - **OK**.

[185] How to Use | Menu operations | Setup

Calibration

Use this function if the buttons on the touch panel does not work correctly.

1. **MENU** - [Setup] - [ General Settings] - [Calibration].
2. Touch “x” displayed on the LCD monitor with the corner of memory card or the like 3 times.



Note

- If you did not press the right spot, try the calibration again.
- Do not use a sharp-pointed object for calibration. Doing so may damage the LCD monitor.
- You cannot calibrate the LCD monitor if it is rotated, or closed with the LCD monitor facing out.

Hint

- Select [Cancel] to cancel calibration.

[186] How to Use | Menu operations | Setup

Battery Info

You can check the estimated remaining capacity of the battery pack.

1. **MENU** - [Setup] - [ General Settings] - [Battery Info].

[187] How to Use | Menu operations | Setup

Power Save

You can change the settings for the backlight of the LCD monitor and the power status of this product.

1. **MENU** - [Setup] - [ General Settings] - [Power Save].

Descriptions of menu items

Standard (default setting):

The backlight of the LCD monitor turns dark automatically if you do not attempt to operate this product for more than about 1 minute. This product turns off automatically if you do not attempt to operate this product for more than about 2 minutes.

Max:

The backlight of the LCD monitor turns dark automatically if you do not attempt to operate this product for more than about 15 seconds. This product turns off automatically if you do not attempt to operate this product for more than about 1 minute.

Off:

The backlight of the LCD monitor is always on brightly. This product does not turn off automatically.

Note

- This setting works only when using the battery pack.

[188] How to Use | Menu operations | Setup

Initialize

All the settings return to the default.

1. **MENU** - [Setup] - [ General Settings] - [Initialize] - **OK** .

Hint

- Even if you use this function, all movies and photos are retained.

[189] How to Use | Menu operations | Setup

Demo Mode

When this product is connected to a wall outlet (wall socket) using the supplied AC Adaptor and no operation is attempted within a certain period with the movie recording mode or the

Event View mode set, a demonstration movie starts playing.

1. **MENU** - [Setup] - [ General Settings] - [Demo Mode] - desired setting.

Descriptions of menu items

On (default setting):

Make the settings for playback of the demonstration movie.

Off:

The demonstration does not appear.

Note

- In the default setting, the protected demonstration movie is pre-recorded in the Event View. If you delete the demonstration movie, you cannot recover it.
- A movie you have recorded will be registered as the demonstration movie if it satisfies all of the following conditions.
 - The movie is protected.
 - The movie is the one that was recorded first.
 - The movie is saved on the internal memory.
 - The movie is recorded in the AVCHD format.
- When you operate this product during the demonstration playback, it will be suspended.

[190] How to Use | Menu operations | Setup

Version

You can display the software version of this product.

1. **MENU** - [Setup] - [ General Settings] - [Version].

[191] How to Use | Menu operations | Setup

Date & Time Setting

Set the date & time settings.

1. **MENU** - [Setup] - [ Clock Settings] - [Date & Time Setting] - desired setting.

Descriptions of menu items

Date & Time Format:

You can select the order of year, month and day displayed.

Daylight Savings/Summer Time:

Sets the summertime. The clock is set to move the time forward 1 hour.

Date & Time:

You can set the clock.

[192] How to Use | Menu operations | Setup

Area Setting

You can adjust a time difference without stopping the clock. Select your local area when using this product in other time zones.

1. **MENU** - [Setup] - [🕒 Clock Settings] - [Area Setting] - [Home] - desired setting.

Hint

- You can set another place as a [Destination].

[193] How to Use | Charging time/recording time of movies/number of recordable photos | Check the charging time

Charging time

Approximate time (min.) required when you fully charge a fully discharged battery pack.

When using the AC Adaptor

NP-FV70 (supplied):

205 min

NP-FV100:

360 min

When using your computer

NP-FV70 (supplied):

555 min

NP-FV100:

930 min

Hint

- The charging times shown in the table above are measured when charging this product at a temperature of 25 °C (77 °F). It is recommended that you charge the battery in a temperature range of 10 °C to 30 °C (50 °F to 86 °F).
- The charging times are measured without using the USB Connection support cable.

[194] How to Use | Charging time/recording time of movies/number of recordable photos | Expected recording and playback times for individual batteries

Expected recording time with each battery pack

Approximate recording time with each battery pack is shown as follows.

Continuous recording time

NP-FV70 (supplied):

135 min

135 min

NP-FV100

270 min

270 min

Typical recording time

NP-FV70 (supplied):

65 min

65 min

NP-FV100

135 min

135 min

Top:

When the LCD monitor is opened

Bottom:

When recording with the viewfinder without opening the LCD monitor (models with the

viewfinder)

Hint

- Each recording time is measured with the following settings.
 - When [File Format] is set to [4K XAVC S 4K], [REC Mode] is set to [60Mbps 60] and [Frame Rate] is set to [30p]
 - [Dual Video REC] is set to [Off]
- Typical recording time shows the time when you repeat recording start/stop, switching the [Shooting Mode], and zooming.
- Times measured when using this product at 25 °C (77 °F). 10 °C to 30 °C (50 °F to 86 °F) is recommended.
- The recording and playback time will be shorter, depending on the conditions under which you use this product, such as when use this product in low temperatures.

[195] How to Use | Charging time/recording time of movies/number of recordable photos | Expected recording and playback times for individual batteries

Expected playback time with each battery pack

Approximate playback time with each battery pack is shown as follows.

NP-FV70 (supplied):

235 min

235 min

NP-FV100:

470 min

470 min

Top:

When the LCD monitor is opened

Bottom:

When playing with the viewfinder without opening the LCD monitor (models with the viewfinder)

[196] How to Use | Charging time/recording time of movies/number of recordable photos | Expected movie recording time and number of recordable photos for the internal memory

Notes on recording movies

Read the following precautions regarding movie recording.

Note

- The recordable time may vary depending on the recording and subject conditions and [ REC Mode].
- You can record movies of a maximum of 9,999 scenes in XAVC S format or 3,999 scenes in AVCHD format. And you can record a maximum of 40,000 MP4 movies and photos collectively.
- The maximum continuous recording time of a movie is approximately 13 hours.
- This product uses the VBR (Variable Bit Rate) format to automatically adjust image quality to suit the recording scene. This technology causes fluctuations in the recording time of the media. Movies containing quickly moving and complex images are recorded at a higher bit-rate, and this reduces the overall recording time.

[197] How to Use | Charging time/recording time of movies/number of recordable photos | Expected movie recording time and number of recordable photos for the internal memory

Expected recording time of movies (models with the internal memory)

The expected recording time when saving on the internal memory is shown as follows.

XAVC S 4K:

When [ REC Mode] is set to [100Mbps 100].

30p (*)/25p ():**

[Dual Video REC] is set to [On]: 75 min (75 min)

[Dual Video REC] is set to [Off]: 75 min (75 min)

24p (*):

[Dual Video REC] is set to [On]: 75 min (75 min)

[Dual Video REC] is set to [Off]: 75 min (75 min)

When [ REC Mode] is set to [60Mbps 60].

30p (*)/25p ():**

[Dual Video REC] is set to [On]: 120 min (120 min)

[Dual Video REC] is set to [Off]: 125 min (125 min)

24p (*):

[Dual Video REC] is set to [On]: 120 min (120 min)

[Dual Video REC] is set to [Off]: 125 min (125 min)

XAVC S HD:

60p (*)/50p ():**

[Dual Video REC] is set to [Off]: 150 min (150 min)

30p (*)/25p ():**

[Dual Video REC] is set to [On]: 145 min (145 min)

[Dual Video REC] is set to [Off]: 150 min (150 min)

24p (*):

[Dual Video REC] is set to [On]: 145 min (145 min)

[Dual Video REC] is set to [Off]: 150 min (150 min)

AVCHD: (Audio 5.1ch)

60p Quality PS (*)/50p Quality PS ():**

[Dual Video REC] is set to [Off]: 310 min (310 min)

Highest Quality FX:

[Dual Video REC] is set to [On]: 315 min (315 min)

[Dual Video REC] is set to [Off]: 365 min (365 min)

High Quality FH:

[Dual Video REC] is set to [On]: 415 min (415 min)

[Dual Video REC] is set to [Off]: 495 min (495 min)

Standard HQ:

[Dual Video REC] is set to [On]: 650 min (525 min)

[Dual Video REC] is set to [Off]: 870 min (660 min)

Long Time LP:

[Dual Video REC] is set to [On]: 930 min (835 min)

[Dual Video REC] is set to [Off]: 1505 min (1240 min)

* 1080 60i-compatible device

** 1080 50i-compatible device

Note

- The number in () is the minimum recordable time.
- If you want to record up to the maximum recording time, you need to delete the demonstration movie on this product.

[198] How to Use | Charging time/recording time of movies/number of recordable photos | Expected movie recording time and number of recordable photos for the internal memory

Expected number of recordable photos (models with the internal memory)

The expected number of images you can save on the internal memory is shown as follows. You can record a maximum 40,000 photos collectively.

[199] How to Use | Charging time/recording time of movies/number of recordable photos | Expected movie recording time and number of recordable photos for memory cards

Notes on recording movies

Read the following precautions regarding movie recording.

Note

- The recordable time may vary depending on the recording and subject conditions and [ REC Mode].
- You can record movies of a maximum of 9,999 scenes in XAVC S format or 3,999 scenes in AVCHD format. And you can record a maximum of 40,000 MP4 movies and photos collectively.
- The maximum continuous recording time of a movie is approximately 13 hours.
- This product uses the VBR (Variable Bit Rate) format to automatically adjust image quality to suit the recording scene. This technology causes fluctuations in the recording time of the media. Movies containing quickly moving and complex images are recorded at a higher bit-rate, and this reduces the overall recording time.

[200] How to Use | Charging time/recording time of movies/number of recordable photos | Expected movie recording time and number of recordable photos for memory cards

Expected recording time of movies

The expected recording time of movies when saving on a memory card is shown as follows.

16 GB

60p Quality PS (*) / 50p Quality PS (**):

[Dual Video REC] is set to [Off]: 75 min (75 min)

Highest Quality FX :

[Dual Video REC] is set to [On]: 75 min (75 min)

[Dual Video REC] is set to [Off]: 85 min (85 min)

High Quality FH :

[Dual Video REC] is set to [On]: 100 min (100 min)

[Dual Video REC] is set to [Off]: 120 min (120 min)

Standard HQ :

[Dual Video REC] is set to [On]: 155 min (125 min)

[Dual Video REC] is set to [Off]: 210 min (160 min)

Long Time LP :

[Dual Video REC] is set to [On]: 225 min (205 min)

[Dual Video REC] is set to [Off]: 370 min (300 min)

32 GB

60p Quality PS (*) / 50p Quality PS (**):

[Dual Video REC] is set to [Off]: 150min (150 min)

Highest Quality FX :

[Dual Video REC] is set to [On]: 155 min (155 min)

[Dual Video REC] is set to [Off]: 180 min (180 min)

High Quality FH :

[Dual Video REC] is set to [On]: 205 min (205 min)

[Dual Video REC] is set to [Off]: 245 min (245 min)

Standard HQ :

[Dual Video REC] is set to [On]: 315 min (260 min)

[Dual Video REC] is set to [Off]: 430 min (325 min)

Long Time LP :

[Dual Video REC] is set to [On]: 455 min (410 min)

[Dual Video REC] is set to [Off]: 740 min (610 min)

64 GB

4K XAVC S 4K:

When [ REC Mode] is set to [100Mbps₁₀₀].

[Dual Video REC] is set to [On]: 75 min (75 min)

[Dual Video REC] is set to [Off]: 75 min (75 min)

When [ REC Mode] is set to [60Mbps₆₀].

[Dual Video REC] is set to [On]: 120 min (120 min)

[Dual Video REC] is set to [Off]: 125 min (125 min)

 XAVC S HD :

[Dual Video REC] is set to [On]: 145 min (145 min)

[Dual Video REC] is set to [Off]: 155 min (155 min)

 AVCHD :

60p Quality PS (*) / 50p Quality PS ():**

[Dual Video REC] is set to [Off]: 305 min (305 min)

Highest Quality FX :

[Dual Video REC] is set to [On]: 315 min (315 min)

[Dual Video REC] is set to [Off]: 360 min (360 min)

High Quality FH :

[Dual Video REC] is set to [On]: 410 min (410 min)

[Dual Video REC] is set to [Off]: 490 min (490 min)

Standard HQ :

[Dual Video REC] is set to [On]: 635 min (520 min)

[Dual Video REC] is set to [Off]: 865 min (655 min)

Long Time LP :

[Dual Video REC] is set to [On]: 920 min (830 min)

[Dual Video REC] is set to [Off]: 1490 min (1225 min)

128 GB

 XAVC S 4K:

When [ REC Mode] is set to [100Mbps₁₀₀].

[Dual Video REC] is set to [On]: 150 min (150 min)

[Dual Video REC] is set to [Off]: 155 min (155 min)

When [ REC Mode] is set to [60Mbps₆₀].

[Dual Video REC] is set to [On]: 245 min (245 min)

[Dual Video REC] is set to [Off]: 255 min (255 min)

 XAVC S HD :

[Dual Video REC] is set to [On]: 290 min (290 min)

[Dual Video REC] is set to [Off]: 310 min (310 min)

HD AVCHD :

60p Quality PS (*) / 50p Quality PS ():**

[Dual Video REC] is set to [Off]: 610 min (610 min)

Highest Quality FX :

[Dual Video REC] is set to [On]: 630 min (630 min)

[Dual Video REC] is set to [Off]: 720 min (720 min)

High Quality FH :

[Dual Video REC] is set to [On]: 820 min (820 min)

[Dual Video REC] is set to [Off]: 980 min (980 min)

Standard HQ :

[Dual Video REC] is set to [On]: 1290 min (1045 min)

[Dual Video REC] is set to [Off]: 1730 min (1315 min)

Long Time LP :

[Dual Video REC] is set to [On]: 1840 min (1655 min)

[Dual Video REC] is set to [Off]: 2985 min (2450 min)

* 1080 60i-compatible device

** 1080 50i-compatible device

Note

- When using a Sony memory card.
- When recording AVCHD movies with [Audio Mode] set to [5.1ch Surround].
- The number in () is the minimum recordable time.

[201] How to Use | Charging time/recording time of movies/number of recordable photos | Expected movie recording time and number of recordable photos for memory cards

Expected number of recordable photos

The expected number of images you can save on a memory card is shown as follows.

When recording 20.6 M size of images (16:9)

16 GB:

2250 images

32 GB:

4600 images

64 GB:

9200 images

When recording 15.4 M size of images (4:3)**16 GB:**

3050 images

32 GB:

6100 images

64 GB:

12000 images

Note

- When using a Sony memory card.
- The number of recordable photos of memory card shown is for the maximum image size of this product. The actual number of recordable photos is displayed on the LCD monitor during recording.
- The number of recordable photos of memory card may vary depending on the recording conditions.
- The unique image processing system of Sony's BIONZ X allows still image resolution equivalent to the sizes described.

[202] How to Use | Charging time/recording time of movies/number of recordable photos | Bit-rate for each recording mode

Bit-rate and recording pixels

The following list shows the bit-rate, pixels and aspect ratio of each recording mode for movies (movie + audio, etc.).

XAVC S 4K:

When [ REC Mode] is set to [100Mbps .

Approx. 100 Mbps 3,840 × 2,160 pixels/30p(*), 3,840 × 2,160 pixels/25p(**) or 3,840 × 2,160 pixels/24p(*), 16:9

When [ REC Mode] is set to [60Mbps .

Approx. 60 Mbps 3,840 × 2,160 pixels/30p(*), 3,840 × 2,160 pixels/25p(**) or 3,840 × 2,160 pixels/24p(*), 16:9

XAVC S HD:

Approx. 50 Mbps 1,920 × 1,080 pixels/60p(*), 1,920 × 1,080 pixels/50p(**), 1,920 × 1,080 pixels/30p(*), 1,920 × 1,080 pixels/24p(*) or 1,920 × 1,080 pixels/25p(**), 16:9

AVCHD:

PS: Max. 28 Mbps 1,920 x 1,080 pixels/60p(*) or 1,920 x 1,080 pixels/50p(**), AVC HD 28 M (PS), 16:9

FX: Max. 24 Mbps 1,920 x 1,080 pixels/60i(*), 1,920 x 1,080 pixels/50i(**), 1,920 x 1,080 pixels/24p(*) or 1,920 x 1,080 pixels/25p(**), AVC HD 24 M (FX), 16:9

FH: Approx. 17 Mbps (average) 1,920 x 1,080 pixels/60i(*), 1,920 x 1,080 pixels/50i(**), 1,920 x 1,080 pixels/24p(*) or 1,920 x 1,080 pixels/25p(**), AVC HD 17 M (FH), 16:9

HQ: Approx. 9 Mbps (average) 1,440 x 1,080 pixels/60i(*) or 1,440 x 1,080 pixels/50i(**), AVC HD 9 M (HQ), 16:9

LP: Approx. 5 Mbps (average) 1,440 x 1,080 pixels/60i(*) or 1,440 x 1,080 pixels/50i(**), AVC HD 5 M (LP), 16:9

MP4:

Approx. 3 Mbps (average) 1,280 x 720 pixels/30p(*), 1,280 x 720 pixels/24p(*) or 1,280 x 720 pixels/25p(**), 16:9

* 1080 60i-compatible device

** 1080 50i-compatible device

[203] How to Use | Charging time/recording time of movies/number of recordable photos | Pixels recorded at each image size of photos

Recording pixels and aspect ratio

The photo recording pixels and the aspect ratio.

Photo recording mode, Dual Capture:

6,048 × 3,400 dots/16:9(*)

4,528 × 3,400 dots/4:3 (*)

4,288 × 2,408 dots/16:9

3,216 × 2,408 dots/4:3 (*)

1,920 × 1,080 dots/16:9

640 × 480 dots/4:3 (*)

* Not available for Dual Capture

Capturing a photo from a movie:

1,920 × 1,080 dots/16:9

About the AVCHD format

What is the AVCHD format?

The AVCHD format is a high definition digital video camera format used to record a high definition (HD) signal using efficient data compression coding technology. The MPEG-4 AVC/H.264 format is adopted to compress video data, and the Dolby Digital or Linear PCM system is used to compress audio data.

The MPEG-4 AVC/H.264 format is capable of compressing images at higher efficiency than that of the conventional image compressing format.

Hint

- As the AVCHD format uses a compression coding technology, the picture may be disturbed in scenes where picture, field angles or brightness, etc. change drastically, but this is not a malfunction.

About the memory card

- A memory card formatted by a computer (Windows OS/Mac OS) is not guaranteed to be compatible with this product.
- Data read/write speed may vary depending on the combination of the memory card and memory card compliant product you use.
- Data may be damaged or lost in the following cases (the data will not be compensated for):
 - If you eject the memory card, or turn off this product while this product is reading or writing image files on the memory card (while the access lamp is lit or flashing)
 - If you use the memory card near magnets or magnetic fields
- It is recommended that you make a back-up of important data on the hard disk of a computer.
- Do not attach a label or the like on memory card or memory card adaptor.
- Do not touch, or allow metallic objects to come into contact with the terminals.
- Do not bend, drop or apply strong force to the memory card.
- Do not disassemble or modify the memory card.
- Do not allow the memory card to get wet.
- Keep the memory card out of the reach of small children. There is danger that a child might swallow it.
- Do not insert anything other than the compliant size of memory card into the memory card

slot. Doing so may cause a malfunction.

- Do not use or keep the memory card in the following locations:
 - Places subject to extremely high temperature, such as a car parked outside in the sun
 - Places under direct sunlight
 - Places with extremely high humidity or subject to corrosive gases

On types of memory card you can use with this product

- You can use only Memory Stick PRO Duo media which is half as large as that of Memory Stick media or a standard sized SD card.

On the memory card adaptor

- If using the memory card adaptor to allow use of a memory card in a device compatible with memory cards, make sure that the memory card is inserted facing in the correct direction. If the memory card is not inserted to the end, it may not work correctly.

On image data compatibility

- Image data files recorded on memory card by this product conform to the “Design rule for Camera File system” universal standard established by the JEITA (Japan Electronics and Information Technology Industries Association).
- If you cannot use memory cards that have been used with another device, format it with this product. Note that formatting erases all information on the memory card.
- You may not be able to play back images with this product:
 - When playing back image data modified on your computer
 - When playing back image data recorded with other devices

About the Memory Stick media

Memory Stick PRO Duo media (Mark2):

Recording/Playback: supported (*)

Memory Stick PRO-HG Duo media :

Recording/Playback: supported (*)

Memory Stick XC-HG Duo media :

Recording/Playback: supported (*)

* Except for XAVC S format

- This product does not support 8-bit parallel data transfer but it supports 4-bit parallel data transfer the same as with Memory Stick PRO Duo media.
- This product cannot record or play back data that uses MagicGate technology. MagicGate is a copyright protection technology that records and transfers the contents in an encrypted format.

Movies saved on Memory Stick XC-HG Duo media or SDXC memory cards cannot be imported to or played back on computers or AV devices not supporting the exFAT(*) file system by connecting this product to these devices with the USB cable. Confirm in advance that the connecting equipment is supporting the exFAT system. If you connect equipment not supporting the exFAT system and the format screen appears, do not perform the format. All the data saved will be lost.

* The exFAT is a file system that is used for Memory Stick XC-HG Duo media or SDXC memory cards.

[206] How to Use | Additional information | Precautions

About the InfoLITHIUM battery pack

This product operates only with an InfoLITHIUM V series battery packs. InfoLITHIUM V series battery packs have the  mark.

What is an InfoLITHIUM battery pack?

- An InfoLITHIUM battery pack is a lithium-ion battery pack that has functions for communicating information related to operating conditions between this product and an AC Adaptor/charger (sold separately).
- The InfoLITHIUM battery pack calculates the power consumption according to the operating conditions of this product, and displays the remaining battery capacity in minutes.

To charge the battery pack

- Be sure to charge the battery pack before you start using this product.
- We recommend that you charge the battery pack in an ambient temperature range of 10 °C to 30 °C (50 °F to 86 °F) until the POWER/CHG (charge) lamp turns off. If you charge the battery pack outside of this temperature range, you may not be able to charge it efficiently.
- The POWER/CHG (charge) lamp flashes during charging under the following conditions.
 - The battery pack is not inserted correctly.
 - The battery pack is damaged.
 - The temperature of the battery pack is low.
Remove the battery pack from this product and put it in a warm place.
 - The temperature of the battery pack is high.
Remove the battery pack from this product and put it in a cool place.

To use the battery pack effectively

- Battery pack performance decreases when the ambient temperature is 10 °C (50 °F) or below, and the length of time you can use the battery pack becomes shorter. If that happens, one of the following is recommended to enable longer use of the battery pack:
 - Put the battery pack in a pocket to warm it up, and install it on this product immediately before you start shooting.
 - Use a large capacity battery pack: NP-FV100 (sold separately).
- Frequent use of the LCD monitor or a frequent playback, fast forward or reverse operation wears out the battery pack faster.
- Be sure to close the LCD monitor when not recording or playing back on this product. The battery pack is also consumed when this product is in recording standby or playback pause.
- Have spare battery packs ready for 2 or 3 times the expected recording time, and make trial recordings before making the actual recording.
- Do not expose the battery pack to water. The battery pack is not water resistant.

About the remaining battery power indicator

- When the power goes off even though the remaining battery power indicator indicates that the battery pack has enough power to operate, charge the battery pack fully again. Remaining battery power will be indicated correctly. Note, however, that the battery indication will not be restored if it is used in high temperatures for a long time, or if left in a fully charged state, or when the battery pack is frequently used.
- Depending on the operating conditions or ambient temperature, the  icon that indicates a low battery may flash even if there are still 20 minutes of power remaining.

About storage of the battery pack

- If the battery pack is not used for a long time, fully charge the battery pack and use it up on this product once a year to maintain proper function. To store the battery pack, remove it from this product and put it in a dry, cool place.
- To discharge the battery pack on this product completely, select **[MENU]** - **[Setup]** -  **General Settings** - **[Power Save]** - **[Off]**, and leave this product in recording standby until the power goes off.

About battery life

- Battery capacity decreases over time and through repeated use. If the interval between charges becomes significantly short, the battery pack may need to be replaced with a new one.
- Each battery's life depends on storage, operating and environmental conditions.

On use and care

On recording

- Before starting to record, test the recording function to make sure the image and sound are recorded without any problems.
- Compensation for the contents of recordings cannot be provided, even if recording or playback is not possible due to a malfunction of this product, recording media, etc.
- TV color systems differ depending on the country/region. To view your recordings on a TV, you need a TV that supports the signal format for this product.
- Television programs, films, video tapes, and other materials may be copyrighted. Unauthorized recording of such materials may be contrary to the copyright laws.

LCD monitor

- The LCD monitor is manufactured using extremely high-precision technology, so over 99.99% of the pixels are operational for effective use. However, there may be some tiny black points and/or bright points (white, red, blue, or green in color) that appear constantly on the LCD monitor. These points are normal results of the manufacturing process and do not affect the shooting in any way.

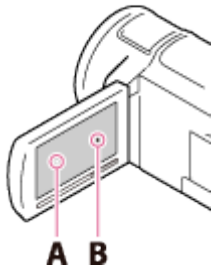

A: White, red, blue or green points

B: Black points

About this Help Guide, illustrations and on-screen displays

- The example images used in this Help Guide for illustration purposes are captured using a digital still camera, and therefore may appear different from images and screen indicators that actually appear on this product. And, the illustrations of this product and its screen indication are exaggerated or simplified for understandability.
- Design and specifications of this product and accessories are subject to change without notice.
- In this Help Guide, DVD discs recorded with high definition image quality (HD) are called AVCHD disc.
- In this Help Guide, the internal memory (models with the internal memory) and memory card are called “recording media.”

On use and storage place

- This product is not dustproofed, dripproofed or waterproofed.

- Do not hold this product by the following parts, and also do not hold this product by the jack covers.

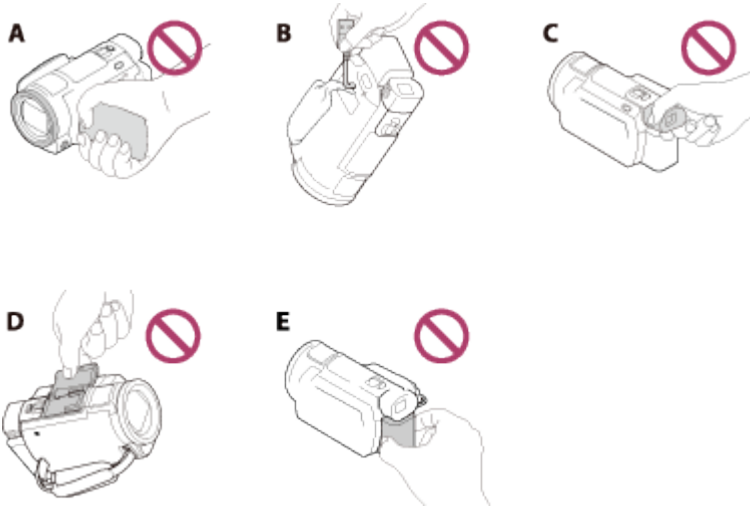

A: LCD monitor

B: Built-in USB Cable

C: Viewfinder (models with the viewfinder)

D: Shoe cover

E: Battery pack

- Do not aim this product at the sun. Doing so might cause this product to malfunction. Take images of the sun only in low light conditions, such as at dusk.
- Do not use or store this product and accessories in the following locations:
 - Anywhere extremely hot, cold or humid. Never leave them exposed to temperatures above 60 °C (140 °F), such as under direct sunlight, near heaters or in a car parked in the sun. They may malfunction or become deformed.
 - Near strong magnetic fields or mechanical vibration. This product may malfunction.
 - Near strong radio waves or radiation. This product may not be able to record properly.
 - Near tuner devices such as TVs or radio. Noise may occur.
 - On a sandy beach or anywhere dusty. If sand or dust gets in this product, it may malfunction. Sometimes this malfunction cannot be repaired.
 - Near windows or outdoors, where the LCD monitor, the viewfinder (models with the viewfinder), or the lens may be exposed to direct sunlight. This damages the inside of the LCD monitor or the viewfinder.
- For DC or AC operation, use the accessories recommended in these operating instructions.
- Do not let your product get wet, for example, from rain or sea water. If your product gets wet, it may malfunction. Sometimes this malfunction cannot be repaired.
- If any solid object or liquid gets inside the casing, unplug your product and have it checked by a Sony dealer before operating it any further.
- Avoid rough handling, disassembling, modifying, physical shock, or impact such as hammering, dropping or stepping on the product. Be particularly careful with the lens.
- Keep the LCD monitor closed and the viewfinder retracted when you are not using your product (models with the viewfinder).
- Do not operate your product with it wrapped in an object such as a towel.
- When disconnecting the cable, pull it by the plug and not the cord.

- Do not damage the cable such as by placing anything heavy on it.
- Do not use a deformed or damaged battery pack.
- Keep metal contacts clean.
- If the battery electrolytic liquid has leaked:
 - Consult your local authorized Sony service facility.
 - Wash off any liquid that may have contacted your skin.
 - If any liquid gets in your eyes, wash with plenty of water and consult a doctor.

When not using this product for a long time

- To keep this product in optimum state for a long time, turn it on and let it run by recording and playing back images about once a month.
- Use up the battery pack completely before storing it.

Note on this product/battery pack temperature

- When the temperature of this product or battery pack becomes extremely high or extremely low, you may not be able to record or play back on this product, due to the protection features of this product being activated in such situations. In this case, an indicator appears on the LCD monitor or the viewfinder (models with the viewfinder).

Notes on charging through the Built-in USB Cable

- Charging may not be possible with all computers.
- If you connect this product to a laptop computer that is not connected to a power source, the battery of the laptop computer will continue to use up its charge. Do not leave this product connected to a computer in this manner.
- Charging with a personally assembled computer, with a converted computer, or through a USB hub are not guaranteed. This product may not function correctly depending on the USB device which is used with the computer.
- When charging, cancel the sleep mode of the computer.

LCD monitor

- Do not apply excessive pressure on the LCD monitor, as it may cause uneven color and other damage.
- If this product is used in a cold place, a residual image may appear on the LCD monitor. This is not a malfunction.
- While using this product, the back of the LCD monitor may heat up. This is not a malfunction.

Multi interface shoe

- When using a dedicated microphone or portable speaker, their power turns on or off according to the power of this product.
- Refer to the operating instructions supplied with the accessory used for details.
- To attach an accessory, insert and fix the accessory to the Multi interface shoe by pressing down and sliding forward until it stops. Remove the accessory by pressing it

down.

- When you are recording movies with an external flash (sold separately) connected to the Multi interface shoe, turn off the power of the external flash to prevent charging noise from being recorded.
- When an external microphone (sold separately) is connected, it takes precedence over the built-in microphone.

On the pre-installed rechargeable battery

- This product has a pre-installed rechargeable battery to retain the date, time, and other settings even when the LCD monitor is closed. The pre-installed rechargeable battery is always charged while this product is connected to a wall outlet (wall socket) via the AC Adaptor or while the battery pack is inserted. The rechargeable battery will be fully discharged in about 2 months if you do not use this product at all. Charge the pre-installed rechargeable battery before you start using this product. However, even if the pre-installed rechargeable battery is not charged, this product operation other than date recording will not be affected.

How to charge the pre-installed rechargeable battery

Connect this product to a wall outlet (wall socket) using the supplied AC Adaptor, and leave it with the LCD monitor closed for more than 24 hours.

[208] How to Use | Additional information | Handling of this product

On connecting to a computer or accessory etc.

- Do not try to format the recording media of this product with a computer. If you do so, this product may not operate correctly.
- When connecting this product to another device with communication cables, be sure to insert the connector plug in the correct way. Pushing the plug forcibly into the terminal will damage the terminal and may result in a malfunction of this product.
- When this product is connected to other devices through a USB connection and the power of this product is turned on, do not close the LCD monitor. The image data that has been recorded may be lost.

[209] How to Use | Additional information | Handling of this product

Notes on optional accessories

-
- We recommend using genuine Sony accessories.
 - Genuine Sony accessories may not be available in some countries/regions.

[210] [How to Use](#) | [Additional information](#) | [Handling of this product](#)

On moisture condensation

If this product is brought directly from a cold place to a warm place, moisture may condense inside this product. This may cause a malfunction to this product.

If moisture condensation occurs

Leave this product for about 1 hour without turning it on.

Where moisture condensation frequently occurs

Moisture may condense when you bring this product from a cold place into a warm place (or vice versa) or when you use this product in a humid place as follows:

- You bring this product from a ski slope into a place warmed up by a heating device.
- You bring this product from an air conditioned car or room into a hot place outside.
- You use this product after a squall or a rain.
- You use this product in a hot and humid place.

How to prevent moisture condensation

When you bring this product from a cold place into a warm place, put this product in a plastic bag and seal it tightly. Remove the bag when the air temperature inside the plastic bag has reached the surrounding temperature (after about 1 hour).

[211] [How to Use](#) | [Additional information](#) | [Handling of this product](#)

Notes on disposal/transfer the ownership of this product (models equipped with the internal memory)

Even if you delete all movies and still images, or perform [Format], data on the internal memory may not be completely erased. It is recommended that you perform [Empty] to prevent the recovery of your data.

For the network related information on this product, perform [Network Info Reset] to reset the connection information.

Note on disposal/transfer of the memory card

Even if you [Delete] data in the memory card or [Format] the memory card on this product or a computer, you may not delete data from the memory card completely. When you give the memory card to somebody, it is recommended that you delete data completely using data deletion software on a computer. Also, when you dispose of the memory card, it is recommended that you destroy the actual body of the memory card.

On handling the LCD monitor

- If you leave fingerprints, hand cream, etc. on the LCD monitor, the coating of the LCD monitor will come off easily. Wipe those off as soon as possible.
- If you wipe the LCD monitor strongly with a tissue, etc., the coating of the LCD monitor may be scratched.
- If the LCD monitor becomes dirty with fingerprints or dust, it is recommended that you gently remove those from the screen then clean it with a soft cloth, etc.

To clean the casing and the projector lens surface (models with the projector)

- Wipe the casing and the lens gently with a soft cloth such as a cleaning cloth or eyeglass cleaning cloth.
- If the casing and the projector lens are very dirty, clean the casing of this product and the lens with a soft cloth lightly moistened with water, and then wipe the casing and the projector lens with a dry soft cloth.
- Avoid the following so as not to deform the casing, damage the finish or scratch the lens:
 - Using chemicals such as thinner, benzene, alcohol, chemical cloths, insect repellent, insecticide and sunscreen
 - Handling this product with the above substances on your hands

- Leaving this product in contact with rubber or vinyl objects for a long period of time

[215] [How to Use](#) | [Additional information](#) | [Maintenance](#)

About care and storage of the lens

- Wipe the surface of the lens clean with a soft cloth in the following instances:
 - When there are fingerprints on the lens surface
 - In hot or humid locations
 - When the lens is exposed to salty air such as at the seaside
- Store in a well-ventilated location subject to little dirt or dust.
- To prevent mold, periodically clean and store the lens as described above.

[216] [How to Use](#) | [Additional information](#) | [Using this product abroad](#)

Using this product abroad

Power supply

- You can use this product in any countries/regions using the AC Adaptor supplied with this product within the AC 100 V to 240 V, 50 Hz/60 Hz range. You can also charge the battery pack.

Viewing images in 4K

- To view 4K images in 4K, you need the HDMI cable and a 4K compatible TV (or a monitor). Refer to “On TV color systems” for countries and regions where the playback signal format of this product is supported.

Viewing images on a TV connected

- To view images on a TV (or monitor), you need to connect this product to a TV (or monitor) using the HDMI cable (supplied) or AV cable (sold separately). Refer to “On TV color systems” for countries and regions where the playback signal format of this product is supported.

Viewing high definition image quality (HD) movies

- In countries/regions where high definition image quality (HD) broadcasts are supported,

you can view recorded movies on a TV at the same high definition image quality (HD) as they were recorded with this product.

To view images at the same high definition image quality (HD) as they were recorded with this product, you need the HDMI cable and a high definition TV (or monitor) that supports the signal format for this product and is equipped with an HDMI jack.

On TV color systems

- For signal formats supported by this product, refer to “Model Information.” To view images in this product on TV, use a TV (or monitor) that supports the signal format of this product.

PAL:

Australia, Austria, Belgium, China, Czech Republic, Denmark, Finland, Germany, Holland, Hong Kong, Hungary, Italy, Kuwait, Malaysia, New Zealand, Norway, Poland, Portugal, Singapore, Slovak Republic, Spain, Sweden, Switzerland, Thailand, United Kingdom, etc.

PAL-M:

Brazil

PAL-N:

Argentina, Paraguay, Uruguay

NTSC:

Bahama Islands, Bolivia, Canada, Central America, Chile, Colombia, Ecuador, Guyana, Jamaica, Japan, Korea, Mexico, Peru, Surinam, Taiwan, the Philippines, the USA, Venezuela, etc.

SECAM:

Bulgaria, France, Guiana, Iran, Iraq, Monaco, Russia, Ukraine, etc.

Setting to the local time

- You can easily set the clock to the local time by setting a time difference when using this product abroad. Select **MENU** - [Setup] - [Clock Settings] - [Daylight Savings] or [Summer Time], and **MENU** - [Setup] - [Clock Settings] - [Area Setting].

[217] How to Use | Additional information | Trademarks

On trademarks

- Handycam and **HANDYCAM** are registered trademarks of Sony Corporation.

- AVCHD, AVCHD logotype, AVCHD Progressive and AVCHD Progressive logotype are trademarks of Panasonic Corporation and Sony Corporation.
- XAVC and **XAVC S** are registered trademarks of Sony Corporation.
- PlayMemories Home, the PlayMemories Home logo, PlayMemories Online, the PlayMemories Online logo, PlayMemories Mobile and the PlayMemories Mobile logo are trademarks of Sony Corporation.
- Memory Stick, , Memory Stick Duo, **MEMORY STICK DUO**, Memory Stick PRO Duo, **MEMORY STICK PRO DUO**, Memory Stick PRO-HG Duo, **MEMORY STICK PRO-HG DUO**, Memory Stick XC-HG Duo, **MEMORY STICK XC-HG DUO**, MagicGate, **MAGIC GATE**, MagicGate Memory Stick and MagicGate Memory Stick Duo are trademarks or registered trademarks of Sony Corporation.
- InfoLITHIUM is a trademark of Sony Corporation.
- BIONZ X is a trademark of Sony Corporation.
- BRAVIA and Photo TV HD are trademarks of Sony Corporation.
- Blu-ray Disc™ and Blu-ray™ are trademarks of the Blu-ray Disc Association.
- Dolby and the double-D symbol are trademarks of Dolby Laboratories.
- The terms HDMI and HDMI High-Definition Multimedia Interface, and the HDMI Logo are trademarks or registered trademarks of HDMI Licensing LLC in the United States and other countries.
- Microsoft, Windows, Windows Vista, and DirectX are either registered trademarks or trademarks of Microsoft Corporation in the United States and/or other countries.
- Mac and Mac OS are registered trademarks of Apple Inc. in the United States and other countries.
- iPhone and iPad are trademarks of Apple Inc., registered in the U.S. and other countries.
- iOS is a registered trademark or trademark of Cisco Systems, Inc.
- Intel, Pentium and Intel Core are trademarks of Intel Corporation in the U.S. and/or other countries.
- Android and Google Play are trademarks of Google Inc.
- Wi-Fi, the Wi-Fi logo, Wi-Fi PROTECTED SET-UP, Wi-Fi Direct, WPA and WPA2 are registered trademarks of the Wi-Fi Alliance.
- DLNA and DLNA CERTIFIED are trademarks of Digital Living Network Alliance.
- The N mark is a trademark or registered trademark of NFC Forum, Inc. in the United States and in other countries.
- SDXC logo is a trademark of SD-3C, LLC.
- Facebook and the “f” logo are trademarks or registered trademarks of Facebook, Inc.
- Twitter and the Twitter logo are trademarks or registered trademarks of Twitter, Inc.
- All other product names mentioned herein may be the trademarks or registered trademarks of their respective companies. Furthermore, ™ and ® are not mentioned in each case in this Help Guide.

Notes on the License

THIS PRODUCT IS LICENSED UNDER THE AVC PATENT PORTFOLIO LICENSE FOR THE PERSONAL AND NON-COMMERCIAL USE OF A CONSUMER TO

(i) ENCODE VIDEO IN COMPLIANCE WITH THE AVC STANDARD ("AVC VIDEO") AND/OR

(ii) DECODE AVC VIDEO THAT WAS ENCODED BY A CONSUMER ENGAGED IN A PERSONAL AND NON-COMMERCIAL ACTIVITY AND/OR WAS OBTAINED FROM A VIDEO PROVIDER LICENSED TO PROVIDE AVC VIDEO.

NO LICENSE IS GRANTED OR SHALL BE IMPLIED FOR ANY OTHER USE.

ADDITIONAL INFORMATION MAY BE OBTAINED FROM MPEG LA, L.L.C.

SEE <[HTTP://WWW.MPEGLA.COM](http://www.mpegla.com)>

We provide the software in this product based on license agreements with the owners of the respective copyrights. Based on requests by the owners of copyright of these software applications, we have an obligation to inform you of the following. Please read the following sections.

Copies of the licenses (in English) are stored in the internal memory of this product.

Establish a Mass Storage connection between this product and a computer, and read the files in the "LICENSE" folder in "PMHOME."

On GNU GPL/LGPL applied software

The software that is eligible for the following GNU General Public License (hereinafter referred to as "GPL") or GNU Lesser General Public License (hereinafter referred to as "LGPL") are included in this product.

This informs you that you have a right to have access to, modify, and redistribute source code for these software programs under the conditions of the supplied GPL/LGPL.

Source code is provided on the web. Use the following URL to download it. When downloading the source code, select HDR-PJ670 as the model for this product.

<http://oss.sony.net/Products/Linux>

We would prefer you do not contact us about the contents of source code.

Copies of the licenses (in English) are stored in the internal memory of this product.

Establish a Mass Storage connection between this product and a computer, and read the files in the "LICENSE" folder in "PMHOME."

Zoom magnifications

When recording a movie with SteadyShot set to [Active]

4K :

15 times

HD:

20 times

When recording a movie or photo with SteadyShot set to [Standard] or [Off]

10 times

When [Digital Zoom] is set to [120x]

120 times

[220] How to Use | Additional information | Using this product after a long time

Using this product after a long time

In case you have not used this product for several months, check the following before use.

- When the date and clock settings are initialized, reset it by selecting **MENU** - [Setup] - [ Clock Settings] - [Date & Time Setting].
- Be sure to charge the battery of this product before use. For details, see “Charging the battery pack using the AC Adaptor.”
- It may be required to change the movie format to view images recorded in the past. For details, see “Playing MP4 Movies (HD movie) (switching the movie format).”

[221] Troubleshooting | Troubleshooting | If you have problems

If you have problems

If you run into any problems using this product, follow the steps below.

1. Check the items under “Troubleshooting,” and inspect this product.
2. Disconnect the power source, attach the power source again after about 1 minute, and turn this product on.
3. Perform [Initialize].

- If you select [Initialize], all settings, including the clock setting, are reset.

4. Contact your Sony dealer or local authorized Sony service facility.

Note

- You may need to initialize or change the current internal memory (Models with the internal memory) of this product depending on the problem.
If you do so, the data stored on the internal memory (Models with the internal memory) will be deleted. Be sure to save the data on the internal memory (Models with the internal memory) on other media (backup) before sending this product for repair. We will not compensate you for any loss of internal memory (Models with the internal memory) data.
- During repair, we may check a minimum amount of data stored on the internal memory (Models with the internal memory) in order to investigate the problem. However, your Sony dealer will neither copy nor retain your data.

[222] Troubleshooting | Troubleshooting | Overall operations

The power does not turn on.

-
- Attach a charged battery pack to this product.
 - The plug of the AC Adaptor has been disconnected from a wall outlet (wall socket).
Connect it to a wall outlet (wall socket).



[223] Troubleshooting | Troubleshooting | Overall operations

This product does not operate even when the power is set to on.

-
- Disconnect the AC Adaptor from a wall outlet (wall socket) or remove the battery pack, then reconnect it after about 1 minute.

[224] Troubleshooting | Troubleshooting | Overall operations

The menu settings have been changed automatically.

- While Intelligent Auto is active, some menu settings related to image quality will be changed automatically.
- The following menu items return to the default settings when you switch between movie recording, photo recording and playback modes.
 - [ Fader]
 - [ Self-Timer]

[225] Troubleshooting | Troubleshooting | Overall operations

This product gets warm.

- This product may become warm during operation. This is not a malfunction.

[226] Troubleshooting | Troubleshooting | Overall operations



A rattling noise is heard when this product is shaken.

- If no noise is heard when this product is turned on and is in movie/photo recording mode, the noise is produced by the movement of the internal lens. This is not a malfunction.

[227] Troubleshooting | Troubleshooting | Overall operations

Intelligent Auto is canceled.

- The Intelligent Auto setting is canceled if you change the following settings:
 - [Smth Slw REC]
 - [Golf Shot]
 - [High Speed REC]
 - [White Balance]
 - [Spot Meter/Fcs]
 - [Spot Meter]
 - [Spot Focus]
 - [Exposure]
 - [Focus]
 - [IRIS]

- [Shutter Speed]
- [AGC Limit]
- [AE Shift]
- [White Balance Shift]
- [Low Lux]
- [Scene Selection]
- [Picture Effect]
- [ Cinematone]
- [ SteadyShot]
- [Auto Back Light]
- [Face Detection]

[228] Troubleshooting | Troubleshooting | Batteries/power sources

The power abruptly turns off.

- Use the AC Adaptor.
- In the default setting, this product turns itself off when no operations are performed for more than about 2 minutes ([Power Save]). Change the setting of [Power Save], or turn on the power again.
- Charge the battery pack.

[229] Troubleshooting | Troubleshooting | Batteries/power sources

The POWER/CHG (charge) lamp does not light while the battery pack is being charged.

- Turn off this product.
- Attach the charged battery pack to this product correctly.
- Connect the power cord (mains lead) to a wall outlet (wall socket) properly.
- The battery charge is completed.

[230] Troubleshooting | Troubleshooting | Batteries/power sources

The POWER/CHG (charge) lamp flashes while the battery pack is being charged.

-
- When the battery is being charged using the Built-in USB Cable, disconnect the Built-in USB Cable and connect it again.
 - If the temperature of the battery pack is too high or too low, you may not be able to charge it.
 - Attach the charged battery pack to this product correctly. If the problem persists, disconnect the AC Adaptor from a wall outlet (wall socket) and contact your Sony dealer. The battery pack may be damaged.

[231] Troubleshooting | Troubleshooting | Batteries/power sources

The remaining battery power is not displayed correctly.

- The ambient temperature is too high or too low. This is not a malfunction.
- The battery pack has not been charged enough. Fully charge the battery again. If the problem persists, replace the battery pack with a new one.
- The indicated remaining battery power may not be correct depending on the environment in which this product is used.

[232] Troubleshooting | Troubleshooting | Batteries/power sources

The battery pack is quickly discharged.

- The ambient temperature is too high or low. This is not a malfunction.
- The battery pack has not been charged enough. Fully charge the battery again. If the problem persists, replace the battery pack with a new one.

[233] Troubleshooting | Troubleshooting | Monitor

Menu items are grayed out.

- You cannot select grayed out items in the current recording/playback situation.
- There are some functions you cannot activate simultaneously.

[234] Troubleshooting | Troubleshooting | Monitor

The buttons do not appear on the LCD monitor.

- Touch the LCD monitor lightly.
-

[235] Troubleshooting | Troubleshooting | Monitor

The buttons on the touch panel do not work correctly or do not work at all.

- Adjust the touch panel ([Calibration]).
-

[236] Troubleshooting | Troubleshooting | Monitor

The buttons on the LCD monitor quickly disappear.

- If you set [Display Setting] to [On], the buttons do not disappear from the LCD monitor while in recording mode.
-

[237] Troubleshooting | Troubleshooting | Monitor

There are dots in the shape of a grid on the monitor.

- These dots are a normal result of the manufacturing process of the monitor and do not affect the recording in any way.
-

[238] Troubleshooting | Troubleshooting | Monitor

The backlight of the LCD monitor turns off if you do not attempt to operate this product for a while.

-
- In the default setting, the backlight of the LCD monitor turns off automatically if you do not attempt to operate this product for more than about 1 minute ([Power Save]).

[239] Troubleshooting | Troubleshooting | Viewfinder

The image in the viewfinder is not clear (models with the viewfinder).

-
- Move the viewfinder lens adjustment lever until the image appears clearly.

[240] Troubleshooting | Troubleshooting | Viewfinder

The image in the viewfinder is no-longer displayed (models with the viewfinder).

-
- Close the LCD monitor. Even if the viewfinder is pulled out, no image is displayed in the viewfinder when the LCD monitor is open.

[241] Troubleshooting | Troubleshooting | Memory card

Operations using the memory card cannot be performed.

-
- If you use the memory card formatted on a computer, format it again on this product.
 - When you select XAVC S format in [File Format], use an SDXC memory card Class 10 or faster.
 - When you record an 4K XAVC S 4K movie with [REC Mode] set to [100Mbps100], use an SDXC memory card of UHS-I U3 or faster.

[242] Troubleshooting | Troubleshooting | Memory card

Images stored on the memory card cannot be deleted.

-
- The maximum number of images that you can delete on the index screen at one time is 100.
 - You cannot delete the protected images.

[243] Troubleshooting | Troubleshooting | Memory card

The data file name is not indicated correctly or flashes.

-
- The file is damaged.
 - The file format is not supported by this product.

[244] Troubleshooting | Troubleshooting | Memory card

Images cannot be played back or the memory card is not recognized.

-
- The playback device does not support the playing back of memory cards.

[245] Troubleshooting | Troubleshooting | Recording

Pressing START/STOP or PHOTO does not record images.

-
- The playback screen is displayed. Stop playback, and select **MENU** - [Shooting Mode] - [Movie] or [Photo].
 - This product is recording the image you have just shot on the recording media. You cannot make new recording during this period.
 - The recording media is full. Delete unnecessary images.
 - Total number of movie scenes or photos exceeds the recordable capacity of this product. Delete unnecessary images.

Photos cannot be recorded.

- You cannot record photos together with:
 - [Smth Slw REC]
 - [Golf Shot]
 - [High Speed REC]
 - [Fader]
 - When [File Format] is set to [XAVC S 4K] and [Dual Video REC] is set to [On], you cannot shoot photos while recording a movie in movie recording mode.
 - This product cannot shoot photos while it is in movie recording mode, depending on the [REC Mode] or [Frame Rate] selected.
 - When you select a [Picture Effect] item, you cannot record photos in the movie recording mode.
-

The access lamp remains lit or flashing even if recording has stopped.

- This product is recording the scene you have just shot on the memory card.
-

The imaging field looks different.

- The imaging field may look different depending on the condition of this product. This is not a malfunction.
-

The actual recording time for movies is less than the expected recording time of the recording media.

-
- Depending on the recording conditions, the time available for recording may be shorter, for example when recording a fast moving object, etc.

[250] Troubleshooting | Troubleshooting | Recording

This product stops recording.

-
- If you keep applying vibration on this product, recording may stop.

[251] Troubleshooting | Troubleshooting | Recording

There is a slight time lag between the moment when START/STOP is pressed and the actual movie recording starts or stops.

-
- On this product, there may be a slight time difference between the moment when you press START/STOP and when the actual movie recording starts/stops. This is not a malfunction.

[252] Troubleshooting | Troubleshooting | Recording



The auto focus does not function.

-
- Set [Focus] to [Auto].
 - If auto focus does not lock to on the subject, adjust the focus manually.

[253] Troubleshooting | Troubleshooting | Recording

SteadyShot does not function.

Set [ SteadyShot] to [Active] or [Standard], or set [ SteadyShot] to [On].

- Even if [ SteadyShot] is set to [Active] or [Standard], or [ SteadyShot] is set to [On], this product may not be able to compensate for excessive vibrations.

[254] Troubleshooting | Troubleshooting | Recording

Images cannot be recorded or played back correctly.

- If you record and delete images repeatedly for a long time, the files on the recording media may become fragmented and images cannot be recorded or played back correctly. After backing up the images on other media, perform [Format] of the recording media on this product.

[255] Troubleshooting | Troubleshooting | Recording

The subjects passing across this product very fast appear crooked.

- This is called the focal plane phenomenon. This is not a malfunction. Because of the way the image device (CMOS sensor) reads out image signals, the subjects passing by the lens rapidly might appear crooked depending on the recording conditions.

[256] Troubleshooting | Troubleshooting | Recording

Horizontal stripes appear on the images.

- Horizontal stripes may appear on the LCD monitor when recording images under a fluorescent lamp, sodium lamp, mercury lamp, or LED light. You may be able to improve the situation by adjusting the shutter speed.

[257] Troubleshooting | Troubleshooting | Recording

[Monitor Brightness] cannot be set.

-
- You cannot set [Monitor Brightness] when:
 - The LCD monitor is closed on this product with the LCD monitor facing out.
 - The power is supplied from the AC Adaptor.

[258] Troubleshooting | Troubleshooting | Recording

Sound is not recorded correctly.

- If you connect or disconnect an external microphone, etc. while recording movies, the sound may not be recorded correctly. The sound will be recorded correctly by restoring the microphone connection at the start of movie recording.
- If you turn the volume down to the minimum level by adjusting in [Audio Rec Level], the sound of movies cannot be recorded.

[259] Troubleshooting | Troubleshooting | Recording

Photos are recorded automatically.

- When [Smile Shutter] is set to [Dual Capture] or [Always On], photos are recorded automatically when this product detects a smile.

[260] Troubleshooting | Troubleshooting | Playback

Images cannot be played back.

- Select the type of recording media you want to play back. (models with the internal memory)
- Select the movie type (XAVC S/AVCHD/MP4) you want to play with the movie format select button.
- Images recorded on other devices may not be played back. This is not a malfunction.
- To play movie files edited on a computer or other equipment and written back to the recording media, but where no image appears on the Event View screen, perform [Repair Img. DB F.].
- To play a movie recorded in [4K] XAVC S 4K] format, make sure to set [Frame

Rate] to the same value (30p or 24p) you set when recording. If not, you cannot play the movie, and a thumbnail does not appear on the LCD monitor (1080 60i-compatible device).

[261] Troubleshooting | Troubleshooting | Playback

Photos cannot be played back.

- You may not be able to play back photos if you have changed file or folder names, or have edited the data on a computer. (The file name flashes in that case.) This is not a malfunction.
-



[262] Troubleshooting | Troubleshooting | Playback

The movie freezes.

- Photos which were recorded while recording a movie are played back. In the default setting, movies and photos are played back continuously.
-

[263] Troubleshooting | Troubleshooting | Playback

An icon appears on a thumbnail.

- The image data base file may be damaged. Check the data base file by selecting **MENU** - [Setup] - [Media Settings] - [Repair Img. DB F.] - the recording medium. If it still appears, delete the image with .
 -  may appear on an image recorded on other devices, edited on a computer, etc.
 - You removed the AC Adaptor or the battery pack while the recording media icon at the top right corner of the screen is lit, or before the access lamp is turned off after recording. This may damage your image data and  is displayed.
-

[264] Troubleshooting | Troubleshooting | Playback

No sound or only a quiet sound is heard during

playback.

- Turn up the volume.
 - If you turn the volume down to the minimum level by adjusting in [Audio Rec Level], the sound of movies cannot be recorded.
 - Sounds are not recorded while shooting with [Smth Slw REC] or [Golf Shot].
-

[265] Troubleshooting | Troubleshooting | Playback

Left and right sound is heard unbalanced when playing back movies on computers or other devices.

- Change the sound conversion type (downmix type) when playing back on 2ch stereo devices. Refer to the instruction manual supplied with your playback device for details.
 - Change the sound to 2ch when creating a disc using the PlayMemories Home software.
 - This happens when sound recorded in 5.1ch surround is converted to 2ch (normal stereo sound) by a computer or other device. This is not a malfunction.
 - Record sound with [Audio Mode] set to [2ch Stereo].
-

[266] Troubleshooting | Troubleshooting | Wi-Fi

The wireless access point you want to connect to does not appear.

- Depending on the signal conditions, the wireless access point may not appear on this product. Move this product closer to the wireless access point.
 - Depending on its setting, the wireless access point may not appear on this product. Refer to the instruction manual for the wireless access point for the correct settings.
-

[267] Troubleshooting | Troubleshooting | Wi-Fi

[WPS Push] does not work.

- Depending on the wireless access point setting, [WPS Push] may not be available. Confirm the password and SSID of the wireless access point to set [Access point settings].
-

[268] Troubleshooting | Troubleshooting | Wi-Fi

[Ctrl with Smartphone], [Send to Smartphone], [Send to Computer] or [View on TV] terminates prematurely.

- If the battery level is low, [Ctrl with Smartphone], [Send to Smartphone], [Send to Computer] or [View on TV] may terminate prematurely. Connect the AC Adaptor or charge the battery pack before use.
 - Do not close the LCD monitor while copying/transferring files. Copying/transferring will be interrupted.
-

[269] Troubleshooting | Troubleshooting | Wi-Fi

Cannot transfer movies to your smartphone.

- To send a movie to your smartphone, be sure to record it in the MP4 format. Before shooting a movie to be transferred to a smartphone, set [Dual Video REC] to [On].
 - Do not close the LCD monitor while transferring files. Transferring will be interrupted.
-

[270] Troubleshooting | Troubleshooting | Wi-Fi





The shooting screen does not display smoothly. The connection is cut off.

- Depending on the signal conditions, communication between the smartphone and this product may not work correctly. Reduce the distance between this product and the smartphone.
-

The shooting screen during Multi Camera Control does not display smoothly. The connection is cut off.

- Depending on the signal conditions, communication between the camera and this product may not work correctly. Reduce the distance between this product and the camera.
-

The NFC connection does not work.

- Change the position of the compatible device to reduce the distance between  (N mark) on the smartphone and  (N mark) on this product.
If this still does not solve the problem, move the smartphone a few millimeters, or move the smartphone away from this product and wait for 10 seconds or more before touching again.
 - This product is in [Airplane Mode]. Set [Airplane Mode] to [Off].
 - Make sure that the smartphone is ready for communication. Refer to the instruction manual of your smartphone for details.
 - Do not put any metal products other than the smartphone close to  (N mark) on this product.
 - Do not touch  (N mark) on this product with 2 or more smartphones at the same time.
 - When running another application that uses the NFC function on your smartphone, close the application.
-

Unable to edit.

- Unable to edit because of the condition of the image.
-

A movie cannot be divided.

-
- The following movies cannot be divided.
 - Movies that are too short
 - XAVC S 4K and XAVC S HD movies
 - MP4 movies
 - Release the protection, and then divide.

[275] Troubleshooting | Troubleshooting | Editing movies/photos on this product

The demonstration movies cannot be deleted. (models with the internal memory)

-
- Release the protection, and then delete them.

[276] Troubleshooting | Troubleshooting | Playback on a TV

Neither image nor sound is played on the connected TV.

-
- Images are not output from the HDMI OUT jack, if copyright protection signals are recorded in the images.

[277] Troubleshooting | Troubleshooting | Playback on a TV

The top, bottom, right, and left edges of images are trimmed slightly on a connected TV.

-
- The LCD monitor of this product can display recording images across the entire LCD monitor (full pixel display). However, this may cause slight trimming of the top, bottom, right, and left edges of images when played back on a TV which is not compatible with full pixel display.
 - It is recommended you record images using the outer frame of [Grid Line] as a guide.

The image appears distorted on the 4:3 TV.

- This happens when viewing an image on a 4:3 TV. Set [TV Type] correctly and play back the image.
-

Black bands appear at the top and bottom of the LCD monitor of the 4:3 TV.

- This happens when viewing an image on a 4:3 TV. This is not a malfunction.
-

Images are not copied correctly.

- You cannot copy images using the HDMI cable.
 - An AV cable (sold separately) is not connected properly. Make sure that the cable is connected to the input jack of the device.
 - Do not close the LCD monitor while copying files. Copying will be interrupted.
-

PlayMemories Home cannot be installed.

- An Internet connection is required to install PlayMemories Home.
 - Check the computer environment or installation procedure required to install PlayMemories Home.
-

PlayMemories Home does not work correctly.

- Quit PlayMemories Home and restart your computer.
-

[283] Troubleshooting | Troubleshooting | Connecting to a computer

This product is not recognized by the computer.

- Disconnect all USB devices from the USB jack of your computer except the keyboard, mouse, and this product.
 - Disconnect the Built-in USB Cable from the computer and restart the computer, then connect the computer and this product again in the correct order.
 - When both the Built-in USB Cable and the Multi/Micro USB terminal of this product are connected to the external devices at the same time, disconnect the one that is not connected to a computer.
-

[284] Troubleshooting | Self-diagnosis display/Warning indicators | Self-diagnosis display/Warning indicators

Self-diagnosis display

If indicators appear on the LCD monitor or in the viewfinder (models with the viewfinder), check the following. If the problem persists even after you have tried to fix a couple of times, contact your Sony dealer or local authorized Sony service facility. When you contact them, give them the complete error code beginning with C or E displayed on the LCD monitor.



You may hear a melody when an important warning indicator appears on the LCD monitor.

C:(or E:) □ □ : □ □ (Self-diagnosis display)

C:04: □ □

You are not using the designated battery pack. Make sure to use the designated battery pack.

Connect the DC plug of the AC Adaptor to the DC IN jack of this product firmly.

C:06: □ □

The battery pack temperature is high. Change the battery pack or place it in a cool place.

C:13: □ □ / **C:32:** □ □

Remove the power source. Reconnect it and operate this product again.

E: □ □ : □ □

Follow the steps from 2 on “If you have problems.”

(Battery level warning)

The battery pack is nearly used up.

Depending on the operating environment or battery conditions,  may flash even with about 20 minutes of power remaining.

(Warning indicator pertaining to the temperature of this product/battery pack)

The temperature of the product/battery pack is high. In this case, leave the power off and wait until the temperature of the product/battery pack goes down.

(Warning indicator pertaining to memory card)

Slow flashing

Free spaces for recording images are running out.

No memory card is inserted.

Fast flashing

There is not enough free spaces for recording images. After storing the images on other media, delete unnecessary images, or format the memory card.

The image data base file may be damaged. Check the data base file by selecting **MENU** - [Setup] -  Media Settings] - [Repair Img. DB F.] - the recording medium.

The memory card is damaged.

When you record an XAVC S 4K movie with [ REC Mode] set to [100Mbps¹⁰⁰], use an SDXC memory card of UHS-I U3 or faster.

(Warning indicator pertaining to memory card formatting)

The memory card is damaged.

The memory card is not formatted correctly.

(Warning indicator pertaining to incompatible memory card)

Incompatible memory card is inserted.

(Warning indicator pertaining to the write-protect of the memory card)

The memory card is write-protected.

Access to the memory card was restricted on another device.

(Warning indicator pertaining to the external device)

The image data base file may be damaged. Check the data base file by selecting **MENU** - [Setup] - [Media Settings] - [Repair Img. DB F.] - the recording medium.

The external device is damaged.

(Warning indicators pertaining to external device formatting)

The external device is damaged.

The external device is not formatted correctly.

(Warning indicator pertaining to camera-shake warning)

This product is unsteady, so camera-shake easily occurs. Hold this product steady with both hands and record the image. However, note that the camera shake warning indicator does not disappear.

(Warning indicator pertaining to photo recording)

The recording media is full.

Photos cannot be recorded during processing. Wait for a while, then record.

You cannot capture photos while recording movies in the following situations:

- When [REC Mode] is set to [60p Quality **PS**], [Highest Quality **FX**].
- When an item of [Picture Effect] is selected.
- When [File Format] is set to [**4K** XAVC S 4K] and [REC Mode] is set to [100Mbps₁₀₀].
- When [File Format] is set to [**4K** XAVC S 4K] and [Dual Video REC] is set to [On].

[285] Troubleshooting | Self-diagnosis display/Warning indicators | Error messages during Live Streaming

Error messages during Live Streaming

If any trouble occurs when connecting to Live Streaming, the following messages appear. Follow the instructions for each error message to resolve the problem.

[Setting]

Live streaming information has not been set to the device. Verify the settings on a computer.

- Set the necessary settings for USTREAM using “PlayMemories Home.”

Cannot stream. Login to USTREAM failed. Verify the settings on a computer.

- Log in to USTREAM again and confirm the settings using “PlayMemories Home.”

Cannot stream. There is an USTREAM channel error. Verify the settings on a computer.

- The channel set by “PlayMemories Home” is incorrect.
- This message also displays if other media starts streaming on the same channel while

streaming from this product is performed.

- Set the channel again.

Cannot stream. Please verify the date & time setting of the device.

- Set the date and time again on this product.

Could not find connectable access point.

- Access point has been found but is not connected. Check the password of the access point and connect again.

[Network]

Connecting...

- The network is temporarily unavailable.

Could not save the movie on USTREAM.

- The saving settings of video cannot be saved to USTREAM because an error has occurred on the network.

Could not find an access point.

- Access point cannot be found. Confirm the setting of the access point using [Access point settings] of this product.

[Network Service]

USTREAM error occurred.

- An unknown error has occurred on USTREAM. Wait a moment and then try confirming the connection again.

Twitter post failed.

- Twitter post error. Check the network or log in to Twitter again.

Facebook post failed.

- Facebook post error. Check the network or log in to Facebook again.

[286] Troubleshooting | Warning messages | Warning messages

Warning Indicators

If messages appear on the LCD monitor, follow the instructions.

 **Cannot recognize the internal memory. Format and use again.**

- The internal memory of this product is set differently from the default format. Performing [Format] may enable you to use this product. Formatting will delete all data in the internal recording medium.

Data error.

- An error occurred during reading or writing the internal memory of this product.
- This may occur when you keep applying shock to this product.
- Movies recorded on other devices may not be played back.

The Image Database File is damaged. Do you want to create a new file?

HD movie management information is damaged. Create new information?

- The management file is damaged. When you select [Yes], a new management file is created. The old recorded images on the media cannot be played back (Image files are not damaged). If you execute [Repair Img. DB F.] after creating new information, playing back the old recorded images may become possible. If it does not work, copy the image using the PlayMemories Home software.

There is no Image Database File Movies cannot be recorded or played Create a new file?

There is no HD movie management information. Create new information?

- You cannot record or play back movies because no movie management information exists. If you select [Yes], new management information is created and you can record or play back movies.

Inconsistencies found in image database file. Do you want to repair the image database file?

The Image Database File is damaged. Do you want to repair the Image Database File?

Inconsistencies found in image database file. Cannot record or play HD movies. Do you want to repair the image database file?

- You cannot record or play back movies because no movie management information exists. If you select , new management information is created and you can record or play back movies.

Inconsistencies found in the image database file. Back up and recover.

Recover, then import using the included PC software.

- Since the database information of high definition image quality (HD) movies has been damaged, there are inconsistencies between the information in the database and the information in the file. Select to back up the high definition image quality (HD) movies and repair the database file. You cannot see the backed-up movies on this product. By connecting this product to a computer after repairing the database, you can import backed-up high definition image quality (HD) movies to the computer using the PlayMemories Home software installed on the computer. However, it is not guaranteed that all movies can be imported to the computer.

Buffer overflow. Writing to the media was not completed in time.

- You have performed recording and erasing operations repeatedly, or a memory card that has been formatted by other device is used. Copy and take data backup to other device (such as a computer), and then format the memory card on this product.
- The size of the inserted memory card is not sufficient for copying the movie(s). Use the recommended memory card.

Restoring data...

- Writing data onto the media of this product has failed. Attempts were made to recover the data, but they were unsuccessful.

Cannot recover data.

- Writing data onto the media of this product has failed. Attempts were made to recover the data, but they were unsuccessful.

Reinsert the memory card.

- Reinsert the memory card a few times. If the indicator continues to flash even after reinserting, the memory card could be damaged. Try with another memory card.

Cannot recognize this memory card. Format and use again.

- Format the memory card. Note that when you format the memory card, all the recorded movies and photos are deleted.

The maximum number of still image folders has been reached.

Cannot record still images.

- You cannot create folders exceeding 999MSDCF. You cannot create or delete created folders using this product.
- Format the memory card, or delete folders using your computer.

This memory card may not be able to record or play movies.

This memory card may not be able to record or play images correctly.

- Use a memory card recommended for this product.

Do not eject the memory card during writing. Data may be damaged.

- Reinsert the memory card.

External media cannot execute functions.

- Check the image database file by selecting **[MENU]** - **[Setup]** -  **Media Settings]** - **[Repair Img. DB F.]**
- If even then the indicator flashes, format the external media using your computer, and then reconnect this product with the external media. Note that if you format the external media device, all the recorded movies and photos in it are deleted.
- If the same message still appears after formatting, the external media may not be supported by this product, or it may be damaged. Try with another external media.

Unable to access external media.

- Use the external media device in stable condition (the environment such as no vibration and room temperature, etc.).
- Make sure that the power source of the external media device is connected.

Others

Maximum number of images already selected.

- You can select only 100 images at one time for:
 - Deleting movies/photos
 - Protecting movies/photos, or releasing the protection
 - Copying movies/photos

Data protected.

- You tried to delete protected data. Release the protection of the data.

Free Manuals Download Website

<http://myh66.com>

<http://usermanuals.us>

<http://www.somanuals.com>

<http://www.4manuals.cc>

<http://www.manual-lib.com>

<http://www.404manual.com>

<http://www.luxmanual.com>

<http://aubethermostatmanual.com>

Golf course search by state

<http://golfingnear.com>

Email search by domain

<http://emailbydomain.com>

Auto manuals search

<http://auto.somanuals.com>

TV manuals search

<http://tv.somanuals.com>