

# WEATHER/FM/AM CD Portable Radio

## Operating Instructions

### ICF-CD73W

©2008 Sony Corporation Printed in China

<http://www.sony.net/>

### Owner's Record

The model number and the serial number are located at the bottom. Record the serial number in the space provided below. Refer to them whenever you call upon your Sony dealer regarding this product.

Model No. ICF-CD73W

Serial No. \_\_\_\_\_

For customers who purchased this product in the USA Please register this product on line at <http://www.sony.com/productregistration>. Proper registration will enable us to send you periodic mailings about new products, services, and other important announcements. Registering your product will also allow us to contact you in the unlikely event that the product needs adjustment or modification. Thank you.

### WARNING

You are cautioned that any changes or modifications not expressly approved in this manual could void your authority to operate this equipment.

### INFORMATION

This equipment has been tested and found to comply with the limits for a Class B digital device, pursuant to Part 15 of the FCC Rules. These limits are designed to provide reasonable protection against harmful interference in a residential installation. This equipment generates, uses and can radiate radio frequency energy and, if not installed and used in accordance with the instructions, may cause harmful interference to radio communications. However, there is no guarantee that interference will not occur in a particular installation. If this equipment does cause harmful interference to radio or television reception, which can be determined by turning the equipment off and on, the user is encouraged to try to correct the interference by one or more of the following measures:

- Reorient or relocate the receiving antenna.
- Increase the separation between the equipment and receiver.
- Connect the equipment into an outlet on a circuit different from that to which the receiver is connected.
- Consult the dealer or an experienced radio/TV technician for help.

If you have any questions about this product, you may call:  
Sony Customer Information Service Center  
1-800-222-7669 or  
<http://www.sony.com/>

Declaration of Conformity  
Trade Name: SONY  
Model No.: ICF-CD73W  
Responsible Party: Sony Electronics Inc.  
Address: 16530 Via Esprillo, San Diego, CA 92127 USA  
Telephone No.: 858-942-2230

This device complies with Part 15 of the FCC Rules. Operation is subject to the following two conditions: (1) This device may not cause harmful interference, and (2) this device must accept any interference received, including interference that may cause undesired operation.

- To clean the casing, use a soft cloth dampened with water, wipe it again with a dry cloth. Do not use alcohol, benzine or thinner.
- Do not use soap or detergent; do not dry with an electric hair dryer.

#### Note on condensation

If the player is brought directly from a cold to a warm location, or is placed in a very damp room, moisture may condense on the lens inside the CD player section. Should this occur, the player will not operate properly. In this case, remove the CD and wait about an hour for the moisture to evaporate.

#### Notes on CDs

- Before playing, clean the CD with a cleaning cloth. Wipe the CD from the center out.



- If there is a scratch, dirt or fingerprints on the CD, it may cause tracking error.

## Cautions on Water-resistance

- This unit is designed so that it can be used with slight exposure to rain, snow and other forms of moisture, but there are several points on which caution should be observed.
- Do not allow it to come in contact with large amounts of water.
  - Do not immerse it in water.
  - Open or close the battery/CD compartment with dry hands in a place without exposure to any water.
  - Do not touch the AC power adaptor with wet hands, as there is a risk of electric shock.
  - Use batteries for the unit when you use it in a wet place, such as a bathroom. Do not use the AC power adaptor, as there is a risk of electric shock.
  - The rubber parts attached to the lid of the battery/CD compartment and the DC IN 6V socket are necessary to keep the unit water resistant. Do not damage them.
  - Before replacing batteries, wipe all water droplets from the unit. Then, open the lid on the back of the unit.
  - Any malfunction caused by water entering the unit, consult the nearest Sony dealer.

## Replacing the Batteries

- When the batteries (not supplied) become weak, the sound becomes weak and distorted and "AM" flashes. Replace the batteries with new ones. When the batteries are completely exhausted, the unit and the timer will turn off and "AM" is displayed.
- When the batteries become weak while playing a CD, "AM" will flash in the display and CD playback will stop. However, the radio will still function after turning on the unit again until the batteries are completely exhausted.
- Before replacing the batteries, make sure that the unit is turned off.
- After replacing the batteries, press **RADIO ON BAND/CD ►II** and "AM" will disappear.
- Replace the batteries within 5 minutes. Otherwise, the memories for the clock and the preset stations will be erased and "AM 12:00" will flash in the display.
- When operating the unit on batteries, remove the AC power adaptor from the DC IN jack. The unit cannot be operated on batteries when the AC power adaptor is connected to the DC IN jack.
- When you install/replace the batteries, do not push hard on the unit as it may damage the display panel or cause a malfunction.

#### Notes on batteries

- Do not charge dry batteries.
- Do not carry dry batteries together with coins or other metallic objects. It can generate heat if the positive and negative terminals of the batteries accidentally come into contact with metallic objects.
- When you are not going to use the unit for a long time, remove the batteries to avoid damage from battery leakage and corrosion.
- Do not use different types of batteries at the same time.
- When you replace the batteries, replace all with new ones.

## Using the AC power adaptor

- When operating the unit with an external power source, do not remove the batteries. These batteries serve to backup the clock and memory settings. Since the batteries discharge in this case as well, we recommend changing them about once a year.
- When you are not going to use the unit for a long time, remove the batteries to avoid damage from battery leakage. In that case, current time and preset tuning settings will be reset. Set them again when you next use the unit.

- Before connecting and disconnecting the external power source plug, be sure to turn off the radio/CD. Otherwise, "AM" may be displayed. When this occurs, turn on the radio/CD so that "AM" disappears.
- When the AC power adaptor (not supplied) is not to be used for a long period of time, unplug it both from the DC IN 6 V jack and from the wall outlet.
- Use only the recommended AC power adaptor. Using any other AC power adaptor may cause damage to the unit.
- When the cover of the DC IN 6 V jack is open (to use the AC power adaptor), the jack area is not water-resistant. When the AC power adaptor is not connected to the DC IN 6 V jack, be sure to close the cover of the DC IN 6 V jack.
- For details of the AC power adaptor (not supplied), see "Specifications."



Polarity of the plug

If you have any questions or problems concerning your unit, please consult your nearest Sony dealer.

## Troubleshooting

Should any problem occur with the unit, do the following checks to determine whether or not servicing is required. If the problem persists, consult the nearest Sony dealer.

#### The CD player does not operate.

- Did you close the CD compartment lid?
- Did you place the disc correctly?  
The disc should be placed with the labeled side up.
- Dusty or defective disc—Clean the disc with an optional cleaning cloth. Wipe the disc from the center out (see "Notes on CDs").
- Take out the CD and leave the CD compartment open for about an hour to get rid of moisture condensation (see "Note on condensation").

#### Sporadic loss of sound in CD operation.

- Dusty or defective disc—Clean or replace the disc.
- Volume too high—Reduce the volume.
- Strong vibration.

## Specifications

### CD player section

**System:** Compact disc digital audio system  
**Laser diode properties:** Material: GaAlAs  
Wavelength: 780 nm  
Emission duration: Continuous  
Laser output: Less than 44.6 μW  
(This output is the value measured at a distance of about 200 mm from the objective lens surface on the optical pick-up block with 7 mm aperture.)

**Frequency response:** 20 – 20 000 Hz  $-1.5$  dB  
**Wow and flutter:** Below measurable limit

### Radio section

#### Frequency range:

Band	Range	Channel step
WEATHER	1 – 7 ch	1 channel
FM	87.5 – 108 MHz	0.1 MHz
AM	530 – 1 710 kHz	10 kHz

### General

**Time display:** 12-hour system  
**Speaker:** 50 mm (2 inches) dia, 6 Ω  
**Power outputs:**  
400 mW + 400 mW (at 10% harmonic distortion)  
**Power requirements:**  
6 V DC, four Size C (R14) batteries  
**External power source:** DC IN 6 V  
**Dimensions:**  
Approx. 151.5 × 248 × 84 mm (w/h/d)  
(Approx. 6 × 9 7/8 × 3 3/8 inches) incl. projecting parts and controls  
**Mass:** Approx. 1 350 g (2 lb 16 oz) incl. batteries  
**Supplied accessories:**  
Suction cup (1), Strap (1)

#### Optional accessory

AC power adaptor AC-E60HG\*  
\* The voltage of power supply is different depending on the country/region. Please buy an AC power adaptor in the country/region where the unit is to be used.  
Your dealer may not handle the above listed accessory. Please ask the dealer for detailed information.

Design and specifications are subject to change without notice.

## Choosing Power Sources

### Installing the Batteries (See Fig. A)

Press the buckle of the battery compartment lid inward and pull upward to open the lid. Install four Size C (R14) batteries (not supplied) with the correct polarity and close the lid.

"AM12:00" flashes in the display when you install batteries for the first time. To stop the display from flashing, set the clock (see "Setting the Clock").

Battery Life (Approx. hours)	(JEITA*)			
When using	WEATHER	FM	AM	CD
Sony alkaline Size C (LR 14)	50	50	60	18
Sony Size C (R 14)	15	15	17	3

\* Measured by JEITA (Japan Electronics and Information Technology Industries Association) standards. The actual battery life may vary depending on the circumstance of the unit.

### House Current (See Fig. B)

Make sure the unit is turned off before using house current.

Connect the Sony AC power adaptor (not supplied) to the DC IN 6 V jack firmly, and plug it into a wall outlet.

When the AC power adaptor is not connected to the DC IN 6 V jack, be sure to close the cover of the DC IN 6 V jack.

## Using the FM wire antenna (See Fig. C)

### Taking out the FM wire antenna

Hook your finger around the FM wire antenna and pull out the end of the antenna from the slot ①. Open the buckle and unwrap the FM wire antenna completely, then close the buckle.

### Storing the FM wire antenna

When the FM wire antenna is not in use, store the antenna as follows:

Open the buckle and wrap the FM wire antenna completely around the buckle, then close the buckle. Insert the end of the wire antenna into the slot ①. Pinch the antenna wires wrapped around the buckle and push them into the slit ②.

#### Note

When you close the buckle, make sure the antenna is stored correctly. You may damage the antenna if you close the buckle forcefully.

### Tying the FM wire antenna (See Fig. D)

Tie the FM wire antenna to the supplied suction cup and attach the cup to the wall.

## Using the Strap (See Fig. E)

Use the strap as shown in the illustration.

#### Notes

- The strap is only for hanging the unit, do not use the strap to carry it.
- Do not hang the unit from where it can easily fall down.

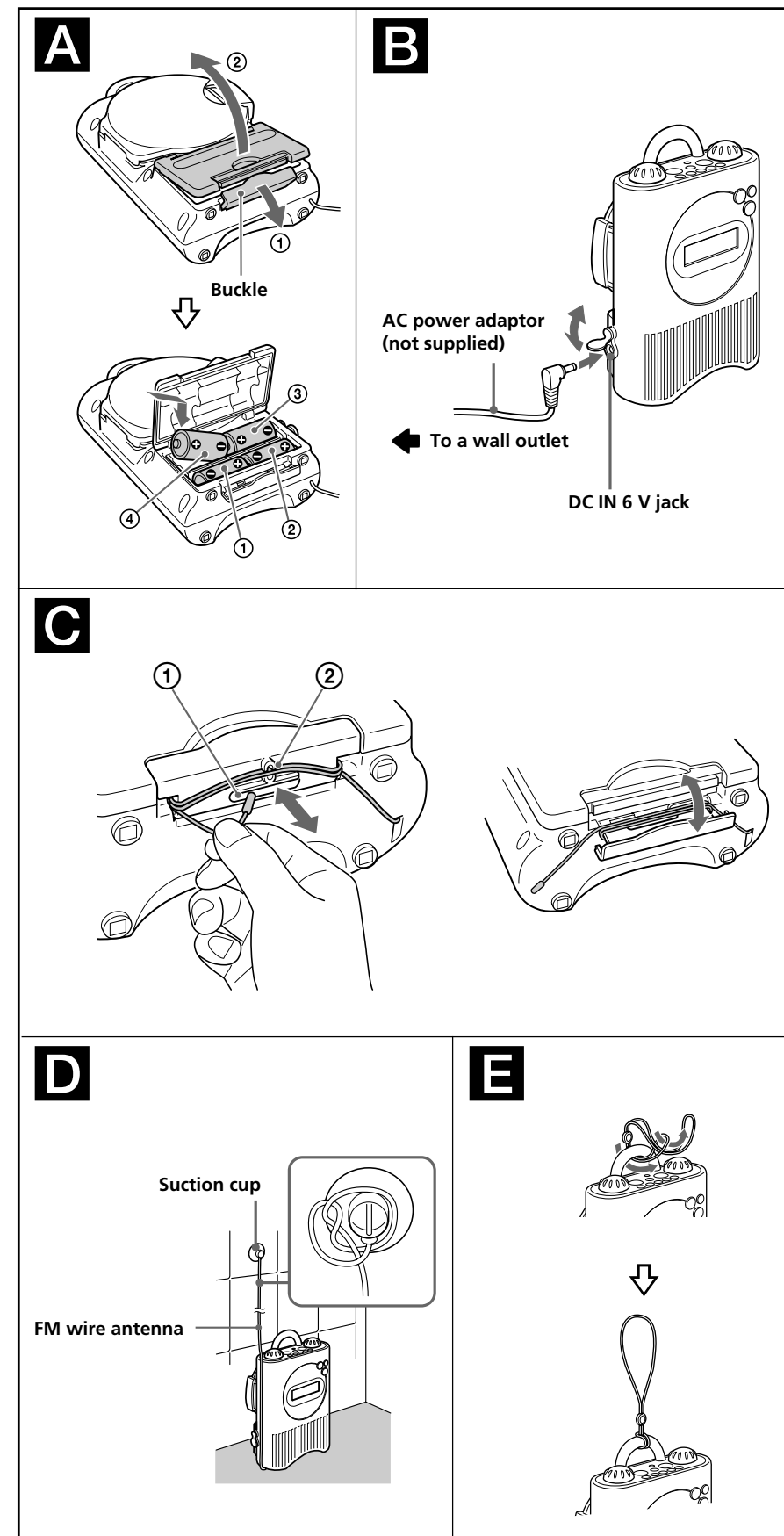

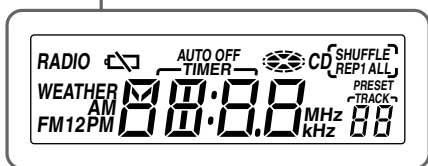
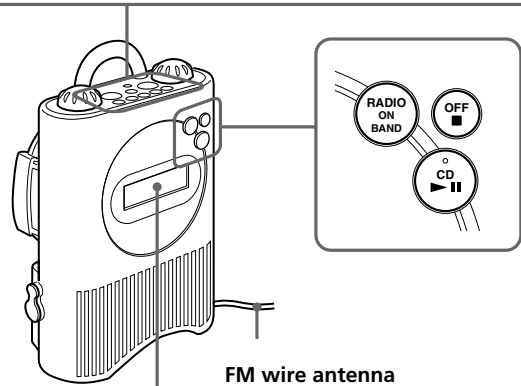
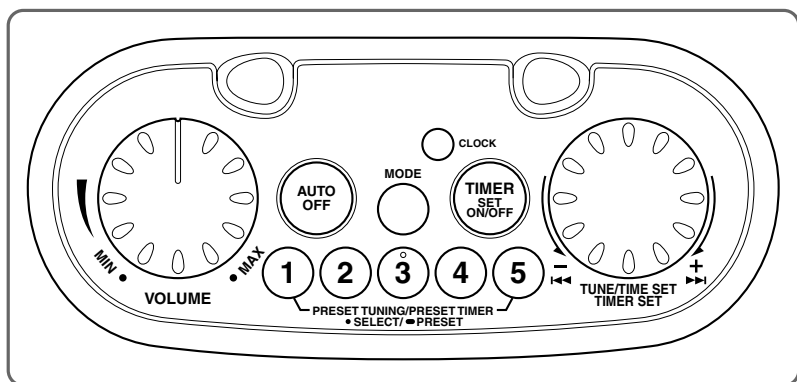

**F**

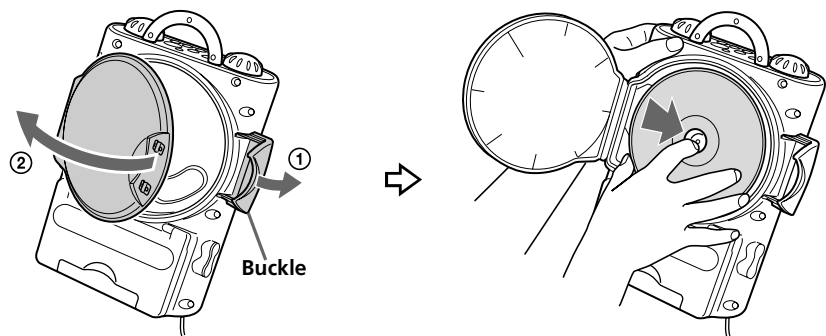

**G**

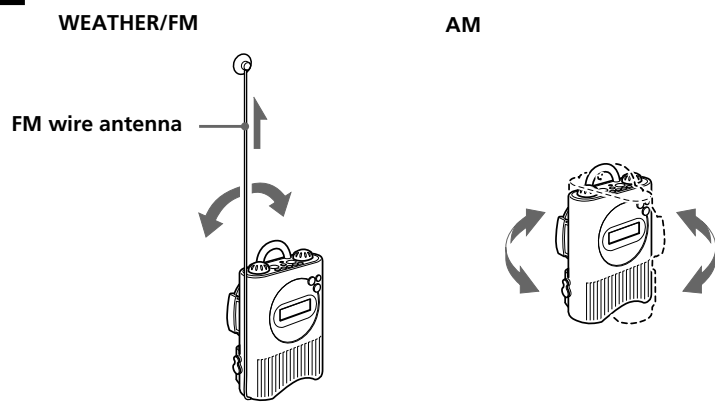

## Setting the Clock

The display will flash "AM12:00" when the batteries are installed or the AC power adaptor is plugged in for the first time.

- 1 Hold down **CLOCK** for more than 2 seconds. The beep sounds and the hour flashes in the display.
- 2 Rotate in either **+/-** direction the **TUNE/TIME SET/TIMER SET** dial until the correct hour appears in the display.



Each rotation of the dial changes the digit(s) by one. When you hold the dial, the digit(s) change rapidly.

- 3 Press **CLOCK**.

The beep sounds and the minute starts to flash. Repeat step 2 to set the minute. After setting the minute, press **CLOCK** again. The two beeps sound and the clock starts from 0 seconds.



12-hour system: "AM 12:00" = midnight  
"PM 12:00" = noon

### Notes

- You can set the clock also during the radio reception/CD playback mode.
- To set the current time quickly, rotate and hold in either **+/-** direction the **TUNE/TIME SET/TIMER SET** dial.
- To set the current time exactly, follow step 2 and press **CLOCK** again with the time signal of a radio station.

## Playing a CD (See Fig. F)

An 8 cm (3-inch) CD can be played without an adaptor.

- 1 Release the buckle on the back of the unit to open the CD compartment lid and place a disc.
- 2 Close the CD compartment lid and fasten with the buckle until it clicks.
- 3 Press **CD ▶II**.

"CD" and "TRACK 01" appear in the display to indicate that track 1 of CD is playing.

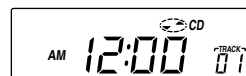

- 4 Adjust the volume using **VOLUME**.

To	Operation
Pause	<b>CD ▶II</b>
Resume play after pause	<b>CD ▶II</b> again
Locate the beginning of the current track (AMS*)	<b>◀◀**</b>
Locate the next track (AMS*)	<b>▶▶**</b>
Go back at high speed	Hold <b>◀◀**</b>
Go forward at high speed	Hold <b>▶▶**</b>
Locate the previous track (AMS*)	<b>◀◀</b> repeatedly**
Locate the succeeding track (AMS*)	<b>▶▶</b> repeatedly**
Stop play	<b>OFF ■</b>

\* AMS = Automatic Music Sensor

\*\*These operations are possible during both play and pause.

## Various Modes of CD Playback

You can play tracks repeatedly or in random order.

Press **MODE**.

Each pressing **MODE** changes the play mode as follows:

Display indication	Play mode
none	(normal play)
All the tracks are played once.	↓
"REP 1"	(single repeat)
A single track is played repeatedly.	↓
"REP ALL"	(all repeat)
All the tracks are played repeatedly.	↓
"SHUFFLE"	(shuffle play)
All the tracks are played once in random order.	↓
"SHUFFLE REP"	(shuffle repeat)
All the tracks are played repeatedly in random order.	

### Notes

- Discs with non-standard shapes (e.g., heart, square, star) cannot be played on this unit. Attempting to do so may damage the unit. Do not use such discs.
- If you press **CD ▶II** when there is no disc in the CD compartment, "00" flashes for about 5 seconds on the display and the unit turns off automatically.

## About CD-Rs/CD-RWs

This unit is compatible with CD-Rs/CD-RWs but playback capability may vary depending on the quality of the disc, the recording device and application software.

## Music discs encoded with copyright protection technologies

This product is designed to play back discs that conform to the Compact Disc (CD) standard. Recently, various music discs encoded with copyright protection technologies are marketed by some record companies. Please be aware that among those discs, there are some that do not conform to the CD standard and may not be playable by this product.

### To handle compact discs

Correct



Handle the disc by its edge.

Incorrect

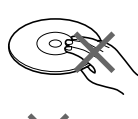

Do not touch the surface.

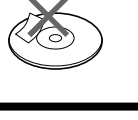

Do not stick paper or tape nor write anything on the surface.

## Changing AM Channel Step

The AM channel step differs depending on area. The channel step of this unit is factory-set to 10 kHz to match the frequency allocation system of the country/region listed below. When needed, change the channel step before listening to the radio.

Area	Channel step
North and South America	10 kHz
Other countries/regions	9 kHz

- 1 Press **OFF ■** to turn off the power.
- 2 While holding down **OFF ■**, keep pressing the **PRESET TUNING / PRESET TIMER** button **1** for more than 5 seconds. Two short beeps will sound, and the AM channel step will be changed. If you proceed to step 2, the channel step will change again.

### Notes

- When the AM channel step is changed, the preset stations will be initialized.
- When the AM channel step is changed, the preset stations will be reset to their default factory settings.
- When the AM channel step is changed, the FM channel step also will be changed.

## Improving the Reception (See fig. G)

### WEATHER, FM:

Tie the FM wire antenna to the supplied suction cup. Extend and adjust the antenna. Secure the suction cup on the wall where you get optimum reception.

**AM:** Rotate the unit horizontally for optimum reception. A ferrite bar antenna is built in the unit.

## Playing the Radio —Manual Tuning

- 1 Press **RADIO ON BAND** to turn on the radio. The band and frequency will appear in the display for a few seconds. Then the current time indication will return to the display.
- 2 Press **RADIO ON BAND** repeatedly to select the desired band.

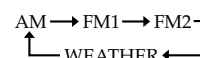

When using FM1 or FM2 preset mode, you may listen to the radio on either mode (See "Presetting Your Favorite Station").

- 3 Rotate in either **+/-** direction the **TUNE/TIME SET/TIMER SET** dial to tune in to the desired station. Two short beeps sound when the minimum frequency of each band is received during tuning.
- 4 Adjust the volume using **VOLUME**.

### To check the station being received

Press **RADIO ON BAND** or rotate in either **+/-** direction the **TUNE/TIME SET/TIMER SET** dial lightly. The display shows the band and frequency for a few seconds and then returns to the current time.

To turn off the radio, press **OFF ■**.

## Presetting Your Favorite Station —Preset Tuning

You can preset 10 stations in FM (5 stations in FM1, 5 stations in FM2) and 5 stations in each AM, WEATHER.

### Presetting a Station

**Example:** To set FM 90.0 MHz to **PRESET TUNING/PRESET TIMER** button **2**.

- 1 Press **RADIO ON BAND** to turn on the radio.
- 2 Tune in to FM 90.0 MHz (See "Manual Tuning").
- 3 Hold down the desired **PRESET TUNING/PRESET TIMER** button (in this case, **2**) until you hear two short beeps.

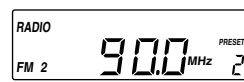

The display shows the frequency for a few seconds and then changes back to the current time.

To preset another station, repeat these steps. To change the preset station, tune in to the desired station and hold down the **PRESET TUNING 1 to 5** button. The new station will replace the previous station on the **PRESET TUNING** button.

## Tuning in to a Preset Station

- 1 Press **RADIO ON BAND** to turn on the radio.
- 2 Press **RADIO ON BAND** repeatedly to select the desired band.
- 3 Press the **PRESET TUNING/PRESET TIMER** button of your choice.

- 4 Adjust the volume using **VOLUME**.

After a few seconds, the display returns to the current time but the **PRESET TUNING** button number remains.

### Note

To change the preset station, preset a new station to the button of your choice. The previous station will be overwritten by the new one.

## Switching between monaural and stereo

- 1 Press **RADIO ON BAND** to turn on the radio.
- 2 Press **RADIO ON BAND** repeatedly to select FM 1 or FM 2.
- 3 Press **MODE**. "Mono (monaural)" or "ST (Stereo)" appears in the display. Each time you press **MODE**, the mode changes either "Mono" or "ST."
- 4 Select Mono or ST. The mode you selected appears in the display for a few seconds and returns to the current time.

### Note

When listening to the FM stereo reception, normally set to "ST" (stereo). If the FM stereo reception is poor, set to "Mono". Although the sound will not be heard in stereo, noise will be reduced.

## Using the Countdown Timer

The beep alarm will go off when the countdown time has elapsed. Use the timer as a reminder. The buzzer alarm activates whether or not the radio reception/CD playback mode is on.

The countdown time can be set at 1 minute intervals between 1 to 120 minutes.

- 1 Press **TIMER SET ON/OFF**. The indication flashes in the display.

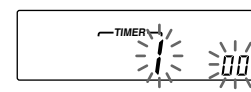

- 2 Rotate in either **+/-** direction the **TUNE/TIME SET/TIMER SET** dial to set the desired time.

- 3 Press **TIMER SET ON/OFF**. Two short beeps sound and countdown starts. When the countdown has completed, the beep alarm will go off and the display will flash.

### Notes

- To stop the beep alarm, press **TIMER SET ON/OFF**. The alarm will beep 30 minutes if it is not turned off.
- While the timer is counting down, the display shows the remaining time. To display the current time, press **CLOCK**. To check the station you are listening to, Press **RADIO ON BAND** shortly. The band and frequency will appear for a few seconds.
- To cancel the timer during the countdown, press **TIMER SET ON/OFF**. The countdown timer will be canceled and the current time will appear in the display.

## Using the PRESET TIMER buttons

You can use the countdown timer with the **PRESET TUNING/PRESET TIMER** buttons.

- 1 Press **TIMER SET ON/OFF**.
- 2 Press the desired **PRESET TUNING/PRESET TIMER** button. The countdown time and the preset button number will appear in the display. The default countdown time for the **PRESET TIMER** buttons **1 to 5** are 3 minutes, 10 minutes, 30 minutes, 60 minutes and 90 minutes respectively.
- 3 Press **TIMER SET ON/OFF** again. A beep sound and starts to countdown. When the countdown time has elapsed, the beep alarm will go off and the display will flash.

## Presetting a Countdown Time

You can also store a countdown time of your choice to each of the five preset buttons.

- 1 Set the timer (See steps 1 and 2 of "Using the Countdown Timer").
- 2 Hold down the desired **PRESET TUNING/PRESET TIMER** button until you hear two short beeps. The countdown time has been stored as displayed.

## Other Useful Functions

### AUTO OFF function

The AUTO OFF function will turn off the radio/CD after a preset duration of time.

- 1 Press **RADIO ON BAND/CD▶II** to turn on the radio/CD.
- 2 Press **AUTO OFF**. Each time you press **AUTO OFF**, the AUTO OFF time (minutes) changes as follows.

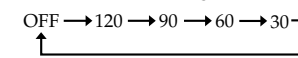

The radio/CD will play for the AUTO OFF time you have set, then turn off. The AUTO OFF time appears in the display for a few seconds with AUTO OFF indication.

### Note

To turn off the radio/CD before the AUTO OFF time has elapsed, press **OFF ■**.

SONY

Portable Audio

## LIMITED WARRANTY (U.S. Only)

Sony Electronics Inc. ("Sony") warrants this product against defects in material or workmanship for the time periods and as set forth below. Pursuant to this Limited Warranty, Sony will, at its option, (i) repair the product using new or refurbished parts or (ii) replace the product with a new or refurbished product. For purposes of this Limited Warranty, "refurbished" means a product or part that has been returned to its original specifications. **In the event of a defect, these are your exclusive remedies.**

**Labor:** For a period of one (1) year from the original date of purchase of the product ("Labor Warranty"), Sony will, at its option, repair or replace with new or refurbished product, product determined to be defective. If Sony elects to replace the product after this Labor Warranty has expired but while the Parts Warranty below is still in effect, it will do so for the applicable labor charge.

**Parts:** For a period of one (1) year from the original date of purchase of product ("Parts Warranty"), Sony will supply new or refurbished replacement parts in exchange for parts determined to be defective.

This Limited Warranty covers only the hardware components packaged with the Product. It does not cover technical assistance for hardware or software usage and it does not cover any software products whether or not contained in the Product; any such software is provided "AS IS" unless expressly provided for in any end user software Limited Warranty. Please refer to the End User License Agreements included with the Product for your rights and obligations with respect to the software.

**Instructions:** To obtain warranty service, you must deliver the product, freight prepaid, in either its original packaging or packaging affording an equal degree of protection to the Sony authorized service facility specified. **It is your responsibility to backup any data, software or other materials you may have stored or preserved on your unit. It is likely that such data, software, or other materials will be lost or reformatted during service and Sony will not be responsible for any such damage or loss.** A dated purchase receipt is required. For specific instructions on how to obtain warranty service for your product,

Visit Sony's Web Site:  
[www.sony.com/service](http://www.sony.com/service)

Or call the Sony Customer Information Service Center  
1-800-222-SONY (7669)

For an accessory or part not available from your authorized dealer, call:

1-800-488-SONY (7669)

**Repair / Replacement Warranty:** This Limited Warranty shall apply to any repair, replacement part or replacement product for the remainder of the original Limited Warranty period or for ninety (90) days, whichever is longer. Any parts or product replaced under this Limited Warranty will become the property of Sony.

This Limited Warranty only covers product issues caused by defects in material or workmanship during ordinary consumer use; it does not cover product issues caused by any other reason, including but not limited to product issues due to commercial use, acts of God, misuse, limitations of technology, or modification of or to any part of the Sony product. This Limited Warranty does not cover Sony products sold AS IS or WITH ALL FAULTS or consumables (such as fuses or batteries). This Limited Warranty is invalid if the factory-applied serial number has been altered or removed from the product. This Limited Warranty is valid only in the United States.

**LIMITATION ON DAMAGES:** SONY SHALL NOT BE LIABLE FOR ANY INCIDENTAL OR CONSEQUENTIAL DAMAGES FOR BREACH OF ANY EXPRESS OR IMPLIED WARRANTY ON THIS PRODUCT.

**DURATION OF IMPLIED WARRANTIES:** EXCEPT TO THE EXTENT PROHIBITED BY APPLICABLE LAW, ANY IMPLIED WARRANTY OF MERCHANTABILITY OR FITNESS FOR A PARTICULAR PURPOSE ON THIS PRODUCT IS LIMITED IN DURATION TO THE DURATION OF THIS WARRANTY.

Some states do not allow the exclusion or limitation of incidental or consequential damages, or allow limitations on how long an implied warranty lasts, so the above limitations or exclusions may not apply to you. This Limited Warranty gives you specific legal rights and you may have other rights which vary from state to state.

## Free Manuals Download Website

<http://myh66.com>

<http://usermanuals.us>

<http://www.somanuals.com>

<http://www.4manuals.cc>

<http://www.manual-lib.com>

<http://www.404manual.com>

<http://www.luxmanual.com>

<http://aubethermostatmanual.com>

Golf course search by state

<http://golfingnear.com>

Email search by domain

<http://emailbydomain.com>

Auto manuals search

<http://auto.somanuals.com>

TV manuals search

<http://tv.somanuals.com>