

Home Theatre System

Operating Instructions

HT-SF360

©2009 Sony Corporation

WARNING

To reduce the risk of fire or electric shock, do not expose this apparatus to rain or moisture.

To reduce the risk of fire, do not cover the ventilation opening of the apparatus with newspapers, tablecloths, curtains, etc. Do not place the naked flame sources such as lighted candles on the apparatus.

Do not install the appliance in a confined space, such as a bookcase or built-in cabinet.

To reduce the risk of fire or electric shock, do not expose this apparatus to dripping or splashing, and do not place objects filled with liquids, such as vases, on the apparatus.

As the main plug is used to disconnect the unit from the mains, connect the unit to an easily accessible AC outlet. Should you notice an abnormality in the unit, disconnect the main plug from the AC outlet immediately.

Do not expose batteries or apparatus with battery-installed to excessive heat such as sunshine, fire or the like.

The unit is not disconnected from the mains as long as it is connected to the AC outlet, even if the unit itself has been turned off.

To prevent injury, this apparatus must be securely attached to the floor/wall in accordance with the installation instructions.

For customers in the United States, Canada and Mexico



This symbol is intended to alert the user to the presence of the Hot Surface that may be hot if it is touched during the normal operation.

For customers in the United States

Owner's Record

The model and serial numbers are located on the rear of the unit. Record these numbers in the space provided below. Refer to them whenever you call upon your Sony dealer regarding this product.

Model No. _____ Serial No. _____



This symbol is intended to alert the user to the presence of uninsulated "dangerous voltage" within the product's enclosure that may be of sufficient magnitude to constitute a risk of electric shock to persons.



This symbol is intended to alert the user to the presence of important operating and maintenance (servicing) instructions in the literature accompanying the appliance.

Important Safety Instructions

- 1) Read these instructions.
- 2) Keep these instructions.
- 3) Heed all warnings.
- 4) Follow all instructions.
- 5) Do not use this apparatus near water.
- 6) Clean only with dry cloth.
- 7) Do not block any ventilation openings. Install in accordance with the manufacturer's instructions.
- 8) Do not install near any heat sources such as radiators, heat registers, stoves, or other apparatus (including amplifiers) that produce heat.
- 9) Do not defeat the safety purpose of the polarized or grounding-type plug. A polarized plug has two blades with one wider than the other. A grounding type plug has two blades and a third grounding prong. The wide blade or the third prong are provided for your safety. If the provided plug does not fit into your outlet, consult an electrician for replacement of the obsolete outlet.
- 10) Protect the power cord from being walked on or pinched particularly at plugs, convenience receptacles, and the point where they exit from the apparatus.
- 11) Only use attachments/accessories specified by the manufacturer.

- 12) Use only with the cart, stand, tripod, bracket, or table specified by the manufacturer, or sold with the apparatus. When a cart is used, use caution when moving the cart/apparatus combination to avoid injury from tip-over.



- 13) Unplug this apparatus during lightning storms or when unused for long periods of time.
- 14) Refer all servicing to qualified service personnel. Servicing is required when the apparatus has been damaged in any way, such as power-supply cord or plug is damaged, liquid has been spilled or objects have fallen into the apparatus, the apparatus has been exposed to rain or moisture, does not operate normally, or has been dropped.

The following FCC statement applies only to the version of this model manufactured for sale in the U.S.A. Other versions may not comply with FCC technical regulations.

NOTE:

This equipment has been tested and found to comply with the limits for a Class B digital device, pursuant to Part 15 of the FCC Rules. These limits are designed to provide reasonable protection against harmful interference in a residential installation.

This equipment generates, uses and can radiate radio frequency energy and, if not installed and used in accordance with the instructions, may cause harmful interference to radio communications. However, there is no guarantee that interference will not occur in a particular installation. If this equipment does cause harmful interference to radio or television reception, which can be determined by turning the equipment off and on, the user is encouraged to try to correct the interference by one or more of the following measures:

- Reorient or relocate the receiving antenna.
- Increase the separation between the equipment and receiver.
- Connect the equipment into an outlet on a circuit different from that to which the receiver is connected.
- Consult the dealer or an experienced radio/TV technician for help.

CAUTION

You are cautioned that any changes or modifications not expressly approved in this manual could void your authority to operate this equipment.

To reduce the risk of electric shock, the speaker cord should be connected to the apparatus and the speakers in accordance with the following instructions.

- 1) Disconnect the AC power cord from the MAINS.
- 2) Strip 10 to 15 mm of the wire insulation of the speaker cord.
- 3) Connect the speaker cord to the apparatus and the speakers carefully so as not to touch the core of speaker cord by hand. Also disconnect the AC power cord from the MAINS before disconnecting the speaker cord from the apparatus and the speakers.

About This Manual

- The instructions in this manual are for model HT-SF360.
- In this manual, models of area code UC is used for illustration purposes unless stated otherwise. Any difference in operation is clearly indicated in the text, for example, “Models of area code UC only”.

The HT-SF360 consists of:

- Receiver STR-KS360S
- Speaker system^{a)}
 - Front speaker SS-MSP36F
 - Center speaker SS-CNP36
 - Surround speaker SS-SRP36F
 - Subwoofer SS-WP36

^{a)} Be sure to use only the supplied speakers.

- The instructions in this manual describe the controls on the supplied remote. You can also use the controls on the receiver if they have the same or similar names as those on the remote.

About area codes

The area code of the receiver you purchased is shown on the lower portion of the rear panel (see the illustration below).

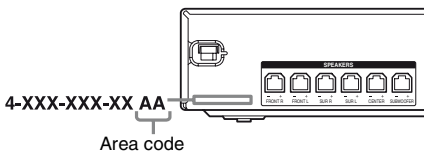

Any differences in operation, according to the area code, are clearly indicated in the text, for example, “Models of area code AA only”.

On Copyrights

This receiver incorporates Dolby* Digital and Pro Logic Surround and the DTS** Digital Surround System.

- * Manufactured under license from Dolby Laboratories. Dolby, Pro Logic, and the double-D symbol are trademarks of Dolby Laboratories.
- ** Manufactured under license under U.S. Patent #'s: 5,451,942; 5,956,674; 5,974,380; 5,978,762; 6,487,535 & other U.S. and worldwide patents issued & pending. DTS and DTS Digital Surround are registered trademarks and the DTS logos and Symbol are trademarks of DTS, Inc. © 1996-2008 DTS, Inc. All Rights Reserved.

This receiver incorporates High-Definition Multimedia Interface (HDMITM) technology. HDMI, the HDMI logo and High-Definition Multimedia Interface are trademarks or registered trademarks of HDMI Licensing LLC.

“x.v.Color” and “x.v.Color” logo are trademarks of Sony Corporation.

“BRAVIA” is a trademarks of Sony Corporation.

“S-AIR” and its logo are trademarks of Sony Corporation.

Table of Contents

Description and location of parts	6
-----------------------------------------	---

Getting Started

1: Installing the speakers	13
2: Connecting the speakers	15
3: Connecting the TV	16
4: Connecting the audio/video components	17
5: Connecting the antennas	21
6: Preparing the receiver and the remote.....	21
7: Calibrating the appropriate settings automatically (AUTO CALIBRATION)	22
8: Adjusting the speaker levels (TEST TONE).....	27

Playback

Selecting a component	28
Enjoying sound/images from the components connected to the receiver ...	29

Amplifier Operations

Navigating through menus	32
Settings for the HDMI (SET HDMI menu)	36
Settings for the Auto Calibration (A.CAL menu)	36
Settings for the Speaker (SP SETUP menu)	37
Adjusting the level (LEVEL menu)	38
Adjusting the tone (TONE menu)	38
Settings for the Custom Menu (CUSTOM menu)	39
Settings for the S-AIR (S-AIR menu).....	40

Enjoying Surround Sound

Selecting the sound field	41
---------------------------------	----

Tuner Operations

Listening to FM/AM radio	42
Presetting radio stations.....	43

Using “BRAVIA” Sync features

What is “BRAVIA” Sync?.....	45
Preparing for the “BRAVIA” Sync.....	46
Playing back components with one-touch operation (One-Touch Play)	48
Enjoying the TV sound from the speakers connected to the receiver (System Audio Control)	48
Turning off the receiver with the TV (System Power Off).....	49
Using the Power Saving function (Power Save).....	50

Other Operations

Changing the brightness of the display (DIMMER).....	51
Changing the display setting (DISPLAY) ...	51
Using the Sleep Timer (SLEEP).....	52
Switching the audio input mode (IN MODE)	52
Using an S-AIR Product.....	53

Using the Remote

Changing the input button assignments.....	60
--------------------------------------------	----

Additional Information

Glossary.....	61
Precautions	63
Troubleshooting.....	64
Specifications	69
Index.....	Back cover

Description and location of parts

Front panel

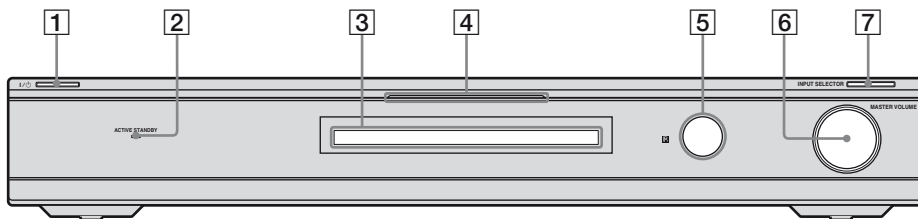

Name	Function
1 I/⏻ (on/standby)	Press to turn the receiver on or off (page 21, 29, 30).
2 ACTIVE STANDBY lamp	Lights up in amber when the Control for HDMI and/or S-AIR standby mode are set to on and the receiver is on standby mode. Note If the ACTIVE STANDBY lamp is flashing, see page 68.
3 Display	The current status of the selected component or a list of selectable items appears here (page 7).
4 White lamp	Lights up when the receiver is on and DSPL is set to on in DISPLAY function (page 51). Lights off when the receiver is in standby mode or DSPL is set to off in DISPLAY function.
5 Remote sensor	Receives signals from remote commander.
6 MASTER VOLUME	Turn to adjust the volume level of all speakers at the same time (page 28, 29, 30).
7 INPUT SELECTOR	Press to select the input source to playback (page 28, 29, 42, 43).

Indicators on the display

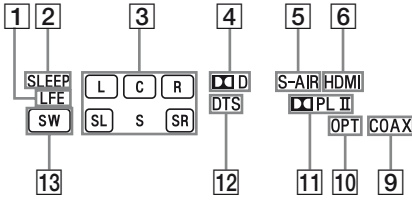

Name	Function
1 LFE	Lights up when the disc being played back contains an LFE (Low Frequency Effect) channel and the LFE channel signal is actually being reproduced.
2 SLEEP	Lights up when the sleep timer is activated (page 52).
3 Playback channel indicators	The letters (L, C, R, etc.) indicate the channels being played back. The boxes around the letters vary to show how the receiver downmixes the source sound. L Front Left R Front Right C Center (monaural) SL Surround Left SR Surround Right S Surround (monaural or the surround components obtained by Pro Logic processing) Example: Recording format (Front/Surround): 3/2.1 Sound Field: A.F.D. AUTO <div style="text-align: center;"> L C R SW SL SR </div>
4 D D D	Lights up when receiver is decoding Dolby Digital signals. Note When playing a Dolby Digital format disc, be sure that you have made digital connections.
5 S-AIR	Lights up when the S-AIR transmitter (not supplied) is connected.

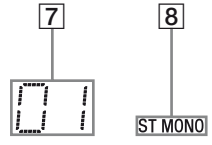

Name	Function
6 HDMI	Lights up when a playback component is connected to this receiver using an HDMI jack (page 18).
7 Preset station indicators	Lights up when using the receiver to tune in radio stations you have preset. For details on presetting radio stations, see page 43.
8 Tuner indicators	Lights up when using the receiver to tune in radio stations (page 42), etc.
9 COAX	Lights up when the source signal is a digital signal being input through the COAX IN jack.
10 OPT	Lights up when the source signal is a digital signal being input through the OPT IN jack.
11 D D PL/ PLII	“ D D PL ” lights up when the receiver applies Pro Logic processing to 2 channel signals in order to output the center and surround channel signals. “ D D PLII ” lights up when the Pro Logic II Movie/Music decoder is activated.
12 DTS	Lights up when the receiver is decoding DTS signals. Note When playing a DTS format disc, be sure that you have made digital connections.
13 SW	Lights up when the audio signal is output from the SUBWOOFER jack.

Rear panel

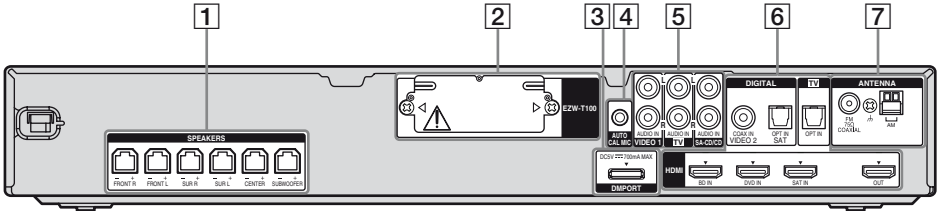

1 SPEAKERS section



Connects to the supplied speakers and subwoofer (page 15).

2 S-AIR (EZW-T100)

With slot cover



CAUTION
Please do not remove the slot cover until you want to install the wireless transmitter.

slot



Connects to a wireless transmitter (not supplied) (page 53).

3 DMPORT



DMPORT jack
Connects to a DIGITAL MEDIA PORT adapter (page 17).

4 AUTO CALIBRATION section



AUTO CAL MIC jack
Connects to the supplied optimizer microphone for the Auto Calibration function (page 24).

5 AUDIO INPUT section



White (L) AUDIO IN jacks
Connects to a Super Audio CD player, CD player, etc.



Red (R)

6 DIGITAL INPUT/OUTPUT section



OPT IN jacks
Connects to a DVD player, etc. The COAX IN jack provides a better sound quality (page 20).



COAX IN jack



HDMI IN/OUT jacks
Connects to a DVD player, satellite tuner, or a Blu-ray disc player. The image is output to a TV or a projector while the sound can be output from a TV or/and speakers connected to this receiver (page 18).

7 ANTENNA section



FM ANTENNA jack
Connects to the supplied FM wire antenna (page 21).



AM ANTENNA terminals
Connects to the supplied AM loop antenna (page 21).

Remote commander

You can use the supplied remote RM-AAU057 to operate the receiver and to control the Sony audio/video components that the remote is assigned to operate (page 60).

RM-AAU057

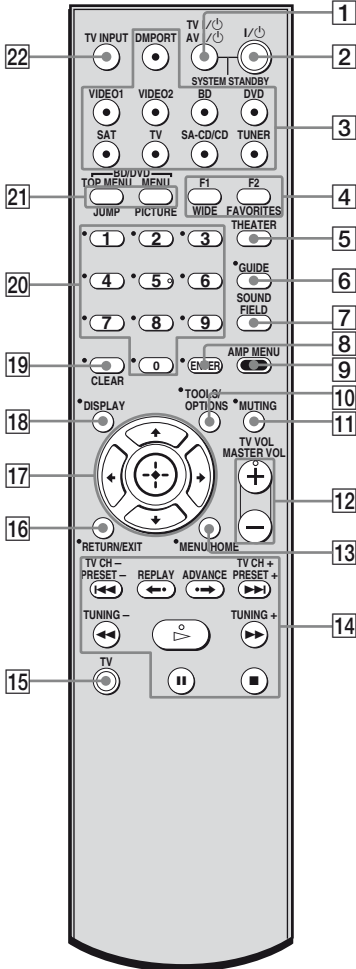

Basic operations

Remote Button Function

2	I/⏻ (on/standby)	Press to turn the receiver on or off. To turn off all Sony components, press I/⏻ (1) at the same time (SYSTEM STANDBY).
---	---------------------	----------------------------------------------------------------------------------------------------------------------------

Saving the power in standby mode

- When “CONTROL FOR HDMI” is set to “CTRL ON” and “P.SAVE” is set to “SAVE ON” (page 50).
- When S-AIR standby “STBY” is set to “STBY OFF” (page 59).

3	Input buttons	Press one of the buttons to select the component you want to use. The buttons are factory assigned to control Sony components. You can change the button assignments following the steps in “Changing the input button assignments” on page 60.
---	---------------	----------------------------------------------------------------------------------------------------------------------------------------------------------------------------------------------------------------------------------------------------

7	SOUND FIELD	Press to select a sound field.
---	-------------	--------------------------------

9	AMP MENU	Press to display the menu of the receiver.
---	----------	--------------------------------------------

11	MUTING	Press to turn off the sound temporarily. Press MUTING again to restore the sound.
----	--------	--------------------------------------------------------------------------------------



12	MASTER VOL +*/-	Press to adjust the volume.
----	--------------------	-----------------------------

17	⬆️, ⬇️, ⬅️, ➡️, ⬆️/⬇️/⬅️/➡️	Press ⬆️, ⬇️, ⬅️ or ➡️ to select the settings. Then, press ⬆️/⬇️/⬅️/➡️ to enter the selection.
----	-----------------------------	------------------------------------------------------------------------------------------------







continued

9US

Tuner operations

Remote Button	Function
8 ENTER	Press to enter the selection.
13 MENU/HOME	Press to display the menu.
14 PRESET +/-	Press to select a preset station.
TUNING +/-	Press to scan the station.
17  ,  , 	Press to select the menu items and to enter the selection.
18 DISPLAY	Press to display the information during Tuner function.
19 CLEAR	Press to clear a mistake when you input a wrong character.

DMPORT operations

Remote Button	Function
14  	Press to skip the track.
 	Press to fast reverse or fast forward.
 * (playback)/  (pause, press again to resume normal playback/  (stop)	Play mode button.

To control the component

1 Press one of the input buttons **3** (TV, BD, DVD, or SAT) to select the component you want to operate.

The component assigned to the selected input button becomes operable.

2 Referring to the following table, press the corresponding button for the operation.



Common operations

Remote Button	Function
1 TV I/⏻ AV I/⏻ (on/standby)	Press to turn on or off the Sony audio/video components that the remote is assigned to operate (page 60). Press 1 I/⏻ and 2 TV I/⏻/AV I/⏻ at the same time to turn off the receiver and all other components that the remote is assigned to operate (SYSTEM STANDBY).
8 ENTER	Press to enter the selection.
20 Numeric buttons (number 5*)	Press to select channels and tracks directly.









To control the TV

Press and hold (**15**) TV (yellow) button while pressing the buttons with a yellow dot or yellow printing to control the TV.

Remote Button	Function
4 FAVORITES	To display the stored favorite channel list of TV.
WIDE	To select the wide picture mode.
5 THEATER	Press to sets the optimal picture settings automatically for watching movies, when you connect a Sony TV which is compatible with the THEATER button. Also, the audio is automatically switched to the audio output of this receiver when you connect the TV and the receiver with HDMI connection, and the Control for HDMI function is set to on.
6 GUIDE	Press to display the guide when you are watching analog and digital channels.
10 TOOLS/OPTIONS	Press to enable you to access various viewing options and change/make adjustments according to the source and screen format.

Remote Button	Function
11 MUTING	Press to turn off the sound.
12 TV VOL +/-	Press to adjust the volume.
13 MENU/HOME	Press to allow you to select channels or input sources and change the settings for your TV.
14 TV CH +/-	Selects the next (+) or previous (-) channel. To scan quickly through channels, press and hold down either +/-.
16 RETURN/EXIT	Press to return to the previous screen of any displayed menu.
17 	Press to select the menu item and enters the selection.
18 DISPLAY	Display the TV's information on the TV screen. (Displays the current channel number, etc.)
19 	Selects digital channels using with the 0-9 and ENTER buttons. For example, to enter "2.1", press (2), (.), (1) and ENTER.
20 Numeric buttons (number 5*)	Press to select channels. Press ENTER ([8]) to change channels immediately.
21 JUMP	To select the previous and the current channels of the TV, Satellite tuner, Blu-ray disc recorder, DVD player.
PICTURE	To cycle through the available picture modes of the TV.
22 TV INPUT	Press to select input.

To control the DVD recorder/Blu-ray Disc recorder

Remote Button	Function
4 F1	Press to select the HDD.
F2	Press to select the Blu-ray Disc/DVD.
13 MENU/HOME	Press to display the menu.
14 	Press to skip chapters.
REPLAY 	Press to jump backward while viewing live or recorded programs.
ADVANCE 	Press to jump forward while viewing recorded programs.
	Press to skip forward to the next available chapter.
	Press to fast reverse or to fast forward the disc when pressed during playback.
 * (playback)/  (pause, press again to resume normal playback/  (stop)	Play mode button.
17 	Press to select a menu item and enters the selection.
21 BD/DVD TOP MENU, MENU	Press to display the top menu or disc menu.

continued

11 US

To control the DVD player/ Blu-ray Disc player

Remote Button	Function
13 MENU/HOME	Press to display the menu.
14 ◀◀/▶▶	Press to skip chapters.
REPLAY ◀◀	Press to jump backward.
ADVANCE ▶▶	Press to jump forward.
◀◀/▶▶	Press to fast reverse or to fast forward the disc when pressed during playback.
▷* (playback)/ ▬▬ (pause, press again to resume normal playback/ ■ (stop)	Play mode button.
17  , ↑/↓/←/→	Press to select a menu item and enters the selection.
21 BD/DVD TOP MENU, MENU	Press to display the top menu or disc menu.

To control the HDD/DVD COMBO

Remote Button	Function
4 F1	Press to select the HDD.
F2	Press to select the DVD.
13 MENU/HOME	Press to display the menu.
14 ◀◀/▶▶	Press to specify the previous/next chapter/track.
REPLAY ◀◀	Press to change to replay mode.
ADVANCE ▶▶	Press to advance.
◀◀/▶▶	Press to fast reverse or to fast forward the disc when pressed during playback.
▷* (playback)/ ▬▬ (pause, press again to resume normal playback/ ■ (stop)	Play mode button.
17  , ↑/↓/←/→	Press to move the highlight (cursor) and selects the item.
21 BD/DVD TOP MENU, MENU	Press to display the top menu or disc menu.

To control the SAT

Remote Button	Function
6 GUIDE	Press to display the guide menu.
13 MENU/HOME	Press to display the menu.
17  , ↑/↓/←/→	Press to select a menu item and enters the selection.

* The number 5, MASTER VOL + and ▷ buttons have tactile dots. Use the tactile dots as references when operating the receiver.

Notes

- Some functions explained in this section may not work depending on the model.
- The above explanation is intended to serve as an example only. Therefore, depending on the component, the above operation may not be possible or may operate differently than described.

1: Installing the speakers

This receiver allows you to use a 5.1 channel speaker system. To fully enjoy theater-like multi channel surround sound, be sure to connect all the speakers (two front speakers, a center speaker, and two surround speakers) and a subwoofer (5.1 channel).

You can place your speakers as shown below.

- A** Front speaker (left)
- B** Front speaker (right)
- C** Center speaker
- D** Surround speaker (left)
- E** Surround speaker (right)
- F** Subwoofer

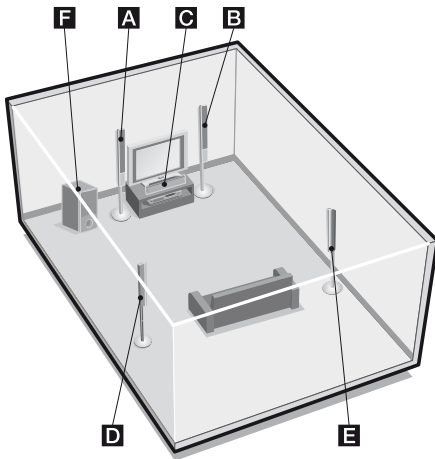

Tip

Since the subwoofer does not emit highly directional signals, you can place it wherever you want.

Installing the speakers on a flat surface

Before you install the speaker and subwoofer, be sure to attach the supplied foot pads to the center speaker and subwoofer to prevent vibration or movement as shown in the illustration below.

Example of subwoofer

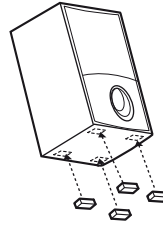

Installing the speakers on the speaker stand

For greater flexibility in positioning the speakers, use the supplied speaker stand. For details, refer to the supplied speaker stand installation guide.

Installing the speakers on the wall

You can install your speakers on the wall.

- 1 Prepare screws (not supplied) that are suitable for the hook on the back of each speaker. See the illustrations below.**

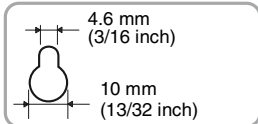
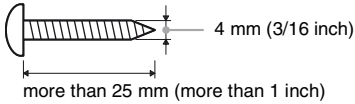

Hook on the back of the speaker

- 2 Fasten the screws to the wall. The screws should protrude 7/32 to 9/32 inch.**

For the center speaker

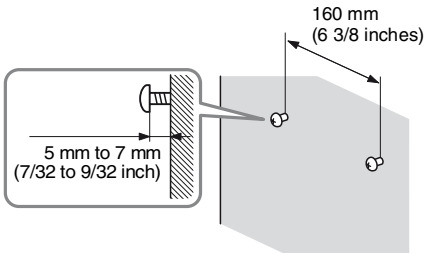

For the front speakers

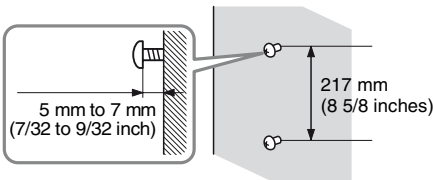

For the surround speakers

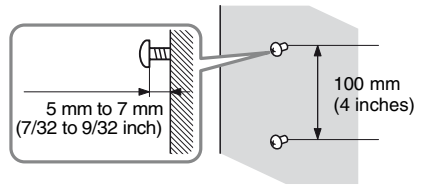

- 3 Hang the speakers on the screws.**

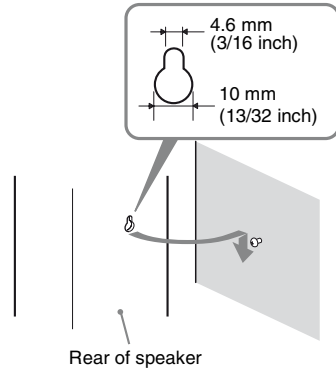

Notes

- Use screws that are suitable for the wall material and strength. As a plaster board wall is especially fragile, attach the screws securely to a beam and fasten them to the wall. Install the speakers on a vertical and flat wall where reinforcement is applied.
- Contact a screw shop or installer regarding the wall material or screws to be used.
- Sony is not responsible for accident or damage caused by improper installation, insufficient wall strength or improper screw installation, natural calamity, etc.
- If you install the speakers on the wall, you do not need to attach the supplied speaker stand.

2: Connecting the speakers

Before connecting the cords, be sure to disconnect the AC power cord (mains lead).

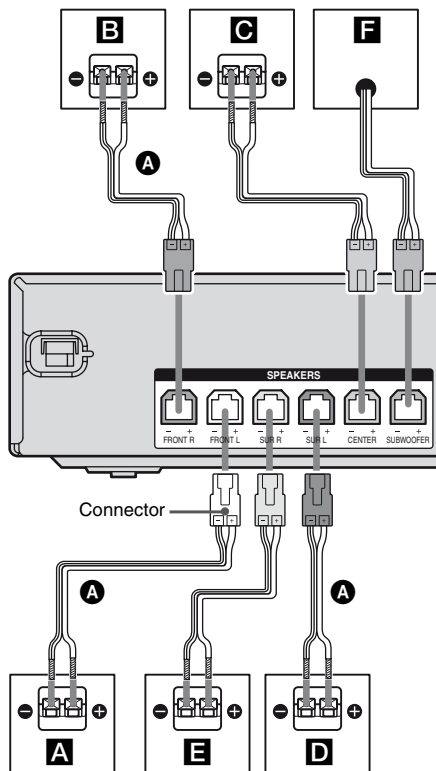

A Speaker cord (supplied)

A Front speaker (left)

B Front speaker (right)

C Center speaker

D Surround speaker (left)

E Surround speaker (right)

F Subwoofer

Note on speaker cords

The connector of the speaker cords are the same color as the speaker jack to be connected. When connecting a speaker cord, be sure to match the colored connector to the speaker jack on the receiver:

Connector	Speaker jack
Red	FRONT R
White	FRONT L
Grey	SUR R
Blue	SUR L
Green	CENTER
Purple	SUBWOOFER

To connect the speakers correctly

Check the speaker type by referring to the speaker label* at the rear panel of the speakers.

Character on speaker label	Speaker type
L	Front left
R	Front right
SL	Surround left
SR	Surround right

* The center speaker and subwoofer do not have the character on the speaker label. For details on the speaker type, see page 4.

3: Connecting the TV

You can watch the selected input image when you connect the HDMI OUT jack to a TV. It is not necessary to connect all the cords. Connect audio and video cords according to the jacks of your components. Before connecting the cords, be sure to disconnect the AC power cord.

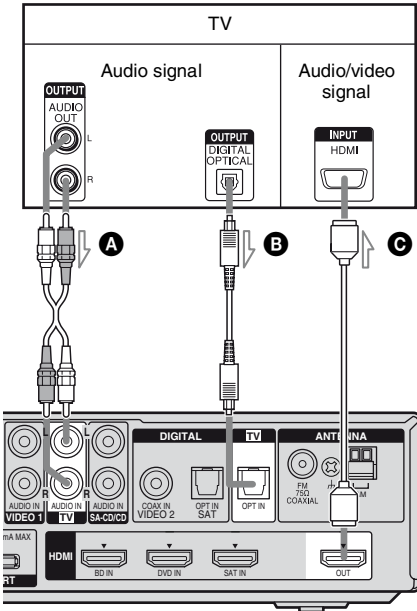

- A** Audio cord (not supplied)
- B** Optical digital cord (not supplied)
- C** HDMI cable (not supplied)

We recommend that you use a Sony HDMI cable.

Notes

- Be sure to turn on the receiver when the video and audio signals of a playback component are being output to a TV via the receiver. Unless the power is turned on, neither video nor audio signals will be transmitted.
- When connecting optical digital cords, insert the plugs straight in until they click into place.
- Do not bend or tie optical digital cords.

Tips

- To output the sound of the TV from the speakers connected to the receiver, be sure to
 - connect the audio output jacks of the TV to the TV IN jacks of the receiver.
 - turn off the TV's volume or activate the TV's muting function.
- All the digital audio jacks are compatible with 32 kHz, 44.1 kHz, 48 kHz, and 96 kHz sampling frequencies.

4: Connecting the audio/video components

How to hook up your components

This section describes how to hook up your components to this receiver. Before you begin, refer to “Component to be connected” below for the pages which describe how to connect the audio/video components.

Before connecting the cords, be sure to disconnect the AC power cord (mains lead). After hooking up all your components, proceed to “5: Connecting the antennas” (page 21).

Component to be connected

To connect	See
TV	page 16
Audio components	page 17
<ul style="list-style-type: none"> • Super Audio CD player/ CD player • DIGITAL MEDIA PORT adapter 	
Components with HDMI jack	page 18
Video components	page 20
<ul style="list-style-type: none"> • Satellite tuner, Set-top box • DVD player, DVD recorder • VCR 	

Connecting audio components

The following illustration shows how to connect audio components such as Super Audio CD player or CD player and DIGITAL MEDIA PORT adapter.

You can also view the images on the TV screen by connecting the video output of the DIGITAL MEDIA PORT adapter to the video input of the TV.

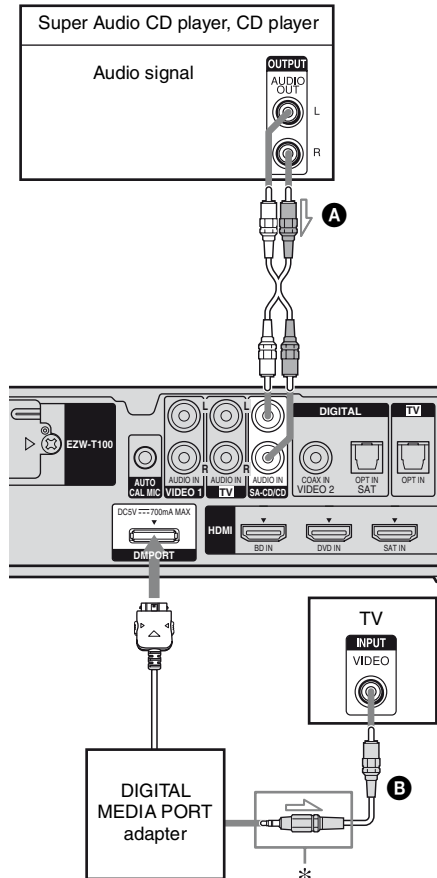

- A** Audio cord (not supplied)
- B** Video cord (not supplied)

* The type of connector varies depending on the DIGITAL MEDIA PORT adapter.

For details, refer to the operating instructions supplied with the DIGITAL MEDIA PORT adapter.

continued

Notes on connecting DIGITAL MEDIA PORT adapter

- Do not connect or disconnect the DIGITAL MEDIA PORT adapter while the receiver is turned on.
- Be sure to make DMPORT connections firmly, insert the connector straight in.
- As the connector of the DIGITAL MEDIA PORT adapter is fragile, be sure to handle with care when placing or moving the receiver.
- When connecting the DIGITAL MEDIA PORT adapter, be sure the connector is inserted with the arrow mark facing toward the arrow mark on the DMPORT jack. To detach the DIGITAL MEDIA PORT adapter, press and hold both sides of the connector and then pull out the connector.

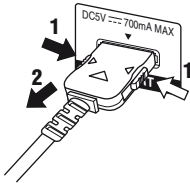

Connecting components with HDMI jacks

HDMI is the abbreviated name for High-Definition Multimedia Interface. It is an interface which transmits video and audio signals in digital format.

Sony recommends that you connect components to the receiver using an HDMI cable.

With HDMI, you can easily enjoy both high quality sound and high quality images.

However, it is necessary to connect the audio output of the TV to the audio input of the receiver using an optical cord to listen to the TV multi channel surround sound broadcasting from the receiver.

By connecting Sony “BRAVIA” Sync compatible components using HDMI cables, “BRAVIA” Sync Features” makes operations simpler (page 45).

HDMI features

- A digital audio signals transmitted by HDMI can be output from the speakers connected to the receiver. This signal supports Dolby Digital, DTS and Linear PCM.
- This receiver supports xvYCC transmission.
- This receiver supports the Control for HDMI function. For details, see “Using “BRAVIA” Sync features” (page 45).

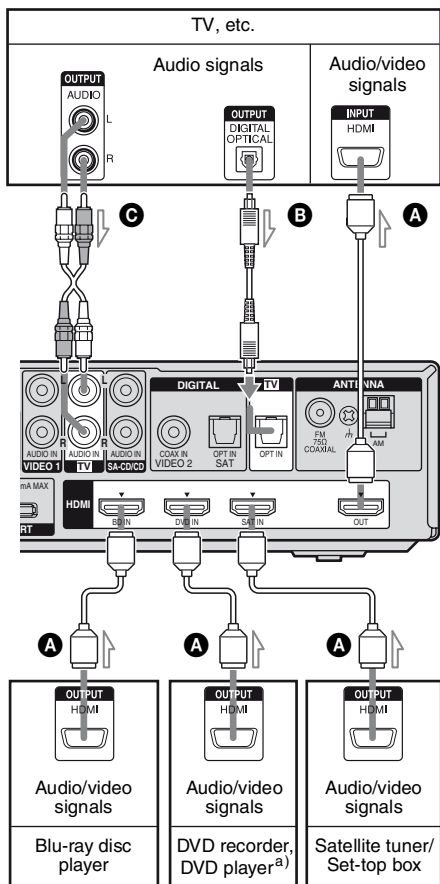

A HDMI cable (not supplied)

We recommend that you use a Sony HDMI cable.

B Optical digital cord (not supplied)^{b)}

C Audio cord (not supplied)^{b)}

- ^{a)} If you connect a DVD player, be sure to change the factory setting of the DVD button on the remote so that you can use the button to control your DVD player. For details, see “Changing the input button assignments” (page 60).

^{b)} Connect at least one of the audio cords (**B** or **C**).

Notes on HDMI connections

- An audio signal input to the HDMI IN jack is output from the SPEAKERS jacks and HDMI OUT jack. It is not output from any other audio jacks.
- Video signals input to the HDMI IN jack can only be output from the HDMI OUT jack.
- The multi/stereo area audio signals of a Super Audio CD are not output.
- Audio signals (sampling frequency, bit length, etc.) transmitted from an HDMI jack may be suppressed by the connected component. Check the setup of the connected component if the image is poor or the sound does not come out of a component connected via the HDMI cable.
- Sound may be interrupted when the sampling frequency, the number of channels or the audio format of the audio output signals from the playback component is switched.
- When the connected component is not compatible with copyright protection technology (HDCP), the image and/or the sound from the HDMI OUT jack may be distorted or may not be output. In this case, check the specification of the connected component.
- You can enjoy multi channel Linear PCM only with an HDMI connection.
- Set the image resolution of the playback component to 720p, 1080i or 1080p when you output 96 kHz multi channel sound over an HDMI connection.
- You may need to make certain settings on the image resolution of the player before you can enjoy multi channel Linear PCM. Refer to the operating instructions of the player.
- Refer to the operating instructions of each component connected for details.
- We do not recommend using an HDMI-DVI conversion cable. When you connect an HDMI-DVI conversion cable to a DVI-D component, the sound and/or the image may not be output.

Connecting video components

The following illustration shows how to connect video components such as DVD player, DVD recorder, VCR, etc. It is not necessary to connect all the cords. Connect audio and video cords according to the jacks of your components.

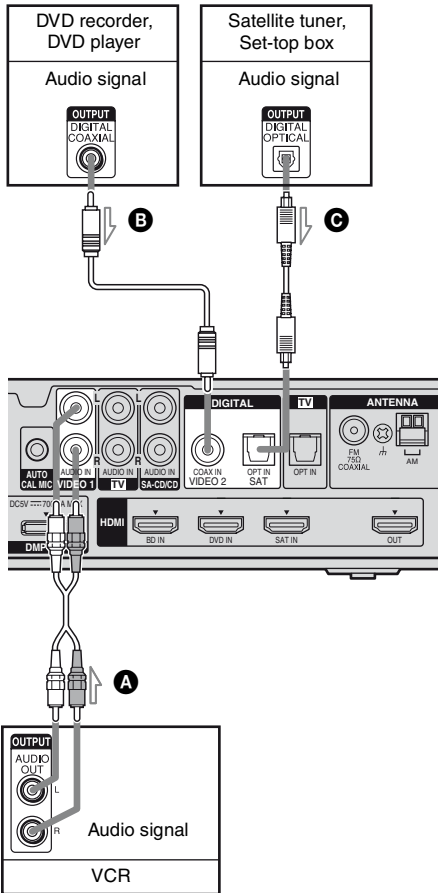

- A** Audio cord (not supplied)
- B** Coaxial digital cord (not supplied)
- C** Optical digital cord (not supplied)

Notes

- To input multi channel digital audio from the DVD player, set the digital audio output setting on the DVD player. Refer to the operating instructions supplied with the DVD player.
- When connecting optical digital cords, insert the plugs straight in until they click into place.
- Do not bend or tie optical digital cords.
- Be sure to connect the video output of the DVD player, DVD recorder and VCR to the TV, so that the image is displayed on the TV. Refer to the operating instructions of each connected component for details.
- You cannot do recording on the DVD recorder or VCR via this receiver. For details, refer to the operating instructions supplied with the DVD recorder or VCR.

Tips

- To output the sound of the TV from the speakers connected to the receiver, be sure to
 - connect the audio output jacks of the TV to the TV IN jacks of the receiver.
 - turn off the TV's volume or activate the TV's muting function.
- All the digital audio jacks are compatible with 32 kHz, 44.1 kHz, 48 kHz, and 96 kHz sampling frequencies.

5: Connecting the antennas

Connect the supplied AM loop antenna and FM wire antenna.

Before connecting the antennas, be sure to disconnect the AC power cord (mains lead).

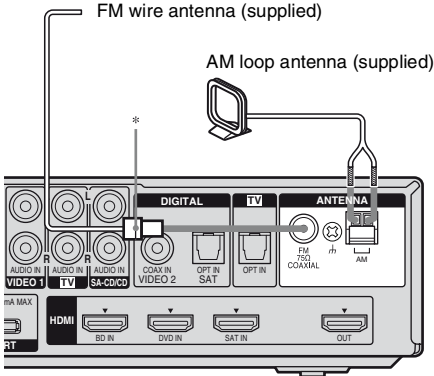

* The shape of the connector varies depending on the area code of this receiver.

Notes

- To prevent noise pickup, keep the AM loop antenna away from the receiver and other components.
- Be sure to fully extend the FM wire antenna.
- After connecting the FM wire antenna, keep it as horizontal as possible.

6: Preparing the receiver and the remote

Connecting the AC power cord (mains lead)

Connect the AC power cord (mains lead) to a wall outlet.

AC power cord (mains lead)

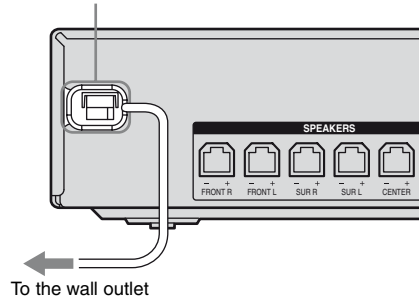

Performing initial setup operations

Before using the receiver for the first time, initialize the receiver by performing the following procedure. This procedure can also be used to return settings you have made to their factory defaults.

Be sure to use the buttons on the receiver for this operation.

1,2

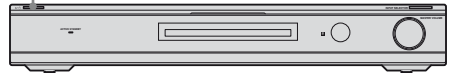

1 Press **I/⏻** to turn on the receiver.

2 Hold down **I/⏻** for 5 seconds.

“CLEARED” appears.

All the settings you have changed or adjusted are reset to the initial settings.

Inserting batteries into the remote

Insert two R6 (size-AA) batteries in the RM-AAU057 Remote Commander. Observe the correct polarity when installing batteries.

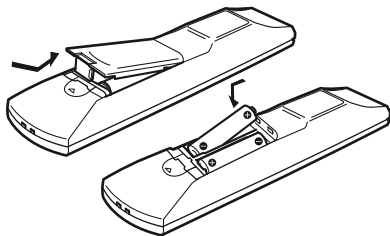

Notes

- Do not leave the remote in an extremely hot or humid place.
- Do not use a new battery with old ones.
- Do not mix manganese batteries and other kinds of batteries.
- Do not expose the remote sensor to direct sunlight or lighting apparatuses. Doing so may cause a malfunction.
- If you do not intend to use the remote for an extended period of time, remove the batteries to avoid possible damage from battery leakage and corrosion.
- When you replace the batteries, the remote buttons may be reset to their factory settings. If this happens, reassign the buttons again (page 60).
- When the remote no longer operates the receiver, replace all the batteries with new ones.

7: Calibrating the appropriate settings automatically (AUTO CALIBRATION)

This receiver is equipped with DCAC (Digital Cinema Auto Calibration) Technology which allows you to perform automatic calibration as follows:

- Check the connection between each speaker and the receiver.
- Adjust the speaker level.
- Measure the distance of each speaker from your listening position.
- Measure the frequency characteristics.*

* The measurement result is not utilized for signals with a sampling frequency of more than 96 kHz.

The DCAC is designed to obtain proper sound balance in your room. However, you can adjust the speaker levels manually according to your preference. For details, see “8: Adjusting the speaker levels (TEST TONE)” (page 27).

Before you perform Auto Calibration

Before you perform the Auto Calibration, set up and connect the speakers (page 13, 15).

- The AUTO CAL MIC jack is used for the supplied optimizer microphone only. Do not connect other microphones to this jack. Doing so may damage the receiver and the microphone.
- During the calibration, the sound that comes out of the speakers is very loud. The volume of the sound cannot be adjusted. Pay attention to the presence of children or to the effect on your neighborhood.
- Perform the Auto Calibration in a quiet environment to avoid the effect of noise and to get a more accurate measurement.
- If there are any obstacles in the path between the optimizer microphone and the speakers, the calibration cannot be performed correctly. Remove any obstacles from the measurement area to avoid measurement error.

Notes

- If the muting function has been activated before you perform Auto Calibration, the muting function will be set to off automatically.
- When you use the S-AIR product, disconnect the headphones.

Example:

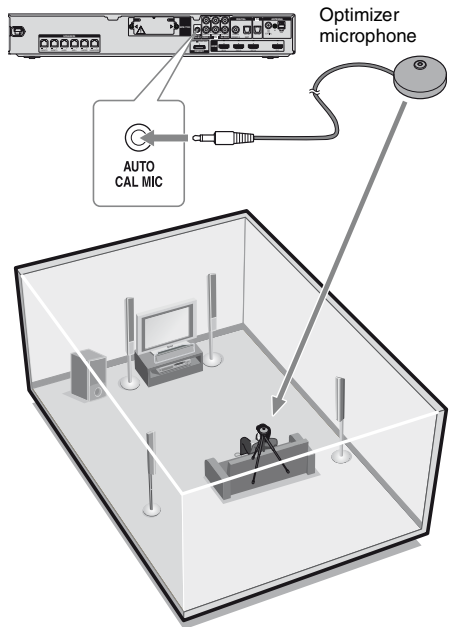

1 Connect the supplied optimizer microphone to the AUTO CAL MIC jack.

2 Set up the optimizer microphone.

Place the optimizer microphone at your listening position. You can also use a stool or tripod so that the optimizer microphone remains at the same height as your ears.

Tip

When you face the speaker towards the optimizer microphone, you will get a more accurate measurement.

Performing Auto Calibration

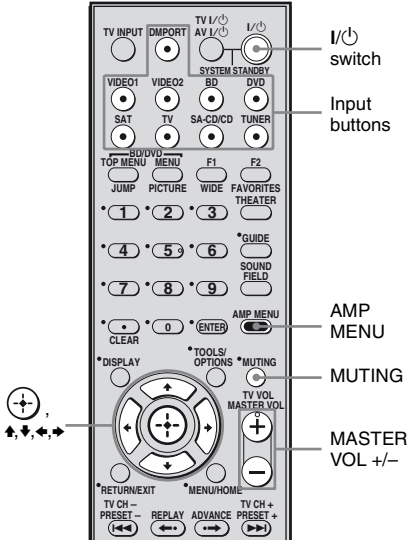

- 1 Press AMP MENU.**
- 2 Press \uparrow/\downarrow repeatedly to select “A.CAL”.**
- 3 Press \odot or \rightarrow to enter the menu.**
“START” appears on the display.
- 4 Press \odot to start the measurement.**

Measurement starts in 5 seconds.

While the time is counting down, stand away from the measurement area to avoid measurement error.

The measurement process will take approximately 30 seconds to complete.

The table below shows the display when measurement starts.

Measurement for	Display
Speaker existence	TONE
Speaker gain, distance, frequency response	T.S.P.
Subwoofer gain and distance	WOOFER

Notes

- If “PHONES” appears, you cannot perform the Auto Calibration. Disconnect the headphones from the S-AIR product you are using, then restart the Auto Calibration.
- If “CHK MIC” appears, you cannot perform the Auto Calibration. Connect the calibration mic, then restart the Auto Calibration.

Tips

- When Auto Calibration starts:
 - Stand some distance from the speakers and the listening position to avoid measurement failure. This is because test signals are output from the speakers during measurement.
 - Avoid making noise to get a more accurate measurement.
- The Auto Calibration function will be canceled when you do the following during the measurement process:
 - Press I/⏻ or MUTING.
 - Press input buttons on the remote or INPUT SELECTOR on the receiver.
 - Change the volume level.

Confirming/saving the measurement results

1 Confirm the measurement result.

When the measurement ends, a beep sounds and the measurement result appears on the display.

Measurement result	Display	Explanation
When the measurement process completes properly	SAVE	Proceed to step 2.
When the measurement process fails	ERROR XXXX	See “When error codes appear” (page 25).

2 Press \uparrow/\downarrow repeatedly to select the item. Then, press \oplus .

Item	Explanation
SAVE	Saves the measurement results and exits the setting process.
WRN CHK	Displays warning concerning the measurement results. See “When you select “WRN CHK”” (page 25).
DIST	Displays the measurement result for speaker distance.
LEVEL	Displays the measurement result for speaker level.
EXIT	Exits the setting process without saving the measurement results.

Note

After “SAVE” is displayed for 50 seconds, the measurement result is saved automatically, without the need to save the procedure.

3 Save the measurement result.

Select “SAVE” in step 2.

The measurement results are saved.

When error codes appear

Try the remedies and perform the Auto Calibration again.

Error code	Cause and remedies
ERROR 32	<ul style="list-style-type: none"> The sound input from the optimizer microphone is out of the acceptable range. The optimizer microphone or subwoofer may be damaged. Contact your Sony dealer or local authorized Sony service facility.
ERROR F 33	The front speakers are not connected. Check that the front speakers are connected properly.
ERROR SR 33	Either the surround left or surround right speaker is not connected. Check that the surround speakers are connected properly.
ERROR SW 33	The subwoofer may be damaged. Contact your Sony dealer or local authorized Sony service facility.

When you select “WRN CHK”

If a warning on the measurement result is present, detailed information is displayed.

Press \oplus or \leftarrow to return to step 2 of “Confirming/saving the measurement results”.

Warning code	Explanation
WARN 40	The Auto Calibration has completed. However, the noise level is high. You may be able to perform the Auto Calibration properly if you try it again, even though the measurement cannot be performed in all environments. Try to perform the Auto Calibration in a quiet environment.

Warning code	Explanation
WARN 41 WARN 42	The sound input from the optimizer microphone is out of the acceptable range. The distance between the optimizer microphone and the speakers is too closed. The distance between the optimizer microphone and the speakers is too closed. Set them away, and then try to perform the Auto Calibration.
WARN 43	The distance and position of a subwoofer cannot be detected. This may be caused by noise. Try to perform the Auto Calibration in a quiet environment.
NO WARN	There is no warning information.

When you select “DIST” or “LEVEL”

You can check the speaker distance or speaker level.

When you have finished

Disconnect the optimizer microphone from the receiver.

Note

If you have changed the position of the speakers, it is recommended that you perform Auto Calibration again in order to enjoy the surround sound.

Clearing the measurement result

You can delete the result of Auto Calibration. If there is no saved data, you cannot delete the result.

- 1 Press AMP MENU.**
- 2 Press \uparrow/\downarrow repeatedly until “A.CAL” appears, then press \oplus or \rightarrow .**
- 3 Press \uparrow/\downarrow repeatedly to select “A.CAL CLR”, then press \oplus or \rightarrow .**
- 4 Press \uparrow/\downarrow to select “YES”, then press \oplus .**

The saved result is deleted.

The settings for speaker distance and speaker level return to their defaults.

8: Adjusting the speaker levels

(TEST TONE)

You can adjust the speaker levels while listening to the test tone from your listening position.

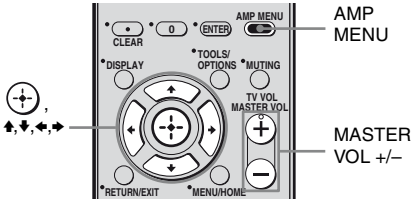

1 Press AMP MENU.

“SET HDMI” appears on the display.

2 Press \uparrow/\downarrow repeatedly until “LEVEL” appears, then press \oplus or \rightarrow .

3 Press \uparrow/\downarrow repeatedly until “T. TONE” appears, then press \oplus or \rightarrow .

4 Press \uparrow/\downarrow repeatedly to select “T. TONE Y”, then press \oplus .

The test tone is output from each speaker in sequence as follows:

Front left \rightarrow Center \rightarrow Front right \rightarrow
Surround right \rightarrow Surround left \rightarrow
Subwoofer

5 Press \leftarrow until “T. TONE” appears.

6 Press \uparrow/\downarrow repeatedly to select the desired speaker, then press \oplus or \rightarrow .

The test tone is emitted from the speaker that is being adjusted only.

- FL LVL: adjusts the front left speaker level.
- CNT LVL: adjusts the center speaker level.

- FR LVL: adjusts the front right speaker level.
- SR LVL: adjusts the surround right speaker level.
- SL LVL: adjusts the surround left speaker level.
- SW LVL: adjusts the subwoofer level.

Notes

- “CNT LVL” does not appear when you set “CNT N” in the “SP SETUP” setting.
- “SR LVL” and “SL LVL” do not appear when you set “SUR N” in the “SP SETUP” setting.

7 Press \uparrow/\downarrow repeatedly to adjust the speaker level, then press \oplus or \rightarrow .

You can adjust from -6.0 dB to $+6.0$ dB in 0.5 dB steps.

Note

If you do not adjust for a certain period, the test tone is emitted from the next speaker in sequence.

8 Repeat step 6 and 7 to adjust the other speaker level.

9 After you have finished making adjustments, press \uparrow/\downarrow until “T. TONE” appears, then press \oplus or \rightarrow .

10 Press \uparrow/\downarrow repeatedly to select “T. TONE N”, then press \oplus .

11 Press AMP MENU.

The AMP menu turns off.

When a test tone is not output from the speakers

- The speaker cords may not be connected securely.
- The speaker cords may have the short-circuit problem.
- The test tone signals are not output from the HDMI OUT jack.

Selecting a component

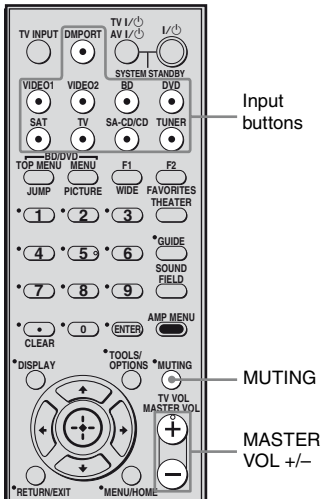

1 Press the input button to select a component.

You can also use INPUT SELECTOR on the receiver.
The selected input appears on the display.

Selected input [Display]	Components that can be played back
DMPOR [DMPOR]	DIGITAL MEDIA PORT adapter connected to the DMPOR jack
VIDEO1 or VIDEO2 [VIDEO 1 or VIDEO 2]	VCR, etc., connected to the VIDEO 1 or VIDEO 2 jack
BD [BD]	Blu-ray disc player, etc., connected to the BD jack
DVD [DVD]	DVD player, DVD recorder, etc., connected to the DVD jack
SAT [SAT]	Satellite tuner, set-top box, etc., connected to the SAT jack

Selected input [Display]	Components that can be played back
TV [TV]	TV, etc., connected to the TV jack
SA-CD/CD [SA-CD/CD]	Super Audio CD/CD player, etc., connected to the SA-CD/CD jack
TUNER [FM or AM band]	Built-in radio tuner

2 Turn on the component and start playback.

3 Press MASTER VOL +/- to adjust the volume.

You can also use MASTER VOLUME on the receiver.

To activate the muting function

Press MUTING.

The muting function will be canceled when you do the following.

- Press MUTING again.
- Increase the volume.
- Turn off the receiver.

To avoid damaging your speakers

Before you turn off the receiver, be sure to turn down the volume level.

Enjoying sound/images from the components connected to the receiver

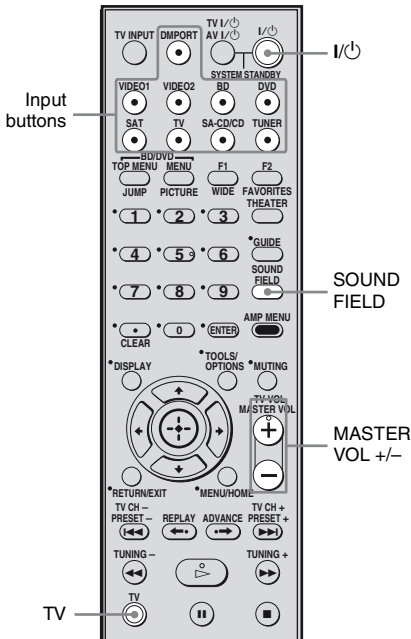

Enjoying TV

- 1 Turn on the TV and choose a program.**
For details, refer to the operating instructions of the TV.
- 2 Turn the receiver on.**
- 3 Press TV.**
- 4 Adjust the volume of the receiver.**

Tips

- When you connect a Sony TV, the audio input of the TV is switched and the image from the TV tuner is displayed on the TV screen automatically by pressing the TV button. To change this setting, see “Changing the input button assignments” (page 60).
- The sound may be output from the TV’s speaker. In this case, turn the volume of the TV’s speaker down to the minimum.

Enjoying a satellite tuner

- 1 Turn on the TV.**
For details, refer to the operating instructions of the TV.
- 2 Turn the satellite tuner and the receiver on.**
- 3 Press SAT.**
You can also use INPUT SELECTOR on the receiver to select “SAT”.
- 4 Change the TV input.**
For details, refer to the operating instructions of the TV.
- 5 Adjust the volume of the receiver.**

Tip

- The sound may be output from the TV’s speaker. In this case, turn the volume of the TV’s speaker down to the minimum.

Enjoying Blu-ray Disc or DVD

- 1 Turn on the TV.**
- 2 Turn the Blu-ray Disc or DVD player (recorder) and the receiver on.**
- 3 Press DVD or BD.**

You can also use INPUT SELECTOR on the receiver to select “DVD” or “BD”. Be sure to change the factory setting of the DVD input button on the remote so that you can use the button to control your DVD player. For details, see “Changing the input button assignments” (page 60).
- 4 Change the TV input.**

For details, refer to the operating instructions of the TV.
- 5 Play back the disc.**
- 6 Adjust the volume.**

Tip

Even if you playback Dolby True HD, Dolby Digital Plus or DTS-HD with a connected component compatible with these sound formats, the receiver accepts as Dolby Digital or DTS. When you connect the component to the receiver using an HDMI cable to playback these high-quality sound formats, set the connected component to output the sound in multi channel PCM, if possible.

Enjoying a VCR

- 1 Turn on the TV.**
- 2 Turn the VCR player and the receiver on.**
- 3 Press VIDEO 1 or VIDEO 2.**

You can also use INPUT SELECTOR on the receiver to select “VIDEO 1” or “VIDEO 2”.
- 4 Change the TV input.**

For details, refer to the operating instructions of the TV.
- 5 Play back the tape on the VCR.**

Enjoying a Super Audio CD/CD

- 1 Turn on the Super Audio CD player/CD player, then place the disc on the tray.**
- 2 Turn on the receiver.**
- 3 Press SA-CD/CD.**

You can also use INPUT SELECTOR on the receiver to select “SA-CD/CD”.
- 4 Adjust the volume.**

Enjoying a connected component through DMPORT connection

1 Press DMPORT.

You can also use INPUT SELECTOR on the receiver to select “DMPORT”.

2 Start playback of the connected component.

Tip

When listening to MP3 or other compressed music using a portable audio source, you can enhance the sound. Press SOUND FIELD repeatedly to select “P. AUDIO” (page 41).

Amplifier Operations

Navigating through menus

By using the amplifier menus, you can make various adjustments to customize the receiver.

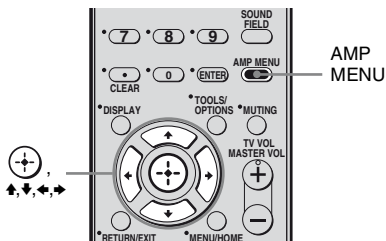

- 1 Press AMP MENU.**
“SET HDMI” appears on the display.
- 2 Press \uparrow/\downarrow repeatedly to select the menu you want.**
- 3 Press \oplus or \rightarrow to enter the menu.**
- 4 Press \uparrow/\downarrow repeatedly to select the parameter you want to adjust.**
- 5 Press \oplus or \rightarrow to enter the parameter.**
- 6 Press \uparrow/\downarrow repeatedly to select the setting you want.**
- 7 Press \oplus or \rightarrow to enter the setting.**

To return to the previous display

Press \leftarrow .

To exit the menu

Press AMP MENU.

Overview of the menus

The following options are available in each menu. For details on navigating through menus, see page 32.

Menu [Display]	Parameters [Display]	Settings	Initial setting
HDMI settings [SET HDMI] (page 36)	Control for HDMI ^{a)} ^{b)} [CONTROL FOR HDMI]	CTRL ON, CTRL OFF	CTRL OFF ^{c)}
	Volume limit ^{a)} [VOL LIM]	MAX, 39.....1, MIN	MAX
	Power save ^{a)} [P.SAVE]	SAVE ON, SAVE OFF	SAVE ON
Auto Calibration settings [A.CAL] (page 36)	Auto calibration start ^{a)} [START]	For details, see “Performing Auto Calibration” (page 24).	
	Clear Auto Calibration result ^{a)} ^{d)} [A.CAL CLR]	YES, NO	NO
Speaker settings [SP SETUP] (page 37)	Center speaker ^{a)} [CNT SP]	CNT Y, CNT N	CNT Y
	Surround speakers ^{a)} [SUR SP]	SUR Y, SUR N	SUR Y
	Front left speaker distance ^{a)} ^{e)} [FL DIST]	FL 0.00 m to FL 7.00 m (FL 0.00 ft. to FL 23.00 ft.) (0.10 m (0.25 ft.) step)	FL 3.00 m (FL 10.00 ft.)
	Center speaker distance ^{a)} ^{e)} [CNT DIST]	CNT 0.00 m to CNT 7.00 m (CNT 0.00 ft. to CNT 23.00 ft.) (0.10 m (0.25 ft.) step)	CNT 3.00 m (CNT 10.00 ft.)
	Front right speaker distance ^{a)} ^{e)} [FR DIST]	FR 0.00 m to FR 7.00 m (FR 0.00 ft. to FR 23.00 ft.) (0.10 m (0.25 ft.) step)	FR 3.00 m (FR 10.00 ft.)
	Surround right speaker distance ^{a)} ^{e)} [SR DIST]	SR 0.00 m to SR 7.00 m (SR 0.00 ft. to SR 23.00 ft.) (0.10 m (0.25 ft.) step)	SR 3.00 m (SR 10.00 ft.)
	Surround left speaker distance ^{a)} ^{e)} [SL DIST]	SL 0.00 m to SL 7.00 m (SL 0.00 ft. to SL 23.00 ft.) (0.10 m (0.25 ft.) step)	SL 3.00 m (SL 10.00 ft.)
	Subwoofer distance ^{a)} ^{e)} [SW DIST]	(SW 0.00 m to SW 7.00 m) (SW 0.00 ft. to SW 23.00 ft.) (0.10 m (0.25 ft.) step)	SW 3.00 m (SW 10.00 ft.)

Menu [Display]	Parameters [Display]	Settings	Initial setting
Level settings [LEVEL] (page 38)	Test tone ^{a)} [T. TONE]	T. TONE N, T. TONE Y	T. TONE N
	Front left speaker level ^{a)} [FL LVL]	FL -6 dB to FL +6 dB (0.5 dB step)	FL 0.0 dB
	Center speaker level [CNT LVL]	CNT -6 dB to CNT +6 dB (0.5 dB step)	CNT 0.0 dB
	Front right speaker level [FR LVL]	FR -6 dB to FR +6 dB (0.5 dB step)	FR 0.0 dB
	Surround right speaker level [SR LVL]	SR -6 dB to SR +6 dB (0.5 dB step)	SR 0.0 dB
	Surround left speaker level [SL LVL]	SL -6 dB to SL +6 dB (0.5 dB step)	SL 0.0 dB
	Subwoofer level [SW LVL]	SW -6 dB to SW +6 dB (0.5 dB step)	SW 0.0 dB
Tone settings [TONE] (page 38)	Bass level [BASS]	BASS -6 dB to BASS +6 dB (0.5 dB step)	BASS 0.0 dB
	Treble level [TREBLE]	TRE -6 dB to TRE +6 dB (0.5 dB step)	TRE 0.0 dB
Custom settings [CUSTOM] (page 39)	Digital broadcast language selection ^{a)} [DUAL]	MAIN, SUB, MAIN/SUB	MAIN
	Synchronizes audio with video output ^{d)} [A/V SYNC]	SYNC OFF, SYNC 1 to SYNC 20	SYNC OFF
	Audio Dynamics range compression ^{a)} [AUD. DRC]	DRC OFF, DRC STD, DRC MAX	DRC OFF
	Brightness of the display ^{a)} [DIMMER]	DIMMER Y, DIMMER N	DIMMER N
	Display ^{a)} [DISPLAY]	DSPL ON, DSPL OFF	DSPL ON
	Sleep timer ^{a)} [SLEEP]	SLP OFF, SLP 10M, SLP 20M.... SLP 90M	SLP OFF
Switching the audio input mode ^{a)f)} [IN MODE]	AUTO, OPT	AUTO	

Menu [Display]	Parameters [Display]	Settings	Initial setting
S-AIR settings [S-AIR] (page 40)	S-AIR ID ^{g)} [S-AIR ID]	ID A, ID B, ID C	ID A
	PAIRING ^{g)} [PAIRING]	START, CONDIN	START
	S-AIR mode ^{g)} [MODE]	PARTY, SEPARATE	PARTY
	RF Change ^{g)} [RF CHNG]	RF AUTO, RF ON, RF OFF	RF AUTO
	RF Power ^{g)h)} [RF POWER]	PWR HIGH, PWR LOW	PWR HIGH
	S-AIR standby ^{g)} [STBY]	STBY ON, STBY OFF	STBY OFF

- a) For details, refer to the page in the parentheses.
- b) “CONTROL FOR HDMI” scroll across the display, then “CONTROL” appears.
- c) The initial setting for the model of area code MX is “CTRL ON”.
- d) This parameter is only available after the when the result of the Auto Calibration is saved.
- e) When the Auto Calibration result is saved, you can adjust the setting in 0.01 meter (1 inch) increment.
- f) This parameter is only available when SAT input is selected.
- g) This parameter is only available if the S-AIR transmitter (not supplied) is inserted to the EZW-T100 slot on the receiver.
- h) This parameter is only available when using the EZW-T100A wireless transceiver (for model of area code UC only).

Settings for the HDMI (SET HDMI menu)

You can use the SET HDMI menu to make various adjustments for HDMI settings. Select “SET HDMI” in the amplifier menus. For details on adjusting the parameters, see “Navigating through menus” (page 32) and “Overview of the menus” (page 33).

SET HDMI menu parameters

■ CONTROL FOR HDMI (Control for HDMI)

Lets you turn the Control for HDMI function on or off. For details, see “Preparing for the “BRAVIA” Sync” (page 46).

■ VOL LIM (Volume limit)

Lets you set the volume limit of your receiver. For details, see “Using the Volume Limit function” (page 49).

■ P.SAVE (Power Save)

Lets you save the power consumption during power standby mode while Control for HDMI function is set to on.

For details, see “Using the Power Saving function (Power Save)” (page 50).

Settings for the Auto Calibration (A.CAL menu)

You can use the A.CAL menu to make settings for the Auto Calibration function to suit your preference.

Select “A.CAL” in the amplifier menus. For details on adjusting the parameters, see “Navigating through menus” (page 32) and “Overview of the menus” (page 33).

A.CAL menu parameters

■ START (Auto Calibration start)

Lets you start the Auto Calibration function. For details, see “Performing Auto Calibration” (page 24).

■ A.CAL CLR (Clear Auto Calibration result)

Lets you delete the Auto Calibration result. For details on the operation, see “Clearing the measurement result” (page 26).

Settings for the Speaker

(SP SETUP menu)

You can use the SP SETUP menu to set the distance of the speakers connected to this receiver.

Select “SP SETUP” in the amplifier menus. For details on adjusting the parameters, see “Navigating through menus” (page 32) and “Overview of the menus” (page 33).

SP SETUP menu parameters

■ CNT SP (Center speaker)

Lets you select the center speaker.

■ SUR SP (Surround speaker)

Lets you select the surround speakers.

■ FL DIST (Front left speaker distance)

■ FR DIST (Front right speaker distance)

Lets you set the distance from your listening position to the front speaker (A). If both front speakers are not placed an equal distance from your listening position, set the distance to the closest speaker.

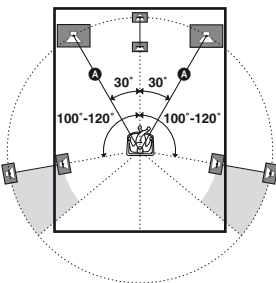

■ CNT DIST (Center speaker distance)

Lets you set the distance from your listening position to the center speaker.

■ SL DIST (Surround left speaker distance)

■ SR DIST (Surround right speaker distance)

Lets you set the distance from your listening position to the surround speakers.

■ SW DIST (Subwoofer distance)

Lets you set the distance from your listening position to the subwoofer.

Notes

- “CNT DIST” does not appear when you set “CNT N” in the “SP SETUP” setting.
- “SR DIST” and “SL DIST” do not appear when you set “SUR N” in the “SP SETUP” setting.

Tip

When the Auto Calibration result is saved, you can adjust the speakers distance in 1 cm steps. If the Auto Calibration result is not saved, you can adjust the speakers distance in 10 cm steps.

Adjusting the level

(LEVEL menu)

You can use the LEVEL menu to adjust the level of each speaker.

Select “LEVEL” in the amplifier menus. For details on adjusting the parameters, see “Navigating through menus” (page 32) and “Overview of the menus” (page 33).

LEVEL menu parameters

■ T. TONE (Test tone)

Lets you adjust the speaker levels while listening to the test tone from your listening position. For details, see “8: Adjusting the speaker levels (TEST TONE)” (page 27).

■ FL LVL (Front left speaker level)

■ CNT LVL (Center speaker level)

■ FR LVL (Front right speaker level)

■ SR LVL (Surround right speaker level)

■ SL LVL (Surround left speaker level)

■ SW LVL (Subwoofer level)

Notes

- “CNT LVL” does not appear when you set “CNT N” in the “SP SETUP” setting.
- “SR LVL” and “SL LVL” do not appear when you set “SUR N” in the “SP SETUP” setting.

Adjusting the tone

(TONE menu)

You can use the TONE menu to adjust the tonal quality (bass/treble level) of the speakers.

Select “TONE” in the amplifier menus. For details on adjusting the parameters, see “Navigating through menus” (page 32) and “Overview of the menus” (page 33).

TONE menu parameters

■ BASS (Bass level)

■ TREBLE (Treble level)

Settings for the Custom Menu

(CUSTOM menu)

You can use the CUSTOM menu to make settings for the audio to suit your preference. Select “CUSTOM” in the amplifier menus. For details on adjusting the parameters, see “Navigating through menus” (page 32) and “Overview of the menus” (page 33).

CUSTOM menu parameters

■ DUAL (Digital broadcast language selection)

Lets you select the language you want to listen to during digital broadcast. This feature only functions for Dolby Digital sources.

- MAIN (Main)
Sound of the main language will be output.
- SUB (Sub)
Sound of the sub language will be output.
- MAIN/SUB (Main/Sub)
Sound of the main language will be output through the front left speaker and sound of the sub language will be output through the front right speaker simultaneously.

■ A/V SYNC (Synchronizes audio with video output)

Lets you delay the audio output so that the time gap between the audio output and visual display is minimized. You can adjust from OFF, 1 (10 ms) to 20 (200 ms) in 1 (10 ms) steps.

Notes

- You may not be able to adjust the delay between sound and image perfectly using this function.
- This function is useful only for Dolby Digital, DTS and Linear PCM (2ch) input by optical and coaxial audio input signals.

■ AUD. DRC (Audio dynamic range compression)

Lets you compress the dynamic range of the sound track. This may be useful when you want to watch movies at low volumes late at night. Audio dynamic range compression is possible with Dolby Digital sources only.

- DRC OFF
The audio dynamic range is not compressed.
- DRC STD
The audio dynamic range is compressed as intended by the recording engineer.
- DRC MAX
The audio dynamic range is compressed dramatically.

Tip

Audio dynamic range compression lets you compress the dynamic range of the sound track based on the dynamic range information included in the Dolby Digital signal.

“DRC STD” is the standard setting, but it only enacts light compression. Therefore, we recommend using the “DRC MAX” setting. This greatly compresses the dynamic range and lets you view movies late at night at low volumes. Unlike analog limiters, the levels are predetermined and provide a very natural compression.

■ DIMMER (Brightness of the display)

Lets you adjust the brightness of the display. For details, see “Changing the brightness of the display (DIMMER)” (page 51).

■ DISPLAY (Display)

Lets you turn on and off the display. For details, see “Changing the display setting (DISPLAY)” (page 51).

■ SLEEP (Sleep timer)

Lets you set the timer to power off the receiver automatically. For details, see “Using the Sleep Timer (SLEEP)” (page 52).

■ IN MODE (Switching the audio input mode)

Lets you set the audio input mode of inputs. For details, see “Switching the audio input mode (IN MODE)” (page 52). This parameter is only available when SAT input is selected.

Settings for the S-AIR (S-AIR menu)

For details on S-AIR, see “Using an S-AIR Product” (page 53).

Selecting the sound field

This receiver can create multi channel surround sound. You can select one of the optimized sound fields from the receiver's preprogrammed sound fields.

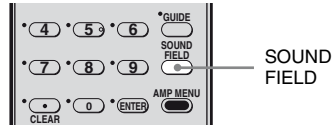

Press SOUND FIELD repeatedly to select the sound field you want.

For details, see “Types of sound field available” (page 41).

Types of sound field available

Sound field for	Sound field [Display]	Effect
A.F.D. mode	2CH STEREO [2CH ST]	When multi channel surround formats are input, the signals are downmixed to 2 channel.
	A.F.D. STANDARD [A.F.D. STD]	Presents the sound as it was recorded/encoded without adding any surround effects. However, this receiver will generate a low frequency signal for output to the subwoofer when there is no LFE signals.
	A.F.D. MULTI [A.F.D. MULT]	Reproduce sound from any of the format to 2 or more speakers.
	PRO LOGIC [DOLBY PL]	Performs Dolby Pro Logic decoding. The source recorded in 2 channel format is decoded into 4.1 channels.
	PRO LOGIC II MOVIE [PLII MV]	Performs Dolby Pro Logic II Movie mode decoding. This setting is ideal for movies encoded in Dolby Surround. In addition, this mode can reproduce sound in 5.1 channel for watching videos of overdubbed or old movies.
	PRO LOGIC II MUSIC [PLII MS]	Performs Dolby Pro Logic II Music mode decoding. This setting is ideal for normal stereo sources such as CDs.
Movie	MOVIE-D.C.S.- ^{a)} [MV-D.C.S.-]	The system reproduces the sound characteristics of the Sony Pictures Entertainment “Cary Grant Theater” cinema production studio. This is a standard mode, great for watching almost any type of movie.
Music	SPORTS [SPORTS]	Reproduces the feeling of sports broadcasting.
	NEWS [NEWS]	The systems provided the clearer sound for the voice program such as news.
	PORTABLE AUDIO ENHANCER [P. AUDIO]	Reproduces a clear enhanced sound image from your portable audio device. This mode is ideal for MP3 and other compressed music.
Others ^{b)}	HEADPHONE 2CH [HP 2CH]	Output the sound from headphone left and right. Multi channel surround formats are downmixed to 2 channels.
	HEADPHONE THEATER [HP THEA]	Output the sound as surround from headphone left and right.

^{a)}D.C.S. technology is used. For details, see “Glossary” (page 61).

^{b)}This decoding mode appears when you connect the headphones to surround amplifier (S-Air sub unit) (not supplied).

Notes

- The effects provided by the virtual speakers may cause increased noise in the playback signal.
- When listening with sound fields that employ the virtual speakers, you will not be able to hear any sound coming directly from the surround speakers.
- This function does not work when:
 - signals with a sampling frequency of more than 48 kHz is input.
 - the multi channel Linear PCM signals are received via an HDMI IN jack.
- The sound is not output from multiple speakers depending on the source.
- Depending on the disc or source, the beginning of the sound may be cut off as the optimum mode is automatically selected. To avoid cutting the sound, select “A.F.D. STD.”.
- When the input signal is multi channel source, Dolby Pro Logic II MOVIE/MUSIC are canceled and the multi channel source is output directly.
- When the bilingual broadcast sound is input, Dolby Pro Logic II MOVIE/MUSIC are not effective.
- Multi channel Linear PCM is not available for “P. AUDIO.”
- Depending on the input stream, the decoding mode may not be effective.
- When you select “MV-D.C.S.-” depending on the input stream, Dolby Pro Logic may be applied automatically.
- When changing the sound mode while using the S-AIR receiver (not supplied), sound from the S-AIR receiver (not supplied) may skip.

Tip

You can identify the encoding format of DVD software, etc., by looking at the logo on the package.

Tuner Operations

Listening to FM/AM radio

You can listen to FM and AM broadcasts through the built-in tuner. Before operation, make sure you have connected the FM and AM antennas to the receiver (page 21).

Tip

The tuning scale for direct tuning differs depending on the area code as shown in the following table. For details on area codes, see page 4.

Area code	FM	AM
UC	100 kHz	10 kHz*
MX	50 kHz	10 kHz*

* The AM tuning scale can be changed (page 44).

Tuning into a station automatically (Auto Tuning)

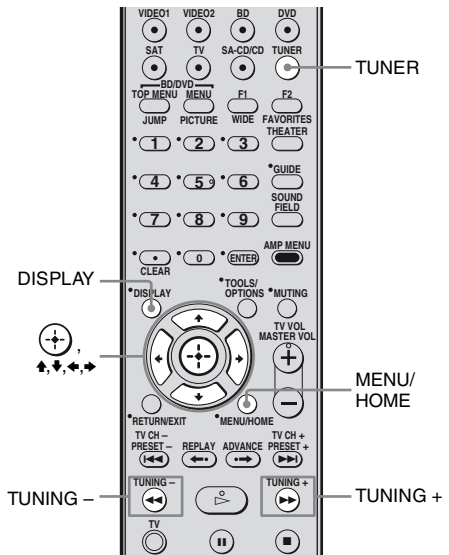

- 1 Press TUNER repeatedly to select the FM or AM band.**

You can also use INPUT SELECTOR on the receiver.

2 Press TUNING + or TUNING –.

Press TUNING + to scan from low to high; press TUNING – to scan from high to low.

The receiver stops scanning whenever a station is received.

To stop the automatic tuning manually, press TUNING + or –.

If an FM program is noisy

If an FM program is noisy, you can select monaural reception. There will be no stereo effect, but reception will improve.

1 Press MENU/HOME.

2 Press \uparrow/\downarrow repeatedly until “FM MODE” appears, then press \oplus or \rightarrow .

3 Press \uparrow/\downarrow repeatedly to select “MONO”.

- STEREO: stereo reception.
 - MONO: monaural reception.
- The default setting is STEREO.

4 Press \oplus .

5 Press MENU/HOME.

Tip

To improve reception, reorient the supplied antennas (aerials).

Presetting radio stations

You can preset up to 20 FM stations and 10 AM stations. Then you can easily tune in the stations you often listen to.

Presetting radio stations

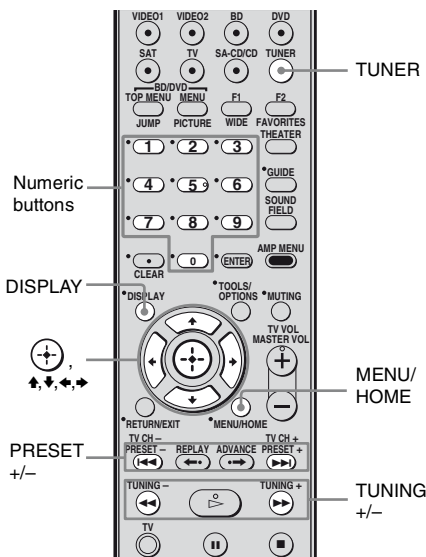

1 Press TUNER repeatedly to select the FM or AM band.

You can also use INPUT SELECTOR on the receiver.

2 Press and hold TUNING + or TUNING – until the auto scanning starts.

Scanning stops when the receiver tunes in a station. “ST” (for stereo program) light up in the display.

3 Press MENU/HOME.

4 Press \uparrow/\downarrow repeatedly until “MEMORY” appears in the display.

continued

5 Press **⊕** or **➔**.

A preset number appears in the display.

6 Press **▲/▼** repeatedly to select the preset number you want.

You can select the preset number directly by pressing the number buttons.

7 Press **⊕**.

“COMPLETE” appears in the display, and the station is stored.

8 Press **MENU/HOME**.

9 Repeat 2 to 8 to store other stations.

To change the preset number

Restart from step 3.

Changing the AM tuning interval

The AM tuning interval can be set to either 10 kHz or 9 kHz.

1 Press **TUNER/BAND** repeatedly until “AM” appears in the display.

2 Press **MENU/HOME**.

3 Press **▲/▼** repeatedly until “AM STEP” appears in the display, then press **⊕** or **➔**.

“9K STEP” or “10K STEP” appears in the display.

4 Press **⊕**.

“COMPLETE” appears in the display. The AM tuning interval is changed.

5 Press **MENU/HOME**.

Note

If you change the interval, AM preset stations will be erased.

Tuning to preset stations

1 Press **TUNER** repeatedly to select the FM or AM band.

2 Press **PRESET +** or **PRESET -** repeatedly to select the preset station you want.

Each time you press the button, the receiver tunes in one preset station.

You can also press the numeric buttons to select the preset station you want. Then, press **ENTER** to enter the selection.

Naming preset station

You can enter a name for preset stations.

These names (for example, “XYZ”) appear in the display when a station is selected.

Note that no more than one name can be entered for each preset station.

1 Press **TUNER** repeatedly to select the FM or AM band.

You can also use **INPUT SELECTOR** on the receiver.

2 Press **PRESET +** or **PRESET -** repeatedly to select the preset station you want to create an index name for.

3 Press **MENU/HOME**.

4 Press **▲/▼** repeatedly to select “NAME IN”.

5 Press **⊕**.

6 Create a name by using

▲/▼/◀/▶.

Press ▲/▼ repeatedly to select a character, then press ▶ to move the cursor to the next position. Letters, numbers and other symbols can be input for a radio station name.

If you enter a wrong character

Press ◀/▶ repeatedly until the character to be changed flashes, then press ▲/▼ repeatedly to select the desired character. To erase the character, press ◀/▶ repeatedly until the character to be erased flashes, then press CLEAR.

7 Press (⊕).

"COMPLETE" appears in the display and the station name is stored.

8 Press MENU/HOME.

Viewing the station name or frequency in the display

When the receiver is set to "FM" or "AM", you can check the frequency using the display.

Press DISPLAY.

Each time you press DISPLAY, the display changes as shown.

Station name^{a)} ↔ Frequency^{b)}

^{a)}This is displayed if you have entered a name for a preset station.

^{b)}Returns to the original display when several seconds have elapsed.

Using "BRAVIA" Sync features

What is "BRAVIA" Sync?

"BRAVIA" Sync is compatible with a Sony TV, Blu-ray Disc/DVD Player, AV amplifier, etc., that is equipped with the Control for HDMI function.

By connecting Sony components that are compatible with the "BRAVIA" Sync with an HDMI cable (not supplied), operation is simplified as follows:

- One-Touch Play: When you play back a component such as a DVD/Blu-ray disc player, the receiver and the TV are turned on automatically and switched to the appropriate HDMI input. Be sure that the System Audio Control setting is set to on.
- System Audio Control: While watching TV, you can select to output the sound from the TV speaker or the speakers connected to the receiver.
- System Power Off: When you turn off the TV, the receiver and connected components are also turned off simultaneously.

Control for HDMI is a mutual control function standard used by HDMI CEC (Consumer Electronics Control) for HDMI (High-Definition Multimedia Interface).

The Control for HDMI function does not work in the following cases:

- When you connect the receiver to a component which does not correspond with Sony's Control for HDMI function.
- When you connect the receiver and components using other than HDMI connection.

We recommend that you connect the receiver to products featuring "BRAVIA" Sync.

Note

Depending on the connected component, the Control for HDMI function may not work. Refer to the operating instructions of the component.

Preparing for the “BRAVIA” Sync

To use the “BRAVIA” Sync, set the Control for HDMI function to on for both the receiver and the connected component. The receiver is compatible with the “Control for HDMI-Easy Setting” function.

When your TV is compatible with the “Control for HDMI-Easy Setting” function

When you connect a Sony TV with the “Control for HDMI-Easy Setting” function, the Control for HDMI function of the receiver can be turned on simultaneously by turning the Control for HDMI function of the TV on.





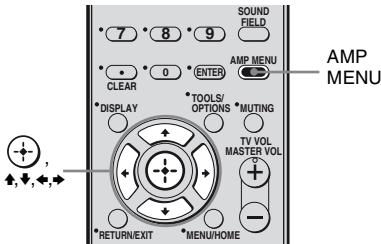

- 1** Make sure that the receiver, TV, and playback components are connected using an HDMI cable (not supplied). (The respective components must be compatible with the Control for HDMI function.)
- 2** Turn on the receiver, TV and playback components.
- 3** Turn the Control for HDMI function of the TV on.
The Control for HDMI function of this receiver and all the connected components are simultaneously turned on.
During setup, “SCANNING” appears in the display, and once setting is completed, “COMPLETE” will appear. Wait until the setup is complete.

For details on setting the TV, refer to the operating instructions supplied with the TV.

When your TV is not compatible with the "Control for HDMI-Easy Setting" function

Turn the Control for HDMI function of the receiver and the connected component on individually.



- 1 Perform the steps given in "When your TV is compatible with the "Control for HDMI-Easy Setting" function" (page 46).
- 2 Press AMP MENU.
"SET HDMI" appears on the display.
- 3 Press  or  to enter the menu.
- 4 Press  repeatedly to select "CONTROL FOR HDMI".
"CONTROL FOR HDMI" scrolls across the display, then "CONTROL" appears.
- 5 Press  or  to enter the parameter.
- 6 Press  repeatedly to select "CTRL ON".
Control for HDMI function is activated.
- 7 Set the Control for HDMI function of the connected component to on.
- 8 Select the HDMI input (BD, DVD, SAT) of the receiver and TV to match the HDMI output of the connected component, so that the image from the connected component is displayed.
For details on setting the TV and connected components, refer to the operating instructions of the respective components.

Notes

- You cannot perform One-Touch Play and System Audio Control during Control for HDMI-Easy Setting operation.
- Before you do the Control for HDMI-Easy Setting from the TV, be sure to turn on the TV, connected components and receiver.
- When you unplug the HDMI cable or change the connection, perform the steps given in "When your TV is compatible with the "Control for HDMI-Easy Setting" function" (page 46) or "When your TV is not compatible with the "Control for HDMI-Easy Setting" function" (page 47).
- If the playback components cannot function after you have made the settings for Control for HDMI-Easy Setting, check the Control for HDMI setting on your TV.
- If the connected components do not support the Control for HDMI-Easy Setting, you need to set the Control for HDMI function for the connected components to on before you perform the Control for HDMI-Easy Setting from the TV.

Playing back components with one-touch operation (One-Touch Play)

You can enjoy sound and image from the components connected to the receiver via HDMI connections by a simple operation.

Play back a connected component.

The receiver and the TV are turned on automatically and switched to the appropriate HDMI input.

Note

Be sure that the System Audio Control setting is set to on.

Watching a DVD/Blu-ray disc by simple operation

You can also select a connected component, such as a DVD/Blu-ray disc player using the TV menu. In this case, the receiver and the TV switch to the appropriate HDMI input.

Note

Depending on the TV, the start of the content may not be output.

Tip

You can enjoy the components that are connected to the HDMI jacks, even if you turn the receiver off. The ACTIVE STANDBY indicator lights up in amber.

Enjoying the TV sound from the speakers connected to the receiver (System Audio Control)

You can enjoy the TV sound from the speakers connected to the receiver by a simple operation.

You can operate System Audio Control function using the TV menu. For details, refer to the operating instructions supplied with the TV.

When System Audio Control function is turned on, the receiver will turn on and switches to the appropriate input automatically.

TV sound is output from the speakers connected to the receiver, and the volume of the TV is minimized simultaneously.

You can use the System Audio Control function as follows.

- If you turn on the receiver while the TV is turned on, the System Audio Control function will automatically be set to on and the TV sound will output from the speakers connected to the receiver. However, if you turn off the receiver, the sound will output from the TV speakers.
- You can adjust the receiver's volume when you adjust the TV volume.

Notes

- If System Audio Control does not function according to your TV setting, refer to the operating instructions supplied with the TV.
- When you connect a TV that does not have System Audio Control function, the System Audio Control function does not work.
- If the TV is turned on before turning on the receiver, the TV sound will not be output for a moment.

Using the Volume Limit function

When the System Audio Control function is active, and the output method changes from the TV speaker to the speakers connected to the receiver automatically, loud sound may be output depending on the volume level of the receiver. You can prevent this by limiting the maximum volume level.

- 1 Press AMP MENU.**
- 2 Press \downarrow/\uparrow repeatedly until “SET HDMI” appears, then press \odot or \rightarrow .**
- 3 Press \downarrow/\uparrow repeatedly until “VOL LIM” appears, then press \odot or \rightarrow .**
- 4 Press \downarrow/\uparrow to select the maximum volume level you want.**

The maximum volume level changes as follows:

MAX \leftrightarrow 39 \leftrightarrow 38 \leftrightarrow \leftrightarrow 2 \leftrightarrow 1 \leftrightarrow MIN

- 5 Press AMP MENU.**

The AMP MENU turns off.

Notes

- This function is available only when the Control for HDMI function is set to on.
- This function is not available when the output method changes from the speakers connected to the receiver to the TV speaker.

Tips

- Sony recommends that you set the maximum volume level to a little lower than the volume you usually listen to.
- Regardless of the maximum volume level you set, the MASTER VOLUME on the receiver and the MASTER VOL +/- button of the remote are operable.
- If you do not want to limit the maximum volume level, select “MAX.”

Turning off the receiver with the TV (System Power Off)

When you turn the TV off by using the POWER button on the TV’s remote, the receiver and the connected components turn off automatically. You can also use the receiver’s remote to turn off the TV.

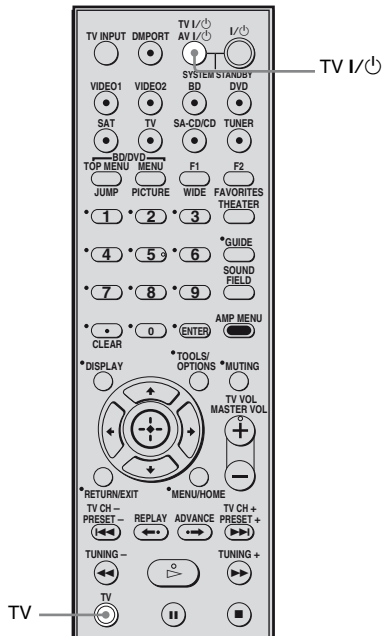

Press TV and TV I/O at the same time.

The TV, receiver and the components connected via HDMI are turned off.

Notes

- Set the TV Standby Synchro to “ON” before using the System Power Off function. For details, refer to the operating instructions supplied with the TV.
- Depending on the status, the connected components may not be turned off. For details, refer to the operating instructions supplied with the connected components.

Using the Power Saving function

(Power Save)

You can reduce the receiver's power consumption when you connect a "BRAVIA" Sync-compatible TV to this receiver during active standby mode if the TV is turned off and HDMI signal transmission is stopped.

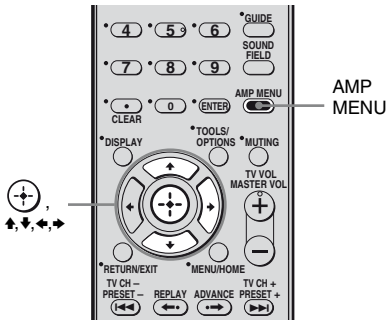

Notes

- The power saving function may not work for some TVs compatible with the "BRAVIA" Sync. In this case, set "P.SAVE" to "SAVE OFF."
- Depending on your components, it may take time before image or sound is output.
- This function is available only when the Control for HDMI function is set to on.

1 Press AMP MENU.

"SET HDMI" appears on the display.

2 Press or to enter the menu.

3 Press repeatedly to select "P.SAVE", then press or .

4 Press repeatedly to select the setting, then press or .

- SAVE ON: Reduces power consumption in standby mode. HDMI signal transmission occurs only when the TV is on.
- SAVE OFF: No reduction. HDMI signal transmission occurs continuously.

5 Press AMP MENU.

The AMP MENU turns off.

Changing the brightness of the display (DIMMER)

You can change the brightness of the display.

- 1 Press AMP MENU.**
“SET HDMI” appears on the display.
- 2 Press \uparrow/\downarrow repeatedly until “CUSTOM” appears, then press \oplus or \rightarrow .**
- 3 Press \uparrow/\downarrow repeatedly until “DIMMER” appears, then press \oplus or \rightarrow .**
- 4 Press \uparrow/\downarrow repeatedly to select the brightness of the display, then press \oplus .**
 - DIMMER Y: Low lighting.
 - DIMMER N: Bright lighting.
- 5 Press AMP MENU.**
The AMP menu turns off.

Changing the display setting (DISPLAY)

You can change the display setting.

- 1 Press AMP MENU.**
“SET HDMI” appears on the display.
- 2 Press \uparrow/\downarrow repeatedly until “CUSTOM” appears, then press \oplus or \rightarrow .**
- 3 Press \uparrow/\downarrow repeatedly until “DISPLAY” appears, then press \oplus or \rightarrow .**
- 4 Press \uparrow/\downarrow repeatedly to change the display setting, then press \oplus .**
 - DSPL ON: The display appears all the time.
 - DSPL OFF: The display appears when you operate the receiver.
- 5 Press AMP MENU.**
The AMP menu turns off.

Using the Sleep Timer (SLEEP)

You can set the receiver to turn off at a preset time when you sleep while listening to music. You can preset the time in 10 minutes decrements.

1 Press AMP MENU.

“SET HDMI” appears on the display.

2 Press \uparrow/\downarrow repeatedly until “CUSTOM” appears, then press

\oplus or \rightarrow .

3 Press \uparrow/\downarrow repeatedly until “SLEEP” appears, then press

\oplus or \rightarrow .

4 Press \uparrow/\downarrow repeatedly to select the preset time.

The minutes display (the remaining time) changes as follows:

SLP OFF \leftrightarrow SLP 10M \leftrightarrow SLP 20M
 \updownarrow \updownarrow
SLP 90M \leftrightarrow SLP 80M SLP 30M

5 Press \oplus .

6 Press AMP MENU.

The AMP menu turns off.

Switching the audio input mode

(IN MODE)

You can select the audio input mode setting when you connect satellite tuner or set-top box to both HDMI IN jack and optical digital input jack on the receiver and SAT input has been selected.

1 Press AMP MENU.

“SET HDMI” appears on the display.

2 Press \uparrow/\downarrow repeatedly to select “CUSTOM”.

3 Press \oplus or \rightarrow to enter the menu.

4 Press \uparrow/\downarrow repeatedly to select “IN MODE”.

5 Press \oplus or \rightarrow to enter the parameter.

6 Press \uparrow/\downarrow repeatedly to select the audio input mode you want.

7 Press AMP MENU.

The AMP menu turns off.

Audio input modes

■ AUTO

Gives priority to HDMI audio signals if there are both digital (HDMI and optical) connections.

■ OPT

Specifies the digital audio signals input to the DIGITAL SAT OPT IN jack.

Using an S-AIR Product

The unit is compatible with the S-AIR function (page 62), which allows wireless sound transmission between S-AIR products. When you purchase the S-AIR product, you need to perform the following settings to establish the sound transmission.

About S-AIR products

There are two types of S-AIR product.

- S-AIR main unit (this receiver):
The S-AIR main unit is for transmitting sound.
You can use up to 3 S-AIR main units. (The number of usable S-AIR main unit depends on the use environment.)
- S-AIR sub unit (not supplied): The S-AIR sub unit is for receiving sound.
 - Surround amplifier: You can enjoy surround speaker sound wirelessly.
 - S-AIR receiver: You can enjoy system sound in another room.

These S-AIR products can be purchased as an option (the S-AIR products lineup differs depending on the area).

Notes or instruction from the surround amplifier or S-AIR receiver in this operating instructions is refer only when the surround amplifier or S-AIR receiver is used.

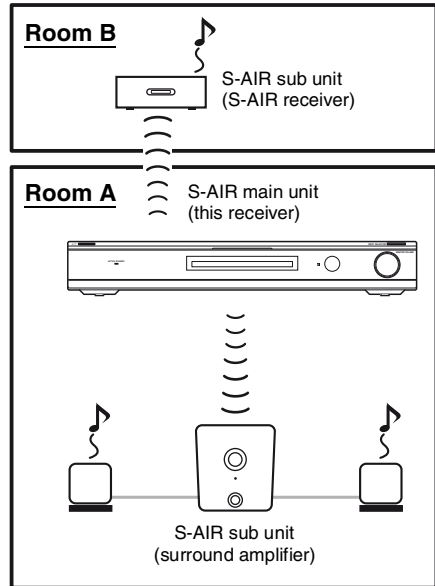

Inserting the wireless transmitter/transceiver

To make use of the S-AIR function, you need to insert the wireless transmitter (not supplied) into the S-AIR main unit and the wireless transceiver (not supplied) into the S-AIR sub unit.

Notes

- Before inserting the wireless transmitter/transceiver, be sure to disconnect the AC power cord (mains lead).
- Do not touch the terminals of the wireless transmitter/transceiver.

To insert the wireless transmitter into the S-AIR main unit

- 1 Remove the screws and detach the slot cover.

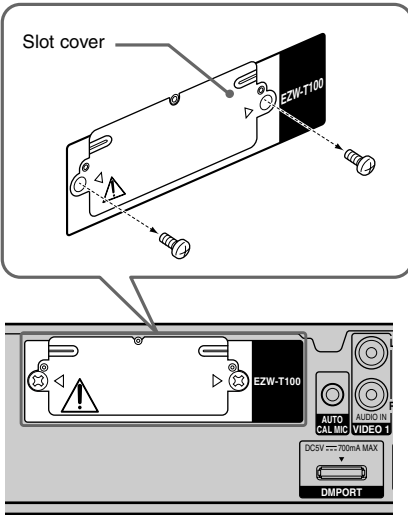

Notes

- Remove the screws from the slot cover bearing the caution mark. Do not remove other screws.
- The slot cover is no longer necessary. However, keep it after detaching.

- 2 Insert the wireless transmitter.

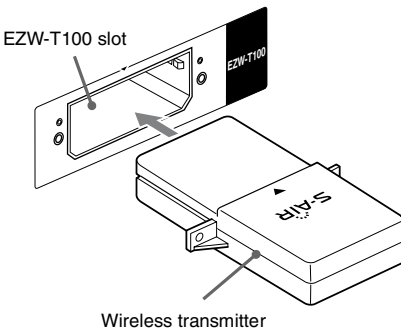

Notes

- Insert the wireless transmitter with the S-AIR logo facing up.
- Insert the wireless transmitter so that the ▼ marks are aligned.
- Insert the wireless transmitter EZW-T100 only into the wireless transceiver slot.

- 3 Use the screws that you removed from step 1 to secure the wireless transmitter.

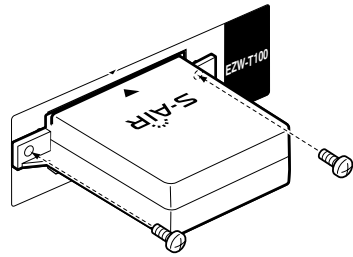

Note

Do not use other screws to fasten the wireless transmitter.

To insert the wireless transceiver into the S-AIR sub unit

For details on installing the wireless transceiver into the surround amplifier and S-AIR receiver, refer to the operating instructions supplied with the surround amplifier and S-AIR receiver.

Establishing sound transmission between the S-AIR main unit and S-AIR sub unit (ID setting)

When you match the ID of the S-AIR main unit and the S-AIR sub unit, you can establish sound transmission. You can use multiple S-AIR products by setting a different ID for each unit.

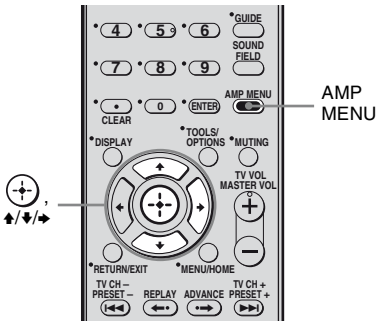

To set the ID of the S-AIR sub unit

For details on setting the ID of the surround amplifier and S-AIR receiver, refer to operating instructions supplied with the surround amplifier and S-AIR receiver.

Sound transmission is established as follows (example):

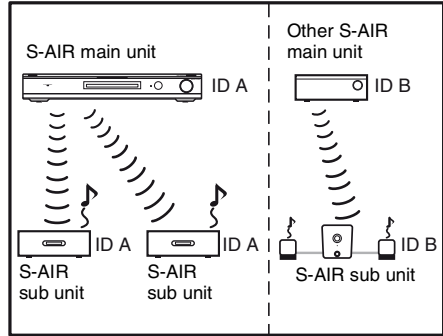

To set the ID of the S-AIR main unit

- 1 Press AMP MENU.
- 2 Press \uparrow/\downarrow repeatedly to select "S-AIR".
- 3 Press \oplus or \rightarrow to enter the menu.
- 4 Press \uparrow/\downarrow repeatedly to select "S-AIR ID".
- 5 Press \oplus or \rightarrow to enter the parameter.
- 6 Press \uparrow/\downarrow repeatedly to select the desired ID (A, B or C) then press \oplus .

To exit the menu

Press AMP MENU.

Pairing the S-AIR main unit with a specific S-AIR sub unit (Pairing operation)

To establish sound transmission, you need to set the same ID for your S-AIR main unit and S-AIR sub unit. However, if your neighbors have S-AIR products and their IDs are the same as yours, your neighbors could receive the sound of your S-AIR main unit or vice versa.

To prevent this, you can pair the S-AIR main unit with a specific S-AIR sub unit by performing the pairing operation.

■ Before pairing

Sound transmission is established by the ID (example).

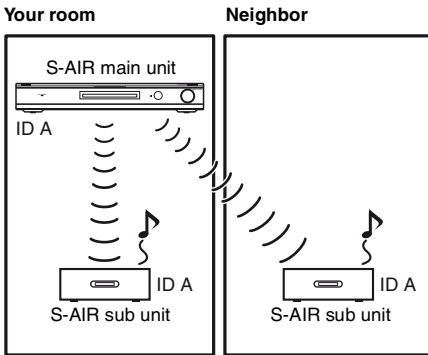

■ After pairing

Sound transmission is established between the paired S-AIR main unit and S-AIR sub unit(s) only.

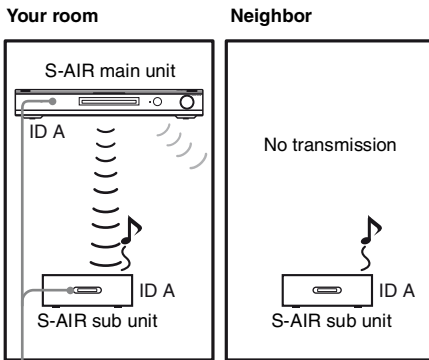

Pairing

1 Place the S-AIR sub unit that you want to pair near the S-AIR main unit.

Note

Remove headphones from the surround amplifier (if connected).

2 Match the IDs of the S-AIR main unit and the S-AIR sub unit.

- To set the ID of the S-AIR main unit, see “To set the ID of the S-AIR main unit” (page 55).
- To set the ID of the S-AIR sub unit, refer to the operating instructions supplied with the S-AIR sub unit.

3 Press AMP MENU.

4 Press \uparrow/\downarrow repeatedly to select “S-AIR”.

5 Press \oplus or \rightarrow to enter the menu.

6 Press \uparrow/\downarrow repeatedly to select “PAIRING”.

7 Press \ominus or \rightarrow to enter the parameter.

8 Press \uparrow/\downarrow repeatedly to select the setting you want, then press \oplus .

- START: The S-AIR main unit starts pairing.
- CONDIN: you can check the current ID. When the pairing setting is timed out, “NO PAIR” appears in the display.

9 Start pairing of the S-AIR sub unit.

■ For the surround amplifier

Refer to the operating instructions supplied with the surround amplifier.

■ For the S-AIR receiver

Refer to the operating instructions supplied with the S-AIR receiver.

10 Pairing completed.

“COMPLETE” appears in the display.

To exit the menu

Press AMP MENU.

Note

Perform the pairing within several minutes after step 8. If you do not, the pairing is canceled automatically and the “INCOMP” display appears.

To cancel pairing

Reset the ID of the S-AIR main unit. For details, see “To set the ID of the S-AIR main unit” (page 55). You can set the same ID as before.

Enjoying the system’s sound in another room

(For the S-AIR receiver only (not supplied))

You can enjoy the system’s sound in another room by using the S-AIR receiver. The S-AIR receiver can be placed in another room for enjoying the system’s sound there.

For details of the S-AIR receiver, refer to the operating instructions supplied with the S-AIR receiver.

Note

Sources with copyright protection may not be playable on S-AIR products.

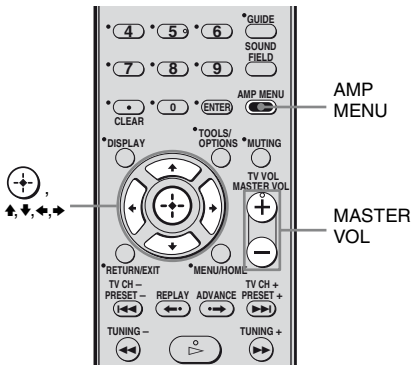

1 Set the ID of the S-AIR receiver to match the S-AIR main unit.

- To set the ID of the S-AIR main unit, see “To set the ID of the S-AIR main unit” (page 55).
- To set the ID of the S-AIR receiver, refer to the operating instructions supplied with the S-AIR receiver.

Notes

- When you are using another S-AIR sub unit, such as a surround amplifier, do not change the ID of the S-AIR main unit. Set the ID of the S-AIR receiver to match the ID of the S-AIR main unit.
- When you pair the S-AIR main unit and another S-AIR sub unit, such as a surround amplifier, you also need to pair between the S-AIR main unit and the S-AIR receiver. For details, see “Pairing the S-AIR main unit with a specific S-AIR sub unit (Pairing operation)” (page 55).

2 Press AMP MENU.

3 Press \uparrow/\downarrow repeatedly to select “S-AIR”.

4 Press \oplus or \rightarrow to enter the menu.

5 Press \uparrow/\downarrow repeatedly to select “MODE”.

6 Press \oplus or \rightarrow to enter the parameter.

7 Press \uparrow/\downarrow repeatedly to select the setting you want.

- **PARTY**: The S-AIR sub unit outputs sound according to function set on the S-AIR main unit.
- **SEPARATE**: You can select the input you want for the S-AIR receiver while the input of the S-AIR main unit remain unchanged.

When “SEPARATE” is set, the functions you can select are “MAIN UNIT”, “SA-CD/CD”, “TUNER FM”, “TUNER AM” and “DMPORT”. To enjoy the same function as the S-AIR main unit, select “MAIN UNIT”.

8 Select the desired function on the S-AIR product.

When the sound is other than 2 channel stereo, multi channel sound is down mixed to 2 channel.

9 Adjust the volume on the S-AIR receiver.

Notes

- When the sound is other than 2 channel stereo, multi channel sound is downmixed to 2 channel.
- When “TUNER FM” or “TUNER AM” is selected on the receiver, you can only select the same band for the tuner on the S-AIR product.

Changing the channel for better sound transmission

If you use multiple wireless systems which sharing the 2.4 GHz band, such as wireless LAN or Bluetooth, the transmission of S-AIR products or other wireless systems may be unstable. In this case, the transmission may be improved by changing the following “RF CHNG” setting.

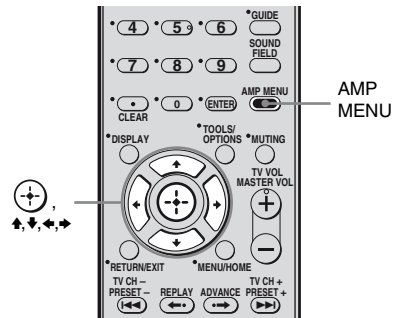

- 1 Press **AMP MENU**.
- 2 Press \uparrow/\downarrow repeatedly to select “S-AIR”.
- 3 Press \oplus or \rightarrow to enter the menu.
- 4 Press \uparrow/\downarrow repeatedly to select “RF CHNG”.
- 5 Press \oplus or \rightarrow to enter the parameter.
- 6 Press \uparrow/\downarrow repeatedly to select the setting you want, then press \oplus .

- **RF AUTO**: Normally select this. The system change “RF CHNG” to “RF ON” or “RF OFF” automatically.
- **RF ON**: The system transmits sound by searching the better channel for transmitting.
- **RF OFF**: The system transmits sound by fixing the channel for transmitting.

To exit the menu

Press AMP MENU.

Notes

- When the wireless transmitter is not inserted in the S-AIR main unit, you cannot set “RF CHNG”.
- In most cases, you will not need to change this setting.
- If “RF CHNG” is set to “RF OFF,” transmission between the S-AIR main unit and S-AIR sub unit can be performed using one of the following channels.
 - S-AIR ID A: equivalent channel for IEEE 802.11b/g channel 1
 - S-AIR ID B: equivalent channel for IEEE 802.11b/g channel 6
 - S-AIR ID C: equivalent channel for IEEE 802.11b/g channel 11
- The transmission may be improved by changing the transmission channel (frequency) of the other wireless system(s). For details, refer to the operating instructions of the other wireless system(s).

Changing the RF output power

(For EZW-T100A wireless transceiver only)

- 1 Press AMP MENU.**
- 2 Press \uparrow/\downarrow repeatedly to select “S-AIR”.**
- 3 Press \oplus or \rightarrow to enter the menu.**
- 4 Press \uparrow/\downarrow repeatedly until “RF POWER” appears in the front panel display, then press \oplus or \rightarrow .**
- 5 Press \uparrow/\downarrow repeatedly to select the desired setting.**
 - “HIGH”: Normally select this.
 - “LOW”: The RF output power is decreased.
- 6 Press \oplus .**

The setting is made.

7 Press AMP MENU.

The receiver menu turns off.

Enjoying the S-AIR receiver while the S-AIR main unit is in standby mode

(For the S-AIR receiver only (not supplied))

You can enjoy the S-AIR receiver while the S-AIR main unit is in standby mode by setting “STBY” to “STBY ON”.

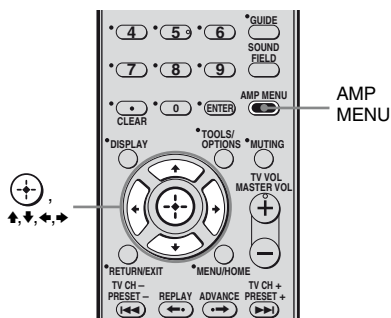

- 1 Press AMP MENU.**
- 2 Press \uparrow/\downarrow repeatedly to select “S-AIR”.**
- 3 Press \oplus or \rightarrow to enter the menu.**
- 4 Press \uparrow/\downarrow repeatedly to select “STBY”.**
- 5 Press \oplus or \rightarrow to enter the parameter.**
- 6 Press \uparrow/\downarrow repeatedly to select the setting you want, then press \oplus .**
 - STBY OFF: You cannot enjoy the S-AIR receiver while the S-AIR main unit is in standby mode.
 - STBY ON: You can enjoy the S-AIR receiver while the S-AIR main unit is in standby mode or turned on.

continued

To exit the menu

Press AMP MENU.

Notes

- When you set “STBY” to “STBY ON”, the power consumption during the standby mode increases.
- When the wireless transmitter is not inserted in the S-AIR main unit, you cannot set “STBY”.
- “STBY” is set to “STBY OFF” automatically when the wireless transmitter is removed from the S-AIR main unit.
- When you turn the system off while “STBY” is set to “STBY ON”, you cannot use any buttons other than I/⏻ button.
- The sound of the S-AIR sub unit may be cut off when the S-AIR main unit is operated.

Using the Remote

Changing the input button assignments

You can change the factory settings of the input buttons to suit the components in your system.

For example, if you connect a Blu-ray Disc player to the DVD jack on the receiver, you can set the DVD button on this remote to control the Blu-ray Disc player.

Notes

- You can change the remote assignments for BD, DVD and SAT input buttons.
- When the receiver is in VIDEO1, VIDEO2 or SA-CD/CD MENU, you cannot operate the selected component.

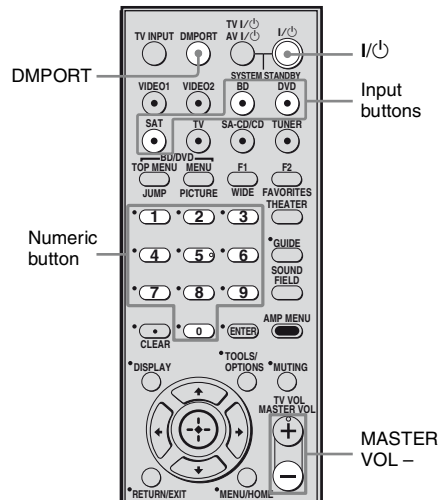

- 1 Hold down the input button of which you want to change the assignment.**

Example: Hold down DVD.

2 Referring to the following table, press the corresponding button for the category you want.

Example: Press 3.

Now you can use the DVD button to control the Blu-ray Disc player.

Categories and the corresponding buttons for BD, DVD, and SAT

Categories	Press
DVD player (command mode DVD1) ^{a)}	1
DVD recorder (command mode DVD3)	2
Blu-ray disc player (command mode BD1) ^{b)}	3
Blu-ray disc recorder (command mode BD3)	4
DVR (Digital CATV terminal)	7
DSS (Digital Satellite Receiver) ^{c)}	8

^{a)}The default setting of the DVD button.

Sony DVD recorders are operated with a DVD1 or DVD3 setting. For details, refer to the operating instructions of the DVD recorders.

^{b)}The default setting of the BD button.

For details on the BD1 or BD3 setting, refer to the operating instructions of the Blu-ray Disc player or Blu-ray Disc recorder.

^{c)}The default setting of the SAT button.

To clear all remote button assignments

Press MASTER VOL -, I/⏻ and DMPORT at the same time.

The remote is reset to its factory settings.

Additional Information

Glossary

■ Digital Cinema Sound (DCS)

A unique sound reproduction technology for home theater developed by Sony, in cooperation with Sony Pictures Entertainment, for enjoying the exciting and powerful sound of movie theaters at home. With this "Digital Cinema Sound" developed by integrating a DSP (Digital Signal Processor) and measured data, the ideal sound field intended by filmmakers can be experienced at home.

■ Dolby Digital

Digital audio encoding/decoding technology developed by Dolby Laboratories, Inc. It consists of front (Left/Right), center, surround (Left/Right) and subwoofer channels. It is a designated audio standard for DVD-video and also known as 5.1 channel surround. Since surround information is recorded and reproduced in stereo, more realistic sound with fuller presence is delivered than with Dolby surround.

■ Dolby Pro Logic II

This technology converts 2 channel stereo recorded audio into 5.1 channel for playback. There is a MOVIE mode for movies and MUSIC mode for stereo sources such as music. Old movies encoded in the traditional stereo format can be enhanced with 5.1 channel surround sound.

■ Dolby Surround (Dolby Pro Logic)

Audio processing technology developed by Dolby Laboratories, Inc. Center and mono surround information is matrixed into two stereo channels. When reproduced, audio is decoded and output in 4 channel surround sound. This is the most common audio processing method for DVD-video.

■ DTS Digital Surround

Digital audio encoding/decoding technology for theaters developed by DTS, Inc. It compresses audio less than Dolby Digital, delivering a higher quality sound reproduction.

■ HDMI (High-Definition Multimedia Interface)

HDMI (High-Definition Multimedia Interface) is an interface that supports both video and audio on a single digital connection, allowing you to enjoy high quality digital picture and sound. The HDMI specification supports HDCP (High-bandwidth Digital Contents Protection), a copy protection technology that incorporates coding technology for digital video signals.

■ L.F.E. (Low Frequency Effects)

Sound effects of low frequencies which are output from a subwoofer in Dolby Digital or DTS, etc. By adding a deep bass with a frequency between 20 to 120 Hz, audio becomes more powerful.

■ S-AIR (Sony Audio Interactive Radio frequency)

Recent times have seen the rapid spread of DVD media, Digital Broadcasting, and other high-quality media.

To ensure that the subtle nuances of these high-quality media are transmitted with no deterioration, Sony has developed a technology called “S-AIR” for the radio transmission of digital audio signals with no compression, and has incorporated this technology into the EZW-T100.

This technology transfers digital audio signals with no compression using the 2.4 GHz band range of ISM band (Industrial, Scientific, and Medical band), such as wireless LANs and Bluetooth applications.

■ S-master

S-master is an all-digital amplifier technology developed by Sony, which effectively minimizes the occurrence of sound fragmentation and jitter, delivering superb dialog clarity and faithful reproduction of the original sound. The compact amplifier section supports a higher power efficiency and improved thermal performance.

■ Sampling frequency

To convert analog audio to digital, analog data should be quantified. This process is called sampling, and the number of times per second the analog data is quantified is called the sampling frequency. A standard music CD stores data quantified at 44,100 times per second, which is expressed as a sampling frequency of 44.1 kHz. Generally speaking, a higher sampling frequency means better sound quality.

■ TSP (Time Stretched Pulse)

A TSP signal is a highly precise measuring signal that utilizes impulse energy, measuring a wide band, from low to high, in a short period.

The amount of energy used to measure signals is important to ensure measurement accuracy in a normal indoor environment. Using TSP signals makes it possible to measure signals effectively.

■ x.v.Color

x.v.Color is a more familiar term for the xvYCC standard proposed by Sony, and is a trademark of Sony. xvYCC is an international standard for colour space in video.

This standard can express a wider colour range than the currently used broadcast standard.

Precautions

On safety

Should any solid object or liquid fall into the cabinet, unplug the receiver and have it checked by qualified personnel before operating it any further.

On power sources

- Before operating the receiver, check that the operating voltage is identical with your local power supply.

The operating voltage is indicated on the nameplate on the back of the receiver.

- The unit is not disconnected from the AC power source (mains) as long as it is connected to the wall outlet, even if the unit itself has been turned off.
- If you are not going to use the receiver for a long time, be sure to disconnect the receiver from the wall outlet. To disconnect the AC power cord, grasp the plug itself; never pull the cord.
- (Models of area code U, UC, CA only)
One blade of the plug is wider than the other for the purpose of safety and will fit into the wall outlet only one way. If you are unable to insert the plug fully into the outlet, contact your dealer.
- The AC power cord must be changed only at a qualified service shop.

On heat buildup

Although the receiver heats up during operation, this is not a malfunction. If you continuously use this receiver at a large volume, the cabinet temperature of the top, side and bottom rises considerably. To avoid burning yourself, do not touch the cabinet.

On placement

- Place the receiver in a location with adequate ventilation to prevent heat buildup and prolong the life of the receiver.
- Do not place the receiver near heat sources, or in a place subject to direct sunlight, excessive dust, or mechanical shock.
- Do not place anything on top of the cabinet that might block the ventilation holes and cause malfunctions.
- Do not place the receiver near equipment such as a TV, VCR, or tape deck. If the receiver is being used in combination with a TV, VCR, or tape deck, and is placed too close to that equipment, noise may result, and picture quality may suffer. This is especially likely when using an indoor antenna. Therefore, we recommend using an outdoor antenna.
- Use caution when placing the receiver or speakers on surfaces that have been specially treated (with wax, oil, polish, etc.) as staining or discoloration of the surface may result.

On operation

Before connecting other components, be sure to turn off and unplug the receiver.

If you encounter color irregularity on a nearby TV screen

The center speaker is magnetically shielded to allow it to be installed near a TV set. However, color irregularities may still be observed on certain types of TV sets. As the front, surround speakers and subwoofer are not magnetically shielded, we recommend that you place the surround speakers and subwoofer slightly further away from TV set (page 13).

If color irregularity is observed...

Turn off the TV set, then turn it on again after 15 to 30 minutes.

If color irregularity is observed again...

Place the speaker further away from the TV set.

If howling occurs

Reposition the speakers or turn down the volume on the receiver.

On cleaning

Clean the cabinet, panel, and controls with a soft cloth slightly moistened with a mild detergent solution. Do not use any type of abrasive pad, scouring powder, or solvent, such as alcohol or benzine.

If you have any questions or problems concerning your receiver, please consult your nearest Sony dealer.

Troubleshooting

If you experience any of the following difficulties while using the receiver, use this troubleshooting guide to help you remedy the problem.

Audio

There is no sound, no matter which component is selected, or only a very low-level sound is heard.

- Check that the speakers and components are connected securely.
- Check that both the receiver and all components are turned on.
- Check that MASTER VOLUME is not set to "VOL MIN".
- Press MUTING to cancel the muting function.
- Check that you have selected the correct component with the input buttons.
- The protective device on the receiver has been activated. Turn off the receiver, eliminate the short-circuit problem, and turn on the power again.
- Check that the IN MODE setting is correct for SAT input.

There is no sound from a specific component.

- Check that the component is connected correctly to the audio input jacks for that component.
- Check that the cord(s) used for the connection is (are) fully inserted into the jacks on both the receiver and the component.

There is no sound from one of the front speakers.

- Make sure you have connected to both the L and R jacks of an analog component, and not only to either the L or R jack. Use an audio cord (not supplied).

There is no sound from digital sources (from OPTICAL input jack).

- Check that the IN MODE is set to "AUTO" for SAT input.

There is severe hum or noise.

- Check that the speakers and components are connected securely.
- Check that the connecting cords are away from a transformer or motor, and at least 10 feet away from a TV set or fluorescent light.
- Move your audio components away from the TV.
- The plugs and jacks are dirty. Wipe them with a cloth slightly moistened with alcohol.

There is pop noise from a specific component connected to this receiver when you turn on the component.

- Check that the IN MODE is set to "AUTO" for SAT input (page 52).

There is no sound, or only a very low-level sound is heard from the center/surround speakers.

- Select a MOVIE-D.C.S.- mode (page 41).
- Adjust the speaker level (page 27).
- Check that the speakers are connected securely.

There is no sound from the subwoofer.

- Check that the subwoofer is connected correctly and securely.

The surround effect cannot be obtained.

- Make sure the sound field function is on (press SOUND FIELD).
- Sound fields do not function for signals with a sampling frequency of more than 48 kHz.

Dolby Digital or DTS multi channel sound is not reproduced.

- Check that the DVD, etc. you are playing is recorded in Dolby Digital or DTS format.
- When connecting the DVD player, etc., to the digital input jacks of this receiver, check the audio setting (the settings for the audio output) of the connected component.

There is no sound from the component connected to the DIGITAL MEDIA PORT adapter.

- Adjust the volume of this receiver.
- The DIGITAL MEDIA PORT adapter and/or component is not connected correctly. Turn off the receiver, then reconnect the DIGITAL MEDIA PORT adapter and/or component.
- Check the DIGITAL MEDIA PORT adapter and/or component device to make sure it supports this receiver.

Video

There is no picture or an unclear picture appears on the TV screen or monitor.

- Make sure you have connected the video output of your video component to the TV.
- Move your audio components away from the TV.
- Depending on the DIGITAL MEDIA PORT adapter, video output may not be possible.

HDMI

The volume turns down when the output method changes from the TV speaker to the speakers connected to the receiver.

- The Volume Limit function is working.
For details, see “Using the Volume Limit function” (page 49).

The source sound input to the HDMI jack on the receiver is not output from the receiver or the TV speaker.

- Check the setting of CONTROL FOR HDMI in the SET HDMI menu (page 36).
- Check the HDMI connection (page 18).
- You cannot listen to the Super Audio CD by connecting HDMI.
- Depending on the playback component, you may need to set up the component. Refer to the operating instructions supplied with each component.

The source image input to the HDMI jack on the receiver is not output from the TV.

- Check the HDMI connection (page 18).
- Depending on the playback component, you may need to set up the component. Refer to the operating instructions supplied with each component.

The control for HDMI function does not work.

- Check the HDMI connection (page 18).
- Make sure “CONTROL FOR HDMI” is set to “CTRL ON” in SET HDMI menu.
- Make sure the connected component is compatible with the Control for HDMI function.
- Check the Control for HDMI settings on the connected component. Refer to the operating instructions of the connected component.
- Repeat the procedures of “Preparing for the “BRAVIA” Sync” if you change the HDMI connection, connect/disconnect the AC power cord, or there is a power failure (page 46).

No sound is output from the receiver and TV speaker while using the System Audio Control function.

- Make sure the TV is compatible with the System Audio Control function.
- If you cannot listen to the sound of a component connected to the receiver
 - Select the appropriate input when you want to watch a program on a component connected via HDMI connection to the receiver.
 - Change the TV channel when you want to watch a TV broadcast.
 - Select the component or input you want to watch when you watch a program on the component connected to the TV. Refer to the operating instructions of the TV on this operation.

When the receiver is in standby mode, there is no image or sound on the TV.

- When the receiver is in standby mode, image and sound are output from the HDMI component selected the last time you turned off the receiver. If you are enjoying other component, play the component and perform the One-Touch Play operation, or turn on the system to select the HDMI component you want to enjoy.
 - Make sure “P.SAVE” is set to “SAVE OFF” in the SET HDMI menu if you connect component not compatible with the “BRAVIA” Sync to the receiver (page 50).
-

S-AIR function

S-AIR connection is not established (sound transmission is not established), e.g., the indicator of the S-AIR sub unit turns off, flashes, or turns red.

- If you use another S-AIR main unit, place it more than 26 1/4 feet away from this S-AIR main unit.
- Confirm the S-AIR IDs of the S-AIR main unit and S-AIR sub unit (page 55).
- Another S-AIR sub unit is paired to the S-AIR main unit. Pair the desired S-AIR sub unit with the S-AIR main unit (page 55).
- The S-AIR main unit is paired to another S-AIR sub unit. Cancel pairing.
- Place the S-AIR main unit and S-AIR sub unit separately from other wireless devices.
- Avoid using any other wireless devices.
- The S-AIR sub unit is turned off. Make sure the AC power cord (mains lead) is connected and turn on the S-AIR sub unit.

No sound is heard from the S-AIR product.

- If you use another S-AIR main unit, place it more than 26 1/4 feet away from this S-AIR main unit.
- Confirm the S-AIR IDs of the S-AIR main unit and S-AIR sub unit (page 55).
- Confirm the pairing setting (page 55).
- Place the S-AIR main unit and S-AIR sub unit closer to each other.
- Avoid use of equipment that generates electromagnetic energy, such as a microwave oven.
- Place the S-AIR main unit and S-AIR sub unit separately from other wireless devices.
- Avoid using any other wireless devices.
- Change the “RF CHNG” setting (page 58).
- Change the S-AIR ID settings of the S-AIR main unit and S-AIR sub unit.
- Turn off the receiver and S-AIR sub unit, then turn on again.

There is noise or the sound skips.

- If you use another S-AIR main unit, place it more than 26 1/4 feet away from this S-AIR main unit.
- Place the S-AIR main unit and S-AIR sub unit closer to each other.
- Avoid use of equipment that generates electromagnetic energy, such as a microwave oven.
- Place the S-AIR main unit and S-AIR sub unit separately from other wireless devices.
- Avoid using any other wireless devices.
- Change the “RF CHNG” setting (page 58).
- Change the S-AIR ID settings of the S-AIR main unit and S-AIR sub unit.

Tuner

The FM reception is poor.

- Use a 75-ohm coaxial cable (not supplied) to connect the receiver to an outdoor FM antenna as shown below. If you connect the receiver to an outdoor antenna, ground it against lightning. To prevent a gas explosion, do not connect the ground wire to a gas pipe.

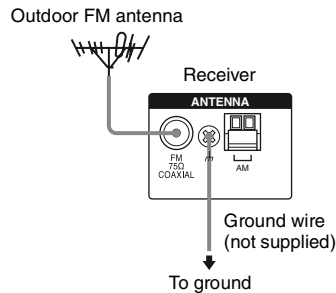

Radio stations cannot be tuned in.

- Check that the antennas are connected securely. Adjust the antennas and connect an external antenna, if necessary.
 - The signal strength of the stations is too weak (when tuning in with automatic tuning). Change to monaural reception (page 43).
 - No stations have been preset or the preset stations have been cleared (when tuning by scanning preset stations). Preset the stations (page 43).
-

Remote control

The remote does not function.

- For receiver operation, you can only use the DISPLAY button when the TUNER input is selected.
 - Point the remote at the remote sensor on the receiver.
 - Remove any obstacles in the path between the remote and the receiver.
 - Replace all the batteries in the remote with new ones, if they are weak.
 - Make sure you select the correct input on the remote.
-

Others

The ACTIVE STANDBY lamp is flashing.

- The receiver is in protection mode. Turn off the receiver and turn it on again.
-

Error messages

If an error message appears while you perform Auto Calibration, see “When error codes appear” (page 25) to solve the problem.

If you are unable to remedy the problem using the troubleshooting guide

Clearing the receiver’s memory may remedy the problem (page 21). However, note that all memorized settings will be reset to their factory settings and you will have to readjust all settings on the receiver.

If the problem persist

Consult your nearest Sony dealer. Note that if service personnel changes some parts during repair, these parts may be retained.

In the event of a problem with S-AIR function, have a Sony dealer check the entire system together (S-AIR main unit and S-AIR sub unit).

Reference sections for clearing the receiver’s memory

To clear	See
All memorized settings	page 21

Specifications

AUDIO POWER SPECIFICATIONS

POWER OUTPUT AND TOTAL HARMONIC DISTORTION: (Models of area code UC only)

With 3 ohm loads, both channels driven, from 170 – 20,000 Hz; rated 84 watts per channel minimum RMS power, with no more than 1% total harmonic distortion from 250 milliwatts to rated output.

Amplifier section

Models of area code UC

Power Output¹⁾

Stereo mode (rated) 84 W + 84 W
(3 ohms at 170 – 20,000 Hz, THD 1%)

Surround mode (reference)

RMS Output
(3 ohms at 1 kHz, THD 10%)
FRONT²⁾: 143 W/ch
CENTER²⁾: 143 W
SUR²⁾: 143 W/ch
(1.5 ohms at 70 Hz, THD 10%)
SUBWOOFER²⁾: 285 W

Models of area code MX

Power Output¹⁾

Stereo mode (rated) 90 W + 90 W
(3 ohms at 1 kHz, THD 1%)

Surround mode (reference)

RMS Output
(3 ohms at 1 kHz, THD 10%)
FRONT²⁾: 125 W/ch
CENTER²⁾: 125 W
SUR²⁾: 125 W/ch
(1.5 ohms at 70 Hz, THD 10%)
SUBWOOFER²⁾: 210 W

¹⁾Measured under the following conditions:

Area code	Power requirements
UC	120 V AC, 60 Hz
MX	127 V AC, 60 Hz

²⁾Reference power output for front, center, surround speakers and subwoofer. Depending on the sound field settings and the source, there may be no sound output.

Inputs

Analog Sensitivity: 1 V/50 kohms

Digital (Coaxial) Impedance: 75 ohms

Tone

Gain levels ±10 dB, 0.5 dB step

Reproduction frequency range:

28 – 20,000 Hz

FM tuner section

Tuning range 87.5 – 108.0 MHz

Antenna FM wire antenna

Antenna terminals 75 ohms, unbalanced

Intermediate frequency

10.7 MHz

AM tuner section

Tuning range

Area code	Tuning scale	
	10 kHz step	9 kHz step
UC, MX	530 – 1,710 kHz	531 – 1,710 kHz

Antenna Loop antenna

Intermediate frequency
450 kHz

General

Power requirements

Area code	Power requirements
UC	120 V AC, 60 Hz
MX	127 V AC, 60 Hz

Power output (DIGITAL MEDIA PORT)

DC OUT: 5 V, 700 mA MAX

Power consumption	
Area code	Power consumption
UC	165 W
MX	140 W

Power consumption (during standby mode)
0.3 W (When Control for HDMI and S-AIR standby are off)

Dimensions (w/h/d) (Approx.)
17 × 2 5/8 × 13 1/8 inches
(430 × 66.5 × 333 mm)
including projecting parts and controls

Mass (Approx.) 3.4 kg (7 lb 8 oz)

Speaker section

- **Front speaker (SS-MSP36F)**
- **Surround speaker (SS-SRP36F)**
- **Center speaker (SS-CNP36)**

Front/Surround speaker

Full range

Center speaker Full range, Magnetically shielded

Speaker unit

Front/Surround speaker

2 5/8 inches (65 mm),
cone type

Center speaker 1 3/16 × 2 3/8 inches
(30 × 60 mm), cone type

Enclosure type

Front/Surround speaker

Bass reflex

Center speaker Acoustic suspension

Rated Impedance 3 ohms

Dimension (w/h/d) (Approx.)

Front speaker 4 1/2 × 32 3/4 × 3 3/8 inches
(113 × 830 × 83 mm)
(without stand)
12 1/2 × 40 – 53 × 12 1/2 inches
(315 × 1,015 – 1,345 × 315 mm) (with stand)

Surround speaker 4 3/8 × 21 3/8 × 3 1/8 inches
(108 × 540 × 78 mm)
(without stand)
11 1/2 × 41 1/4 – 48 5/8 × 11 1/2 inches
(290 × 1,045 – 1,235 × 290 mm) (with stand)

Center speaker 15 × 2 × 2 5/8 inches
(380 × 50 × 64 mm)
(with foot)

Mass (Approx.)

Front speaker 1.6 kg (3 lb 9 oz) (without stand)
3.3 kg (7 lb 5 oz) (with stand)

Surround speaker 1.1 kg (2 lb 7 oz) (without stand)
2.6 kg (5 lb 12 oz) (with stand)

Center speaker 0.38 kg (0 lb 14 oz)

• Subwoofer (SS-WP36)

Speaker unit 6 3/8 inches (160 mm),
cone type

Enclosure type Bass reflex

Rated Impedance 1.5 ohms

Dimensions (w/h/d) (Approx.)

8 3/4 × 15 5/8 × 12 7/8 inches
(220 × 395 × 325 mm) (with foot)

Mass (Approx.) 5.6 kg (12 lb 6 oz)

Supplied speakers

Front speaker (2)

Center speaker (1)

Surround speaker (2)

Subwoofer (1)

Supplied accessories

Operating Instructions (this manual)

Quick Setup Guide (1)

Speaker Stand Installation Guide (1)

FM wire antenna (1)

AM loop antenna (1)

Remote commander

•RM-AAU057 (1)

R6 (size-AA) batteries (2)

Optimizer microphone (ECM-AC2) (1)

Speaker cords (5)

Foot pads

•Speakers (4)

•Subwoofer (4)

Screws (small) (12)

Screws (large) (8)

For details on the area code of the component you are using, see page 4.

Design and specifications are subject to change without notice.

Halogenated flame retardants are not used in the certain printed wiring boards.

Index

A

AUTO CALIBRATION 22

B

Blu-ray disc player
connecting 18
playback 30

C

CD player
connecting 17
playback 29
Control for HDMI
connecting 18
preparing 46

D

Digital Cinema Sound
(DCS) 61
DIMMER 51
DISPLAY 51
Dolby Digital 61
DTS 62
DVD player
connecting 20
playback 30
DVD recorder
connecting 20
playback 30

E

Error messages 68

H

HDMI
connecting 18
Control for HDMI 36

I

IN MODE 52
Initial setup 21

M

Menu
A.CAL 36
CUSTOM 39
LEVEL 38
S-AIR 40
SET HDMI 36
SP SETUP 37
TONE 38
Muting 28

O

One-Touch Play 48

P

PAIRING 55
Power Save 50

R

Remote commander 9

S

S-AIR 53
Satellite tuner/Set-top box
connecting 18
enjoying 29
Selecting
component 28
Sleep Timer 52
Speakers
connecting 15
Super Audio CD player
connecting 17
playback 30
System Audio Control 48
System Power Off 49

T

TEST TONE 26
Tuner
connecting 21
Tuning
automatically 42
to preset stations 44
TV
connecting 16
enjoying 29

V

VCR
connecting 20
playback 30
Volume Limit 49



* 4 1 3 0 0 3 3 1 3 * (1)

Free Manuals Download Website

<http://myh66.com>

<http://usermanuals.us>

<http://www.somanuals.com>

<http://www.4manuals.cc>

<http://www.manual-lib.com>

<http://www.404manual.com>

<http://www.luxmanual.com>

<http://aubethermostatmanual.com>

Golf course search by state

<http://golfingnear.com>

Email search by domain

<http://emailbydomain.com>

Auto manuals search

<http://auto.somanuals.com>

TV manuals search

<http://tv.somanuals.com>