



The software of this system may be updated in the future. To find out details on any available updates, please visit: <http://esupport.sony.com>

## BD/DVD Home Theatre System

Operating Instructions

BDV-T20W / E500W



\* 4 1 4 7 2 2 8 1 2 \* (1)



## WARNING

**To reduce the risk of fire or electric shock, do not expose this apparatus to rain or moisture.**

Do not install the appliance in a confined space, such as a bookcase or built-in cabinet.

To reduce the risk of fire, do not cover the ventilation opening of the apparatus with newspapers, tablecloths, curtains, etc. Do not place the naked flame sources such as lighted candles on the apparatus.

To reduce the risk of fire or electric shock, do not expose this apparatus to dripping or splashing, and do not place objects filled with liquids, such as vases, on the apparatus.

Do not expose batteries or apparatus with battery-installed to excessive heat such as sunshine, fire or the like.

To prevent injury, this apparatus must be securely attached to the floor/wall in accordance with the installation instructions.

Excessive sound pressure from earphones and headphones can cause hearing loss.

Indoor use only.

## CAUTION

The use of optical instruments with this product will increase eye hazard. As the laser beam used in this BD/DVD Home Theatre System is harmful to eyes, do not attempt to disassemble the cabinet.

Refer servicing to qualified personnel only.



This label is located on the laser protective housing inside the enclosure.

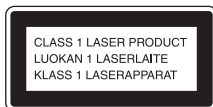

This appliance is classified as a CLASS 1 LASER product. This marking is located on the rear exterior.

## About the surround amplifier

- The nameplate is located on the side exterior.
- For the customers in the U.S.A.: Date of Manufacture Marking is located on the bottom exterior.

## Precautions

### On power sources

- The unit is not disconnected from the mains as long as it is connected to the AC outlet, even if the unit itself has been turned off.
- As the main plug is used to disconnect the unit from the mains, connect the unit to an easily accessible AC outlet. Should you notice an abnormality in the unit, disconnect the main plug from the AC outlet immediately.

### For the customers in the U.S.A.



This symbol is intended to alert the user to the presence of uninsulated “dangerous voltage” within the product’s enclosure that may be of sufficient magnitude to constitute a risk of electric shock to persons.



This symbol is intended to alert the user to the presence of important operating and maintenance (servicing) instructions in the literature accompanying the appliance.

### Owner's Record

The model and serial numbers are located at the rear exterior of the control unit. Record the serial number in the space provided below. Refer to them whenever you call upon your Sony dealer regarding this product.

Model No. BDV-T20W/BDV-E500W

Serial No. \_\_\_\_\_

The following FCC statement applies only to the version of this model manufactured for sale in the USA. Other versions may not comply with FCC technical regulations.

### NOTE:

This equipment has been tested and found to comply with the limits for a Class B digital device, pursuant to Part 15 of the FCC Rules. These limits are designed to provide reasonable protection against harmful interference in a residential installation. This equipment generates, uses, and can radiate radio frequency energy and, if not installed and used in accordance with the instructions, may cause harmful interference to radio communications. However, there is no guarantee that interference will not occur in a

particular installation. If this equipment does cause harmful interference to radio or television reception, which can be determined by turning the equipment off and on, the user is encouraged to try to correct the interference by one or more of the following measures:

- Reorient or relocate the receiving antenna (aerial).
- Increase the separation between the equipment and receiver.
- Connect the equipment into an outlet on a circuit different from that to which the receiver is connected.
- Consult the dealer or an experienced radio/TV technician for help.

## CAUTION

You are cautioned that any changes or modifications not expressly approved in this manual could void your authority to operate this equipment.

## Important Safety Instructions

- 1) Read these instructions.
- 2) Keep these instructions.
- 3) Heed all warnings.
- 4) Follow all instructions.
- 5) Do not use this apparatus near water.
- 6) Clean only with dry cloth.
- 7) Do not block any ventilation openings. Install in accordance with the manufacturer's instructions.
- 8) Do not install near any heat sources such as radiators, heat registers, stoves, or other apparatus (including amplifiers) that produce heat.
- 9) Do not defeat the safety purpose of the polarized or grounding-type plug. A polarized plug has two blades with one wider than the other. A grounding type plug has two blades and a third grounding prong. The wide blade or the third prong are provided for your safety. If the provided plug does not fit into your outlet, consult an electrician for replacement of the obsolete outlet.
- 10) Protect the power cord from being walked on or pinched particularly at plugs, convenience receptacles, and the point where they exit from the apparatus.
- 11) Only use attachments/accessories specified by the manufacturer.
- 12) Use only with the cart, stand, tripod, bracket, or table specified by the manufacturer, or sold with the apparatus. When a cart is used, use caution

when moving the cart/apparatus combination to avoid injury from tip-over.



- 13) Unplug this apparatus during lightning storms or when unused for long periods of time.
- 14) Refer all servicing to qualified service personnel. Servicing is required when the apparatus has been damaged in any way, such as power-supply cord or plug is damaged, liquid has been spilled or objects have fallen into the apparatus, the apparatus has been exposed to rain or moisture, does not operate normally, or has been dropped.



ENERGY STAR<sup>®</sup> is a U.S. registered mark.

As an ENERGY STAR<sup>®</sup> partner, Sony Corporation has determined that this product meets the ENERGY STAR<sup>®</sup> guidelines for energy efficiency.

## For the wireless transceiver (EZW-RT10/EZW-RT10A)

This equipment must not be co-located or operated in conjunction with any other antenna or transmitter.

This equipment complies with FCC radiation exposure limits set forth for uncontrolled equipment and meets the FCC radio frequency (RF) Exposure Guidelines in Supplement C to OET65.

This equipment should be installed and operated with at least 20cm and more between the radiator and person's body (excluding extremities: hands, wrists, feet and ankles).

## Notice for the customers in Canada

### For the wireless transceiver (EZW-RT10/EZW-RT10A)

This Class B digital apparatus complies with Canadian ICES-003.

This device complies with RSS-Gen of IC Rules. Operation is subject to the following two conditions: (1) this device may not cause interference, and (2) this device must accept any interference, including interference that may cause undesired operation of this device.

This equipment complies with IC radiation exposure limits set forth for uncontrolled equipment and meets RSS-102 of the IC radio frequency (RF) Exposure rules.

This equipment should be installed and operated with at least 20cm and more between the radiator and persons body (excluding extremities: hands, wrists, feet and ankles).

## Copyrights and Trademarks

- This product incorporates copyright protection technology that is protected by U.S. patents and other intellectual property rights.

Use of this copyright protection technology must be authorized by Macrovision, and is intended for home and other limited viewing uses only unless otherwise authorized by Macrovision.

Reverse engineering or disassembly is prohibited.

- This system incorporates with Dolby\* Digital and Dolby Pro Logic (II) adaptive matrix surround decoder and the DTS\*\* Digital Surround System.

\* Manufactured under license from Dolby Laboratories.

“Dolby”, “Pro Logic”, and the double-D symbol are trademarks of Dolby Laboratories.

\*\* Manufactured under license under U.S. Patent #'s: 5,451,942; 5,956,674; 5,974,380; 5,978,762; 6,226,616; 6,487,535; 7,392,195; 7,272,567; 7,333,929; 7,212,872 & other U.S. and worldwide patents issued & pending.

DTS is a registered trademark and the DTS logos, Symbol, DTS-HD and DTS-HD Master Audio | Essential are trademarks of DTS, Inc. © 1996-2008 DTS, Inc. All Rights Reserved.

- This system incorporates High-Definition Multimedia Interface (HDMI™) technology. HDMI, the HDMI logo and High-Definition Multimedia Interface are trademarks or registered trademarks of HDMI Licensing LLC.
- Java and all Java-based trademarks and logos are trademarks or registered trademarks of Sun Microsystems, Inc.
- “BD-Live” and “BonusView” are trademarks of Blu-ray Disc Association.
- “Blu-ray Disc” is a trademark.
- “Blu-ray Disc,” “DVD+RW,” “DVD-RW,” “DVD+R,” “DVD-R,” “DVD VIDEO,” and “CD” logos are trademarks.
- “BRAVIA” is a trademark of Sony Corporation.
- “AVCHD” and the “AVCHD” logo are trademarks of Matsushita Electric Industrial Co., Ltd. and Sony Corporation.
- “S-AIR” and its logo are trademarks of Sony Corporation.

- “XMB,” and “xross media bar” are trademarks of Sony Corporation and Sony Computer Entertainment Inc.
- “PLAYSTATION” is a trademark of Sony Computer Entertainment Inc.
- “x.v.Color” and “x.v.Color” logo are trademarks of Sony Corporation.
- “PhotoTV HD” and the “PhotoTV HD” logo are trademarks of Sony Corporation.
- Other system and product names are generally trademarks or registered trademarks of the manufacturers. ™ and © marks are not indicated in this document.

---

## About These Operating Instructions

- The instructions in these Operating Instructions describe the controls on the remote. You can also use the controls on the unit if they have the same or similar names as those on the remote.
- Icons, such as **BD**, listed at the top of each explanation indicate what kind of disc can be used with the function being explained. For details, see “Playable Discs” (page 101).
- In this manual, “disc” is used as a general reference for the BDs, DVDs, or CDs unless otherwise specified by the text or illustrations.
- The instructions in this manual are for BDV-T20W and BDV-E500W. BDV-T20W is the model used for illustration purposes. Any difference in operation is clearly indicated in the text, for example, “BDV-T20W.”
- The Control Menu items may vary depending on the area.
- The default setting is underlined.

---

## About the S-AIR function

The system is compatible with the S-AIR function, which allows transmission of sound between S-AIR products wirelessly. The following S-AIR products can be used with the system:

- Surround amplifier (supplied): You can enjoy surround speaker sound wirelessly.
- Surround back amplifier (optional): You can enjoy surround back speaker sound wirelessly.
- S-AIR receiver (optional): You can enjoy system sound in another room.

The S-AIR products can be purchased as options (the S-AIR product lineup differs depending on the area).

Notes or instructions for the surround amplifier, surround back amplifier, or S-AIR receiver in these Operating Instructions refer only to when the surround amplifier, surround back amplifier, or S-AIR receiver is used.

For details on the S-AIR function, see “Using an S-AIR Product” (page 61).

# Table of Contents

About These Operating Instructions .....	5	Using the Sleep Timer .....	75
About the S-AIR function .....	5	Changing the Brightness of the Front Panel Display.....	75
Unpacking .....	7	Deactivating the Buttons on the Unit ...	76
Index to Parts and Control .....	10	About the demonstration .....	76
<b>Getting Started</b>		Saving Power in Standby Mode .....	77
<b>Step 1: Installing the System .....</b>	<b>16</b>	<b>Settings and Adjustments</b>	
<b>Step 2: Connecting the System ...</b>	<b>22</b>	Using the Setup Display .....	78
<b>Step 3: Setting up the Wireless   System .....</b>	<b>32</b>	[Network Update] .....	79
<b>Step 4: Performing the Easy   Setup .....</b>	<b>34</b>	[Video Settings] .....	80
<b>Step 5: Selecting the Source .....</b>	<b>37</b>	[Audio Settings].....	82
<b>Step 6: Enjoying Surround   Sound .....</b>	<b>38</b>	[BD/DVD Viewing Settings] .....	84
<b>Playback</b>		[Photo Settings] .....	86
Playing a BD/DVD .....	41	[HDMI Settings].....	86
Enjoying BonusView/BD-Live.....	48	[System Settings].....	87
Playing a CD .....	49	[Network Settings].....	88
Playing Photo Files .....	50	[Easy Setup].....	89
<b>Sound Adjustment</b>		[Resetting] .....	90
Selecting the Effect to Suit the Source .....	52	<b>Additional Information</b>	
Selecting the Audio Format, Multilingual Tracks, or Channel.....	53	Precautions .....	91
Enjoying Multiplex Broadcast Sound .....	54	Notes about the Discs .....	92
Using the Sound Effect .....	54	Troubleshooting .....	93
<b>Tuner</b>		Self-diagnosis Function .....	100
Listening to the Radio .....	56	Playable Discs .....	101
<b>External Audio Device</b>		Supported Audio Formats.....	103
Using the DIGITAL MEDIA PORT Adapter .....	60	Video Output Resolution.....	104
Using an S-AIR Product .....	61	Specifications .....	105
<b>Other Operations</b>		Language Code List.....	108
Using the Control for HDMI Function for “BRAVIA” Sync .....	67	Terms and Conditions of Use and End User License Agreement .....	109
Calibrating the Appropriate Settings Automatically .....	70	Software License Information .....	111
Setting the Speakers .....	71	Glossary .....	120
Controlling Your TV with the Supplied Remote .....	73	Index .....	123

# Unpacking

## BDV-T20W

- Front speakers (2)

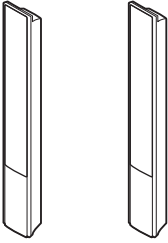

- Surround speakers (2)

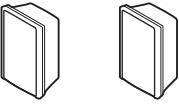

- Center speaker (1)



- Subwoofer (1)

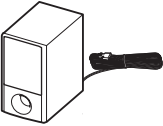

- AM loop antenna (aerial) (1)



- FM wire antenna (aerial) (1)

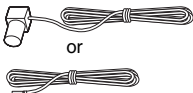

- Speaker cords (5, white/red/blue/gray/green)



- Video cord (1)



- Remote commander (remote) (1)



- R6 (size AA) batteries (2)



- Calibration mic (1)

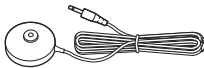

- Foot pads (1 set)



- Posts (2)

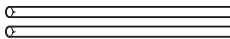

- Bases (2)



- Mounting plates (2)



- Post covers (2)



- Screws (large, with washer) (4)



- Screws (small) (6)



- Surround amplifier (1)

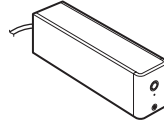

- Speaker cord cover (1)



- Speaker cord holder (1)



- Wireless transceivers (2)



- Operating Instructions
- Speaker Installation Guide
- Quick Setup Guide
- To stabilize S-AIR reception
- Setup Disc (DVD)
- DIGITAL MEDIA PORT adapter (TDM-iP20) (1)

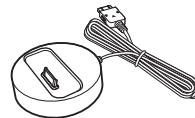

- Operating Instructions for the DIGITAL MEDIA PORT adapter (TDM-iP20)

# BDV-E500W

- Front speakers (2)

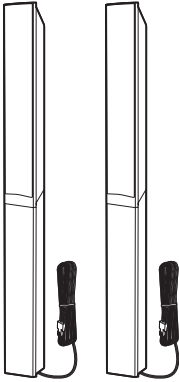

- Surround speakers (2)

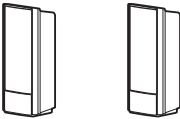

- Center speaker (1)



- Subwoofer (1)

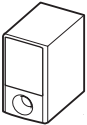

- AM loop antenna (aerial) (1)



- FM wire antenna (aerial) (1)

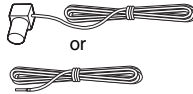

- Speaker cords (4, blue/gray/green/purple)

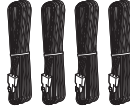

- Video cord (1)



- Remote commander (remote) (1)



- R6 (size AA) batteries (2)



- Calibration mic (1)



- Foot pads (1 set)



- Bases (2)



- Screws (with washer) (6)



- Surround amplifier (1)

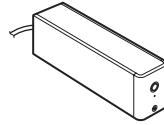

- Speaker cord cover (1)



- Speaker cord holder (1)



- Wireless transceivers (2)

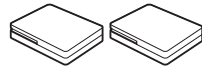

- Operating Instructions
- Speaker Installation Guide
- Quick Setup Guide
- To stabilize S-AIR reception
- Setup Disc (DVD)
- DIGITAL MEDIA PORT adapter (TDM-iP20) (1)



- Operating Instructions for the DIGITAL MEDIA PORT adapter (TDM-iP20)



## Using the remote

### Inserting batteries into the remote

Insert two R6 (size AA) batteries (supplied) by matching the  $\oplus$  and  $\ominus$  ends on the batteries to the markings inside the compartment.

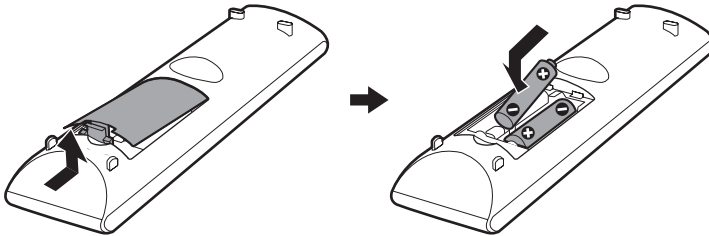

#### Note

- Do not leave the remote in an extremely hot or humid place.
- Do not use a new battery with an old one.
- Do not drop any foreign object into the remote casing, particularly when replacing the batteries.
- If you do not intend to use the remote for an extended period of time, remove the batteries to avoid possible damage from battery leakage and corrosion.

## Attaching the foot pads to the subwoofer

Attach the foot pads (supplied) to the bottom of the subwoofer to stabilize the subwoofer and prevent it from slipping.

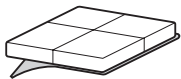

Remove the foot pads from the protective cover.

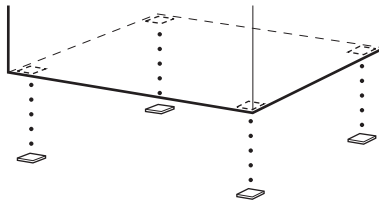

# Index to Parts and Control

For more information, refer to the pages indicated in parentheses.

## Remote control

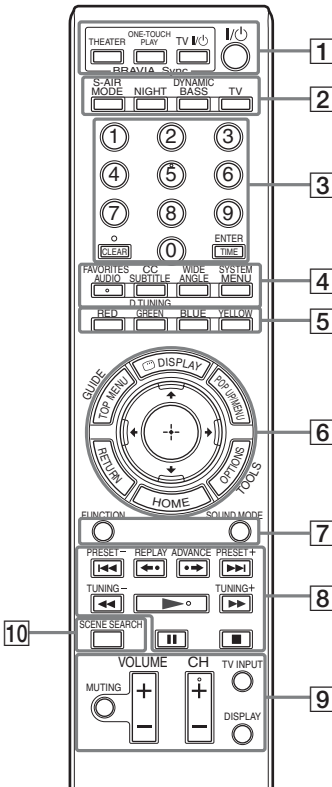

Number 5, FAVORITES/AUDIO, CH +, and ► buttons have a tactile dot. Use the tactile dot as a reference when operating the remote.

- **[BD]** : For system operations
- **[TV]** : For TV operations  
(For details, see “Controlling Your TV with the Supplied Remote” (page 73).)

- 1 THEATER (page 68) [TV]**  
Switches to the optimum video mode for watching movies automatically.  
**ONE-TOUCH PLAY (pages 41, 68) [BD]**  
By only pressing the button, the TV turns on, the TV is set for BD/DVD input selector, and the system starts playing a disc automatically.  
**TV I/⏻ (on/standby) (page 73) [TV]**  
Turns on the TV or sets it to standby mode.  
**I/⏻ (on/standby) (pages 31, 34, 41, 56) [BD]**  
Turns on the system or sets it to standby mode.
- 2 S-AIR MODE (page 62) [BD]**  
Selects playback mode for the S-AIR receiver.  
**NIGHT (page 55) [BD]**  
Activates the night mode function.  
**DYNAMIC BASS (page 54) [BD]**  
Reinforces bass frequencies.  
**TV (page 73) [TV]**  
Changes to the TV operation mode for the remote.
- 3 Number buttons (pages 41, 57, 73) [BD] [TV]**  
Enters the title/chapter numbers, radio frequencies, etc.  
**CLEAR (pages 45, 58) [BD]**  
Clears the entry field.  
**TIME (page 46) [BD]**  
Displays the elapsed/remaining playback time in the front panel display.  
• **(page 73) [TV]**  
Inputs “.” (dot) when inputting numerics.  
**ENTER (page 73) [TV]**  
Enters the selected item.
- 4 AUDIO (pages 53, 54) [BD]**  
**SUBTITLE (page 43) [BD]**  
Selects the subtitle language when multilingual subtitles are recorded on a BD-ROM/DVD VIDEO.  
**D.TUNING (page 58) [BD]**  
Selects the radio frequencies.

**ANGLE (page 43)**  BD

Switches to other viewing angles when multi-angles are recorded on a BD-ROM/DVD VIDEO.

**SYSTEM MENU (pages 38, 47, 54, 58, 61, 75, 75)**  BD

Enters the system menu.

**FAVORITES (page 73)**  TV

Displays the favorite channel list.

**CC (page 73)**  TV

Displays closed captioning (when available).

**WIDE (page 73)**  TV

Changes the aspect ratio of the connected TV.

**5 Color buttons (RED/GREEN/BLUE/YELLOW) (page 88)**  BD

Short cut keys for selecting items on some BD's menus (can also be used for BD's Java interactive operations).

**6 TOP MENU (page 44)**  BD

Opens or closes the BD's or DVD's Top Menu.

 **DISPLAY (page 46)**  BD

Displays the playback information on the TV screen.

**POP UP/MENU (page 44)**  BD

Opens or closes the BD-ROM's Pop-up Menu, or the DVD's menu.

**OPTIONS (pages 41, 49, 50, 56)**  BD

Displays the options menu on the TV screen.

**HOME (pages 34, 41, 49, 50, 56, 70, 78)**
 BD  TV

Enters or exits the system's home menu.

**RETURN (pages 73, 88)**  BD  TV

Returns to the previous display.

**←/↑/↓/→**  BD  TV

Moves the highlight to a displayed item.

**⊕ (ENTER)**  BD  TV

Enters the selected item.

**GUIDE (page 73)**  TV

Displays the Digital Electronic Programme Guide (EPG).

**TOOLS (page 73)**  TV

Displays the operation menu for the current display.

**7 FUNCTION (pages 37, 41, 49, 50, 56, 60)**  BD

Selects the playback source.

**SOUND MODE (page 52)**  BD

Selects the sound mode.

**8 Playback operation buttons**  BD

See "Playback" (page 41).

**◀◀/▶▶ (previous/next)****◀•/•▶ REPLAY/ADVANCE****◀◀/▶▶ (fast reverse/fast forward)****▶ (play)****⏸ (pause)****■ (stop)****Radio operation buttons**  BD

See "Tuner" (page 56).

**PRESET +/-****TUNING +/-****9 MUTING (pages 41, 49, 73)**  BD  TV

Turns off the sound temporarily.

**VOLUME +/- (pages 41, 73)**  BD
 TV

Adjusts the volume.

**CH +/- (page 73)**  TV

Selects the channels up and down.

**TV INPUT (page 73)**  TV

Switches the TV's input source between the TV and other input sources.

**DISPLAY (page 56)**  BD

Changes the radio information in the front panel display between radio frequency and station name.

**10 SCENE SEARCH (page 45)**  BD

Switches to Scene Search mode that lets you move quickly between scenes within the title currently being played back.

## Front panel

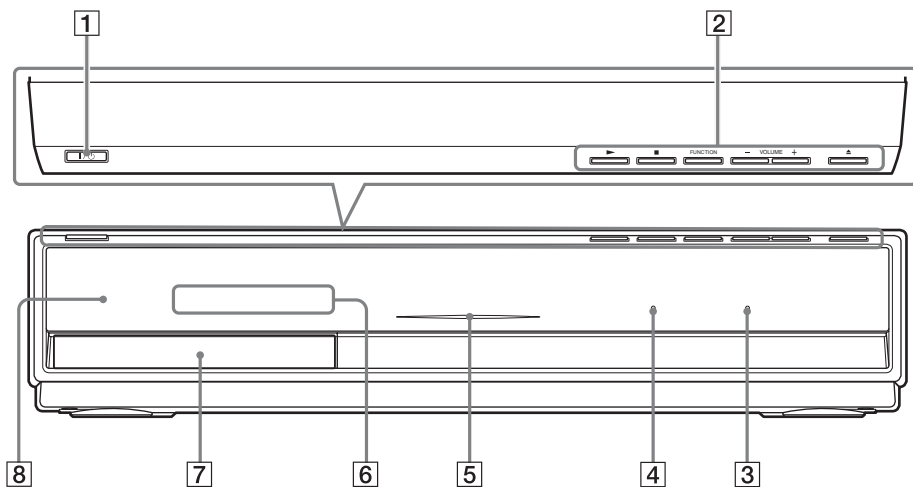

- 1** **I/O (on/standby) (page 41)**  
Turns on the unit, or sets to standby mode.
  - 2** **Play operation buttons (page 41)**
    - ▶ (play)**  
Starts or re-starts playback.  
Plays a slideshow when a disc containing JPEG image files is inserted.
    - (stop)**  
Stops playback and remembers the stop point (resume point).  
The resume point for a title/track is the last point you played or the last photo for a photo folder.
  - FUNCTION**  
Selects the playback source.
  - VOLUME +/-**  
Adjusts the system's volume.
  - ▲ (open/close)**  
Opens or closes the disc tray.
- 3** **S-AIR indicator**  
Lights up when the S-AIR transceiver is inserted in the unit and the system transmits sound.
  - 4** **VIRTUAL 7.1CH indicator (page 38)**  
Lights up while virtual 7.1ch decoding is activated.
  - 5** **Power indicator**  
Lights up while the system is turned on.
  - 6** **Front panel display**
  - 7** **Disc tray (page 41)**
  - 8** **■ (remote sensor)**

## Front panel display

### About the indications in the front panel display

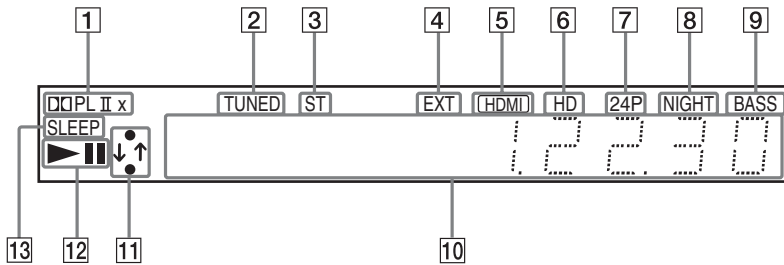

- 1 Current surround format
- 2 Lights up when a station is received. (Radio only) (page 56)
- 3 Lights up when stereo sound is received. (Radio only) (page 56)
- 4 Lights up when the external memory is recognized. (page 29)
- 5 Lights up when the HDMI OUT jack is correctly connected to an HDCP (High-bandwidth Digital Content Protection)-compliant device with HDMI or DVI (Digital Visual Interface) input.
- 6 Lights up when outputting 720p/1080i/1080p video signals from the HDMI OUT jack or 720p/1080i video signals from the COMPONENT VIDEO OUT jacks.
- 7 Lights up when outputting 1920 × 1080p/24 Hz video signals.
- 8 Lights up when the night mode is on. (page 55)
- 9 Lights up when the DYNAMIC BASS function is on. (page 54)
- 10 Displays system's status such as chapter, title, or track number, time information, radio frequency, playing status, decoding mode, etc.
- 11 Lights up when the system is accessing the network.
- 12 Displays system's playing status.
- 13 Flashes when the sleep timer is set. (page 75)

## Rear panel

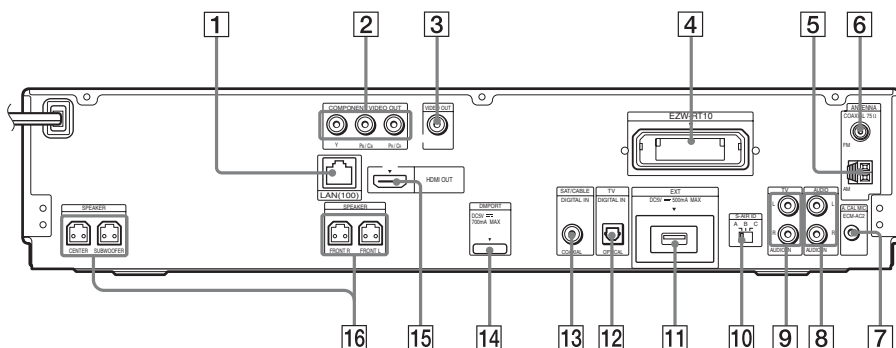

- |   |   |
|---|---|
| <b>1</b> LAN (100) terminal (page 30)         | <b>10</b> S-AIR ID switch (pages 32, 61)                |
| <b>2</b> COMPONENT VIDEO OUT jacks (page 24)  | <b>11</b> EXT slot (page 29)                            |
| <b>3</b> VIDEO OUT jack (page 24)             | <b>12</b> TV (DIGITAL IN OPTICAL) jack (page 25)        |
| <b>4</b> EZW-RT10 slot (page 28)              | <b>13</b> SAT/CABLE (DIGITAL IN COAXIAL) jack (page 26) |
| <b>5</b> AM terminal (page 27)                | <b>14</b> DMPORT (DIGITAL MEDIA PORT) jack (page 26)    |
| <b>6</b> COAXIAL 75Ω FM jack (page 27)        | <b>15</b> HDMI OUT jack (page 24)                       |
| <b>7</b> A.CAL MIC jack (pages 34, 70)        | <b>16</b> SPEAKER jacks (page 22)                       |
| <b>8</b> AUDIO (AUDIO IN L/R) jacks (page 26) |   |
| <b>9</b> TV (AUDIO IN L/R) jacks (page 25)    |   |

# Surround amplifier

## Front panel

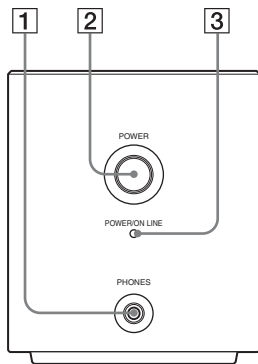

## Rear panel

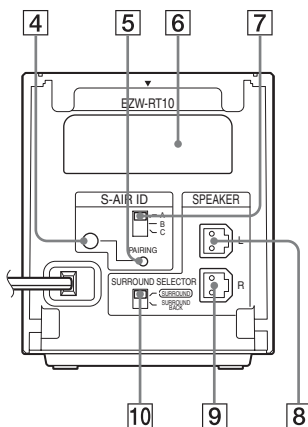

- 1 PHONES jack (page 32)
- 2 POWER (ON/OFF) (pages 32, 61)
- 3 POWER / ON LINE indicator (pages 32, 61)
- 4 PAIRING indicator (page 64)
- 5 PAIRING (page 64)

- 6 Wireless transceiver (EZW-RT10) slot (page 28)
- 7 S-AIR ID switch (pages 32, 61)
- 8 SPEAKER L jack (page 22)
- 9 SPEAKER R jack (page 22)
- 10 SURROUND SELECTOR switch (pages 32, 61)

## Step 1: Installing the System

### Positioning the speakers

For the best possible surround sound, place all speakers at the same distance from the listening position (A). The distance can be between 0 to 23 feet (0.0 to 7.0 meters).

If you cannot place the center speaker and surround speakers at the same distance as (A), place them within 23 feet (7.0 meters) of the listening position.

Place the surround speakers to the rear of the listening position (B).

The subwoofer can be placed anywhere in the room.

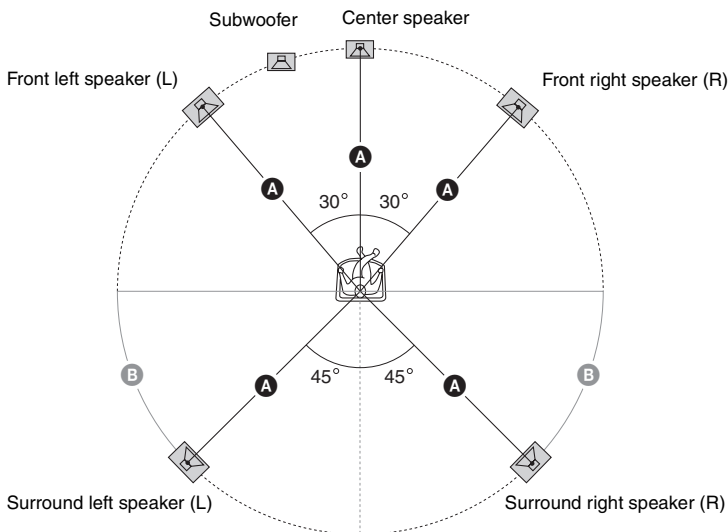

#### Note

- Use caution when placing the speakers and/or speaker stands attached to the speakers on a specially treated (waxed, oiled, polished, etc.) floor, as staining or discoloration may result.
- Do not lean or hang on a speaker, as it may fall down.



## To add the optional surround back speakers

You can enjoy 7.1 surround sound by purchasing the Wireless Surround Speaker Kit (WAHT-SBP1, optional). The optional product lineup differs depending on the area.

For the position of the surround back speakers, refer the illustration below (C).

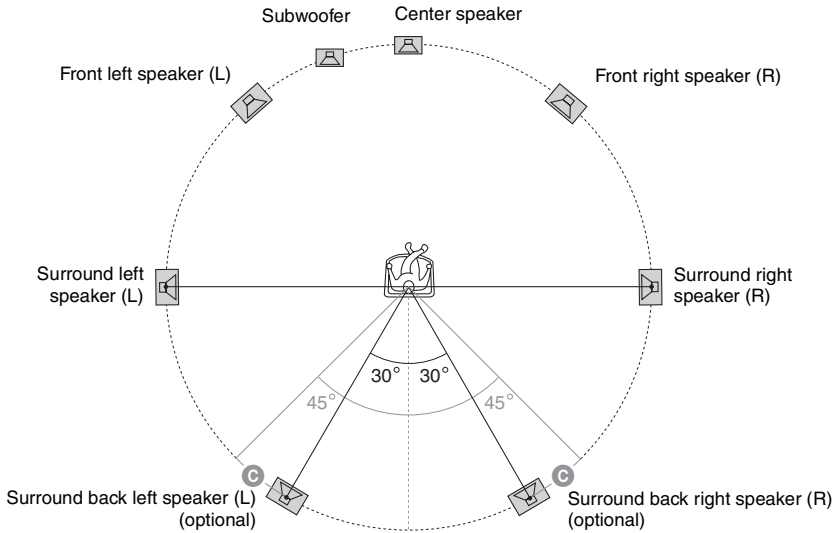

## Installing the speakers on a wall

### Caution

- Contact a screw shop or installer regarding the wall material or screws to be used.
- Use screws that are suitable for the wall material and strength. As a plaster board wall is especially fragile, attach the screws securely to a beam and fasten them to the wall. Install the speakers on a vertical and flat wall where reinforcement is applied.
- Sony is not responsible for accidents or damage caused by improper installation, insufficient wall strength or improper screw installation, natural calamity, etc.

Before installing the front speakers of BDV-E500W on a wall, you need to disassemble the speakers. You can install the upper part of a speaker on a wall.

### To disassemble the speaker

*(Front speakers of BDV-E500W only)*

- 1** Disconnect the speaker cords from the speaker.

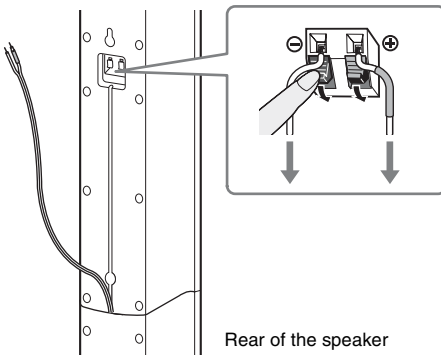

- 2** Remove the screw (pre-installed) at the rear of the speaker.

This screw is used when reassembling the speaker. Be sure not to lose the screw.

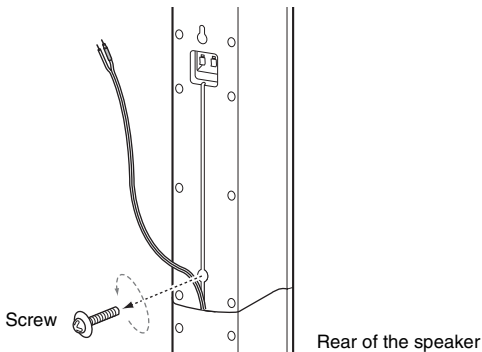

### 3 Disassemble the speaker by lifting the upper part of the speaker.

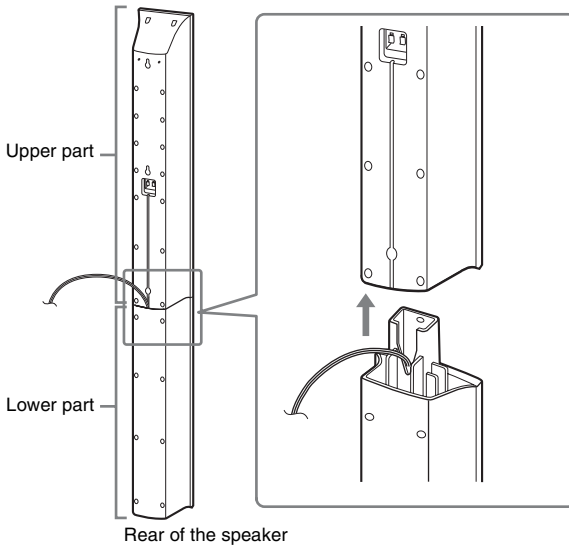

### 4 Pull out the speaker cord from the bottom of the lower part of the speaker.

The removed speaker cord is used when installing the speaker on a wall.

Lower part of the speaker

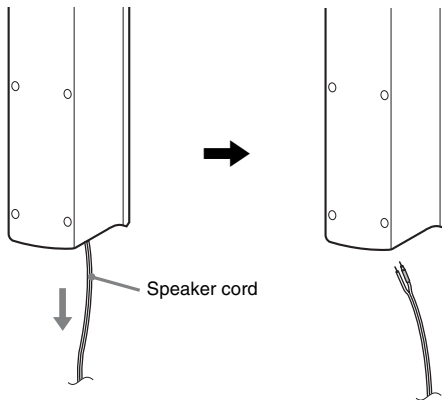

## Fully-disassembled illustration

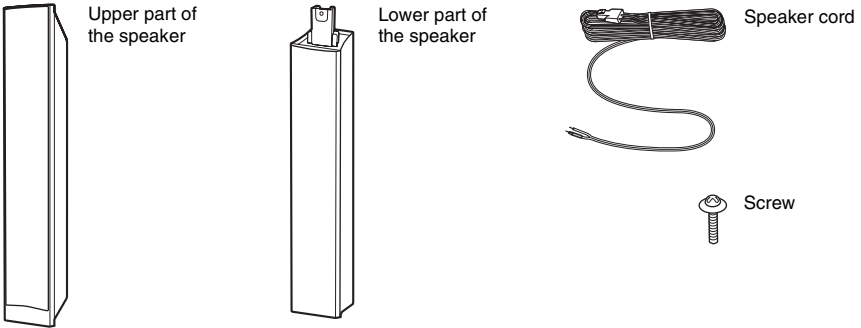

## To install the speakers on a wall

Before installing the speakers on a wall, connect the speaker cord to the speaker.

Be sure to match the speaker cords to the appropriate terminals on the speakers: the speaker cord with the color tube to  $\oplus$ , and the speaker cord without the color tube to  $\ominus$ .

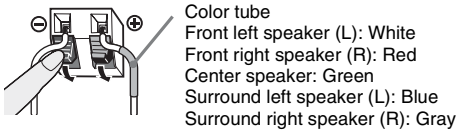

- 1 Prepare screws (not supplied) that are suitable for the hole on the back of each speaker. See the illustrations below.**

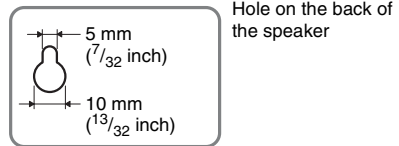
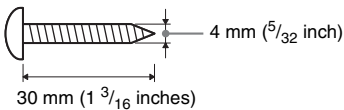

## 2 Fasten the screws to the wall.

### BDV-T20W

For the front speakers

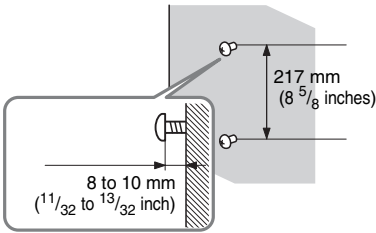

For the center speaker

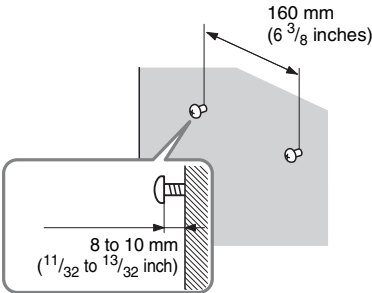

For the surround speakers

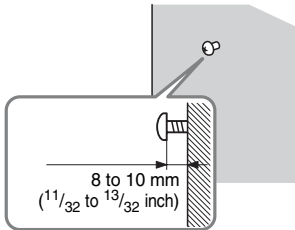

### BDV-E500W

For the front speakers

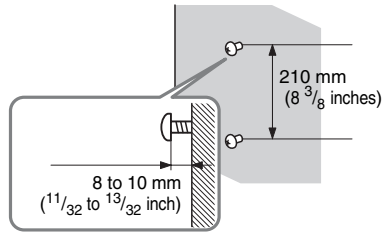

For the center speaker

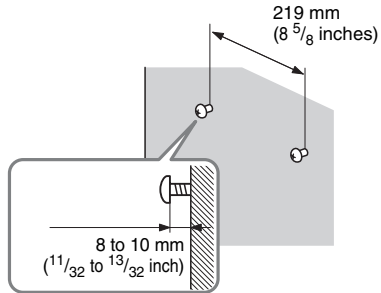

For the surround speakers

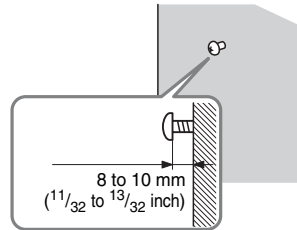

## 3 Hang the speakers on the screws.

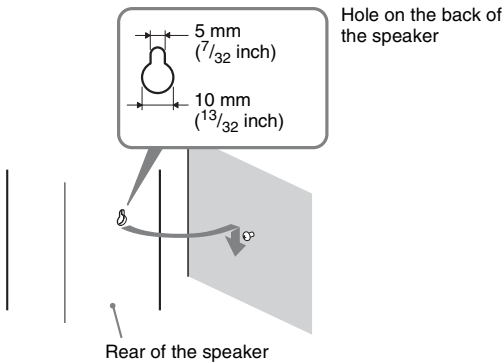

## Step 2: Connecting the System

For connecting the system, read the information on the following pages.

Do not connect the AC power cord (mains lead) of the unit to a wall outlet (mains) until all the other connections are made.

**Note**

- When you connect another component with a volume control, turn down the volume of the other components to a level where sound is not distorted.

### Connecting the speakers

The connector of the speaker cords and the color tube are color-coded depending on the type of speaker. Connect the speaker cords to match the color of the SPEAKER jacks of the unit.

Be sure to match the speaker cords to the appropriate terminals on the speakers: the speaker cord with the color tube to  $\oplus$ , and the speaker cord without the color tube to  $\ominus$ . Do not catch the speaker cord insulation (rubber covering) in the speaker terminals.

## To connect speaker cords to the unit

When connecting to the unit, insert the connector until it clicks.

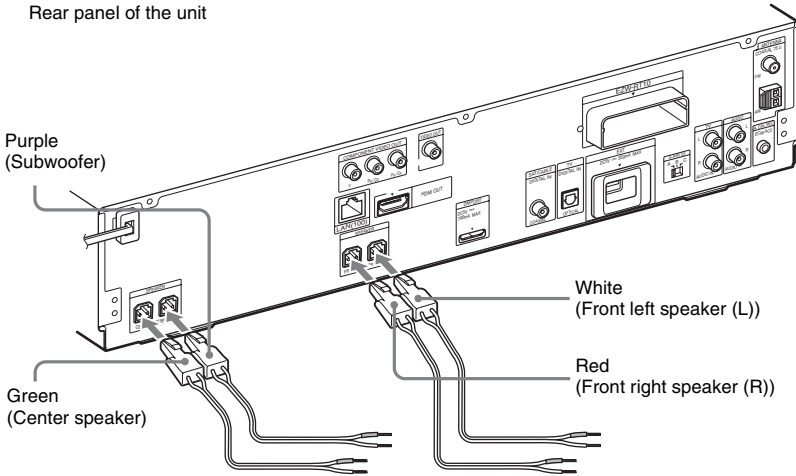

Rear panel of the surround amplifier

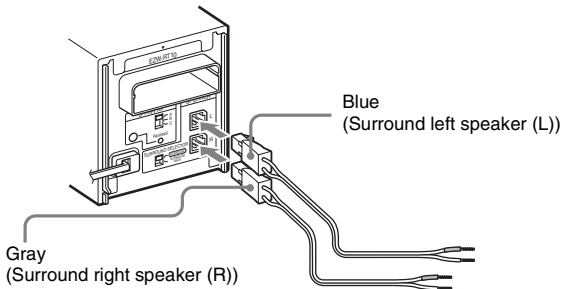

## To connect speaker cords to the speaker

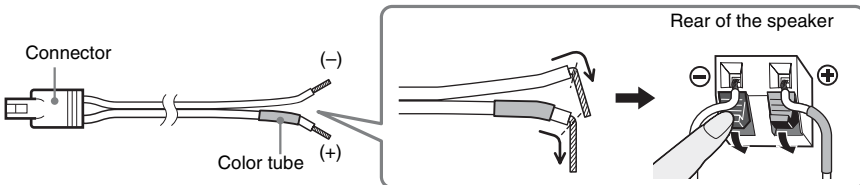

## Connecting the TV (Video connection)

This connection sends a video signal to the TV.  
Depending on the jacks on your TV, select the connection method.

Rear panel of the unit

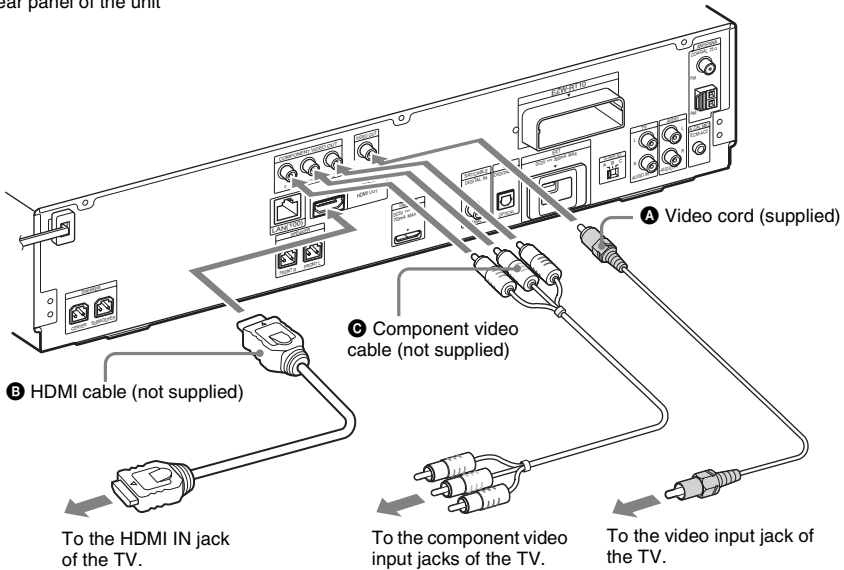

### Method 1: Video cord (A) connection

This is the basic connection.

### Method 2: HDMI\* cable (B) and video cord (A) connection

If your TV has an HDMI jack, connect to the TV both with an HDMI cable and video cord. Picture quality will be improved compared to using only the video cord connection.

When connecting with the HDMI cable, you need to select the type of output signal (pages 34, 81).

To view images from the DIGITAL MEDIA PORT adapter, you need to connect to the TV with the video cord. Video signals from the DIGITAL MEDIA PORT adapter are not output via the HDMI OUT jack.

\* HDMI (High-Definition Multimedia Interface)

### Method 3: Component video cable (C) and video cord (A) connection

If your TV does not have an HDMI jack, but has component video input jacks, connect to the TV both with a component video cable and video cord. Picture quality will be improved compared to using only the video cord connection.

When connecting with the component video cable, you need to select the type of output signal (pages 34, 81).

To view images from the DIGITAL MEDIA PORT adapter, you need to connect to the TV with the video cord. Video signals from the DIGITAL MEDIA PORT adapter are not output via the COMPONENT VIDEO OUT jack.



## Connecting the TV (Audio connection)

This connection sends an audio signal to the unit from the TV. To listen to TV sound via the system, perform this connection.

Rear panel of the unit

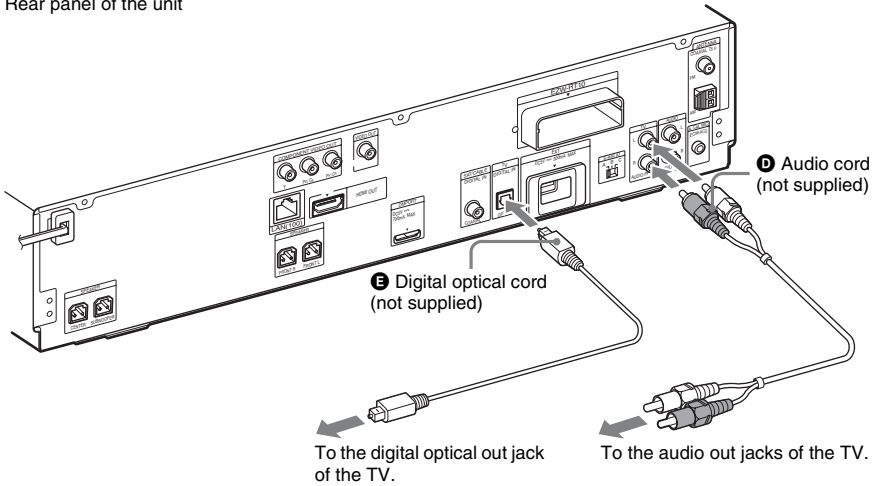

### Method 1: Audio cord (D) connection

This is the basic connection and sends an analog audio signal.

### Method 2: Digital optical cord (E) connection

When the TV has a digital optical output jack, you can improve sound quality by connecting with a digital optical cord in addition to an audio cord connection.

With a digital audio connection, the system receives a Dolby Digital multiplex broadcast signal and you can enjoy multiplex broadcast sound.

#### Note

- The system can accept both digital and analog signals. Digital signals have priority over analog signals. If the digital signal ceases, the analog signal will be processed after 2 seconds.

## Connecting the other components

You can enjoy connected components via the system's speakers.

- DIGITAL MEDIA PORT adapter: **F** (TDM-iP20 is supplied. You can also use other DIGITAL MEDIA PORT adapters.)
- VCR, digital satellite receiver, PlayStation, or portable audio source, etc. (not supplied): **G**
- VCR or digital satellite receiver, etc. (not supplied) which has a digital coaxial output jack: **H**

Rear panel of the unit

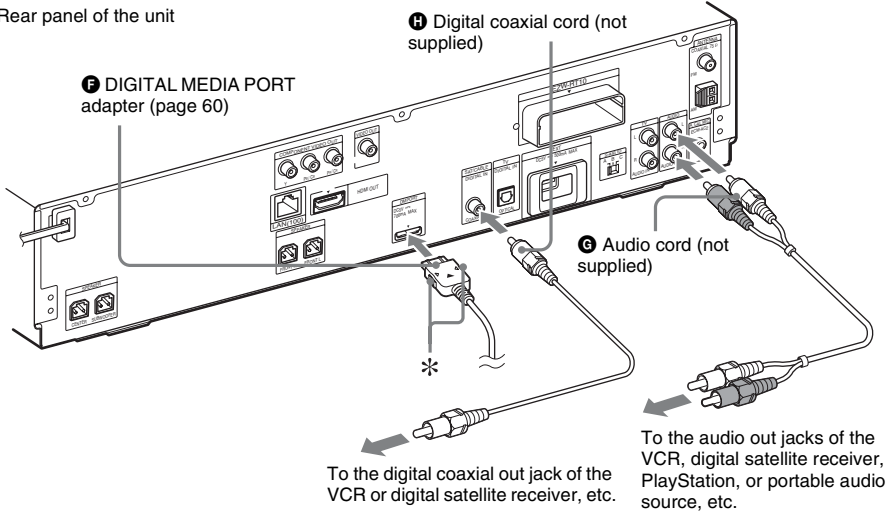

### Note

- Connect the DIGITAL MEDIA PORT adapter so that the ▼ marks are aligned. When disconnecting, pull out while pressing \*.

### If your TV has multiple audio/video inputs

You can enjoy sound with the speakers of the system through the connected TV. Connect the components as follows.

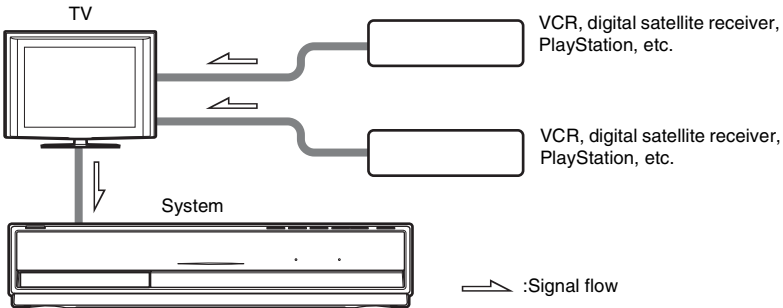

Select the component on the TV. For details, refer to the operating instructions of the TV.

If the TV does not have multiple audio/video inputs, a switcher will be necessary to receive sound from more than one component.

## Connecting the antenna (aerial)

### To assemble the AM loop antenna (aerial)

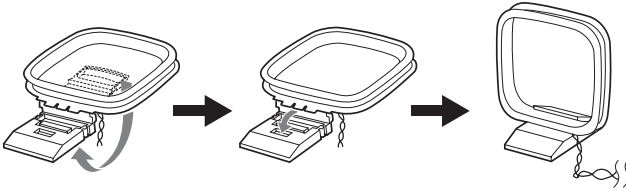

### To connect the antenna (aerial)

Rear panel of the unit

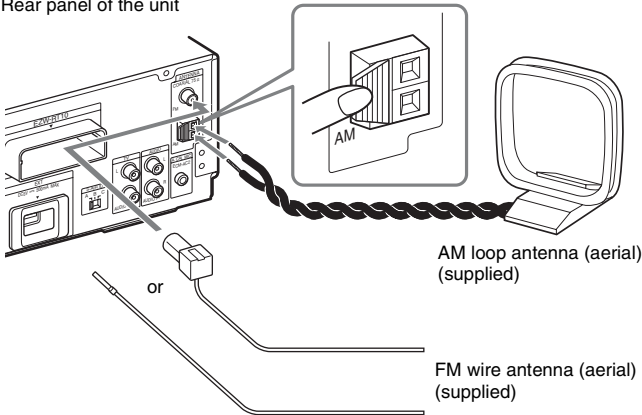

#### Note

- Keep the AM loop antenna (aerial) and cord away from the system or other AV components, as noise may result.
- Be sure to fully extend the FM wire antenna (aerial).
- After connecting the FM wire antenna (aerial), keep it as horizontal as possible.

#### Tip

- Adjust the direction of the AM loop antenna (aerial) for best AM broadcast sound.
- If you have poor FM reception, use a 75-ohm coaxial cable (not supplied) to connect the unit to an outdoor FM antenna (aerial) as shown below.

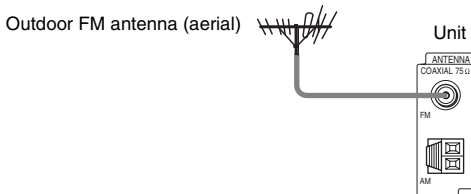

## Inserting the wireless transceiver

You can transmit sound from the unit to an S-AIR product, such as the surround amplifier or S-AIR receiver.

To transmit sound from the unit, you need to insert the wireless transceivers into the unit and S-AIR product.

For details of S-AIR products, see “Using an S-AIR Product” (page 61).

Rear panel of the unit

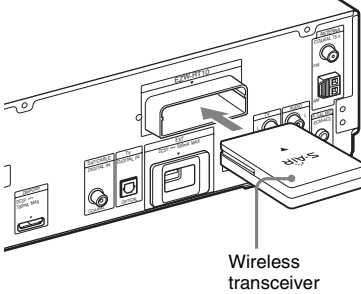

Rear panel of the surround amplifier

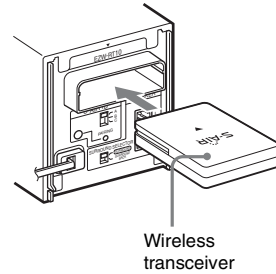

## Inserting the external memory

Insert the external memory device (1 GB or larger USB flash memory, such as Sony USM2GL, USM4GL, or USM1GH, not supplied) into the EXT slot. Check that “EXT” lights up in the front panel display when turning the system on. By connecting an external memory, you can enjoy additional contents (BonusView/BD-Live) depending on the disc (page 48).

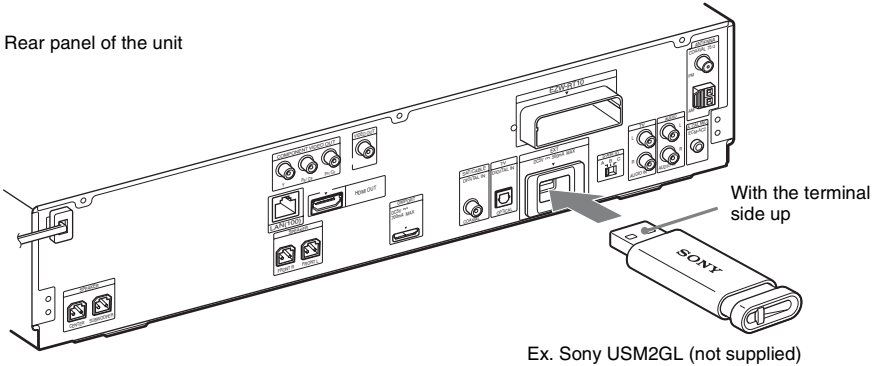

### Note

- Insert the external memory into the EXT slot as far as it will go.
- Insert the external memory straight. If you force the external memory into the slot, this will cause damage to both the external memory and the unit.
- Keep the external memory away from small children to prevent them from accidentally swallowing it.
- Do not apply too much pressure to the external memory in the slot, as it may cause a malfunction.
- To avoid data corruption or damage to the external memory, turn the system off when inserting or removing the external memory.
- Do not insert an external memory that contains photo or music files to avoid corrupting the external memory data.

### To remove the external memory

- 1** Press **I/⏻** to turn the system off.
- 2** Pull out the external memory from the EXT slot.

## Connecting to the network

Connect the LAN (100) terminal of the unit to your Internet source using a network cable to update the system's software using the network. You can also enjoy BD-Live (page 48).  
Make the appropriate settings in [Internet Settings] under [Network Settings] (page 88).

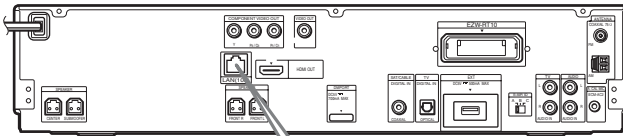

Rear panel of the unit

### When connecting to a broadband router directly

### When connecting via a wireless LAN router

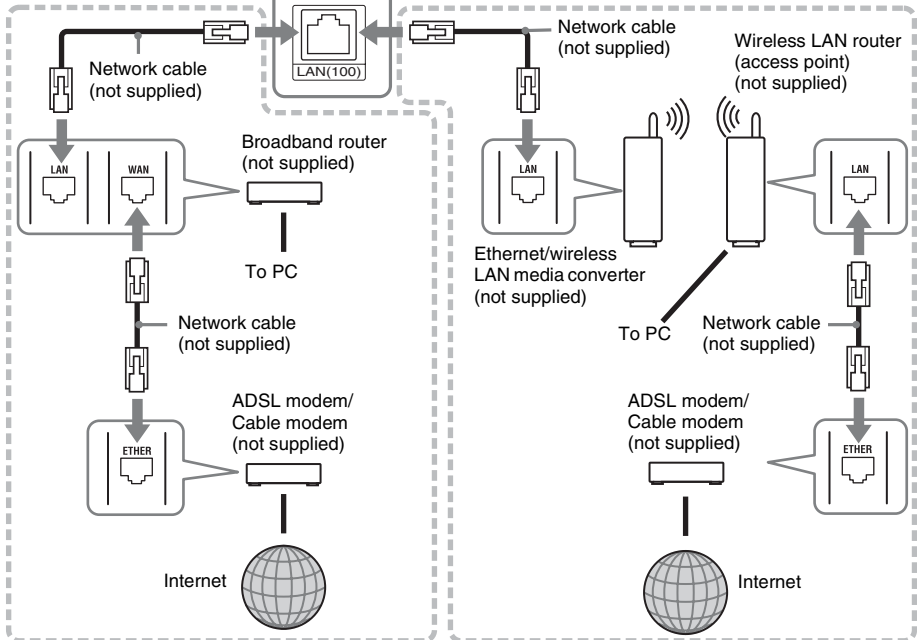

### To update the system's software using the network

See [Network Update] (page 79) and [Software Update Notification] (page 87).

#### Note

- Do not connect a phone line to the LAN (100) terminal, as it may cause a malfunction.
- Do not connect the LAN terminal of the unit to the LAN terminal of the PC.
- Depending on the modem or router, the type of network (LAN) cable, straight or crossing, differs. For details on the network (LAN) cables, refer to the operating instructions supplied with the modem or router.
- For optimal performance of BD-Live functions, we recommend using an Internet connection with an effective speed of 1 Mbps or greater.

## Connecting the AC power cords (mains leads)

Before connecting the AC power cords (mains leads) of the unit and the surround amplifier to a wall outlet (mains), connect the front, center speakers and subwoofer to the unit and surround speakers to the surround amplifier.

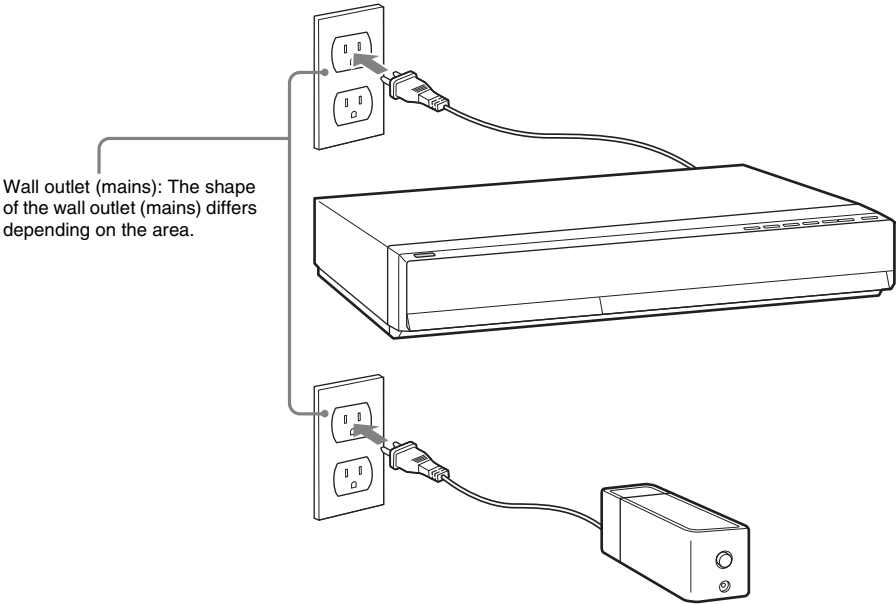

### To turn off the demonstration mode (Except for U.S. models)

After connecting the AC power cord (mains lead), the demonstration appears in the front panel display. You can turn off the demonstration simply by pressing **I/⏻** on the remote. For details, see “About the demonstration” (page 76).

### To turn the system on/off (standby mode)



Press **I/⏻**.

## Step 3: Setting up the Wireless System

To use the wireless system, you need to set up the surround amplifier. Before setting, make sure that the wireless transceivers are inserted into the unit and the surround amplifier correctly (page 28).

This wireless system is called “S-AIR.” For details of the S-AIR function, see “Using an S-AIR Product” (page 61).

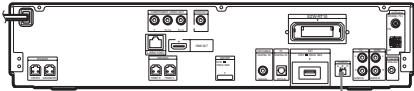

S-AIR ID switch

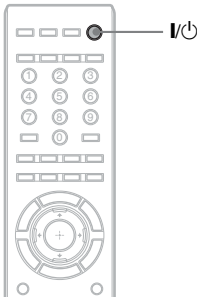

POWER / ON LINE Indicator

POWER

S-AIR ID switch

PHONES jack

SURROUND SELECTOR switch

The unit transmits sound to the surround amplifier that is connected to the surround speakers. To establish sound transmission, perform the following Steps.

- 1** Set the S-AIR ID switch of the unit to A.
- 2** Press I/⏻.

The system turns on.

- 3** Set the SURROUND SELECTOR switch of the surround amplifier to SURROUND.
- 4** Set the S-AIR ID switch of the surround amplifier to A.
- 5** Press POWER on the surround amplifier.

The POWER / ON LINE indicator turns green. If it doesn't, check the transmission status as follows.

### To check the transmission status

You can check the status of sound transmission between the unit and surround amplifier by observing the POWER / ON LINE indicator of the surround amplifier.

POWER / ON LINE indicator	Status
Turns green.	Sound transmission is established.
Flashes green.	Sound transmission is not established.
Turns red.	The surround amplifier does not output sound.
Turns off.	The surround amplifier turns off or its protection is active.

For details of the surround amplifier, see “Surround amplifier operation” (page 99).

### To enjoy sound by using headphones

You can enjoy the system's sound by connecting the headphones to the PHONES jack on the surround amplifier.

#### Note

- The volume of the unit may become minimum if you turn off the surround amplifier while the headphones are connected to the surround amplifier, or radio reception is poor. In this case, “HP NO LINK” and “VOLUME MIN” appear alternately in the front panel display. Check radio reception, and set the volume again.
- When you connect the headphones to the surround amplifier, sound is not output from the system's speakers.



## When you use multiple S-AIR products

See “Establishing sound transmission between the unit and S-AIR sub unit (ID setting)” (page 61).

### To attach the cover to the surround amplifier

After connecting and setting, you can attach the cover to the surround amplifier for organizing and storing excess speaker cords.

- 1 Attach the speaker cord cover by sliding it down along the grooves at the edges of the surround amplifier.**

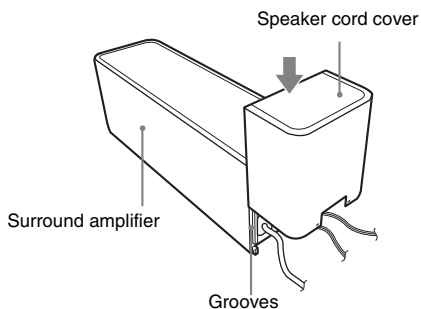

Push the speaker cord cover down until you hear a click. Turn the surround amplifier upside down, then store the cords in the speaker cord cover.

- 2 Insert the tabs of the speaker cord holder in the slots of the speaker cord cover, and press it into place.**

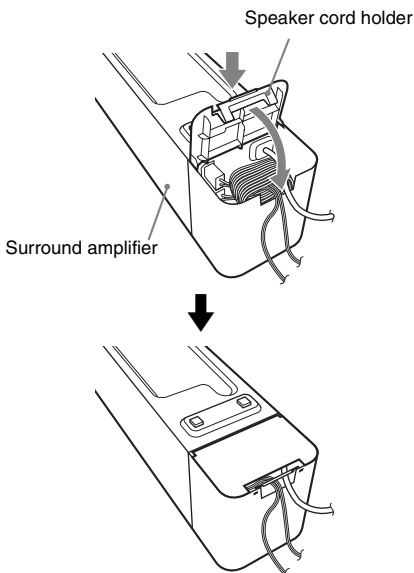

## Step 4: Performing the Easy Setup

Follow the Steps below to make the basic adjustments for using the system.  
Displayed items vary depending on the country model.

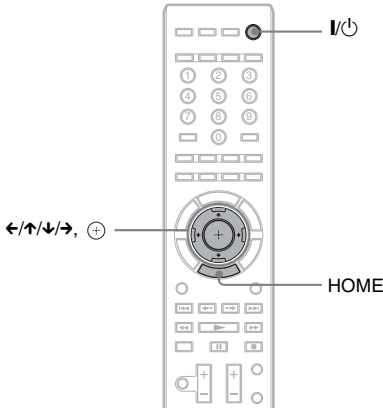

- 1 Turn on the TV.
- 2 Press **I/⏻** on the unit, and **POWER** on the surround amplifier.
- 3 Switch the input selector on your TV so that the signal from the system appears on the TV screen.

The Easy Setup Display for OSD language selection appears.

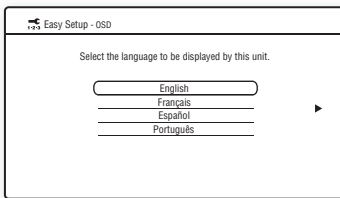

### If the Easy Setup Display does not appear

Recall the Easy Setup Display. See “To recall the Easy Setup Display” (page 37).

- 4 Press **↑/↓** to select a language for the OSD.

- 5 Press **+** or **→**.

The setting message appears.

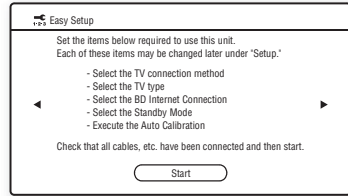

This message appears only when performing the [Easy Setup] for the first time. It does not appear when performing the [Easy Setup] accessed via the [Setup] setting.

- 6 Press **+** or **→**.

The Setup Display for video cable selection appears.

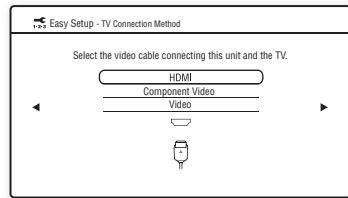

- 7 Press **↑/↓** to select the cable used to connect the unit and TV.

Check the connection of the unit and TV (page 24).

- When you connect the unit and TV with an HDMI cable, select [HDMI], go to Step 8 and set the video output resolution to match your TV.
- When you connect the unit and TV with a component video cord, select [Component Video], go to Step 8 and set the video output resolution to match your TV.
- When you connect the unit and TV with the video cord, select [Video] and go to Step 9.

**Note**

- When you do not connect the unit and TV with an HDMI cable, you cannot select [HDMI].
- When connecting the HDMI OUT jack and other video output jacks at the same time, select [Component Video].
- For details about video output resolution, see “Video Output Resolution” (page 104).

**8 Press  $\oplus$  or  $\rightarrow$ .**

The Setup Display for video output resolution selection appears. For details, see [Output Video Format] (page 81).

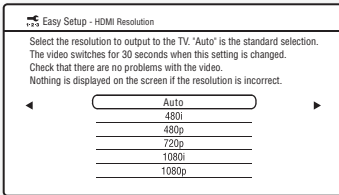
**When you select [HDMI] in Step 7**

Select from [Auto], [480i], [480p], [720p], [1080i], or [1080p].

When connecting the HDMI OUT jack and other video output jacks at the same time, video signals may only output from the HDMI OUT jack when [Auto] or [1080p] is selected.

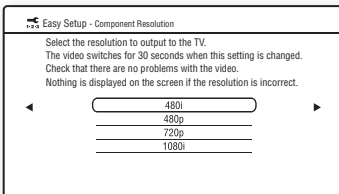
**When you select [Component Video] in Step 7**

Select from [480i], [480p], [720p], or [1080i].

**When you change the video output resolution**

A picture is displayed in the selected resolution for about 30 seconds, then the display asks for confirmation.

Follow the on-screen instructions and go to the next step.

**Note**

- If the picture is distorted or no picture appears, wait for about 30 seconds without pressing any buttons. [Is this resolution OK?] appears. Select [Cancel]. The display returns to the resolution setting screen.
- If the selected video output resolution is incorrect, no picture appears on the screen. In this case, press and hold  $\blacktriangleright$  and  $\blacktriangle$  on the unit for more than 5 seconds to reset the video output resolution to the lowest resolution. To change the video output resolution, set [Output Video Format] in [Video Settings] (page 81).

**9 Press  $\oplus$  or  $\rightarrow$ .**

The Setup Display for selecting the aspect ratio of the TV to be connected appears.

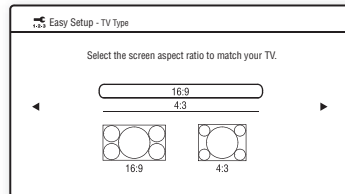
**10 Press  $\uparrow/\downarrow$  to select the setting that matches your TV type.**

- [16:9]: If you have a wide-screen TV or a 4:3 standard TV with a wide-screen mode. (page 80)
- [4:3]: If you have a 4:3 standard TV. (page 80)

**11 Press  $\oplus$  or  $\rightarrow$ .****When you connect the unit and TV with an HDMI cable**

The Setup Display for the [Control for HDMI] function appears. Go to Step 12.

**When you do not connect the unit and TV with an HDMI cable**

The Setup Display for [BD Internet Connection] appears. Go to Step 14.

- 12** Press  $\uparrow/\downarrow$  to select the setting for the **Control for HDMI** function.

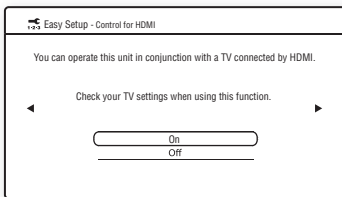

Select [On] to use the [Control for HDMI] function (page 67) when connecting Sony components that are compatible with the Control for HDMI function.

If you do not use the [Control for HDMI] function, select [Off].

- 13** Press  $\oplus$  or  $\rightarrow$ .

The Setup Display for [BD Internet Connection] appears.

- 14** Press  $\uparrow/\downarrow$  to select the setting for the **BD Internet connections**.

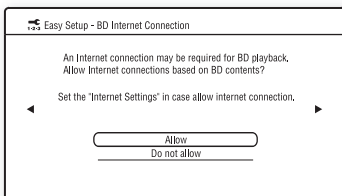

Select [Allow] to allow Internet connections.

If you do not allow the connections, select [Do not allow].

- 15** Press  $\oplus$  or  $\rightarrow$ .

The Setup Display for [Standby Mode] appears.

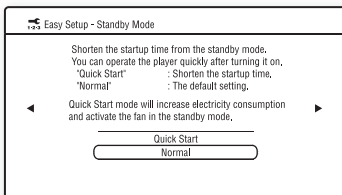

- 16** Press  $\uparrow/\downarrow$  to select the **standby mode**.

You can operate the player quickly after turning on this function.

Select [Quick Start] if you want to shorten the startup time from the standby mode. The default setting is [Normal].

**Note**

- Quick Start mode will increase electricity consumption in the standby mode.

- 17** Press  $\oplus$  or  $\rightarrow$ .

The Setup Display for [Auto Calibration] appears.

- 18** **Connect the calibration mic to the A.CAL MIC jack on the rear panel.**

Set up the calibration mic at ear level using a tripod, etc. (not supplied). The front of each speaker should face the calibration mic, and there should be no obstruction between the speakers and the calibration mic.

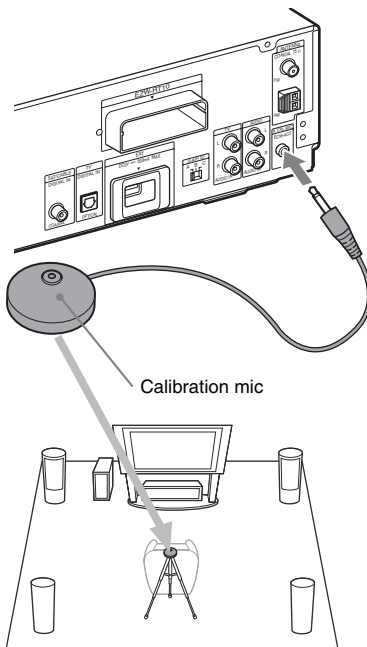

- 19** Press  $\uparrow/\downarrow$  to select [Start].

To cancel, select [Cancel].

**20** Press  $\oplus$ .

[Auto Calibration] starts.

The system adjusts the speaker setting automatically.

Be quiet during the measurement.

**Note**

- Loud test sound is output when [Auto Calibration] starts. You cannot turn the volume down. Give consideration to children and neighbors.
- Before [Auto Calibration], install the surround amplifier in the appropriate location. If you install the surround amplifier in an improper location, such as another room, proper measurement will not be obtained.
- When you use the Wireless Surround Speaker Kit (WAHT-SBP1, optional) for the surround back speakers (page 17), install the speakers in appropriate location and turn the surround amplifier on.

**21** Confirm the conclusions of [Auto Calibration].

The conclusions appear on the TV screen. Press  $\leftarrow/\rightarrow$  to change the page. The first page shows the distance of speakers. The second page shows the level of speakers. If the conclusions are OK, unplug the calibration mic and press  $\uparrow/\downarrow$  to select [OK].

**Note**

- The environment of the room in which the system is installed may affect measurements.

**Tip**

- You can change a measurement unit (feet or meters) by pressing the color button (RED).

**22** Press  $\oplus$ .

Easy Setup is finished. All connections and setup operations are complete.

**To quit the Easy Setup**

Press HOME in any Step.

**To recall the Easy Setup Display****1** Press HOME.

The home menu appears on the TV screen.

**2** Press  $\leftarrow/\rightarrow$  to select  [Setup].**3** Press  $\uparrow/\downarrow$  to select [Easy Setup], then press  $\oplus$ .**4** Press  $\leftarrow/\rightarrow$  to select [Start], then press  $\oplus$ .

The Easy Setup display appears.

## Step 5: Selecting the Source

You can select the playback source.

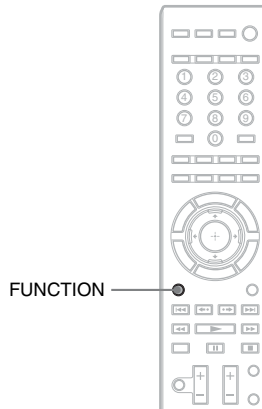

**Press FUNCTION repeatedly until the desired function appears in the front panel display.**

Each time you press FUNCTION, the function changes as follows.

“BD/DVD” → “TUNER FM” → “TUNER AM” → “TV” → “SAT/CABLE” → “DMPORT” → “AUDIO” → ...

Function	Source
“BD/DVD”	Disc that is played by the system
“TUNER FM”/ “TUNER AM”	FM/AM radio (page 56)
“TV”	TV (component that is connected to the TV (AUDIO IN L/R) jacks or TV (DIGITAL IN OPTICAL) jack on the rear panel (page 25))
“SAT/CABLE”	Component that is connected to the SAT/CABLE (DIGITAL IN COAXIAL) jack on the rear panel (page 26)
“DMPORT”	DIGITAL MEDIA PORT adapter (page 60)
“AUDIO”	Component that is connected to the AUDIO (AUDIO IN L/R) jacks on the rear panel (page 26)

## Step 6: Enjoying Surround Sound

You can enjoy surround sound simply by selecting one of the system's pre-programmed decoding modes. They bring the exciting and powerful sound of movie theaters into your home.

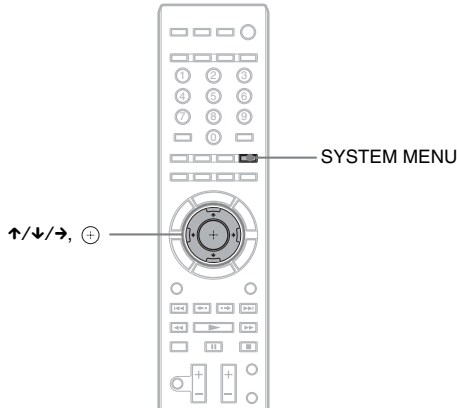

### Selecting surround sound effects based on your listening preference

- 1** Press **SYSTEM MENU**.
- 2** Press **↑/↓** repeatedly until "AUDIO MENU" appears in the front panel display, then press **⊕** or **→**.
- 3** Press **↑/↓** repeatedly until "DEC. MODE" appears in the front panel display, then press **⊕** or **→**.
- 4** Press **↑/↓** repeatedly until the surround sound effect you want appears in the front panel display.

See the table below for surround sound effect descriptions.

- 5** Press **⊕**.  
The setting is made.
- 6** Press **SYSTEM MENU**.  
The system menu turns off.

## About speaker output

The table below describes the options when you connect all the speakers to the unit.

The default setting is “A.F.D. 7.1CH” (when connecting the headphones to the surround amplifier, the default setting is “HP 2CH”).

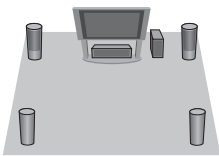
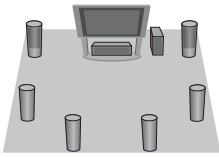
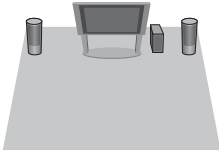
Sound from	Surround effect	Effect
Depending on the source.	“A.F.D. STD” (AUTO FORMAT DIRECT STANDARD)	The system discriminates the sound format of the source and presents sound as it was recorded/encoded.
	“A.F.D. 7.1CH” (AUTO FORMAT DIRECT 7.1CH) “PRO LOGIC” “PLII MOVIE” “PLII MUSIC”	<ul style="list-style-type: none"> <li>• 2 channel source: The system simulates surround sound from 2 channel sources and outputs sound from the 5.1 channel speakers. <ul style="list-style-type: none"> <li>– “A.F.D. 7.1CH” outputs sound from the 5.1 channel speakers by duplicating 2 channel source sound across each speaker.</li> <li>– “PRO LOGIC” performs Dolby Pro Logic decoding.</li> <li>– “PLII MOVIE” performs Dolby Pro Logic II movie mode decoding.</li> <li>– “PLII MUSIC” performs Dolby Pro Logic II music mode decoding.</li> </ul> </li> <li>• Multi-channel source: The system outputs sound from the speakers depending on the number of channels of the source. “A.F.D. 7.1CH” creates the surround back sound virtually and gives you the sound as 7.1 channel surround sound.</li> </ul>
	“A.F.D. 7.1CH” (AUTO FORMAT DIRECT 7.1CH) “PLIIx MOVIE” “PLIIx MUSIC”	<p>These decoding modes appear only when you use the Wireless Surround Speaker Kit (WAHT-SBP1, optional) for the surround back speakers (page 17).</p> <ul style="list-style-type: none"> <li>• 2 channel source: The system simulates surround sound from 2 channel sources and outputs sound from all the speakers including the surround back speakers. <ul style="list-style-type: none"> <li>– “A.F.D. 7.1CH” outputs sound from the 7.1 channel speakers by duplicating 2 channel source sound across each speaker.</li> <li>– “PLIIx MOVIE” performs Dolby Pro Logic IIx movie mode decoding.</li> <li>– “PLIIx MUSIC” performs Dolby Pro Logic IIx music mode decoding.</li> </ul> </li> <li>• Multi-channel source: The system outputs sound from the speakers depending on the number of channels of the source.</li> </ul>
	“2CH STEREO”	The system outputs the sound from the front speakers and subwoofer regardless of sound format or number of channels. Multi-channel surround formats are downmixed to 2 channels.

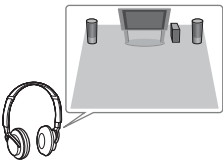
Sound from	Surround effect	Effect
	“HP 2CH” <sup>2)</sup> (HEADPHONE 2 CHANNEL STEREO)	This decoding mode appears only when you connect headphones to the surround amplifier (page 32). The system outputs the sound from the headphones regardless of sound format or number of channels. Multi-channel surround formats are downmixed to 2 channels.

## To turn the sound effect off

Select “A.F.D. STD” for “DEC. MODE.”

### Note

- When you select “A.F.D. 7.1CH,” depending on the disc or source, the beginning of the sound may be cut off while the optimum mode is automatically selected. To avoid cutting the sound, select “A.F.D. STD.”
- When the input signal is multi-channel source, “PRO LOGIC,” “PLII MOVIE,” and “PLII MUSIC” are canceled and the multi-channel source is output directly.
- When the bilingual broadcast sound is input, “PRO LOGIC,” “PLII MOVIE,” and “PLII MUSIC” are not effective.
- “A.F.D. 7.1CH,” “PRO LOGIC,” “PLII MOVIE,” “PLII MUSIC,” “PLIIX MOVIE,” and “PLIIX MUSIC” are canceled when you set the sound mode (page 52) to either of the following settings.
  - “SPORTS”
  - “OMNI-DIR”
  - “MOVIE-D.C.S.-”
- Depending on the input stream, the decoding mode may not be effective.
- When changing the decoding mode while using the S-AIR receiver, sound from the S-AIR receiver may skip.

### Tip

- The system memorizes the last decoding mode selected for each function. Whenever you select a function such as “BD/DVD” or “TUNER FM,” the decoding mode that was last applied to the function is automatically applied again. For example, if you select “BD/DVD” with “PRO LOGIC” as the decoding mode, then change to another function, and then return to “BD/DVD,” “PRO LOGIC” will be applied again.



# Playing a BD/DVD

**BD** **DVD**

Depending on the disc, some operations may be different or restricted. Refer to the operating instructions supplied with your disc.

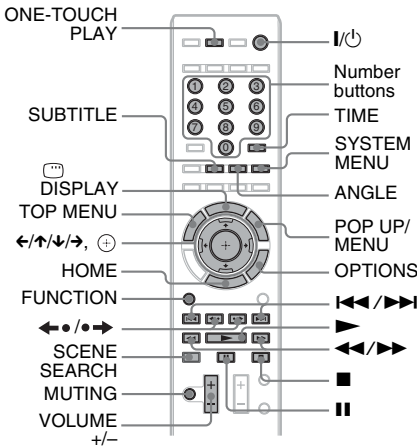
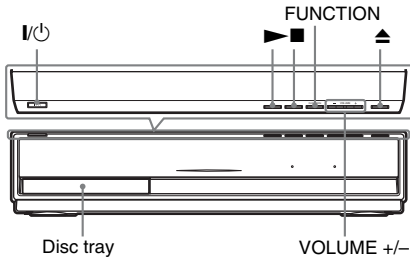

- 1** Turn on your TV.
- 2** Switch the input selector on the TV to this system.
- 3** Press I/⏻. The system turns on.
- 4** Press FUNCTION repeatedly until "BD/DVD" appears in the front panel display.

**5** Press ▲.

**6** Place a disc.

Place one disc on the disc tray, and then press ▲.

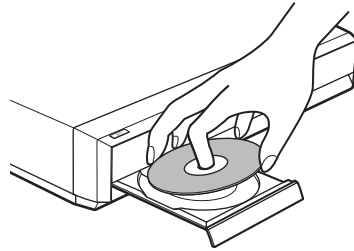

When you insert a commercially available BD-ROM or DVD VIDEO, playback may automatically start depending on the disc. In this case, go to Step 9.

**Note**

- When you play an 8 cm disc, place it on the inner circle of the tray. Be careful that the disc is not skewed on the inner circle of the tray.
- Do not place more than one disc on the tray.

**7** Press <-/> to select [Video].

**8** Press <+> to select ●, then press ▶ or ⊕.

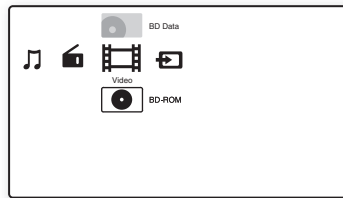

For commercially available BD-ROM or DVD VIDEO, playback starts.

For a BD or DVD recorded on other equipment, the title list appears. Press <+> to select the desired title, then press ▶ or ⊕.

Playback starts.

**9** Press VOLUME +/- to adjust the volume.

The volume level appears on the TV screen and in the front panel display.

**Note**

- When you set the [Control for HDMI] function to [On], the TV that is connected to the system with an HDMI cable can be sync-operated with the system. For details, see “Using the Control for HDMI Function for “BRAVIA” Sync” (page 67).

**Tip**

- You can change the speed at which the volume is turned up and down. To turn the volume up/down quickly, press and hold VOLUME +/- . To set the volume up/down precisely, press VOLUME +/- briefly.

**Other operations**

To	Press
Stop	■
Pause	
Resume play after pause	or ►
Go to the next chapter	►►
Go back to the preceding chapter	◄◄ twice in a second. When you press ◄◄ once, you can go to the beginning of the current chapter.
Turn off the sound temporarily	MUTING To cancel, press it again or VOLUME + to adjust the sound volume.
Remove the disc	▲ on the unit.
Locate a point quickly by playing a disc in fast forward or fast reverse (Scan) <sup>1)</sup>	►► or ◄◄ while playing a disc. Each time you press ►► or ◄◄ during scan, the playback speed changes as follows:  Playback direction ►►1 (×10) → ►►2 (×30) → ►►3 (×120) Reverse direction ◄◄1 (×1) → ◄◄2 (×30) → ◄◄3 (×120)
	When you press and hold the button, fast forward/fast reverse continues at the selected speed until you release the button. To return to normal speed, press ► . Actual speeds may differ with some discs.

To	Press
Play in slow, freeze frame (playback direction only)	►► for more than one second in pause mode. When you press ►► briefly in pause mode, you can play one frame at a time. Depending on the disc, this function may not work. To return to normal playback, press ► .
Replay the previous scene <sup>2)</sup>	◄◄ (instant replay) during playback.
Briefly fast forward the current scene <sup>3)</sup>	►► (instant advance) during playback.

<sup>1)</sup>Scan speeds may differ with some discs.

<sup>2)</sup>BD/DVD VIDEO/DVD-RW/DVD-R only.

<sup>3)</sup>BD/DVD VIDEO/DVD-RW/DVD-R/DVD+RW/DVD+R only.

**To play a restricted BD or DVD (Parental Control)****When you play a restricted BD**

Change [BD Parental Control] in [BD/DVD Viewing Settings] (page 84).

**When you play a restricted DVD**

Change [DVD Parental Control] in [BD/DVD Viewing Settings] (page 84).

When you play a restricted BD or DVD, the display for entering your password appears on the screen.

Enter your four-digit password using the number buttons, and press ⊕ . Playback starts.

To register or change the password, see [Password] (page 85).

**To play a restricted BD-RE or BD-R (Disc Lock)**

When you play a BD-RE or BD-R restricted by the Disc Lock function, the display for entering your password appears on the screen.

**1** Enter the four-digit password that has been registered when creating the disc using the number buttons, and press ⊕ .

**2** Select a title, and press ► or ⊕ . Playback starts.

## One-Touch Play (for HDMI connection only)

Press ONE-TOUCH PLAY.

The system and the connected TV turn on and the input selector on the TV is switched to the system; then you can enjoy the contents of a disc.

### Note

- When using the HDMI connection, there may be a delay before the playback picture appears on the screen, and the beginning portion of the playback picture may not be displayed.
- To use this function, set [Control for HDMI] to [On] in [HDMI Settings] (page 86).

## Available OPTIONS

### 1 Press OPTIONS.

The options menu appears.

### 2 Press $\uparrow/\downarrow$ to select an item, then press



The available items differ depending on the disc type or system situation.

Items	Details
[Video Settings]	Adjusts settings for picture (page 47).
[Title List]	Displays the title list.
[Play]	Plays the title from the point where you pressed <b>■</b> .
[Play from beginning]	Plays the title from the beginning.
[Top Menu]	Displays the disc's Top Menu (page 44).
[Menu/Popup Menu]	Displays the BD-ROM's Pop-up Menu or DVD's menu (page 44).
[Stop]	Stops playback.
[Title Search]	Searches for a title and starts playback from the beginning (page 45).
[Chapter Search]	Searches for a chapter and starts playback from the beginning (page 45).

## Changing the angles

**B D**

**DVD**

If various angles (multi-angles) for a scene are recorded on a disc, you can change the viewing angle.

**Press ANGLE during playback to select the desired angle.**

## Displaying the subtitles

**B D**

**DVD**

If subtitles are recorded on a disc, you can turn the subtitles on/off during playback. If multilingual subtitles are recorded on the disc, you can change the subtitle language during playback, or turn the subtitles on/off whenever you want.

**Press SUBTITLE during playback to select the desired subtitle language.**

## Resuming playback from the point where you stopped the disc

### (Resume Play)

**BD** **DVD**

When you stop the disc, the system remembers the point where you pressed **■**. As long as you do not remove the disc, Resume Play will work even if the system is set to standby mode by pressing **I/⏻**.

- 1** While playing a disc, press **■** to stop playback.
- 2** Press **↑/↓** to select **⊙**, then press **▶** or **⊕**.

The system starts playback from the point where you stopped the disc in Step 1.

#### Note

- Depending on where you stop the disc, the system may not resume playback from exactly the same point.
- The point where you stopped playing may be cleared when:
  - you open the disc tray.
  - you play another title.
  - you change the settings on the system.
  - you disconnect the AC power cord (mains lead).
  - you remove the external memory (for BD-ROMs).
- This function may not work properly with some discs.

## To play from the beginning of the title

Press **OPTION** to select [Play from beginning], then press **⊕**. Playback starts from the beginning of the title.

## Using the BD's or DVD's menu

**BD** **DVD**

### To display the Top Menu

A BD/DVD is divided into a lot of sections, which make up a picture or music feature. These sections are called "titles." When you play a BD/DVD which contains several titles, you can select the title you want using the Top Menu. You can also select items such as the language for the subtitles and the language for the sound using the Top Menu.

#### 1 Press TOP MENU.

The disc's menu appears on the TV screen. The contents of the menu vary depending on the disc.

#### 2 Press **←/↑/↓/→** or the number buttons to select the item you want to play or change.

#### 3 Press **⊕**.

### To display Pop-up Menus

Some BD-ROMs contain Pop-up Menus that appear without interrupting playback.

#### 1 Press POP UP/MENU during playback.

The Pop-up Menu appears.

#### 2 Press **←/↑/↓/→**, the color buttons, or number buttons to select the item, and follow the on-screen instructions.

## Searching for a scene quickly

### (Scene Search)

**B D** **DVD**

You can move quickly between scenes within the title currently being played back.

**1** Press **SCENE SEARCH** during playback or in pause mode.

Playback pauses and a bar with a scene indicator (square-shaped – indicates the current point) appears at the bottom of the screen.

**2** Press and hold **←/→** or **◀/▶** to move the scene indicator to the scene you are searching for.

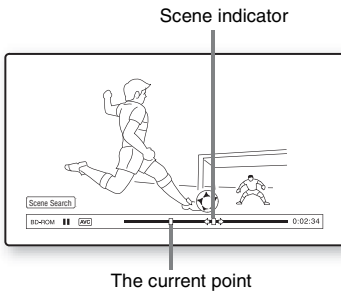

The scene indicator on the bar is displayed around the playing point.

**3** Release the button at the point you want to watch.

The scene at which you released the button is displayed in pause mode.

To search for a scene again, move the scene indicator using **←/→** or **◀/▶**.

**4** Press **SCENE SEARCH**, **+**, **▶**, or **II**. Playback starts.

### To cancel Scene Search mode

Press **SCENE SEARCH**, **+**, **▶**, or **II**.

Playback starts from the point you pressed the button.

#### Note

- The Scene Search function is available for titles longer than 100 seconds and shorter than 100 hours.
- Depending on the disc, this function may not work.

## Searching for a Title/Chapter

**B D** **DVD**

You can search for a chapter if the title contains chapter marks.

**1** Press **OPTIONS** during playback or in pause mode.

The options menu appears.

**2** Press **↑/↓** to select a search method, then press **+**.

- [Title Search] (for a BD-ROM/DVD VIDEO): Searches the desired title.
- [Chapter Search]: Searches the desired chapter.

The display for entering the number appears.

Example: Chapter Search

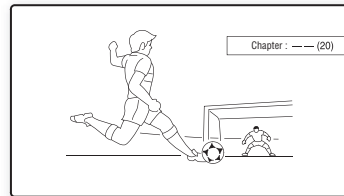

**3** Press the number buttons to enter the number of the title or chapter.

If you make a mistake, press **CLEAR**, and re-enter another number.

**4** Press **+**.

After a while, the system starts playback from the selected number.

### To cancel [Title Search]/[Chapter Search]

Press **RETURN**.

## Displaying the playing time and play information

**B D**

**DVD**

You can check the title information, including the video transmission rate, etc.

Press **DISPLAY** during playback.

The displayed information differs depending on the disc type and system status.

Example: When playing a BD-ROM

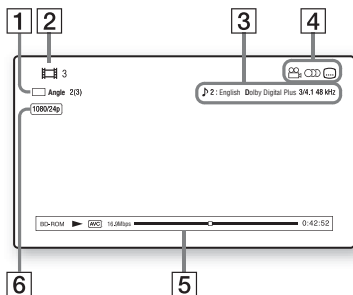

- 1 The current selected angle
- 2 Title number or name
- 3 The currently selected audio setting
- 4 Available functions (angle/audio/subtitle)
- 5 Playback information  
Displays Disc type/Play mode/Video codec/  
Bit rate/Playing status bar/Playing time  
(Remaining time\*)

6 Output resolution/Video frequency

\* Displayed when you press TIME repeatedly.

### Tip

- You can also check the playback information in the front panel display.
- You can change each setting by pressing SUBTITLE, AUDIO, or ANGLE.

## To view the playing time and remaining time in the front panel display

Press **TIME** repeatedly.

Each time you press TIME while playing the disc, the display changes:

① ↔ ②

- ① Playing time of the current title
- ② Remaining time of the current title

Some displayed items may disappear after a few seconds.

## Adjusting pictures for videos

**B D** **DVD**

- 1 Press **OPTIONS** during playback.**  
The options menu appears.
- 2 Press **↑/↓** to select **[Video Settings]**, then press **+**.**  
The **[Video Settings]** screen appears.

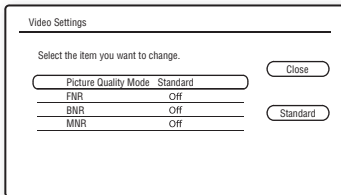

- 3 Press **↑/↓** to select an item, then press **+**.**

### **[Picture Quality Mode]**

Optimizes the picture settings for different lighting environments.

- **[Standard]**
- **[Brighter Room]**
- **[Theater Room]**

### **[FNR]**

Reduces random noise appearing in the picture.

- **[Off]**
- **[Auto]**

### **[BNR]**

Reduces mosaic-like block noise in the picture.

- **[Off]**
- **[Auto]**

### **[MNR]**

Reduces minor noise around the picture outlines (mosquito noise).

- **[Off]**
- **[Auto]**

- 4 Press **←/↑/↓/→** to select or adjust the settings, then press **+**.**

To adjust any other items, repeat steps 3 and 4.

### **Note**

- Set the picture setting of your TV to **[Standard]** before changing **[Picture Quality Mode]**.
- **[Video Settings]** is disabled when the connected TV is set to **Theater Mode** (page 68).
- Depending on the disc or the scene being played, **[FNR]**, **[BNR]**, or **[MNR]** effects may be hard to discern.

## Adjusting the delay between the picture and sound

### **(A/V SYNC)**

**B D** **DVD**

When the sound does not match the pictures on the TV screen, you can adjust the delay between the picture and sound.

- 1 Press **SYSTEM MENU**.**
- 2 Press **↑/↓** repeatedly until “**AUDIO MENU**” appears in the front panel display, then press **+** or **→**.**
- 3 Press **↑/↓** repeatedly until “**A/V SYNC**” appears in the front panel display, then press **+** or **→**.**
- 4 Press **↑/↓** to adjust the delay between the picture and sound.**  
You can adjust from 0 ms to 300 ms in 25 ms increments.
- 5 Press **+**.**  
The setting is made.
- 6 Press **SYSTEM MENU**.**  
The system menu turns off.

### **Note**

- Depending on the input stream, **A/V SYNC** may not be effective.

# Enjoying BonusView/BD-Live

## BD

Some BD-ROMs with “BD-LIVE Logo\*” have bonus contents and other data that can be downloaded to the external memory (local storage) for enjoyment.

\*  BD-LIVE™

- 1** If a disc is inserted, remove the disc from the unit.
- 2** Turn the system off.
- 3** Insert the external memory (not supplied) into the EXT slot on the rear of the unit.  
The external memory is used as the local storage.  
Make sure that the external memory is properly inserted into the unit (page 29).
- 4** Connect the system to a network (page 30).
- 5** Turn the system on.
- 6** Set [BD Internet Connection] to [Allow] in [BD/DVD Viewing Settings] (page 85).
- 7** Insert a BD-ROM with BONUSVIEW/BD-LIVE.

The operation method differs depending on the disc. Refer to the instruction manual supplied with the disc.

## To delete data in the external memory

You can delete unnecessary data.

- 1** If a disc is inserted, remove the disc from the unit.
- 2** Press HOME.
- 3** Press  $\leftarrow/\rightarrow$  to select  [Video].
- 4** Press  $\uparrow/\downarrow$  to select [BD Data], then press  $\oplus$ .

**5** Select the disc name, then press OPTIONS.

**6** Select [Erase], then press  $\oplus$ .

**7** Select [OK], then press  $\oplus$ .

The data of the selected disc will be deleted.

### Note

- Depending on the BD-ROM, the disc name may not be displayed.

### Tip

- To delete all data in the external memory at once, select [Erase All] in Step 6.
- Press  $\oplus$  instead of OPTIONS in Step 5 to skip Step 6.



# Playing a CD

CD

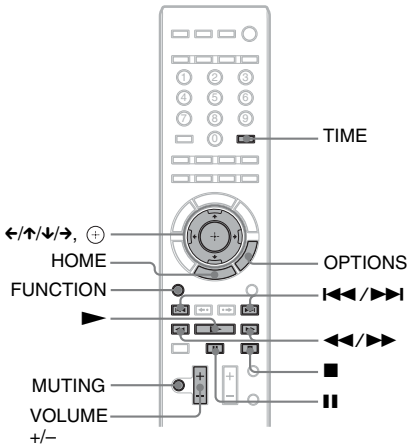

- 1 Press **FUNCTION** repeatedly until “BD/ DVD” appears in the front panel display.
- 2 Insert a CD.  
The Music Player screen appears.
- 3 Press **▶**.  
Playback starts.

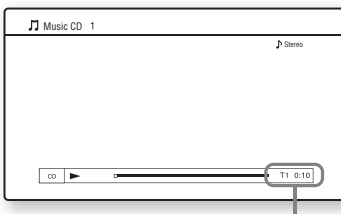

Current track number and elapsed time

- 4 Adjust the volume by pressing **VOLUME +/-**.  
The volume level appears on the TV screen and in the front panel display.

## To select a track

- 1 Press **HOME**.

- 2 Press **←/→** to select **♪ [Music]**.

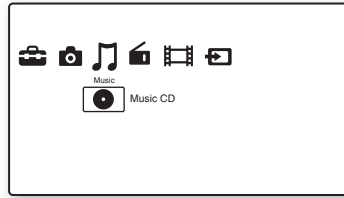

- 3 Press **+**.  
The music list appears.
- 4 Press **↑/↓** to select a track, then press **▶** or **+**.  
The system plays the selected track.

## Other operations

To	Press
Stop	■
Pause	⏸
Resume play after pause	⏸ or ▶
Start playback from the point where you pressed ■.	▶
Go to the next track	▶▶
Go back to the preceding track	◀◀ twice in a second. When you press ◀◀ once, you can go to the beginning of the current track.
Turn off the sound temporarily	MUTING To cancel, press it again or VOLUME + to adjust the sound volume.
Remove the disc	▲ on the unit.
Fast reverse/fast forward	◀◀ or ▶▶ during playback.

## Available OPTIONS

### 1 Press OPTIONS.

The options menu appears.

### 2 Press $\uparrow/\downarrow$ to select an item, then press $\oplus$ .

The available items differ depending on the disc type or system situation.

Items	Details
[Play]	Plays the selected track.
[Play from beginning] (during playback)	Plays the current track from the beginning.
[Play from beginning] (in stop mode)	Plays the selected track from the beginning.
[Stop]	Stops playback.

#### Note

- The point where you stopped playing (resume point) is cleared from memory when:
  - You open the disc tray.
  - You turn the system off.

## To view the playing time and remaining time in the front panel display

### Press TIME repeatedly.

Each time you press TIME while playing the disc, the display changes:

① → ② → ③ → ④ → ① → ...

- Playing time of the current track
- Remaining time of the current track
- Playing time of the disc
- Remaining time of the disc

## Playing Photo Files



<sup>1)</sup>BD-REs/BD-Rs containing JPEG image files

<sup>2)</sup>DVD+RWs/DVD+Rs/DVD-RWs/DVD-Rs containing JPEG image files

<sup>3)</sup>CD-RWs/CD-Rs containing JPEG image files

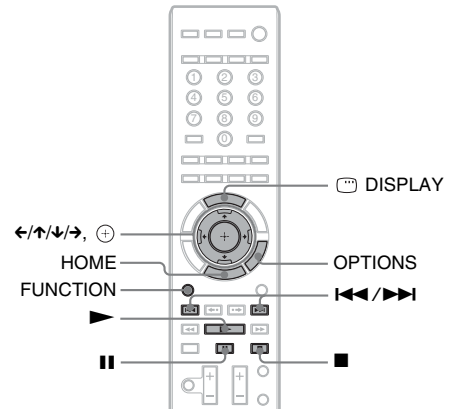

**1** Press **FUNCTION** repeatedly until “BD/DVD” appears in the front panel display.

**2** Insert a disc that contains photo files.

**3** Press **HOME**.

**4** Press  $\leftarrow/\rightarrow$  to select [Photo].

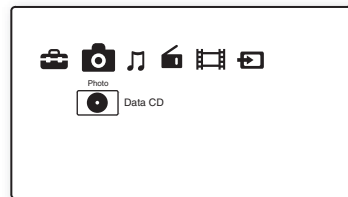

**5** Press  $\oplus$ .

The file list or folder list appears.

**6** Press  $\uparrow/\downarrow$  to select a file or folder, then press  $\oplus$ .

When you select a folder, press  $\uparrow/\downarrow$  to select a file in the folder, then press  $\oplus$ .

The selected photo file is displayed.

## Other operations

To	Press
Play a slideshow	▶
Stop a slideshow	■
Pause a slideshow	
Go to the next photo	▶▶
Go back to the preceding photo	◀◀
Display the file information	☺ DISPLAY

## Available OPTIONS

### 1 Press OPTIONS.

The options menu appears.

### 2 Press ↑/↓ to select an item, then press Ⓡ.

The available items differ depending on the situation.

Items	Details
[Slideshow Speed] <sup>1)2)</sup>	Changes the slideshow speed. <ul style="list-style-type: none"> <li>• [Fast]</li> <li>• [Normal]</li> <li>• [Slow]</li> </ul>
[Stop] <sup>1)</sup>	Stops a slideshow.
[Rotate Left] <sup>1)</sup>	Rotates the photo counterclockwise by 90 degrees.
[Rotate Right] <sup>1)</sup>	Rotates the photo clockwise by 90 degrees.
[View Image] <sup>2)</sup>	Displays the selected picture.
[Slideshow] <sup>2)</sup>	Starts a slideshow.

<sup>1)</sup>Appears when you press OPTIONS during playback of photo files.

<sup>2)</sup>Appears when you press OPTIONS while the file/folder list is displayed.

#### Note

- When you attempt to play the following photo files, the  mark appears on the screen and they cannot be played.
  - Photo files with width or height larger than 8,192 pixels
  - Photo files with width or height smaller than 15 pixels
  - Photo files exceeding 32 MB
  - Photo files with extreme aspect ratios (greater than 50:1 or 1:50)
  - Photo files in Progressive JPEG format
  - Photo files that have a “.jpeg” or “.jpg” extension, but are not in JPEG format
  - Photo files that have an extremely long name
- The following photo files cannot be played.
  - Photo files recorded on BD-Rs in any format other than UDF (Universal Disk Format) 2.6
  - Photo files recorded on BD-REs in any format other than UDF (Universal Disk Format) 2.5
- The following photo files or folders cannot be displayed in the file list or folder list.
  - Photo files that have an extension other than “.jpeg” or “.jpg”
  - Photo files that have an extremely long name
  - Photo files in the 5th tree and photo files/folders in the 6th tree or lower
  - Folders beyond the 500th folder, when the total number of folders and files in a single tree exceeds 500
- Photo files edited on a PC may not be played.
- Thumbnail images of some photo files may not be displayed.
- Large photo files may take some time to display or to start a slideshow.

## To view images in high picture quality

If you have a Sony TV compatible with “PhotoTV HD,” you can enjoy images in high picture quality by the following connection and setting.

### 1 Connect the unit to the TV using an HDMI cable.

### 2 Set the TV's video setting to [VIDEO-A] mode.

For details on [VIDEO-A], refer to the operating instructions supplied with the TV.

# Selecting the Effect to Suit the Source

You can select a suitable sound mode for movies or music.

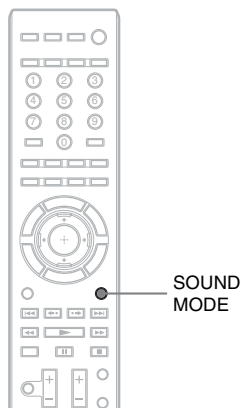

**Press SOUND MODE repeatedly during playback until the desired mode appears in the front panel display.**

- **“AUTO”**: The system selects “MOVIE” or “MUSIC” automatically to produce the sound effect depending on the disc or sound stream.
  - **“MOVIE”**: The system provides the sound for movies.
  - **“MOVIE-D.C.S.-”\***: The system reproduces the sound characteristics of the Sony Pictures Entertainment “Cary Grant Theater” cinema production studio.
  - **“MUSIC”**: The system provides the sound for music.
  - **“SPORTS”**: The system adds reverberation for the sports program.
  - **“NEWS”**: The system provides the sound for the voice program, such as news.
  - **“OMNI-DIR”**: The same sound is audible anywhere in the room.
- \* DCS technology is used.

### Note

- When you connect headphones to the surround amplifier, the sound mode is disabled.
- Depending on the disc or source, when you select “AUTO,” the beginning of the sound may be cut off as the system selects the optimum mode automatically. To avoid cutting the sound, select other than “AUTO.”
- Depending on the input stream, the sound mode may not be effective.
- When changing the sound mode while using the S-AIR receiver, sound from the S-AIR receiver may skip.

# Selecting the Audio Format, Multilingual Tracks, or Channel

When the system is playing a BD/DVD VIDEO recorded in multiple audio formats (PCM, Dolby Digital, MPEG audio, or DTS), you can change the audio format. If the BD/DVD VIDEO is recorded with multilingual tracks, you can also change the language.

With a CD, you can select the sound from the right or left channel and listen to the sound of the selected channel through both the right and left speakers.

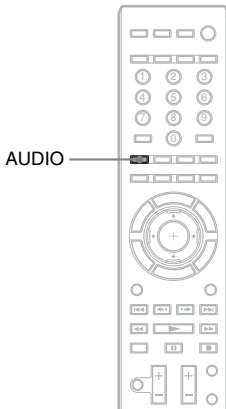

**Press AUDIO repeatedly during playback to select the desired audio signal.**

The audio information appears on the TV screen.

## ■ BD/DVD VIDEO

Depending on the BD/DVD VIDEO, the choice of language varies.

When 4 digits are displayed, they indicate a language code. See “Language Code List” (page 108) to confirm which language the code represents. When the same language is displayed two or more times, the BD/DVD VIDEO is recorded in multiple audio formats.

## ■ DVD-VR

The types of sound tracks recorded on a disc are displayed.

Example:

- [♪ Stereo]
- [♪ Stereo (Audio1)]
- [♪ Stereo (Audio2)]
- [♪ Main]
- [♪ Sub]
- [♪ Main/Sub]

### Note

- [♪ Stereo (Audio1)] and [♪ Stereo (Audio2)] do not appear when only one audio stream is recorded on the disc.

## ■ CD

- [♪ Stereo]: The standard stereo sound.
- [♪ 1/L]: The sound of the left channel (monaural).
- [♪ 2/R]: The sound of the right channel (monaural).

# Enjoying Multiplex Broadcast Sound

## (DUAL MONO)

You can enjoy multiplex broadcast sound when the system receives or plays a Dolby Digital multiplex broadcast signal.

### Note

- To receive the Dolby Digital signal, you need to connect a TV or other component to the unit with an optical or coaxial digital cord (pages 25, 26) and set the digital output mode of the TV or other component to Dolby Digital.

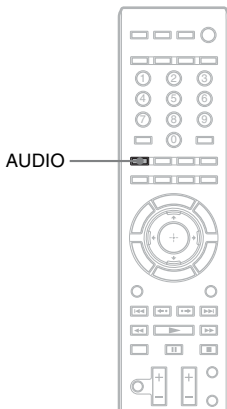

Press **AUDIO** repeatedly until the desired signal appears in the front panel display.

- **“MAIN”**: Sound of the main language will be output.
- **“SUB”**: Sound of the sub language will be output.
- **“MAIN/SUB”**: Mixed sound of both the main and sub languages will be output.

# Using the Sound Effect

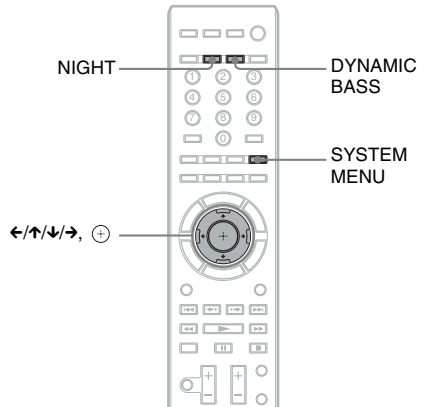

## Reinforcing bass frequencies

You can reinforce bass frequencies.

Press **DYNAMIC BASS**.

“D. BASS ON” appears in the front panel display and bass frequencies are effectively reinforced.

During this mode is on, “BASS” lights up in the front panel display.

**To turn off the sound effect**

Press **DYNAMIC BASS** so that “BASS” disappears from the front panel display.

## Enjoying sound at low volume

You can enjoy sound effects or dialog, as you would in a movie theater, even at low volume. It is useful for watching movies at night.

### Press NIGHT.

“NIGHT ON” appears in the front panel display and the sound effect is activated.

During the night mode is on, “NIGHT” lights up in the front panel display.

#### Note

- When sound is output from the center speaker, this effect is more pronounced, as speech (movie dialog, etc.) is easy to hear. When sound is not output from the center speaker, or you are using the headphones, the system optimally adjusts the volume.

### To turn off the sound effect

Press NIGHT so that “NIGHT” disappears from the front panel display.

## Changing the tonal balance

You can adjust the sound by changing the tonal balance of the sound.

- 1 Press SYSTEM MENU.**
- 2 Press  $\uparrow/\downarrow$  repeatedly until “AUDIO MENU” appears in the front panel display, then press  $\oplus$  or  $\rightarrow$ .**
- 3 Press  $\uparrow/\downarrow$  repeatedly until “TONE” appears in the front panel display, then press  $\oplus$  or  $\rightarrow$ .**
- 4 Press  $\uparrow/\downarrow$  to select the desired setting, then press  $\oplus$ .**
  - “BASS”: You can adjust the bass frequencies.
  - “TREBLE”: You can adjust the treble frequencies.
- 5 Press  $\uparrow/\downarrow$  to adjust the sound.**

The adjusted value appears in the front panel display. You can set the value from -6 to +6.
- 6 Press  $\oplus$ .**

The setting is made.
- 7 Press SYSTEM MENU.**

The system menu turns off.

# Listening to the Radio

You can enjoy radio sound with the system's speakers.

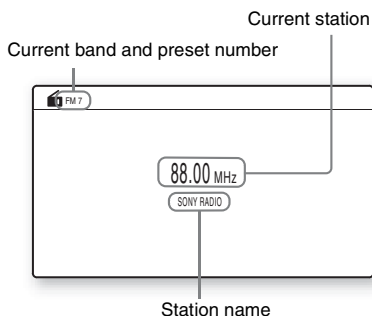
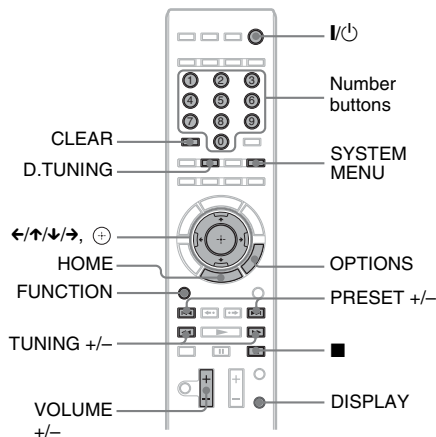

### Tip

- You can operate the tuner function using the tuner menu on the front panel display. See "Operating the tuner function using the system menu" (page 58)

- Press **FUNCTION** repeatedly until "TUNER FM" or "TUNER AM" appears in the front panel display.

- Select the radio station.

### Automatic tuning

Press and hold **TUNING +/-** until the auto scanning starts.

[Auto Tuning] appears on the TV screen. Scanning stops when the system tunes in a station.

To stop the automatic tuning manually, press **TUNING +/-** or **■**.

"TUNED" and "ST" (for stereo program) light up in the front panel display.

### Manual tuning

Press **TUNING +/-** repeatedly.

- Adjust the volume by pressing **VOLUME +/-**.

### To turn off the radio

Press **I/Power**.

### To change the AM tuning interval

- Press **FUNCTION** repeatedly until "TUNER AM" appears in the front panel display.
- Press and hold **▶** and **FUNCTION** on the unit until "AM 9K STEP" or "AM 10K STEP" appears in the front panel display.

### Tip

- To improve reception, reorient the connected antennas (aerials).

### Available OPTIONS

- Press **OPTIONS**.  
The options menu appears.
- Press **↕/↕** to select an item, then press **⊕**.  
The available items differ depending on the situation.

Items	Details
[Preset Memory]	Preset 20 FM stations, 10 AM stations.
[Direct Tuning]	Input station frequency directly.
[FM Mode]	Select monaural or stereo reception of FM programs.



## To view the station name or frequency in the front panel display

When the system is set to “TUNER FM” or “TUNER AM,” you can check the frequency using the front panel display.

### Press DISPLAY.

Each time you press DISPLAY on the remote, the display changes as shown.

① Station name\*

② Frequency\*\*

\* This is displayed if you have entered a name for a preset station.

\*\* Returns to the original display after several seconds have elapsed.

## Presetting radio stations

You can preset 20 FM stations, and 10 AM stations. Before tuning, make sure to turn down the volume to minimum.

**1 Press FUNCTION repeatedly until “TUNER FM” or “TUNER AM” appears in the front panel display.**

**2 Press and hold TUNING +/- until the auto scanning starts.**

[Auto Tuning] appears on the TV screen. Scanning stops when the system tunes in a station.

“TUNED” and “ST” (for stereo program) light up in the front panel display.

**3 Press OPTIONS.**

The options menu appears.

**4 Press  $\uparrow/\downarrow$  to select [Preset Memory], then press  $\oplus$ .**

**5 Press  $\uparrow/\downarrow$  to select the preset number you want.**

**6 Press  $\oplus$ .**

The setting is made.

## To change the preset number

Select the desired preset number by pressing PRESET +/-, then perform the procedure from Step 3.

## Selecting the preset station

**1 Press FUNCTION repeatedly until “TUNER FM” or “TUNER AM” appears in the front panel display.**

The last received station is tuned in.

**2 Press PRESET +/- repeatedly to select the preset station.**

The preset number and frequency appear on the TV screen and front panel display.

Each time you press the button, the system tunes in one preset station.

### Tip

• You can select the preset station number directly by pressing the number buttons.

## Selecting a radio station by inputting a frequency directly

When you know the frequencies, you can select radio stations by inputting the frequencies directly.

**1 Press FUNCTION repeatedly until “TUNER FM” or “TUNER AM” appears in the front panel display.**

**2 Press OPTIONS.**

The options menu appears.

**3 Press  $\uparrow/\downarrow$  to select [Direct Tuning], then press  $\oplus$ .**

**4 Press the number buttons to select the frequencies.**

**5 Press  $\oplus$ .**

The setting is made.

## To operate by using D.TUNING

- 1 Press FUNCTION repeatedly until "TUNER FM" or "TUNER AM" appears in the front panel display.
- 2 Press D.TUNING.



- 3 Press the number buttons to select the frequencies.
- 4 Press ⊕.

## If an FM program is noisy

If an FM program is noisy, you can select monaural reception. There will be no stereo effect, but reception will improve.

- 1 Press OPTIONS.  
The options menu appears.
- 2 Press ↑/↓ to select [FM Mode], then press ⊕.
- 3 Press ↑/↓ to select [Monaural].
  - [Stereo]: Stereo reception.
  - [Monaural]: Monaural reception.
- 4 Press ⊕.  
The setting is made.

## Operating the tuner function using the system menu

You can operate the tuner function using the system menu on the front panel display.

### To preset radio stations

- 1 Press FUNCTION repeatedly until "TUNER FM" or "TUNER AM" appears in the front panel display.
- 2 Press and hold TUNING +/- until the auto scanning starts.  
Scanning stops when the system tunes in a station. "TUNED" and "ST" (for stereo program) light up in the front panel display.
- 3 Press SYSTEM MENU.
- 4 Press ↑/↓ repeatedly until "TUNER MENU" appears in the front panel display, then press ⊕ or →.
- 5 Press ↑/↓ repeatedly until "MEMORY" appears in the front panel display, then press ⊕ or →.

A preset number appears in the front panel display.



- 6 Press ↑/↓ to select the preset number you want.



#### TIP

- You can select the preset number directly by pressing the number buttons.

- 7 Press ⊕.  
"COMPLETE" appears in the front panel display, and the station is stored.
- 8 Repeat Steps 2 to 8 to store other stations.
- 9 Press SYSTEM MENU.  
The system menu turns off.

## To change the preset number

Select the desired preset number by pressing PRESET +/-, then perform the procedure from Step 3.

## If an FM program is noisy

If an FM program is noisy, you can select monaural reception. There will be no stereo effect, but reception will improve.

- 1** Press **SYSTEM MENU**.
- 2** Press **↑/↓** repeatedly until **“TUNER MENU”** appears in the front panel display, then press **⊕** or **→**.
- 3** Press **↑/↓** repeatedly until **“FM MODE”** appears in the front panel display.

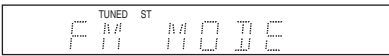

- 4** Press **⊕** or **→**.
- 5** Press **↑/↓** to select **“MONO.”**
  - **“STEREO”**: Stereo reception.
  - **“MONO”**: Monaural reception.
- 6** Press **⊕**.  
The setting is made.
- 7** Press **SYSTEM MENU**.  
The system menu turns off.

## To name preset stations

You can enter a name for preset stations. These names (for example, “ABC”) appear in the front panel display when a station is selected.

Only one name can be entered for each preset station.

- 1** Press **FUNCTION** repeatedly until **“TUNER FM”** or **“TUNER AM”** appears in the front panel display.  
The last received station is tuned in.
- 2** Press **PRESET +/-** repeatedly to select the preset station you want to create an index name for.
- 3** Press **SYSTEM MENU**.
- 4** Press **↑/↓** repeatedly until **“TUNER MENU”** appears in the front panel display, then press **⊕** or **→**.
- 5** Press **↑/↓** repeatedly until **“NAME IN”** appears in the front panel display.

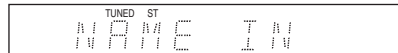

- 6** Press **⊕** or **→**.
- 7** Create a name by using **←/↑/↓/→**.  
Press **↑/↓** to select a character, then press **→** to move the cursor to the next position.



You can input letters, numbers, and other symbols for a radio station.

## If you make a mistake

Press **←/→** repeatedly until the character to be changed flashes, then press **↑/↓** to select the desired character.

To erase the character, press **←/→** repeatedly until the character to be erased flashes, then press **CLEAR**.

- 8** Press **⊕**.  
“COMPLETE” appears in the front panel display, and the station name is stored.
- 9** Press **SYSTEM MENU**.  
The system menu turns off.

## Using the DIGITAL MEDIA PORT Adapter

The DIGITAL MEDIA PORT (DMPORT) adapter is for enjoying sound from a portable audio source or computer. By connecting a DIGITAL MEDIA PORT adapter, you can enjoy sound from the connected component on the system.

Available DIGITAL MEDIA PORT adapters vary in each area.

For details on connecting the DIGITAL MEDIA PORT adapter, see “Connecting the other components” (page 26).

### Note

- Do not connect an adapter other than the DIGITAL MEDIA PORT adapter.
- Do not connect or disconnect the DIGITAL MEDIA PORT adapter to/from the unit while the system is turned on.
- Depending on the type of DIGITAL MEDIA PORT adapter, images are also output. In this case, the system outputs a composite video signal only, regardless of the type of video signal.
- When you use the system and a Bluetooth Wireless Audio Adapter (such as TDM-BT1, not supplied) at the same time, transmission distance between the Bluetooth transmitter and Bluetooth Wireless Audio Adapter may be reduced. In this case, place the Bluetooth transmitter as far as possible from the system, or move the Bluetooth Wireless Audio Adapter closer to the Bluetooth transmitter.
- When you use the system and the Wireless Network Audio Adapter (such as TDM-NC1, not supplied) at the same time, place the Wireless Network Audio Adapter as far as possible from the system.

## Playing the connected component on the system

- 1 Press **FUNCTION** repeatedly until “DMPORT” appears in the front panel display.
- 2 Start playback of the connected component.

The sound and images from the connected component are played on the system or connected TV.

For operation details, refer to the operating instructions of the DIGITAL MEDIA PORT adapter.

### Tip

- Depending on the type of DIGITAL MEDIA PORT adapter, you may be able to operate a connected component using either the buttons on the remote or the unit. The following illustration shows an example of buttons that can be used in this case.

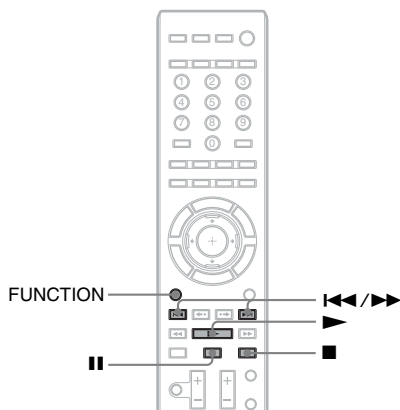

## To enhance compressed sound

You can enhance compressed sound such as an MP3 audio file. This effect is activated automatically when you set the decoding mode to “A.F.D. STD” (page 38) while the “DMPORT” function is selected. To cancel the effect, select other than “A.F.D. STD.”

# Using an S-AIR Product

The unit is compatible with the S-AIR function (page 122), which allows sound transmission between S-AIR products.

## About S-AIR products

There are two types of S-AIR product.

- **S-AIR main unit** (this unit): This is for transmitting sound. You can use up to three S-AIR main units. (The number of usable S-AIR main units depends on the use environment.)
- **S-AIR sub unit**: This is for receiving sound.
  - **Surround amplifier**: You can enjoy surround speaker sound wirelessly.
  - **S-AIR receiver**: You can enjoy system sound in another room.

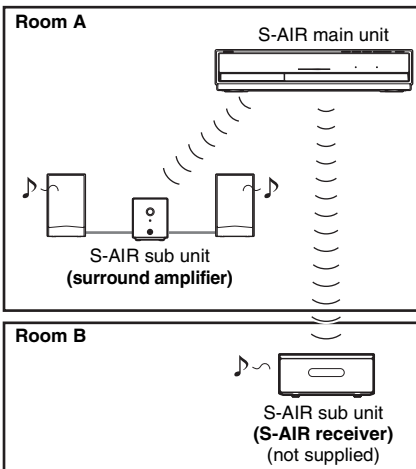

### Note

- You cannot operate this function if you do not insert the wireless transceiver in the unit correctly (page 28).

## Establishing sound transmission between the unit and S-AIR sub unit (ID setting)

*For the surround amplifier*

*For the S-AIR receiver*

Simply by matching the ID of the unit and the S-AIR sub unit, you can establish sound transmission.

### To set the ID of the unit

- 1 Set the S-AIR ID switch of the unit to the desired ID.

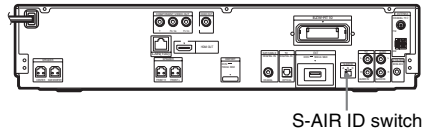

You can select any ID (A, B, or C).

- 2 Press I/⏻.

The system turns on.

- 3 Set the S-AIR sub unit to the same ID.

Sound transmission is established as follows (example):

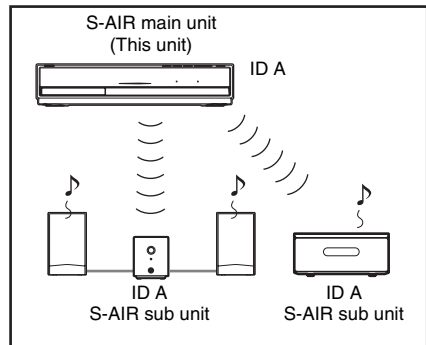

## To set the ID of the surround amplifier

- 1 Make sure that the **SURROUND SELECTOR** switch of the surround amplifier is set to **SURROUND**.
- 2 Set the **S-AIR ID** switch of the surround amplifier to match the ID (A, B, or C) of the unit.
- 3 Press **POWER** on the surround amplifier.

When sound transmission is established, the **POWER / ON LINE** indicator of the surround amplifier turns green.

For details of the **POWER / ON LINE** indicator, see “To check the transmission status” (page 32).

### Tip

- When you use the Wireless Surround Speaker Kit (WAHT-SBP1, optional) for the surround back speakers (page 17), set the **SURROUND SELECTOR** switch to **SURROUND BACK**.

## To set the ID of the S-AIR receiver

Refer to the operating instructions of the S-AIR receiver.

## To use multiple S-AIR main units

You can use multiple S-AIR main units by setting a different ID for each component.

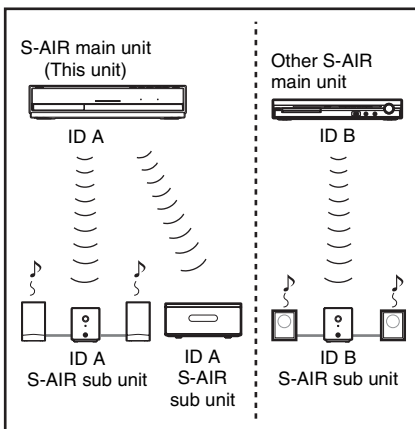

## Enjoying the system's sound in another room

### For the S-AIR receiver

You can enjoy the system's sound by using the S-AIR receiver. The S-AIR receiver can be placed in another room for enjoying the system's sound there.

For details of the S-AIR receiver, refer to the operating instructions of the S-AIR receiver.

- 1 Press **SYSTEM MENU**.
- 2 Press **↑/↓** repeatedly until “**S-AIR MENU**” appears in the front panel display, then press **⊕** or **→**.
- 3 Press **↑/↓** repeatedly until “**S-AIR MODE**” appears in the front panel display, then press **⊕** or **→**.
- 4 Press **↑/↓** to select the desired setting.
  - “**PARTY**”: The S-AIR receiver outputs sound according to functions set on the unit.
  - “**SEPARATE**”: You can set the desired function for the S-AIR receiver while unit functions do not change.
- 5 Press **⊕**.

The setting is made.
- 6 Press **SYSTEM MENU**.

The system menu turns off.
- 7 Select the desired function on the S-AIR receiver.

### ■ When “PARTY” is set

The **S-AIR receiver's** function changes sequentially as you press **FUNCTION** of the main unit (page 37) or **S-AIR CH** of the S-AIR receiver.

### ■ When “SEPARATE” is set

The **S-AIR receiver's** function changes by pressing **S-AIR CH** of the S-AIR receiver as follows.

“**MAIN UNIT**” → “**TUNER FM**” →  
“**TUNER AM**” → “**DMPORT**” →  
“**AUDIO**” → ...

To enjoy the same function as the unit, select “MAIN UNIT.”

When “TUNER FM” or “TUNER AM” is selected on the unit, you can only select the same band on the S-AIR receiver. When other than “TUNER FM” or “TUNER AM” is selected on the unit, you can select any band for the tuner on the S-AIR receiver.

## 8 Adjust the volume on the S-AIR receiver.

### Note

- When the sound is other than 2 channel stereo, multi-channel sound is downmixed to 2 channel.
- The sound of the S-AIR receiver may be cut off by operation of the unit.

## To set “S-AIR MODE” via the remote

### Press S-AIR MODE.

The S-AIR mode appears in the front panel display. Each time you press S-AIR MODE, the S-AIR mode changes.

## To control the system from the S-AIR receiver

You can control the system from the S-AIR receiver by using the following buttons.

Press	Operation
▶, II, ■, ◀◀/▶▶	Share the same operations on the remote and unit.
S-AIR CH	Change the function of the system.

For details, refer to the operating instructions of the S-AIR receiver.

## Enjoying the S-AIR receiver while the unit is in standby mode

### For the S-AIR receiver

You can enjoy the S-AIR receiver while the unit is in standby mode by setting “S-AIR STBY” to “STBY ON.”

- 1 Press **SYSTEM MENU**.
- 2 Press **↑/↓** repeatedly until “**S-AIR MENU**” appears in the front panel display, then press **+** or **→**.
- 3 Press **↑/↓** repeatedly until “**S-AIR STBY**” appears in the front panel display, then press **+** or **→**.
- 4 Press **↑/↓** to select the desired setting.
  - “**STBY ON**”: You can enjoy the S-AIR receiver while the unit is in standby mode or turned on. The power consumption during standby mode increases.
  - “**STBY OFF**”: You cannot enjoy the S-AIR receiver while the unit is in standby mode.
- 5 Press **+**.  
The setting is made.
- 6 Press **SYSTEM MENU**.  
The system menu turns off.

### Note

- When you turn the system off while “S-AIR STBY” is set to “STBY ON,” “S-AIR” flashes (when sound transmission between the unit and S-AIR receiver is not established), or lights up (when sound transmission between the unit and S-AIR receiver is established) in the front panel display.

## Identifying the unit with a specific S-AIR sub unit (Pairing operation)

*For the surround amplifier*

*For the S-AIR receiver*

It is easy to set the same ID for the unit and an S-AIR sub unit, such as a surround amplifier or S-AIR receiver, to establish sound transmission. However, neighbors may also receive your system's sound if IDs are the same, or you may receive sound from neighbors. To prevent this, you can identify the unit with a specific S-AIR sub unit by performing the pairing operation.

### ■ Before pairing

Sound transmission is established by the ID (example).

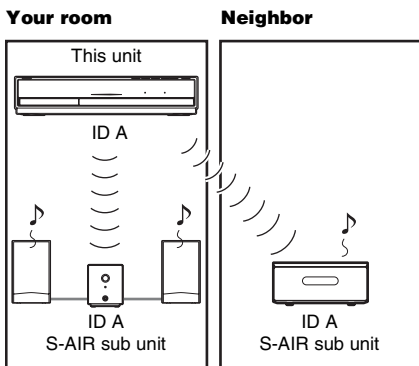

### ■ After pairing

Sound transmission is established between the paired unit and S-AIR sub unit(s) only.

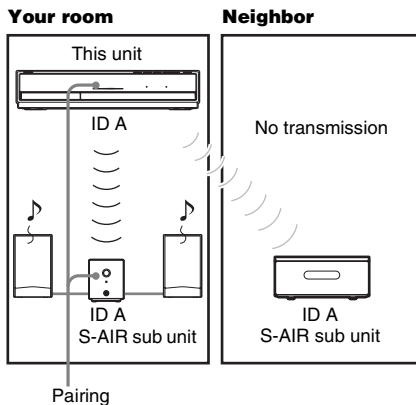

### To perform pairing

- 1 Place the S-AIR sub unit that you want to pair near the unit.

#### Note

- Remove headphones from the surround amplifier (if connected).

- 2 Match the IDs of the unit and the S-AIR sub unit.

- To set the ID of the unit, see “To set the ID of the unit” (page 61).
- To set the ID of the surround amplifier, see “To set the ID of the surround amplifier” (page 62).
- To set the ID of the S-AIR receiver, refer to the operating instructions of the S-AIR receiver.

- 3 Press **SYSTEM MENU**.

- 4 Press **↑/↓** repeatedly until “**S-AIR MENU**” appears in the front panel display, then press **+** or **→**.

- 5 Press **↑/↓** repeatedly until “**PAIRING**” appears in the front panel display, then press **+** or **→**.



- 6** Press  $\uparrow/\downarrow$  repeatedly until “START” appears in the front panel display, then press  $\oplus$ .

The unit starts pairing and “SEARCH” flashes in the front panel display.

To cancel pairing, press SYSTEM MENU.

- 7** Start pairing of the S-AIR sub unit.

**■ For the surround amplifier**

Press POWER on the surround amplifier to turn on the surround amplifier and press PAIRING on the rear panel of the surround amplifier.

The PAIRING indicator of the surround amplifier flashes red when pairing starts.

When sound transmission is established, the PAIRING indicator of the surround amplifier turns red and “PAIRING” and “COMPLETE” appear alternately in the front panel display.

**Tip**

- To press PAIRING on the rear panel of the surround amplifier, a slim instrument, such as a paper clip, can be used.

**■ For the S-AIR receiver**

Refer to the operating instructions of the S-AIR receiver.

When sound transmission is established, “PAIRING” and “COMPLETE” appear alternately in the front panel display.

**Note**

- Perform pairing within several minutes of Step 5. If you do not, “PAIRING” and “INCOMPLETE” appear alternately in the front panel display. To continue pairing, press  $\oplus$  and start again from Step 5. To cancel pairing, press SYSTEM MENU.

- 8** Press SYSTEM MENU.

The system menu turns off.

**Note**

- When you perform pairing, “(PAIRING)” appears beside ID on the display for selecting ID.

## To cancel pairing

Change the ID setting of the unit by using the S-AIR ID switch of the unit. If you select a new ID, pairing is canceled.

## Checking the S-AIR status of the unit

You can check the S-AIR status such as the S-AIR ID or pairing information.

- 1** Press SYSTEM MENU.
- 2** Press  $\uparrow/\downarrow$  repeatedly until “S-AIR MENU” appears in the front panel display, then press  $\oplus$  or  $\rightarrow$ .
- 3** Press  $\uparrow/\downarrow$  repeatedly until “S-AIR INFO” appears in the front panel display, then press  $\oplus$  or  $\rightarrow$ .

The S-AIR ID of the unit appears in the front panel display. When the unit is paired, “(PAIRING)” appears beside ID.

- 4** Press SYSTEM MENU.

The system menu turns off.

## If sound transmission is unstable

### *For the surround amplifier For the S-AIR receiver*

If you use multiple wireless systems which share the 2.4 GHz band, such as wireless LAN or Bluetooth, the transmission of S-AIR products or other wireless systems may be unstable. In this case, the transmission may be improved by changing the following “RF CHANGE” setting.

- 1** Press SYSTEM MENU.
- 2** Press  $\uparrow/\downarrow$  repeatedly until “S-AIR MENU” appears in the front panel display, then press  $\oplus$  or  $\rightarrow$ .
- 3** Press  $\uparrow/\downarrow$  repeatedly until “RF CHANGE” appears in the front panel display, then press  $\oplus$  or  $\rightarrow$ .

#### **4 Press ↑/↓ to select the desired setting.**

- “**AUTO**”: Normally select this. The system changes “**RF CHANGE**” to “**ON**” or “**OFF**” automatically.
- “**ON**”: The system transmits sound by searching for a better channel for transmitting.
- “**OFF**”: The system transmits sound by fixing the channel for transmitting.

#### **5 Press ⊕.**

The setting is made.

#### **6 Press SYSTEM MENU.**

The system menu turns off.

#### **7 When you set “RF CHANGE” to “OFF,” select the ID so that sound transmission is most stable (page 61).**

##### **Note**

- In most cases, you will not need to change this setting.
  - If “**RF CHANGE**” is set to “**OFF**,” transmission between the unit and S-AIR sub unit can be performed using one of the following channels.
  - S-AIR ID A: equivalent channel for IEEE 802.11b/g channel 1
  - S-AIR ID B: equivalent channel for IEEE 802.11b/g channel 6
  - S-AIR ID C: equivalent channel for IEEE 802.11b/g channel 11
- The transmission may be improved by changing the transmission channel (frequency) of the other wireless system(s). For details, refer to the operating instructions of the other wireless system(s).

# Using the Control for HDMI Function for “BRAVIA” Sync

This function is available on TVs with the “BRAVIA” Sync function only.

By connecting Sony components that are compatible with the Control for HDMI function with an HDMI cable, operation is simplified as below:

- Theater Mode (page 68)
- One-Touch Play (page 68)
- System Power Off (page 68)
- Volume Limit (page 69)
- System Audio Control (page 69)
- Language Follow (page 69)

Control for HDMI is a mutual control function standard used by CEC (Consumer Electronics Control) for HDMI (High-Definition Multimedia Interface).

The Control for HDMI function will not work in the following cases:

- When you connect this system to a component which is not compatible with the Control for HDMI function.
- A component does not have an HDMI jack.

There are convenient buttons on the system’s remote for operating the TV, such as THEATER, ONE-TOUCH PLAY, and TV I/O. For details, see “Controlling Your TV with the Supplied Remote” (page 73) and refer to the operating instructions of the TV.

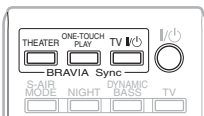

### Note

- Depending on the connected component, the Control for HDMI function may not work. Refer to the operating instructions supplied with the component.
- The Control for HDMI function may not work if you connect a component other than Sony, even if the component is compatible with the Control for HDMI function.

## Preparing for the Control for HDMI function

### (Control for HDMI - Easy Setting)

The system is compatible with the Control for HDMI - Easy Setting function. If the TV is compatible with the Control for HDMI - Easy Setting function, you can set the system’s [Control for HDMI] function automatically by setting the TV. For details, refer to the operating instructions of the TV.

If the TV is not compatible with the Control for HDMI - Easy Setting function, set the Control for HDMI function of the system and TV manually.





### Note

- For details on setting the TV, refer to the operating instructions.

- 1 Make sure that the system and the TV are connected with an HDMI cable.**
- 2 Turn on the TV and press I/O to turn on the system.**
- 3 Switch the input selector on your TV so that the signal from the system through the HDMI input appears on the TV screen.**
- 4 Set the Control for HDMI function of the system and TV.**

The Control for HDMI function for system and TV is simultaneously set to on.

## To set the [Control for HDMI] function of the system to on/off manually

- 1 Press HOME.**  
The home menu appears on the TV screen.
- 2 Press ←/→ to select  [Setup].**
- 3 Press ↑/↓ to select [HDMI Settings], then press .**  
The options for [HDMI Settings] appear.
- 4 Press ↑/↓ to select [Control for HDMI], then press .**
- 5 Press ↑/↓ to select the setting, then press .**
  - [On]: On.
  - [Off]: Off.

### Note

- During the setting of the Control for HDMI function for the system, the System Audio Control function does not work.

### Tip

- The default setting of the Control for HDMI function of the system is [On].

## Using the Theater Mode

### (Theater Mode)

If your TV is compatible with the Theater mode, when you press THEATER, you can enjoy the optimum video mode and sound quality suited for movies, and TV sound is output from the system's speakers automatically. Also, the TV's video mode switches to Theater Mode.

## Watching BD/DVD by a single button press

### (One-Touch Play)

By only pressing ONE-TOUCH PLAY, the TV turns on, the TV is set for BD/DVD input selector, and the system starts playing a disc automatically.

Also, when you insert a disc, One-Touch Play is enabled. If One-Touch Play does not start (in the case of inserting a disc that is not compatible with the auto playback function), press  or ONE-TOUCH PLAY.

The system and TV work as follows (e.g.):

This system	TV
Turns on. (If not already turned on.)	Turns on. (If not already turned on.)
↓	↓
Switches to "BD/DVD" function.	Switches to HDMI input.
↓	↓
Starts playing the disc and outputs the sound.	Minimizes sound level. (System Audio Control)

## Turning the system off in sync with the TV

### (System Power Off)

When you turn the TV off by using the POWER button on the TV's remote or TV  on the system's remote, the system turns off automatically.

### Note

- Before using the System Power Off function, set the function for TV power. For details, refer to the operating instructions of the TV.
- Depending on the status, the system or the connected components may not turn off automatically. For details, see the operating instructions supplied with the connected components.

## Enjoying TV sound from the speakers in this system

### *(System Audio Control)*

You can enjoy TV sound in this system by easy operation.

To use this function, connect the system and the TV with an audio cord and an HDMI cable (page 24).

You can use the System Audio Control function as follows:

- You can enjoy TV sound from the speakers of the system by means of a simple operation. For details, see the operating instructions of the TV.
- When the system is turned on, TV sound will be output from the speakers of the system.
- When TV sound is output from the speakers of the system, you can adjust the volume and turn off the sound of the system using the TV remote.

#### **Note**

- While the TV is in PAP (picture and picture) mode, the System Audio Control function will not work. When the TV exits PAP mode, the output method of the TV returns to the one before PAP mode.

## Setting the Maximum Volume Level of the System

### *(Volume Limit)*

If you change the output method of the TV to the system speaker on the TV menu or by pressing THEATER, loud sound may be output depending on the volume level of the system. You can prevent this by limiting the maximum level of the volume. For details, see [Volume Limit] (page 86).

## Changing the language for the on-screen display of the TV

### *(Language Follow)*

When you change the language for the on-screen display of the TV, the system's on-screen display language is also changed after turning the system off and on.

# Calibrating the Appropriate Settings Automatically

## [Auto Calibration]

D. C. A. C. (Digital Cinema Auto Calibration) can set the appropriate surround sound automatically.

### Note

- The system outputs a loud test sound when [Auto Calibration] starts. You cannot turn the volume down. Give consideration to children and neighbors.

### 1 Press HOME.

The home menu appears on the TV screen.

### 2 Press $\leftarrow/\rightarrow$ to select [Setup].

### 3 Press $\uparrow/\downarrow$ to select [Audio Settings], then press $\oplus$ .

### 4 Press $\uparrow/\downarrow$ to select [Auto Calibration], then press $\oplus$ .

The confirmation display for [Auto Calibration] appears.

### 5 Connect the calibration mic to the A.CAL MIC jack on the rear panel.

Set up the calibration mic at ear level using a tripod, etc. (not supplied). The front of each speaker should face the calibration mic, and there should be no obstruction between the speakers and the calibration mic.

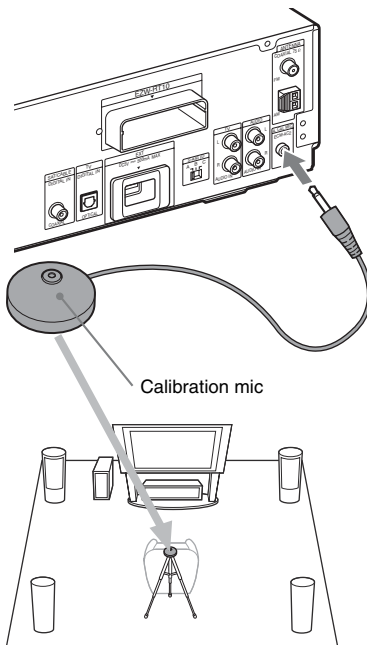

### 6 Press $\uparrow/\downarrow$ to select [Start].

To cancel, select [Cancel].

### 7 Press $\oplus$ .

[Auto Calibration] starts.

The system adjusts the speaker settings automatically.

Be quiet during the measurement.

### Note

- Before [Auto Calibration], make sure that the surround amplifier turns on and you install the surround amplifier in the appropriate location. If you install the surround amplifier in an improper location, such as another room, proper measurement will not be obtained.
- When you use the Wireless Surround Speaker Kit (WAHT-SBP1, optional) for the surround back speakers (page 17), install the speakers in appropriate location and turn the surround amplifier on.
- Loud test sound is output when [Auto Calibration] starts. You cannot turn the volume down. Give consideration to children and neighbors.

## 8 Confirm the conclusions of [Auto Calibration].

The conclusions appear on the TV screen. Press  $\leftarrow/\rightarrow$  to change the page. The first page shows the distance of speakers. The second page shows the level of speakers.

### Note

- If measurement fails, follow the message then retry [Auto Calibration].

### Tip

- You can change a measurement unit (feet or meters) by pressing the color button (RED).

## 9 Press $\uparrow/\downarrow$ to select [OK] or [Cancel], then press $\oplus$ .

### ■ The measurement is OK.

Disconnect the calibration mic, then select [OK]. The result is implemented.

### ■ The measurement is not OK.

Follow the message, then select [OK] to retry.

### Note

- While the Auto Calibration function works:
  - do not turn off the power.
  - do not press any button.
  - do not change the volume.
  - do not change the function.
  - do not change the disc.
  - do not insert or eject a disc.
  - do not connect the headphones to the surround amplifier.
  - do not disconnect the calibration mic.

# Setting the Speakers

## [Speaker Settings]

To obtain the best possible surround sound, set connection of the speakers and their distance from your listening position. Then use the test tone to adjust the level and the balance of the speakers to the same level.

### 1 Press HOME.

The home menu appears on the TV screen.

### 2 Press $\leftarrow/\rightarrow$ to select [Setup].

### 3 Press $\uparrow/\downarrow$ to select [Audio Settings], then press $\oplus$ .

### 4 Press $\uparrow/\downarrow$ to select [Speaker Settings], then press $\oplus$ .

The [Speaker Settings] display appears.

### 5 Press $\uparrow/\downarrow$ to select the item, press $\oplus$ .

Setup the following settings.

### ■ [Connection]

If you do not connect center or surround speakers, set the parameters for [Center] and [Surround]. Since the front speaker and subwoofer settings are fixed, you cannot change them.

When you use the Wireless Surround Speaker Kit (WAHT-SBP1, optional) for the surround back speakers (page 17), set [Surround Back] also.

### [Front]

[Yes]

### [Center]

[Yes]: Normally select this.

[None]: Select this if no center speaker is used.

### [Surround]

[Yes]: Normally select this.

[None]: Select this if no surround speaker is used.

### [Surround Back]

[Yes]: Select this if surround back speakers are used.

[None]: Select this if no surround back speaker is used.

## [Subwoofer]

[Yes]

### ■ [Distance]

When you move the speakers, be sure to set the parameters of the distance (A) from the listening position to the speakers.

You can set the parameters from 0 to 23 feet (0.0 to 7.0 meters).

The speakers in the illustration correspond to the following:

- ① Center speaker
- ② Front left speaker (L)
- ③ Front right speaker (R)
- ④ Subwoofer
- ⑤ Surround left speaker (L)
- ⑥ Surround right speaker (R)
- ⑦ Surround back left speaker (L) (optional)
- ⑧ Surround back right speaker (R) (optional)

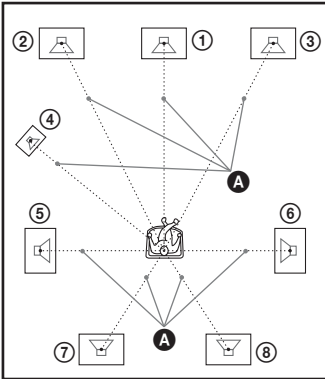

[Front Left/Right] 10 ft/3.0 m: Set the front speaker distance.

[Center]\* 10 ft/3.0 m: Set the center speaker distance.

[Surround Left/Right]\* 10 ft/3.0 m: Set the surround speaker distance.

[Surround Back Left/Right]\* 10 ft/3.0 m: Set the surround back speaker distance.

[Subwoofer] 10 ft/3.0 m: Set the subwoofer distance.

\* This item appears when you set to [Yes] in the [Connection] setting.

#### Note

- Depending on the input stream, [Distance] may not be effective.

#### Tip

- You can change a measurement unit (feet or meters) by pressing the color button (RED).

### ■ [Level]

You can adjust the sound level of the speakers. You can set the parameters from  $-6.0$  dB to  $+6.0$  dB. Be sure to set [Test Tone] to [On] for easy adjustment.

[Front Left/Right] 0.0 dB: Set the front speaker level.

[Center]\* 0.0 dB: Set the center speaker level.

[Surround Left/Right]\* 0.0 dB: Set the surround speaker level.

[Surround Back Left/Right]\* 0.0 dB: Set the surround back speaker level.

[Subwoofer] 0.0 dB: Set the subwoofer level.

\* This item appears when you set to [Yes] in the [Connection] setting.

### ■ [Test Tone]

The speakers will emit a test tone to adjust [Level].

[Off]: The test tone is not emitted from the speakers.

[On]: The test tone is emitted from each speaker in sequence while adjusting level. When you select one of the [Speaker Settings] items, the test tone is emitted from each speaker in sequence.

Adjust the sound level as follows.

- 1** Set [Test Tone] to [On].
- 2** Press  $\uparrow/\downarrow$  to select [Level], then press  $\oplus$ .
- 3** Press  $\uparrow/\downarrow$  to select the desired speaker type, then press  $\oplus$ .
- 4** Press  $\leftarrow/\rightarrow$  to select the left or right speaker, then press  $\uparrow/\downarrow$  to adjust the level.
- 5** Press  $\oplus$ .
- 6** Repeat Steps 3 to 5.
- 7** Press RETURN.  
The system returns to the previous display.
- 8** Press  $\uparrow/\downarrow$  to select [Test Tone], then press  $\oplus$ .



**9** Press **↑/↓** to select [Off], then press **+**.

**Note**

- The test tone signals are not output from the HDMI OUT jack.

**Tip**

- To adjust the volume of all the speakers at one time, press VOLUME +/-.

## Controlling Your TV with the Supplied Remote

By adjusting the remote signal, you can control your TV with the supplied remote.

**Note**

- When you replace the batteries of the remote, the code number may reset itself to the default (SONY) setting. Reset the appropriate code number.

### Preparing the remote for controlling the TV

**Press and hold TV I/⏻ while entering your TV's manufacturer's code (see the table) using the number buttons. Then release TV I/⏻.**

If you successfully set the manufacturer's code, the TV button flashes twice slowly. If the setting is unsuccessful, the TV button flashes five times quickly.

#### Code numbers of controllable TVs

If more than one code number is listed, try entering them one at a time until you find the code that works with your TV.

Manufacturer	Code number
SONY	501 (default), 502
DAEWOO	506
EMERSON	567
FUNAI	548
GE	509
GOLDSTAR/LG	503, 517, 544, 568
GRUNDIG	533
HITACHI	514
ITT	521, 522
JVC	516
LOEWE	518
MITSUBISHI/MGA	527
NEC	503
NOKIA	521, 522, 573, 575
PANASONIC	553, 572
PHILIPS	515, 518, 557, 570
PIONEER	526

Manufacturer	Code number
RADIO SHACK	565
RCA/PROSCAN	510
SABA	530, 537, 558
SAMSUNG	515, 517, 544, 566, 569, 571, 574
SANYO	508, 545
SHARP	535, 565
TELEFUNKEN	547, 558
THOMSON	547, 549
TOSHIBA	541, 551
ZENITH	543

## Controlling the TV with the remote







You can control the TV using the following buttons. To use these buttons (other than THEATER, TV , TV INPUT), set the remote to the TV mode by pressing TV, so that TV lights up for 1 second.

To exit the TV mode, press TV so that TV flashes four times.

### Note

- While in the TV mode, if you press any of the following buttons, TV lights up. (Depending on the manufacturer setting, some buttons may not work, and TV does not light up.)
- When you press other than the following buttons while the remote is in the TV mode, TV flashes four times and the remote exits the TV mode automatically, and the system is operated as the function of the pressed button.
- Depending on the TV, you may not be able to use some or all of the buttons.

By pressing	You can
TV 	Turn the TV on or off.
THEATER	Enjoy optimal images and sound suited for movies.
TV INPUT	Switch the TV's input source between the TV and other input sources.
VOLUME +/-	Adjust the TV volume.
CH +/-	Select the TV channel.
MUTING	Turn off the TV sound temporarily.

By pressing	You can
Number buttons,  , ENTER	Select the TV channel.
HOME	Display the menu of the TV.
FAVORITES	Display the favorite channel list.
CC	Display closed captioning.
GUIDE	Display the Digital Electronic Programme Guide (EPG).
TOOLS	Display the operation menu for the current display.
RETURN	Return to the previous channel or layer on the menu of the TV.
•	Input “.” (dot) when inputting numerics.
WIDE	Change the aspect ratio of the connected TV.
 /  /  /  , 	Select the item on the menu.
DISPLAY	Display the information.

### Tip

- The function of these buttons are same as the remote buttons of the SONY TV. For details, refer to the operating instructions of the TV.

## Using the Sleep Timer

You can set the system to turn off at a preset time, so you can fall asleep listening to music. You can preset the time in 10-minute increments.

- 1** Press **SYSTEM MENU**.
- 2** Press **↑/↓** repeatedly until **“SLEEP MENU”** appears in the front panel display, then press **⊕** or **→**.
- 3** Press **↑/↓** to select a setting.

The minutes display (the remaining time) changes by 10 minutes.

### Tip

- You can select the remaining time by pressing the number buttons. In this case, you can preset the time in 1-minute increments.

- 4** Press **⊕**.  
The setting is made and **“SLEEP”** flashes in the front panel display.
- 5** Press **SYSTEM MENU**.  
The system menu turns off.

## Changing the Brightness of the Front Panel Display

The brightness of the front panel display can be set to either of 2 levels.

- 1** Press **SYSTEM MENU**.
- 2** Press **↑/↓** repeatedly until **“DISP MENU”** appears in the front panel display, then press **⊕** or **→**.
- 3** Press **↑/↓** repeatedly until **“DIMMER”** appears in the front panel display, then press **⊕** or **→**.
- 4** Press **↑/↓** to select the brightness of the front panel display.
  - **“DIMMER OFF”**: Bright.
  - **“DIMMER ON”**: Dark.
- 5** Press **⊕**.  
The setting is made.
- 6** Press **SYSTEM MENU**.  
The system menu turns off.

# Deactivating the Buttons on the Unit

## (Child Lock)

You can deactivate the buttons on the unit (except for **I/⏻**) for preventing misoperation, such as child mischief (child lock function).

**Press ■ on the unit for more than 5 seconds.**

“CHILD LOCK” and “ON” appear in the front panel display.

The child lock function is activated and the buttons on the unit are locked. (You can operate the system by using the remote.)

To cancel, press ■ for more than 5 seconds so that “CHILD LOCK” and “OFF” appear in the front panel display.

### Note

- When you operate the buttons on the unit while the child lock function is on, “CHILD LOCK” appears in the front panel display.

# About the demonstration

You can turn on/off the demonstration in the front panel display while the system is in standby mode.

- 1 Press SYSTEM MENU.**
- 2 Press ↑/↓ repeatedly until “DISP MENU” appears in the front panel display, then press ⊕ or →.**
- 3 Press ↑/↓ repeatedly until “DEMO” appears in the front panel display, then press ⊕ or →.**
- 4 Press ↑/↓ to select a setting.**
  - “DEMO ON”: On.
  - “DEMO OFF”: Off.

The default setting differs depending on the area.
- 5 Press ⊕.**

The setting is made.
- 6 Press SYSTEM MENU.**

The system menu turns off.

### Tip

- When you purchase the system new, or if the system is at its factory default settings (page 90), you can turn off the demonstration simply by pressing **I/⏻** on the remote.

---

# Saving Power in Standby Mode

Check that the following settings are made:

- [Control for HDMI] is set to [Off] (page 67).
- “S-AIR STBY” is set to “STBY OFF” (page 63).
- “DEMO” is set to “DEMO OFF” (page 76).
- [Standby Mode] is set to [Normal] (page 87).

# Using the Setup Display

You can make various adjustments of items such as picture and sound.

Select  (Setup) on the home menu when you need to change the settings of the system.

### Note

- Playback settings stored in the disc take priority over the Setup Display settings and not all the functions described may work.

## 1 Press HOME.

The home menu appears on the TV screen.

## 2 Press $\leftarrow/\rightarrow$ to select [Setup].

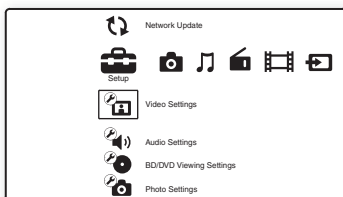





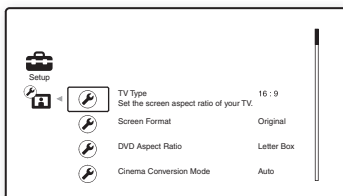





## 3 Press $\uparrow/\downarrow$ to select the setup category icon to change, then press $\oplus$ .

Example: [Video Settings]



You can setup the following options.

Icon	Explanation
	<b>[Network Update] (page 79)</b> Updates the software of the system.
	<b>[Video Settings] (page 80)</b> Makes the video settings according to the type of connecting jacks.
	<b>[Audio Settings] (page 82)</b> Makes the audio settings according to the type of connecting jacks.
	<b>[BD/DVD Viewing Settings] (page 84)</b> Makes detailed settings for BD/DVD playback.
	<b>[Photo Settings] (page 86)</b> Makes the photo-related settings.
	<b>[HDMI Settings] (page 86)</b> Makes the HDMI settings.
	<b>[System Settings] (page 87)</b> Makes the system-related settings.
	<b>[Network Settings] (page 88)</b> Makes detailed settings for Internet and network.
	<b>[Easy Setup] (page 89)</b> Re-runs the Easy Setup to make the basic settings.
	<b>[Resetting] (page 90)</b> Resets the system to the factory settings.

## 4 Press $\uparrow/\downarrow$ to select an item, then press $\oplus$ .

The options for the selected item appear.

Example: [TV Type]

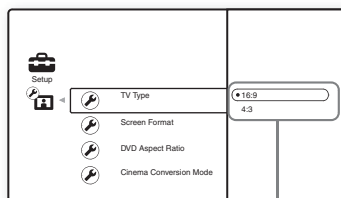

Options

**5** Press **↑/↓** to select a setting, then press **+**.

The setting is selected and setup is complete.

The options for the selected item appear.

Example: [4:3]

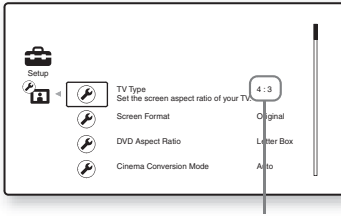

Selected setting

## [Network Update]

You can update and improve the functions of the system.

For information about update functions, refer to the following website:

<http://esupport.sony.com>

**Note**

- Do not disconnect the AC power cord (mains lead) or network cable while downloading or updating software.
- All operations, including opening the disc tray, are disabled while updating.
- Downloading times may differ depending on the server provider or line status.
- When error messages on network connections appear, check the network connections using [Network Diagnostic] of [Internet Settings] in [Network Settings] (page 88).

**Tip**

- The “UPDATE \*/9” counter (“\*” indicates update step) in the front panel display also shows progress of the update.
- You can check the current software version by selecting [System Information] in [System Settings] (page 87).
- The [Setup] settings remain after updating.
- The system informs you of newer software version information when [Software Update Notification] is set to [On] (default) (page 87).

## Updating the system's software using the network

**1** Press **↑/↓** to select [Network Update], then press **+**.

The unit connects to the network, and the display asks for confirmation.

**2** Press **←/→** to select [OK], then press **+**.

The unit starts downloading, then updating the software automatically.

When updating finishes, “COMPLETE” appears for 5 seconds in the front panel display, then the system automatically turns off.

### 3 Press I/⏻ to turn the system on.

The system starts up with the updated software.

## Updating the system's software using an update disc

You can update and improve the functions of the system using an update disc provided by a Sony dealer or local authorized Sony service facility.

### 1 Insert the update disc.

The display asks for confirmation.

### 2 Select [OK], and press ⊕.

Software update starts.

When updating finishes, "COMPLETE" appears for 5 seconds in the front panel display, then the system automatically turns off.

### 3 Press I/⏻ to turn the system on.

The system starts up with the updated software.

### 4 Press ▲ to remove the disc.

## [Video Settings]

You can make the video settings according to the type of connecting jacks.

### ■ [TV Type]

You can select the aspect ratio of the connected TV.

[16:9]: Select this when connecting to a wide-screen TV or a TV with a wide-mode function.

[4:3]: Select this when connecting to a 4:3 screen TV without a wide-mode function.

### ■ [Screen Format]

You can select the display configuration for a 4:3 screen picture on a 16:9 wide-screen TV.

[Original]: Select this when connecting to a TV with a wide-mode function. Displays a 4:3 screen picture in 16:9 aspect ratio even on a wide-screen TV.

[Fixed Aspect Ratio]: Changes the picture size to fit the screen size with the original picture aspect ratio.

### ■ [DVD Aspect Ratio]

You can select the display configuration for playback of 16:9 screen pictures on a 4:3 screen TV (selectable when [TV Type] is set to [4:3] and [Screen Format] is set to [Fixed Aspect Ratio]).

[Letter Box]: Displays a wide picture with black bands on the top and bottom.



[Pan & Scan]: Displays a full-height picture on the entire screen, with trimmed sides.





### ■ [Cinema Conversion Mode]

You can set the video conversion method for 480p, 720p, 1080i, or 1080p\* signals from the HDMI OUT jack or the COMPONENT VIDEO OUT jacks.

\* HDMI only

[Auto]: Normally select this. The unit automatically detects whether the material is video-based or film-based, and switches to the appropriate conversion method.

[Video]: The conversion method suited for video-based material will always be selected regardless of the material.

### ■ [Output Video Format]

You can select the jack type to output video signals. For details, see “Video Output Resolution” (page 104).

**1** Press **↑/↓** to select the jack type to output video signals, then press **⊕**.

#### Note

- When connecting the HDMI OUT jack and other video output jacks at the same time, select [Component Video].

### [TV Connection Method]

[HDMI]: Outputs signals from the HDMI OUT jack according to the [HDMI Resolution] setting below.

[Component Video]: Outputs signals from the COMPONENT VIDEO OUT jacks according to the [Component Resolution] setting below.

[Video]: Outputs signals from the VIDEO OUT jack.

**2** (When you select [HDMI] or [Component Video])  
Press **↑/↓** to select the signal type for the HDMI OUT jack or COMPONENT VIDEO OUT jacks, then press **⊕**.

When you change the video output resolution, a picture is displayed in the selected resolution for about 30 seconds, then the display asks for confirmation.

Follow the on-screen instructions.

“HD” lights up in the front panel display when outputting 720p/1080i/1080p video signals.

#### Note

- If the picture is distorted or no picture appears, wait for about 30 seconds without pressing any buttons. The display returns to the resolution setting screen.
- If the selected video output resolution is incorrect, no picture appears on the screen when you press any button in 30 seconds. In this case, press and hold **▶** and **▲** on the unit for more than 5 seconds to reset the video output resolution to the lowest resolution.
- When connecting the HDMI OUT jack and other video output jacks at the same time, video signals may not output from the jacks, other than from the HDMI OUT jack, when [Auto] or [1080p] is selected.

### [HDMI Resolution]/[Component Resolution]

[Auto] (HDMI only): Normally select this.

The unit outputs signals starting from the highest resolution acceptable to the TV:

1080p > 1080i > 720p > 480p > 480i

If the resulting image format is undesirable, try another setting that suits your TV.

[480i]: Outputs 480i video signals.

[480p]: Outputs 480p video signals.

[720p]: Outputs 720p video signals.

[1080i]: Outputs 1080i video signals.

[1080p] (HDMI only): Outputs 1080p video signals.

### ■ [BD-ROM 1080/24p Output]

You can set to output 1920 × 1080p/24 Hz video signals when playing film-based materials on BD-ROMs (720p/24 Hz or 1080p/24 Hz).

1920 × 1080p/24 Hz video signals can be output when all of the following conditions are met.

- You connect a 1080/24p-compatible TV using the HDMI OUT jack,
- [Output Video Format] is set to [HDMI], and
- [HDMI Resolution] is set to [Auto] or [1080p].

The 24P indicator lights up when outputting 1920 × 1080p/24 Hz video signals.

[Auto]: Outputs 1920 × 1080p/24 Hz video signals only when connecting a 1080/24p-compatible TV using the HDMI OUT jack.

[On]: Outputs 1920 × 1080p/24 Hz video signals regardless of the connected TV type.

[Off]: Select this when your TV is not compatible with 1080/24p video signals.

**Note**

- Video signals may not be output when [BD-ROM 1080/24p Output] is set to [On].

---

■ **[YCbCr/RGB (HDMI)]**

You can set the color setting for video signals output from the HDMI OUT jack. Select the setting that matches the connected TV type.

[Auto]: Automatically detects the type of external device, and switches to the matching color setting.

[YCbCr (4:2:2)]: Outputs YCbCr 4:2:2 video signals.

[YCbCr (4:4:4)]: Outputs YCbCr 4:4:4 video signals.

[RGB (16-235)]: Select this when connecting to a device with an HDCP-compliant DVI jack.

[RGB (0-255)]: Select this when connecting to an RGB (0-255) device.

---

■ **[x.v.Color Output]**

You can set whether to send xvYCC information to the connected TV.

Combining xvYCC-compatible video with a TV that supports x.v.Color display makes it possible to more accurately reproduce object colors present in the natural world.

[Auto]: Normally select this.

[Off]: Select this when the picture is unstable or colors appear unnatural.

---

■ **[Pause Mode] (BD/DVD VIDEO/DVD-R/DVD-RW only)**

You can select the picture in pause mode.

[Auto]: The picture, including subjects that move dynamically, is output with no jitter. Normally select this position.

[Frame]: The picture, including subjects that do not move dynamically, is output in high resolution.

---

 **[Audio Settings]**

You can make the audio settings.

---

■ **[BD Audio Setting]**

You can select whether to mix or not mix the interactive audio (button sound, effect sound, etc.) and secondary audio (commentary) when playing a BD that contains such audio.

[Mix]: Outputs the audio obtained by mixing the interactive audio and secondary audio to the primary audio.

[Direct]: Outputs the primary audio only.

---

■ **[Audio DRC] (BD/DVD VIDEO only)**

You can compress the dynamic range of the sound track. [Audio DRC] is useful for watching movies at low volume late at night.

[Auto]: Performs playback at the dynamic range specified by the disc (BD-ROM only).

[Off]: No compression of dynamic range.

[On]: The system reproduces the sound track with the kind of dynamic range that the recording engineer intended.

---

■ **[Attenuate - TV]**

Distortion may occur when you listen to a component connected to the TV (AUDIO IN L/R) jacks. You can prevent distortion by reducing the input level on the unit. Distortion is not a malfunction and will depend on the component connected.

[On]: Attenuates the input level. The output level is changed.

[Off]: Normal input level.

---

**■ [Attenuate - AUDIO]**

Distortion may occur when you listen to a component connected to the AUDIO (AUDIO IN L/R) jacks. You can prevent distortion by reducing the input level on the unit. Distortion is not a malfunction and will depend on the component connected.

[On]: Attenuates the input level. The output level is changed.

[Off]: Normal input level.

---

**■ [BD/DVD Audio Output]**

The system cannot output multi-channel sound from both the HDMI OUT jack and system's speakers simultaneously. You can select the output method.

[Speaker only]: Outputs multi-channel sound from the system's speakers only.

[Speaker priority]: Outputs multi-channel sound from the system's speakers and 2-channel linear PCM signals from the HDMI OUT jack.

[HDMI priority]: Outputs 2-channel stereo sound from the system's speakers, and enables sound output from the HDMI OUT jack. Sound format from the HDMI OUT jack depends on the connected component.

**Note**

- When you set [BD/DVD Audio Output] to [HDMI priority], a confirmation message appears on the TV screen. Press ←/→ to select [OK] to complete the setup.
- When you set [BD/DVD Audio Output] to [HDMI priority], the SOUND MODE, DYNAMIC BASS, NIGHT, "TONE," and "DEC. MODE" functions are disabled.
- When the System Audio Control function (page 69) is activated, this setting may change automatically.

---

**■ [Sound Effect]**

You can set the system's sound effects (SOUND MODE, DYNAMIC BASS, NIGHT, "TONE," and "DEC. MODE") to on/off.

[On]: Enables all of the system's sound effects. The upper limit of sampling frequency is set to 48kHz.

[Off]: The sound effects are disabled. Select this when you do not want to set the upper limit of sampling frequency.

---

**■ [Speaker Settings]**

To obtain the best possible surround sound, set the speakers. For details, see "Setting the Speakers" (page 71).

---

**■ [Auto Calibration]**

You can calibrate the appropriate settings automatically. For details, see "Calibrating the Appropriate Settings Automatically" (page 70).

# [BD/DVD Viewing Settings]

You can make detailed settings for BD/DVD playback.

## ■ [BD/DVD Menu]

You can select the default menu language for BD-ROMs or DVD VIDEOS. When you select [Select Language Code], the display for entering the language code appears. Enter the code for your language by referring to “Language Code List” (page 108).

## ■ [Audio]

You can select the default track language for BD-ROMs or DVD VIDEOS. When you select [Original], the language given priority in the disc is selected. When you select [Select Language Code], the display for entering the language code appears. Enter the code for your language by referring to “Language Code List” (page 108).

## ■ [Subtitle]

You can select the default subtitle language for BD-ROMs or DVD VIDEOS. When you select [Select Language Code], the display for entering the language code appears. Enter the code for your language by referring to “Language Code List” (page 108).

## ■ [BD Parental Control]

Playback of some BD-ROMs can be limited according to the age of the users. Scenes may be blocked or replaced with different scenes.

- 1 Enter your four-digit password using the number buttons.**
- 2 Press  $\uparrow/\downarrow$  to select [OK], then press  $\oplus$ .**
- 3 Press  $\uparrow/\downarrow$  to select the age restriction, then press  $\oplus$ .**

The lower the value, the stricter the limitation.

If you select [Select Age Restriction], you can enter the age restriction level from [0]

to [255] using  $\leftarrow/\uparrow/\downarrow/\rightarrow$  and the number buttons.

### **To cancel the Parental Control setting**

Select [No Restrictions].

#### **Note**

- If you forget the password, reset the system (page 90) and set a new password (see [Password] (page 85)).
- When you play discs which do not have the Parental Control function, playback cannot be limited on this unit.
- Depending on the disc, you may be asked to change the Parental Control level while playing the disc. In this case, enter your password, then change the level.
- When [255] is selected in [Select Age Restriction], the Parental Control setting is canceled.

#### **Tip**

- You can change the password. See [Password] (page 85).

## ■ [DVD Parental Control]

Playback of some DVD VIDEOS can be limited according to a predetermined level such as the age of the users. Scenes may be blocked or replaced with different scenes.

- 1 Enter your four-digit password using the number buttons.**
- 2 Press  $\uparrow/\downarrow$  to select [OK], then press  $\oplus$ .**
- 3 Press  $\uparrow/\downarrow$  to select a level, then press  $\oplus$ .**

The lower the value, the stricter the limitation.

### **To cancel the Parental Control setting**

Select [No Restrictions].

#### **Note**

- If you forget the password, reset the system (page 90) and set a new password (see [Password] (page 85)).
- When you play discs which do not have the Parental Control function, playback cannot be limited on this unit.
- Depending on the disc, you may be asked to change the Parental Control level while playing the disc. In this case, enter your password, then change the level.

#### **Tip**

- You can change the password. See [Password] (page 85).

**■ [Parental Control Region Code]**

Playback of some BD-ROMs or DVD VIDEOS can be limited according to the geographic area. Scenes may be blocked or replaced with different scenes.

- 1 Enter your four-digit password using the number buttons.**
- 2 Press  $\uparrow/\downarrow$  to select [OK], then press  $\oplus$ .**
- 3 Press  $\uparrow/\downarrow$  to select the area restriction, then press  $\oplus$ .**

When you select [Select Region Code], the display for entering the region code appears. Enter the code for the area restriction by referring to “Parental Control/ Area Code List” (page 108).

**Note**

- If you forget the password, reset the system (page 90) and set a new password (see [Password] (page 85)).
- When you play discs which do not have the Parental Control function, playback cannot be limited on this unit.
- Depending on the disc, you may be asked to change the Parental Control level while playing the disc. In this case, enter your password, then change the level.

**Tip**

- You can change the password. See [Password] (page 85).

**■ [Password]**

You can set or change the password for the Parental Control function. A password allows you to set a restriction on BD-ROM or DVD VIDEO playback. If necessary, you can differentiate the restriction levels for BD-ROMs and DVD VIDEOS.

- 1 Enter your four-digit password using the number buttons.**
- 2 Press  $\uparrow/\downarrow$  to select [OK], then press  $\oplus$ .**

**To change the password**

- 1 After Step 1, enter your four-digit password using the number buttons.**
- 2 Press  $\uparrow/\downarrow$  to select [OK], then press  $\oplus$ .**

- 3 Enter a new password using the number buttons.**

- 4 Press  $\uparrow/\downarrow$  to select [OK], then press  $\oplus$ .**

**■ [Hybrid Disc Playback Layer]**

You can select the layer priority when playing a Hybrid Disc. To change the setting, turn the system off and on again.

[BD]: Plays BD layer.

[DVD/CD]: Plays DVD or CD layer.

**■ [BD Internet Connection]**

You can set whether or not to allow Internet connections from the contents of a BD (in BDMV mode) being played. Network connections and settings are required when using this function (page 88).

[Allow]: Normally select this.

[Do not allow]: Prohibits Internet connection.



## [Photo Settings]

You can make the photo-related settings.

### ■ [Slideshow Speed]

You can change the slideshow speed.

[Fast]: Photos change rapidly.

[Normal]: Photos change at normal speed.

[Slow]: Photos change slowly.



## [HDMI Settings]

You can make the HDMI settings.

### ■ [Control for HDMI]

You can set the [Control for HDMI] function to on/off. For details, see “Using the Control for HDMI Function for “BRAVIA” Sync” (page 67).

[On]: On. You can operate mutually between components that are connected with an HDMI cable.

[Off]: Off.

### ■ [Volume Limit]

If you change the output method of the TV to the system speaker on the TV menu or by pressing THEATER, the System Audio Control (page 69) is activated and loud sound may be output depending on the volume level of the system. You can prevent this by limiting the maximum level of the volume.

[Level3]: Maximum volume level is set to 10.

[Level2]: Maximum volume level is set to 15.

[Level1]: Maximum volume level is set to 20.

[Off]: Off.

#### Note

- This function is available only when you connect the unit and TV with an HDMI cable and [Control for HDMI] is set to [On].



## [System Settings]

You can make the system-related settings.

### ■ [OSD]

You can select your language for the system on-screen displays.

### ■ [Standby Mode]

You can shorten the startup time when turning the system on.

[Quick Start]: Shortens the startup time from standby mode. You can operate the system quickly after turning it on.

[Normal]: The default setting.

#### Note

- When [Standby Mode] is set to [Quick Start], power consumption will be higher than when [Standby Mode] is set to [Normal].

### ■ [Auto Display]

You can display information when switching audio modes or during playback.

[On]: Automatically displays information on the screen when changing the viewing titles, picture modes, audio signals, etc.

[Off]: Displays information only when you press  DISPLAY.

### ■ [Screen Saver]

The screen saver image appears when you do not use the system for more than 15 minutes while an on-screen display, such as the home menu, is displayed on your TV screen. The screen saver image helps prevent your display device from becoming damaged (ghosting).

[On]: Turns on the screen saver function.

[Off]: Off.

### ■ [Software Update Notification]

You can get information on newer software versions. The information appears on the TV screen when you turn the system on. Network connections and settings are required when using this function (page 88).

[On]: Sets the system to inform you of newer software version information (page 79).

[Off]: Off.

### ■ [System Information]

You can display the system's software version information and the MAC address.

## [Network Settings]

You can make detailed settings for Internet and network.

### ■ [Internet Settings]

These items are necessary when you connect to the Internet via a network cable. Enter the respective (alphanumeric) values for your broadband router or Wireless LAN router. The items that need to be set may differ, depending on the Internet service provider or the router. For details, refer to the instruction manuals that have been provided by your Internet service provider or supplied with the router.

- 1 Press **↑/↓** to select [IP Address Acquisition], then press **+**.
- 2 Press **↑/↓** to select an item, then press **+**.

[Use DHCP]: Select this when DHCP (Dynamic Host Configuration Protocol) server settings are available from your Internet service provider. The network settings necessary for the system will be assigned automatically.

If you set [DNS Server Auto Acquisition] to [Off], set the following items:

- [DNS Server (Primary)]
- [DNS Server (Secondary)]

[Use Static IP Address]: Set the IP address manually according to your network environment.

Set the following items:

- [IP Address]
- [Subnet Mask]
- [Default Gateway]
- [DNS Server (Primary)]
- [DNS Server (Secondary)]

#### Note

- When you set the [DNS Server (Primary)]/[DNS Server (Secondary)] addresses manually, enter the [DNS Server (Primary)] address. Otherwise, the [Internet Settings] will be set incorrectly.

- 3 If your ISP has a specific proxy server setting, press **↑/↓** to select [Proxy Settings], then press **+**.

The [Proxy Settings] display appears.

If the proxy server does not have a specific setting, go to step 8.

- 4 Press **↑/↓** to select [Use of Proxy Server], then press **+**.
- 5 Press **↑/↓** to select [On], then press **+**.
- 6 Select [Proxy Server] and [Port], and enter the settings.  
To enter the proxy server, see “To enter characters” (page 88).
- 7 Press RETURN.
- 8 Press **↑/↓** to select [Network Diagnostic], then press **+**.
- 9 Press **←/→** to select [Start], then press **+**.
- 10 Check that the message [Network connections are correct.] appears.

The setup is finished. If the message does not appear, follow the on-screen messages.

### To enter characters

The display for entering characters appears when you select [Proxy Server] in [Proxy Settings].

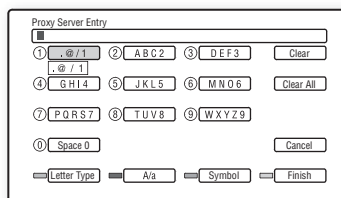

- 1 Press the number button repeatedly to select a character.  
Example:  
Press the number 3 button once to enter [D].  
Press the number 3 button three times to enter [F].
- 2 Press **→**, and enter the next character.
- 3 Press YELLOW ([Finish]) to finish.



You can use the following buttons to enter characters.

Buttons	Details
RED [Letter Type]	Switches the keyboard between alphabet and numbers.
GREEN [A/a]	Switches the keyboard between upper case and lower case.
BLUE [Symbol]	Displays the keyboard for symbols.
YELLOW [Finish]	The input is entered, and the system returns to the previous display.
CLEAR [Clear]/[Clear All]	Erases the character to the right of the cursor.  To erase all displayed characters, press and hold CLEAR for 2 seconds or more.
RETURN [Cancel]	Returns to the previous display, canceling the input.
←/↑/↓/→, ⊕	<ul style="list-style-type: none"> <li>• Select an input function using ←/↑/↓/→, and press ⊕.</li> <li>• Enter characters as follows:               <ol style="list-style-type: none"> <li>① Select a character selection panel using ←/↑/↓/→, and press ⊕.</li> <li>② Select a character using ←/→, and press ⊕.</li> </ol> </li> </ul>

## [Easy Setup]

You can recall the Easy Setup to make the basic settings.

- 1** Press ←/→ to select [Start], then press ⊕.
- 2** Follow the instructions for “Step 4: Performing the Easy Setup” (page 34) from step 4.

## [Resetting]

### Resetting the system settings other than the settings related to password

You can reset the system settings to their factory default. Settings can be reset by function group. All the settings within the group will be reset.

- 1 Press **+** to select [Reset to Factory Default Settings], then press **+**.
- 2 Press **↑/↓** to select the settings you want to reset to default, then press **+**.

You can reset the following settings:

- [Video Settings]
- [Audio Settings]
- [BD/DVD Viewing Settings] (except for the [BD Parental Control], [DVD Parental Control], [Parental Control Region Code], [Password] settings)
- [Photo Settings]
- [HDMI Settings]
- [System Settings]
- [Network Settings]
- [All Settings] (except for the [BD Parental Control], [DVD Parental Control], [Parental Control Region Code], [Password] settings)

The display asks for confirmation.

#### Note

- When [All Settings] is selected, all system settings other than the settings related to the password are reset, and the system turns off.
- Settings for “Adjusting pictures for videos” (page 47) are not reset.

- 3 Press **←/→** to select [Start], then press **+**.

To cancel, select [Cancel].

### Resetting all the system settings to the default

You can reset all the system settings to the default settings.

- 1 Press **+** to select [Reset to Factory Default Settings], then press **+**.
- 2 Press **↑/↓** to select [All Settings], then press **+**.  
The display asks for confirmation.
- 3 Press **■** and **VOLUME –** on the unit at the same time for more than 5 seconds.

All system settings are reset to the default settings, and the system turns off.

#### Note

- Settings for “Adjusting pictures for videos” (page 47) are not reset.

## Precautions

### On safety

- To prevent fire or shock hazard, do not place objects filled with liquids, such as vases, on the system, or place the system near water, such as near a bathtub or shower room. Should any solid object or liquid fall into the cabinet, unplug the system and have it checked by qualified personnel before operating it any further.
- Do not touch the AC power cord (mains lead) with wet hands. Doing so may cause an electric shock.

### On power sources

- Unplug the unit from the wall outlet (mains) if you do not intend to use it for an extended period of time. To disconnect the cord, pull it out by the plug, never by the cord.

### On placement

- Place the system in a location with adequate ventilation to prevent heat build-up in the system.
- At high volume, over long periods of time, the cabinet becomes hot to the touch. This is not a malfunction. However, touching the cabinet should be avoided. Do not place the system in a confined space where ventilation is poor as this may cause overheating.
- Do not block the ventilation slots by putting anything on the system. The system is equipped with a high power amplifier. If the ventilation slots are blocked, the system can overheat and malfunction.
- Do not place the system on surfaces (rugs, blankets, etc.) or near materials (curtains, draperies) that may block the ventilation slots.
- Do not install the system in a confined space, such as a bookshelf or similar unit.
- Do not install the system near heat sources such as radiators, air ducts, or in a place subject to direct sunlight, excessive dust, mechanical vibration, or shock.
- Do not install the system in an inclined position. It is designed to be operated in a horizontal position only.
- Keep the system and discs away from components with strong magnets, such as microwave ovens, or large loudspeakers.
- Do not place heavy objects on the system.

### On operation

- If the system is brought directly from a cold to a warm location, or is placed in a very damp room, moisture may condense on the lenses inside the unit. Should this occur, the system may not operate properly. In this case, remove the disc and leave the system turned on for about half an hour until the moisture evaporates.
- When you move the system, take out any disc. If you don't, the disc may be damaged.
- If anything falls into the cabinet, unplug the unit and have it checked by qualified personnel before operating it any further.

### On adjusting volume

- Do not turn up the volume while listening to a section with very low level inputs or no audio signals. If you do, the speakers may be damaged when a peak level section is suddenly played.

### On cleaning

- Clean the cabinet, panel, and controls with a soft cloth slightly moistened with a mild detergent solution. Do not use any type of abrasive pad, scouring powder or solvent such as alcohol or benzene.  
If you have any questions or problems concerning your system, please consult your nearest Sony dealer.

### On cleaning discs, disc/lens cleaners

- **Do not use cleaning discs or disc/lens cleaners (including wet or spray types). These may cause the apparatus to malfunction.**

### On replacement of parts

- In the events that this system is repaired, repaired parts may be collected for reuse or recycling purposes.

### On your TV's color

- If the speakers should cause the TV screen to have color irregularity, turn off the TV then turn it on after 15 to 30 minutes. If color irregularity should persist, place the speakers further away from the TV set.

#### IMPORTANT NOTICE

Caution: This system is capable of holding a still video image or on-screen display image on your television screen indefinitely. If you leave the still video image or on-screen display image displayed on your TV for an extended period of time you risk permanent damage to your television screen. Projection televisions are especially susceptible to this.

## On moving the system

Before moving the system, make sure that there is no disc inserted, and remove the AC power cord (mains lead) from the wall outlet (mains).

## About S-AIR function

- As the S-AIR function transmits sound by radio waves, heed the following:
  - Sound may skip when radio waves are obstructed. This is a characteristic of radio waves and is not malfunction.
  - Equipment that generates electromagnetic energy, such as a microwave oven, may interfere with sound transmission.
- As the S-AIR function uses the radio waves that share the same frequency as other wireless systems, such as wireless LAN or Bluetooth, interference or poor transmission may result. In this case, take the following steps:
  - Do not install the system near other wireless systems.
  - Do not use the system and the other wireless systems at the same time.
- The transmission distance differs depending on the usage environment. Find a location where transmission between the S-AIR main unit and sub unit is most effective, and install the S-AIR main unit and sub unit there.

# Notes about the Discs

## On handling discs

- To keep the disc clean, handle the disc by its edge. Do not touch the surface.
- Do not stick paper or tape on the disc.



- Do not expose the disc to direct sunlight or heat sources such as hot air ducts, or leave it in a car parked in direct sunlight as the temperature may rise considerably inside the car.
- After playing, store the disc in its case.

## On cleaning

- Before playing, clean the disc with a cleaning cloth. Wipe the disc from the center out.



- Do not use solvents such as benzine, thinner, commercially available cleaners, or anti-static spray intended for vinyl LPs.

This system can only playback a standard circular disc. Using neither standard nor circular discs (e.g., card, heart, or star shape) may cause a malfunction.

Do not use a disc that has a commercially available accessory attached, such as a label or ring.

# Troubleshooting

If you experience any of the following difficulties while using the system, use this troubleshooting guide to help remedy the problem before requesting repairs. Should any problem persist, consult your nearest Sony dealer.

Note that if service personnel changes some parts during repair, these parts may be retained.

In the event of a problem with the S-AIR function, have a Sony dealer check the entire system together (S-AIR main unit and sub unit).

## Power

Symptom	Remedy
The power is not turned on.	<ul style="list-style-type: none"><li>• Check that the AC power cord (mains lead) is connected securely.</li><li>• Press <b>I/⏻</b> after “STANDBY” disappears from the front panel display.</li></ul>
If “PROTECTOR” and “PUSH POWER” appear alternately in the front panel display.	<p>Press <b>I/⏻</b> to turn off the system, and check the following items after “STANDBY” disappears.</p> <ul style="list-style-type: none"><li>• Are the + and – speaker cords short-circuited?</li><li>• Are you using only the specified speakers?</li><li>• Is anything blocking the ventilation holes of the system?</li><li>• After checking the above items and fixing any problems, turn on the system. If the cause of the problem cannot be found even after checking all the above items, consult your nearest Sony dealer.</li></ul>

## Picture

Symptom	Remedy
There is no picture.	<ul style="list-style-type: none"><li>• The video connecting cords are not connected securely.</li><li>• The video connecting cords are damaged.</li><li>• The unit is not connected to the correct TV input jack (page 24).</li><li>• The video input on the TV is not set so that you can view pictures from the system.</li><li>• Check the output method on your system (page 24).</li><li>• Re-connect the connecting cord securely.</li><li>• The unit is connected to an input device that is not HDCP (High-bandwidth Digital Content Protection) compliant (“HDMI” on the front panel does not light up) (page 24).</li><li>• When playing a double-layer DVD, the video and audio may be momentarily interrupted at the point where the layers switch.</li></ul>
No picture appears when the video output resolution selected in [Output Video Format] is incorrect.	<ul style="list-style-type: none"><li>• Press and hold <b>▶</b> and <b>▲</b> on the unit for more than 5 seconds to reset the video output resolution to the lowest resolution.</li></ul>
Video signals are not output from the jacks, other than from the HDMI OUT jack, when connecting the HDMI OUT jack and other video output jacks at the same time.	<ul style="list-style-type: none"><li>• Set [Output Video Format] to [Component Video] (page 81).</li></ul>
The dark area of the picture is too dark/the bright area is too bright or unnatural.	<ul style="list-style-type: none"><li>• Set [Picture Quality Mode] to [Standard] (default) (page 47).</li></ul>

Symptom	Remedy
The picture is not output correctly.	<ul style="list-style-type: none"> <li>• Check the [Output Video Format] settings (page 81).</li> </ul>
Picture noise appears.	<ul style="list-style-type: none"> <li>• The disc is dirty or flawed.</li> <li>• If the picture output from your system goes through your VCR to get to your TV, the copy-protection signal applied to some BD/DVD programs could affect picture quality. If you still experience problems even when you connect your unit directly to your TV, try connecting your unit to the other input jacks.</li> </ul>
Even though you set the aspect ratio in [TV Type] of [Video Settings], the picture does not fill the TV screen.	<ul style="list-style-type: none"> <li>• The aspect ratio on the disc is fixed.</li> </ul>
Color irregularity occurs on the TV screen.	<ul style="list-style-type: none"> <li>• If the speakers are used with a CRT-based TV or projector, install the speakers at least 1.0 ft (0.3 meters) from the TV set.</li> <li>• If the color irregularity persists, turn off the TV set once, then turn it on after 15 to 30 minutes.</li> <li>• If howling occurs, reposition the speakers farther away from the TV set.</li> <li>• Make sure that no magnetic object (magnetic latch on a TV stand, health care device, toy, etc.) is placed near the speakers.</li> </ul>

## Sound

Symptom	Remedy
There is no sound.	<ul style="list-style-type: none"> <li>• The speaker cord is not connected securely.</li> <li>• Press MUTING on the remote if “MUTING ON” is displayed in the front panel display.</li> <li>• The system is in pause mode. Press ► to return to normal play mode.</li> <li>• Fast forward or fast reverse is performed. Press ► to return to normal play mode.</li> <li>• Check the speaker settings (page 71).</li> <li>• Slow forward or freeze frame is performed. Press ► to return to normal play mode.</li> </ul>
No sound is output from the HDMI OUT jack.	<ul style="list-style-type: none"> <li>• The HDMI OUT jack is connected to a DVI (Digital Visual Interface) device jacks do not accept audio signals.</li> <li>• Try the following: ① Turn the system off and on again. ② Turn the connected component off and on again. ③ Disconnect and then connect an HDMI cable again.</li> <li>• Set [BD/DVD Audio Output] to [HDMI priority] (page 83).</li> </ul>
The left and right sounds are unbalanced or reversed.	<ul style="list-style-type: none"> <li>• Check that the speakers and components are connected correctly and securely.</li> </ul>
There is no sound from the subwoofer.	<ul style="list-style-type: none"> <li>• Check the speaker connections and settings (pages 22, 71).</li> </ul>
Severe hum or noise is heard.	<ul style="list-style-type: none"> <li>• Check that the speakers and components are connected securely.</li> <li>• Check that the connecting cords are away from a transformer or motor, and at least 10 feet (3 meters) away from your TV set or a fluorescent light.</li> <li>• Move your TV away from the audio components.</li> <li>• The plugs and jacks are dirty. Wipe them with a cloth slightly moistened with alcohol.</li> <li>• Clean the disc.</li> </ul>
The sound loses stereo effect when you play a CD.	<ul style="list-style-type: none"> <li>• Select stereo sound by pressing AUDIO (page 53).</li> <li>• Make sure the unit is connected properly.</li> </ul>

Symptom	Remedy
The surround effect is difficult to hear when you are playing a sound track of Dolby Digital, DTS, or MPEG audio.	<ul style="list-style-type: none"> <li>• Check the decoding mode setting (page 38).</li> <li>• Check the speaker connections and settings (pages 22, 71).</li> <li>• Depending on the BD/DVD, the output signal may not be the entire 5.1 channel. It may be monaural or stereo even if the sound track is recorded in Dolby Digital or MPEG audio format.</li> </ul>
The sound comes from the center speaker only.	<ul style="list-style-type: none"> <li>• Depending on the disc, the sound may come from the center speaker only.</li> </ul>
No sound is heard from the center speaker.	<ul style="list-style-type: none"> <li>• Check the speaker connections and settings (pages 22, 71).</li> <li>• Check the decoding mode setting (page 38).</li> <li>• Depending on the source, the effect of the center speaker may be less noticeable.</li> <li>• A 2 channel source is being played.</li> </ul>
No sound or only a very low-level sound is heard from the surround speakers.	<ul style="list-style-type: none"> <li>• Check the speaker connections and settings (pages 22, 71).</li> <li>• Check the decoding mode setting (page 38).</li> <li>• Depending on the source, the effect of the surround speakers may be less noticeable.</li> <li>• Check the wireless setting (page 32).</li> <li>• A 2 channel source is being played.</li> </ul>
The beginning of the sound is cut off.	<ul style="list-style-type: none"> <li>• Set the sound mode to "MOVIE" or "MUSIC" (page 52).</li> <li>• Select "A.F.D. STD" for the decoding mode (page 38).</li> </ul>
The sound effects are disabled.	<ul style="list-style-type: none"> <li>• The effects of SOUND MODE, DYNAMIC BASS, NIGHT, "TONE," and "DEC. MODE" may be disabled depending on the input stream (page 83).</li> </ul>
Distortion occurs in the sound of a connected component.	<ul style="list-style-type: none"> <li>• Reduce the input level for the connected component by setting [Attenuate - TV] or [Attenuate - AUDIO] (page 82).</li> </ul>

## Operation

Symptom	Remedy
Radio stations cannot be tuned in.	<ul style="list-style-type: none"> <li>• Check that the antenna (aerial) is connected securely. Adjust the antenna (aerial) or connect an external antenna (aerial) if necessary.</li> <li>• The signal strength of the stations is too weak (when tuning in with automatic tuning). Use direct tuning.</li> <li>• No stations have been preset or the preset stations have been cleared (when tuning by scanning preset stations). Preset the stations (page 56).</li> <li>• Press DISPLAY so that the frequency appears in the front panel display.</li> </ul>
Noise is heard on AM radio.	<ul style="list-style-type: none"> <li>• Check the location of the AM loop antenna (aerial) and cord (page 27).</li> </ul>
The remote does not function.	<ul style="list-style-type: none"> <li>• There are obstacles between the remote and the unit.</li> <li>• The distance between the remote and the unit is too far.</li> <li>• The remote is not pointed at the remote sensor on the unit.</li> <li>• The batteries in the remote are weak.</li> <li>• When you cannot perform menu operations via the front panel display, press HOME on the remote.</li> </ul>

Symptom	Remedy
The disc does not play.	<ul style="list-style-type: none"> <li>• The disc is dirty.</li> <li>• There is no disc inserted.</li> <li>• The disc is upside down. Insert the disc with the playback side facing down.</li> <li>• The disc is skewed on the disc tray.</li> <li>• You are attempting to play a disc with a format that cannot be played back by this system (page 101).</li> <li>• The region code on the BD/DVD does not match the system.</li> <li>• Moisture has condensed inside the unit and may cause damage to the lenses. Remove the disc and leave the unit turned on for about half an hour.</li> <li>• The system cannot play a recorded disc that is not correctly finalized (page 101).</li> </ul>
File names are not displayed correctly.	<ul style="list-style-type: none"> <li>• The system can only display ISO 8859-1-compliant character formats. Other character formats may be displayed differently.</li> <li>• Depending on the writing software used, the input characters may be displayed differently.</li> </ul>
A disc does not start playing from the beginning.	<ul style="list-style-type: none"> <li>• Resume Play has been selected. Press <b>OPTIONS</b> and select [Play from beginning], then press <b>⊕</b>.</li> <li>• The title or BD/DVD menu automatically appears on the TV screen.</li> </ul>
The system starts playing the disc automatically.	<ul style="list-style-type: none"> <li>• The BD/DVD features an auto playback function.</li> </ul>
Playback stops automatically.	<ul style="list-style-type: none"> <li>• Some discs may contain an auto pause signal. While playing such a disc, the system stops playback at the auto pause signal.</li> </ul>
You cannot perform some functions such as stop or search.	<ul style="list-style-type: none"> <li>• Depending on the disc, you may not be able to perform some of the operations above. Refer to the operating instructions supplied with the disc.</li> </ul>
Messages do not appear on the TV screen in the language you want.	<ul style="list-style-type: none"> <li>• In the Setup Display, select the desired language for the on-screen display in [OSD] in [System Settings] (page 87).</li> </ul>
The language for the soundtrack/subtitle or angles cannot be changed.	<ul style="list-style-type: none"> <li>• Try using the BD's or DVD's menu instead of the direct selection button on the remote (page 44).</li> <li>• Multi-lingual tracks/subtitles or multi-angles are not recorded on the BD or DVD being played.</li> <li>• The BD or DVD prohibits the changing of the language for the sound track/subtitle or angles.</li> </ul>
The disc tray does not open and you cannot remove the disc even after you press <b>▲</b> .	<ul style="list-style-type: none"> <li>• Try the following: ① Press and hold <b>VOLUME –</b> and <b>▲</b> on the unit for more than 5 seconds to open the disc tray. ② Remove the disc. ③ Disconnect the AC power cord (mains lead) from the wall outlet (mains), then reconnect after several minutes.</li> </ul>
A disc cannot be ejected and "LOCKED" appears in the front panel display.	<ul style="list-style-type: none"> <li>• Contact your Sony dealer or local authorized Sony service facility.</li> </ul>
The system does not work normally.	<ul style="list-style-type: none"> <li>• Disconnect the AC power cord (mains lead) from the wall outlet (mains), then reconnect after several minutes.</li> </ul>



Symptom	Remedy
The Control for HDMI function does not work.	<ul style="list-style-type: none"> <li>• When “HDMI” does not light up in the front panel display, check the HDMI connection (page 24).</li> <li>• Set [Control for HDMI] in [HDMI Settings] to [On] (page 86).</li> <li>• Make sure that the connected component is compatible with the [Control for HDMI] function.</li> <li>• Check that the AC power cord (mains lead) of the connected component is connected securely.</li> <li>• Check the connected component’s setting for the Control for HDMI function. Refer to the operating instructions supplied with the component.</li> <li>• If you change the HDMI connection, connect and disconnect the AC power cord (mains lead), or have a power failure, set [Control for HDMI] in [HDMI Settings] to [Off], then set [Control for HDMI] in [HDMI Settings] to [On] (page 86).</li> <li>• For details, see “Using the Control for HDMI Function for “BRAVIA” Sync” (page 67).</li> </ul>
No sound is output from the system and TV while using the System Audio Control function.	<ul style="list-style-type: none"> <li>• Make sure that the connected TV is compatible with the System Audio Control function.</li> <li>• For details, see “Using the Control for HDMI Function for “BRAVIA” Sync” (page 67).</li> </ul>
The external memory is not recognized.	<ul style="list-style-type: none"> <li>• Try the following: ① Turn the system off. ② Align the ▼ mark of the EXT slot with the ▼ mark on the external memory, and insert the external memory (USG1H only). ③ Turn the system on. ④ Check that the EXT indicator lights up in the front panel display.</li> </ul>
Bonus contents or other data that are contained in a BD-ROM cannot be played.	<ul style="list-style-type: none"> <li>• Try the following: ① Remove the disc. ② Turn the system off. ③ Remove and re-insert the external memory (page 29). ④ Turn the system on. ⑤ Check that the EXT indicator lights up in the front panel display. ⑥ Insert the BD-ROM with BonusView/BD-Live.</li> </ul>
A message indicating that the local storage does not have enough space appears on the screen.	<ul style="list-style-type: none"> <li>• Delete unnecessary data in the external memory (page 48).</li> </ul>
The unit does not work and “CHILD LOCK” appears in the front panel display when you press any button on the unit.	<ul style="list-style-type: none"> <li>• Set the child lock function to off (page 76).</li> </ul>
The system menu does not work.	<ul style="list-style-type: none"> <li>• Press HOME on the remote.</li> </ul>

## The S-AIR function

Symptom	Remedy
S-AIR connection is not established (sound transmission is not established), e.g., the indicator of the S-AIR sub unit does the following: <ul style="list-style-type: none"><li>• Turns off.</li><li>• Flashes.</li><li>• Turns red.</li></ul>	<ul style="list-style-type: none"><li>• If you use another S-AIR main unit, place it more than 26 1/4 feet (8 meters) away from the unit.</li><li>• Confirm the ID of the unit and S-AIR sub unit (page 61).</li><li>• You performed pairing the unit and another S-AIR sub unit. Perform pairing of the desired S-AIR sub unit (page 64).</li><li>• The unit is paired to another S-AIR sub unit. To cancel pairing, reset the ID of the unit and S-AIR sub unit (page 61).</li><li>• Install the S-AIR main unit and S-AIR sub unit away from other wireless products.</li><li>• Stop using another wireless product.</li><li>• The S-AIR sub unit is turned off. Make sure the AC power cord (mains lead) is connected and turn on the S-AIR sub unit.</li></ul>
No sound is heard from the S-AIR sub unit.	<ul style="list-style-type: none"><li>• If you use another S-AIR main unit, place it more than 26 1/4 feet (8 meters) away from the unit.</li><li>• Confirm the ID of the unit and S-AIR sub unit (page 61).</li><li>• Confirm the pairing setting (page 64).</li><li>• Install the S-AIR main unit and S-AIR sub unit closer together.</li><li>• Avoid use of equipment that generates electromagnetic energy, such as a microwave oven.</li><li>• Install the S-AIR main unit and S-AIR sub unit away from other wireless products.</li><li>• Stop using another wireless product.</li><li>• Change the "RF CHANGE" setting (page 65).</li><li>• Change the ID settings of the S-AIR main unit and S-AIR sub unit.</li><li>• Turn off the system and S-AIR sub unit, then turn on them.</li></ul>
There is noise or the sound skips.	<ul style="list-style-type: none"><li>• If you use another S-AIR main unit, place it more than 26 1/4 feet (8 meters) away from the unit.</li><li>• Install the S-AIR main unit and S-AIR sub unit closer together.</li><li>• Avoid use of equipment that generates electromagnetic energy, such as a microwave oven.</li><li>• Install the S-AIR main unit and S-AIR sub unit away from other wireless products.</li><li>• Stop using another wireless product.</li><li>• Change the "RF CHANGE" setting (page 65).</li><li>• Change the ID settings of the S-AIR main unit and S-AIR sub unit.</li></ul>

## Surround amplifier operation

If no sound is output from the surround speakers, check the status of the POWER / ON LINE indicator on the surround amplifier. For details of the POWER / ON LINE indicator, see “Step 3: Setting up the Wireless System” (page 32).

Symptom	Remedy
The power is not turned on.	<ul style="list-style-type: none"> <li>• Check that the AC power cord (mains lead) is connected securely.</li> </ul>
The POWER / ON LINE indicator does not turn on.	<p>Turn off the surround amplifier and remove the AC power cord (mains lead) of the surround amplifier, then check the following items.</p> <ul style="list-style-type: none"> <li>• Are the + and – speaker cords short-circuited?</li> <li>• Is anything blocking the ventilation holes of the surround amplifier?</li> </ul> <p>After checking the above items and fixing any problems, connect the AC power cord (mains lead) of the surround amplifier and turn on the surround amplifier. If the cause of the problem cannot be found even after checking all the above items, consult your nearest Sony dealer.</p>
There is no sound. Check the status of the POWER / ON LINE indicator on the surround amplifier.	<ul style="list-style-type: none"> <li>• turns green           <ul style="list-style-type: none"> <li>– Check the speaker connections and settings.</li> <li>– The volume of the unit is set to minimum.</li> <li>– The unit is in muting status.</li> <li>– Depending on the source or the settings of the unit, the effect of the speakers may be less noticeable.</li> <li>– Headphones are connected.</li> </ul> </li> <li>• flashes green           <ul style="list-style-type: none"> <li>– The unit is not turned on.</li> <li>– You performed pairing the unit and another S-AIR sub unit.</li> <li>– The surround amplifier is paired to another S-AIR main unit.</li> <li>– Confirm the IDs of the unit and surround amplifier (page 61).</li> <li>– Pairing operation is not completed.</li> <li>– Sound transmission is poor.               <ul style="list-style-type: none"> <li>Move the surround amplifier so that the POWER / ON LINE indicator turns green.</li> </ul> </li> <li>– Install the unit and surround amplifier apart from another wireless product.</li> <li>– Stop using another wireless product.</li> <li>– The wireless transceiver(s) is/are not inserted correctly.</li> </ul> </li> <li>• turns red           <ul style="list-style-type: none"> <li>– Change the SURROUND SELECTOR switch (SURROUND or SURROUND BACK) of the surround amplifier to match the unit.</li> </ul> </li> </ul>
“HP NO LINK” and “VOLUME MIN” appear alternately in the front panel display, and the volume of the unit becomes minimum.	<ul style="list-style-type: none"> <li>• Volume becomes the minimum when you turn off the surround amplifier with headphones connected before you turn off the unit or if radio reception is poor. In these cases, check radio reception, and set the volume again.</li> </ul>

---

# Self-diagnosis Function

When the self-diagnosis function is activated to prevent the system from malfunctioning, an error code appears in the front panel display, or just  appears without any messages on the entire screen. In these cases, check the following.

## When an error code appears in the front panel display

---

















Error code	Corrective action
Exxxx	Contact your nearest Sony dealer or local authorized Sony service facility and give the error code.
SYSTEM ERR UPDATE NG	Turn off the system and disconnect the AC power cord (mains lead) from the wall outlet (mains), then reconnect and turn the system on. If the system does not work normally, consult your nearest Sony dealer or local authorized Sony service facility.

---

## When just appears without any messages on the entire screen

Contact your nearest Sony dealer or local authorized Sony service facility.

# Playable Discs

Type	Disc logo	Characteristics	Icon
Blu-ray Disc		BD-ROMs and BD-REs/BD-Rs in BDMV and BDAV mode, including 8 cm discs (single layer) and DL discs	
DVD VIDEO		Discs such as movies that can be purchased or rented	
DVD/DATA DVD	    	DVD+RWs/DVD+Rs in +VR mode or DVD-RWs/DVD-Rs in video and VR mode, including 8 cm discs (single layer) and DVD+R DL/DVD-R DL discs  DVD+RWs/DVD+Rs/DVD-RWs/DVD-Rs containing JPEG* image files	  
AVCHD		Discs recorded in AVCHD format**	
CD		Music CDs or CD-Rs/CD-RWs in music CD format	
DATA CD	—	CD-Rs/CD-RWs containing JPEG image files	

\* JPEG format conforming to UDF (Universal Disk Format).

\*\* Some AVCHD format discs may not play, depending on the recording condition. The AVCHD format disc will not play if it has not been correctly finalized.

## Notes about BD-ROM compatibility

Since the Blu-ray Disc specifications are new and evolving, some discs may not be playable depending on the disc type and the version.

The audio output differs depending on the source, connected output jack, and selected audio settings.

## Discs that cannot be played

- BDs with cartridge
- DVD-RAMs
- HD DVDs
- DVD Audio discs
- PHOTO CDs
- Data part of CD-Extras
- VCDs/Super VCDs
- HD layer on Super Audio CDs
- BD-ROMs/DVD VIDEOS with a different region code (page 102).

- A disc recorded in a color system other than NTSC, such as PAL (this system conforms to the NTSC color system).

### **Note on playback operations of a BD/DVD**

Some playback operations of a BD/DVD may be intentionally set by software producers. Since this system plays a BD/DVD according to the disc contents the software producers designed, some playback features may not be available. Refer to the instructions supplied with the BD/DVD.

### **Region code (BD-ROM/DVD VIDEO only)**

Your system has a region code printed on the rear of the unit and will only play a BD-ROM/DVD VIDEO (playback only) labeled with identical region codes. This system is used to protect copyrights. DVD VIDEO labeled  will also play on this system.

If you try to play any other DVD VIDEO, the message [Playback prohibited by region code.] will appear on the TV screen. Depending on the BD-ROM/DVD VIDEO, no region code may be indicated even though playing the BD-ROM/DVD VIDEO is prohibited by area restrictions.

### **Notes about BD-REs/BD-Rs, DVD+RWs/DVD+Rs, DVD-RWs/DVD-Rs, or CD-Rs/CD-RWs**

Some BD-REs/BD-Rs, DVD+RWs/DVD+Rs, DVD-RWs/DVD-Rs, or CD-Rs/CD-RWs cannot be played on this system due to the recording quality or physical condition of the disc, or the characteristics of the recording device and authoring software. The BD-Rs recorded on a PC cannot be played if postscripts are recordable.

A CD or DVD disc will not play if it has not been correctly finalized. For more information, refer to the operating instructions supplied with the recording device. Note that some playback functions may not work with some DVD+RWs/DVD+Rs, even if they have been correctly finalized. In this case, view the disc using normal playback.

### **Notes on discs**

This product is designed to playback discs that conform to the Compact Disc (CD) standard. DualDiscs and some of the music discs encoded with copyright protection technologies do not conform to the Compact Disc (CD) standard, therefore, these discs may not be playable by this product.

### **Note about double-layer DVDs**

The playback pictures and sound may be momentarily interrupted when the layers switch.

### **Note about 8 cm BD-REs/8 cm BD-Rs**

Some 8 cm BD-REs/8 cm BD-Rs cannot be played on this system.

### **Note about BD-REs/BD-Rs**

This system supports Ver. 2.1 BD-RE and Ver. 1.1 and 1.2 BD-R including organic pigment type BD-R (LTH type).

# Supported Audio Formats

Audio formats supported by this system are as follows.

Function	Format							
	LPCM 2ch	LPCM 5.1ch, LPCM 7.1ch	Dolby Digital	Dolby TrueHD, Dolby Digital Plus	DTS	DTS-ES Discrete 6.1, DTS-ES Matrix 6.1, DTS96/24	DTS-HD High Resolution Audio	DTS-HD Master Audio
"BD/DVD"	○	○	○	○	○	○*	○	○
"SAT/CABLE" "TV" (DIGITAL IN)	○	-	○	-	○	-	-	-

○: Supported format.

-: Unsupported format.

\* BD only.

**Note**

- The table above is valid only when you set [BD Audio Setting] to [Direct] (page 82) and [Sound Effect] to [Off] (page 83). If another setting is used, depending on the audio format, sound may be decoded to a suitable format automatically.

# Video Output Resolution

Output resolution differs depending on the [Output Video Format] setting in [Video Settings] (page 80).

Resolution setting	When [Output Video Format] is set to [HDMI]			When [Output Video Format] is set to [Component Video]		
	VIDEO OUT jack	COMPONENT VIDEO OUT jack	HDMI OUT jack	VIDEO OUT jack	COMPONENT VIDEO OUT jacks	HDMI OUT jack
<b>480i</b>	480i	480i	480i	480i	480i	480i
<b>480p</b>	480i	480i	480p	480i	480p	480p
<b>720p</b>	480i	480i	720p	480i	720p*	720p*
<b>1080i</b>	480i	480i	1080i	480i	1080i*	1080i*
<b>1080p</b>	no picture	no picture	1080p	unselectable	unselectable	unselectable

\* Protected contents on DVDs are output at 480p resolution.

## When [Output Video Format] is set to [Video]

480i video signals are output from the VIDEO OUT or COMPONENT VIDEO OUT jack, and 480p video signals are output from the HDMI OUT jack.

## About the video output resolution of the DIGITAL MEDIA PORT adapter

480i video signals are output from the VIDEO OUT jack regardless of the resolution setting, and video signals are not output from the HDMI OUT and COMPONENT VIDEO OUT jacks when playing contents via the DIGITAL MEDIA PORT adapter.



# Specifications

## Amplifier Section (BDV-T20W)

### POWER OUTPUT AND TOTAL HARMONIC

#### DISTORTION:

(FTC Output Power)

for the US model

Front L/Front R:

With 3 ohms loads, both channels driven, from 180 - 20,000 Hz; rated 56 watts per channel minimum RMS power, with no more than 0.7% total harmonic distortion from 250 milli watts to rated output.

Surround mode (reference) RMS output power

Front L/Front R/Center\*: 142 watts (per channel at 3 ohms, 1 kHz, 10% THD) Subwoofer\*: 140 watts (at 1.5 ohms, 80 Hz, 10% THD)

\* Depending on the decoding mode settings and the source, there may be no sound output.

## Amplifier Section (BDV-E500W)

### POWER OUTPUT AND TOTAL HARMONIC

#### DISTORTION:

(FTC Output Power)

for the US model

Front L/Front R:

With 3 ohms loads, both channels driven, from 180 - 20,000 Hz; rated 56 watts per channel minimum RMS power, with no more than 0.7% total harmonic distortion from 250 milli watts to rated output.

U.S. models:

Surround mode (reference) RMS output power

Front L/Front R/Center\*: 143 watts (per channel at 3 ohms, 1 kHz, 10% THD) Subwoofer\*: 285 watts (at 1.5 ohms, 80 Hz, 10% THD)

Other models:

Stereo mode (rated)

108 W + 108 W (at 3 ohms, 1 kHz, 1% THD)

Surround mode (reference) RMS output power

Front L/Front R/Center\*: 143 watts (per channel at 3 ohms, 1 kHz, 10% THD) Subwoofer\*: 285 watts (at 1.5 ohms, 80 Hz, 10% THD)

\* Depending on the decoding mode settings and the source, there may be no sound output.

### Inputs (Analog)

TV (AUDIO IN)

Sensitivity: 450/250 mV

Impedance: 50 kilohms

AUDIO (AUDIO IN)

Sensitivity: 450/250 mV

Impedance: 50 kilohms

### Inputs (Digital)

TV (OPTICAL)

Impedance: -

SAT/CABLE (COAXIAL)

Impedance: 75 ohms

## Video Section

### Outputs

VIDEO: 1 Vp-p 75 ohms

COMPONENT:

Y: 1 Vp-p 75 ohms

P<sub>B</sub>/C<sub>B</sub>, Pr/Cr: 0.7 Vp-p 75 ohms

HDMI OUT: Type A (19 pin)

## BD/DVD/CD System

Signal format system

NTSC

## Tuner Section

System

PLL quartz-locked digital synthesizer

FM tuner section

Tuning range

87.5 MHz - 108.0 MHz (100 kHz step)

Antenna (aerial)

Antenna (aerial) terminals

FM wire antenna (aerial)

75 ohms, unbalanced

Intermediate frequency

10.7 MHz

AM tuner section

Tuning range

530 kHz - 1,710 kHz (with the interval set at 10 kHz) 531 kHz - 1,710 kHz (with the interval set at 9 kHz)

Antenna (aerial)

Intermediate frequency

AM loop antenna (aerial)

450 kHz

## Speakers (BDV-T20W)

### Front (SS-TSB94)

Speaker system	Full range Bass reflex
Speaker unit	65 mm (2 5/8 in) cone type
Rated impedance	3 ohms
Dimensions (approx.)	113 mm × 830 mm × 83 mm (4 1/2 in × 32 3/4 in × 3 3/8 in) (w/h/d) (without stand) 315 mm × 1,015 mm - 1,345 mm × 315 mm (12 1/2 in × 40 in - 53 in × 12 1/2 in) (w/h/d) (with stand)
Mass (approx.)	1.6 kg (3 lb 9 oz) (without stand) 3.3 kg (7 lb 5 oz) (with stand)

### Center (SS-CTB92)

Speaker system	Full range, Magnetically Shielded
Speaker unit	30 mm × 60 mm (1 3/16 in × 2 3/8 in) cone type
Rated impedance	3 ohms
Dimensions (approx.)	380 mm × 50 mm × 64 mm (15 in × 2 in × 2 5/8 in) (w/h/d)
Mass (approx.)	0.38 kg (14 oz)

### Surround (SS-TSB95)

Speaker system	Full range Bass reflex
Speaker unit	65 mm (2 5/8 in) cone type
Rated impedance	3 ohms
Dimensions (approx.)	102 mm × 163 mm × 77 mm (4 1/8 in × 6 1/2 in × 3 1/8 in) (w/h/d)
Mass (approx.)	0.52 kg (1 lb 3 oz)

### Subwoofer (SS-WSB92)

Speaker system	Subwoofer Bass reflex
Speaker unit	160 mm (6 3/8 in) cone type
Rated impedance	1.5 ohms
Dimensions (approx.)	220 mm × 395 mm × 325 mm (8 3/4 in × 15 5/8 in × 12 7/8 in) (w/h/d)
Mass (approx.)	5.6 kg (12 lb 6 oz)

## Speakers (BDV-E500W)

### Front (SS-TSB91)

Speaker system	2-Way 2-Driver, Bass reflex
Speaker unit	Tweeter: 20 mm (13/16 in) cone type Woofer: 65 mm (2 5/8 in) cone type
Rated impedance	3 ohms
Dimensions (approx.)	115 mm × 640 mm × 85 mm (4 5/8 in × 25 1/4 in × 3 3/8 in) (w/h/d) (wall-mounted part) 295 mm × 1,190 mm × 295 mm (11 5/8 in × 46 7/8 in × 11 5/8 in) (w/h/d) (whole speaker)
Mass (approx.)	1.5 kg (3 lb 5 oz) (wall-mounted part) 3.7 kg (8 lb 3 oz) (whole speaker)

### Center (SS-CTB91)

Speaker system	Full range, Magnetically Shielded
Speaker unit	30 mm × 60 mm (1 3/16 in × 2 3/8 in) cone type
Rated impedance	3 ohms
Dimensions (approx.)	380 mm × 51 mm × 68 mm (15 in × 2 1/8 in × 2 3/4 in) (w/h/d)
Mass (approx.)	0.4 kg (15 oz)

### Surround (SS-TSB92)

Speaker system	Full range Bass reflex
Speaker unit	65 mm (2 5/8 in) cone type
Rated impedance	3 ohms
Dimensions (approx.)	105 mm × 225 mm × 85 mm (4 1/4 in × 8 7/8 in × 3 3/8 in) (w/h/d)
Mass (approx.)	0.6 kg (1 lb 6 oz)

### Subwoofer (SS-WSB91)

Speaker system	Subwoofer Bass reflex
Speaker unit	180 mm (7 1/8 in) cone type
Rated impedance	1.5 ohms
Dimensions (approx.)	225 mm × 395 mm × 325 mm (8 7/8 in × 15 5/8 in × 12 7/8 in) (w/h/d)
Mass (approx.)	6.2 kg (13 lb 11 oz)

**General**

Power requirements	120 V AC, 60 Hz
Power consumption	On: 120 W Standby: 0.3 W (at the Power Saving mode)
Output voltage/current (DIGITAL MEDIA PORT)	DC 5 V/700 mA
LAN (100) EXT	100BASE-TX Terminal External memory slot (For connecting the external memory) DC output: 5 V 500 mA Max
Dimensions (approx.)	430 mm × 93 mm × 400 mm (17 in × 3 3/4 in × 15 3/4 in) (w/h/d) incl. projecting parts 430 mm × 93 mm × 430 mm (17 in × 3 3/4 in × 17 in) (w/h/d) (incl. Wireless transceiver)
Mass (approx.)	5.4 kg (11 lb 15 oz)

**Surround amplifier (TA-SA100WR)**

Amplifier Section (BDV-T20W)

**AUDIO POWER SPECIFICATIONS**

for the US model

**POWER OUTPUT AND TOTAL HARMONIC DISTORTION:**

With 3 ohms loads, both channels driven, from 180 - 20,000 Hz; rated 50 watts per channel minimum RMS power, with no more than 0.7% total harmonic distortion from 250 milli watts to rated output.

Surround mode (reference)	RMS output power 142 W (per channel at 3 ohms, 1 kHz, 10% THD)*
---------------------------	--

\* *Depending on the source, there may be no sound output.*

Amplifier Section (BDV-E500W)

**AUDIO POWER SPECIFICATIONS**

for the US model

**POWER OUTPUT AND TOTAL HARMONIC DISTORTION:**

With 3 ohms loads, both channels driven, from 180 - 20,000 Hz; rated 50 watts per channel minimum RMS power, with no more than 0.7% total harmonic distortion from 250 milli watts to rated output.

U.S. models:

Surround mode (reference)	RMS output power 143 W (per channel at 3 ohms, 1 kHz, 10% THD)*
Other models:	
Stereo mode (rated)	80 W + 80 W (at 3 ohms, 1 kHz, 1% THD)
Surround mode (reference)	RMS output power 143 W (per channel at 3 ohms, 1 kHz, 10% THD)*

\* *Depending on the source, there may be no sound output.*

Rated impedance	3 - 16 Ω
-----------------	----------

**General**

Power requirements	120 V AC, 60 Hz
Power consumption	On: 50 W
Dimensions (approx.)	85 mm × 100 mm × 330 mm (3 3/8 in × 4 in × 13 in) (w/h/d) (incl. Wireless transceiver) 85 mm × 100 mm × 345 mm (3 3/8 in × 4 in × 13 5/8 in) (w/h/d) incl. speaker cord cover and speaker cord holder
Mass (approx.)	1.7 kg (3 lb 12 oz) incl. speaker cord cover and speaker cord holder

**Wireless transceiver (EZW-RT10/EZW-RT10A)**

Communication system	S-AIR Specification version 1.0
Frequency band	2.4000 GHz - 2.4835 GHz
Modulation method	DSSS
Power requirements	DC 3.3 V, 350 mA
Dimensions (approx.)	50 mm × 13 mm × 60 mm (2 in × 17/32 in × 2 3/8 in) (w/h/d)
Mass (approx.)	24 g (1 oz)

Design and specifications are subject to change without notice.

- Standby power consumption 0.3 W.
- Halogenated flame retardants are not used in the certain printed wiring boards.
- Over 85% power efficiency of amplifier block is achieved with the full digital amplifier, S-Master.

# Language Code List

The language spellings conform to the ISO 639: 1988 (E/F) standard.

Code Language	Code Language	Code Language	Code Language
1027 Afar	1183 Irish	1347 Maori	1507 Samoan
1028 Abkhazian	1186 Scots Gaelic	1349 Macedonian	1508 Shona
1032 Afrikaans	1194 Galician	1350 Malayalam	1509 Somali
1039 Amharic	1196 Guarani	1352 Mongolian	1511 Albanian
1044 Arabic	1203 Gujarati	1353 Moldavian	1512 Serbian
1045 Assamese	1209 Hausa	1356 Marathi	1513 Siswati
1051 Aymara	1217 Hindi	1357 Malay	1514 Sesotho
1052 Azerbaijani	1226 Croatian	1358 Maltese	1515 Sundanese
1053 Bashkir	1229 Hungarian	1363 Burmese	1516 Swedish
1057 Byelorussian	1233 Armenian	1365 Nauru	1517 Swahili
1059 Bulgarian	1235 Interlingua	1369 Nepali	1521 Tamil
1060 Bihari	1239 Interlingue	1376 Dutch	1525 Telugu
1061 Bislama	1245 Inupiak	1379 Norwegian	1527 Tajik
1066 Bengali; Bangla	1248 Indonesian	1393 Occitan	1528 Thai
1067 Tibetan	1253 Icelandic	1403 (Afan)Oromo	1529 Tigrinya
1070 Breton	1254 Italian	1408 Oriya	1531 Turkmen
1079 Catalan	1257 Hebrew	1417 Punjabi	1532 Tagalog
1093 Corsican	1261 Japanese	1428 Polish	1534 Setswana
1099 Czech	1269 Yiddish	1435 Pashto;	1535 Tonga
1103 Welsh	1283 Javanese	Pushto	1538 Turkish
1105 Danish	1287 Georgian	1436 Portuguese	1539 Tsonga
1109 German	1297 Kazakh	1463 Quechua	1540 Tatar
1130 Bhutani	1298 Greenlandic	1481 Rhaeto-	1543 Twi
1142 Greek	1299 Cambodian	Romance	1557 Ukrainian
1144 English	1300 Kannada	1482 Kirundi	1564 Urdu
1145 Esperanto	1301 Korean	1483 Romanian	1572 Uzbek
1149 Spanish	1305 Kashmiri	1489 Russian	1581 Vietnamese
1150 Estonian	1307 Kurdish	1491 Kinyarwanda	1587 Volapük
1151 Basque	1311 Kirghiz	1495 Sanskrit	1613 Wolof
1157 Persian	1313 Latin	1498 Sindhi	1632 Xhosa
1165 Finnish	1326 Lingala	1501 Sangho	1665 Yoruba
1166 Fiji	1327 Laothian	1502 Serbo-	1684 Chinese
1171 Faroese	1332 Lithuanian	Croatian	1697 Zulu
1174 French	1334 Latvian;	1503 Singhalese	
1181 Frisian	Lettish	1505 Slovak	
	1345 Malagasy	1506 Slovenian	1703 Not specified

## Parental Control/Area Code List

Code Area	Code Area	Code Area	Code Area
2044 Argentina	2165 Finland	2362 Mexico	2149 Spain
2047 Australia	2174 France	2376 Netherlands	2499 Sweden
2046 Austria	2109 Germany	2390 New Zealand	2086 Switzerland
2057 Belgium	2248 India	2379 Norway	2528 Thailand
2070 Brazil	2238 Indonesia	2427 Pakistan	2184 United Kingdom
2079 Canada	2254 Italy	2424 Philippines	
2090 Chile	2276 Japan	2436 Portugal	
2092 China	2304 Korea	2489 Russia	
2115 Denmark	2363 Malaysia	2501 Singapore	

# Terms and Conditions of Use and End User License Agreement

The Sony Blu-ray Disc player ("Product") and associated software ("Software") are provided and maintained by Sony Electronics Inc. and its affiliates ("Sony"). Sony also provides and maintains associated service (the "Service"), including any subsite accessible through the Service's Internet homepage (the "Site"). The Software includes software embedded in the Product; stored on any media, bundled with the Product or otherwise provided by Sony; downloaded from the Site or otherwise made accessible or provided by Sony; any such media and any printed or "on-line" or electronic documentation associated with the Product and all updates and upgrades thereto.

WHEN YOU ACCESS, BROWSE, OR USE THE SERVICE, PRODUCT, SOFTWARE, AND/OR SITE, YOU ACCEPT, WITHOUT LIMITATION OR QUALIFICATION, THE TERMS AND CONDITIONS SET FORTH HEREIN, SONY'S PRIVACY POLICY POSTED ON THE SITE, AND ANY ADDITIONAL TERMS AND CONDITIONS OF USE SET FORTH IN ANY PORTION OF THE SERVICE AND SITE (COLLECTIVELY THE "AGREEMENT"). IF YOU DO NOT AGREE WITH THE TERMS AND CONDITIONS OF THIS AGREEMENT, SONY DOES NOT GRANT THE LIMITED RIGHTS HEREIN, AND PLEASE DO NOT USE THE SERVICE, PRODUCT, SOFTWARE, AND/OR SITE.

## 1. Ownership

The Software and all materials on the Service and/or Site, including but not limited to images, software and text (the "Content") are protected by copyright under U.S. copyright law, international conventions, and other copyright laws. You cannot use the Software, Service, Product, Content, and Site except as specified herein. There may be proprietary logos, service marks, and trademarks found on this Service or Site. By making them available on the Service and/or Site, Sony is not granting you any license to utilize those proprietary logos, service marks, or trademarks. Any unauthorized use of the Service, Site, Content or Software may violate copyright laws, trademark laws, the laws of privacy and publicity, and civil and criminal statutes. All title and copyright in and to the Software or materials on the Service/Site and any copies of the Software, are owned by Sony, its licensors, or suppliers. All rights not specifically granted under this Agreement are reserved by Sony, its licensors, and suppliers.

## 2. Your Rights & Limited License

The Service, Site, Software, Content, and Product are only for your personal use. You are responsible for all your activities hereunder, including all legal liability incurred from your use of the Service or others who use the Service via your Product or Account (as defined below). You may use the Service, Site, Software, Content and Product for lawful purposes only. You may not distribute, exchange, modify, sell, or transmit anything you may copy from the Service or Site, including but not limited to any text, images, audio, and video, for any business, commercial, or public purpose. As long as you comply with the terms of this Agreement, Sony grants you a non-exclusive, non-transferable, limited right to enter, display, and use the Service, Site, and Software as set forth in this Agreement. You agree not to interrupt/disrupt or attempt to interrupt/disrupt the operation of this Service, Site or Software in any way.

## 3. User Account & Privacy

As part of your usage of the Product, Service, Site, and/or Software, Sony may require that you establish a user account ("Account") for which you must provide Sony true, accurate, current, and complete information about yourself and maintain/promptly update such information. You are responsible for maintaining the confidentiality of any and all of your passwords associated with the Account. You agree to notify Sony immediately of any unauthorized use of your

password or any other breach of security related to the Service, Site, and/or Software.

Sony's Privacy Policy is posted on the Site and at <http://products.sel.sony.com/SEL/legal/privacy.html>, the terms of which are incorporated herein, and applies to your use of the Account, Product, Service, Site, and Software.

## 4. Automatic Update

The Software contains a functionality by which it is updated automatically when the Product is connected to a server belonging to Sony or to a third party designated by Sony. When you specify your intention not to use this automatic update functionality, or when the setting asking whether you wish to update automatically is activated and you decline to execute updates, it is assumed that you agree that the security functionality improvements, error corrections, other functional updates or any other changes offered by Sony through such updates would not be made to the Software and that your current and further use of the Software may be affected thereby.

When the automatic update functionality described in the previous paragraph is activated, it is assumed that you agree (a) that the Software will be automatically updated as necessary to improve security functionality, to correct errors, to improve update functionality, or for other purposes, and (b) that this updating of the Software may be accompanied by the augmenting, modifying, or removing of functionality of the Software.

## 5. Additional Terms Governing Product Software

You may use the Software solely in conjunction with the Product that accompanied the Software. The Software is licensed, not sold. In addition to the terms set forth in other portions of this Agreement, the Software is subject to the following:

Use of Software. You may use the Software in conjunction with the Product for personal use.

Limitation on Reverse Engineering, Decompilation and Disassembly. You may not modify, reverse engineer, decompile, or disassemble the Software in whole or in part.

Separation of Components. The Software is licensed as a single product. Its component parts may not be separated for use on more than one device unless expressly authorized by Sony.

Data Files. The Software may create data files automatically for use with the Software. Any such data files will be deemed as part of the Software.

Rental. You may not rent or lease the Software.

Software Transfer. You may permanently transfer all of your rights under this Agreement only as part of a sale or transfer of Software accompanying the sale or transfer of your Product, provided you retain no copies, transfer all of the Software (including all copies, component parts, the media and printed materials, all versions and any upgrades of the Software and this Agreement), and the recipient agrees to the terms of this Agreement.

Dependent Software. The software, network services or other products other than Software upon which the Software's performance depends on might be interrupted or discontinued at the discretion of the suppliers (software suppliers, service providers or Sony).

High Risk Activities. The Software is not fault-tolerant and is not designed, manufactured or intended for use or resale as on-line control equipment in hazardous environments requiring fail-safe performance, such as in the operation of nuclear facilities, aircraft navigation or communication systems, air traffic control, direct life support machines, or weapons systems, in which the failure of the Software could lead to death, personal injury, or severe physical or environmental damage ("High Risk Activities"). Sony and its suppliers specifically disclaim any express or implied warranty of fitness for High Risk Activities.

U.S. Government Restricted Rights. The Software is provided with RESTRICTED RIGHTS. Use, duplication, or disclosure by the United States Government is subject to restriction as set forth in subparagraph (c) (1) and (2) of the Commercial Computer Software-Restricted Rights at 48 CFR 52.227-19, as applicable. Manufacturer is Sony Electronics Inc., 16530 Via Esprillo, San Diego, CA 92127.

GNU General Public, Lesser General Public, & Other Licenses.  
Notwithstanding terms in this Agreement, certain portions of the Software are governed by the GNU Lesser General Public License, Version 2.1 (LGPL), GNU General Public License Version 2 (GPL), and other open source code licenses ("Open Source Licenses"), copies of which are attached hereto and incorporated herein. For such portions of the Software, to the extent there is any conflict between this Agreement and the Open Source Licenses, the Open Source Licenses shall govern as applicable.  
Certain Source Code Availability. Sony is making available the source code of certain portions of the SOFTWARE per the GPL/LGPL LICENSES. Please see <http://www.sony.com/linux> for access to and instructions on obtaining such source code.

## **6. Changes to Service**

Sony reserves the right to discontinue one, some, or all of the features of the Service you receive at any time at its discretion. Sony may, at its discretion and from time to time change, add or remove features and functionality, upgrade or modify the Service, Site and/or Software without notice. You may, at Sony's discretion, receive messages regarding these changes and new features/functionality. Any new text, content, file, data, product, services, information, software, software tool or other feature provided by Sony (through the network or by CD-ROM or other means) (including, but not limited to, any update to Software provided to you automatically pursuant to Section 4 of this Agreement) will be subject to this Agreement; provided that, if separate terms and conditions applicable to such feature are provided to you, such terms and conditions shall apply to such feature in priority to this Agreement.

## **7. Confidentiality**

You shall maintain the confidentiality of any information with regard to the Product and Documentation that is provided under this Agreement and is not publicly known. You agree not to disclose such information to any third party without the prior written consent.

## **8. Sony's Right to Terminate or Modify Terms or Conditions of this Agreement**

Sony may add to, change, or remove any part, term, or condition of this Agreement at any time, without prior notice. Any changes to this Agreement or any terms posted on the Service and/or Site apply as soon as they are posted. By continuing to use the Service, Product, Software and/or Site after any changes are posted, you are indicating your acceptance of those changes. SONY MAY ADD, CHANGE, DISCONTINUE, REMOVE, OR SUSPEND ANY OTHER CONTENT POSTED ON THE SERVICE AND/OR SITE, INCLUDING FEATURES AND SPECIFICATIONS OF PRODUCTS DESCRIBED OR DEPICTED ON THE SERVICE AND/OR SITE, TEMPORARILY OR PERMANENTLY, AT ANY TIME, WITHOUT NOTICE AND WITHOUT LIABILITY, WITHOUT PREJUDICE TO ANY OTHER RIGHTS, SONY MAY SUSPEND OR TERMINATE THIS AGREEMENT IMMEDIATELY UPON NOTICE IF YOU FAIL TO COMPLY WITH THE TERMS AND CONDITIONS OF THIS AGREEMENT. Upon termination, you shall destroy the Software within fourteen (14) days after the date of such termination, and upon Sony's request, provide Sony with the certification of such destruction. Sony may take any legal and technical remedies to prevent the violation of and/or to enforce this Agreement, including without limitation, immediate termination of your access to the Service if we believe in our discretion you are violating this Agreement.

## **9. Indemnification**

You agree to indemnify, defend, and hold Sony and all of its agents, directors, employees, information providers, licensors and licensees, affiliates, content providers, officers, and parent (collectively, "Indemnified Parties"), harmless from and against any and all liability and costs (including, without limitation, attorneys' fees and costs), incurred by the Indemnified Parties in connection with any claim arising out of (i) any breach or alleged breach by you of this Agreement in any manner, (ii) any information you submit to Sony hereunder, (iii) any breach or alleged breach by you of a third party's rights or (iv) any damage caused by or alleged to have been caused by you to the Service. You will cooperate as fully as reasonably required in Indemnified Party(s) defense of any claim. Sony and/or Indemnified Parties reserve the right, at its own expense, to assume the exclusive defense and control of any matter otherwise subject to indemnification by you and you shall not in any event settle any matter without the written consent of Sony and/or Indemnified Parties.

## **10. DISCLAIMER OF WARRANTIES AND DAMAGES; LIMITATION OF LIABILITY**

YOU UNDERSTAND THAT USAGE OF THE PRODUCT AND SERVICE REQUIRES INTERNET SERVICE PROVIDED BY YOU, FOR WHICH YOU ARE SOLELY RESPONSIBLE. OPERATION OF THE PRODUCT AND/OR SERVICE MAY BE LIMITED OR RESTRICTED DEPENDING UPON THE CAPABILITIES OR TECHNICAL LIMITATIONS OF YOUR INTERNET SERVICE.

YOUR USE OF THE SOFTWARE, SERVICE, PRODUCT, CONTENT AND/OR SITE IS AT YOUR OWN RISK. THE SOFTWARE, SERVICE, CONTENT AND SITE ARE PROVIDED "AS IS" AND, TO THE FULLEST EXTENT PERMISSIBLE BY LAW, SONY MAKES NO REPRESENTATIONS OR WARRANTIES OF ANY KIND WHATSOEVER (1) FOR THE ACCURACY, MERCHANTABILITY, FITNESS FOR A PARTICULAR PURPOSE, OR NON-INFRINGEMENT ASSOCIATED WITH THE SERVICE, SITE, AND/OR SOFTWARE; (2) THAT THE SERVER(S) THAT MAKES THE SERVICE, SOFTWARE, AND/OR SITE AVAILABLE ARE FREE OF VIRUSES OR OTHER COMPONENTS THAT MAY INFECT, HARM, OR CAUSE DAMAGE TO YOUR COMPUTER, TELEVISION, OTHER EQUIPMENT, OR ANY OTHER PROPERTY. FURTHERMORE, SONY DOES NOT WARRANT OR MAKE ANY REPRESENTATIONS REGARDING THE USE OR THE RESULTS OF THE USE OF THE SOFTWARE, SERVICE, AND/OR SITE IN TERMS OF ITS CORRECTNESS, ACCURACY, RELIABILITY, OR OTHERWISE. NO ORAL OR WRITTEN INFORMATION OR ADVICE GIVEN BY SONY OR A SONY AUTHORIZED REPRESENTATIVE SHALL CREATE A WARRANTY OR IN ANY WAY INCREASE THE SCOPE OF THIS WARRANTY. SHOULD THE SOFTWARE, SERVICE, AND/OR SITE PROVE DEFECTIVE YOU (AND NOT SONY OR A SONY AUTHORIZED REPRESENTATIVE) ASSUME THE ENTIRE COST OF ALL NECESSARY SERVICING, REPAIR OR CORRECTION.

UNDER NO CIRCUMSTANCES, INCLUDING BUT NOT LIMITED TO SONY'S NEGLIGENCE OR ISSUES RELATED TO THIRD PARTY CONTENT PROVIDERS, SHALL SONY BE LIABLE FOR ANY CONSEQUENTIAL, DIRECT, INCIDENTAL, INDIRECT, PUNITIVE, OR SPECIAL DAMAGES RELATED TO (A) THE USE OF, (B) THE INABILITY TO USE, OR (C) ERRORS OR OMISSIONS IN THE SOFTWARE, SERVICE, PRODUCT, AND/OR SITE, EVEN IF SONY OR AN AUTHORIZED REPRESENTATIVE THEREOF HAS BEEN ADVISED OF THE POSSIBILITY OF SUCH DAMAGES. SOME STATES DO NOT ALLOW THE EXCLUSION OR LIMITATION OF CONSEQUENTIAL OR INCIDENTAL DAMAGES, SO THE ABOVE LIMITATION OR EXCLUSION MAY NOT APPLY TO YOU. IN NO EVENT SHALL SONY'S TOTAL LIABILITY TO YOU FOR ALL DAMAGES, LOSSES, AND CAUSES OF ACTION (WHETHER IN CONTRACT OR TORT, INCLUDING, BUT NOT LIMITED TO, NEGLIGENCE OR OTHERWISE) EXCEED \$100.00.

## 11. General Provisions

This Agreement, the limited warranty accompanying the Product, plus any additional terms posted on the Service or Site, together constitute the entire agreement between Sony and you with respect to your use of the Product, Service, Site, Content, and Software. Any notice by Sony hereunder may be made by letter, email, or posting on the Service or Site. Any cause of action you may have with respect to your use of this Site must be commenced within one (1) year after the claim or cause of action arises. If for any reason a court of competent jurisdiction finds any provision of this Agreement, or portion thereof, to be unenforceable, that provision shall be enforced to the maximum extent permissible so as to affect the intent of this Agreement, and the remaining terms and conditions of the Agreement shall continue in full force and effect. This Agreement shall be governed by and construed in accordance with the laws of the State of Delaware, United States of America, without reference to its conflicts of law rules. You agree to submit to the personal and exclusive jurisdiction of federal or state courts in Delaware.

# Software License Information

## Required public statement & License for GPL/LGPL licensed software used in this product

This product contains software that is subject to the following GNU General Public License ("GPL") or GNU Lesser General Public License ("LGPL"). These establish that customers have the right to acquire, modify, and redistribute the source code of said software in accordance with the terms of the GPL or the LGPL.

### Package List

```
linux-kernel.tar.gz
pump
lrzsz
busybox
gcc
glibe
netbase
dosfstools
lzo
mkcramfs
hostname
scfs
```

The source code for the above-listed software is available on the Web.

To download, please access the following URL:  
<http://www.sony.net/Products/Linux>

Please note that Sony cannot answer or respond to any inquiries regarding the content of this source code.

## GNU GENERAL PUBLIC LICENSE

Version 2, June 1991

Copyright (C) 1989, 1991 Free Software Foundation, Inc.

51 Franklin Street, Fifth Floor, Boston, MA 02110-1301 USA

Everyone is permitted to copy and distribute verbatim copies of this license document, but changing it is not allowed.

### Preamble

The Licenses for most software are designed to take away your freedom to share and change it. By contrast, the GNU General Public License is intended to guarantee your freedom to share and change free software--to make sure the software is free for all its users. This General Public License applies to most of the Free Software Foundation's software and to any other program whose authors commit to using it. (Some other Free Software Foundation software is covered by the GNU Lesser General Public License instead.) You can apply it to your programs, too.

When we speak of free software, we are referring to freedom, not price. Our General Public Licenses are designed to make sure that you have the freedom to distribute copies of free software (and charge for this service if you wish), that you receive source code or can get it if you want it, that you can change the software or use pieces of it in new free programs; and that you know you can do these things.

To protect your rights, we need to make restrictions that forbid anyone to deny you these rights or to ask you to surrender the rights. These restrictions translate to certain responsibilities for you if you distribute copies of the software, or if you modify it.

For example, if you distribute copies of such a program, whether gratis or for a fee, you must give the recipients all the rights that you have. You must make sure that they, too, receive or can get the source code. And you must show them these terms so they know their rights.

We protect your rights with two steps: (1) copyright the software, and (2) offer you this license which gives you legal permission to copy, distribute and/or modify the software.

Also, for each author's protection and ours, we want to make certain that everyone understands that there is no warranty for this free software. If the software is modified by someone else and passed on, we want its recipients to know that what they have is not the original, so that any problems introduced by others will not reflect on the original authors' reputations.

Finally, any free program is threatened constantly by software patents. We wish to avoid the danger that redistributors of a free program will individually obtain patent licenses, in effect making the program proprietary. To prevent this, we have made it clear that any patent must be licensed for everyone's free use or not licensed at all.

The precise terms and conditions for copying, distribution and modification follow.

## GNU GENERAL PUBLIC LICENSE TERMS AND CONDITIONS FOR COPYING, DISTRIBUTION AND MODIFICATION

0. This License applies to any program or other work which contains a notice placed by the copyright holder saying it may be distributed under the terms of this General Public License. The "Program", below, refers to any such program or work, and a "work based on the Program" means either the Program or any derivative work under copyright law: that is to say, a work containing the Program or a portion of it, either verbatim or with modifications and/or translated into another language.

(Hereinafter, translation is included without limitation in the term "modification".) Each licensee is addressed as "you".

Activities other than copying, distribution and modification are not covered by this License; they are outside its scope. The act of running the Program is not restricted, and the output from the Program is covered only if its contents constitute a work based on the Program (independent of having been made by running the Program). Whether that is true depends on what the Program does.

1. You may copy and distribute verbatim copies of the Program's source code as you receive it, in any medium, provided that you conspicuously and appropriately publish on each copy an appropriate copyright notice and disclaimer of warranty; keep intact all the notices that refer to this License and to the absence of any warranty; and give any other recipients of the Program a copy of this License along with the Program.

You may charge a fee for the physical act of transferring a copy, and you may at your option offer warranty protection in exchange for a fee.

2. You may modify your copy or copies of the Program or any portion of it, thus forming a work based on the Program, and may distribute such modifications or work under the terms of Section 1 above, provided that you also meet all of these conditions:

- You must cause the modified files to carry prominent notices stating that you changed the files and the date of any change.
- You must cause any work that you distribute or publish, that in whole or in part contains or is derived from the Program or any part thereof, to be licensed as a whole at no charge to all third parties under the terms of this License.
- If the modified program normally reads commands interactively when run, you must cause it, when started running for such interactive use in the most ordinary way, to print or display an announcement including an appropriate copyright notice and a notice that there is no warranty (or else, saying that you provide a warranty) and that users may redistribute the program under these conditions, and telling the user how to view a copy of this License. (Exception: if the Program itself is interactive but does not normally print such an announcement, your work based on the Program is not required to print an announcement.)

These requirements apply to the modified work as a whole. If identifiable sections of that work are not derived from the Program, and can be reasonably considered independent and separate works in themselves, then this License, and its terms, do not apply to those sections when you distribute them as separate works. But when you distribute the same sections as part of a whole which is a work based on the Program, the distribution of the whole must be on the terms of this License, whose permissions for other licensees extend to the entire whole, and thus to each and every part regardless of who wrote it.

Thus, it is not the intent of this section to claim rights or contest your rights to work written entirely by you; rather, the intent is to exercise the right to control the distribution of derivative or collective works based on the Program.

In addition, mere aggregation of another work not based on the Program with the Program (or with a work based on the Program) on a volume of a storage or distribution medium does not bring the other work under the scope of this License.

3. You may copy and distribute the Program (or a work based on it, under Section 2) in object code or executable form under the terms of Sections 1 and 2 above provided that you also do one of the following:

- Accompany it with the complete corresponding machine-readable source code, which must be distributed under the terms of Sections 1 and 2 above on a medium customarily used for software interchange; or,
- Accompany it with a written offer, valid for at least three years, to give any third party, for a charge no more than your cost of physically performing source distribution, a complete machine-readable copy of the corresponding source code, to be distributed under the terms of Sections 1 and 2 above on a medium customarily used for software interchange; or,
- Accompany it with the information you received as to the offer to distribute corresponding source code. (This alternative is allowed only for noncommercial distribution and only if you received the program in object code or executable form with such an offer, in accord with Subsection b above.)

The source code for a work means the preferred form of the work for making modifications to it. For an executable work, complete source code means all the source code for all modules it contains, plus any associated interface definition files, plus the scripts used to control compilation and installation of the executable. However, as a special exception, the source code distributed need not include anything that is normally distributed (in either source or binary form) with the major components (compiler, kernel, and so on) of the operating system on which the executable runs, unless that component itself accompanies the executable.

If distribution of executable or object code is made by offering access to copy from a designated place, then offering equivalent access to copy the source code from the same place counts as distribution of the source code, even though third parties are not compelled to copy the source along with the object code.

4. You may not copy, modify, sublicense, or distribute the Program except as expressly provided under this License. Any attempt otherwise to copy, modify, sublicense or distribute the Program is void, and will automatically terminate your rights under this License. However, parties who have received copies, or rights, from you under this License will not have their licenses terminated so long as such parties remain in full compliance.
5. You are not required to accept this License, since you have not signed it. However, nothing else grants you permission to modify or distribute the Program or its derivative works. These actions are prohibited by law if you do not accept this License. Therefore, by modifying or distributing the Program (or any work based on the Program), you indicate your acceptance of this License to do so, and all its terms and conditions for copying, distributing or modifying the Program or works based on it.



6. Each time you redistribute the Program (or any work based on the Program), the recipient automatically receives a license from the original licensor to copy, distribute or modify the Program subject to these terms and conditions. You may not impose any further restrictions on the recipients' exercise of the rights granted herein. You are not responsible for enforcing compliance by third parties to this License.
7. If, as a consequence of a court judgment or allegation of patent infringement or for any other reason (not limited to patent issues), conditions are imposed on you (whether by court order, agreement or otherwise) that contradict the conditions of this License, they do not excuse you from the conditions of this License. If you cannot distribute so as to satisfy simultaneously your obligations under this License and any other pertinent obligations, then as a consequence you may not distribute the Program at all. For example, if a patent license would not permit royalty-free redistribution of the Program by all those who receive copies directly or indirectly through you, then the only way you could satisfy both it and this License would be to refrain entirely from distribution of the Program.

If any portion of this section is held invalid or unenforceable under any particular circumstance, the balance of the section is intended to apply and the section as a whole is intended to apply in other circumstances.

It is not the purpose of this section to induce you to infringe any patents or other property right claims or to contest validity of any such claims; this section has the sole purpose of protecting the integrity of the free software distribution system, which is implemented by public license practices. Many people have made generous contributions to the wide range of software distributed through that system in reliance on consistent application of that system; it is up to the author/donor to decide if he or she is willing to distribute software through any other system and a licensee cannot impose that choice.

This section is intended to make thoroughly clear what is believed to be a consequence of the rest of this License.

8. If the distribution and/or use of the Program is restricted in certain countries either by patents or by copyrighted interfaces, the original copyright holder who places the Program under this License may add an explicit geographical distribution limitation excluding those countries, so that distribution is permitted only in or among countries not thus excluded. In such case, this License incorporates the limitation as if written in the body of this License.
9. The Free Software Foundation may publish revised and/or new versions of the General Public License from time to time. Such new versions will be similar in spirit to the present version, but may differ in detail to address new problems or concerns.

Each version is given a distinguishing version number. If the Program specifies a version number of this License which applies to it and "any later version", you have the option of following the terms and conditions either of that version or of any later version published by the Free Software Foundation. If the Program does not specify a version number of this License, you may choose any version ever published by the Free Software Foundation.

10. If you wish to incorporate parts of the Program into other free programs whose distribution conditions are different, write to the author to ask for permission. For software which is copyrighted by the Free Software Foundation, write to the Free Software Foundation; we sometimes make exceptions for this. Our decision will be guided by the two goals of preserving the free status of all derivatives of our free software and of promoting the sharing and reuse of software generally.

## NO WARRANTY

11. BECAUSE THE PROGRAM IS LICENSED FREE OF CHARGE, THERE IS NO WARRANTY FOR THE PROGRAM, TO THE EXTENT PERMITTED BY APPLICABLE LAW. EXCEPT WHEN OTHERWISE STATED IN WRITING THE COPYRIGHT HOLDERS AND/OR OTHER PARTIES PROVIDE THE PROGRAM "AS IS" WITHOUT WARRANTY OF ANY KIND, EITHER EXPRESSED OR IMPLIED, INCLUDING, BUT NOT LIMITED TO, THE IMPLIED WARRANTIES OF MERCHANTABILITY AND FITNESS FOR A PARTICULAR PURPOSE. THE ENTIRE RISK AS TO THE QUALITY AND PERFORMANCE OF THE PROGRAM IS WITH YOU. SHOULD THE PROGRAM PROVE DEFECTIVE, YOU ASSUME THE COST OF ALL NECESSARY SERVICING, REPAIR OR CORRECTION.
12. IN NO EVENT UNLESS REQUIRED BY APPLICABLE LAW OR AGREED TO IN WRITING WILL ANY COPYRIGHT HOLDER, OR ANY OTHER PARTY WHO MAY MODIFY AND/OR REDISTRIBUTE THE PROGRAM AS PERMITTED ABOVE, BE LIABLE TO YOU FOR DAMAGES, INCLUDING ANY GENERAL, SPECIAL, INCIDENTAL OR CONSEQUENTIAL DAMAGES ARISING OUT OF THE USE OR INABILITY TO USE THE PROGRAM (INCLUDING BUT NOT LIMITED TO LOSS OF DATA OR DATA BEING RENDERED INACCURATE OR LOSSES SUSTAINED BY YOU OR THIRD PARTIES OR A FAILURE OF THE PROGRAM TO OPERATE WITH ANY OTHER PROGRAMS), EVEN IF SUCH HOLDER OR OTHER PARTY HAS BEEN ADVISED OF THE POSSIBILITY OF SUCH DAMAGES.

## END OF TERMS AND CONDITIONS

### How to Apply These Terms to Your New Programs

If you develop a new program, and you want it to be of the greatest possible use to the public, the best way to achieve this is to make it free software which everyone can redistribute and change under these terms.

To do so, attach the following notices to the program. It is safest to attach them to the start of each source file to most effectively convey the exclusion of warranty; and each file should have at least the "copyright" line and a pointer to where the full notice is found.

<one line to give the program's name and an idea of what it does.>  
Copyright (C) <year> <name of author>

This program is free software; you can redistribute it and/or modify it under the terms of the GNU General Public License as published by the Free Software Foundation; either version 2 of the License, or (at your option) any later version.

This program is distributed in the hope that it will be useful, but WITHOUT ANY WARRANTY; without even the implied warranty of MERCHANTABILITY or FITNESS FOR A PARTICULAR PURPOSE. See the GNU General Public License for more details.

You should have received a copy of the GNU General Public License along with this program; if not, write to the Free Software Foundation, Inc., 59 Temple Place - Suite 330, Boston, MA 02111-1307, USA.

Also add information on how to contact you by electronic and paper mail.

If the program is interactive, make it output a short notice like this when it starts in an interactive mode:

Gnomovision version 69, Copyright (C) year name of author  
Gnomovision comes with ABSOLUTELY NO WARRANTY; for details type 'show w'. This is free software, and you are welcome to redistribute it under certain conditions; type 'show c' for details.

The hypothetical commands 'show w' and 'show c' should show the appropriate parts of the General Public License. Of course, the commands you use may be called something other than 'show w' and 'show c'; they could even be mouse-clicks or menu items--whatever suits your program.

You should also get your employer (if you work as a programmer) or your school, if any, to sign a "copyright disclaimer" for the program, if necessary. Here is a sample; alter the names:

Yoyodyne, Inc., hereby disclaims all copyright interest in the program 'Gnomovision' (which makes passes at compilers) written by James Hacker.

<signature of Ty Coon>, 1 April 1989  
Ty Coon, President of Vice

This General Public License does not permit incorporating your program into proprietary programs. If your program is a subroutines library, you may consider it more useful to permit linking proprietary applications with the library. If this is what you want to do, use the GNU Lesser General Public License instead of this License.

## GNU LESSER GENERAL PUBLIC LICENSE

Version 2.1, February 1999

Copyright (C) 1991, 1999 Free Software Foundation, Inc.

51 Franklin Street, Fifth Floor, Boston, MA 02110-1301 USA

Everyone is permitted to copy and distribute verbatim copies of this license document, but changing it is not allowed.

[This is the first released version of the Lesser GPL. It also counts as the successor of the GNU Library Public License, version 2, hence the version number 2.1.]

### Preamble

The licenses for most software are designed to take away your freedom to share and change it. By contrast, the GNU General Public Licenses are intended to guarantee your freedom to share and change free software--to make sure the software is free for all its users.

This license, the Lesser General Public License, applies to some specially designated software packages--typically libraries--of the Free Software Foundation and other authors who decide to use it.

You can use it too, but we suggest you first think carefully about whether this license or the Ordinary General Public License is the better strategy to use in any particular case, based on the explanations below.

When we speak of free software, we are referring to freedom of use, not price. Our General Public Licenses are designed to make sure that you have the freedom to distribute copies of free software (and charge for this service if you wish); that you receive source code or can get it if you want it; that you can change the software and use pieces of it in new free programs; and that you are informed that you can do these things.

To protect your rights, we need to make restrictions that forbid distributors to deny you these rights or to ask you to surrender these rights. These restrictions translate to certain responsibilities for you if you distribute copies of the library or if you modify it.

For example, if you distribute copies of the library, whether gratis or for a fee, you must give the recipients all the rights that we gave you. You must make sure that they, too, receive or can get the source code. If you link other code with the library, you must provide complete object files to the recipients, so that they can relink them with the library after making changes to the library and recompiling it. And you must show them these terms so they know their rights.

We protect your rights with a two-step method: (1) we copyright the library, and (2) we offer you this license, which gives you legal permission to copy, distribute and/or modify the library.

To protect each distributor, we want to make it very clear that there is no warranty for the free library. Also, if the library is modified by someone else and passed on, the recipients should know that what they have is not the original version, so that the original author's reputation will not be affected by problems that might be introduced by others.

Finally, software patents pose a constant threat to the existence of any free program. We wish to make sure that a company cannot effectively restrict the users of a free program by obtaining a restrictive license from a patent holder. Therefore, we insist that any patent license obtained for a version of the library must be consistent with the full freedom of use specified in this license.

Most GNU software, including some libraries, is covered by the ordinary GNU General Public License. This license, the GNU Lesser General Public License, applies to certain designated libraries, and is quite different from the ordinary General Public License. We use this license for certain libraries in order to permit linking those libraries into non-free programs.

When a program is linked with a library, whether statically or using a shared library, the combination of the two is legally speaking a combined work, a derivative of the original library. The ordinary General Public License therefore permits such linking only if the entire combination fits its criteria of freedom. The Lesser General Public License permits more lax criteria for linking other code with the library.

We call this license the "Lesser" General Public License because it does Less to protect the user's freedom than the ordinary General Public License. It also provides other free software developers Less of an advantage over competing non-free programs. These disadvantages are the reason we use the ordinary General Public License for many libraries. However, the Lesser License provides advantages in certain special circumstances.

For example, on rare occasions, there may be a special need to encourage the widest possible use of a certain library, so that it becomes a de-facto standard. To achieve this, non-free programs must be allowed to use the library. A more frequent case is that a free library does the same job as widely used non-free libraries. In this case, there is little to gain by limiting the free library to free software only, so we use the Lesser General Public License.

In other cases, permission to use a particular library in non-free programs enables a greater number of people to use a large body of free software. For example, permission to use the GNU C Library in non-free programs enables many more people to use the whole GNU operating system, as well as its variant, the GNU/Linux operating system.

Although the Lesser General Public License is Less protective of the users' freedom, it does ensure that the user of a program that is linked with the Library has the freedom and the wherewithal to run that program using a modified version of the Library.

The precise terms and conditions for copying, distribution and modification follow. Pay close attention to the difference between a "work based on the library" and a "work that uses the library". The former contains code derived from the library, whereas the latter must be combined with the library in order to run.

### GNU GENERAL PUBLIC LICENSE TERMS AND CONDITIONS FOR COPYING, DISTRIBUTION AND MODIFICATION

0. This License Agreement applies to any software library or other program which contains a notice placed by the copyright holder or other authorized party saying it may be distributed under the terms of this Lesser General Public License (also called "this License"). Each licensee is addressed as "you".

A "library" means a collection of software functions and/or data prepared so as to be conveniently linked with application programs (which use some of those functions and data) to form executables.

The "Library", below, refers to any such software library or work which has been distributed under these terms. A "work based on the Library" means either the Library or any derivative work under copyright law: that is to say, a work containing the Library or a portion of it, either verbatim or with modifications and/or translated straightforwardly into another language. (Hereinafter, translation is included without limitation in the term "modification".)

"Source code" for a work means the preferred form of the work for making modifications to it. For a library, complete source code means all the source code for all modules it contains, plus any associated interface definition files, plus the scripts used to control compilation and installation of the library.

Activities other than copying, distribution and modification are not covered by this License; they are outside its scope. The act of running a program using the Library is not restricted, and output from such a program is covered only if its contents constitute a work based on the Library (independent of the use of the Library in a tool for writing it). Whether that is true depends on what the Library does and what the program that uses the Library does.

1. You may copy and distribute verbatim copies of the Library's complete source code as you receive it, in any medium, provided that you conspicuously and appropriately publish on each copy an appropriate copyright notice and disclaimer of warranty; keep intact all the notices that refer to this License and to the absence of any warranty; and distribute a copy of this License along with the Library.

You may charge a fee for the physical act of transferring a copy, and you may at your option offer warranty protection in exchange for a fee.

2. You may modify your copy or copies of the Library or any portion of it, thus forming a work based on the Library, and copy and distribute such modifications or work under the terms of Section 1 above, provided that you also meet all of these conditions:

- a) The modified work must itself be a software library.
- b) You must cause the files modified to carry prominent notices stating that you changed the files and the date of any change.
- c) You must cause the whole of the work to be licensed at no charge to all third parties under the terms of this License.
- d) If a facility in the modified Library refers to a function or a table of data to be supplied by an application program that uses the facility, other than as an argument passed when the facility is invoked, then you must make a good faith effort to ensure that, in the event an application does not supply such function or table, the facility still operates, and performs whatever part of its purpose remains meaningful.

(For example, a function in a library to compute square roots has a purpose that is entirely well-defined independent of the application. Therefore, Subsection 2d requires that any application-supplied function or table used by this function must be optional: if the application does not supply it, the square root function must still compute square roots.)

These requirements apply to the modified work as a whole. If identifiable sections of that work are not derived from the Library, and can be reasonably considered independent and separate works in themselves, then this License, and its terms, do not apply to those sections when you distribute them as separate works. But when you distribute the same sections as part of a whole which is a work based on the Library, the distribution of the whole must be on the terms of this License, whose permissions for other licensees extend to the entire whole, and thus to each and every part regardless of who wrote it.

Thus, it is not the intent of this section to claim rights or contest your rights to work written entirely by you; rather, the intent is to exercise the right to control the distribution of derivative or collective works based on the Library.

In addition, mere aggregation of another work not based on the Library with the Library (or with a work based on the Library) on a volume of a storage or distribution medium does not bring the other work under the scope of this License.

3. You may opt to apply the terms of the ordinary GNU General Public License instead of this License to a given copy of the Library. To do this, you must alter all the notices that refer to this License, so that they refer to the ordinary GNU General Public License, version 2, instead of to this License. (If a newer version than version 2 of the ordinary GNU General Public License has appeared, then you can specify that version instead if you wish.) Do not make any other change in these notices.

Once this change is made in a given copy, it is irreversible for that copy, so the ordinary GNU General Public License applies to all subsequent copies and derivative works made from that copy.

This option is useful when you wish to copy part of the code of the Library into a program that is not a library.

4. You may copy and distribute the Library (or a portion or derivative of it, under Section 2) in object code or executable form under the terms of Sections 1 and 2 above provided that you accompany it with the complete corresponding machine-readable source code, which must be distributed under the terms of Sections 1 and 2 above on a medium customarily used for software interchange.

If distribution of object code is made by offering access to copy from a designated place, then offering equivalent access to copy the source code from the same place satisfies the requirement to distribute the source code, even though third parties are not compelled to copy the source along with the object code.

5. A program that contains no derivative of any portion of the Library, but is designed to work with the Library by being compiled or linked with it, is called a "work that uses the Library". Such a work, in isolation, is not a derivative work of the Library, and therefore falls outside the scope of this License.

However, linking a "work that uses the Library" with the Library creates an executable that is a derivative of the Library (because it contains portions of the Library), rather than a "work that uses the library". The executable is therefore covered by this License. Section 6 states terms for distribution of such executables.

When a "work that uses the Library" uses material from a header file that is part of the Library, the object code for the work may be a derivative work of the Library even though the source code is not. Whether this is true is especially significant if the work can be linked without the Library, or if the work is itself a library. The threshold for this to be true is not precisely defined by law.

If such an object file uses only numerical parameters, data structure layouts and assessors, and small macros and small inline functions (ten lines or less in length), then the use of the object file is unrestricted, regardless of whether it is legally a derivative work. (Executables containing this object code plus portions of the Library will still fall under Section 6.)

Otherwise, if the work is a derivative of the Library, you may distribute the object code for the work under the terms of Section 6. Any executables containing that work also fall under Section 6, whether or not they are linked directly with the Library itself.

6. As an exception to the Sections above, you may also combine or link a "work that uses the Library" with the Library to produce a work containing portions of the Library, and distribute that work under terms of your choice, provided that the terms permit modification of the work for the customer's own use and reverse engineering for debugging such modifications.

You must give prominent notice with each copy of the work that the Library is used in it and that the Library and its use are covered by this License. You must supply a copy of this License. If the work during execution displays copyright notices, you must include the copyright notice for the Library among them, as well as a reference directing the user to the copy of this License. Also, you must do one of these things:

- a) Accompany the work with the complete corresponding machine-readable source code for the Library including whatever changes were used in the work (which must be distributed under Sections 1 and 2 above); and, if the work is an executable linked with the Library, with the complete machine-readable "work that uses the Library", as object code and/or source code, so that the user can modify the Library and then relink to produce a modified executable containing the modified Library. (It is understood that the user who changes the contents of definitions files in the Library will not necessarily be able to recompile the application to use the modified definitions.)
- b) Use a suitable shared library mechanism for linking with the Library. A suitable mechanism is one that (1) uses at run time a copy of the library already present on the user's computer system, rather than copying library functions into the executable, and (2) will operate properly with a modified version of the library, if the user installs one, as long as the modified version is interface-compatible with the version that the work was made with.

- c) Accompany the work with a written offer, valid for at least three years, to give the same user the materials specified in Subsection 6a, above, for a charge no more than the cost of performing this distribution.
- d) If distribution of the work is made by offering access to copy from a designated place, offer equivalent access to copy the above specified materials from the same place.
- e) Verify that the user has already received a copy of these materials or that you have already sent this user a copy.

For an executable, the required form of the “work that uses the Library” must include any data and utility programs needed for reproducing the executable from it. However, as a special exception, the materials to be distributed need not include anything that is normally distributed (in either source or binary form) with the major components (compiler, kernel, and so on) of the operating system on which the executable runs, unless that component itself accompanies the executable.

It may happen that this requirement contradicts the license restrictions of other proprietary libraries that do not normally accompany the operating system. Such a contradiction means you cannot use both them and the Library together in an executable that you distribute.

- 7. You may place library facilities that are a work based on the Library side-by-side in a single library together with other library facilities not covered by this License, and distribute such a combined library, provided that the separate distribution of the work based on the Library and of the other library facilities is otherwise permitted, and provided that you do these two things:

- a) Accompany the combined library with a copy of the same work based on the Library, uncombined with any other library facilities. This must be distributed under the terms of the Sections above.
- b) Give prominent notice with the combined library of the fact that part of it is a work based on the Library, and explaining where to find the accompanying uncombined form of the same work.

- 8. You may not copy, modify, sublicense, link with, or distribute the Library except as expressly provided under this License. Any attempt otherwise to copy, modify, sublicense, link with, or distribute the Library is void, and will automatically terminate your rights under this License. However, parties who have received copies, or rights, from you under this License will not have their licenses terminated so long as such parties remain in full compliance.

- 9. You are not required to accept this License, since you have not signed it. However, nothing else grants you permission to modify or distribute the Library or its derivative works. These actions are prohibited by law if you do not accept this License. Therefore, by modifying or distributing the Library (or any work based on the Library), you indicate your acceptance of this License to do so, and all its terms and conditions for copying, distributing or modifying the Library or works based on it.

- 10. Each time you redistribute the Library (or any work based on the Library), the recipient automatically receives a license from the original licensor to copy, distribute, link with or modify the Library subject to these terms and conditions. You may not impose any further restrictions on the recipients’ exercise of the rights granted herein. You are not responsible for enforcing compliance by third parties with this License.

- 11. If, as a consequence of a court judgment or allegation of patent infringement or for any other reason (not limited to patent issues), conditions are imposed on you (whether by court order, agreement or otherwise) that contradict the conditions of this License, they do not excuse you from the conditions of this License. If you cannot distribute so as to satisfy simultaneously your obligations under this License and any other pertinent obligations, then as a consequence you may not distribute the Library at all. For example, if a patent license would not permit royalty-free redistribution of the Library by all those who receive copies directly or indirectly through you, then the only way you could satisfy both it and this License would be to refrain entirely from distribution of the Library.

If any portion of this section is held invalid or unenforceable under any particular circumstance, the balance of the section is intended to apply, and the section as a whole is intended to apply in other circumstances.

It is not the purpose of this section to induce you to infringe any patents or other property right claims or to contest validity of any such claims; this section has the sole purpose of protecting the integrity of the free software distribution system which is implemented by public license practices. Many people have made generous contributions to the wide range of software distributed through that system in reliance on consistent application of that system; it is up to the author/donor to decide if he or she is willing to distribute software through any other system and a licensee cannot impose that choice.

This section is intended to make thoroughly clear what is believed to be a consequence of the rest of this License.

- 12. If the distribution and/or use of the Library is restricted in certain countries either by patents or by copyrighted interfaces, the original copyright holder who places the Library under this License may add an explicit geographical distribution limitation excluding those countries, so that distribution is permitted only in or among countries not thus excluded. In such case, this License incorporates the limitation as if written in the body of this License.
- 13. The Free Software Foundation may publish revised and/or new versions of the Lesser General Public License from time to time. Such new versions will be similar in spirit to the present version, but may differ in detail to address new problems or concerns.

Each version is given a distinguishing version number. If the Library specifies a version number of this License which applies to it and “any later version”, you have the option of following the terms and conditions either of that version or of any later version published by the Free Software Foundation. If the Library does not specify a license version number, you may choose any version ever published by the Free Software Foundation.

- 14. If you wish to incorporate parts of the Library into other free programs whose distribution conditions are incompatible with these, write to the author to ask for permission. For software which is copyrighted by the Free Software Foundation, write to the Free Software Foundation; we sometimes make exceptions for this. Our decision will be guided by the two goals of preserving the free status of all derivatives of our free software and of promoting the sharing and reuse of software generally.

## NO WARRANTY

- 15. BECAUSE THE LIBRARY IS LICENSED FREE OF CHARGE, THERE IS NO WARRANTY FOR THE LIBRARY, TO THE EXTENT PERMITTED BY APPLICABLE LAW. EXCEPT WHEN OTHERWISE STATED IN WRITING THE COPYRIGHT HOLDERS AND/OR OTHER PARTIES PROVIDE THE LIBRARY “AS IS” WITHOUT WARRANTY OF ANY KIND, EITHER EXPRESSED OR IMPLIED, INCLUDING, BUT NOT LIMITED TO, THE IMPLIED WARRANTIES OF MERCHANTABILITY AND FITNESS FOR A PARTICULAR PURPOSE. THE ENTIRE RISK AS TO THE QUALITY AND PERFORMANCE OF THE LIBRARY IS WITH YOU. SHOULD THE LIBRARY PROVE DEFECTIVE, YOU ASSUME THE COST OF ALL NECESSARY SERVICING, REPAIR OR CORRECTION.

- 16. IN NO EVENT UNLESS REQUIRED BY APPLICABLE LAW OR AGREED TO IN WRITING WILL ANY COPYRIGHT HOLDER, OR ANY OTHER PARTY WHO MAY MODIFY AND/OR REDISTRIBUTE THE LIBRARY AS PERMITTED ABOVE, BE LIABLE TO YOU FOR DAMAGES, INCLUDING ANY GENERAL, SPECIAL, INCIDENTAL OR CONSEQUENTIAL DAMAGES ARISING OUT OF THE USE OR INABILITY TO USE THE LIBRARY (INCLUDING BUT NOT LIMITED TO LOSS OF DATA OR DATA BEING RENDERED INACCURATE OR LOSSES SUSTAINED BY YOU OR THIRD PARTIES OR A FAILURE OF THE LIBRARY TO OPERATE WITH ANY OTHER SOFTWARE), EVEN IF SUCH HOLDER OR OTHER PARTY HAS BEEN ADVISED OF THE POSSIBILITY OF SUCH DAMAGES.

## END OF TERMS AND CONDITIONS

### How to Apply These Terms to Your New Libraries

If you develop a new library, and you want it to be of the greatest possible use to the public, we recommend making it free software that everyone can redistribute and change. You can do so by permitting redistribution under these terms (or, alternatively, under the terms of the ordinary General Public License).

To apply these terms, attach the following notices to the library. It is safest to attach them to the start of each source file to most effectively convey the exclusion of warranty; and each file should have at least the "copyright" line and a pointer to where the full notice is found.

<one line to give the library's name and an idea of what it does.>  
Copyright (C) <year> <name of author>

This library is free software; you can redistribute it and/or modify it under the terms of the GNU Lesser General Public License as published by the Free Software Foundation; either version 2.1 of the License, or (at your option) any later version.

This library is distributed in the hope that it will be useful, but WITHOUT ANY WARRANTY; without even the implied warranty of MERCHANTABILITY or FITNESS FOR A PARTICULAR PURPOSE. See the GNU Lesser General Public License for more details.

You should have received a copy of the GNU Lesser General Public License along with this library; if not, write to the Free Software Foundation, Inc., 59 Temple Place, Suite 330, Boston, MA 02111-1307 USA

Also add information on how to contact you by electronic and paper mail.

You should also get your employer (if you work as a programmer) or your school, if any, to sign a "copyright disclaimer" for the library, if necessary. Here is a sample; alter the names:

Yooyodyne, Inc., hereby disclaims all copyright interest in the library "Frob" (a library for tweaking knobs) written by James Random Hacker.

signature of Ty Coon, 1 April 1990  
Ty Coon, President of Vice

That's all there is to it!

### Required statements for OpenSSL project used in this product

This product contains OpenSSL (including the library Original SSLeay), which Sony uses under license with the copyright holder. In compliance with a request by the copyright holder of said software, Sony conveys the following notice and asks that you read it.

Package name: sony-target-grel-openssl-0.9.8g-020201.src.rpm

#### OpenSSL

Copyright (c) 1998-2006 The OpenSSL Project. All rights reserved.

Redistribution and use in source and binary forms, with or without modification, are permitted provided that the following conditions are met:

1. Redistributions of source code must retain the above copyright notice, this list of conditions and the following disclaimer.
2. Redistributions in binary form must reproduce the above copyright notice, this list of conditions and the following disclaimer in the documentation and/or other materials provided with the distribution.
3. All advertising materials mentioning features or use of this software must display the following acknowledgment:  
"This product includes software developed by the OpenSSL Project for use in the OpenSSL Toolkit. (<http://www.openssl.org/>)"
4. The names "OpenSSL Toolkit" and "OpenSSL Project" must not be used to endorse or promote products derived from this software without prior written permission. For written permission, please contact [openssl-core@openssl.org](mailto:openssl-core@openssl.org).

5. Products derived from this software may not be called "OpenSSL" nor may "OpenSSL" appear in their names without prior written permission of the OpenSSL Project.
6. Redistributions of any form whatsoever must retain the following acknowledgment:  
"This product includes software developed by the OpenSSL Project for use in the OpenSSL Toolkit (<http://www.openssl.org/>)"

THIS SOFTWARE IS PROVIDED BY THE OpenSSL PROJECT "AS IS" AND ANY EXPRESSED OR IMPLIED WARRANTIES, INCLUDING, BUT NOT LIMITED TO, THE IMPLIED WARRANTIES OF MERCHANTABILITY AND FITNESS FOR A PARTICULAR PURPOSE ARE DISCLAIMED. IN NO EVENT SHALL THE OpenSSL PROJECT OR ITS CONTRIBUTORS BE LIABLE FOR ANY DIRECT, INDIRECT, INCIDENTAL, SPECIAL, EXEMPLARY, OR CONSEQUENTIAL DAMAGES (INCLUDING, BUT NOT LIMITED TO, PROCUREMENT OF SUBSTITUTE GOODS OR SERVICES; LOSS OF USE, DATA, OR PROFITS; OR BUSINESS INTERRUPTION) HOWEVER CAUSED AND ON ANY THEORY OF LIABILITY, WHETHER IN CONTRACT, STRICT LIABILITY, OR TORT (INCLUDING NEGLIGENCE OR OTHERWISE) ARISING IN ANY WAY OUT OF THE USE OF THIS SOFTWARE, EVEN IF ADVISED OF THE POSSIBILITY OF SUCH DAMAGE.

This product includes cryptographic software written by Eric Young ([ey@cryptsoft.com](mailto:ey@cryptsoft.com)). This product includes software written by Tim Hudson ([tjh@cryptsoft.com](mailto:tjh@cryptsoft.com)).

### Original SSLeay License

#### Original SSLeay

Copyright (C) 1995-1998 Eric Young ([ey@cryptsoft.com](mailto:ey@cryptsoft.com))  
All rights reserved.

This package is an SSL implementation written by Eric Young ([ey@cryptsoft.com](mailto:ey@cryptsoft.com)).

The implementation was written so as to conform with Netscape SSL.

This library is free for commercial and non-commercial use as long as the following conditions are adhered to. The following conditions apply to all code found in this distribution, be it the RC4, RSA, lhash, DES, etc., code; not just the SSL code. The SSL documentation included with this distribution is covered by the same copyright terms except that the holder is Tim Hudson ([tjh@cryptsoft.com](mailto:tjh@cryptsoft.com)).

Copyright remains Eric Young's, and as such any Copyright notices in the code are not to be removed.

If this package is used in a product, Eric Young should be given attribution as the author of the parts of the library used.

This can be in the form of a textual message at program startup or in documentation (online or textual) provided with the package.

Redistribution and use in source and binary forms, with or without modification, are permitted provided that the following conditions are met:

1. Redistributions of source code must retain the copyright notice, this list of conditions and the following disclaimer.
2. Redistributions in binary form must reproduce the above copyright notice, this list of conditions and the following disclaimer in the documentation and/or other materials provided with the distribution.
3. All advertising materials mentioning features or use of this software must display the following acknowledgement:  
"This product includes cryptographic software written by Eric Young ([ey@cryptsoft.com](mailto:ey@cryptsoft.com))"  
The word 'cryptographic' can be left out if the routines from the library being used are not cryptographic related :-).
4. If you include any Windows specific code (or a derivative thereof) from the apps directory (application code) you must include an acknowledgement:  
"This product includes software written by Tim Hudson ([tjh@cryptsoft.com](mailto:tjh@cryptsoft.com))"

THIS SOFTWARE IS PROVIDED BY ERIC YOUNG "AS IS" AND ANY EXPRESS OR IMPLIED WARRANTIES, INCLUDING, BUT NOT LIMITED TO, THE IMPLIED WARRANTIES OF MERCHANTABILITY AND FITNESS FOR A PARTICULAR PURPOSE ARE DISCLAIMED. IN NO EVENT SHALL THE AUTHOR OR CONTRIBUTORS BE LIABLE FOR ANY DIRECT, INDIRECT, INCIDENTAL, SPECIAL, EXEMPLARY, OR CONSEQUENTIAL DAMAGES (INCLUDING, BUT NOT LIMITED TO, PROCUREMENT OF SUBSTITUTE GOODS OR SERVICES; LOSS OF USE, DATA, OR PROFITS; OR BUSINESS INTERRUPTION) HOWEVER CAUSED AND ON ANY THEORY OF LIABILITY, WHETHER IN CONTRACT, STRICT LIABILITY, OR TORT (INCLUDING NEGLIGENCE OR OTHERWISE) ARISING IN ANY WAY OUT OF THE USE OF THIS SOFTWARE, EVEN IF ADVISED OF THE POSSIBILITY OF SUCH DAMAGE.

The licence and distribution terms for any publicly available version or derivative of this code cannot be changed. i.e. this code cannot simply be copied and put under another distribution licence [including the GNU Public Licence.]

## FreeType

The FreeType Project is copyright (C) 1996-2000 by David Turner, Robert Wilhelm, and Werner Lemberg. All rights reserved except as specified below.

THE FREETYPE PROJECT IS PROVIDED 'AS IS' WITHOUT WARRANTY OF ANY KIND, EITHER EXPRESS OR IMPLIED, INCLUDING, BUT NOT LIMITED TO, WARRANTIES OF MERCHANTABILITY AND FITNESS FOR A PARTICULAR PURPOSE. IN NO EVENT WILL ANY OF THE AUTHORS OR COPYRIGHT HOLDERS BE LIABLE FOR ANY DAMAGES CAUSED BY THE USE OR THE INABILITY TO USE, OF THE FREETYPE PROJECT.

## Notice about NetBSD Software

### BSD License

Copyright (c) 1994-2004 The NetBSD Foundation, Inc. All rights reserved.

Redistribution and use in source and binary forms, with or without modification, are permitted provided that the following conditions are met:

1. Redistributions of source code must retain the above copyright notice, this list of conditions and the following disclaimer.
2. Redistributions in binary form must reproduce the above copyright notice, this list of conditions and the following disclaimer in the documentation and/or other materials provided with the distribution.
3. All advertising materials mentioning features or use of this software must display the following acknowledgement:  
This product includes software developed by the NetBSD Foundation, Inc. and its contributors.
4. Neither the name of The NetBSD Foundation nor the names of its contributors may be used to endorse or promote products derived from this software without specific prior written permission.

THIS SOFTWARE IS PROVIDED BY THE REGENTS AND CONTRIBUTORS "AS IS" AND ANY EXPRESS OR IMPLIED WARRANTIES, INCLUDING, BUT NOT LIMITED TO, THE IMPLIED WARRANTIES OF MERCHANTABILITY AND FITNESS FOR A PARTICULAR PURPOSE ARE DISCLAIMED. IN NO EVENT SHALL THE REGENTS OR CONTRIBUTORS BE LIABLE FOR ANY DIRECT, INDIRECT, INCIDENTAL, SPECIAL, EXEMPLARY, OR CONSEQUENTIAL DAMAGES (INCLUDING, BUT NOT LIMITED TO, PROCUREMENT OF SUBSTITUTE GOODS OR SERVICES; LOSS OF USE, DATA, OR PROFITS; OR BUSINESS INTERRUPTION) HOWEVER CAUSED AND ON ANY THEORY OF LIABILITY, WHETHER IN CONTRACT, STRICT LIABILITY, OR TORT (INCLUDING NEGLIGENCE OR OTHERWISE) ARISING IN ANY WAY OUT OF THE USE OF THIS SOFTWARE, EVEN IF ADVISED OF THE POSSIBILITY OF SUCH DAMAGE.

The following notices are required to satisfy the license terms of the software that we have mentioned in this document:

This product includes software developed by Adam Glass.  
This product includes software developed by Bill Paul.  
This product includes software developed by Charles M. Hannum.  
This product includes software developed by Christian E. Hopps.  
This product includes software developed by Christopher G. Demetriou.

This product includes software developed by Christopher G. Demetriou for the NetBSD Project.

This product includes software developed by Christos Zoulas.  
This product includes software developed by Gardner Buchanan.  
This product includes software developed by Gordon W. Ross

This product includes software developed by Jonathan Stone for the NetBSD Project.

This product includes software developed by Manuel Bouyer.  
This product includes software developed by Rolf Grossmann.  
This product includes software developed by TooLs GmbH.

This product includes software developed by the NetBSD Foundation, Inc. and its contributors.

This product includes software developed by the University of California, Berkeley and its contributors.

This product includes software developed by the University of California, Lawrence Berkeley Laboratory and its contributors.

This product includes software developed by the University of California, Lawrence Berkeley Laboratory.  
This product includes software developed for the NetBSD Project by Wasabi Systems, Inc.

This product includes software developed for the NetBSD Project by Matthias Drochner..

## Notice about JPEG

Parts of this product utilize the research results of the Independent JPEG Group.

Package name `sony-target-grel-libjpeg-6b-020201.src.rpm`.

In plain English:

1. We don't promise that this software works. (But if you find any bugs, please let us know!)
2. You can use this software for whatever you want. You don't have to pay us.
3. You may not pretend that you wrote this software. If you use it in a program, you must acknowledge somewhere in your documentation that you've used the IJG code.

In legalese:

The authors make NO WARRANTY or representation, either express or implied, with respect to this software, its quality, accuracy, merchantability, or fitness for a particular purpose. This software is provided "AS IS", and you, its user assume the entire risk as to its quality and accuracy.

This software is copyright (c) 1991-1998, Thomas G. Lane. All Rights Reserved except as specified below.

Permission is hereby granted to use, copy, modify, and distribute this software (or portions thereof) for any purpose, without fee, subject to these conditions:

- (1) If any part of the source code for this software is distributed, then this README file must be included, with this copyright and no-warranty notice unaltered; and any additions, deletions, or changes to the original files must be clearly indicated in accompanying documentation.
- (2) If only executable code is distributed, then the accompanying documentation must state that "this software is based in part on the work of the Independent JPEG Group".
- (3) Permission for use of this software is granted only if the user accepts full responsibility for any undesirable consequences; the authors accept NO LIABILITY for damages of any kind.

These conditions apply to any software derived from or based on the IJG code, not just to the unmodified library. If you use our work, you ought to acknowledge us.

Permission is NOT granted for the use of any IJG author's name or company name in advertising or publicity relating to this software or products derived from it. This software may be referred to only as "the Independent JPEG Group's software".

We specifically permit and encourage the use of this software as the basis of commercial products, provided that all warranty or liability claims are assumed by the product vendor.

## Notice about PuTTY Software

This product contains some code of the application PuTTY.  
Source package: putty-0.58.tar.gz  
License text: <http://www.chiark.greenend.org.uk/~sgtatham/putty/licence.html>

PuTTY is copyright 1997-2006 Simon Tatham.

Portions copyright Robert de Bath, Joris van Rantwijk, Delian Delchev, Andreas Schultz, Jeroen Massar, Wez Furlong, Nicolas Barry, Justin Bradford, Ben Harris, Malcolm Smith, Ahmad Khalifa, Markus Kuhn, and CORE SDI S.A.

Permission is hereby granted, free of charge, to any person obtaining a copy of this software and associated documentation files (the "Software"), to deal in the Software without restriction, including without limitation the rights to use, copy, modify, merge, publish, distribute, sublicense, and/or sell copies of the Software, and to permit persons to whom the Software is furnished to do so, subject to the following conditions:

The above copyright notice and this permission notice shall be included in all copies or substantial portions of the Software.

THE SOFTWARE IS PROVIDED "AS IS", WITHOUT WARRANTY OF ANY KIND, EXPRESS OR IMPLIED, INCLUDING BUT NOT LIMITED TO THE WARRANTIES OF MERCHANTABILITY, FITNESS FOR A PARTICULAR PURPOSE AND NONINFRINGEMENT. IN NO EVENT SHALL SIMON TATHAM BE LIABLE FOR ANY CLAIM, DAMAGES OR OTHER LIABILITY, WHETHER IN AN ACTION OF CONTRACT, TORT OR OTHERWISE, ARISING FROM, OUT OF OR IN CONNECTION WITH THE SOFTWARE OR THE USE OR OTHER DEALINGS IN THE SOFTWARE.

## Notice about fdlibm Software

@(#)fdlibm.h 1.5 95/01/18  
Copyright (C) 1993 by Sun Microsystems, Inc. All rights reserved.  
Developed at SunSoft, a Sun Microsystems, Inc. business.  
Permission to use, copy, modify, and distribute this software is freely granted, provided that this notice is preserved.

## Notice about Root Certificates

In addition, the Runtimes and Runtime Components may contain one or more root certificates (herein referred to as "Root Certificates"). You may not modify the Root Certificates.

## Notice about Nano-XML

Copyright (C) 2000-2002 Marc De Scheemaeker, All Rights Reserved.

This software is provided 'as-is', without any express or implied warranty. In no event will the authors be held liable for any damages arising from the use of this software.

Permission is granted to anyone to use this software for any purpose, including commercial applications, and to alter it and redistribute it freely, subject to the following restrictions:

1. The origin of this software must not be misrepresented; you must not claim that you wrote the original software. If you use this software in a product, an acknowledgment in the product documentation would be appreciated but is not required.
2. Altered source versions must be plainly marked as such, and must not be misrepresented as being the original software.
3. This notice may not be removed or altered from any source distribution.

## About MPEG-4 AVC and VC-1

THIS PRODUCT IS LICENSED UNDER THE AVC PATENT PORTFOLIO LICENSE AND VC-1 PATENT PORTFOLIO LICENSE FOR THE PERSONAL AND NON-COMMERCIAL USE OF A CONSUMER TO DECODE VIDEO IN COMPLIANCE WITH THE AVC STANDARD ("AVC VIDEO") AND/OR THE VC-1 STANDARD ("VC-1 VIDEO") THAT WAS ENCODED BY A CONSUMER ENGAGED IN A PERSONAL AND NON-COMMERCIAL ACTIVITY AND/OR WAS OBTAINED FROM A VIDEO PROVIDER LICENSED TO PROVIDE AVC VIDEO AND/OR VC-1 VIDEO. NO LICENSE IS GRANTED OR SHALL BE IMPLIED FOR ANY OTHER USE. ADDITIONAL INFORMATION MAY BE OBTAINED FROM MPEG LA, L.L.C. SEE [HTTP://WWW.MPEGLA.COM](http://www.MPEGLA.COM)

## The curl license

COPYRIGHT AND PERMISSION NOTICE

Copyright (c) 1996 - 2009, Daniel Stenberg, <daniel@haxx.se>.

All rights reserved.

Permission to use, copy, modify, and distribute this software for any purpose with or without fee is hereby granted, provided that the above copyright notice and this permission notice appear in all copies.

THE SOFTWARE IS PROVIDED "AS IS", WITHOUT WARRANTY OF ANY KIND, EXPRESS OR IMPLIED, INCLUDING BUT NOT LIMITED TO THE WARRANTIES OF MERCHANTABILITY, FITNESS FOR A PARTICULAR PURPOSE AND NONINFRINGEMENT OF THIRD PARTY RIGHTS. IN NO EVENT SHALL THE AUTHORS OR COPYRIGHT HOLDERS BE LIABLE FOR ANY CLAIM, DAMAGES OR OTHER LIABILITY, WHETHER IN AN ACTION OF CONTRACT, TORT OR OTHERWISE, ARISING FROM, OUT OF OR IN CONNECTION WITH THE SOFTWARE OR THE USE OR OTHER DEALINGS IN THE SOFTWARE.

Except as contained in this notice, the name of a copyright holder shall not be used in advertising or otherwise to promote the sale, use or other dealings in this Software without prior written authorization of the copyright holder.

## Notice about expat

Copyright (c) 1998, 1999, 2000 Thai Open Source Software Center Ltd and Clark Cooper Copyright (c) 2001, 2002, 2003 Expat maintainers.

Permission is hereby granted, free of charge, to any person obtaining a copy of this software and associated documentation files (the "Software"), to deal in the Software without restriction, including without limitation the rights to use, copy, modify, merge, publish, distribute, sublicense, and/or sell copies of the Software, and to permit persons to whom the Software is furnished to do so, subject to the following conditions:

The above copyright notice and this permission notice shall be included in all copies or substantial portions of the Software.

THE SOFTWARE IS PROVIDED "AS IS", WITHOUT WARRANTY OF ANY KIND, EXPRESS OR IMPLIED, INCLUDING BUT NOT LIMITED TO THE WARRANTIES OF MERCHANTABILITY, FITNESS FOR A PARTICULAR PURPOSE AND NONINFRINGEMENT. IN NO EVENT SHALL THE AUTHORS OR COPYRIGHT HOLDERS BE LIABLE FOR ANY CLAIM, DAMAGES OR OTHER LIABILITY, WHETHER IN AN ACTION OF CONTRACT, TORT OR OTHERWISE, ARISING FROM, OUT OF OR IN CONNECTION WITH THE SOFTWARE OR THE USE OR OTHER DEALINGS IN THE SOFTWARE.

---

# Glossary

## **AVCHD**

The AVCHD format is a high-definition digital video camera format used to record SD (standard definition) or HD (high definition) signals of either the 1080i specification\* or the 720p specification\*\* on DVDs, using efficient data compression coding technology. The MPEG-4 AVC/H.264 format is adopted to compress video data, and the Dolby Digital or Linear PCM system is used to compress audio data. The MPEG-4 AVC/H.264 format is capable of compressing images at higher efficiency than that of the conventional image compression format. The MPEG-4 AVC/H.264 format enables a high definition (HD) video signal shot on a digital video camera recorder to be recorded on DVD discs in the same way as it would be for a standard definition (SD) television signal.

\* A high definition specification that utilizes 1080 effective scanning lines and the interlace format.

\*\* A high definition specification that utilizes 720 effective scanning lines and the progressive format.

## **BD-J application**

The BD-ROM format supports Java for interactive functions. "BD-J" offers content providers almost unlimited functionality when creating interactive BD-ROM titles.

## **BD-R**

BD-R (Blu-ray Disc Recordable) is a recordable, write-once Blu-ray Disc, available in the same capacities as the BD below. Since contents can be recorded and cannot be overwritten, a BD-R can be used to archive valuable data or storing and distributing video material.

## **BD-RE**

BD-RE (Blu-ray Disc Rewritable) is a recordable and rewritable Blu-ray Disc, available in the same capacities as the BD below. The re-recordable feature makes extensive editing and time-shifting applications possible.

## **BD-ROM**

BD-ROMs (Blu-ray Disc Read-Only Memory) are commercially produced discs and are available in the same capacities as the BD below. Other than conventional movie and video contents, these discs have enhanced features such as interactive content, menu operations using pop-up menus, selection of subtitle display, and slideshow. Although a BD-ROM may contain any form of data, most BD-ROM discs will contain movies in High Definition format, for playback on Blu-ray Disc/DVD players.

## **Blu-ray Disc (BD)**

A disc format developed for recording/playing high-definition (HD) video (for HDTV, etc.), and for storing large amounts of data. A single layer Blu-ray Disc holds up to 25 GB, and a dual-layer Blu-ray Disc holds up to 50 GB of data.

## **DCS (Digital Cinema Sound)**

In collaboration with Sony Pictures Entertainment, Sony measured the sound environment of their studios and integrated the data of the measurement with Sony DSP (Digital Signal Processor) technology to develop "Digital Cinema Sound." "Digital Cinema Sound" simulates in a home theater an ideal movie theater sound environment based on the preference of the movie director.

## **Digital Cinema Auto Calibration**

Digital Cinema Auto Calibration was developed by Sony to automatically measure and adjusts the speaker settings to your listening environment in a short period of time.

## **Dolby Digital**

This movie theater sound format is more advanced than Dolby Surround Pro Logic. In this format, the surround speakers output stereo sound with an expanded frequency range, and a subwoofer channel for deep bass is independently provided. This format is also called "5.1" with the subwoofer channel designed as the 0.1 channel (since it functions only when a deep bass effect is needed). All six channels in this format are recorded separately for superior channel separation. Furthermore,



since all the signals are processed digitally, less signal degradation occurs.

### **Dolby Digital Plus**

Developed as an extension to Dolby Digital, the audio coding technology supports 7.1 multi-channel surround sound.

### **Dolby Pro Logic II**

Dolby Pro Logic II creates five full-bandwidth output channels from 2 channel sources. This is done using an advanced, high-purity matrix surround decoder that extracts the spatial properties of the original recording without adding any new sounds or tonal colorations.

#### ■ **Movie mode**

The Movie mode is for use with stereo television shows and all programs encoded in Dolby Surround. The result is enhanced sound field directionality that approaches the quality of discrete 5.1-channel sound.

#### ■ **Music mode**

The Music mode is for use with any stereo music recordings, and provides a wide and deep sound space.

### **Dolby Surround Pro Logic**

As one method of decoding Dolby Surround, Dolby Surround Pro Logic produces four channels from 2 channel sound. Compared with the former Dolby Surround system, Dolby Surround Pro Logic reproduces left-to-right panning more naturally and localizes sounds more precisely. To take full advantage of Dolby Surround Pro Logic, you should have one pair of surround speakers and a center speaker. The surround speakers output monaural sound.

### **Dolby TrueHD**

Dolby TrueHD is a lossless coding technology that supports up to 8 channels of multi-channel surround sound for the next generation optical discs. The reproduced sound is true to the original source bit-for-bit.

### **DTS**

Digital audio compression technology developed by DTS, Inc. This technology conforms to 5.1-channel surround. This format comprises of stereo rear channel and there is discrete subwoofer channel in this format. DTS provides the same 5.1 discrete channels of high quality digital audio. The good channel separation is realized due to the all channel data being recorded discretely and processed in digitally.

### **DTS-HD High Resolution Audio**

Developed as an extension to DTS Digital Surround format. It supports a maximum sampling frequency of 96 kHz, and 7.1 multi-channel surround.

DTS-HD High Resolution Audio has a maximum transmission rate of 6 Mbps, with lossy compression (Lossy).

### **DTS-HD Master Audio**

DTS-HD Master Audio has a maximum transmission rate of 24.5 Mbps, and uses lossless compression (Lossless), and DTS-HD Master Audio corresponds to a maximum sampling frequency of 192 kHz, and maximum of 7.1ch.

### **HDMI (High-Definition Multimedia Interface)**

HDMI is an interface that supports both video and audio on a single digital connection, allowing you to enjoy high quality digital picture and sound. The HDMI specification supports HDCP (High-bandwidth Digital Content Protection), a copy protection technology that incorporates coding technology for digital video signals.

### **Interlace format (Interlaced scanning)**

The Interlace format is the NTSC standard method for displaying TV images at 30 frames per second. Each frame is scanned twice - alternately between the even numbered scanning lines and then odd numbered scanning lines, at 60 times per second.

### **LTH (Low to High)**

LTH is a recording system that supports organic pigment type BD-R.

## **Parental Control**

A function of the BD/DVD to limit playback of the disc by the age of the users according to the limitation level in each country. The limitation varies from disc to disc; when it is activated, playback is completely prohibited, violent scenes are skipped or replaced with other scenes and so on.

## **PhotoTV HD**

“PhotoTV HD” allows for a highly-detailed pictures, and photo-like expression of subtle textures and colors. By connecting Sony “PhotoTV HD” compatible devices using an HDMI cable, whole new world of photos can be enjoyed in breathtaking Full HD quality. For instance, the delicate texture of the human skin, flowers, sand and waves can now be displayed on a large screen in beautiful photo-like quality.

## **Pop-up menu**

An enhanced menu operation available on BD-ROMs. The pop-up menu appears when POP UP/MENU is pressed during playback, and can be operated while playback is in progress.

## **Progressive format (sequential scanning)**

In contrast to the Interlace format, the progressive format can reproduce 50 - 60 frames per second by reproducing all scanning lines (525 lines for the NTSC system). The overall picture quality increases and still images, text and horizontal lines appear sharper. This format is compatible with the 525 or 625 progressive format.

## **S-AIR (Sony Audio Interactive Radio frequency)**

Recent times have seen the rapid spread of BD/DVD media, Digital Broadcasting, and other high-quality media.

To ensure that the subtle nuances of these high-quality media are transmitted with no deterioration, Sony has developed a technology called “S-AIR” for the radio transmission of digital audio signals with no compression, and has incorporated this technology into the EZW-RT10/EZW-RT10A/EZW-T100.

This technology transfers digital audio signals with no compression using the 2.4 GHz band

range of ISM band (Industrial, Scientific, and Medical band), such as wireless LANs and Bluetooth applications.

## **x.v.Color**

x.v.Color is a familiar term for the xvYCC standard proposed by Sony.

xvYCC is an international standard for Color space in video.

This standard can express a wider color range than the currently used broadcast standard.

## **24p True Cinema**

Movies shot with a film camera consist of 24 frames per second.

Since conventional televisions (both CRT and flat panels) display frames either at 1/60 or 1/50 second intervals, the 24 frames do not appear at an even pace.

When connected to a TV with 24p capabilities, the player displays each frame at 1/24 second intervals — the same interval originally shot with the film camera, thus faithfully reproducing the original cinema image.

# Index

## Numerics

24p True Cinema 122

## A

A/V SYNC 47  
ANGLE 43  
Attenuate - AUDIO 83  
Attenuate - TV 82  
Audio 84  
Audio DRC 82  
Audio Settings 82  
Auto Calibration 70, 83  
Auto Display 87  
AVCHD 101, 120

## B

BD Audio Setting 82  
BD Data 48  
BD Internet Connection 85  
BD Parental Control 84  
BD/DVD Menu 84  
BD/DVD Viewing Settings 84  
BD-RE 101  
BD-Live 48  
BDMV 101  
BD-R 120  
BD-RE 120  
Blu-ray Disc 120

## C

CD 49, 101  
Child Lock 76  
Cinema Conversion Mode 81  
Control for HDMI 43, 67, 86

## D

D. C. A. C. (Digital Cinema  
Auto Calibration) 70, 120  
DEMO 76  
DIGITAL MEDIA PORT 60  
DIMMER 75  
Disc Lock 42  
Dolby Digital 53, 120  
Dolby Digital Plus 121  
Dolby Pro Logic II 121  
Dolby Surround Pro Logic 121  
Dolby TrueHD 121  
DTS 53, 121  
DTS-HD 121  
DVD 41, 101  
DVD Aspect Ratio 80

DVD Parental Control 84  
DYNAMIC BASS 54

## E

Easy Setup 34, 89

## F

FM MODE 56  
Front panel 12  
Front panel display 13

## H

HDMI  
YCbCr/RGB (HDMI) 82  
HDMI (High-Definition  
Multimedia Interface) 121  
HDMI Settings 86  
Hybrid Disc Playback Layer 85

## I

Instant Advance 42  
Instant Replay 42  
Interlace format 121  
Internet Settings 88

## L

Language Code List 108  
LTH 121

## M

Multiplex broadcast sound 54

## N

NAME IN 59  
Network Settings 88  
Network Update 79  
NIGHT 55

## O

One-Touch Play 43  
OPTIONS 51  
OSD 87  
Output Video Format 81

## P

PAIRING 64  
PARENTAL CONTROL 122  
Parental Control 42  
Parental Control Region Code  
85  
Password 85

Pause Mode 82  
Photo Settings 86  
PhotoTV HD 51, 122  
Playable discs 101  
POP UP/MENU 44  
Progressive format 122

## R

Rear panel 14  
Region code 102  
Remote 9  
Resetting 90  
Resume Play 44  
RF CHANGE 65

## S

S-AIR 5, 61, 122  
S-AIR ID 61  
S-AIR receiver 61  
S-AIR INFO 65  
S-AIR MODE 62  
S-AIR STBY 63  
Screen Format 80  
Screen Saver 87  
SLEEP MENU 75  
Slideshow Speed 86  
Sound Effect 83  
Speaker Settings 71, 83  
Connection 71  
Distance 72  
Level 72  
Standby Mode 87  
Subtitle 84  
Surround amplifier 15, 61  
System Information 87  
SYSTEM MENU 38, 47, 55,  
62, 63, 64, 65, 75, 76

## T

Test Tone 72  
TONE 55  
TV Type 80

## U

Update 79

## V

Video Settings 80

## X

x.v.Color 82, 122

## Free Manuals Download Website

<http://myh66.com>

<http://usermanuals.us>

<http://www.somanuals.com>

<http://www.4manuals.cc>

<http://www.manual-lib.com>

<http://www.404manual.com>

<http://www.luxmanual.com>

<http://aubethermostatmanual.com>

Golf course search by state

<http://golfingnear.com>

Email search by domain

<http://emailbydomain.com>

Auto manuals search

<http://auto.somanuals.com>

TV manuals search

<http://tv.somanuals.com>