



Blu-ray Disc/DVD Home Theatre System

Operating Instructions

BDV-E870 / E370

WARNING

Do not install the appliance in a confined space, such as a bookcase or built-in cabinet.

To reduce the risk of fire, do not cover the ventilation opening of the apparatus with newspapers, tablecloths, curtains, etc. Do not

place the naked flame sources such as lighted candles on the apparatus.

To reduce the risk of fire or electric shock, do not expose this apparatus to dripping or splashing, and do not place objects filled with liquids, such as vases, on the apparatus.

Do not expose batteries or apparatus with battery-installed to excessive heat such as sunshine, fire or the like.

To prevent injury, this apparatus must be securely attached to the floor/wall in accordance with the installation instructions.

Indoor use only.

CAUTION

The use of optical instruments with this product will increase eye hazard. As the laser beam used in this Blu-ray Disc / DVD Home Theatre System is harmful to eyes, do not attempt to disassemble the cabinet.

Refer servicing to qualified personnel only.



This appliance is classified as a CLASS 3R LASER product.

Visible and invisible laser radiation is emitted when the laser protective housing is opened, so be sure to avoid direct eye exposure.

This marking is located on the laser protective housing inside the enclosure.

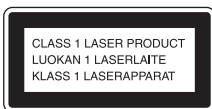

This appliance is classified as a CLASS 1 LASER product. This marking is located on the rear exterior.



Disposal of Old Electrical & Electronic Equipment (Applicable in the European

Union and other European countries with separate collection systems)

This symbol on the product or on its packaging indicates that this product shall not be treated as household waste. Instead it shall be handed over to the applicable collection point for the recycling of electrical and electronic equipment. By ensuring this product is disposed of correctly, you will help prevent potential negative consequences for the environment and human health, which could otherwise be caused by inappropriate waste handling of this product. The recycling of materials will help to conserve natural resources. For more detailed information about recycling of this product, please contact your local Civic Office, your household waste disposal service or the shop where you purchased the product.



Disposal of waste batteries (applicable in the European

Union and other European countries with separate collection systems)

This symbol on the battery or on the packaging indicates that the battery provided with this product shall not be treated as household waste. On

certain batteries this symbol might be used in combination with a chemical symbol. The chemical symbols for mercury (Hg) or lead (Pb) are added if the battery contains more than 0.0005% mercury or 0.004% lead. By ensuring these batteries are disposed of correctly, you will help prevent potentially negative consequences for the environment and human health which could otherwise be caused by inappropriate waste handling of the battery. The recycling of the materials will help to conserve natural resources. In case of products that for safety, performance or data integrity reasons require a permanent connection with an incorporated battery, this battery should be replaced by qualified service staff only. To ensure that the battery will be treated properly, hand over the product at end-of-life to the applicable collection point for the recycling of electrical and electronic equipment. For all other batteries, please view the section on how to remove the battery from the product safely. Hand the battery over to the applicable collection point for the recycling of waste batteries. For more detailed information about recycling of this product or battery, please contact your local Civic Office, your household waste disposal service or the shop where you purchased the product.

Notice for customers: the following information is only applicable to equipment sold in countries applying EU directives.

The manufacturer of this product is Sony Corporation, 1-7-1 Konan Minato-ku Tokyo, 108-0075 Japan. The Authorized Representative for EMC and product safety is Sony Deutschland GmbH, Hedelfinger Strasse 61, 70327 Stuttgart, Germany. For any service or

guarantee matters please refer to the addresses given in separate service or guarantee documents.

Precautions

This equipment has been tested and found to comply with the limits set out in the EMC Directive using a connection cable shorter than 3 meters. (European and Russian models only)

On power sources

- The unit is not disconnected from the mains as long as it is connected to the AC outlet, even if the unit itself has been turned off.
- As the main plug is used to disconnect the unit from the mains, connect the unit to an easily accessible AC outlet. Should you notice an abnormality in the unit, disconnect the main plug from the AC outlet immediately.

Copyrights and Trademarks

- This product incorporates copyright protection technology that is protected by U.S. patents and other intellectual property rights. Use of this copyright protection technology must be authorized by Macrovision, and is intended for home and other limited viewing uses only unless otherwise authorized by Macrovision. Reverse engineering or disassembly is prohibited.
- This system incorporates with Dolby* Digital and Dolby Pro Logic (II) adaptive matrix surround decoder and the DTS** Digital Surround System.

* Manufactured under license from Dolby Laboratories. Dolby, Pro Logic, and the double-D symbol are trademarks of Dolby Laboratories.

** Manufactured under license under U.S. Patent #’s:

5,451,942; 5,956,674; 5,974,380; 5,978,762; 6,226,616; 6,487,535; 7,212,872; 7,333,929; 7,392,195; 7,272,567 & other U.S. and worldwide patents issued & pending. DTS is a registered trademark and the DTS logos, Symbol, DTS-HD and DTS-HD Master Audio are trademarks of DTS, Inc. © 1996-2008 DTS, Inc. All Rights Reserved.

- This system incorporates High-Definition Multimedia Interface (HDMI™) technology. HDMI, the HDMI logo and High-Definition Multimedia Interface are trademarks or registered trademarks of HDMI Licensing LLC.
- Java and all Java-based trademarks and logos are trademarks or registered trademarks of Sun Microsystems, Inc.
- “BD-LIVE” and “BONUSVIEW” are trademarks of Blu-ray Disc Association.
- “Blu-ray Disc” is a trademark.
- “Blu-ray Disc,” “DVD+RW,” “DVD-RW,” “DVD+R,” “DVD-R,” “DVD VIDEO,” and “CD” logos are trademarks.
- “BRAVIA” is a trademark of Sony Corporation.
- “AVCHD” and the “AVCHD” logo are trademarks of Matsushita Electric Industrial Co., Ltd. and Sony Corporation.
- “S-AIR” and its logo are trademarks of Sony Corporation.
- “XMB,” and “cross media bar” are trademarks of Sony Corporation and Sony Computer Entertainment Inc.
- “PLAYSTATION” is a trademark of Sony Computer Entertainment Inc.
- DivX®, DivX Certified® and associated logos are registered trademarks of DivX, Inc. and are used under license.

- Music and video recognition technology and related data are provided by Gracenote®. Gracenote is the industry standard in music recognition technology and related content delivery. For more information, please visit www.gracenote.com. CD, DVD, Blu-ray Disc, and music and video-related data from Gracenote, Inc., copyright © 2000-present Gracenote. Gracenote Software, copyright © 2000-present Gracenote. One or more patents owned by Gracenote apply to this product and service. See the Gracenote website for a nonexhaustive list of applicable Gracenote patents. Gracenote, CDDB, MusicID, MediaVOCS, the Gracenote logo and logotype, and the “Powered by Gracenote” logo are either registered trademarks or trademarks of Gracenote in the United States and/or other countries.



- “PhotoTV HD” and the “PhotoTV HD” logo are trademarks of Sony Corporation.
- MPEG Layer-3 audio coding technology and patents licensed from Fraunhofer IIS and Thomson.
- iPod is a trademark of Apple Inc., registered in the U.S. and other countries.
- “Made for iPod” means that an electronic accessory has been designed to connect specifically to iPod and has been certified by the developer to meet Apple performance standards.
- Apple is not responsible for the operation of this device or its compliance with safety and regulatory standards.
- Other system and product names are generally trademarks or registered trademarks of the manufacturers. ™ and ® marks are not indicated in this document.

About These Operating Instructions

- The instructions in these Operating Instructions describe the controls on the remote. You can also use the controls on the unit if they have the same or similar names as those on the remote.
- In this manual, “disc” is used as a general reference for BDs, DVDs, Super Audio CDs, or CDs unless otherwise specified by the text or illustrations.
- The instructions in this manual are for BDV-E870 and BDV-E370. BDV-E870 is the model used for illustration purposes. Any difference in operation is clearly indicated in the text, for example, “BDV-E870.”
- The items displayed on the TV screen may vary depending on the area.
- The default setting is underlined.
- The system is compatible with the S-AIR function, which allows transmission of sound between S-AIR products wirelessly. For details on the S-AIR function, see “Using an S-AIR Product” (page 39).
- Notes or instructions for the surround amplifier, surround back amplifier, or S-AIR receiver in these Operating Instructions refer only to when the surround amplifier, surround back amplifier, or S-AIR receiver is used.

Table of Contents

About These Operating Instructions	4
Unpacking	6
Index to Parts and Control	8

Getting Started

Step 1: Installing the System.....	13
Step 2: Connecting the System...	19
Step 3: Performing the Easy Setup.....	25
Step 4: Selecting the Source.....	26
Step 5: Enjoying Surround Sound.....	27

Playback

Playing a Disc	29
Playing from a USB Device.....	30
Enjoying an iPod.....	30
Playing via a Network.....	31
Available Options	32

Sound Adjustment

Selecting the Effect to Suit the Source	34
Selecting the Audio Format, Multilingual Tracks, or Channel.....	34
Enjoying Multiplex Broadcast Sound	35
Using the Sound Effect	35

Tuner

Listening to the Radio.....	37
Using the Radio Data System (RDS).....	38

External Audio Device

Using an S-AIR Product	39
------------------------------	----

Other Operations

Using the Control for HDMI Function for “BRAVIA” Sync	44
Calibrating the Appropriate Settings Automatically	46
Setting the Speakers	47
Using the Sleep Timer	49
Deactivating the Buttons on the Unit	49

Controlling Your TV with the Supplied Remote	49
Saving Power in Standby Mode	49

Settings and Adjustments

Using the Setup Display	50
[Network Update].....	50
[Screen Settings].....	51
[Audio Settings].....	52
[BD/DVD Viewing Settings].....	52
[Parental Control Settings]	53
[Music Settings].....	53
[System Settings]	54
[Network Settings].....	55
[Easy Setup].....	55
[Resetting]	55

Additional Information

Precautions.....	56
Notes about the Discs	57
Troubleshooting.....	58
Playable Discs.....	65
Playable Types of Files.....	66
Supported Audio Formats.....	67
Video Output Resolution	67
Specifications.....	68
Language Code List.....	70
Glossary	71
Index	74

Unpacking

BDV-E870

- Front speakers (2)

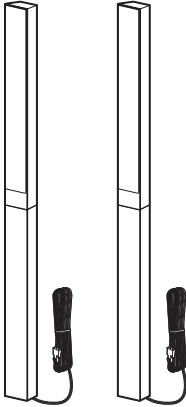

- Surround speakers (2)

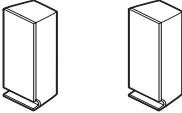

- Center speaker (1)

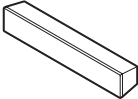

- Subwoofer (1)

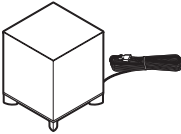

- FM wire antenna (aerial) (1)

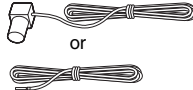

or



- Speaker cords (3, blue/gray/green)



- Video cord (1)



- Remote commander (remote) (1)

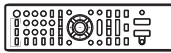

- R6 (size AA) batteries (2)



- Calibration mic (1)



- Bases (2)



- Screws (6)



- Speaker-bottom covers (2)

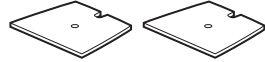

- Operating Instructions
- Speaker Installation Guide
- Quick Setup Guide
- End user license agreement
- HDMI cable (1)
(Taiwan models only)

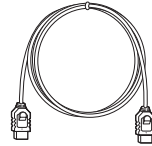

BDV-E370

- Front speakers (2)

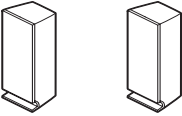

- Surround speakers (2)

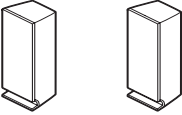

- Center speaker (1)

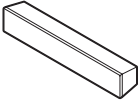

- Subwoofer (1)

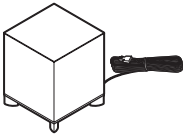

- FM wire antenna (aerial) (1)

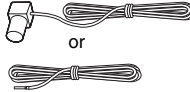

- Speaker cords (5, white/red/blue/gray/green)



- Video cord (1)



- Remote commander (remote) (1)

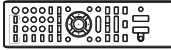

- R6 (size AA) batteries (2)



- Calibration mic (1)



- Operating Instructions
- Quick Setup Guide
- End user license agreement
- HDMI cable (1)
(Singapore, Thai, and Taiwan models only)

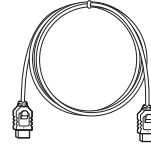

Preparing the remote

Insert two R6 (size AA) batteries (supplied) by matching the ⊕ and ⊖ ends on the batteries to the markings inside the compartment.

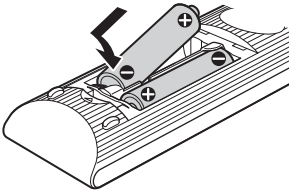

Index to Parts and Control

For more information, refer to the pages indicated in parentheses.

Front panel

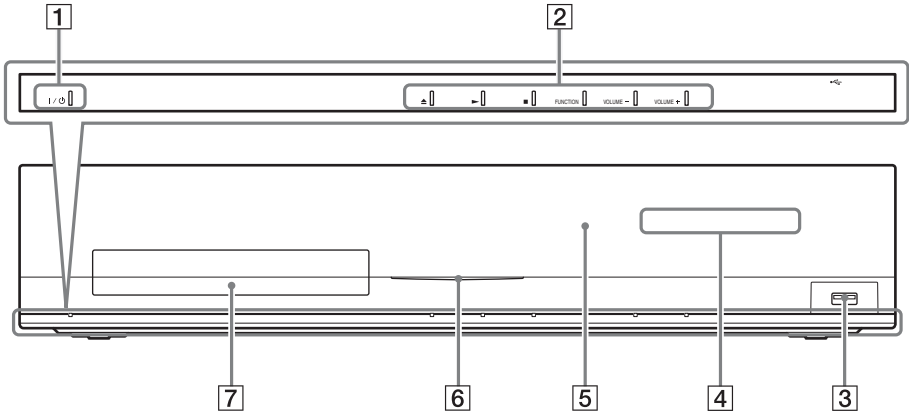

- 1 I/O (on/standby)**
Turns on the unit, or sets it to standby mode.
- 2 Play operation buttons**
 - ▲ (open/close) (page 29)**
Opens or closes the disc tray.
 - ▶ (play)**
Starts or re-starts playback (resume play).
Plays a slideshow when a disc containing JPEG image files is inserted.
 - (stop)**
Stops playback and remembers the stop point (resume point).
The resume point for a title/track is the last point you played or the last photo for a photo folder.
- FUNCTION**
Selects the playback source.
- VOLUME +/-**
Adjusts the system's volume.
- 3 USB port (page 30)**
Used for connecting a USB device.
- 4 Front panel display**
- 5 Remote sensor**
- 6 Power indicator**
Lights up while the system is turned on.
- 7 Disc tray (page 29)**

Front panel display

About the indications in the front panel display

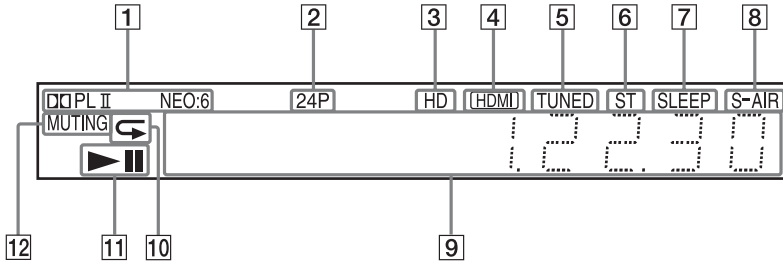

- 1** Displays the current sound format.
- 2** Lights up when outputting 1920 x 1080p/24 Hz video signals.
- 3** Lights up when outputting 720p/1080i/1080p video signals from the HDMI OUT jack or 720p/1080i video signals from the COMPONENT VIDEO OUT jacks.
- 4** Lights up when the HDMI OUT jack is correctly connected to an HDCP (High-bandwidth Digital Content Protection)-compliant device with HDMI or DVI (Digital Visual Interface) input.
- 5** Lights up when a station is received. (Radio only) (page 37)
- 6** Lights up when stereo sound is received. (Radio only) (page 37)
- 7** Flashes when the sleep timer is set. (page 49)
- 8** S-AIR indicator (only when the wireless transmitter (not supplied) is inserted into the unit)
Lights up during wireless transmission. Flashes when [Standby] is set to [On] and the system is in standby mode while wireless transmission between the unit and S-AIR receiver is not activated. (page 39)
- 9** Displays system's status such as chapter, title, or track number, time information, radio frequency, playing status, surround setting, etc.
- 10** Lights up when repeat play is activated.
- 11** Displays system's playing status.
- 12** Lights up when muting is on.

Rear panel

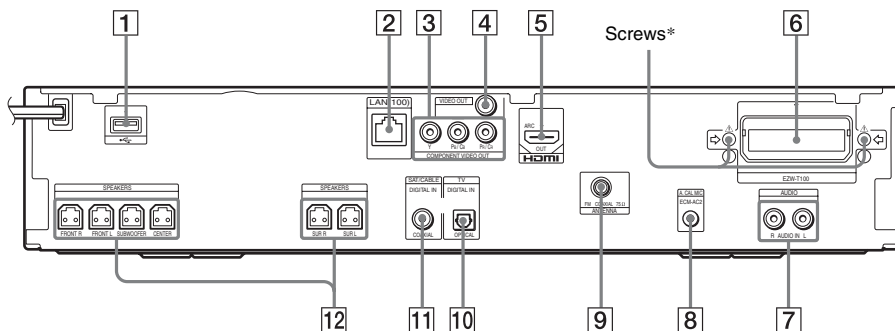

- 1** • (USB) port (page 30)
- 2** LAN (100) terminal (page 24)
- 3** COMPONENT VIDEO OUT jacks (page 20)
- 4** VIDEO OUT jack (page 20)
- 5** HDMI OUT jack (page 20)
- 6** EZW-T100 slot (page 39)
- 7** AUDIO (AUDIO IN L/R) jacks (page 22)
- 8** A.CAL MIC jack (pages 25, 46)
- 9** ANTENNA (FM COAXIAL 75Ω) jack (page 23)
- 10** TV (DIGITAL IN OPTICAL) jack (page 21)
- 11** SAT/CABLE (DIGITAL IN COAXIAL) jack (page 22)
- 12** SPEAKERS jacks (page 19)

*** ⚠ CAUTION**

Please do not remove the screws unless you are installing the EZW-T100.

Remote control

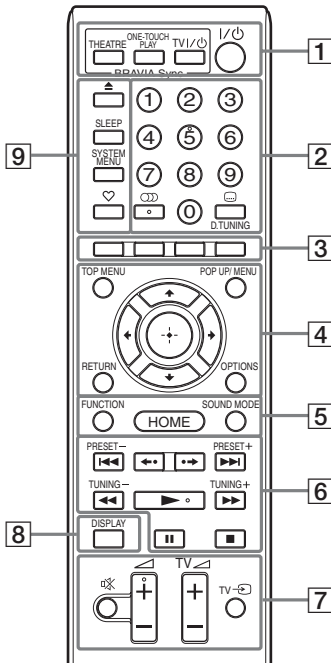

Number 5, , , and buttons have a tactile dot. Use the tactile dot as a reference when operating the remote.

- : For TV operations
(For details, see “Controlling Your TV with the Supplied Remote” (page 49).)

1 THEATRE (page 45)

Switches to the optimum video mode for watching movies automatically.

ONE-TOUCH PLAY (page 45)

Activates One-Touch Play.

TV I/⏻ (on/standby) (page 49)

Turns on the TV or sets it to standby mode.

I/⏻ (on/standby) (pages 25, 37)

Turns on the system or sets it to standby mode.

2 Number buttons (pages 38, 49)

Enters the title/chapter numbers, radio frequencies, etc.

(audio) (pages 34, 35)

Selects the audio format/track.

(subtitle) (page 53)

Selects the subtitle language when multilingual subtitles are recorded on a BD-ROM/DVD VIDEO.

D.TUNING (page 37)

Selects the radio frequencies.

3 Color buttons (red/green/yellow/blue)

Short cut keys for selecting items on some BD menus (can also be used for Java interactive operations on BDs).

4 TOP MENU

Opens or closes the BD's or DVD's Top Menu.

POP UP/MENU

Opens or closes the BD-ROM's Pop-up Menu, or the DVD's menu.

OPTIONS (page 32)

Displays the options menu on the TV screen.

RETURN

Returns to the previous display.

/ / /

Moves the highlight to a displayed item.

(ENTER)

Enters the selected item.

5 FUNCTION (pages 26, 37)

Selects the playback source.

HOME (pages 25, 37, 39, 46, 47, 50)

Enters or exits the system's home menu.

SOUND MODE (page 34)

Selects the sound mode.

6 Playback operation buttons

See “Playback” (page 29).

/ (previous/next)

Skip to the previous/next chapter, track, or file.

/ (replay/advance)

Briefly replay the current scenes for 10 seconds./Briefly fast forwards the current scenes for 15 seconds.

◀◀/▶▶ (fast reverse/fast forward)

Fast reverse/fast forward the disc during playback. Each time you press the button, search speed changes.

Activates slow-motion play when pressed for more than one second in pause mode. Plays one frame at a time when pressed in pause mode.

▶ (play)

Starts or re-starts playback (resume play). Plays a slideshow when a disc containing JPEG image files is inserted.

⏸ (pause)

Pauses or re-starts playback.

■ (stop)

Stops playback and remembers the stop point (resume point). The resume point for a title/track is the last point you played or the last photo for a photo folder.

Radio operation buttons

See “Tuner” (page 37).

PRESET +/-

TUNING +/-

7 **🔇 (muting)**

Turns off the sound temporarily.

◀ (volume) +/- (page 37)

Adjusts the volume.

TV **◀ (volume) +/-**

Adjusts the TV volume.

TV **↔ (TV input)**

Switches the TV's input source between the TV and other input sources.

8 **DISPLAY (pages 29, 31)**

Displays the playback information on the TV screen.

When the function is “TUNER FM,” changes the radio information in the front panel display (European and Russian models only).

When the function is “TV” or “SAT/CABLE” and digital signals are input via the DIGITAL IN jack, displays the stream information in the front panel display.

9 **▲ (open/close)**

Opens or closes the disc tray.

SLEEP (page 49)

Sets the sleep timer.

SYSTEM MENU (pages 27, 33, 35, 37)

Enters the system menu.

♡ (favorites)

Displays the Internet contents added to the Favorites List. You can save 18 favorite Internet contents.

Step 1: Installing the System

Positioning the speakers

For the best possible surround sound, place all speakers at the same distance from the listening position (A). The distance can be between 0.0 to 7.0 meters.

If you cannot place the center speaker and surround speakers at the same distance as (A), place them within 7.0 meters of the listening position.

Place the surround speakers to the rear of the listening position (B).

The subwoofer can be placed anywhere in the room.

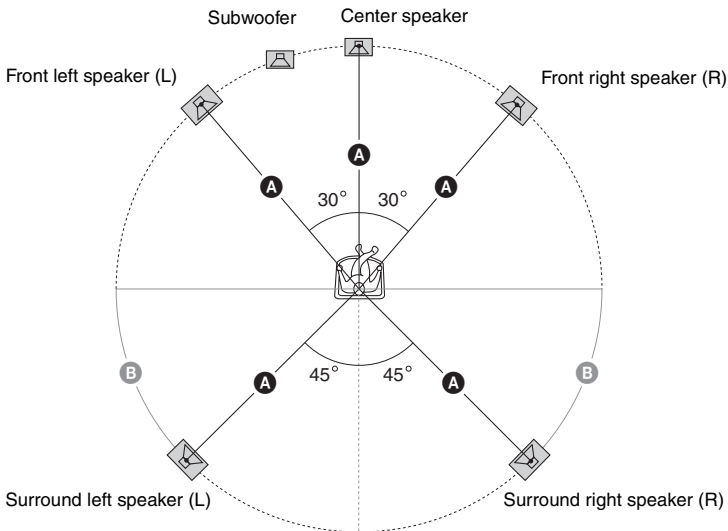

Note

- Use caution when placing the speakers and/or speaker stands attached to the speakers on a specially treated (waxed, oiled, polished, etc.) floor, as staining or discoloration may result.
- Do not lean or hang on a speaker, as it may fall down.

To add the optional surround back speakers

You can enjoy 7.1 surround sound by purchasing the Wireless Surround Speaker Kit (WAHT-SBP2, optional). The optional product lineup differs depending on the area.

For the position of the surround back speakers, refer the illustration below (C).

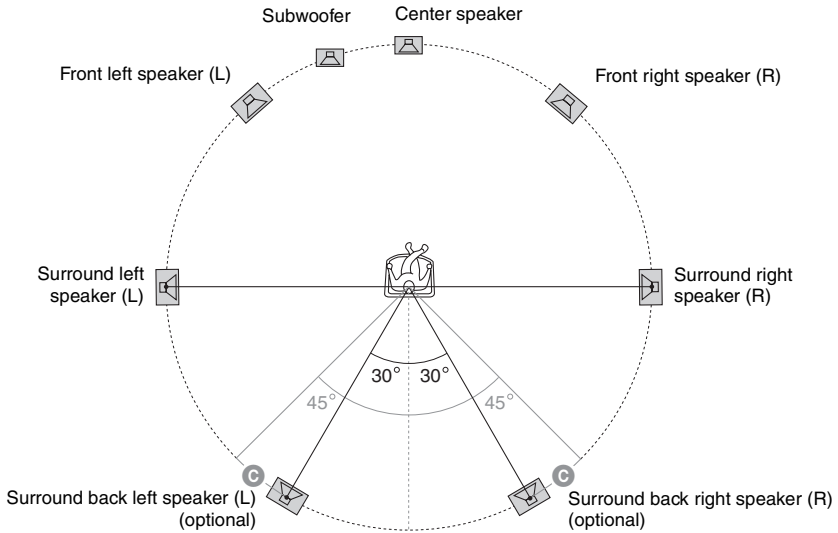

Note

- To use the surround back speakers, set [Surround Back] (page 47) in [Speaker Settings] to [Yes] while performing the Easy Setup (page 25).

Installing the speakers on a wall

Caution

- Contact a screw shop or installer regarding the wall material or screws to be used.
- Use screws that are suitable for the wall material and strength. As a plaster board wall is especially fragile, attach the screws securely to a beam and fasten them to the wall. Install the speakers on a vertical and flat wall where reinforcement is applied.
- Sony is not responsible for accidents or damage caused by improper installation, insufficient wall strength or improper screw installation, natural calamity, etc.

Before installing the front speakers of BDV-E870 on a wall, you need to disassemble the speakers. You can install the upper part of the speakers on a wall.

To disassemble the speaker (Front speakers of BDV-E870 only)

- 1** Disconnect the speaker cords from the speaker.

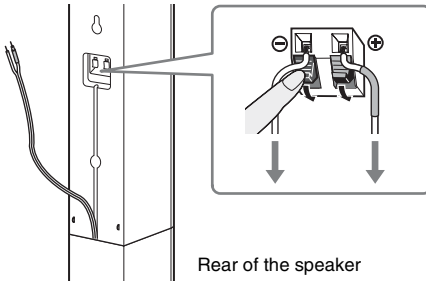

- 2** Remove the screw (pre-installed) at the rear of the speaker.

This screw is used when reassembling the speaker. Be sure not to lose the screw.

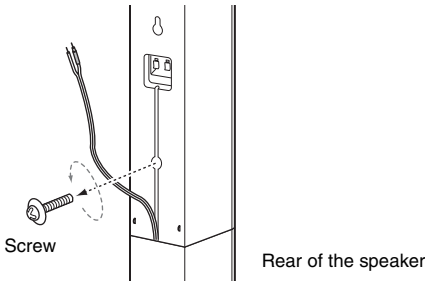

- 3** Disassemble the speaker by lifting the upper part of the speaker.

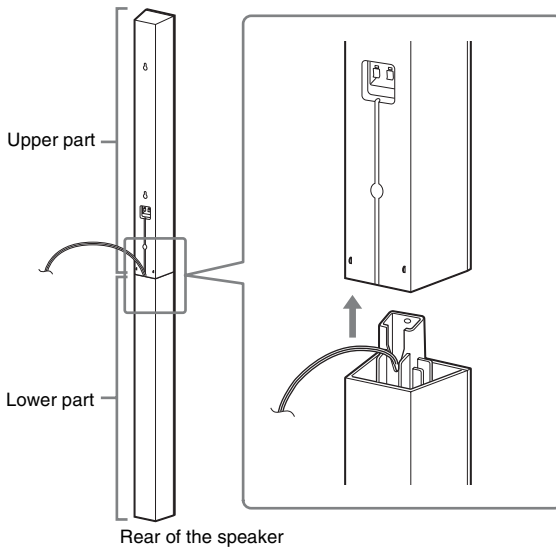

4 Pull out the speaker cord from the bottom of the lower part of the speaker.

The removed speaker cord is used when installing the speaker on a wall.

Lower part of the speaker

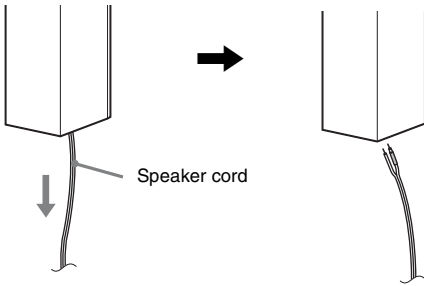

5 Remove the protection paper from the speaker-bottom cover, then attach the speaker-bottom cover to the bottom of the upper part of the speaker.

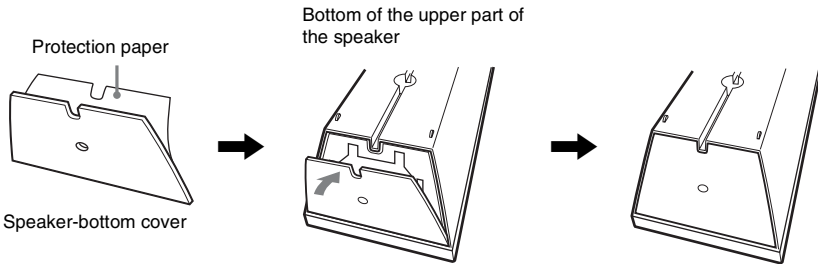

Note

- When removing the protection paper, pull it off via the section exposed by the notch in the speaker-bottom cover.

Fully-disassembled illustration

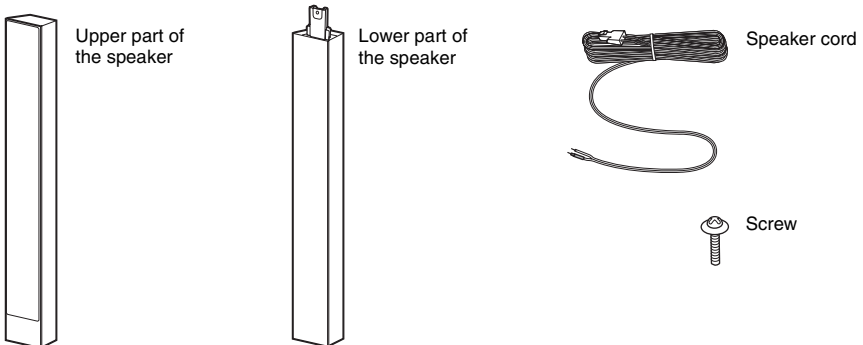

To install the speakers on a wall

Before installing the speakers on a wall, connect the speaker cord to the speaker.

Be sure to match the speaker cords to the appropriate terminals on the speakers: the speaker cord with the color tube to \oplus , and the speaker cord without the color tube to \ominus .



Color tube
 Front left speaker (L): White
 Front right speaker (R): Red
 Center speaker: Green
 Surround left speaker (L): Blue
 Surround right speaker (R): Gray

- 1 Prepare screws (not supplied) that are suitable for the hole on the back of each speaker. See the illustrations below.**

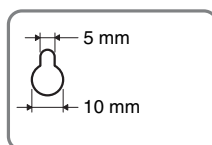
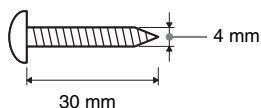

Hole on the back of the speaker

2 Fasten the screws to the wall.

BDV-E870

For the front speakers

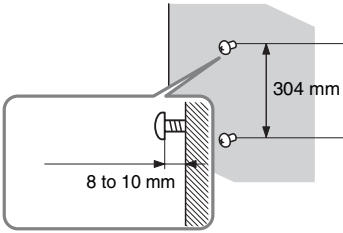

For the center speaker

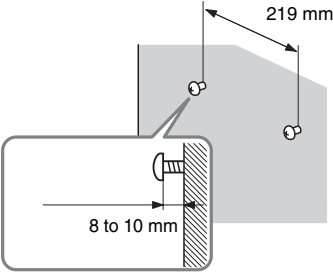

For the surround speakers

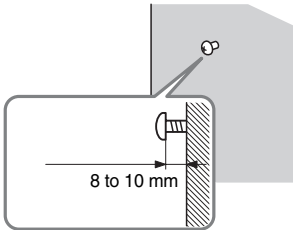

BDV-E370

For the center speaker

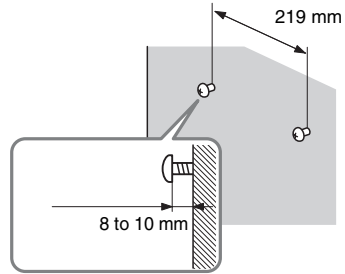

For the other speakers

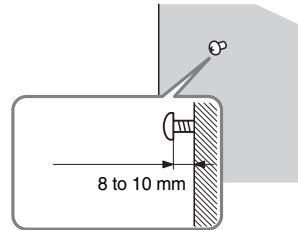

3 Hang the speakers on the screws.

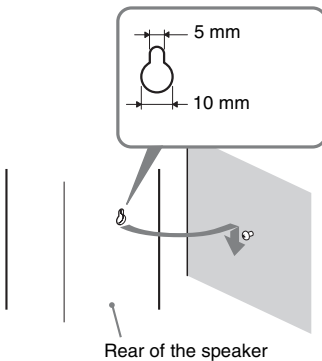

Hole on the back of the speaker

Rear of the speaker

Step 2: Connecting the System

For connecting the system, read the information on the following pages.

Do not connect the AC power cord (mains lead) of the unit to a wall outlet (mains) until all the other connections are made.

Note

- When you connect another component with a volume control, turn down the volume of the other components to a level where sound is not distorted.

Connecting the speakers

The connector of the speaker cords and the color tube are color-coded depending on the type of speaker. Connect the speaker cords to match the color of the **SPEAKERS** jacks of the unit.

Be sure to match the speaker cords to the appropriate terminals on the speakers: the speaker cord with the color tube to \oplus , and the speaker cord without the color tube to \ominus . Do not catch the speaker cord insulation (rubber covering) in the speaker terminals.

To connect speaker cords to the unit

When connecting to the unit, insert the connector until it clicks.

Rear panel of the unit

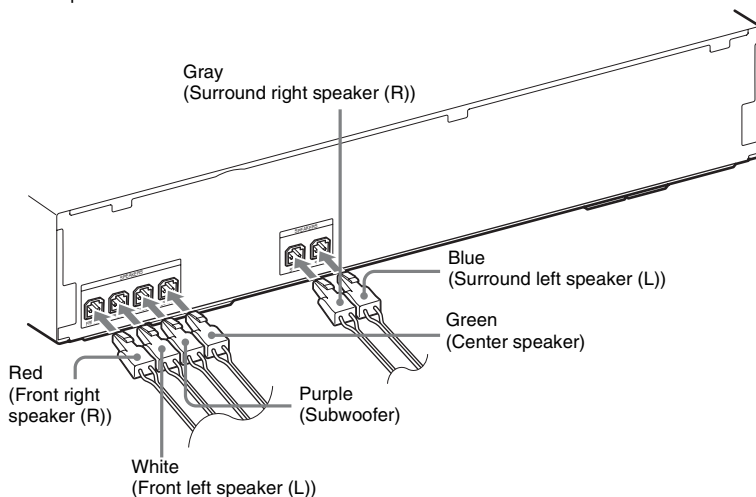

To connect speaker cords to the speaker

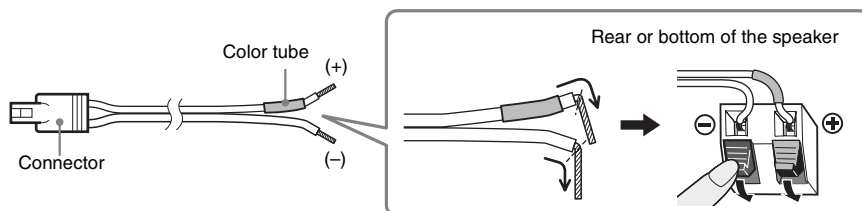

Connecting the TV (Video connection)

This connection sends a video signal to the TV.
Depending on the jacks on your TV, select the connection method.

Rear panel of the unit

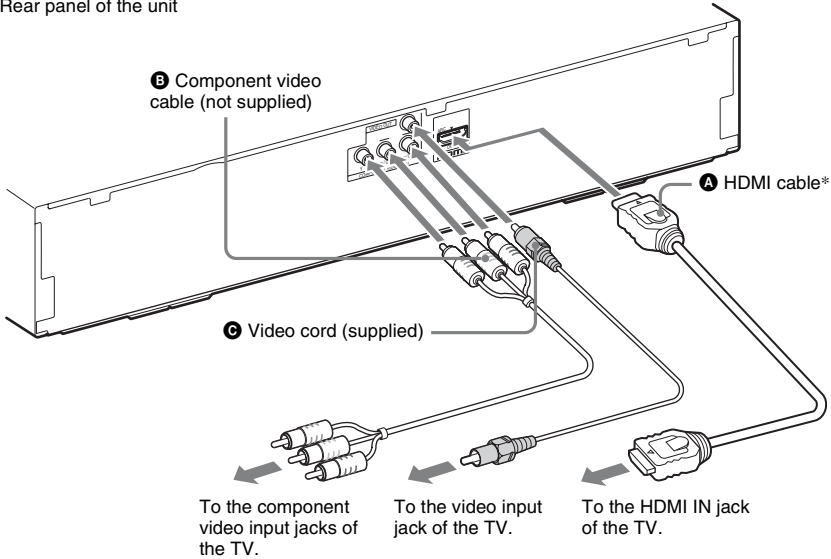

* The HDMI cable is supplied with Singapore, Thai, and Taiwan models only.

Method 1: HDMI cable (A) connection

If your TV has an HDMI jack, connect to the TV with an HDMI cable. Picture quality will be improved compared to using the component video cable connection or the video cord connection. When connecting with the HDMI cable, you need to select the type of output signal (page 51).

Method 2: Component video cable (B) connection

If your TV does not have an HDMI jack, but has component video input jacks, connect to the TV with a component video cable. Picture quality will be improved compared to using the video cord connection.

When connecting with the component video cable, you need to select the type of output signal (page 51).

Method 3: Video cord (C) connection

If you do not have an HDMI cable or a component video cable, temporarily make this connection.

Connecting the TV (Audio connection)

This connection sends an audio signal to the unit from the TV. To listen to TV sound via the system, perform this connection.

Rear panel of the unit

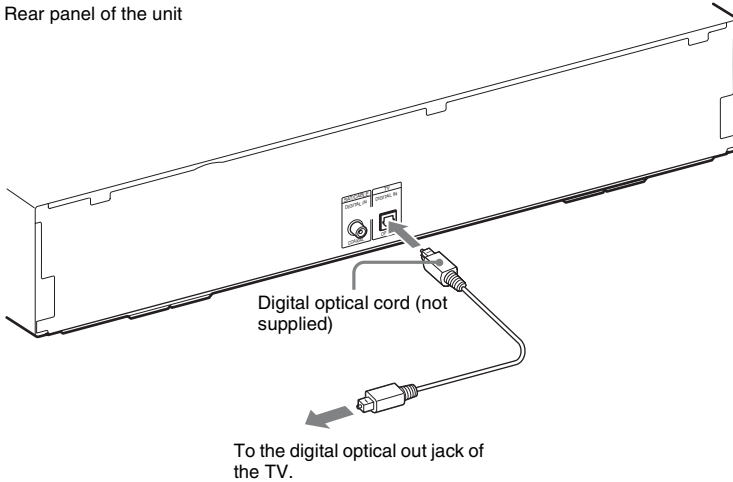

With a digital audio connection, the system receives a Dolby Digital multiplex broadcast signal and you can enjoy multiplex broadcast sound.

Note

- When you connect the TV and the unit with an audio cord, see “Connecting the other components” (page 22).

About Audio Return Channel

If your TV is compatible with the Audio Return Channel function, an HDMI cable connection also sends a digital audio signal from the TV. You do not need to make a separate audio connection for listening to TV sound. For details of the Audio Return Channel function, see [Audio Return Channel] (page 54).

Connecting the other components

When you connect the system and other components to the TV, video signals from the system and the components are sent to the TV, and audio signals from the components are sent to the system as follows.

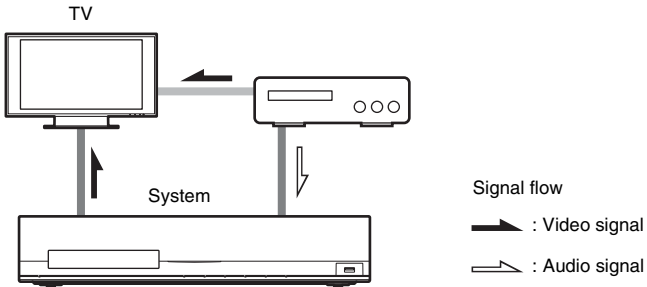

You can enjoy connected components via the system's speakers.

- VCR or digital satellite receiver, etc. (not supplied), which has a digital coaxial output jack: **D**
- VCR, digital satellite receiver, PlayStation, or portable audio source, etc. (not supplied): **E**

Rear panel of the unit

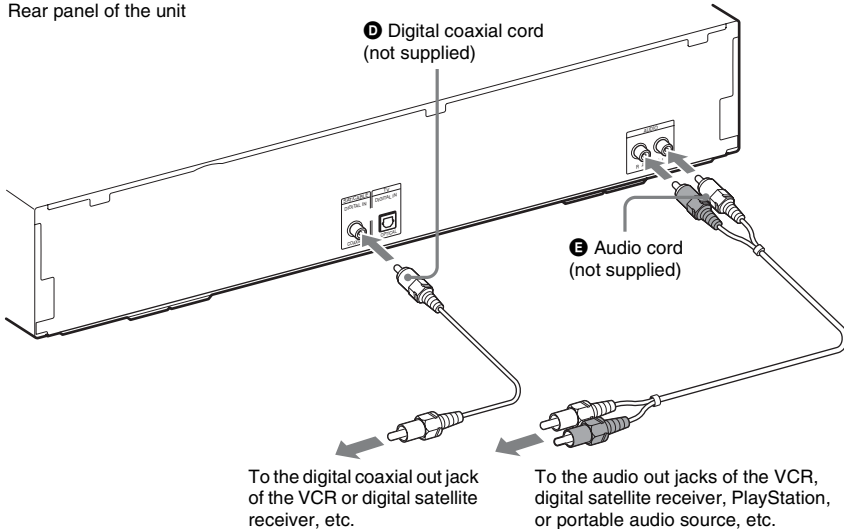

Connecting the antenna (aerial)

To connect the antenna (aerial)

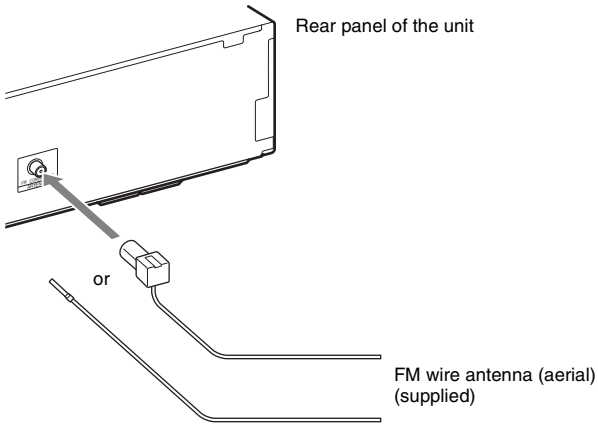

Note

- Be sure to fully extend the FM wire antenna (aerial).
- After connecting the FM wire antenna (aerial), keep it as horizontal as possible.

Tip

- If you have poor FM reception, use a 75-ohm coaxial cable (not supplied) to connect the unit to an outdoor FM antenna (aerial) as shown below.

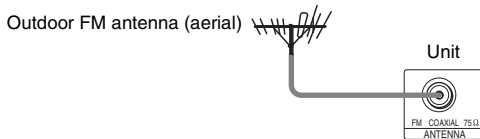

Connecting to the network

Wired Setup

Use a LAN cable to connect to the LAN (100) terminal on the unit.

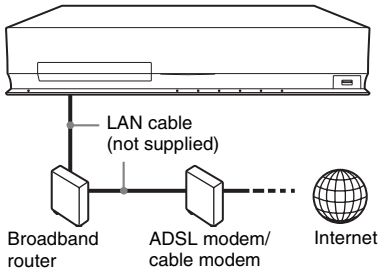

USB Wireless Setup

Use a wireless LAN via the USB Wireless LAN Adapter (Sony UWA-BR100* only) (not supplied).

The USB Wireless LAN Adapter may not be available in some regions/countries.

* As of January 2010.

Turn the unit off before connecting the extension cable or inserting the USB Wireless LAN Adapter. After inserting the USB Wireless LAN Adapter to the base of the extension cable and connecting the extension cable to the  (USB) port (front or rear), turn the unit on again.

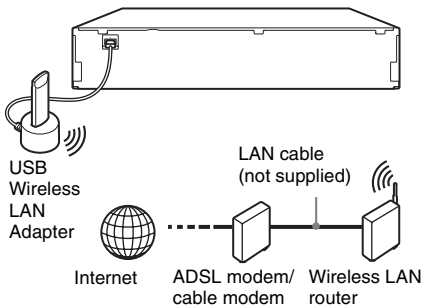

Note

- The placement distance between the USB Wireless LAN Adapter and your wireless LAN router differs depending on the usage environment. If the system cannot connect to the network or the network connection is unstable, move the USB Wireless LAN Adapter to a different position or place the USB

Wireless LAN Adapter and the wireless LAN router closer to each other.

To set the network settings

For details, see [Network Settings] (page 55) and follow the on-screen instructions to complete the setup.

About wireless LAN security

Since communication via the wireless LAN function is established by radio waves, the wireless signal may be susceptible to interception. To protect wireless communication, this system supports various security functions. Be sure to correctly configure the security settings in accordance with your network environment.

No Security

Although you can easily make settings, anyone can intercept wireless communication or intrude into your wireless network, even without any sophisticated tools. Keep in mind that there is a risk of unauthorized access or interception of data.

WEP

WEP applies security to communications to prevent outsiders from intercepting communications or intruding into your wireless network. WEP is a legacy security technology that enables older devices, which do not support TKIP/AES, to be connected.

WPA-PSK (TKIP), WPA2-PSK (TKIP)

TKIP is a security technology developed to correct for the deficiencies of WEP. TKIP assures a higher security level than WEP.

WPA-PSK (AES), WPA2-PSK (AES)

AES is a security technology that uses an advanced security method that is distinct from WEP and TKIP. AES assures a higher security level than WEP or TKIP.

Step 3: Performing the Easy Setup

Before performing Step 3

Make sure all connections are secure, and then connect the AC power cord (mains lead).

Follow the Steps below to make the basic adjustments for using the system.

Displayed items vary depending on the country model.

Note

- To use the optional surround back speakers, set [Surround Back] in [Speaker Settings] to [Yes] (page 47).

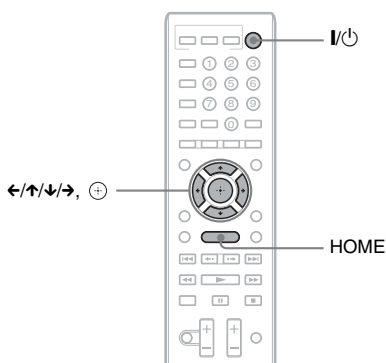

1 Turn on the TV.

2 Connect the calibration mic to the A.CAL MIC jack on the rear panel.

Set up the calibration mic at ear level using a tripod, etc. (not supplied). The front of each speaker should face the calibration mic, and there should be no obstruction between the speakers and the calibration mic.

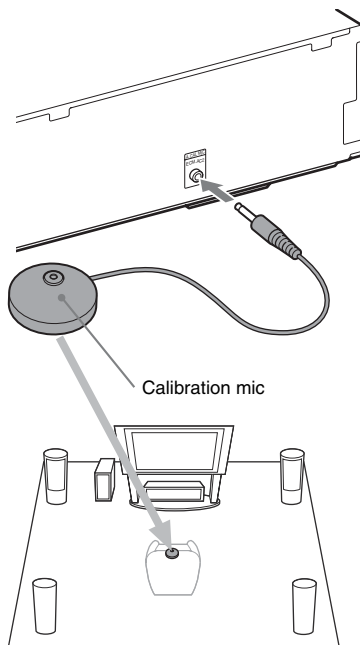

3 Press I/⏻ on the unit.

4 Switch the input selector on your TV so that the signal from the system appears on the TV screen.

The Easy Setup Display for OSD language selection appears.

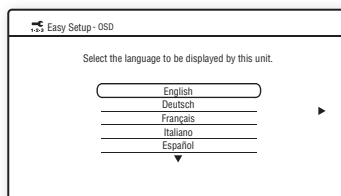

- 5** Perform the [Easy Setup]. Follow the on-screen instructions to make the basic settings using $\leftarrow/\uparrow/\downarrow/\rightarrow$, and \oplus .

For details about [Auto Calibration] settings in [Easy Setup], see “Calibrating the Appropriate Settings Automatically” (page 46).

To recall the Easy Setup Display

- 1** Press HOME.
The home menu appears on the TV screen.
- 2** Press \leftarrow/\rightarrow to select  [Setup].
- 3** Press \uparrow/\downarrow to select [Easy Setup], then press \oplus .
- 4** Press \leftarrow/\rightarrow to select [Start], then press \oplus .
The Easy Setup Display appears.

Step 4: Selecting the Source

You can select the playback source.

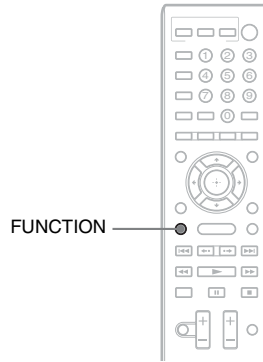

Press FUNCTION repeatedly until the desired function appears in the front panel display.

Each time you press FUNCTION, the function changes as follows.

“BD/DVD” → “D. MEDIA” → “TUNER FM”
→ “TV” → “SAT/CABLE” → “AUDIO” →
“BD/DVD” → ...

Function	Source
“BD/DVD”	Disc that is played by the system
“D. MEDIA”	USB device, iPod, or BRAVIA Internet Video
“TUNER FM”	FM radio (page 37)
“TV”	Component (TV, etc.) that is connected to the TV (DIGITAL IN OPTICAL) jack on the rear panel, or a TV compatible with the Audio Return Channel function that is connected to the HDMI OUT jack on the rear panel (page 21).
“SAT/CABLE”	Component that is connected to the SAT/CABLE (DIGITAL IN COAXIAL) jack on the rear panel (page 22)
“AUDIO”	Component that is connected to the AUDIO (AUDIO IN L/R) jacks on the rear panel (page 22)

Step 5: Enjoying Surround Sound

After performing the previous Steps and starting playback, you can easily enjoy surround sound. You can also select pre-programmed surround settings that are tailored to different kinds of sound sources. They bring the exciting and powerful sound of movie theaters into your home.

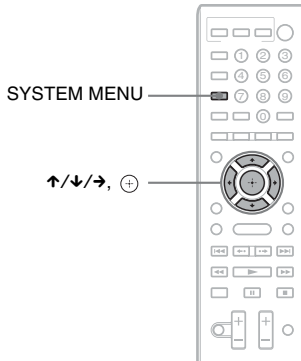

Selecting surround settings based on your listening preference

- 1** Press **SYSTEM MENU**.
- 2** Press **↑/↓** repeatedly until “**SUR.SETTING**” appears in the front panel display, then press **⊕** or **→**.
- 3** Press **↑/↓** repeatedly until the surround setting you want appears in the front panel display.
See the table below for surround sound setting descriptions.
- 4** Press **⊕**.
The setting is made.
- 5** Press **SYSTEM MENU**.
The system menu turns off.

About speaker output of each surround setting

The table below describes the options when you connect all the speakers to the unit. The default setting is “A.F.D. MULTI.”

Sound from	Surround setting	Effect
Depending on the source.	“A.F.D. STD” (AUTO FORMAT DIRECT STANDARD)	The system discriminates the sound format of the source and presents sound as it was recorded/encoded.

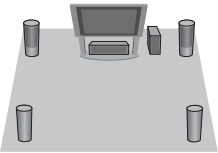
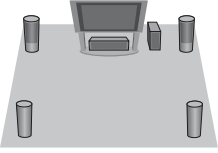
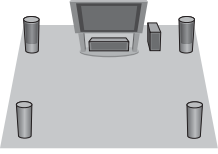
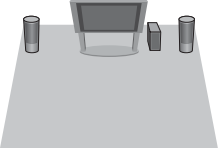
Sound from	Surround setting	Effect
	"A.F.D. MULTI" (AUTO FORMAT DIRECT MULTI)	<ul style="list-style-type: none"> • 2 channel source: The system simulates surround sound from 2 channel sources and outputs sound from the 5.1 channel speakers by duplicating 2 channel source sound across each speaker. • Multi-channel source: The system outputs sound from the speakers depending on the number of channels of the source.
	"PRO LOGIC" "PLII MOVIE"	<ul style="list-style-type: none"> • 2 channel source: The system simulates surround sound from 2 channel sources and outputs sound from the 5.1 channel speakers. <ul style="list-style-type: none"> – "PRO LOGIC" performs Dolby Pro Logic decoding. – "PLII MOVIE" performs Dolby Pro Logic II movie mode decoding. • Multi-channel source: The system outputs sound from the speakers depending on the number of channels of the source.
	"NEO6 CIN" "NEO6 MUS"	<ul style="list-style-type: none"> • 2 channel source: The system simulates surround sound from 2 channel sources and produces 6.1 channel sound. <ul style="list-style-type: none"> – "NEO6 CIN" performs DTS Neo:6 Cinema mode decoding. – "NEO6 MUS" performs DTS Neo:6 Music mode decoding. • Multi-channel source: The system outputs sound from the speakers depending on the number of channels of the source.
	"2CH STEREO"	The system outputs the sound from the front speakers and subwoofer regardless of sound format or number of channels. Multi-channel surround formats are downmixed to 2 channels.

Note

- When you select "A.F.D. MULTI," depending on the disc or source, the beginning of the sound may be cut off while the optimum mode is automatically selected. To avoid cutting the sound, select "A.F.D. STD."
- When bilingual broadcast sound is input, "PRO LOGIC" and "PLII MOVIE" are not effective.
- Depending on the input stream, the surround settings may not be effective.
- When changing the surround setting while using the S-AIR receiver, sound from the S-AIR receiver may skip.
- When you play a Super Audio CD, surround settings are not activated.

Tip

- The system memorizes the last surround setting selected for each function. Whenever you select a function such as "BD/DVD" or "TUNER FM," the surround setting that was last applied to the function is automatically applied again. For example, if you select "BD/DVD" with "PRO LOGIC" as the surround setting, then change to another function, and then return to "BD/DVD," "PRO LOGIC" will be applied again.

Playing a Disc

For playable discs, see “Playable Discs” (page 65).

- 1 **Switch the input selector on your TV so that the signal from the system appears on your TV screen.**
- 2 **Press \blacktriangle , and place a disc on the disc tray.**

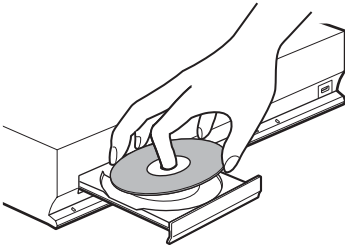

- 3 **Press \blacktriangle to close the disc tray.**
 - appears on the home menu and playback starts.

If playback does not start automatically, select ● in the [Video], [Music], or [Photo] category, and press +.

Enjoying BONUSVIEW/BD-LIVE

Some BD-ROMs with “BD-LIVE Logo*” have bonus content and other data that can be downloaded for enjoyment.

* BD-LIVE™

- 1 **Prepare for BONUSVIEW/BD-LIVE.**
 - Connect the unit to a network (page 24).
 - Set [BD Internet Connection] to [Allow] (page 52).
- 2 **Insert a BD-ROM with BONUSVIEW/BD-LIVE.**

The operation method differs depending on the disc. Refer to the operating instructions of the disc.

Tip

- Delete unnecessary data in internal memory or USB memory. Select [Erase BD Data] in [Video] to delete unnecessary data. If you use USB memory as local storage, all saved data in the [BUDA/BUDB] folder is deleted.

Displaying the play information

You can check the playback information, etc., by pressing DISPLAY. The displayed information differs depending on the disc type and player status.

Example: when playing a BD-ROM

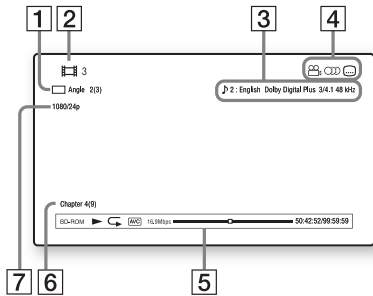

- 1 The currently selected angle
- 2 Title number or name
- 3 The currently selected audio setting
- 4 Available functions (angle, audio, subtitle)
- 5 Playback information
Displays disc type, play mode, repeat type, video codec, bit rate, playing status bar, playing time, total time
- 6 Chapter number
- 7 Output resolution/Video frequency

Playing from a USB Device





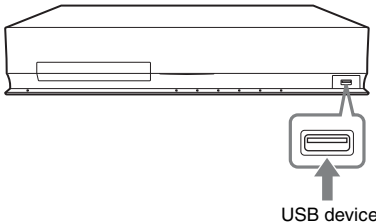
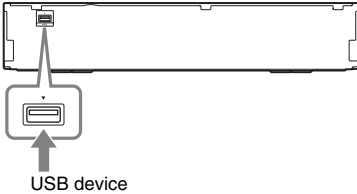

You can play video/music/photo files on the connected USB device.

For playable types of files, see “Playable Types of Files” (page 66).

1 Connect the USB device to the (USB) port on the unit.

Refer to the operating instructions of the USB device before connecting.



- 2 Press  to select  [Video],  [Music], or  [Photo].
- 3 Press  to select  [USB device (front)] or [USB device (rear)], then press .

Note

- Do not remove the USB device during operation. To avoid data corruption or damage to the USB device, turn the system off when connecting or removing the USB device.

Enjoying an iPod

You can enjoy the sound and charge the battery of an iPod via the system.

Compatible iPod models

The compatible iPod models are as follows. Update your iPod with the latest software before using with the system.



iPod nano
5th generation (video camera)



iPod touch
2nd generation



iPod classic



iPod nano
4th generation (video)









iPod touch
1st generation



iPod nano
3rd generation
(video)



iPod nano
2nd generation
(aluminum)

- 1 Connect the iPod to the front  (USB) port on the unit with the iPod's USB cable.
- 2 Press  to select  [Music].
- 3 Press  to select  [iPod (front)], then press .

The sound from the iPod is played on the system.

You can operate the iPod using the buttons on the remote.

For operation details, refer to the operating instructions of the iPod.

To operate the iPod using the remote

You can operate the iPod using the buttons on the remote. The following table shows an example of buttons that can be used.

Press	Operation
▶,	Same operation as the ▶/ button of the iPod.
■	Pause.
◀◀ or ▶▶	Fast reverse or forward.
◀◀◀ or ▶▶▶	Same operation as the ◀◀◀ or ▶▶▶ buttons of the iPod.
DISPLAY, RETURN, ←	Same operation as the MENU button of the iPod.
↑/↓	Same operation as the Click Wheel of the iPod.
⊕, →	Same operation as the Center button of the iPod.

Note

- The iPod is charged when connected to the system while the system is turned on.
- You cannot transfer songs onto the iPod.
- Sony cannot accept responsibility in the event that data recorded to iPod is lost or damaged when using an iPod connected to this unit.
- This product has been designed specifically to work with iPod and has been certified to meet Apple performance standards.
- Do not remove the iPod during operation. To avoid data corruption or damage to the iPod, turn the system off when connecting or removing the iPod.

Playing via a Network

Streaming BRAVIA Internet Video

BRAVIA Internet Video serves as a gateway delivering the selected Internet content and a variety of on-demand entertainment straight to your unit.

- 1 Prepare for BRAVIA Internet Video.**
Connect the unit to a network (page 24).
- 2 Press ←/→ to select [Video], [Music], or [Photo].**
- 3 Press ↑/↓ to select an Internet content provider icon, then press ⊕.**
When the Internet content list has not been retrieved, it will be represented by an unacquired icon or a new icon.

To use the control panel

The control panel appears when the video file starts playing. The displayed items may differ depending on Internet content providers.

To display again, press DISPLAY.

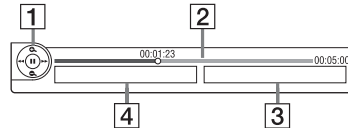

- 1** Control display
Press ←/↑/↓/→ or ⊕ for playback operations.
- 2** Playing status bar
Status bar, cursor indicating the current position, playing time, duration of the video file
- 3** The next video file name
- 4** The currently selected video file name and rating

Available Options

Various settings and playback operations are available by pressing **OPTIONS**. The available items differ depending on the situation.

Common options

Items	Details
[Playback History]	Displays titles/tracks in the playback history of a BD-ROM/DVD-ROM/CD-DA (music CD) using Gracenote technology.
[Search History]	Searches for related information based on keywords from Gracenote via the Information Display (Russian, Thai, and Taiwan models only).
[Search Contents]	Searches for BRAVIA Internet Video content based on keywords from Gracenote via the Information Display (Russian, Thai, and Taiwan models only).
[Repeat Setting]	Sets the repeat play.
[Favourites List]	Displays the Favorites List.
[Play/Stop]	Starts or stops playback.
[Play from start]	Plays the item from the beginning.
[Information Display]	Displays information on the BD-ROM/DVD-ROM/CD-DA (music CD) by using Gracenote technology.
[Add to Favourites]	Adds an Internet content to the Favorites List.
[Remove from Favourites]	Erases an Internet content from the Favorites List.

[Video] only

Items	Details
[Video Settings]	<ul style="list-style-type: none">• [Picture Quality Mode]: Selects the picture settings for different lighting environments.• [FNR]: Reduces the random noise appearing in the picture.• [BNR]: Reduces the mosaic-like block noise in the picture.• [MNR]: Reduces minor noise around the picture outlines (mosquito noise).
[Play/Pause]	Starts or pauses playback.
[Top Menu]	Displays the BD's or DVD's Top Menu.
[Menu/Popup Menu]	Displays the BD-ROM's Pop-up Menu or DVD's menu.
[Title Search]	Searches for a title on BD-ROMs/DVD VIDEOS and starts playback from the beginning.
[Chapter Search]	Searches for a chapter and starts playback from the beginning.
[Angle]	Switches to other viewing angles when multi-angles are recorded on BD-ROMs/DVD VIDEOS.

[Music] only

Items	Details
[Add Slideshow BGM]	Registers music files in the USB memory as slideshow background music (Russian, Thai, and Taiwan models only).

📷 [Photo] only

Items	Details
[Slideshow]	Starts a slideshow.
[Slideshow Speed]	Changes the slideshow speed.
[Slideshow Effect]	Sets the effect when playing a slideshow (Russian, Thai, and Taiwan models only).
[Slideshow BGM]	Sets the background music for slideshows. Only CD-DAs (music CDs) or registered slideshow background music can be set (Russian, Thai, and Taiwan models only).
[Rotate Left]	Rotates the photo counterclockwise by 90 degrees.
[Rotate Right]	Rotates the photo clockwise by 90 degrees.
[View Image]	Displays the selected picture.

Adjusting the delay between the picture and sound

(A/V SYNC)

When the sound does not match the pictures on the TV screen, you can adjust the delay between the picture and sound.

- 1** Press **SYSTEM MENU**.
- 2** Press **↑/↓** repeatedly until **“A/V SYNC”** appears in the front panel display, then press **⊕** or **→**.
- 3** Press **↑/↓** to adjust the delay between the picture and sound.
You can adjust from 0 ms to 300 ms in 25 ms increments.
- 4** Press **⊕**.
The setting is made.
- 5** Press **SYSTEM MENU**.
The system menu turns off.

Note

- Depending on the input stream, A/V SYNC may not be effective.

Selecting the Effect to Suit the Source

You can select a suitable sound mode for movies or music.

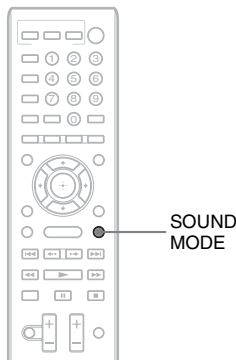

Press SOUND MODE repeatedly during playback until the desired mode appears in the front panel display.

- **“AUTO”**: The system selects “MOVIE” or “MUSIC” automatically to produce the sound effect depending on the disc or sound stream.
- **“MOVIE”**: The system provides the sound for movies.
- **“MUSIC”**: The system provides the sound for music.
- **“SPORTS”**: The system adds reverberation for sports programs.
- **“NEWS”**: The system provides the sound for voice programs, such as news.
- **“GAME ROCK”**: The system provides the sound for music/rhythm games.

Note

- Depending on the disc or source, when you select “AUTO,” the beginning of the sound may be cut off as the system selects the optimum mode automatically. To avoid cutting the sound, select other than “AUTO.”
- Depending on the input stream, the sound mode may not be effective.

- When changing the sound mode while using the S-AIR receiver, sound from the S-AIR receiver may skip.
- When you play a Super Audio CD, this function does not work.

Selecting the Audio Format, Multilingual Tracks, or Channel

When the system is playing a BD/DVD VIDEO or DATA CD/DATA DVD (DivX video files) recorded in multiple audio formats (PCM, Dolby Digital, MPEG audio, or DTS) or multilingual tracks, you can change the audio format or language.

With a CD, you can select the sound from the right or left channel and listen to the sound of the selected channel through both the right and left speakers.

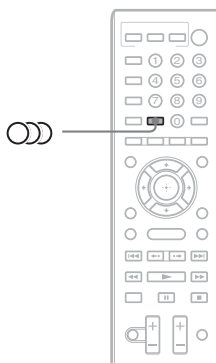

Press  repeatedly during playback to select the desired audio signal.

The audio information appears on the TV screen.

■ BD/DVD VIDEO

Depending on the BD/DVD VIDEO, the choice of language varies.

When 4 digits are displayed, they indicate a language code. See “Language Code List” (page 70) to confirm which language the code represents. When the same language is

displayed two or more times, the BD/DVD VIDEO is recorded in multiple audio formats.

■ DVD-VR

The types of sound tracks recorded on a disc are displayed.

Example:

- [♪ Stereo]
- [♪ Stereo (Audio1)]
- [♪ Stereo (Audio2)]
- [♪ Main]
- [♪ Sub]
- [♪ Main/Sub]

Note

- [♪ Stereo (Audio1)] and [♪ Stereo (Audio2)] do not appear when only one audio stream is recorded on the disc.

■ DATA CD (DivX video file)/DATA DVD (DivX video file)

The choice of DATA CD or DATA DVD audio signal formats differs, depending on the DivX video file contained on the disc. The format appears on the TV screen.

■ CD

- [♪ Stereo]: The standard stereo sound.
- [♪ 1/L]: The sound of the left channel (monaural).
- [♪ 2/R]: The sound of the right channel (monaural).

Enjoying Multiplex Broadcast Sound

(DUAL MONO)

You can enjoy multiplex broadcast sound when the system receives or plays a Dolby Digital multiplex broadcast signal.

Note

- To receive the Dolby Digital signal, you need to connect a TV or other component to the unit with a digital coaxial or optical cord (pages 21, 22). If your TV is compatible with the Audio Return Channel function (page 45), you can receive a Dolby Digital signal via an HDMI cable.

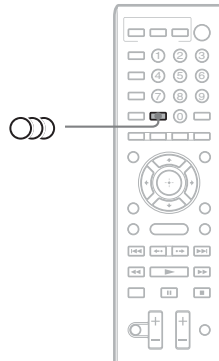

Press  repeatedly until the desired signal appears in the front panel display.

- “MAIN”: Sound of the main language will be output.
- “SUB”: Sound of the sub language will be output.
- “MAIN/SUB”: Mixed sound of both the main and sub languages will be output.

Using the Sound Effect

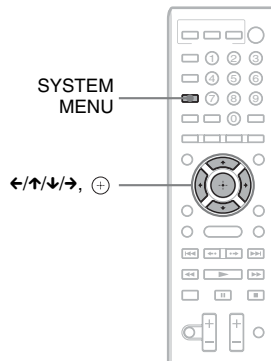

Enjoying sound at low volume

You can enjoy sound effects or dialog, as you would in a movie theater, even at low volume. It is useful for watching movies at night.

- 1 Press **SYSTEM MENU**.

2 Press \uparrow/\downarrow repeatedly until “NIGHT MODE” appears in the front panel display, then press \oplus or \rightarrow .

3 Press \uparrow/\downarrow to select a setting.

- “NIGHT ON”: On.
- “NIGHT OFF”: Off.

4 Press SYSTEM MENU.

The system menu turns off.

Note

- When sound is output from the center speaker, this effect is more pronounced, as speech (movie dialog, etc.) is easy to hear. When sound is not output from the center speaker, the system optimally adjusts the volume.

Reinforcing bass frequencies

You can reinforce bass frequencies.

1 Press SYSTEM MENU.

2 Press \uparrow/\downarrow repeatedly until “D.BASS” appears in the front panel display, then press \oplus or \rightarrow .

3 Press \uparrow/\downarrow to select a setting.

- “D.BASS ON”: On.
- “D.BASS OFF”: Off.

4 Press SYSTEM MENU.

The system menu turns off.

Listening to the Radio

You can enjoy radio sound with the system's speakers.

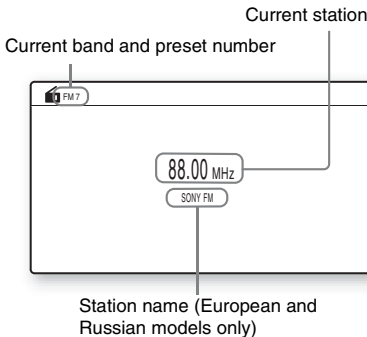
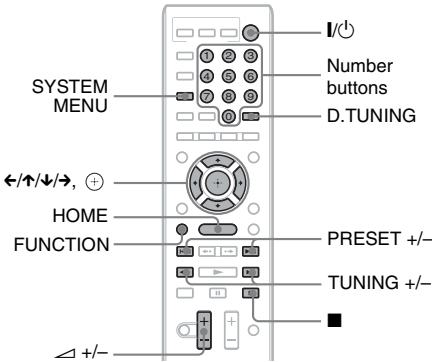

- 1 Press **FUNCTION** repeatedly until "TUNER FM" appears in the front panel display.

- 2 Select the radio station.

Automatic tuning

Press and hold **TUNING +/-** until the auto scanning starts.

[Auto Tuning] appears on the TV screen. Scanning stops when the system tunes in a station.

To stop the automatic tuning manually, press **TUNING +/-** or ■.

Manual tuning

Press **TUNING +/-** repeatedly.

- 3 Adjust the volume by pressing **⏻** +/-.

If an FM program is noisy

If an FM program is noisy, you can select monaural reception. There will be no stereo effect, but reception will improve.

- 1 Press **SYSTEM MENU**.
- 2 Press **↑/↓** repeatedly until "FM MODE" appears in the front panel display.



- 3 Press **⊕** or **→**.
- 4 Press **↑/↓** to select "MONO."
 - "STEREO": Stereo reception.
 - "MONO": Monaural reception.

- 5 Press **SYSTEM MENU**.

The system menu turns off.

To turn off the radio

Press **I/⏻**.

Presetting radio stations

You can preset up to 20 stations. Before tuning, make sure to turn down the volume to minimum.

- 1 Press **FUNCTION** repeatedly until "TUNER FM" appears in the front panel display.
- 2 Press and hold **TUNING +/-** until the auto scanning starts. Scanning stops when the system tunes in a station.
- 3 Press **SYSTEM MENU**.
- 4 Press **↑/↓** repeatedly until "MEMORY" appears in the front panel display, then press **⊕** or **→**.

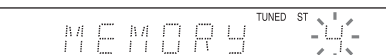
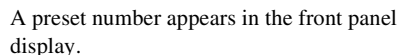

- 1 Press **↑/↓** to select the preset number you want.



Tip

- You can select the preset number directly by pressing the number buttons.

- 2 Press **+**.

“COMPLETE” appears in the front panel display, and the station is stored.

- 3 Repeat Steps 2 to 6 to store other stations.

- 4 Press **SYSTEM MENU**.

The system menu turns off.

To change the preset number

Select the desired preset number by pressing PRESET +/-, then perform the procedure from Step 3.

Selecting the preset station

- 1 Press **FUNCTION** repeatedly until “TUNER FM” appears in the front panel display.

The last received station is tuned in.

- 2 Press **PRESET +/-** repeatedly to select the preset station.

The preset number and frequency appear on the TV screen and front panel display.

Each time you press the button, the system tunes in one preset station.

Tip

- You can select the preset station number directly by pressing the number buttons.

Selecting a radio station by inputting a frequency directly

When you know the frequencies, you can select radio stations by inputting the frequencies directly.

- 1 Press **FUNCTION** repeatedly until “TUNER FM” appears in the front panel display.

- 2 Press **D.TUNING**.

- 3 Press the number buttons to select the frequencies.

- 4 Press **+**.

Using the Radio Data System (RDS)

(European and Russian models only)

What is the Radio Data System?

The Radio Data System (RDS) is a broadcasting service that allows radio stations to send additional information along with the regular program signal. This tuner offers convenient RDS features, such as station name display. The station name appears on the TV screen as well.

Receiving RDS broadcasts

Simply select a station from the FM band.

When you tune in a station that provides RDS services, the station name* appears in the front panel display.

* If an RDS broadcast is not received, the station name may not appear in the front panel display.

Note

- RDS may not work properly if the station you are tuned to is not transmitting the RDS signal properly, or if the signal strength is weak.
- Not all FM stations provide RDS service, nor do they provide the same type of services. If you are not familiar with the RDS system, check with your local radio stations for details on RDS services in your area.

Tip

- While receiving an RDS broadcast and pressing DISPLAY, you can change between the station name and frequency in the front panel display.

Using an S-AIR Product

When you purchase the S-AIR product, you need to perform the following settings to activate wireless transmission.

About S-AIR products

There are two types of S-AIR product.

- S-AIR main unit (this unit): This is for transmitting sound. You can use up to three S-AIR main units. (The number of usable S-AIR main units depends on the use environment.)
- S-AIR sub unit: This is for receiving sound.
 - **Surround amplifier (optional):** You can enjoy surround speaker sound wirelessly.
 - **S-AIR receiver (optional):** You can enjoy system sound in another room.

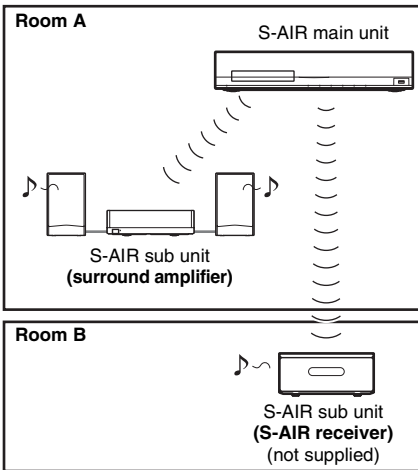

Inserting the wireless transmitter/ transceiver

To make use of the S-AIR function, you need to insert the wireless transmitter into the unit and the wireless transceiver into the S-AIR sub unit.

Note

- When you insert the wireless transmitter/transceiver, make sure that the AC power cord (mains lead) is not connected to a wall outlet (mains).
- Do not touch the terminals of the wireless transmitter/transceiver.

To insert the wireless transmitter into the unit

- 1 Remove the screws directly below the mark.

Rear of the unit

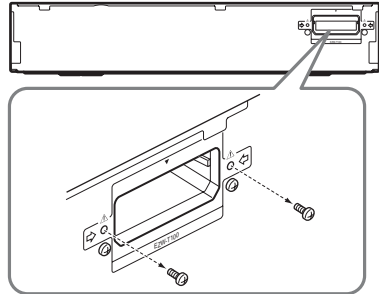

Note

- Remove the screws that are indicated in the illustration. Do not remove other screws.

- 2 Insert the wireless transmitter.

Rear of the unit

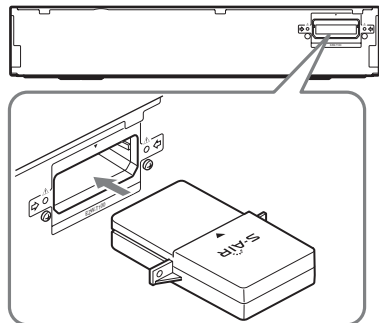

Note

- Insert the wireless transmitter with the S-AIR logo facing up.
- Insert the wireless transmitter so that the marks are aligned.
- Do not insert anything other than the wireless transmitter into the EZW-T100 slot.

- 3 **Make sure to use the same screws to secure the wireless transmitter.**

Rear of the unit

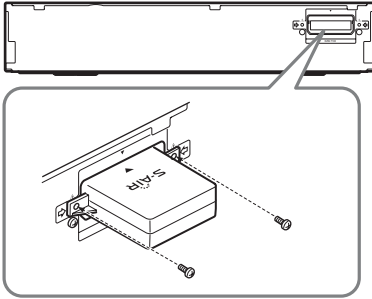

Note

- Do not use other screws to fasten the wireless transmitter.

To insert the wireless transceiver into the S-AIR sub unit

For details on installing the wireless transceiver into the S-AIR sub unit, such as a surround amplifier or S-AIR receiver, see the operating instructions of the S-AIR sub unit.

Tip

- When you change the S-AIR configuration, Sony recommends that you perform [Auto Calibration]. For details, see “Calibrating the Appropriate Settings Automatically” (page 46).

Setting the S-AIR ID to activate wireless transmission

For the surround amplifier
For the S-AIR receiver

Simply by matching the ID of the unit and the S-AIR sub unit, you can activate wireless transmission.

To set the ID of the unit

- 1 **Press I/⏻ on the unit.**
The system turns on.
- 2 **Press HOME.**
The home menu appears on the TV screen.

- 3 **Press ←/→ to select  [Setup].**
- 4 **Press ↑/↓ to select [System Settings], then press ⊕.**
- 5 **Press ↑/↓ to select [S-AIR Settings], then press ⊕.**
The [S-AIR Settings] display appears.
- 6 **Press ↑/↓ to select [ID], then press ⊕.**
- 7 **Press ↑/↓ to select the desired ID.**
You can select any ID (A, B, or C).
- 8 **Press ⊕.**
The setting is made.
- 9 **Set the S-AIR sub unit to the same ID.**
Wireless transmission is activated as follows (example):

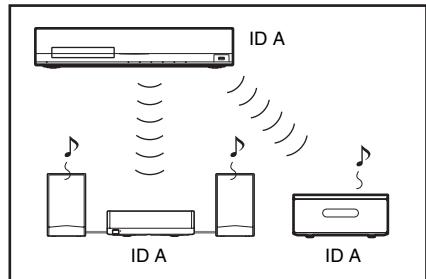

To set the ID of the surround amplifier

Refer to the operating instructions of the surround amplifier.

To set the ID of the S-AIR receiver

Refer to the operating instructions of the S-AIR receiver.

To enjoy a 7.1 channel system

You can enjoy the more realistic surround sound effect of 7.1 channels when you use the Wireless Surround Speaker Kit (WAHT-SBP2, optional). For details, refer to the operating instructions of the Wireless Surround Speaker Kit. In this case, set [Surround Back] in [Speaker Settings] to [Yes] (page 47).

Enjoying the system's sound in another room

For the S-AIR receiver

You can enjoy the system's sound in another room by using the S-AIR receiver.

- 1 Press HOME.**
The home menu appears on the TV screen.
- 2 Press \leftarrow/\rightarrow to select  [Setup].**
- 3 Press \uparrow/\downarrow to select [System Settings], then press \oplus .**
- 4 Press \uparrow/\downarrow to select [S-AIR Settings], then press \oplus .**
The [S-AIR Settings] display appears.
- 5 Press \uparrow/\downarrow to select [Mode], then press \oplus .**
- 6 Press \uparrow/\downarrow to select the desired setting.**
 - [Party]: The S-AIR receiver outputs sound according to functions set on the unit.
 - [Separate]: You can set the desired function for the S-AIR receiver while unit functions do not change.
- 7 Press \oplus .**
The setting is made.
- 8 When you select [Separate] in Step 6, press S-AIR CH on the S-AIR receiver to select the function.**
The S-AIR receiver's function changes as follows.
"MAIN UNIT" \rightarrow "TUNER FM" \rightarrow
"AUDIO" \rightarrow ...

To enjoy the same function as the unit, select "MAIN UNIT."
- 9 Adjust the volume on the S-AIR receiver.**

Enjoying the S-AIR receiver while the unit is in standby mode

For the S-AIR receiver

You can enjoy the S-AIR receiver while the unit is in standby mode by setting [Standby] to [On].

- 1 Press HOME.**
The home menu appears on the TV screen.
- 2 Press \leftarrow/\rightarrow to select  [Setup].**
- 3 Press \uparrow/\downarrow to select [System Settings], then press \oplus .**
- 4 Press \uparrow/\downarrow to select [S-AIR Settings], then press \oplus .**
The [S-AIR Settings] display appears.
- 5 Press \uparrow/\downarrow to select [Standby], then press \oplus .**
- 6 Press \uparrow/\downarrow to select the desired setting.**
 - [On]: You can enjoy the S-AIR receiver while the unit is in standby mode or turned on. The power consumption during standby mode increases.
 - [Off]: You cannot enjoy the S-AIR receiver while the unit is in standby mode.
- 7 Press \oplus .**
The setting is made.

Note

- When you turn the system off while [Standby] is set to [On], "S-AIR" flashes (when wireless transmission between the unit and S-AIR receiver is not activated), or lights up (when wireless transmission between the unit and S-AIR receiver is activated) in the front panel display.

Identifying the unit with a specific S-AIR sub unit (Pairing operation)

For the surround amplifier

For the S-AIR receiver

When using S-AIR products, neighbors may also receive your system's sound if IDs are the same, or you may receive sound from neighbors. To prevent this, you can identify the unit with a specific S-AIR sub unit by performing the pairing operation.

When you perform pairing, wireless transmission is activated between the paired main unit and S-AIR sub unit only.

1 Place the S-AIR sub unit that you want to pair near the unit.

2 Match the IDs of the unit and the S-AIR sub unit.

- To set the ID of the unit, see "To set the ID of the unit" (page 40).
- To set the ID of the surround amplifier, refer to the operating instructions of the surround amplifier.
- To set the ID of the S-AIR receiver, refer to the operating instructions of the S-AIR receiver.

3 Press HOME.

The home menu appears on the TV screen.

4 Press \leftarrow/\rightarrow to select  [Setup].

5 Press \uparrow/\downarrow to select [System Settings], then press \oplus .

6 Press \uparrow/\downarrow to select [S-AIR Settings], then press \oplus .

The [S-AIR Settings] display appears.

7 Press \uparrow/\downarrow to select [Pairing], then press \oplus .

8 Start pairing of the S-AIR sub unit.

■ **For the surround amplifier**

Refer to the operating instructions of the surround amplifier.

■ **For the S-AIR receiver**

Refer to the operating instructions of the S-AIR receiver.

9 Press \leftarrow/\rightarrow to select [Start], then press \oplus .

The unit starts pairing.

The PAIRING indicator of the surround amplifier flashes when pairing starts.

When wireless transmission is activated, the PAIRING indicator of the surround amplifier turns on.

To cancel pairing, select [Cancel].

Note

- Perform pairing within several minutes of Step 9. If you do not, [Pairing failed. Retry?] appears on the TV screen. To continue pairing, select [OK] and press \oplus , then start again from Step 8. To cancel pairing, select [Cancel].

To cancel pairing

Change the ID of the main and sub unit (page 40).

If wireless transmission is unstable

For the surround amplifier

For the S-AIR receiver

If you use multiple wireless systems, such as wireless LAN or Bluetooth, the transmission of S-AIR signals or other wireless signals may be unstable. In this case, the transmission may be improved by changing the following [RF Change] setting.

1 Press HOME.

The home menu appears on the TV screen.

2 Press \leftarrow/\rightarrow to select  [Setup].

3 Press \uparrow/\downarrow to select [System Settings], then press \oplus .

4 Press \uparrow/\downarrow to select [S-AIR Settings], then press \oplus .

The [S-AIR Settings] display appears.

5 Press \uparrow/\downarrow to select [RF Change], then press \oplus .

6 Press \uparrow/\downarrow to select the desired setting, then press \oplus .

- **[Auto]**: Normally select this. The system changes [RF Change] to [On] or [Off] automatically.
- **[On]**: The system transmits sound by searching for the better channel for transmitting.
- **[Off]**: The system transmits sound by fixing the channel for transmitting.

7 Press **+**.

The setting is made.

8 When you set **[RF Change]** to **[Off]**, select the ID so that wireless transmission is most stable (page 40).

Note

- In most cases, you will not need to change this setting.
 - If [RF Change] is set to [Off], transmission between the unit and S-AIR sub unit can be performed using one of the following channels.
 - S-AIR ID A: equivalent channel for IEEE 802.11b/g channel 1
 - S-AIR ID B: equivalent channel for IEEE 802.11b/g channel 6
 - S-AIR ID C: equivalent channel for IEEE 802.11b/g channel 11
- The transmission may be improved by changing the transmission channel (frequency) of the other wireless system(s). For details, refer to the operating instructions of the other wireless system(s).

Using the Control for HDMI Function for “BRAVIA” Sync

This function is available on TVs with the “BRAVIA” Sync function.

By connecting Sony components that are compatible with the Control for HDMI function with an HDMI cable, operation is simplified as below:

- System Power Off (page 45)
- One-Touch Play (page 45)
- Theatre Mode (page 45)
- System Audio Control (page 45)
- Volume Limit (page 45)
- Audio Return Channel (page 45)
- Remote Easy Control (page 46)
- Language Follow (page 46)

Control for HDMI is a mutual control function standard used by CEC (Consumer Electronics Control) for HDMI (High-Definition Multimedia Interface).

The Control for HDMI function will not work when you connect this system to a component which is not compatible with the Control for HDMI function.

There are convenient buttons on the system’s remote for operating the TV, such as THEATRE, ONE-TOUCH PLAY, and TV I/⏻. For details, see “Remote control” (page 11) and refer to the operating instructions of the TV.

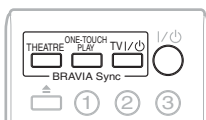

Note

- Depending on the connected component, the Control for HDMI function may not work. Refer to the operating instructions supplied with the component.

- The Control for HDMI function may not work if you connect other than a Sony component, even if the component is compatible with the Control for HDMI function.

Preparing for the Control for HDMI function

(Control for HDMI - Easy Setting)

If your TV is compatible with the Control for HDMI - Easy Setting function, you can set the system’s [Control for HDMI] function automatically by setting the TV. For details, refer to the operating instructions of the TV.

If the TV is not compatible with the Control for HDMI - Easy Setting function, set the Control for HDMI function of the system and TV manually.

Note

- For details on setting the TV, refer to the operating instructions of the TV.

- 1 Make sure that the system and the TV are connected with an HDMI cable.**
- 2 Turn on the TV and press I/⏻ to turn on the system.**
- 3 Set the Control for HDMI function of the system and TV.**

The Control for HDMI function for the system and TV is simultaneously set to on.

To set the [Control for HDMI] function of the system to on/off manually

- 1 Press HOME.**
The home menu appears on the TV screen.
- 2 Press ←/→ to select [Setup].**
- 3 Press ↑/↓ to select [System Settings], then press ⊕.**
- 4 Press ↑/↓ to select [HDMI Settings], then press ⊕.**
The [HDMI Settings] display appears.
- 5 Press ↑/↓ to select [Control for HDMI], then press ⊕.**

6 Press \uparrow/\downarrow to select the setting, then press \oplus .

- [On]: On.
- [Off]: Off.

Turning the system off in sync with the TV

(System Power Off)

When you turn the TV off by using the POWER button on the TV's remote or TV \mathbb{I}/\mathbb{O} on the system's remote, the system turns off automatically.

Note

• This function depends on the settings of your TV. For details, refer to the operating instructions of the TV.

Watching BD/DVD by a single button press

(One-Touch Play)

Press **ONE-TOUCH PLAY**.

The system and your TV turn on, your TV's input is set to the HDMI input to which the system is connected, and the system starts playing a disc automatically.

The System Audio Control function is also activated automatically.

Also, when you insert a disc, One-Touch Play is enabled. If One-Touch Play does not start (in the case of inserting a disc that is not compatible with the auto playback function), press **FUNCTION** repeatedly to select "BD/DVD" and press \blacktriangleright or **ONE-TOUCH PLAY**.

Using the Theatre Mode

(Theatre Mode)

Press **THEATRE**.

If your TV is compatible with the Theatre Mode, you can enjoy optimal image and sound quality suited for movies, and the System Audio Control function is activated automatically.

Enjoying TV sound from the speakers in this system

(System Audio Control)

You can simplify operation to enjoy TV sound via this system.

To use this function, connect the system and the TV with an audio cord and an HDMI cable (pages 20, 21).

You can use the System Audio Control function as follows:

- When the system is turned on, TV sound can be output from the speakers of the system.
- When TV sound is output from the speakers of the system, you can change the output method to the speakers of the TV via the TV menu.
- When TV sound is output from the speakers of the system, you can adjust the volume and turn off the sound of the system using the TV remote.

Note

- While the TV is in PAP (picture and picture) mode, the System Audio Control function will not work.
- Depending on the TV, when you adjust the unit's volume, the volume level appears on the TV screen. In this case, the volume level that appears on the TV screen and the unit's front panel display may differ.

Setting the Maximum Volume Level of the System

(Volume Limit)

When the System Audio Control function is activated, loud sound may be output depending on the volume level of the system. You can prevent this by limiting the maximum level of the volume. For details, see [Volume Limit] (page 54).

Receiving the digital audio signal of the TV

(Audio Return Channel)

The system can receive the digital audio signal of the TV via an HDMI cable when your TV is

compatible with the Audio Return Channel function. You can enjoy TV sound via the system by using just one HDMI cable. For details, see [Audio Return Channel] (page 54).

Operating the system via the TV remote

(Remote Easy Control)

You can control the basic functions of the system via the TV remote when the system's video output is displayed on the TV screen. For details, refer to the operating instructions of the TV.

Changing the language for the on-screen display of the TV

(Language Follow)

When you change the language for the on-screen display of the TV, the system's on-screen display language is also changed after turning the system off and on.

Calibrating the Appropriate Settings Automatically

[Auto Calibration]

D. C. A. C. (Digital Cinema Auto Calibration) can set the appropriate surround sound automatically.

Note

- The system outputs a loud test sound when [Auto Calibration] starts. You cannot turn the volume down. Give consideration to children and neighbors.

1 Press HOME.

The home menu appears on the TV screen.

2 Press ←/→ to select [Setup].

3 Press ↑/↓ to select [Audio Settings], then press ⊕.

4 Press ↑/↓ to select [Auto Calibration], then press ⊕.

The confirmation display for [Auto Calibration] appears.

5 Connect the calibration mic to the A.CAL MIC jack on the rear panel.

Set up the calibration mic at ear level using a tripod, etc. (not supplied). The front of each speaker should face the calibration mic, and there should be no obstruction between the speakers and the calibration mic.

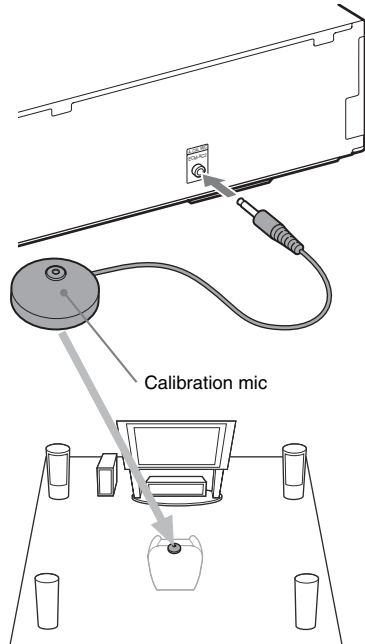

6 Press ↑/↓ to select [OK].

To cancel, select [Cancel].

7 Press ⊕.

[Auto Calibration] starts.

The system adjusts the speaker settings automatically.

Be quiet during the measurement.

Note

- Before [Auto Calibration], make sure that the surround amplifier turns on and you install the surround amplifier in the appropriate location. If you install the surround amplifier in an improper

location, such as another room, proper measurement will not be obtained.

- When you use the Wireless Surround Speaker Kit (WAHT-SBP2, optional) for the surround back speakers (page 14), install the speakers in appropriate location and turn the surround amplifier on. To use the surround back speakers, set [Surround Back] in [Speaker Settings] to [Yes] (page 47)

8 Confirm the conclusions of [Auto Calibration].

The speakers connected to the unit are listed as [Yes] on the TV screen.

Note

- If measurement fails, follow the message then retry [Auto Calibration].
- The measurement for [Subwoofer] is always [Yes] and [Speaker Settings] returns to the default setting when you perform [Auto Calibration].

9 Press \uparrow/\downarrow to select [OK] or [Cancel], then press \oplus .

■ The measurement is OK.

Disconnect the calibration mic, then select [OK]. The result is implemented.

■ The measurement is not OK.

Follow the message, then select [OK] to retry.

Note

- While the Auto Calibration function works:
 - do not turn off the power.
 - do not press any button.
 - do not change the volume.
 - do not change the function.
 - do not change the disc.
 - do not insert a disc.
 - do not disconnect the calibration mic.

Setting the Speakers

[Speaker Settings]

To obtain the best possible surround sound, test connection of the speakers and their distance from your listening position. Then use the test tone to adjust the level and the balance of the speakers to the same level.

1 Press HOME.

The home menu appears on the TV screen.

2 Press \leftarrow/\rightarrow to select [Setup].

3 Press \uparrow/\downarrow to select [Audio Settings], then press \oplus .

4 Press \uparrow/\downarrow to select [Speaker Settings], then press \oplus .

The [Speaker Settings] display appears.

5 Press \uparrow/\downarrow to select the item, then press \oplus .

Check the following settings.

■ [Connection]

If you do not connect center or surround speakers, set the parameters for [Center] and [Surround]. Since the front speaker and subwoofer settings are fixed, you cannot change them.

When you use the Wireless Surround Speaker Kit (WAHT-SBP2, optional) for the surround back speakers (page 14), set [Surround Back] also.

[Front]

[Yes]

[Center]

[Yes]: Normally select this.

[None]: Select this if no center speaker is used.

[Surround]

[Yes]: Normally select this.

[None]: Select this if no surround speaker is used.

[Surround Back]

[Yes]: Select this if surround back speakers are used.

[None]: Select this if no surround back speakers is used.

[Subwoofer]

[Yes]

■ [Distance]

When you move the speakers, be sure to set the parameters of the distance () from the listening position to the speakers.

You can set the parameters from 0.0 to 7.0 meters.

The speakers in the illustration correspond to the following:

- ① Center speaker
- ② Front left speaker (L)
- ③ Front right speaker (R)
- ④ Subwoofer
- ⑤ Surround left speaker (L)
- ⑥ Surround right speaker (R)
- ⑦ Surround back left speaker (L) (optional)
- ⑧ Surround back right speaker (R) (optional)

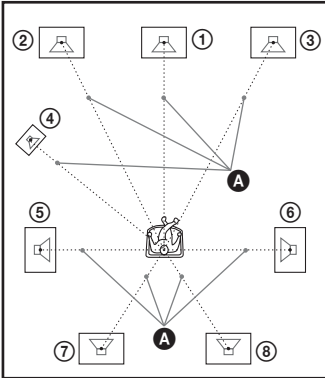

[Front Left/Right] 3.0 m: Set the front speaker distance.

[Center]* 3.0 m: Set the center speaker distance.

[Surround Left/Right]* 3.0 m: Set the surround speaker distance.

[Surround Back Left/Right]* 3.0 m: Set the surround back speaker distance.

[Subwoofer] 3.0 m: Set the subwoofer distance.

* This item appears when you set it to [Yes] in the [Connection] setting.

Note

- Depending on the input stream, [Distance] may not be effective.

■ [Level]

You can adjust the sound level of the speakers. You can set the parameters from -6.0 dB to +6.0 dB. Be sure to set [Test Tone] to [On] for easy adjustment.

[Front Left/Right] 0.0 dB: Set the front speaker level.

[Center]* 0.0 dB: Set the center speaker level.

[Surround Left/Right]* 0.0 dB: Set the surround speaker level.

[Surround Back Left/Right]* 0.0 dB: Set the surround back speaker level.

[Subwoofer] 0.0 dB: Set the subwoofer level.

* This item appears when you set it to [Yes] in the [Connection] setting.

■ [Test Tone]

The speakers will emit a test tone to adjust [Level].

[Off]: The test tone is not emitted from the speakers.

[On]: The test tone is emitted from each speaker in sequence while adjusting level. When you select one of the [Speaker Settings] items, the test tone is emitted from each speaker in sequence.

Adjust the sound level as follows.

- 1** Set [Test Tone] to [On].
- 2** Press \uparrow/\downarrow to select [Level], then press \oplus .
- 3** Press \uparrow/\downarrow to select the desired speaker type, then press \oplus .
- 4** Press \leftarrow/\rightarrow to select the left or right speaker, then press \uparrow/\downarrow to adjust the level.
- 5** Press \oplus .
- 6** Repeat Steps 3 to 5.
- 7** Press RETURN.
The system returns to the previous display.
- 8** Press \uparrow/\downarrow to select [Test Tone], then press \oplus .
- 9** Press \uparrow/\downarrow to select [Off], then press \oplus .

Note

- The test tone signals are not output from the HDMI OUT jack.

Tip

- To adjust the volume of all the speakers at one time, press \triangleleft +/-.

Using the Sleep Timer

You can set the system to turn off at a preset time, so you can fall asleep listening to music. The time can be preset in intervals of 10 minutes.

Press SLEEP.

Each time you press SLEEP, the minutes display (the remaining time) changes by 10 minutes. When you set the sleep timer, "SLEEP" flashes in the front panel display.

To check the remaining time

Press SLEEP once.

To change the remaining time

Press SLEEP repeatedly to select the desired time.

Deactivating the Buttons on the Unit

(Child Lock)

You can deactivate the buttons on the unit (except for I/⏻) for preventing misoperation, such as child mischief (child lock function).

Press ■ on the unit for more than 5 seconds.

"CHILD LOCK" and "ON" appear in the front panel display.

The child lock function is activated and the buttons on the unit are locked. (You can operate the system by using the remote.)

To cancel, press ■ for more than 5 seconds so that "CHILD LOCK" and "OFF" appear in the front panel display.

Note

- When you operate the buttons on the unit while the child lock function is on, "CHILD LOCK" appears in the front panel display.

Controlling Your TV with the Supplied Remote

By adjusting the remote signal, you can control your TV with the supplied remote.

Note

- When you replace the batteries of the remote, the code number may reset itself to the default (SONY) setting. Reset the appropriate code number.

Preparing the remote for controlling the TV

Press and hold TV I/⏻ while entering your TV's manufacturer's code (see the table) using the number buttons. Then release TV I/⏻.

If the setting is unsuccessful, the currently registered code is not changed. Re-enter the code number.

Code numbers of controllable TVs

If more than one code number is listed, try entering them one at a time until you find the code that works with your TV.

Manufacturer	Code number
SONY	01 (default)
SAMSUNG	02, 08
LG	05
PHILIPS	02, 03, 07
PANASONIC	06
TOSHIBA	04

Saving Power in Standby Mode

Check that the following settings are made:

- [Control for HDMI] in [HDMI Settings] is set to [Off] (page 44).
- [Standby] in [S-AIR Settings] is set to [Off] (page 41).
- [Quick Start Mode] is set to [Off] (page 54).

Settings and Adjustments

Using the Setup Display

You can make various adjustments of items such as picture and sound.

Select  (Setup) on the home menu when you need to change the settings of the system.

The default settings are underlined.

Note

- Playback settings stored in the disc take priority over the Setup Display settings and not all the functions described may work.

1 Press HOME.

The home menu appears on the TV screen.

2 Press \leftarrow/\rightarrow to select [Setup].

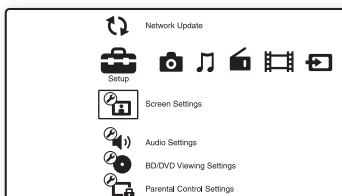





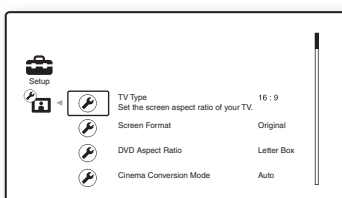





3 Press \uparrow/\downarrow to select the setup category icon to change, then press \oplus .

Example: [Screen Settings]



You can setup the following options.

Icon	Explanation
	[Network Update] (page 50) Updates the software of the system.
	[Screen Settings] (page 51) Makes the screen settings according to the type of connecting jacks.

Icon	Explanation
	[Audio Settings] (page 52) Makes the audio settings according to the type of connecting jacks.
	[BD/DVD Viewing Settings] (page 52) Makes detailed settings for BD/DVD playback.
	[Parental Control Settings] (page 53) Makes detailed settings for the Parental Control function.
	[Music Settings] (page 53) Makes detailed settings for Super Audio CD playback.
	[System Settings] (page 54) Makes the system-related settings.
	[Network Settings] (page 55) Makes detailed settings for Internet and network.
	[Easy Setup] (page 55) Re-runs the Easy Setup to make the basic settings.
	[Resetting] (page 55) Resets the system to the factory settings.

[Network Update]

You can update and improve the functions of the system.

For information about update functions, refer to the following website:

For customers in Europe and Russia
<http://support.sony-europe.com/>

For customers in Asia and Australia
<http://www.sony-asia.com/support>



[Screen Settings]

■ [TV Type]

[16:9]: Select this when connecting to a wide-screen TV or a TV with a wide-mode function.

[4:3]: Select this when connecting to a 4:3 screen TV without a wide-mode function.

■ [Screen Format]

[Original]: Select this when connecting to a TV with a wide-mode function. Displays a 4:3 screen picture in 16:9 aspect ratio even on a wide-screen TV.

[Fixed Aspect Ratio]: Changes the picture size to fit the screen size with the original picture aspect ratio.

■ [DVD Aspect Ratio]

[Letter Box]: Displays a wide picture with black bands on the top and bottom.



[Pan & Scan]: Displays a full-height picture on the entire screen, with trimmed sides.

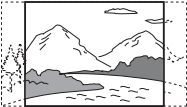

■ [Cinema Conversion Mode]

[Auto]: Normally select this. The unit automatically detects whether the material is video-based or film-based, and switches to the appropriate conversion method.

[Video]: The conversion method suited for video-based material will always be selected regardless of the material.

■ [Output Video Format]

[HDMI]: Normally select [Auto]. Select [Original Resolution] to output the resolution recorded on the disc. (When the resolution is lower than SD resolution, it is scaled up to SD resolution.)

[Component Video]: Select the resolution that suits your TV.

[Video]: Automatically sets the lowest resolution.

Note

- When connecting the HDMI OUT jack and other video output jacks at the same time, select [Component Video].
- If no picture appears when setting [HDMI] or [Component Video] resolution, try another resolution setting.

■ [BD/DVD-ROM 1080/24p Output]

[Auto]: Outputs 1920 × 1080p/24 Hz video signals only when connecting a 1080/24p-compatible TV using the HDMI OUT jack.

[Off]: Select this when your TV is not compatible with 1080/24p video signals.

■ [YCbCr/RGB (HDMI)]

[Auto]: Automatically detects the type of external device, and switches to the matching color setting.

[YCbCr (4:2:2)]: Outputs YCbCr 4:2:2 video signals.

[YCbCr (4:4:4)]: Outputs YCbCr 4:4:4 video signals.

[RGB]: Select this when connecting to a device with an HDCP-compliant DVI jack.

■ [HDMI Deep Colour Output]

[Auto]: Normally select this.

[12bit], [10bit]: Outputs 12bit/10bit video signals when the connected TV is compatible with Deep Colour.

[Off]: Select this when the picture is unstable or colors appear unnatural.

■ [Pause Mode] (BD/DVD VIDEO/DVD-R/DVD-RW only)

[Auto]: The picture, including subjects that move dynamically, is output with no jitter. Normally select this position.

[Frame]: The picture, including subjects that do not move dynamically, is output in high resolution.

 **[Audio Settings]**

■ [BD Audio MIX Setting]

[On]: Outputs the audio obtained by mixing the interactive audio and secondary audio to the primary audio.

[Off]: Outputs the primary audio only. Select this when outputting HD audio signals to an AV receiver.

■ [Audio DRC]

You can compress the dynamic range of the sound track.

[Auto]: Performs playback at the dynamic range specified by the disc (BD-ROM only).

[Off]: No compression of dynamic range.

[On]: The system reproduces the sound track with the kind of dynamic range that the recording engineer intended.

■ [Attenuate - AUDIO]

Distortion may occur when you listen to a component connected to the AUDIO (AUDIO IN L/R) jacks. You can prevent distortion by reducing the input level on the unit.

[On]: Attenuates the input level. The output level is changed.

[Off]: Normal input level.

■ [Audio Output]

The system cannot output multi-channel sound from both the HDMI OUT jack and system's speakers simultaneously.

[Speaker]: Outputs multi-channel sound from the system's speakers only.

[Speaker + HDMI]: Outputs multi-channel sound from the system's speakers and 2-channel linear PCM signals from the HDMI OUT jack.

[HDMI]: Outputs sound from the HDMI OUT jack only. Sound format depends on the connected component.

Note

- When you set [Audio Output] to [HDMI], the SOUND MODE, "D.BASS," "NIGHT MODE," and "SUR.SETTING" functions are disabled.

- When the System Audio Control function (page 45) is activated, this setting may change automatically.
-

■ [Sound Effect]

You can set the system's sound effects (SOUND MODE, "D.BASS," "NIGHT MODE," and "SUR.SETTING") to on/off.

[On]: Enables all of the system's sound effects. The upper limit of sampling frequency is set to 48 kHz.

[Off]: The sound effects are disabled. Select this when you do not want to set the upper limit of sampling frequency.

■ [Speaker Settings]

To obtain the best possible surround sound, set the speakers. For details, see "Setting the Speakers" (page 47).

■ [Auto Calibration]

You can calibrate the appropriate settings automatically. For details, see "Calibrating the Appropriate Settings Automatically" (page 46).

 **[BD/DVD Viewing Settings]**

You can make detailed settings for BD/DVD playback.

■ [BD/DVD Menu]

You can select the default menu language for BD-ROMs or DVD VIDEOS.

When you select [Select Language Code], the display for entering the language code appears. Enter the code for your language by referring to "Language Code List" (page 70).

■ [Audio]

You can select the default track language for BD-ROMs or DVD VIDEOS.

When you select [Original], the language given priority in the disc is selected.

When you select [Select Language Code], the display for entering the language code appears.

Enter the code for your language by referring to “Language Code List” (page 70).

■ [Subtitle]

You can select the default subtitle language for BD-ROMs or DVD VIDEOS.

When you select [Select Language Code], the display for entering the language code appears. Enter the code for your language by referring to “Language Code List” (page 70).

■ [BD Hybrid Disc Playback Layer]

[BD]: Plays BD layer.

[DVD/CD]: Plays DVD or CD layer.

■ [BD Internet Connection]

[Allow]: Normally select this.

[Do not allow]: Prohibits Internet connection.

■ [BD Data Storage Options]

[Internal memory]: Selects the internal memory to store BD data.

[USB device (front)]: Selects the  (USB) port on the front panel to store BD data.

[USB device (rear)]: Selects the  (USB) port on the rear panel to store BD data.

[Parental Control Settings]

■ [Password]

Set or change the password for the Parental Control function. A password allows you to set a restriction on BD-ROM, DVD VIDEO, or Internet video playback. If necessary, you can differentiate the restriction levels for BD-ROMs and DVD VIDEOS.

■ [Parental Control Area Code]

Playback of some BD-ROMs or DVD VIDEOS can be limited according to the geographic area. Scenes may be blocked or replaced with different scenes. Follow the on-screen instructions and enter your four-digit password.

■ [BD Parental Control]

Playback of some BD-ROMs can be limited according to the age of the users. Scenes may be blocked or replaced with different scenes.

Follow the on-screen instructions and enter your four-digit password.

■ [DVD Parental Control]

Playback of some DVD VIDEOS can be limited according to a predetermined level such as the age of the users. Scenes may be blocked or replaced with different scenes. Follow the on-screen instructions and enter your four-digit password.

■ [Internet Video Parental Control]

Playback of some Internet videos can be limited according to the age of the users. Scenes may be blocked or replaced with different scenes.

Follow the on-screen instructions and enter your four-digit password.

■ [Internet Video Unrated]

[Allow]: Allows the playback of unrated Internet videos.

[Block]: Blocks the playback of unrated Internet videos.

[Music Settings]

You can make detailed settings for Super Audio CD playback.

■ [Super Audio CD Playback Layer]

[Super Audio CD]: Plays the Super Audio CD layer.

[CD]: Plays the CD layer.

■ [Super Audio CD Playback Channels]

[DSD 2ch]: Plays the 2ch area.

[DSD Multi]: Plays the multi-channel area.

 **[System Settings]**

You can make the system-related settings.

■ [OSD]

You can select your language for the system on-screen displays.

■ [S-AIR Settings]

You can set up the S-AIR settings. For details, see “Using an S-AIR Product” (page 39).

[ID]: You can set the ID of the system.

[Pairing]: You can pair the system and S-AIR sub unit, such as a surround amplifier or S-AIR receiver.

[RF Change]: If wireless transmission is unstable, set this function.

[Mode]: You can enjoy the system’s sound in another room.

[Standby]: You can enjoy the S-AIR receiver while the unit is in standby mode.

■ [Dimmer]

[Bright]: Bright lighting.

[Dark]: Low lighting.

■ [HDMI Settings]

By connecting Sony components that are compatible with the Control for HDMI function with an HDMI cable, operation is simplified. For details, see “Using the Control for HDMI Function for “BRAVIA” Sync” (page 44).

[Control for HDMI]

You can set the [Control for HDMI] function to on/off.

[On]: On. You can operate mutually between components that are connected with an HDMI cable.

[Off]: Off.

[Audio Return Channel]

This function is available when you connect the system and TV that is compatible with the Audio Return Channel function.

[Auto]: The system can receive the digital audio signal of the TV automatically via an HDMI cable.

[Off]: Off.

Note

- This function is available only when [Control for HDMI] is set to [On].

[Volume Limit]

When the System Audio Control (page 45) is activated, loud sound may be output depending on the volume level of the system. You can prevent this by limiting the maximum level of the volume when the System Audio Control function activates.

[Level3]: Maximum volume level is set to 10.

[Level2]: Maximum volume level is set to 15.

[Level1]: Maximum volume level is set to 20.

[Off]: Off.

Note

- This function is available only when [Control for HDMI] is set to [On].
-

■ [Quick Start Mode]

[On]: Shortens the startup time from standby mode. You can operate the system quickly after turning it on.

[Off]: The default setting.

■ [Auto Standby]

[On]: Turns on the [Auto Standby] function.

When you do not operate the system for about 30 minutes, the system enters standby mode automatically.

[Off]: Turns off the function.

■ [Auto Display]

[On]: Automatically displays information on the screen when changing the viewing titles, picture modes, audio signals, etc.

[Off]: Displays information only when you press DISPLAY.

■ [Screen Saver]

[On]: Turns on the screen saver function.

[Off]: Off.

■ [Software Update Notification]

[On]: Sets the system to inform you of newer software version information (page 50).

[Off]: Off.

■ [Gracenote Settings]

[Auto]: Automatically downloads disc information when you stop playback of the disc. To download, the system must be connected to the network.

[Manual]: Downloads disc information when you select [Playback History] or [Information Display] in the options menu.

■ [DivX® VOD]

You can display the registration or deregistration code for this system, or deregister this system after registration.

When the registration is disabled

[Registration Code]: The registration code is displayed.

[Deregistration Code]: The deregistration code is displayed. (This item can be selected only after the registration code is displayed.)

When the registration is enabled

Press ←/→ to select [OK] or [Cancel], then press ⊕.

[OK]: The device is deregistered and the deregistration code is displayed.

[Cancel]: The system returns to the previous display.

For more information, go to <http://www.divx.com> on the Internet.

■ [System Information]

You can display the system's software version information and the MAC address.

**[Network Settings]**

You can make detailed settings for Internet and network.

■ [Internet Settings]

Connect the system to the network beforehand. For details, see "Connecting to the network" (page 24).

[View Network Status]: Displays the current network status.

[Wired Setup]: Select this when you connect to a broadband router directly.

[USB Wireless Setup]: Select this when you use a USB Wireless LAN Adapter.

For more information, go to

For customers in Europe and Russia
<http://support.sony-europe.com/>

For customers in Asia and Australia
<http://www.sony-asia.com/support>

■ [Network Connection Diagnostics]

You can run the network diagnostic to check if the network connection has been made properly.

■ [BD Remote Device Registration]

Registers your "BD remote" device.

■ [Registered BD Remote Devices]

Displays a list of your registered "BD remote" devices.

**[Easy Setup]**

Re-runs the Easy Setup to make the basic settings. Follow the on-screen instructions.

**[Resetting]****■ [Reset to Factory Default Settings]**

You can reset the system settings to the factory default by selecting the group of settings. All the settings within the group will be reset.

■ [Initialize Personal Information]

You can erase your personal information stored in the system.

Precautions

On safety

- To prevent fire or shock hazard, do not place objects filled with liquids, such as vases, on the system, or place the system near water, such as near a bathtub or shower room. Should any solid object or liquid fall into the cabinet, unplug the system and have it checked by qualified personnel before operating it any further.
- Do not touch the AC power cord (mains lead) with wet hands. Doing so may cause an electric shock.

On power sources

- Unplug the unit from the wall outlet (mains) if you do not intend to use it for an extended period of time. To disconnect the cord, pull it out by the plug, never by the cord.

On placement

- Place the system in a location with adequate ventilation to prevent heat build-up in the system.
- At high volume, over long periods of time, the cabinet becomes hot to the touch. This is not a malfunction. However, touching the cabinet should be avoided. Do not place the system in a confined space where ventilation is poor as this may cause overheating.
- Do not block the ventilation slots by putting anything on the system. The system is equipped with a high power amplifier. If the ventilation slots are blocked, the system can overheat and malfunction.
- Do not place the system on surfaces (rugs, blankets, etc.) or near materials (curtains, draperies) that may block the ventilation slots.
- Do not install the system in a confined space, such as a bookshelf or similar unit.
- Do not install the system near heat sources such as radiators, air ducts, or in a place subject to direct sunlight, excessive dust, mechanical vibration, or shock.
- Do not install the system in an inclined position. It is designed to be operated in a horizontal position only.
- Keep the system and discs away from components with strong magnets, such as microwave ovens, or large loudspeakers.
- Do not place heavy objects on the system.

On operation

- If the system is brought directly from a cold to a warm location, or is placed in a very damp room, moisture may condense on the lenses inside the unit. Should this occur, the system may not operate properly. In this case, remove the disc and leave the system turned on for about half an hour until the moisture evaporates.
- When you move the system, take out any disc. If you do not, the disc may be damaged.
- If anything falls into the cabinet, unplug the unit and have it checked by qualified personnel before operating it any further.

On adjusting volume

- Do not turn up the volume while listening to a section with very low level inputs or no audio signals. If you do, the speakers may be damaged when a peak level section is suddenly played.

On cleaning

- Clean the cabinet, panel, and controls with a soft cloth slightly moistened with a mild detergent solution. Do not use any type of abrasive pad, scouring powder or solvent such as alcohol or benzene.
If you have any questions or problems concerning your system, please consult your nearest Sony dealer.

On cleaning discs, disc/lens cleaners

- **Do not use cleaning discs or disc/lens cleaners (including wet or spray types). These may cause the apparatus to malfunction.**

On replacement of parts

- In the events that this system is repaired, repaired parts may be collected for reuse or recycling purposes.

On your TV's color

- If the speakers should cause the TV screen to have color irregularity, turn off the TV then turn it on after 15 to 30 minutes. If color irregularity should persist, place the speakers further away from the TV set.

IMPORTANT NOTICE

Caution: This system is capable of holding a still video image or on-screen display image on your television screen indefinitely. If you leave the still video image or on-screen display image displayed on your TV for an extended period of time you risk permanent damage to your television screen. Projection televisions are especially susceptible to this.

On moving the system

- Before moving the system, make sure that there is no disc inserted, and remove the AC power cord (mains lead) from the wall outlet (mains).

Notes about the Discs

On handling discs

- To keep the disc clean, handle the disc by its edge. Do not touch the surface.
- Do not stick paper or tape on the disc.



- Do not expose the disc to direct sunlight or heat sources such as hot air ducts, or leave it in a car parked in direct sunlight as the temperature may rise considerably inside the car.
- After playing, store the disc in its case.

On cleaning

- Before playing, clean the disc with a cleaning cloth.
Wipe the disc from the center out.



- Do not use solvents such as benzine, thinner, commercially available cleaners, or anti-static spray intended for vinyl LPs.

This system can only play a standard circular disc. Using neither standard nor circular discs (e.g., card, heart, or star shape) may cause a malfunction.

Do not use a disc that has a commercially available accessory attached, such as a label or ring.

Troubleshooting

If you experience any of the following difficulties while using the system, use this troubleshooting guide to help remedy the problem before requesting repairs. Should any problem persist, consult your nearest Sony dealer.

Note that if service personnel changes some parts during repair, these parts may be retained.

In the event of a problem with the S-AIR function, have a Sony dealer check the entire system together (S-AIR main unit and sub unit).

Power

Symptom	Problems and solutions
The power is not turned on.	<ul style="list-style-type: none">• Check that the AC power cord (mains lead) is connected securely.
“PROTECTOR” and “PUSH POWER” appear alternately in the front panel display.	<p>Press  to turn off the system, and check the following items after “STANDBY” disappears.</p> <ul style="list-style-type: none">• Are the + and – speaker cords short-circuited?• Are you using only the specified speakers?• Is anything blocking the ventilation holes of the system?• After checking the above items and fixing any problems, turn on the system. If the cause of the problem cannot be found even after checking all the above items, consult your nearest Sony dealer.

General

Symptom	Problems and solutions
The remote does not function.	<ul style="list-style-type: none">• The distance between the remote and the unit is too far.• The batteries in the remote are weak.• When you cannot perform menu operations via the front panel display, press HOME on the remote.
The system does not work normally.	<ul style="list-style-type: none">• Disconnect the AC power cord (mains lead) from the wall outlet (mains), then reconnect after several minutes.

Picture

Symptom	Problems and solutions
There is no picture.	<ul style="list-style-type: none">• Check the video connection (page 20).• The unit is not connected to the correct TV input jack (page 20).• The video input on the TV is not set so that you can view pictures from the system.• Check the output method on your system (page 20).• The unit is connected to an input device that is not HDCP (High-bandwidth Digital Content Protection) compliant (“HDMI” on the front panel does not light up) (page 20).• When playing a double-layer DVD, the video and audio may be momentarily interrupted at the point where the layers switch.
No picture appears when the video output resolution selected in [Output Video Format] is incorrect.	<ul style="list-style-type: none">• Press and hold  and VOLUME – on the unit for more than 5 seconds to reset the video output resolution to the lowest resolution.

Symptom	Problems and solutions
Video signals are only output from the HDMI OUT jack when connecting the HDMI OUT jack and other video output jacks at the same time.	<ul style="list-style-type: none"> • Set [Output Video Format] in [Screen Settings] to [Component Video] (page 51).
The dark area of the picture is too dark/the bright area is too bright or unnatural.	<ul style="list-style-type: none"> • Set [Picture Quality Mode] to [Standard] (default) (page 32).
The picture is not output correctly.	<ul style="list-style-type: none"> • Check the [Output Video Format] settings in [Screen Settings] (page 51). • If the analog and digital signals are output at the same time, set [BD/DVD-ROM 1080/24p Output] in [Screen Settings] to [Off] (page 51). • For BD-ROMs, check the [BD/DVD-ROM 1080/24p Output] settings in [Screen Settings] (page 51).
Picture noise appears.	<ul style="list-style-type: none"> • The disc is dirty or flawed. • If the picture output from your system goes through your VCR to get to your TV, the copy-protection signal applied to some BD/DVD programs could affect picture quality. If you still experience problems even when you connect your unit directly to your TV, try connecting your unit to the other input jacks.
Even though you set the aspect ratio in [TV Type] of [Screen Settings], the picture does not fill the TV screen.	<ul style="list-style-type: none"> • The aspect ratio on the disc is fixed.
Color irregularity occurs on the TV screen.	<ul style="list-style-type: none"> • If the speakers are used with a CRT-based TV or projector, install the speakers at least 0.3 meters from the TV set. • If the color irregularity persists, turn off the TV set once, then turn it on after 15 to 30 minutes. • Make sure that no magnetic object (magnetic latch on a TV stand, health care device, toy, etc.) is placed near the speakers.

Sound

Symptom	Problems and solutions
There is no sound.	<ul style="list-style-type: none"> • The speaker cord is not connected securely. • Check the speaker settings (page 47). • Fast forward or fast reverse is performed. Press ► to return to normal play mode. • Slow forward or freeze frame is performed. Press ► to return to normal play mode.
No sound is output from the HDMI OUT jack.	<ul style="list-style-type: none"> • Set [Audio Output] to [HDMI] (page 52).
The left and right sounds are unbalanced or reversed.	<ul style="list-style-type: none"> • Check that the speakers and components are connected correctly and securely.
There is no sound from the subwoofer.	<ul style="list-style-type: none"> • Check the speaker connections and settings (pages 19, 47).

Symptom	Problems and solutions
There is no digital sound from the HDMI OUT jack when using the Audio Return Channel function.	<ul style="list-style-type: none"> • Set [Control for HDMI] in [HDMI Settings] of [System Settings] to [On] (page 54). Also, set [Audio Return Channel] in [HDMI Settings] of [System Settings] to [Auto] (page 54). • Make sure that your TV is compatible with the Audio Return Channel function. • Make sure that an HDMI cable is connected to a jack on your TV that is compatible with the Audio Return Channel function. • The sampling frequency of the input stream is more than 48 kHz.
The system does not output sound correctly when connected to a set-top box.	<ul style="list-style-type: none"> • Set [Audio Return Channel] in [HDMI Settings] of [System Settings] to [Off] (page 45).
Severe hum or noise is heard.	<ul style="list-style-type: none"> • Check that the connecting cords are away from a transformer or motor, and at least 3 meters away from your TV set or a fluorescent light. • Move your TV away from the audio components. • Clean the disc.
The sound loses stereo effect when you play a CD.	<ul style="list-style-type: none"> • Select stereo sound by pressing  (page 34).
The surround effect is difficult to hear when you are playing a sound track of Dolby Digital, DTS, or MPEG audio.	<ul style="list-style-type: none"> • Check the surround setting (page 27). • Check the speaker connections and settings (pages 19, 47). • Depending on the BD/DVD, the output signal may not be the entire 5.1 channel. It may be monaural or stereo even if the sound track is recorded in Dolby Digital or MPEG audio format.
The sound comes from the center speaker only.	<ul style="list-style-type: none"> • Depending on the disc, the sound may come from the center speaker only.
No sound is heard from the center speaker.	<ul style="list-style-type: none"> • Check the speaker connections and settings (pages 19, 47). • Check the surround setting (page 27). • Depending on the source, the effect of the center speaker may be less noticeable. • A 2 channel source is being played.
No sound or only a very low-level sound is heard from the surround speakers.	<ul style="list-style-type: none"> • Check the speaker connections and settings (pages 19, 47). • Check the surround setting (page 27). • Depending on the source, the effect of the surround speakers may be less noticeable. • A 2 channel source is being played.
The beginning of the sound is cut off.	<ul style="list-style-type: none"> • Set the sound mode to "MOVIE" or "MUSIC" (page 34). • Select "A.F.D. STD" for "SUR.SETTING" (page 27).
The sound effects are disabled.	<ul style="list-style-type: none"> • The effects of SOUND MODE, "D.BASS," "NIGHT MODE," and "SUR.SETTING" may be disabled depending on the input stream (page 52).
Distortion occurs in the sound of a connected component.	<ul style="list-style-type: none"> • Reduce the input level for the connected component by setting [Attenuate - AUDIO] (page 52).

Operation

Symptom	Problems and solutions
Radio stations cannot be tuned in.	<ul style="list-style-type: none"> • Check that the antenna (aerial) is connected securely. Adjust the antenna (aerial) or connect an external antenna (aerial) if necessary. • The signal strength of the stations is too weak (when tuning in with automatic tuning). Use direct tuning.

Symptom	Problems and solutions
The disc does not play.	<ul style="list-style-type: none"> You are attempting to play a disc with a format that cannot be played back by this system (page 65). The region code on the BD/DVD does not match the system. Moisture has condensed inside the unit and may cause damage to the lenses. Remove the disc and leave the unit turned on for about half an hour. The system cannot play a recorded disc that is not correctly finalized (page 65).
File names are not displayed correctly.	<ul style="list-style-type: none"> The system can only display ISO 8859-1-compliant character formats. Other character formats may be displayed differently. Depending on the writing software used, the input characters may be displayed differently.
A disc does not start playing from the beginning.	<ul style="list-style-type: none"> Resume play has been selected. Press OPTIONS and select [Play from start], then press ⊖. The title or BD/DVD menu automatically appears on the TV screen.
Playback does not start from the resume point where you last stopped playing.	<ul style="list-style-type: none"> The resume point may be cleared from memory depending on the disc when <ul style="list-style-type: none"> you open the disc tray. you disconnect the USB device. you play other content. you turn off the unit.
The system starts playing the disc automatically.	<ul style="list-style-type: none"> The BD/DVD features an auto playback function.
Playback stops automatically.	<ul style="list-style-type: none"> Some discs may contain an auto pause signal. While playing such a disc, the system stops playback at the auto pause signal.
You cannot perform some functions such as stop or search.	<ul style="list-style-type: none"> Depending on the disc, you may not be able to perform some of the operations. Refer to the operating instructions supplied with the disc.
Messages do not appear on the TV screen in the language you want.	<ul style="list-style-type: none"> In the Setup Display, select the desired language for the on-screen display in [OSD] in [System Settings] (page 54).
The language for the soundtrack/subtitle or angles cannot be changed.	<ul style="list-style-type: none"> Try using the BD's or DVD's menu. Multi-lingual tracks/subtitles or multi-angles are not recorded on the BD or DVD being played. The BD or DVD prohibits the changing of the language for the sound track/subtitle or angles.
The disc tray does not open and you cannot remove the disc even after you press ▲ .	<ul style="list-style-type: none"> Try the following: ① Press and hold ▶ and ▲ on the unit for more than 5 seconds to open the disc tray. ② Remove the disc. ③ Disconnect the AC power cord (mains lead) from the wall outlet (mains), then reconnect after several minutes.
A disc cannot be ejected and "TLK ON" appears in the front panel display.	<ul style="list-style-type: none"> Contact your Sony dealer or local authorized Sony service facility.

Symptom	Problems and solutions
The Control for HDMI function does not work.	<ul style="list-style-type: none"> • Set [Control for HDMI] in [HDMI Settings] of [System Settings] to [On] (page 54). • Make sure that the connected component is compatible with the [Control for HDMI] function. • Check the connected component's setting for the Control for HDMI function. Refer to the operating instructions supplied with the component. • If you change the HDMI connection, connect and disconnect the AC power cord (mains lead), or have a power failure, set [Control for HDMI] in [HDMI Settings] of [System Settings] to [Off], then set [Control for HDMI] to [On] (page 54). • For details, see "Using the Control for HDMI Function for "BRAVIA" Sync" (page 44).
No sound is output from the system and TV while using the System Audio Control function.	<ul style="list-style-type: none"> • Make sure that the connected TV is compatible with the System Audio Control function. • For details, see "Using the Control for HDMI Function for "BRAVIA" Sync" (page 44).
Bonus contents or other data that are contained in a BD-ROM cannot be played.	<ul style="list-style-type: none"> • Try the following: ① Remove the disc. ② Turn the system off. ③ Remove and reconnect the USB device (page 30). ④ Turn the system on. ⑤ Insert the BD-ROM with BONUSVIEW/BD-LIVE.
A message indicating that the internal memory does not have enough space appears on the screen.	<ul style="list-style-type: none"> • Delete unnecessary data in internal memory or USB memory. Select [Erase BD Data] in  [Video] to delete unnecessary data. If you use USB memory as local storage, all saved data in the [BUDA/BUDB] folder is deleted. Make sure to backup any video/music/photo data in the [BUDA/BUDB] folder (page 29).
The unit does not work and "CHILD LOCK" appears in the front panel display when you press any button on the unit.	<ul style="list-style-type: none"> • Set the child lock function to off (page 49).
The system menu does not work.	<ul style="list-style-type: none"> • Press HOME on the remote.

USB device

Symptom	Problems and solutions
The USB device is not recognized.	<ul style="list-style-type: none"> • Try the following: ① Turn the system off. ② Remove and reconnect the USB device. ③ Turn the system on. • Make sure that the USB device is securely connected to the  (USB) port. • Check if the USB device or a cable is damaged. • Check if the USB device is on. • If the USB device is connected via a USB hub, disconnect it and connect the USB device directly to the unit.

S-AIR

Symptom	Problems and solutions
There is no sound from the S-AIR sub unit, noise is heard from the S-AIR sub unit, or sound from the S-AIR sub unit skips.	<ul style="list-style-type: none">• If you use another S-AIR main unit, place it more than 8 meters away from the unit.• Place the S-AIR main unit and S-AIR sub unit closer together.• Avoid use of equipment that generates electromagnetic energy, such as a microwave oven.• Place the S-AIR main unit and S-AIR sub unit away from other wireless products.• See “If wireless transmission is unstable” (page 42).• Change the S-AIR ID settings of the S-AIR main unit and S-AIR sub unit.• Turn off the system and S-AIR sub unit, then turn them on.

BRAVIA Internet Video

Symptom	Problems and solutions
The picture/sound is poor/certain programs display with a loss of detail, especially during fast-motion or dark scenes.	<ul style="list-style-type: none">• Picture/sound quality may be poor depending on Internet content providers.• Picture/sound quality may be improved by changing the connection speed. Sony recommends a connection speed of at least 2.5 Mbps for standard-definition video and 10 Mbps for high-definition video.• Not all videos contain sound.
The picture is small.	<ul style="list-style-type: none">• Press ↑ to zoom in.

Network connection

Symptom	Problems and solutions
The system cannot connect to the network.	<ul style="list-style-type: none">• Check the network connection (page 24) and the network settings (page 55).
You cannot connect your PC to the Internet after [Wi-Fi Protected Setup (WPS)] is performed.	<ul style="list-style-type: none">• The wireless settings of the router may change automatically if you use the Wi-Fi Protected Setup function before adjusting the settings of the router. In this case, change the wireless settings of your PC accordingly.
You cannot connect the system to your wireless LAN router.	<ul style="list-style-type: none">• Check if the wireless LAN router is on.• Depending on the usage environment, including the wall material, radio wave reception conditions, or obstacles between the system and the wireless LAN router, the possible communication distance may be shortened. Move the system and the wireless LAN router closer to each other.• Devices that use a 2.4 GHz frequency band, such as a microwave, Bluetooth, or digital cordless device, may interrupt the communication. Move the unit away from such devices, or turn off such devices.
The desired wireless router is not detected even if [Scan] is performed.	<ul style="list-style-type: none">• Press RETURN to return to the previous screen, and try [Scan] again. If the desired wireless router is still not detected, press RETURN to select [Manual registration].
The message [A new software version has been found on the network. Perform update under “Network Update.”] appears on the screen when turning the system on.	<ul style="list-style-type: none">• See [Network Update] (page 50) to update the system to a newer software version.

Other

Symptom	Problems and solutions
"Exxxx" appears in the front panel display.	<ul style="list-style-type: none">• Contact your nearest Sony dealer or local authorized Sony service facility and give the error code.
△ appears without any messages on the entire screen.	<ul style="list-style-type: none">• Contact your nearest Sony dealer or local authorized Sony service facility.

Playable Discs

Blu-ray Disc	BD-ROM ¹⁾ BD-R/BD-RE ²⁾
DVD³⁾	DVD-ROM DVD-R/DVD-RW DVD+R/DVD+RW
CD³⁾	CD-DA (Music CD) CD-ROM CD-R/CD-RW Super Audio CD

¹⁾Since the Blu-ray Disc specifications are new and evolving, some discs may not be playable depending on the disc type and the version. Also, the audio output differs depending on the source, connected output jack, and selected audio settings.

²⁾BD-RE: Ver.2.1
BD-R: Ver.1.1, 1.2, 1.3 including organic pigment type BD-R (LTH type)
BD-Rs recorded on a PC cannot be played if postscripts are recordable.

³⁾A CD or DVD disc will not play if it has not been correctly finalized. For more information, refer to the operating instructions supplied with the recording device.

Discs that cannot be played

- BDs with cartridge
- DVD-RAMs
- HD DVDs
- DVD Audio discs
- PHOTO CDs
- Data part of CD-Extras
- VCDs/Super VCDs
- Audio material side on DualDiscs

Notes on discs

This product is designed to playback discs that conform to the Compact Disc (CD) standard. DualDiscs and some music discs encoded with copyright protection technologies do not conform to the Compact Disc (CD) standard. Therefore, these discs may not be compatible with this product.

Note on playback operations of a BD/DVD

Some playback operations of a BD/DVD may be intentionally set by software producers. Since this system plays a BD/DVD according to the disc contents the software producers designed, some playback features may not be available.

Note about double-layer BDs/DVDs

The playback picture and sound may be momentarily interrupted when the layers switch.

Region code (BD-ROM/DVD VIDEO only)

Your system has a region code printed on the rear of the unit and will only play a BD-ROM/DVD VIDEO (playback only) labeled with identical region codes or .

Playable Types of Files

Video

File format	Extensions
MPEG-1 Video/PS ¹⁾	“.mpg,” “.mpeg,” “.m2ts,”
MPEG-2 Video/PS, TS ¹⁾	“.mts”
DivX ²⁾	“.avi,” “.divx”
MPEG4/AVC ¹⁾	“.mkv,” “.mp4,” “.m4v,” “.m2ts,” “.mts”
WMV9 ¹⁾	“.wmv,” “.asf”
AVCHD	³⁾

Music

File format	Extensions
MP3 (MPEG-1 Audio Layer III)	“.mp3”
AAC ¹⁾⁴⁾	“.m4a”
WMA9 Standard ¹⁾⁴⁾	“.wma”
LPCM	“.wav”

Photo

File format	Extensions
JPEG	“.jpg,” “.jpeg,” “.jpe”

¹⁾The system does not play files encoded with DRM.

²⁾ABOUT DIVX VIDEO: DivX[®] is a digital video format created by DivX, Inc. This is an official DivX Certified device that plays DivX video. Visit www.divx.com for more information and software tools to convert your files into DivX video. ABOUT DIVX VIDEO-ON-DEMAND: This DivX Certified[®] device must be registered in order to play DivX Video-on-Demand (VOD) content. To generate the registration code, locate the DivX VOD section in the device setup menu. Go to vod.divx.com with this code to complete the registration process and learn more about DivX VOD.

³⁾The system plays AVCHD-format files that are recorded via a digital video camera, etc. To watch AVCHD-format files, the disc with AVCHD-format files on it must be finalized.

⁴⁾The system does not play files encoded with Lossless, etc.

Note

- Some files may not play depending on the format, the encoding, or recording condition.
- Some files edited on a PC may not play.

- The system can recognize the following files or folders in BDs, DVDs, CDs and USB devices:
 - up to folders in the 5th tree
 - up to 500 files in a single tree
- Some USB devices may not work with this system.
- The system can recognize Mass Storage Class (MSC) devices (such as flash memory or an HDD) that are FAT-compatible and non-partitioned, Still Image Capture Devices (SICDs), and 101-key keyboards (front  (USB) port only).
- To avoid data corruption or damage to USB memory or other devices, turn the system off before connecting or removing USB memory or other devices.
- The system may not play high bit rate video files from a DATA CD smoothly. It is recommended to play high bit rate video files using a DATA DVD.

Supported Audio Formats

Audio formats supported by this system are as follows.

Function	Format							
	LPCM 2ch	LPCM 5.1ch, LPCM 7.1ch	Dolby Digital	Dolby TrueHD, Dolby Digital Plus	DTS	DTS-ES Discrete 6.1, DTS-ES Matrix 6.1, DTS96/24	DTS-HD High Resolution Audio	DTS-HD Master Audio
"BD/DVD"	○	○	○	○	○	○	○	○
"SAT/CABLE" "TV" (DIGITAL IN)	○	-	○	-	○	-	-	-

○: Supported format.

-: Unsupported format.

Video Output Resolution

Output resolution differs depending on the [Output Video Format] setting in [Screen Settings] (page 51).

Resolution setting	When [Output Video Format] is set to [HDMI]			When [Output Video Format] is set to [Component Video]		
	VIDEO OUT jack	COMPONENT VIDEO OUT jacks	HDMI OUT jack	VIDEO OUT jack	COMPONENT VIDEO OUT jacks	HDMI OUT jack
480i/576i	480i/576i	480i/576i	480i/576i	480i/576i	480i/576i	480i/576i
480p/576p	480i/576i	480p/576p	480p/576p	480i/576i	480p/576p	480p/576p
720p	480i/576i	720p*	720p	480i/576i	720p*	720p
1080i	480i/576i	1080i*	1080i	480i/576i	1080i*	1080i
1080p	480i/576i	1080i*	1080p	unselectable	unselectable	unselectable

* Protected contents on DVDs are output at 480p/576p resolution.

When [Output Video Format] is set to [Video]

480i/576i video signals are output from the VIDEO OUT or COMPONENT VIDEO OUT jack, and 480p/576p video signals are output from the HDMI OUT jack.

Specifications

Amplifier Section

BDV-E870:

POWER OUTPUT (rated)

Front L/Front R: 108 W + 108 W (at 3 ohms, 1 kHz, 1% THD)

POWER OUTPUT (reference)

Front L/Front R/Center/Surround L/Surround R: 167 W (per channel at 3 ohms, 1 kHz)

Subwoofer: 165 W (at 3 ohms, 80 Hz)

BDV-E370:

POWER OUTPUT (rated)

Front L/Front R: 108 W + 108 W (at 3 ohms, 1 kHz, 1% THD)

POWER OUTPUT (reference)

Front L/Front R/Center/Surround L/Surround R: 142 W (per channel at 3 ohms, 1 kHz)

Subwoofer: 140 W (at 3 ohms, 80 Hz)

Inputs (Analog)

AUDIO (AUDIO IN) Sensitivity: 450/250 mV

Inputs (Digital)

SAT/CABLE (COAXIAL), TV (OPTICAL)

Supported formats: LPCM 2CH (up to 48 kHz), Dolby Digital, DTS

Video Section

Outputs

VIDEO: 1 V_{p-p} 75 ohms
COMPONENT:
Y: 1 V_{p-p} 75 ohms
P_B/C_B, P_R/C_R: 0.7 V_{p-p} 75 ohms
HDMI OUT: Type A (19 pin)

BD/DVD/Super Audio CD/CD System

Signal format system PAL/NTSC

USB Section

↳ (USB) port: Type A (For connecting USB memory, memory card reader, digital still camera, and digital video camera)

Maximum current: 500 mA

LAN Section

LAN (100) terminal 100BASE-TX Terminal

Tuner Section

System PLL quartz-locked digital synthesizer

FM tuner section

Tuning range 87.5 MHz - 108.0 MHz (50 kHz step)

Antenna (aerial) FM wire antenna (aerial)

Antenna (aerial) terminals 75 ohms, unbalanced

Intermediate frequency 10.7 MHz

Speakers

Front/Surround (SS-TSB101) for BDV-E370

Surround (SS-TSB101) for BDV-E870

Speaker system Full range Bass reflex
Speaker unit 55 mm × 80 mm cone type
Rated impedance 3 ohms
Dimensions (approx.) 75 mm × 225 mm × 71 mm (w/h/d)
Mass (approx.) 0.45 kg

Front (SS-TSB104) for BDV-E870

Speaker system Full range Bass reflex
Speaker unit 55 mm × 80 mm cone type
Rated impedance 3 ohms
Dimensions (approx.) 75 mm × 610 mm × 70 mm (w/h/d) (wall-mounted part)
251 mm × 1,205 mm × 251 mm (w/h/d) (whole speaker)
Mass (approx.) 0.9 kg (wall-mounted part)
2.7 kg (whole speaker)

Center (SS-CTB101)

Speaker system Full range Acoustic suspension, Magnetically Shielded
Speaker unit 30 mm × 60 mm cone type
Rated impedance 3 ohms
Dimensions (approx.) 290 mm × 49 mm × 49 mm (w/h/d)
Mass (approx.) 0.28 kg

Subwoofer (SS-WSB101)

Speaker system Subwoofer Bass reflex
Speaker unit 160 mm cone type
Rated impedance 3 ohms
Dimensions (approx.) 260 mm × 320 mm × 260 mm (w/h/d)
Mass (approx.) 5.2 kg

General

Power requirements

Taiwan models: 120 V AC, 50/60 Hz

Other models: 220 V - 240 V AC, 50/60 Hz

Power consumption On: 170 W
Standby: 0.3 W (at the Power Saving mode)

Dimensions (approx.)	430 mm × 85 mm × 335 mm (w/h/d) incl. projecting parts
Mass (approx.)	4.8 kg

Design and specifications are subject to change without notice.

- Standby power consumption 0.3 W.
- Halogenated flame retardants are not used in the certain printed wiring boards.
- Over 85% power efficiency of amplifier block is achieved with the full digital amplifier, S-Master.



Language Code List

The language spellings conform to the ISO 639: 1988 (E/F) standard.

Code Language	Code Language	Code Language	Code Language
1027	Afar	1183	Irish
1028	Abkhazian	1186	Scots Gaelic
1032	Afrikaans	1194	Galician
1039	Amharic	1196	Guarani
1044	Arabic	1203	Gujarati
1045	Assamese	1209	Hausa
1051	Aymara	1217	Hindi
1052	Azerbaijani	1226	Croatian
1053	Bashkir	1229	Hungarian
1057	Byelorussian	1233	Armenian
1059	Bulgarian	1235	Interlingua
1060	Bihari	1239	Interlingue
1061	Bislama	1245	Inupiak
1066	Bengali;	1248	Indonesian
	Bangla	1253	Icelandic
1067	Tibetan	1254	Italian
1070	Breton	1257	Hebrew
1079	Catalan	1261	Japanese
1093	Corsican	1269	Yiddish
1097	Czech	1283	Javanese
1103	Welsh	1287	Georgian
1105	Danish	1297	Kazakh
1109	German	1298	Greenlandic
1130	Bhutani	1299	Cambodian
1142	Greek	1300	Kannada
1144	English	1301	Korean
1145	Esperanto	1305	Kashmiri
1149	Spanish	1307	Kurdish
1150	Estonian	1311	Kirghiz
1151	Basque	1313	Latin
1157	Persian	1326	Lingala
1165	Finnish	1327	Laothian
1166	Fiji	1332	Lithuanian
1171	Faroese	1334	Latvian; Lettish
1174	French	1345	Malagasy
1181	Frisian		
1347	Maori	1349	Macedonian
1350	Malayalam	1352	Mongolian
1353	Moldavian	1353	Moldavian
1356	Marathi	1356	Marathi
1357	Malay	1357	Malay
1358	Maltese	1358	Maltese
1363	Burmese	1363	Burmese
1365	Nauru	1365	Nauru
1369	Nepali	1369	Nepali
1376	Dutch	1376	Dutch
1379	Norwegian	1379	Norwegian
1393	Occitan	1393	Occitan
1403	(Afan)Oromo	1403	(Afan)Oromo
1408	Oriya	1408	Oriya
1417	Punjabi	1417	Punjabi
1428	Polish	1428	Polish
1435	Pashto; Pushto	1435	Pashto; Pushto
1436	Portuguese	1436	Portuguese
1463	Quechua	1463	Quechua
1481	Rhaeto-	1481	Rhaeto-
	Romance		Romance
1482	Kirundi	1482	Kirundi
1483	Romanian	1483	Romanian
1489	Russian	1489	Russian
1491	Kinyarwanda	1491	Kinyarwanda
1495	Sanskrit	1495	Sanskrit
1498	Sindhi	1498	Sindhi
1501	Sangho	1501	Sangho
1502	Serbo-Croatian	1502	Serbo-Croatian
1503	Singhalese	1503	Singhalese
1505	Slovak	1505	Slovak
1506	Slovenian	1506	Slovenian
1507	Samoaan	1507	Samoaan
1508	Shona	1508	Shona
1509	Somali	1509	Somali
1511	Albanian	1511	Albanian
1512	Serbian	1512	Serbian
1513	Siswati	1513	Siswati
1514	Sesotho	1514	Sesotho
1515	Sundanese	1515	Sundanese
1516	Swedish	1516	Swedish
1517	Swahili	1517	Swahili
1521	Tamil	1521	Tamil
1525	Telugu	1525	Telugu
1527	Tajik	1527	Tajik
1528	Thai	1528	Thai
1529	Tigrinya	1529	Tigrinya
1531	Turkmen	1531	Turkmen
1532	Tagalog	1532	Tagalog
1534	Setswana	1534	Setswana
1535	Tonga	1535	Tonga
1538	Turkish	1538	Turkish
1539	Tsonga	1539	Tsonga
1540	Tatar	1540	Tatar
1543	Twí	1543	Twí
1557	Ukrainian	1557	Ukrainian
1564	Urdu	1564	Urdu
1572	Uzbek	1572	Uzbek
1581	Vietnamese	1581	Vietnamese
1587	Volapük	1587	Volapük
1613	Wolof	1613	Wolof
1632	Xhosa	1632	Xhosa
1665	Yoruba	1665	Yoruba
1684	Chinese	1684	Chinese
1697	Zulu	1697	Zulu
1703	Not specified		

Parental Control/Area Code List

Code Area	Code Area	Code Area	Code Area
2044	Argentina	2109	Germany
2047	Australia	2200	Greece
2046	Austria	2219	Hong Kong
2057	Belgium	2248	India
2070	Brazil	2238	Indonesia
2090	Chile	2239	Ireland
2092	China	2254	Italy
2093	Colombia	2276	Japan
2115	Denmark	2304	Korea
2165	Finland	2333	Luxembourg
2174	France	2363	Malaysia
		2362	Mexico
2376	Netherlands	2376	Netherlands
2390	New Zealand	2390	New Zealand
2379	Norway	2379	Norway
2427	Pakistan	2427	Pakistan
2424	Philippines	2424	Philippines
2428	Poland	2428	Poland
2436	Portugal	2436	Portugal
2489	Russia	2489	Russia
2501	Singapore	2501	Singapore
2149	Spain	2149	Spain
2499	Sweden	2499	Sweden
2086	Switzerland	2086	Switzerland
2543	Taiwan	2543	Taiwan
2528	Thailand	2528	Thailand
2184	United Kingdom	2184	United Kingdom

Glossary

AVCHD

The AVCHD format is a high-definition digital video camera format used to record SD (standard definition) or HD (high definition) signals of either the 1080i specification* or the 720p specification** on DVDs, using efficient data compression coding technology. The MPEG-4 AVC/H.264 format is adopted to compress video data, and the Dolby Digital or Linear PCM system is used to compress audio data. The MPEG-4 AVC/H.264 format is capable of compressing images at higher efficiency than that of the conventional image compression format. The MPEG-4 AVC/H.264 format enables a high definition (HD) video signal shot on a digital video camera recorder to be recorded on DVD discs in the same way as it would be for a standard definition (SD) television signal.

* A high definition specification that utilizes 1080 effective scanning lines and the interlace format.

** A high definition specification that utilizes 720 effective scanning lines and the progressive format.

BD-J application

The BD-ROM format supports Java for interactive functions. “BD-J” offers content providers almost unlimited functionality when creating interactive BD-ROM titles.

BD-R

BD-R (Blu-ray Disc Recordable) is a recordable, write-once Blu-ray Disc, available in the same capacities as the BD below. Since contents can be recorded and cannot be overwritten, a BD-R can be used to archive valuable data or store and distribute video material.

BD-RE

BD-RE (Blu-ray Disc Rewritable) is a recordable and rewritable Blu-ray Disc, available in the same capacities as the BD below. The re-recordable feature makes extensive editing and time-shifting applications possible.

BD-ROM

BD-ROMs (Blu-ray Disc Read-Only Memory) are commercially produced discs and are available in the same capacities as the BD below. Other than conventional movie and video contents, these discs have enhanced features such as interactive content, menu operations using pop-up menus, selection of subtitle display, and slideshow. Although a BD-ROM may contain any form of data, most BD-ROM discs will contain movies in High Definition format, for playback on Blu-ray Disc/DVD players.

Blu-ray Disc (BD)

A disc format developed for recording/playing high-definition (HD) video (for HDTV, etc.), and for storing large amounts of data. A single layer Blu-ray Disc holds up to 25 GB, and a dual-layer Blu-ray Disc holds up to 50 GB of data.

Digital Cinema Auto Calibration (D.C.A.C)

Digital Cinema Auto Calibration was developed by Sony to automatically measure and adjust the speaker settings to your listening environment in a short period of time.

Dolby Digital

This movie theater sound format is more advanced than Dolby Surround Pro Logic. In this format, the surround speakers output stereo sound with an expanded frequency range, and a subwoofer channel for deep bass is independently provided. This format is also called “5.1” with the subwoofer channel designed as the 0.1 channel (since it functions only when a deep bass effect is needed). All six channels in this format are recorded separately for superior channel separation. Furthermore, since all the signals are processed digitally, less signal degradation occurs.

Dolby Digital Plus

Developed as an extension to Dolby Digital, the audio coding technology supports 7.1 multi-channel surround sound.

Dolby Pro Logic II

Dolby Pro Logic II creates five full-bandwidth output channels from 2 channel sources. This is done using an advanced, high-purity matrix surround decoder that extracts the spatial properties of the original recording without adding any new sounds or tonal colorations.

■ Movie mode

The Movie mode is for use with stereo television shows and all programs encoded in Dolby Surround. The result is enhanced sound field directionality that approaches the quality of discrete 5.1-channel sound.

Dolby Surround Pro Logic

As one method of decoding Dolby Surround, Dolby Surround Pro Logic produces four channels from 2 channel sound. Compared with the former Dolby Surround system, Dolby Surround Pro Logic reproduces left-to-right panning more naturally and localizes sounds more precisely. To take full advantage of Dolby Surround Pro Logic, you should have one pair of surround speakers and a center speaker. The surround speakers output monaural sound.

Dolby TrueHD

Dolby TrueHD is a lossless coding technology that supports up to 8 channels of multi-channel surround sound for the next generation of optical discs. The reproduced sound is true to the original source bit-for-bit.

DTS

Digital audio compression technology developed by DTS, Inc. This technology conforms to 5.1-channel surround. This format includes a stereo rear channel and a discrete subwoofer channel. DTS provides the same 5.1 discrete channels of high quality digital audio. The good channel separation is realized due to the all channel data being recorded discretely and processed in digitally.

DTS-HD High Resolution Audio

Developed as an extension to DTS Digital Surround format. It supports a maximum sampling frequency of 96 kHz, and 7.1 multi-channel surround.

DTS-HD High Resolution Audio has a maximum transmission rate of 6 Mbps, with lossy compression.

DTS-HD Master Audio

DTS-HD Master Audio has a maximum transmission rate of 24.5 Mbps, and uses lossless compression, and DTS-HD Master Audio corresponds to a maximum sampling frequency of 192 kHz, and maximum of 7.1ch.

HDMI (High-Definition Multimedia Interface)

HDMI is an interface that supports both video and audio on a single digital connection, allowing you to enjoy high quality digital picture and sound. The HDMI specification supports HDCP (High-bandwidth Digital Content Protection), a copy protection technology that incorporates coding technology for digital video signals.

Interlace format (Interlaced scanning)

The Interlace format is the NTSC standard method for displaying TV images at 30 frames per second. Each frame is scanned twice - alternately between the even numbered scanning lines and then odd numbered scanning lines, at 60 times per second.

LTH (Low to High)

LTH is a recording system that supports organic pigment type BD-R.

Parental Control

A function of the BD/DVD to limit playback of the disc by the age of the users according to the limitation level in each country. The limitation varies from disc to disc; when it is activated, playback is completely prohibited, violent scenes are skipped or replaced with other scenes and so on.

PhotoTV HD

“PhotoTV HD” allows for highly-detailed pictures, and photo-like expression of subtle textures and colors. By connecting Sony “PhotoTV HD” compatible devices using an HDMI cable, a whole new world of photos can be enjoyed in breathtaking Full HD quality. For instance, the delicate texture of the human skin, flowers, sand and waves can now be displayed on a large screen in beautiful photo-like quality.

Pop-up menu

An enhanced menu operation available on BD-ROMs. The pop-up menu appears when POP UP/MENU is pressed during playback, and can be operated while playback is in progress.

**Progressive format
(sequential scanning)**

In contrast to the Interlace format, the progressive format can reproduce 50 - 60 frames per second by reproducing all scanning lines (525 lines for the NTSC system). The overall picture quality increases and still images, text and horizontal lines appear sharper. This format is compatible with the 525 or 625 progressive format.

**S-AIR
(Sony Audio Interactive Radio
frequency)**

Recent times have seen the rapid spread of BD/DVD media, digital broadcasting, and other high-quality media.

To ensure that the subtle nuances of these high-quality media are transmitted with no deterioration, Sony has developed a technology called "S-AIR" for the radio transmission of digital audio signals with no compression, and has incorporated this technology into the EZW-RT10/EZW-RT10A/EZW-T100.

This technology transfers digital audio signals with no compression using the 2.4 GHz band range of ISM band (Industrial, Scientific, and Medical band), such as wireless LANs and Bluetooth applications.

24p True Cinema

Movies shot with a film camera consist of 24 frames per second.

Since conventional televisions (both CRT and flat panels) display frames either at 1/60 or 1/50 second intervals, the 24 frames do not appear at an even pace.

When connected to a TV with 24p capabilities, the player displays each frame at 1/24 second intervals — the same interval originally shot with the film camera, thus faithfully reproducing the original cinema image.

Index

Numerics

24p True Cinema 73

A

A/V SYNC 33
Attenuate - AUDIO 52
Audio 52
Audio DRC 52
Audio Output 52
Audio Return Channel 54
Audio Settings 52
Auto Calibration 46, 52
Auto Display 54
Auto Standby 54
AVCHD 71

B

BD Audio MIX Setting 52
BD Data Storage Options 53
BD Hybrid Disc Playback
Layer 53
BD Internet Connection 53
BD Parental Control 53
BD Remote Device
Registration 55
BD/DVD Menu 52
BD/DVD Viewing Settings 52
BD/DVD-ROM 1080/24p
Output 51
BD-LIVE 29
BD-R 71
BD-RE 71
Blu-ray Disc 71
BONUSVIEW 29
BRAVIA Internet Video 31

C

CD 65
Child Lock 49
Cinema Conversion Mode 51
Control for HDMI 44, 54

D

D. C. A. C. (Digital Cinema
Auto Calibration) 46, 71
D.BASS 36
Dimmer 54
DivX® VOD 55
Dolby Digital 34, 71
Dolby Digital Plus 71
Dolby Pro Logic II 72

Dolby Surround Pro Logic 72
Dolby TrueHD 72
DTS 34, 72
DTS-HD 72
DVD 65
DVD Aspect Ratio 51
DVD Parental Control 53

E

Easy Setup 25, 55

F

FM MODE 37
Front panel 8
Front panel display 9

G

Gracenote Settings 55

H

HDMI
YCbCr/RGB (HDMI) 51
HDMI (High-Definition
Multimedia Interface) 72
HDMI Deep Colour Output 51

I

Initialize Personal Information
55
Interlace format 72
Internal memory 62
Internet content 31
Internet Settings 55
Internet Video Parental Control
53
Internet Video Unrated 53

L

Language Code List 70
LTH 72

M

Multiplex broadcast sound 35
Music Settings 53

N

Network Connection
Diagnostics 55
Network Settings 55
Network Update 50
NIGHT MODE 36

O

OSD 54
Output Video Format 51

P

Parental Control 72
Parental Control Area Code 53
Parental Control Settings 53
Password 53
Pause Mode 51
PhotoTV HD 72
Play information 29
Playable discs 65
Progressive format 73

Q

Quick Start Mode 54

R

RDS 38
Rear panel 10
Region code 65
Registered BD Remote Devices
55
Remote control 11
Reset to Factory Default
Settings 55
Resetting 55

S

S-AIR 39, 73
Mode 41
Pairing 42
RF Change 42
S-AIR receiver 39
Standby 41
S-AIR Settings 54
Screen Format 51
Screen Saver 54
Screen Settings 51
SLEEP 49
Slideshow 33
Sound Effect 52
Speaker Settings 47, 52
Connection 47
Distance 47
Level 48
Subtitle 53
Super Audio CD Playback
Channels 53

Super Audio CD Playback
Layer 53
Surround amplifier 39
System Information 55
SYSTEM MENU 27, 33, 35,
36

T

Test Tone 48
TV Type 51

U

Update 50
USB 30

W

WEP 24
WPA2-PSK (AES) 24
WPA2-PSK (TKIP) 24
WPA-PSK (AES) 24
WPA-PSK (TKIP) 24

The software of this system may be updated in the future. To find out details on any available updates, please visit the following URL.

For customers in Europe and Russia: <http://support.sony-europe.com/>

For customers in Asia and Australia: <http://www.sony-asia.com/support>

HDMI

BD-LIVE™

**DVD
VIDEO™**

CD-R-D-S

SUPER AUDIO CD

**COMPACT
disc
DIGITAL AUDIO**

**DOLBY
TRUEHD**

**dts-HD™
Master Audio**

**Java
POWERED**

<http://www.sony.net/>



Free Manuals Download Website

<http://myh66.com>

<http://usermanuals.us>

<http://www.somanuals.com>

<http://www.4manuals.cc>

<http://www.manual-lib.com>

<http://www.404manual.com>

<http://www.luxmanual.com>

<http://aubethermostatmanual.com>

Golf course search by state

<http://golfingnear.com>

Email search by domain

<http://emailbydomain.com>

Auto manuals search

<http://auto.somanuals.com>

TV manuals search

<http://tv.somanuals.com>