

DVD Home Theatre System

Operating Instructions



MP3

DAV-DZ10

WARNING

To reduce the risk of fire or electric shock, do not expose this apparatus to rain or moisture.

Do not install the appliance in a confined space, such as a bookcase or built-in cabinet.

To prevent fire, do not cover the ventilation of the apparatus with news papers, table-cloths, curtains, etc. And don't place lighted candles on the apparatus.

To prevent fire or shock hazard, do not place objects filled with liquids, such as vases, on the apparatus.



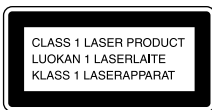

Don't throw away the battery with general house waste, dispose of it correctly as chemical waste.



This appliance is classified as a CLASS 1 LASER product. This marking is located on the rear of the unit.

NOTICE FOR THE CUSTOMERS IN THE UNITED KINGDOM

A moulded plug complying with BS1363 is fitted to this equipment for your safety and convenience.

Should the fuse in the plug supplied need to be replaced, a fuse of the same rating as the supplied one and approved by ASTA or BSI to BS1362, (i.e., marked with mark  or  mark) must be used.

If the plug supplied with this equipment has a detachable fuse cover, be sure to attach the fuse cover after you change the fuse. Never use the plug without the fuse cover.

If you should lose the fuse cover, please contact your nearest Sony service station.

Precautions

Safety

- If anything falls into the cabinet, unplug the unit and have it checked by qualified personnel before operating it any further.
- The unit is not disconnected from the AC power source (mains) as long as it is connected to the wall outlet (mains), even if the unit itself has been turned off.
- Unplug the unit from the wall outlet if you do not intend to use it for an extended period of time. To disconnect the cord, pull it out by the plug, never by the cord.

Installing

- Allow adequate air circulation to prevent internal heat buildup.
- Do not place the unit on surfaces (rugs, blankets, etc.) or near materials (curtains, draperies) that may block the ventilation slots.
- Do not install the unit near heat sources such as radiators, or air ducts, or in a place subject to direct sunlight, excessive dust, mechanical vibration, or shock.
- Do not install the unit in an inclined position. It is designed to be operated in a horizontal position only.
- Keep the unit and discs away from equipment with strong magnets, such as microwave ovens, or large loudspeakers.
- Do not place heavy objects on the unit.
- If the unit is brought directly from a cold to a warm location, moisture may condense inside the DVD Home Theatre System and cause damage to the lenses. When you first install the unit, or when you move it from a cold to a warm location, wait for about 30 minutes before operating the unit.



Disposal of Old Electrical & Electronic Equipment (Applicable in the European Union and other European countries with separate collection systems)

 This symbol on the product or on its packaging indicates that this product shall not be treated as household waste. Instead it shall be handed over to the applicable collection point for the recycling of electrical and electronic equipment. By ensuring this product is disposed of correctly, you will help prevent potential negative consequences for the environment and human health, which could otherwise be caused by inappropriate waste handling of this product. The recycling of materials will help to conserve natural resources. For more detailed information about recycling of this product, please contact your local Civic Office, your household waste disposal service or the shop where you purchased the product.

Welcome!

Thank you for purchasing Sony DVD Home Theatre System. Before operating this system, please read this manual thoroughly and retain it for future reference.

Table of Contents

Welcome!	3
About This Manual	6
This System Can Play the Following Discs	6
Guide to the Control Menu Display	9

Getting Started

Unpacking	12
Inserting Batteries into the Remote	12
Hookup Overview	13
Step 1: Speaker System Hookup	14
Step 2: Antenna (Aerial) Hookup	18
Step 3: TV Hookup	19
Step 4: Connecting the AC Power Cord (Mains Lead)	20
Step 5: Turning off the Demonstration	20
Step 6: Performing the Quick Setup	21
Speaker Setup	23

Playing Discs

Playing Discs	24
Using the DVD's Menu	28
Selecting [ORIGINAL] or [PLAY LIST] on a DVD-RW	29
Playing VIDEO CDs with PBC Functions (Ver.2.0)	29
(PBC Playback)	
About MP3 Audio Tracks and JPEG Image Files	30
Playing DATA CDs with MP3 Audio Tracks and JPEG Image Files	32
Playing Audio Tracks and Images as a Slide Show with Sound	34
Enjoying DivX® Videos	36
(Except for the United Kingdom models)	
Adjusting the Delay Between the Picture and Sound	38
(A/V SYNC)	
Searching for a Particular Point on a Disc	38
(Scan, Slow-motion Play, Freeze Frame)	

Searching for a Title/Chapter/Track/ Scene, etc.	40
Searching by Scene	41
(Picture Navigation)	
Viewing Information About the Disc	42

Sound Adjustments

Changing the Sound	46
Enjoying Surround Sound by Using Sound Field	48
Using the Sound Effect	50

Using Various Additional Functions

Changing the Angles	51
Displaying the Subtitles	51
Locking Discs	52
(CUSTOM PARENTAL CONTROL, PARENTAL CONTROL)	

Other Operations

Controlling the TV with the Supplied Remote	56
Using the THEATRE SYNC Function	57
Enjoying the Radio	58
Using the Radio Data System (RDS) ...	60
Using the Sleep Timer	61
Changing the Brightness of the Front Panel Display	61
Returning to the Default Settings	62

Settings and Adjustments







Using the Setup Display	63
Setting the Display or Sound Track Language	64
[LANGUAGE SETUP]	
Settings for the Display	65
[SCREEN SETUP]	
Custom Settings	66
[CUSTOM SETUP]	
Settings for the Speakers	67
[SPEAKER SETUP]	

Additional Information

Precautions	70
Notes about the Discs	71
Troubleshooting	71
Self-diagnosis Function	74
(When letters/numbers appear in the display)	
Specifications	75
Glossary	76
Language Code List	78
Index to Parts and Controls	79
DVD Setup Display List	83
AMP Menu List	84
Index	85

About This Manual

- The instructions in this manual describe the controls on the remote. You can also use the controls on the system if they have the same or similar names as those on the remote.
- The Control Menu items may be different depending on the area.
- “DVD” may be used as a general term for DVD VIDEOS, DVD+RWs/DVD+Rs, and DVD-RWs/DVD-Rs.
- Measurements are expressed in feet (ft) for North American models.
- The following symbols are used in this manual.

Symbol	Meaning
	Functions available for DVD VIDEOS, DVD-Rs/DVD-RWs in video mode, and DVD+Rs/DVD+RWs
	Functions available for DVD-RWs in VR (Video Recording) mode
	Functions available for VIDEO CDs (including Super VCDs or CD-Rs/CD-RWs in video CD format or Super VCD format)
	Functions available for music CDs or CD-Rs/CD-RWs in music CD format
	Functions available for DATA CDs (CD-ROMs/CD-Rs/CD-RWs containing MP3* ¹ audio tracks, JPEG image files, and DivX* ² * ³ video files)
	Functions available for DATA DVDs (DVD-Rs/DVD-RWs/DVD+Rs/DVD+RWs) containing DivX* ² * ³ * ⁴ video files









*1 MP3 (MPEG1 Audio Layer 3) is a standard format defined by ISO/MPEG which compresses audio data.

*2 DivX[®] is a video file compression technology, developed by DivX, Inc.

*3 DivX, DivX Certified, and associated logos are trademarks of DivX, Inc. and are used under license.

*4 Except for the United Kingdom models.

This System Can Play the Following Discs

Format of discs	Disc logo
DVD VIDEO	
DVD-RW	
VIDEO CD	
Audio CD	
CD-R/CD-RW (audio data) (MP3 files) (JPEG files)	   

The “DVD VIDEO” logo and “DVD-RW” logo are trademarks.

Note about CDs/DVDs

The system can play CD-ROMs/CD-Rs/CD-RWs recorded in the following formats:

- audio CD format
- video CD format
- MP3 audio tracks, JPEG image files, and DivX video files* of format conforming to ISO 9660 Level 1/Level 2, or its extended format, Joliet

The system can play DVD-ROMs/DVD+RWs/DVD-RWs/DVD+Rs/DVD-Rs recorded in the following formats:

- DivX video files* of format conforming to UDF.

* Except for the United Kingdom models.

Example of discs that the system cannot play

The system cannot play the following discs:

- CD-ROMs/CD-Rs/CD-RWs other than those recorded in the formats listed on page 6
- CD-ROMs recorded in PHOTO CD format
- Data part of CD-Extras
- DVD Audios
- Super Audio CD
- DVD-RAMs

Also, the system cannot play the following discs:

- A DVD VIDEO with a different region code (page 7, 77).
- A disc that has a non-standard shape (e.g., card, heart).
- A disc with paper or stickers on it.
- A disc that has the adhesive of cellophane tape or a sticker still left on it.

Notes about CD-R/CD-RW/DVD-R/DVD-RW/DVD+R/DVD+RW

In some cases, CD-R/CD-RW/DVD-R/DVD-RW/DVD+R/DVD+RW cannot be played on this system due to the recording quality or physical condition of the disc, or the characteristics of the recording device and authoring software.

The disc will not play if it has not been correctly finalized. For more information, see the operating instructions for the recording device.

Note that discs created in the Packet Write format cannot be played.

Music discs encoded with copyright protection technologies

This product is designed to play back discs that conform to the Compact Disc (CD) standard.

Recently, various music discs encoded with copyright protection technologies are marketed by some record companies. Please be aware that among those discs, there are some that do not conform to the CD standard and may not be playable by this product.

Note on DualDisc

A DualDisc is a two sided disc product which mates DVD recorded material on one side with digital audio material on the other side.

However, since the audio material side does not conform to the Compact Disc (CD) standard, playback on this product is not guaranteed.

Note on PBC (Playback Control) (VIDEO CDs)

This system conforms to Ver. 1.1 and Ver. 2.0 of VIDEO CD standards. You can enjoy two kinds of playback depending on the disc type.

Disc type	You can
VIDEO CDs without PBC functions (Ver. 1.1 discs)	Enjoy video playback (moving pictures) as well as music.
VIDEO CDs with PBC functions (Ver. 2.0 discs)	Play interactive software using menu screens displayed on the TV screen (PBC Playback), in addition to the video playback functions of Ver. 1.1 discs. Moreover, you can play high-resolution still pictures, if they are included on the disc.

About Multi Session CD

- This system can play Multi Session CDs when an MP3 audio track is contained in the first session. Any subsequent MP3 audio tracks recorded in later sessions can also be played back.
- This system can play Multi Session CDs when a JPEG image file is contained in the first session. Any subsequent JPEG image files recorded in later sessions can also be played back.
- If audio tracks and images in music CD format or video CD format are recorded in the first session, only the first session will be played back.

Region code

Your system has a region code printed on the back of the unit and will only play DVDs labeled with the same region code.

DVD VIDEOS labeled  will also play on this system.

continued

If you try to play any other DVD VIDEO, the message [Playback prohibited by area limitations.] will appear on the TV screen. Depending on the DVD VIDEO, no region code indication may be given even though playing the DVD VIDEO is prohibited by area restrictions.

Note on playback operations of DVDs and VIDEO CDs

Some playback operations of DVDs and VIDEO CDs may be intentionally set by software producers. Since this system plays DVDs and VIDEO CDs according to the disc contents the software producers designed, some playback features may not be available. Also, refer to the instructions supplied with the DVDs or VIDEO CDs.

Copyrights

This product incorporates copyright protection technology that is protected by U.S. patents and other intellectual property rights. Use of this copyright protection technology must be authorized by Macrovision, and is intended for home and other limited viewing uses only unless otherwise authorized by Macrovision. Reverse engineering or disassembly is prohibited.

This system incorporates with Dolby*¹ Digital and Dolby Pro Logic (II) adaptive matrix surround decoder and the DTS*² Digital Surround System.

*1 Manufactured under license from Dolby Laboratories.
“Dolby,” “Pro Logic,” and the double-D symbol are trademarks of Dolby Laboratories.

*2 Manufactured under license from Digital Theater Systems, Inc.
“DTS” and “DTS Digital Surround” are registered trademarks of Digital Theater Systems, Inc.

Guide to the Control Menu Display

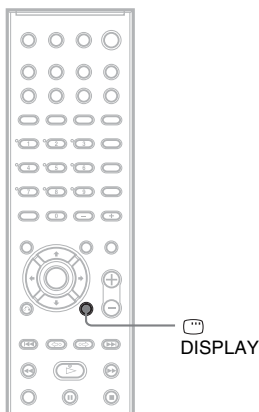

Use the Control Menu to select a function and to view related information. Press  DISPLAY repeatedly to turn on or change the Control Menu display as follows:

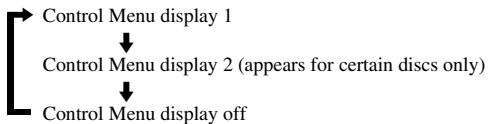

Control Menu display

The Control Menu display 1 and 2 will show different items depending on the disc type. For details about each item, see the pages in parentheses.

continued

Example: Control Menu display 1 when playing a DVD VIDEO.

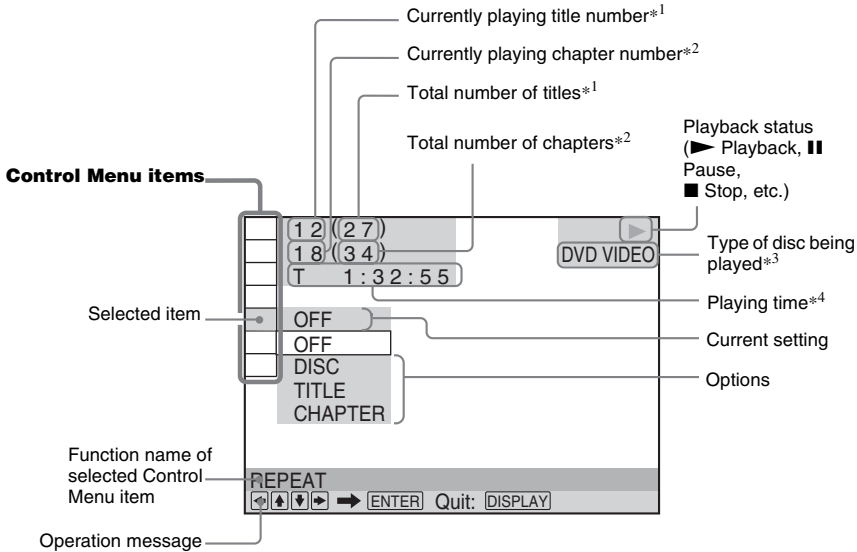













- *1 Displays the scene number for VIDEO CDs (PBC is on), track number for VIDEO CDs/CDs, album number for DATA CDs. DivX video album number for DATA DVDs/DATA CDs (except for the United Kingdom models).
- *2 Displays the index number for VIDEO CDs, MP3 audio track number, or JPEG image file number for DATA CDs. DivX video file number for DATA DVDs/DATA CDs (except for the United Kingdom models).
- *3 Displays Super VCD as "SVCD." Displays "MP3" in the Control Menu display 1 or "JPEG" in the Control Menu 2 for DATA CDs.
- *4 Displays the date for JPEG files.

To turn off the display

Press DISPLAY.

List of Control Menu items



Item	Item Name, Function, Relevant Disc Type
	[TITLE] (page 40)/[SCENE] (page 40)/[TRACK] (page 40) Selects the title, scene, or track to be played. DVD-V DVD-RW VIDEO CD
	[CHAPTER] (page 40)/[INDEX] (page 40) Selects the chapter or index to be played. DVD-V DVD-RW VIDEO CD
	[TRACK] (page 40) Selects the track to be played. C D DATA-CD
	[ORIGINAL/PLAY LIST] (page 29) Selects the type of titles (DVD-RW) to be played, the [ORIGINAL] one, or an edited [PLAY LIST]. DVD-RW
	[TIME/TEXT] (page 41) Checks the elapsed time and the remaining playback time. Input the time code for picture and music searching. Displays the DVD/CD text or the MP3 track name. DVD-V DVD-RW VIDEO CD C D DATA-CD DATA DVD

	[PROGRAM] (page 25) Selects the track to play in the order you want. VIDEO CD <input type="checkbox"/> C D <input type="checkbox"/>
	[SHUFFLE] (page 27) Plays the track in random order. VIDEO CD <input type="checkbox"/> C D <input type="checkbox"/>
	[REPEAT] (page 27) Plays the entire disc (all titles/all tracks/all albums) repeatedly or one title/chapter/track/ album repeatedly. DVD-V <input type="checkbox"/> DVD-RW <input type="checkbox"/> VIDEO CD <input type="checkbox"/> C D <input type="checkbox"/> DATA-CD <input type="checkbox"/> DATA DVD <input type="checkbox"/>
	[A/V SYNC] (page 38) Adjusts the delay between the picture and sound. DVD-V <input type="checkbox"/> DVD-RW <input type="checkbox"/> VIDEO CD <input type="checkbox"/> DATA-CD <input type="checkbox"/> DATA DVD <input type="checkbox"/>
	[PARENTAL CONTROL] (page 52) Sets to prohibit playback on this system. DVD-V <input type="checkbox"/> VIDEO CD <input type="checkbox"/> C D <input type="checkbox"/>
	[SETUP] (page 63) [QUICK] Setup (page 21) Use Quick Setup to choose the desired language of the on-screen display, the aspect ratio of the TV, and the size of the speakers you are using. [CUSTOM] Setup In addition to the Quick Setup setting, you can adjust various other settings. [RESET] Returns the settings in [SETUP] to the default setting. DVD-V <input type="checkbox"/> DVD-RW <input type="checkbox"/> VIDEO CD <input type="checkbox"/> C D <input type="checkbox"/> DATA-CD <input type="checkbox"/> DATA DVD <input type="checkbox"/>
	[ALBUM] (page 40) Selects the album to be played. DATA-CD <input type="checkbox"/> DATA DVD <input type="checkbox"/>
	[FILE] (page 40) Selects the JPEG image file or DivX video file* ¹ to be played. DATA-CD <input type="checkbox"/> DATA DVD <input type="checkbox"/>
 *2	[DATE] (page 45) Displays the date the picture was taken by a digital camera. DATA-CD <input type="checkbox"/>
 *2	[INTERVAL] (page 34) Specifies the duration for which the slides are displayed on the screen. DATA-CD <input type="checkbox"/>
 *2	[EFFECT] (page 35) Selects the effects to be used for changing slides during a slide show. DATA-CD <input type="checkbox"/>
 *2	[MODE (MP3, JPEG)] (page 34) Selects the data type; MP3 audio track [AUDIO], JPEG image file [IMAGE] or both [AUTO] to be played when playing a DATA CD. DATA-CD <input type="checkbox"/>

*1 Except for the United Kingdom models.

*2 These items are not displayed when playing a DATA CD with DivX video file.
(Except for the United Kingdom models)

Tip

- The Control Menu icon indicator lights up in green  →  when you select any item except [OFF] ([PROGRAM], [SHUFFLE], [REPEAT], [A/V SYNC] only). The [ORIGINAL/PLAY LIST] indicator lights up in green when you select [PLAY LIST] (default setting).

Getting Started

Unpacking

Check that you have the following items:

- Speakers (5)
- Subwoofer (1)
- AM loop antenna (aerial) (1)
- FM wire antenna (aerial) (1)
- Speaker cords (6)
- Remote Commander (remote) (1)
- Size AA (R6) batteries (2)
- Operating Instructions

Inserting Batteries into the Remote

You can control the system using the supplied remote. Insert two Size AA (R6) batteries by matching the ⊕ and ⊖ ends on the batteries to the markings inside the compartment. When using the remote, point it at the remote sensor  on the system.

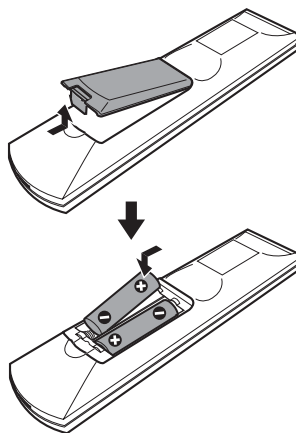

Note

- Do not leave the remote in an extremely hot or humid place.
- Do not use a new battery with an old one.
- Do not drop any foreign object into the remote casing, particularly when replacing the batteries.
- Do not expose the remote sensor to direct light from the sun or lighting apparatus. Doing so may cause a malfunction.
- If you do not intend to use the remote for an extended period of time, remove the batteries to avoid possible damage from battery leakage and corrosion.

Hookup Overview

Perform all connections and settings by following Steps 1 to 6.

“Step 1: Speaker System Hookup” (page 14)

“Step 2: Antenna (Aerial) Hookup” (page 18)

“Step 3: TV Hookup” (page 19)

“Step 4: Connecting the AC Power Cord (Mains Lead)” (page 20)

“Step 5: Turning off the Demonstration” (page 20)

“Step 6: Performing the Quick Setup” (page 21)

Video signal is sent to the TV, and is output from the TV screen; audio signals are processed by this system and output from the speakers of this system. You can also enjoy sound of other sources, such as TV programs, in addition to DVDs or CDs.

Step 1: Speaker System Hookup

Connect the supplied speaker system using the supplied speaker cords by matching the colors of the jacks to those of the cords. Do not connect any speakers other than those supplied with this system. To obtain the best possible surround sound, specify the speaker parameters (distance, level, etc.) on page 67.

Required cords

Speaker cords

The connector and the color tube of the speaker cords are the same color as the label of the jacks to be connected.

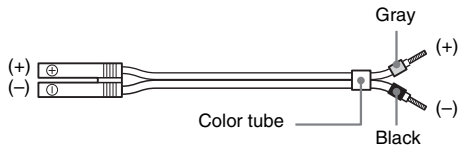

Connecting the speakers

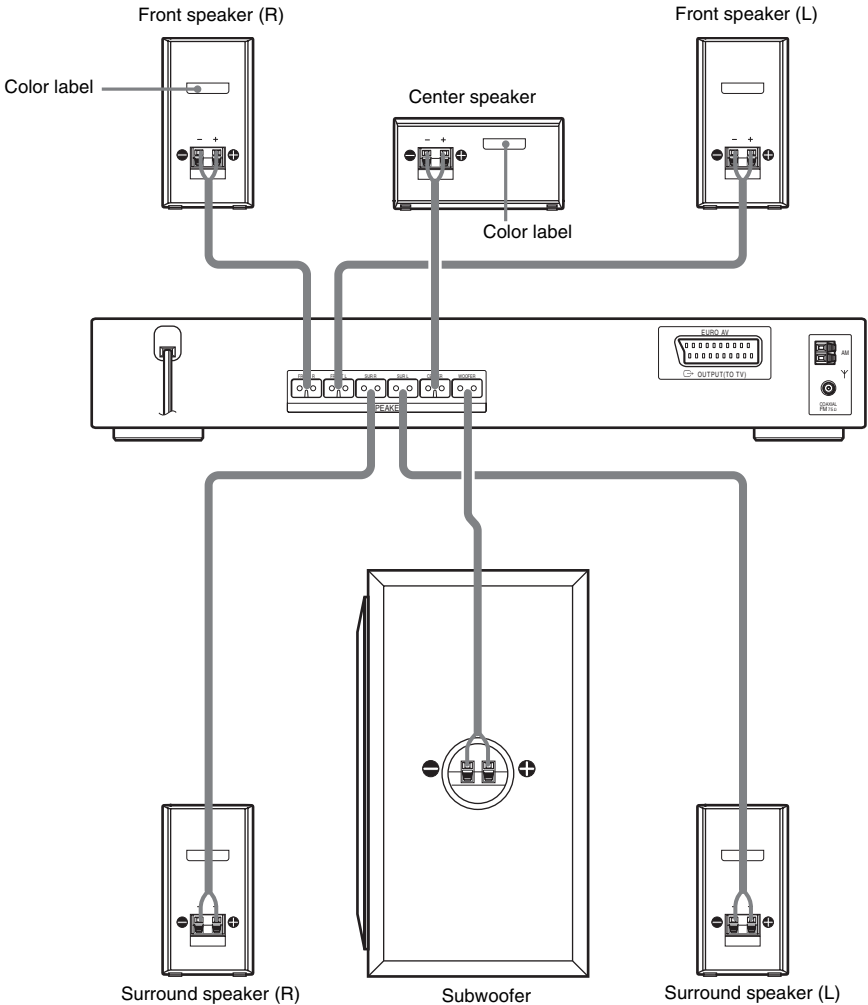

Note

- Do not set the speakers in an inclined position.
- Do not place the speakers in locations that are:
 - Extremely hot or cold
 - Dusty or dirty
 - Very humid
 - Subject to vibrations
 - Subject to direct sunlight
- Use caution when placing the speakers and/or speaker stands (not supplied) that are attached with the speakers on a specially treated (waxed, oiled, polished, etc.) floor, as staining or discoloration may result.

continued

- Do not use any type of abrasive pad, scouring powder, or solvent such as alcohol or benzine.

To connect the speaker cords

Connect the speaker cords after bending the bare wire at the end of the insulation. This prevents the speaker insulation from being inserted in the speaker terminal.

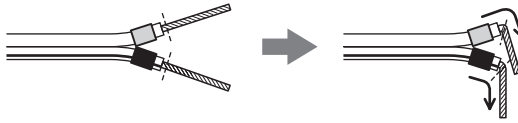

Note

- Do not catch the speaker cord insulation in the SPEAKER jack.

Avoiding short-circuiting the speakers

Short-circuiting of the speakers may damage the system. To prevent this, be sure to follow these precautions when connecting the speakers. Make sure the bare wire of each speaker cord does not touch another speaker terminal or the bare wire of another speaker cord.

Examples of poor conditions of the speaker cord

Stripped speaker cord is touching another speaker terminal.

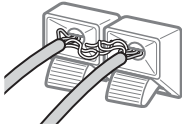

Stripped cords are touching each other due to excessive removal of insulation.

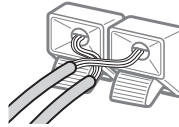

After connecting all the components, speakers, and AC power cord (mains lead), output a test tone to check that all the speakers are connected correctly. For details on outputting a test tone, see page 69. If no sound is heard from a speaker while outputting a test tone, or a test tone is output from a speaker other than the one currently displayed on the Setup Display, the speaker may be short-circuited. If this happens, check the speaker connection again.

Note

- Be sure to match the speaker cord to the appropriate terminal on the components: \oplus to \oplus , and \ominus to \ominus . If the cords are reversed, the sound will lack bass and may be distorted.

Installing the speakers on the wall

- 1 Prepare screws (not supplied) that are suitable for the hole on the back of each speaker. See the illustrations below.

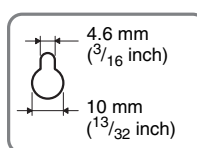
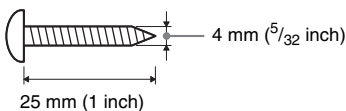

Hole on the back of the speaker

- 2 Fasten the screws to the wall.**
The screws should protrude 5 to 7 mm ($7/32$ to $9/32$ inch).

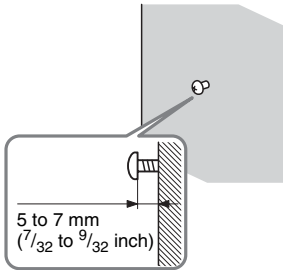

- 3 Hang the speakers on the screws.**

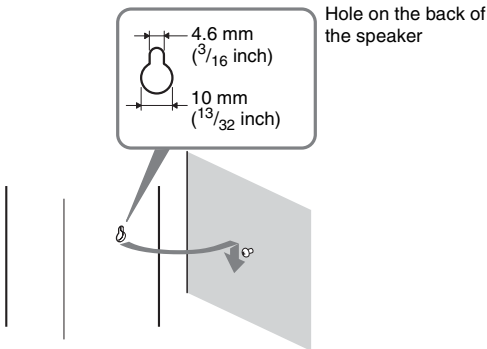

Note

- Use screws that are suitable for the wall material and strength. As a plaster board wall is especially fragile, attach the screws securely to a beam and fasten them to the wall. Install the speakers on a vertical and flat wall where reinforcement is applied.
- Contact a screw shop or installer regarding the wall material or screws to be used.
- Sony is not responsible for accident or damage caused by improper installation, insufficient wall strength or improper screw installation, natural calamity, etc.

Step 2: Antenna (Aerial) Hookup

Connect the supplied AM/FM antennas (aerials) for listening to the radio.

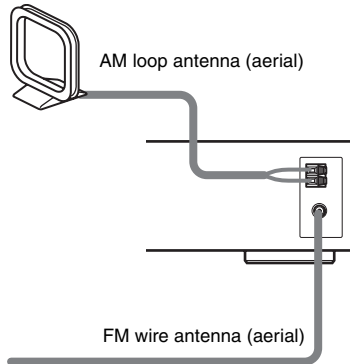

Note

- To prevent noise pickup, keep the AM loop antenna (aerial) away from the system and other components.
- Be sure to fully extend the FM wire antenna (aerial).
- After connecting the FM wire antenna (aerial), keep it as horizontal as possible.

Tip

- When you connect the supplied AM loop antenna (aerial), cord (A) or cord (B) can be connected to either terminal.

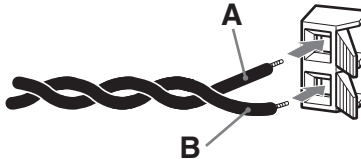

- If you have poor FM reception, use a 75-ohms coaxial cable (not supplied) to connect the system to an outdoor FM antenna (aerial) as shown below.

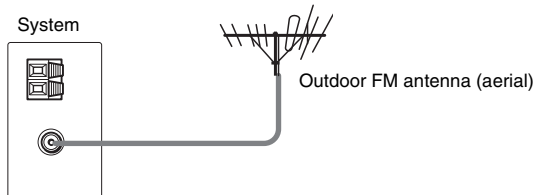

Step 3: TV Hookup

First, perform the video connection, and then audio connection.

With your TV's audio output connected to this system, you can listen to TV sound through the system speakers.

Connecting the video cords

Sends a played back DVD image to a TV.

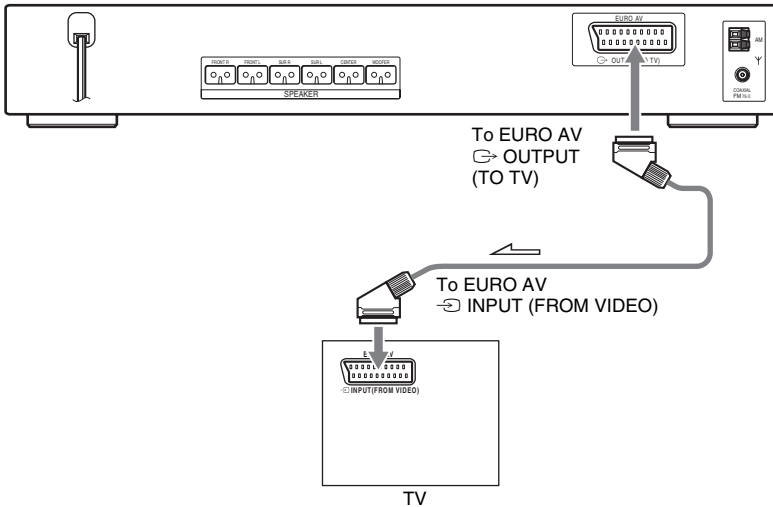

Connect the system to your TV using the SCART (EURO AV) cord.



Be sure to connect the SCART (EURO AV) cord to the EURO AV \rightarrow OUTPUT (TO TV) jack on the system.

When you connect using the SCART (EURO AV) cord, check that the TV conforms to S video or RGB signals. If the TV conforms to S video, change the input mode of the TV to RGB signals. Refer to the operating instructions supplied with the TV to be connected.

When connecting to a standard 4:3 screen TV

Depending on the disc, the image may not fit your TV screen.

To change the aspect ratio, see page 65.

Step 4: Connecting the AC Power Cord (Mains Lead)

Before connecting the AC power cord (mains lead) of this system to a wall outlet (mains), connect the speakers to the system (page 14). Install this system so that the power cord can be unplugged from the wall socket immediately in the event of trouble.

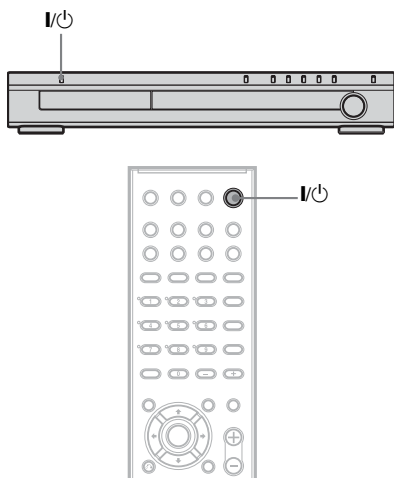

To turn on the system

Press I/⏻.

To turn off the system

Press I/⏻. The system enters standby mode. While playing a disc, do not turn off the system by pressing I/⏻. Doing so may cancel the menu settings. When you turn off the system, first press ■ to stop playback and then press I/⏻.

Step 5: Turning off the Demonstration

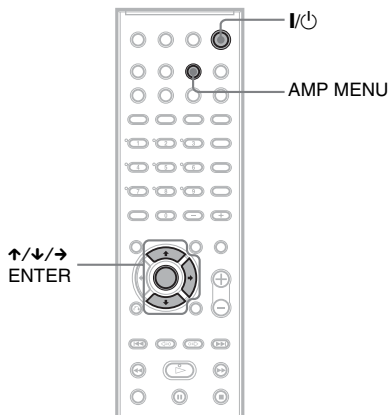

After connecting the AC power cord (mains lead), the demonstration appears in the front panel display. When you press I/⏻ on the remote, the demonstration turns off.

Note

- When you press I/⏻ on the system, the demonstration does not turn off.
- When you set the demonstration mode in the AMP menu to on, the demonstration does not turn off even though you press I/⏻ on the remote. To turn off the demonstration, set the demonstration mode to off, then press I/⏻ on the remote.

Setting the demonstration mode on/off

- 1 Press AMP MENU.**
- 2 Press ↕ repeatedly until “DEMO” appears in the front panel display, then press ENTER or →.**
- 3 Press ↕ to select the setting.**
 - DEMO OFF: sets the demonstration mode off.
 - DEMO ON: sets the demonstration mode on.
- 4 Press ENTER or AMP MENU.**

The AMP menu turns off.

Step 6: Performing the Quick Setup

Follow the steps below to make the minimum number of basic adjustments for using the system.

To skip an adjustment, press **▶▶**. To return to the previous adjustment, press **◀◀**.

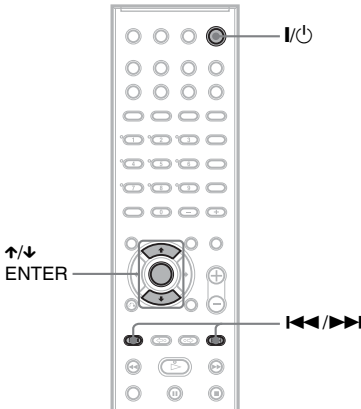

1 Turn on the TV.

2 Press I/O.

Note

- Make sure that the function is set to "DVD."

3 Switch the input selector on your TV so that the signal from the system appears on the TV screen.

[Press [ENTER] to run QUICK SETUP.] appears at the bottom of the screen. If this message does not appear, display the Quick Setup and perform again (page 22).

4 Press ENTER without inserting a disc.

The Setup Display for selecting the language used in the on-screen display appears.

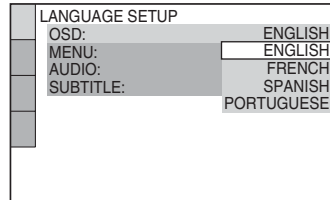

5 Press ↑/↓ to select a language.

The system displays the menu and subtitles in the selected language.

Note

- The selectable language is different depending on the area.

6 Press ENTER.

The Setup Display for selecting the aspect ratio of the TV to be connected appears.

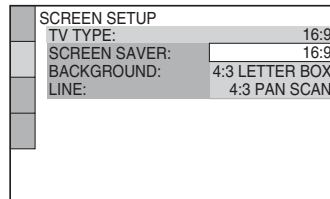

7 Press ↑/↓ to select the setting that matches your TV type.

■ **If you have a 4:3 standard TV**
[4:3 LETTER BOX] or [4:3 PAN SCAN]
(page 65)

■ **If you have a wide-screen TV or a 4:3 standard TV with a wide-screen mode**
[16:9] (page 65)

8 Press ENTER.

The Setup Display for selecting the output method for video signals from the EURO AV  OUTPUT (TO TV) jack on the rear panel of the system appears.

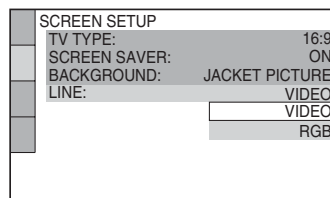

continued

9 Press \uparrow/\downarrow to select the output method for video signals.

- [VIDEO]: outputs video signals.
- [RGB]: outputs RGB signals.

Note

- If your TV does not accept RGB signals, no picture appears on the TV screen even if you select [RGB]. Refer to the instructions supplied with your TV.

10 Press ENTER.

The Setup Display for selecting the speaker distance appears.

11 Press \uparrow/\downarrow to select the front speaker distance from the listening position, then press ENTER.

You can set from 1.0 to 7.0 meters (4 to 23 ft).

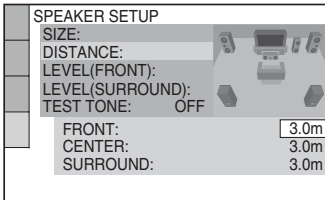

12 Press \uparrow/\downarrow to select the center speaker distance from the listening position, then press ENTER.

You can set from 0.0 to 7.0 meters (0 to 23 ft).

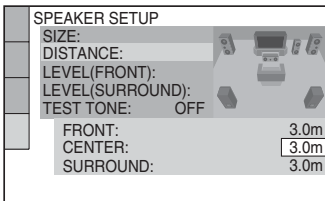

Note

- The setting range changes depending on the front speaker setting.

13 Press \uparrow/\downarrow to select the surround speaker distance from the listening position.

You can set from 0.0 to 7.0 meters (0 to 23 ft).

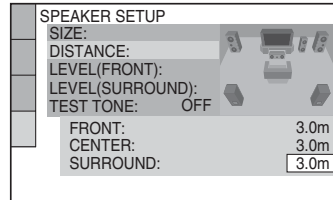

Note

- The setting range changes depending on the front speaker setting.

14 Press ENTER.

Quick Setup is finished. All connections and setup operations are complete.

To quit the Quick Setup

Press \square DISPLAY in any Step.

Note

- If you want to change each setting, see "Using the Setup Display" (page 63).

To recall the Quick Setup display

1 Press \square DISPLAY when the system is in stop mode.

The Control Menu appears.

2 Press \uparrow/\downarrow to select [SETUP], then press ENTER.

The options for [SETUP] appear.

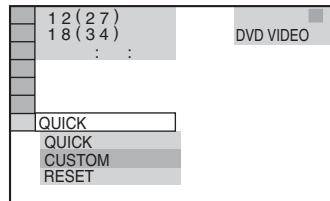

3 Press \uparrow/\downarrow to select [QUICK], then press ENTER.

The Quick Setup display appears.

Speaker Setup

Positioning the speakers

For the best possible surround sound, all the speakers other than the subwoofer should be the same distance from the listening position (A). However, this system allows you to place the center speaker up to 1.6 meters (5 ft) closer (B) and the surround speakers up to 5.0 meters (16 ft) closer (C) to the listening position. The front speakers can be placed from 1.0 to 7.0 meters (4 to 23 ft) (A) from the listening position.

Place speakers as illustrated below.

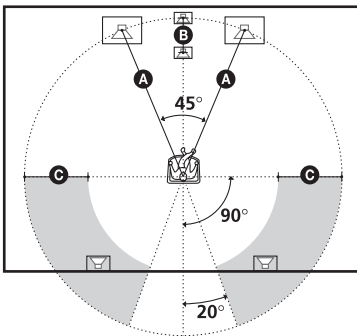

Note

- Do not place the center and surround speakers farther away from the listening position than the front speakers.

If you encounter color irregularity on a nearby TV screen

The front and center speakers and the subwoofer are magnetically shielded to allow it to be installed near a TV set. However, color irregularities may still be observed on certain types of TV sets. As the surround speakers are not magnetically shielded, we recommend that you place the surround speakers slightly further away from TV set.

If color irregularity is observed...

Turn off the TV set once, then turn it on again after 15 to 30 minutes.

If color irregularity is observed again...

Place the speaker further away from the TV set.

If howling occurs

Reposition the speakers or turn down the volume on the system.

Playing Discs

Playing Discs

DVD-V DVD-RW VIDEO CD C D DATA-CD

DATA DVD

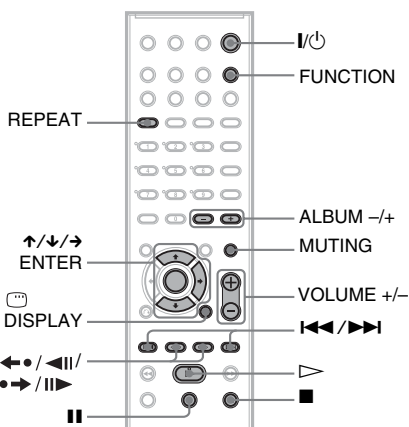
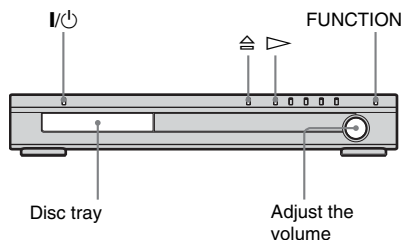

Depending on the DVD VIDEO or VIDEO CD, some operations may be different or restricted. Refer to the operation details supplied with your disc.

1 Turn on your TV.

2 Switch the input selector on the TV to this system.

3 Press I/O.

The system turns on.

Unless the system is set to "DVD," press FUNCTION to select "DVD."

4 Press \triangle .

5 Load a disc.

Place one disc on the tray, and then press \triangle .

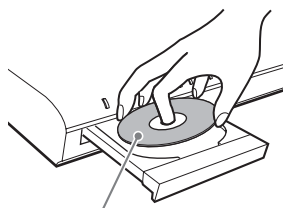

When you play an 8 cm disc, place it on the inner circle of the tray. Be careful that the disc is not skewed on the inner circle of the tray.

Note

- Do not forcibly press the disc tray closed with your finger, as this may cause malfunction.
- Do not place more than one disc on the tray.

6 Press \triangle .

The system starts playback (continuous play).

Adjust the volume on the system.

Tip

- Depending on the disc, a menu may appear on the TV screen. You can play the disc interactively by following the instructions on the menu. (DVD: page 28), (VIDEO CD: page 29).

To save the power in standby mode

Press I/O while the system turns on. To cancel standby mode, press I/O once.

Additional operations

To	Press
Stop	■
Pause	
Resume play after pause	or \triangle
Go to the next chapter, track, or scene	\triangleright (except for JPEG)
Go back to the preceding chapter, track, or scene	\triangleleft (except for JPEG)
Mute the sound	MUTING. To cancel muting, press it again or VOLUME + to adjust the sound volume.

To	Press
Stop play and remove the disc	⏏
Replay the previous scene* ¹	◀● / ◀ (instant replay) during playback.
Briefly fast forward the current scene* ²	●▶ / ▶ (instant advance) during playback.
Go to the next or previous album* ³	ALBUM + or - during playback.

*1 DVD VIDEOS/DVD-RWs/DVD-Rs only. The button can be used except for DivX video files (except for the United Kingdom models).

*2 DVD VIDEOS/DVD-RWs/DVD-Rs/DVD+RWs only. The button can be used except for DivX video files (except for the United Kingdom models).

*3 DATA CDs/DATA DVDs only.

Tip

- You may not be able to use the Instant Replay or Instant Advance function with some scenes.

Resuming playback from the point where you stopped the disc (Resume Play)

When you stop the disc, the system remembers the point where you pressed ■ and “RESUME” appears in the front panel display. As long as you do not remove the disc, Resume Play will work even if the system enters standby mode by pressing I/O.

1 While playing a disc, press ■ to stop playback.

“RESUME” appears in the front panel display.

If “RESUME” does not appear, Resume Play is not available.

2 Press ▷.

The system starts playback from the point where you stopped the disc in Step 1.

Note

- Depending on where you stop the disc, the system may not resume playback from exactly the same point.
- The point where you stopped playing may be cleared when:
 - you eject the disc.

- the system enters standby mode (DATA CD/DATA DVD only).
- you change or reset the settings on the Setup Display.
- you change the function by pressing FUNCTION.
- you disconnect the AC power cord (mains lead).
- For DVD-RWs in VR mode, VIDEO CDs, CDs, DATA CDs, and DATA DVDs, the system remembers the resume playback point for the current disc.
- Resume Play does not work during Program Play and Shuffle Play.
- This function may not work properly with some discs.

Tip

- To play from the beginning of the disc, press ■ twice, then press ▷.

To enjoy a disc that is played before by resume playback (Multi-disc Resume) (DVD VIDEO, VIDEO CD only)

This system stores the point where you stopped the disc for up to 40 discs and resumes playback the next time you insert the same disc. If you store a resume playback point for the 41st disc, the resume playback point for the first disc is deleted.

To activate this function, set [MULTI-DISC RESUME] in [CUSTOM SETUP] to [ON]. For details, see “[MULTI-DISC RESUME] (DVD VIDEO/VIDEO CD only)” (page 67).

Tip

- To play from the beginning of the disc, press ■ twice, then press ▷.

Note

- If [MULTI-DISC RESUME] in [CUSTOM SETUP] is set to [OFF] (page 67), the resume point is cleared when you change the function by pressing FUNCTION.

Creating your own program (Program Play) (VIDEO CD, CD only)

You can play the contents of a disc in the order you want by arranging the order of the tracks on the disc to create your own program. You can program up to 99 tracks.

continued

1 Press DISPLAY.

The Control Menu appears.

2 Press to select [PROGRAM], then press ENTER.

The options for [PROGRAM] appear.

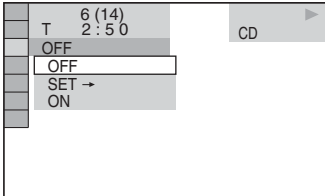

3 Press to select [SET ->], then press ENTER.

[TRACK] is displayed when you play a VIDEO CD or CD.

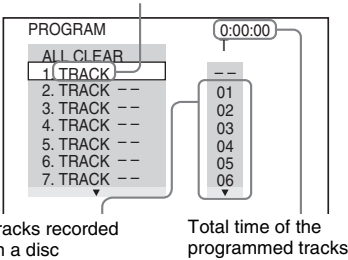

4 Press .

The cursor moves to the track row [T] (in this case, [01]).

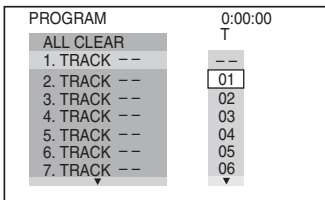

5 Select the track you want to program.

For example, select track [02].

Press  to select [02] under [T], then press ENTER.

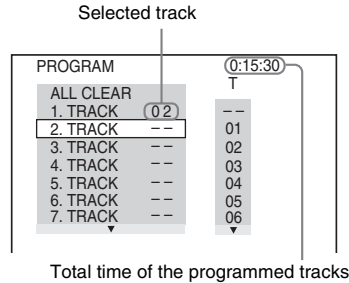

6 To program other tracks, repeat steps 4 to 5.

The programmed tracks are displayed in the selected order.

7 Press to start Program Play.

Program Play starts.

When the program ends, you can restart the same program again by pressing .

To return to normal play

Press CLEAR, or select [OFF] in Step 2. To play the same program again, select [ON] in Step 3 and press ENTER.

To turn off the Control Menu

Press  DISPLAY repeatedly until the Control Menu is turned off.

To change or cancel a program

1 Follow steps 1 to 3 of "Creating your own program (Program Play)."

2 Select the program number of the track you want to change or cancel using . If you want to delete the track from the program, press CLEAR.

3 Follow Step 5 for new programming. To cancel a program, select [--] under [T], then press ENTER.

To cancel all of the tracks in the programmed order

1 Follow steps 1 to 3 of "Creating your own program (Program Play)."

2 Press  and select [ALL CLEAR].

3 Press ENTER.

Playing in random order (Shuffle Play) (VIDEO CD, CD only)

You can have the system “shuffle” tracks. Subsequent “shuffling” may produce a different playing order.

- 1** Press **DISPLAY** during playback. The Control Menu appears.
- 2** Press **↑/↓** to select **[SHUFFLE]**, then press **ENTER**.
The options for [SHUFFLE] appear.

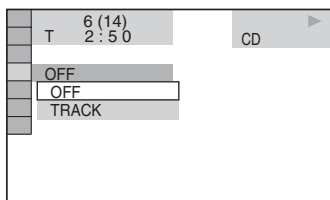

- 3** Press **↑/↓** to select the item to be shuffled.
 - **When playing a VIDEO CD or CD**
 - [TRACK]: shuffles tracks on the disc.
 - **When Program Play is activated**
 - [ON]: shuffles tracks selected in Program Play.
- 4** Press **ENTER**.
Shuffle Play starts.

To return to normal play

Press **CLEAR**, or select **[OFF]** in Step 3.

To turn off the Control Menu

Press **DISPLAY** repeatedly until the Control Menu is turned off.

Note

- You cannot use this function with VIDEO CDs and Super VCDs with PBC playback.

Playing repeatedly (Repeat Play)

You can play all of the titles, tracks or albums on a disc or a single title, chapter, track, or album repeatedly.

You can use a combination of Shuffle or Program Play modes.

- 1** Press **DISPLAY** during playback. The Control Menu appears.
- 2** Press **↑/↓** to select **[REPEAT]**, then press **ENTER**.
The options for [REPEAT] appear.

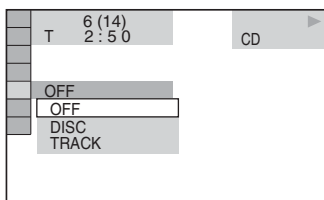

- 3** Press **↑/↓** to select the item to be repeated. The default setting is underlined.
 - **When playing a DVD VIDEO or DVD-RW**
 - [OFF]: does not play repeatedly.
 - [DISC]: repeats all of the titles on the disc.
 - [TITLE]: repeats the current title on a disc.
 - [CHAPTER]: repeats the current chapter.
 - **When playing a VIDEO CD or CD**
 - [OFF]: does not play repeatedly.
 - [DISC]: repeats all of the tracks on the disc.
 - [TRACK]: repeats the current track.

■ When playing a DATA CD or DATA DVD

- [OFF]: does not play repeatedly.
 - [DISC]: repeats all of the albums on the disc.
 - [ALBUM]: repeats the current album.
 - [TRACK] (MP3 audio tracks only): repeats the current track.
 - [FILE] (DivX video files only): repeats the current file.*
- * Except for the United Kingdom models.

4 Press ENTER.

The item is selected.

To return to normal play, press CLEAR, or select [OFF] in Step 3.

To turn off the Control Menu

Press  DISPLAY repeatedly until the Control Menu is turned off.

Note

- You cannot use this function with VIDEO CDs and Super VCDs with PBC playback.
- When playing a DATA CD which contains MP3 audio track and JPEG image files, and their playing time are not the same, the audio sound will not match the image.
- When [MODE (MP3, JPEG)] is set to [IMAGE (JPEG)] (page 34), you cannot select [TRACK].

Using the DVD's Menu

DVD-V

A DVD is divided into a lot of sections, which make up a picture or music feature. These sections are called "titles." When you play a DVD which contains several titles, you can select the title you want using TOP MENU. When you play DVDs that allow you to select items such as the language for the subtitles and the language for the sound, select these items using MENU.

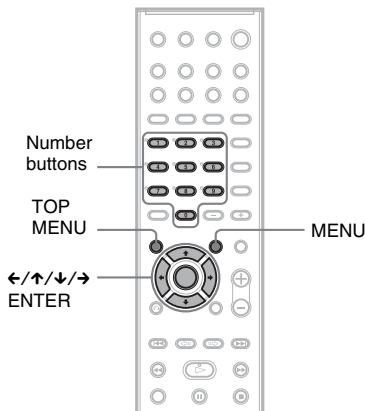

1 Press TOP MENU or MENU.

The disc's menu appears on the TV screen. The contents of the menu vary from disc to disc.

2 Press or the number buttons to select the item you want to play or change.

3 Press ENTER.

Selecting [ORIGINAL] or [PLAY LIST] on a DVD-RW

DVD-RW

Some DVD-RWs in VR (Video Recording) mode have two types of titles for playback: originally recorded titles ([ORIGINAL]) and titles that can be created on recordable DVD players for editing ([PLAY LIST]). You can select the type of title to be played.

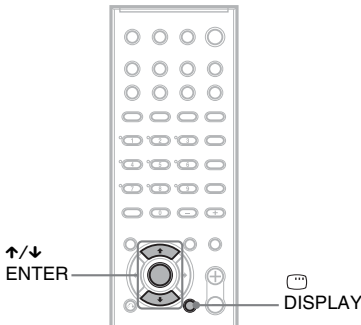

1 Press DISPLAY when the system is in stop mode.

The Control Menu appears.

2 Press to select [ORIGINAL/PLAY LIST], then press ENTER.

The options for [ORIGINAL/PLAY LIST] appear.

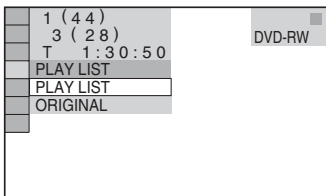

3 Press to select a setting.

- [PLAY LIST]: plays the titles created from [ORIGINAL] for editing.
- [ORIGINAL]: plays the titles originally recorded.

4 Press ENTER.

Playing VIDEO CDs with PBC Functions (Ver.2.0)

(PBC Playback)

VIDEO CD

With PBC (Playback Control) functions, you can enjoy simple interactive operations, search functions, and other such operations. PBC playback allows you to play VIDEO CDs interactively by following the menu on the TV screen.

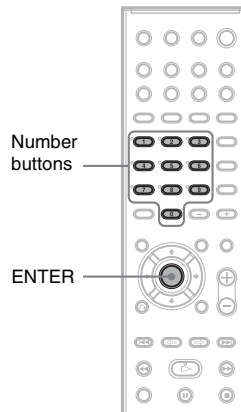

1 Start playing a VIDEO CD with PBC functions.

The menu for your selection appears.

2 Select the item number you want by the number buttons.

3 Press ENTER.

4 Follow the instructions in the menu for interactive operations.

Refer to the operation details supplied with the disc, as the operating procedure may differ depending on the VIDEO CD.

To go back to the menu

Press  RETURN.

Note

- Depending on the VIDEO CD, [Press ENTER] in Step 3 may appear as [Press SELECT] in the instructions supplied with the disc. In this case, press \triangleright .

Tip

- To play without using PBC, press \lll/rrr or the number buttons while the system is stopped to select a track, then press \triangleright or ENTER. The system starts continuous play. You cannot play still pictures such as a menu. To return to PBC playback, press \blacksquare twice, then press \triangleright .

About MP3 Audio Tracks and JPEG Image Files

DATA-CD

What is MP3/JPEG?

MP3 is audio compression technology that satisfies the ISO/MPEG regulations. JPEG is image compression technology.

Discs that the system can play

You can play back DATA CDs (CD-ROMs/CD-Rs/CD-RWs) recorded in MP3 (MPEG1 Audio Layer 3) and JPEG format. However, the discs must be recorded according to ISO 9660 Level 1, Level 2 or Joliet format for the system to recognize the tracks (or files). You can also play discs recorded in Multi Session.

See the instructions supplied with the CD-R/CD-RW drives and the recording software (not supplied) for details on the recording format.

About the multi-session disc

If MP3 audio tracks or JPEG image files are recorded in the first session, the system will also play MP3 audio tracks or JPEG image files in other sessions. If audio tracks and images in audio CD format or video CD format are recorded in the first session, only the first session will be played back.

Note

- The system may not be able to play some DATA CDs created in the Packet Write format. In this case, you cannot view the JPEG images recorded.

MP3 audio track or JPEG image file that the system can play

The system can play the MP3 audio tracks or JPEG image files:

- which have the extension “.MP3” (MP3 audio track) or “.JPG”/“.JPEG” (JPEG image file)
- which conform to the DCF* image file format

* “Design rule for Camera File system”: Image standards for digital cameras regulated by Japan Electronics and Information Technology Industries Association (JEITA).

Note

- The system will play any data with the extension “.MP3,” “.JPG,” or “.JPEG” even if they are not in MP3 or JPEG format. Playing this data may generate a loud noise which could damage your speaker system.
- The system does not conform to audio in MP3PRO format.

Playback order of MP3 audio tracks or JPEG image files

The playback order of MP3 audio tracks or JPEG image files recorded on a DATA CD is as follows:

■ Structure of disc contents

Tree 1 Tree 2 Tree 3 Tree 4 Tree 5

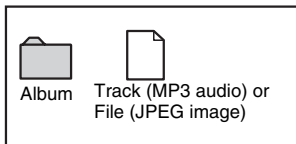
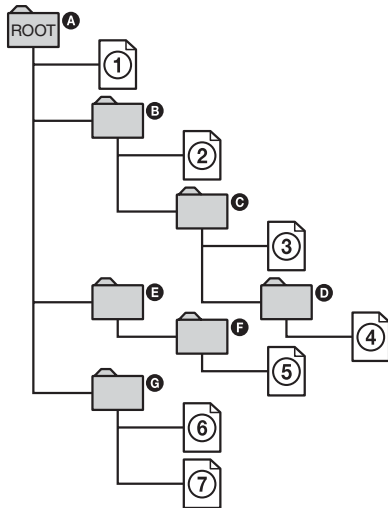

When you insert a DATA CD and press \triangleright , the numbered tracks (or files) are played sequentially, from ① through ⑦. Any sub-albums/tracks (or files) contained within a

currently selected album take priority over the next album in the same tree. (Example: ③ contains ④ so ④ is played before ⑤.)

When you press MENU and the list of album names appears (page 32), the album names are arranged in the following order:

① → ② → ③ → ④ → ⑤ → ⑥ → ⑦. Albums that do not contain tracks (or files) (such as album ③) do not appear in the list.

Tip

- If you add numbers (01, 02, 03, etc.) to the front of the track/file names when you store the tracks (or files) in a disc, the tracks and files will be played in that order.
- A disc with many trees takes longer to start playback.

Note

- Depending on the software you use to create the DATA CD, the playback order may differ from the illustration.
- The playback order above may not be applicable if there are more than 200 albums and 300 files in each album.
- The system can recognize up to 200 albums (the system will count just albums, including albums that do not contain MP3 audio tracks and JPEG image files). The system will not play any albums beyond the 200th album.
- The system may take longer time to playback, when progressing to the following album or jump to other album.
- Some type of JPEG files cannot be played.

Playing DATA CDs with MP3 Audio Tracks and JPEG Image Files

DATA-CD

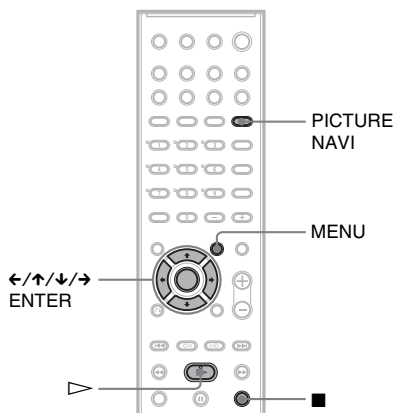

Selecting an MP3 audio track or album

1 Load a DATA CD.

The albums recorded on the DATA CD appear. When an album is being played, its title is shaded.



2 Press **↑/↓** to select an album.

■ When selecting an album

Press **▷** to start playing the selected album.

■ When selecting a track

Press **ENTER**.

The list of tracks contained in the album appears.

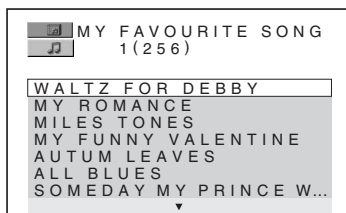

Press **↑/↓** to select a track and press **ENTER**. The selected track starts playing. You can turn the track list off by pressing **MENU**. Pressing **MENU** again will display the album list.

To stop playback

Press **■**.

To play the next or previous MP3 audio track

Press **◀◀/▶▶**. Note that you can select the next album by continuing to press **▶▶** after the last track on the current album, but that you cannot return to the previous album by pressing **◀◀**. To return to the previous album, select the album from the album list.

To return to the previous display

Press **↶** RETURN.

To turn off the display

Press **MENU**.

Selecting a JPEG image file or album

1 Load a DATA CD.

The albums recorded on the DATA CD appear. When an album is being played, its title is shaded.

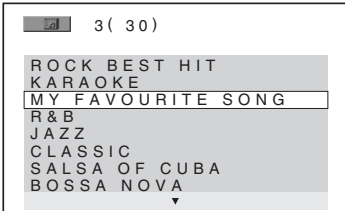

2 Press \uparrow/\downarrow to select an album.

■ When selecting an album

Press \triangleright to start playing the selected album.

■ When selecting an image

Press PICTURE NAVI.

Images of files in the album appear in 16 subscreens.

1	2	3	4
5	6	7	8
9	10	11	12
13	14	15	16

Press $\leftarrow/\uparrow/\downarrow/\rightarrow$ to select the image you want to view and press ENTER.

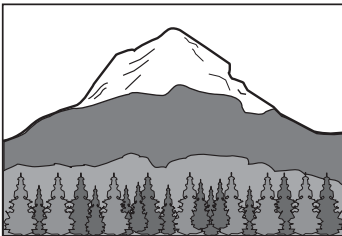

To play the next or previous JPEG image file

Press \leftarrow/\rightarrow when the Control Menu is not displayed. Note that you can select the next album by continuing to press \rightarrow after the last image on the current album, but that you cannot return to the previous album by pressing \leftarrow . To return to the previous album, select the album from the album list.

To rotate a JPEG image

When a JPEG image file is displayed on the screen, you can rotate the image by 90 degrees. Press \uparrow/\downarrow while viewing an image. Each time you press \uparrow , the image rotates counterclockwise by 90 degrees.

Example of when you press \uparrow once:

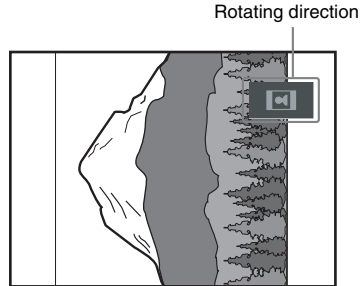

Press CLEAR to return to normal view.

To stop playback

Press ■.

Tip

- A scroll box is displayed at the right side of the screen. To display the additional image files, select the bottom image and press \downarrow . To return to the previous image, select the top image and press \uparrow .

Playing Audio Tracks and Images as a Slide Show with Sound

DATA-CD

You can play a slide show with sound by first placing both MP3 and JPEG files in the same album on a DATA CD. When you play back the DATA CD, select [AUTO] mode as explained below.

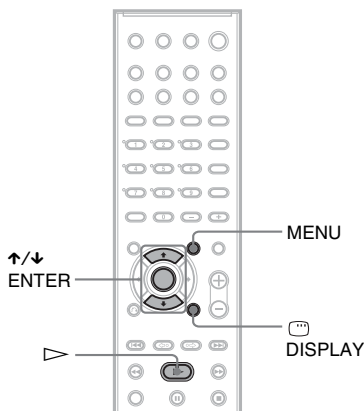

- 1 Load a DATA CD.**
- 2 Press DISPLAY.**
The Control Menu appears.
- 3 Press to select [MODE (MP3, JPEG)], then press ENTER.**
The options for [MODE (MP3, JPEG)] appear.

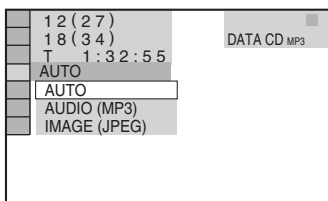

- 4 Press to select the setting you want and press ENTER.**
The default setting is underlined.

- [AUTO]: plays both the JPEG image files and MP3 audio tracks in the same album as a slide show.
- [AUDIO (MP3)]: plays only MP3 audio tracks continuously.
- [IMAGE (JPEG)]: plays only JPEG image files as a slide show.

- 5 Press MENU.**
The list of albums recorded on the DATA CD appears.
- 6 Press to select the album you want and press .**
The system starts playing the selected album.
You can turn the album list on and off by pressing MENU repeatedly.

Tip

- When you select [AUTO], the system can recognize up to 300 MP3 tracks and 300 JPEG files in a single album. When you select [AUDIO (MP3)] or [IMAGE (JPEG)], the system can recognize up to 600 MP3 and 600 JPEG files in a single album. A maximum of 200 albums can be recognized regardless of the selected mode.

Note

- If you set [MODE (MP3, JPEG)] to [IMAGE (JPEG)] on a disc that contains MP3 tracks only or [AUDIO (MP3)] on a disc that contains JPEG files only, you may not be able to change the [MODE (MP3, JPEG)] setting.
- PICTURE NAVI does not work when [AUDIO (MP3)] is selected.
- If you play large MP3 track data and JPEG image data at the same time, the sound may skip. It is recommended that you set the MP3 bit rate to 128 kbps or lower when creating the file. If the sound still skips, then reduce the size of the JPEG file.

Specifying the slide show duration (JPEG only)

When you play JPEG image files using slide show, you can specify the duration for slides to appear on the screen.

- 1 Press DISPLAY twice.**
The Control Menu for JPEG appears.

- 2** Press **↑/↓** to select  [INTERVAL], then press **ENTER**.
The options for [INTERVAL] appear.

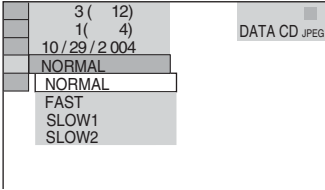

- 3** Press **↑/↓** to select the setting you want.

The default setting is underlined.

- [NORMAL]: sets the duration to about 6 to 9 seconds. (Images that are four million pixels or more will lengthen the duration.)
- [FAST]: sets the duration shorter than [NORMAL].
- [SLOW1]: Sets the duration longer than [NORMAL].
- [SLOW2]: Sets the duration longer than [SLOW1].

- 4** Press **ENTER**.

The selected setting takes effect.



Note

- Some JPEG files may take longer to display than others, which may make the duration seems longer than the option you selected. Especially progressive JPEG files or JPEG files of 3,000,000 pixels or more.

Selecting an effect for image files in the slide show

(JPEG only)

When you play a JPEG image file, you can select the effect to be used when viewing the slide show.

- 1** Press  **DISPLAY** twice.
The Control Menu for JPEG appears.
- 2** Press **↑/↓** to select  [EFFECT], then press **ENTER**.
The options for [EFFECT] appear.

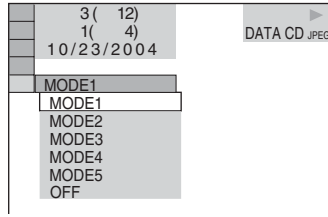

- 3** Press **↑/↓** to select the setting you want.

The default setting is underlined.

- [MODE1]: The image sweeps in from top to bottom.
- [MODE2]: The image stretches out from left to right of the screen.
- [MODE3]: The image stretches out from the center of the screen.
- [MODE4]: The images randomly cycle through the effects.
- [MODE5]: The next image slides over the previous image.
- [OFF]: Turns off this function.

- 4** Press **ENTER**.

The selected setting takes effect.

Enjoying DivX[®] Videos

DATA-CD DATA DVD

(Except for the United Kingdom models)

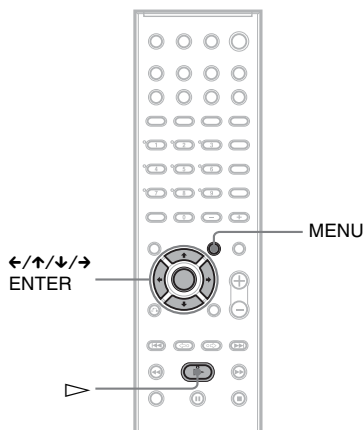

About DivX Video Files

DivX[®] is a video file compression technology, developed by DivX, Inc. This product is an official DivX[®] Certified product. You can play DATA CDs and DATA DVDs that contain DivX[®] video files.

DATA CDs and DATA DVDs that the system can play

Playback of DATA CDs (CD-ROMs/CD-Rs/CD-RWs) and DATA DVDs (DVD-Rs/DVD-RWs/DVD+Rs/DVD+RWs) on this system is subject to certain conditions:

- With DATA CDs that contain DivX video files in addition to MP3 audio tracks or JPEG image files, the system plays only the DivX video files.
- With DATA DVDs, the system plays DivX video files only. Any data other than DivX video file, such as MP3 audio tracks and JPEG image files, are not played.

However, this system only plays DATA CDs whose logical format is ISO 9660 Level 1/Level 2 or Joliet, and DATA DVDs of Universal Disk Format (UDF).

You can also play DATA CDs recorded in Multi Session (page 30), although DATA DVDs recorded in Multi Session are not playable.

Refer to the instructions supplied with the disc drives and the recording software (not supplied) for details on the recording format.

About playback order of data on DATA CDs or DATA DVDs

See “Playback order of MP3 audio tracks or JPEG image files” (page 31). Note that the playback order may not be applicable, depending on the software used for creating the DivX video file, or if there are more than 200 albums and 600 DivX video files in each album.

Note

- The system may not be able to play some DATA CDs/DATA DVDs created in the Packet Write format.

DivX video files that the system can play

The system can play data that is recorded in DivX format, and which has the extension “.AVI,” or “.DIVX.” The system will not play files with the extension “.AVI” or “.DIVX” if they do not contain a DivX video.

Tip

- For details about playable MP3 audio tracks or JPEG image files on DATA CDs, see “Discs that the system can play” (page 30).

Note

- The system may not play a DivX video file when the file has been combined from two or more DivX video files.
- The system cannot play a DivX video file of size more than 720 (width) × 576 (height) or 2GB.
- Depending on the DivX video file, sound may skip or not match the pictures on the screen.
- The system cannot play some DivX video files that are longer than 3 hours.

- Depending on the DivX video file, the picture may pause or be unclear. In which case, it is recommended that you create the file at a lower bit rate. If the sound is still noisy, MP3 is the recommended audio format. Note, however, this system does not conform to WMA (Windows Media Audio) format.
- Because of the compression technology used for DivX video files, it may take some time after you press \triangleright for the picture to appear.

Selecting an album

1 Press MENU.

A list of albums on the disc appears. Only albums that contain DivX video files are listed.

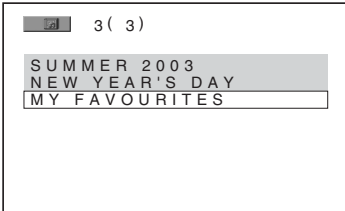

2 Press \uparrow/\downarrow to select the album you want to play.

3 Press \triangleright .

The system starts playing the selected album.

To select DivX video files, see “Selecting a DivX video file” (page 37).

To stop playback

Press \blacksquare .

To go to the next or previous page

Press \leftarrow/\rightarrow .

To turn off the display

Press MENU repeatedly.

Selecting a DivX video file

1 After Step 2 of “Selecting an album,” press ENTER.

The list of files in the album appears.

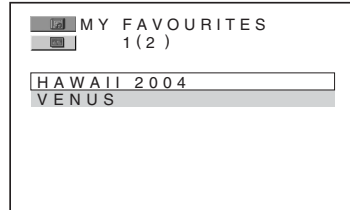

2 Press \uparrow/\downarrow to select a file and press ENTER.

The selected file starts playing.

To stop playback

Press \blacksquare .

To go to the next or previous page

Press \leftarrow/\rightarrow .

To return to the previous display

Press \curvearrowright RETURN.

To play the next or previous DivX video file without turning on the above file list

You can select the next or previous DivX video file in the same album by pressing \lll/\ggg .

You can also select the first file of the next album by pressing \ggg during playback of the last file of the current album. Note that you cannot return to the previous album by pressing \lll . To return to the previous album, select it from the album list.

Tip

- If the number of viewing times is preset, you can play the DivX video files as many times as the preset number. The following occurrences are counted:
 - when the system is turned off.
 - when the disc tray is opened.
 - when another file is played.

Adjusting the Delay Between the Picture and Sound

(A/V SYNC)

DVD-V DVD-RW VIDEO CD DATA-CD DATA DVD

When the sound does not match the pictures on the screen, you can adjust the delay between the picture and sound.

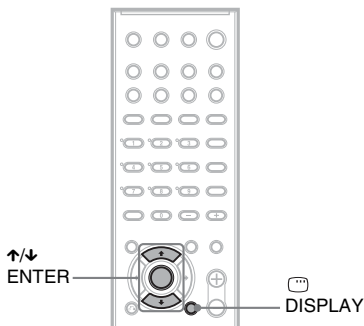

1 Press **DISPLAY** in stop mode.

The Control Menu appears.

2 Press **↑/↓** to select **[A/V SYNC]**, then press **ENTER**.

The options for [A/V SYNC] appear.

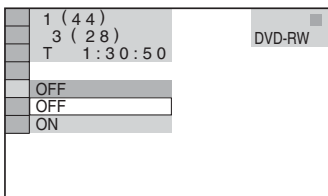

3 Press **↑/↓** to select the setting.

- [OFF]: does not adjust.
- [ON]: adjusts the difference between picture and sound.

Note

- Depending on the input stream, this function may not be effective.

Searching for a Particular Point on a Disc

(Scan, Slow-motion Play, Freeze Frame)

DVD-V DVD-RW VIDEO CD C D DATA-CD
DATA DVD

You can quickly locate a particular point on a disc by monitoring the picture or playing back slowly.

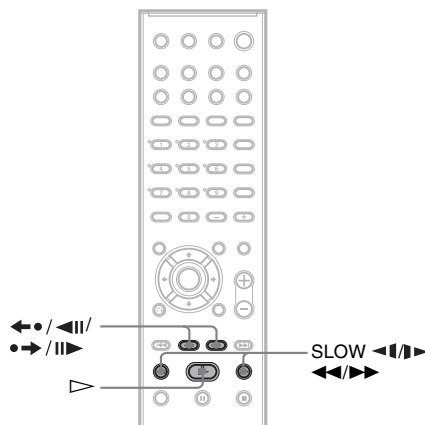

Note

- Depending on the DVD/VIDEO CD, you may not be able to do some of the operations described.

Locating a point quickly by playing a disc in fast forward or fast reverse (Scan) (except for JPEG)

Press **◀◀** or **▶▶** while playing a disc. When you find the point you want, press **▶** to return to normal speed. Each time you press **◀◀** or **▶▶** during scan, the playback speed changes. With each press the indication changes as shown below. Actual speeds may differ with some discs.

Playback direction

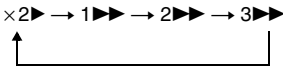

3 (DVD VIDEO/DVD-RW/DivX video*/VIDEO CD only)
 x2 (DVD VIDEO/CD only)

* Except for the United Kingdom models.

Opposite direction

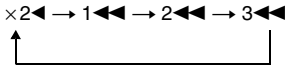

3 (DVD VIDEO/DVD-RW/DivX video*/VIDEO CD only)
 x2 (DVD VIDEO only)

* Except for the United Kingdom models.

With each press, playback speed becomes faster.

Watching frame by frame (Slow-motion Play)

(DVD, DVD-RW, DivX video*, VIDEO CD only)

* Except for the United Kingdom models.

Press ◀◀ or ▶▶ when the system is in pause mode. To return to the normal playback speed, press ▷. Each time you press ◀◀ or ▶▶ during Slow-motion Play, the playback speed changes. Two speeds are available. With each press the indication changes as follows:

Playback direction

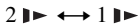

Opposite direction (DVD VIDEO only)

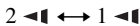

Playing one frame at a time (Freeze Frame)

(except for CD and JPEG)

When the system is in the pause mode, press ●→/||▶ (step) to go to the next frame. Press ◀●/◀|| (step) to go to the preceding frame (DVD VIDEO/DVD-RW only). To return to normal playback, press ▷.

Note

- You cannot search for a still picture on a DVD-RW in VR mode.
- For DATA CDs, this function works only for DivX video files (except for the United Kingdom models).

Searching for a Title/ Chapter/Track/Scene, etc.

DVD-V DVD-RW VIDEO CD C D DATA-CD

DATA DVD

You can search a DVD by title or chapter, and you can search a VIDEO CD/CD/DATA CD/DATA DVD by track, index, or scene. As titles and tracks are assigned unique numbers on the disc, you can select the desired one by entering its number. Or, you can search for a scene using the time code.

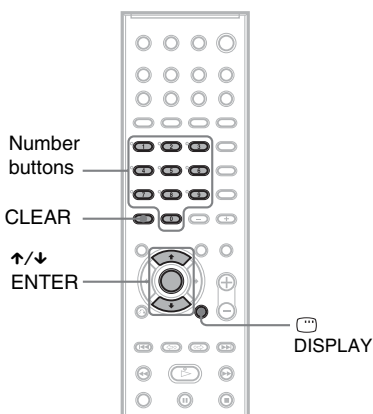

- 1 Press DISPLAY. (When playing a DATA CD with JPEG image files, press DISPLAY twice.)

The Control Menu appears.

- 2 Press to select the search method.

■ When playing a DVD VIDEO/DVD-RW

- [TITLE]
- [CHAPTER]
- [TIME/TEXT]

Select [TIME/TEXT] to search for a starting point by inputting the time code.

■ When playing a VIDEO CD/Super VCD without PBC Playback

- [TRACK]

- [INDEX]

■ When playing a VIDEO CD/Super VCD with PBC Playback

- [SCENE]

■ When playing a CD

- [TRACK]

■ When playing a DATA CD (MP3 audio)

- [ALBUM]

- [TRACK]

■ When playing a DATA CD (JPEG file)

- [ALBUM]

- [FILE]

■ When playing a DviX video (Except for the United Kingdom models)

- [ALBUM]

- [FILE]

Example: when you select [CHAPTER]

[** (**)] is selected (** refers to a number).

The number in parentheses indicates the total number of titles, chapters, tracks, indexes, scenes, albums or files.

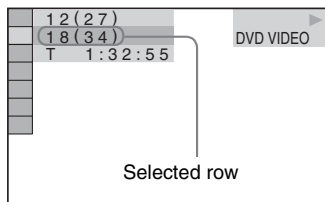

- 3 Press ENTER.

[** (**)] changes to [-- (**)].

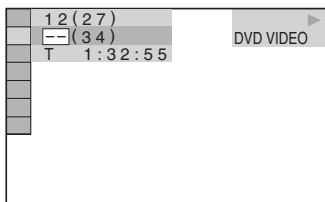

- Press **↑/↓** or the number buttons to select the title, chapter, track, index, scene, etc., number you want to search for.

If you make a mistake

Cancel the number by pressing **CLEAR**, then select another number.

- Press **ENTER**.

The system starts playback from the selected number.

To search for a scene using the time code (DVD VIDEO/DVD-RW only)

- In Step 2, select  [TIME/TEXT].
[T **: **: **: **] (playing time of the current title) is selected.
- Press **ENTER**.
[T **: **: **: **] changes to [T --:--:--].
- Input the time code using the number buttons, then press **ENTER**.
For example, to find the scene at 2 hours, 10 minutes, and 20 seconds after the beginning, just enter [2:10:20].

Tip

- When the Control Menu display is turned off, you can search for a chapter (DVD VIDEO/DVD-RW), track (CD), or file (DATA CD (DivX video*)/DATA DVD) by pressing the number buttons and **ENTER**.
- * Except for the United Kingdom models.

Note

- You cannot search for a scene on a DVD+RW using the time code.

Searching by Scene

(Picture Navigation)

DVD-V VIDEO CD

You can divide the screen into 9 subscreens and find the desired scene quickly.

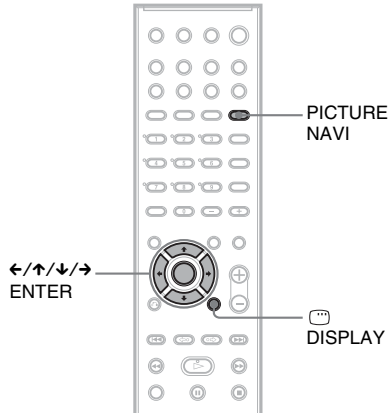

- Press **PICTURE NAVI** during playback. The following display appears.

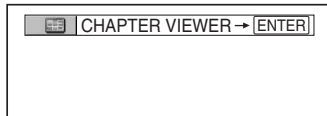

- Press **PICTURE NAVI** repeatedly to select an item.
 - [TITLE VIEWER] (DVD VIDEO only)
 - [CHAPTER VIEWER] (DVD VIDEO only)
 - [TRACK VIEWER] (VIDEO CD/ Super VCD only)
- Press **ENTER**.
The first scene of each title, chapter, or track appears as follows.

continued

1	2	3
4	5	6
7	8	9

4 Press **←/↑/↓/→** to select a title, chapter, or track, and press **ENTER**.

Playback starts from the selected scene.

To return to normal play during setting

Press **↶** RETURN or **⏏** DISPLAY.

Note

- Depending on the disc, you may not be able to select some items.

Viewing Information About the Disc

DVD-V **DVD-RW** **VIDEO CD** **CD** **DATA-CD**

DATA DVD

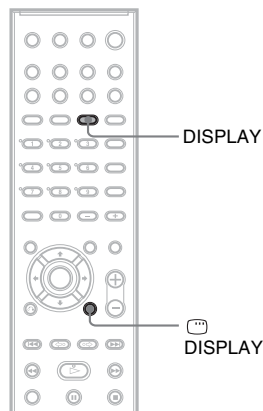

Viewing the Playing Time and Remaining Time in the Front Panel Display

You can check disc information, such as the remaining time, total number of titles in a DVD, tracks in a VIDEO CD, CD, or MP3, file name of a DivX video* using the front panel display (page 80).

* Except for the United Kingdom models.

Press DISPLAY.

Each time you press DISPLAY while playing the disc, the display changes as shown in the charts.

When playing a DVD VIDEO or DVD-RW

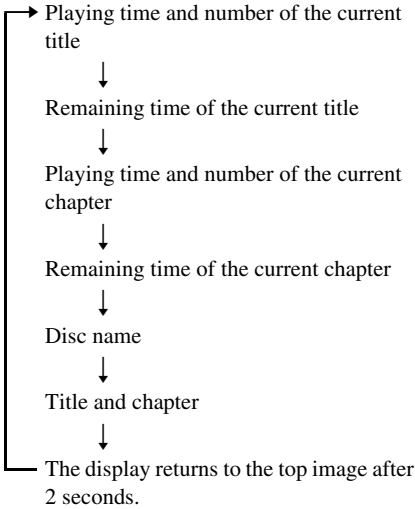

When playing a DATA CD (DivX video) or DATA DVD (DivX video) (except for the United Kingdom models)

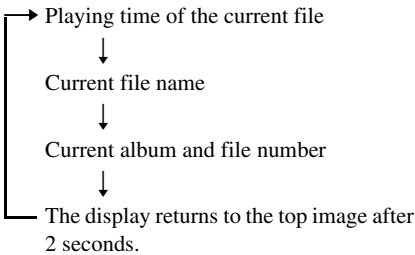

When playing a VIDEO CD (without PBC functions) or CD

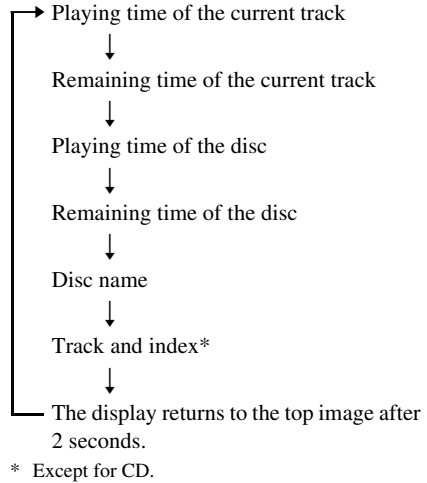

When playing an MP3

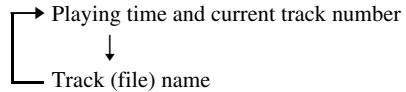

Tip

- When playing VIDEO CDs with PBC functions, the playing time is displayed.

Note

- The system can only display the first level of the DVD/CD text, such as the Disc name or title.
- If an MP3 file name cannot be displayed, “*” will appear in the front panel display instead.
- The disc name or track name may not be displayed depending on the text.
- Playing time of MP3 audio tracks and DivX video files* may not be displayed correctly.

* Except for the United Kingdom models.

Viewing the Station Name or Frequency in the front panel display

When the system is set to “TUNER AM” or “TUNER FM,” you can check the frequency using the front panel display.

continued

Press DISPLAY.

Each time you press DISPLAY, the display changes as shown in the charts.

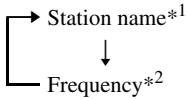

*1 This is displayed if you have entered a name for a preset station (page 59).

*2 Returns to the original display when several seconds has elapsed.

Checking the Playing Time and Remaining Time

You can check the playing time and remaining time of the current title, chapter, or track, and the total playing time or remaining time of the disc. You can also check the DVD text and MP3 folder name/file name recorded on the disc.

1 Press DISPLAY during playback.

The following display appears.

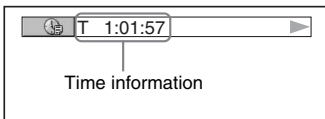

2 Press DISPLAY repeatedly to change the time information.

The display and the kinds of time that you can check depend on the disc you are playing.

■ When playing a DVD VIDEO or DVD-RW

- T **:*:*:*
Playing time of the current title
- T_**:*:*:*
Remaining time of the current title
- C **:*:*:*
Playing time of the current chapter
- C_**:*:*:*
Remaining time of the current chapter

■ When playing a VIDEO CD (with PBC functions)

- **:*:*
Playing time of the current scene

■ When playing a VIDEO CD (without PBC functions) or CD

- T **:*:*
Playing time of the current track
- T_**:*:*
Remaining time of the current track
- D **:*:*
Playing time of the current disc
- D_**:*:*
Remaining time of the current disc

■ When playing a DATA CD (MP3 audio)

- T **:*:*
Playing time of the current track

■ When playing a DATA CD (DivX video)/DATA DVD (DivX video) (except for the United Kingdom models)

- **:*:*:*
Playing time of the current file

Note

- Only alphabetical letters and numbers can be displayed.
- Depending on the type of disc being played, the system can only display a limited number of characters. Also, depending on the disc, not all text characters will be displayed.

Checking the play information of the Disc

To check DVD/CD text

Press DISPLAY repeatedly in Step 2 to display text recorded on the DVD/CD.

The DVD/CD text appears only when text is recorded in the disc. You cannot change the text. If the disc does not contain text, "NO TEXT" appears.

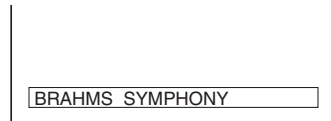

To check DATA CD (MP3 audio/DivX video*1)/DATA DVD (DivX video*1) text

By pressing DISPLAY while playing MP3 audio tracks on a DATA CD or DivX video

files*¹ on a DATA CD/DATA DVD, you can display the name of the album/track/file, and the audio bit rate (the amount of data per second of the current audio) on your TV screen.

Tip

- Date information is [DD/MM/YYYY].
DD: Day
MM: Month
YYYY: Year

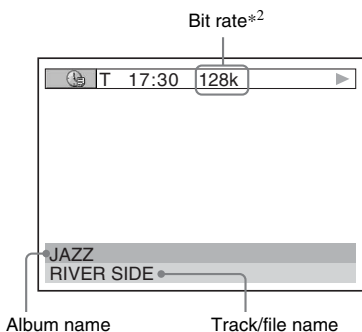

*1 Except for the United Kingdom models.

*2 Appears when:

- playing an MP3 audio track on DATA CDs.
- playing a DivX video file that contains MP3 audio signals on DATA CDs/DATA DVDs (except for the United Kingdom models).

Checking the date information (JPEG only)

You can check the date information during playback when the Exif* tag is recorded in the JPEG image data.

Press **DISPLAY** twice during playback.

The Control Menu appears.

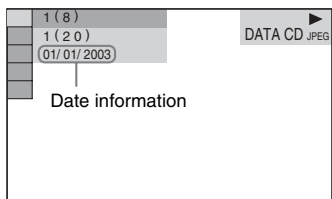

* “Exchangeable Image File Format” is a digital camera image format defined by the Japan Electronics and Information Technology Industries Association (JEITA).

Sound Adjustments

Changing the Sound

DVD-V

DVD-RW

VIDEO CD

CD

DATA-CD

DATA DVD

When playing a DVD VIDEO or DATA CD/ DATA DVD (DivX video files*) recorded in multiple audio formats (PCM, Dolby Digital, MPEG audio, or DTS), you can change the audio format. If the DVD VIDEO is recorded with multilingual tracks, you can also change the language.

With VIDEO CDs, CDs, or DATA CDs, you can select the sound from the right or left channel and listen to the sound of the selected channel through both the right and left speakers.

* Except for the United Kingdom models.

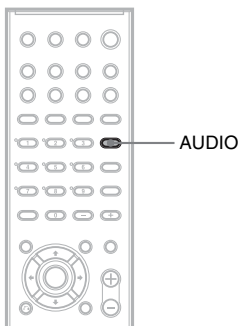

1 Press **AUDIO** during playback.

The following display appears.

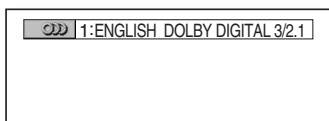

2 Press **AUDIO** repeatedly to select the desired audio signal.

■ When playing a DVD VIDEO

Depending on the DVD VIDEO, the choice of language varies.

When 4 digits are displayed, they indicate a language code. Refer to “Language Code List” (page 78) to see which language the code represents. When the same language is displayed two or more times, the DVD VIDEO is recorded in multiple audio formats.

■ When playing a DVD-RW

The types of sound tracks recorded on a disc are displayed. The default setting is underlined.

Example:

- [1: MAIN] (main sound)
- [1: SUB] (sub sound)
- [1: MAIN+SUB] (main and sub sound)
- [2: MAIN]
- [2: SUB]
- [2: MAIN+SUB]

Note

• [2: MAIN], [2: SUB], and [2: MAIN+SUB] do not appear when one audio stream is recorded on the disc.

■ When playing a VIDEO CD, CD, or DATA CD (MP3 audio)

The default setting is underlined.

- [STEREO]: the standard stereo sound
- [1/L]: the sound of the left channel (monaural)
- [2/R]: the sound of the right channel (monaural)

■ When playing a DATA CD (DivX video) or DATA DVD (DivX video) (except for the United Kingdom models)

The choice of DATA CD or DATA DVD audio signal formats differ, depending on the DivX video file contained on the disc. The format is shown in the display.

■ When playing a Super VCD

The default setting is underlined.

- [1:STEREO]: the stereo sound of the audio track 1
- [1:1/L]: the sound of the left channel of the audio track 1 (monaural)

- [1:2/R]: the sound of the right channel of the audio track 1 (monaural)
- [2:STEREO]: the stereo sound of the audio track 2
- [2:1/L]: the sound of the left channel of the audio track 2 (monaural)
- [2:2/R]: the sound of the right channel of the audio track 2 (monaural)

Note

- While playing a Super VCD on which the audio track 2 is not recorded, no sound will come out when you select [2:STEREO], [2:1/L], or [2:2/R].

■ When playing a DATA CD (DivX video) or DATA DVD (DivX video) (except for the United Kingdom models)

Example:

MP3 audio

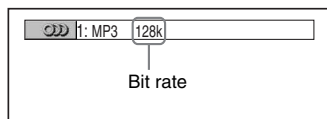

Checking the audio signal format

(DVD, DivX video* only)

* Except for the United Kingdom models. If you press AUDIO repeatedly during playback, the format of the current audio signal (PCM, Dolby Digital, DTS, etc.) appears as shown below.

■ When playing a DVD VIDEO

Example:

Dolby Digital 5.1 ch

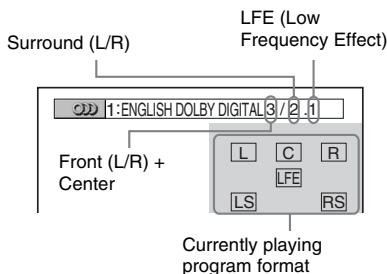

Example:

Dolby Digital 3 ch

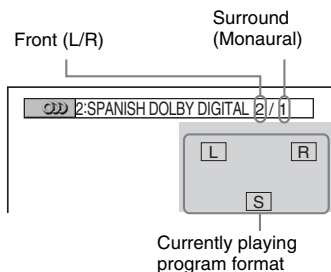

About audio signals

Audio signals recorded in a disc contain the sound elements (channels) shown below. Each channel is output from a separate speaker.

- Front (L)
- Front (R)
- Center
- Surround (L)
- Surround (R)
- Surround (Monaural): This signal can be either the Dolby Surround Sound processed signals or the Dolby Digital sound's monaural Surround audio signals.
- LFE (Low Frequency Effect) signal

Enjoying Surround Sound by Using Sound Field

DVD-V DVD-RW VIDEO CD C D DATA-CD

DATA DVD

You can take advantage of surround sound simply by selecting one of system's pre-programmed sound fields. They bring the exciting and powerful sound of movie theaters into your home.

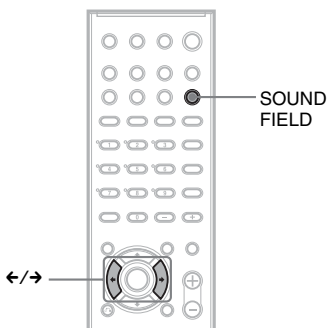

Press SOUND FIELD.

Each time you press SOUND FIELD repeatedly until the sound field you want appears in the front panel display.

You can also select the sound field by pressing ←/→.

All sound field

Sound field	Display
AUTO FORMAT DIRECT AUTO	A.F.D. AUTO
Dolby Pro Logic	PRO LOGIC
Dolby Pro Logic II MOVIE	PLII MOVIE
Dolby Pro Logic II MUSIC	PLII MUSIC
VIRTUAL MULTI DIMENSION	V.M.DIM.
MULTI ST.	MULTI ST.
ROCK	ROCK
POP	POP
JAZZ	JAZZ
CLASSIC	CLASSIC
NIGHT	NIGHT

Sound field	Display
2 CHANNEL STEREO	2CH STEREO

Automatic outputting of the original sound

■ AUTO FORMAT DIRECT AUTO

The auto decoding function automatically detects the type of audio signal being input (Dolby Digital, DTS, or standard 2 channel stereo) and performs the proper decoding if necessary. This mode presents the sound as it was recorded/encoded, without adding any effects (e.g. reverberation).

However, if there are no low frequency signals (Dolby Digital LFE, etc.), it will generate a low frequency signal for output to the subwoofer.

Outputting 2 channel sources like CDs by 5.1 channel

■ Dolby Pro Logic

Dolby Pro Logic produces five output channels from 2 channel sources. This mode performs Pro Logic decoding to the input signal and output to front, center, and surround speakers.

Meanwhile, the surround channel becomes monaural.

■ Dolby Pro Logic II MOVIE/MUSIC

Dolby Pro Logic II produces five full-bandwidth output channels from 2 channel sources. This is done using an advanced, high-purity matrix surround decoder that extracts the spatial properties of the original recording without adding any new sounds or tonal colorations.

■ Note

- When the input signal is multi channel source, Dolby Pro Logic and Dolby Pro Logic II MOVIE/MUSIC are canceled and the multi channel source is output directly.
- When the bilingual broadcast sound is input, Dolby Pro Logic and Dolby Pro Logic II MOVIE/MUSIC are not effective.

Enjoying virtual surround speakers

■ VIRTUAL MULTI DIMENSION

Creates an array of virtual surround speaker positions higher than the listener from a single set of actual surround speakers.

This mode creates 5 pairs of virtual speakers surrounding the listener at approximately a 30° angle of elevation. The effect differs according to the [BEHIND] or [SIDE] setting of the surround speakers (page 67).

[BEHIND]

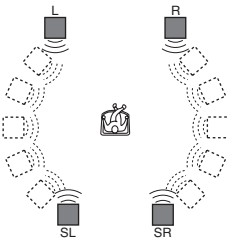

[SIDE]

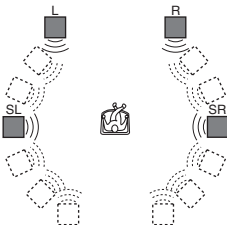

L: Front speaker (left)
R: Front speaker (right)
SL: Surround speaker (left)
SR: Surround speaker (right)
□: Virtual speaker

Outputting 2 channel sources from the surround speakers

■ MULTI ST.

This mode outputs 2 channel sources from the front speakers and surround speakers simultaneously. The sound that is output from the surround speakers is same as the sound that is output from the front speakers.

Tip

- When you select “MULTI ST.,” “LINK” lights up in the front panel display.

Selecting a sound field for music

■ ROCK, POP, JAZZ, CLASSIC

The each mode provided sound to suit the source.

Enjoying the sound at low volume

■ NIGHT

You can enjoy sound effects or dialog, as you would in a movie theater, even at low volume. It is useful for watching movies at night.

In this mode, the sound is output from the front speakers only. When a 2 channel source is played, this function is not effective.

Using only the front speaker and subwoofer

■ 2 CHANNEL STEREO

This mode outputs the sound from the front left and right speakers and subwoofer. Standard 2 channel (stereo) sources completely bypass the sound field processing. Multi channel surround formats are downmixed to two channels.

This allows you to play any source using only the front left and right speakers and subwoofer.

To turn the surround effect off

Press SOUND FIELD repeatedly until “A.F.D. AUTO” or “2CH STEREO” appears in the front panel display.

Using the Sound Effect

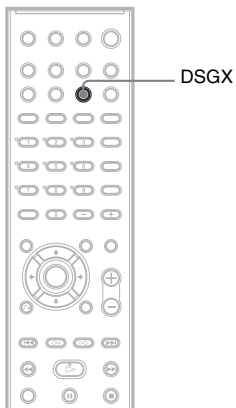

Reinforcing bass frequencies

You can reinforce bass frequencies.

Press DSGX.

Bass frequencies are effectively reinforced.

To turn off the sound effect

Press DSGX again.

Note

- Depending on the input stream, the DSGX function may not be effective.

Using Various Additional Functions

Changing the Angles

DVD-V

If various angles (multi-angles) for a scene are recorded on a DVD VIDEO, you can change the viewing angle.

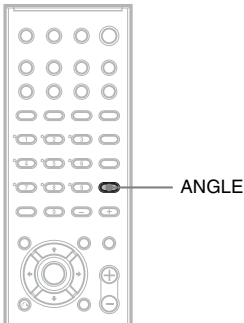

Press ANGLE during playback.

Each time you press ANGLE, the angle changes.

Note

- Depending on the DVD VIDEO, you may not be able to change the angle even if multi-angles are recorded on the DVD VIDEO.

Displaying the Subtitles

DVD-V

DVD-RW

DATA-CD

DATA DVD

If subtitles are recorded on a disc, you can turn the subtitles on or off while playing. If multilingual subtitles are recorded on the disc, you can change the subtitle language while playing, or turn the subtitles on or off whenever you want.

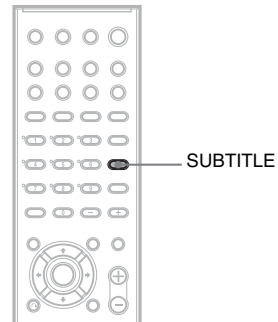

Press SUBTITLE during playback.

Each time you press SUBTITLE, the subtitle language changes.

Note

- Depending on the DVD VIDEO, you may not be able to change the subtitles even if multilingual subtitles are recorded on it. You also may not be able to turn them off.
- You can change the subtitles if the DivX video file has an ".AVI" or ".DIVX" extension and contains subtitle information within the same file. (Except for the United Kingdom models.)

Locking Discs

(CUSTOM PARENTAL CONTROL, PARENTAL CONTROL)

DVD-V VIDEO CD C D

You can set 2 kinds of playback restrictions for the desired disc.

- Custom Parental Control
You can set playback restrictions so that the system will not play inappropriate discs.
- Parental Control
Playback of some DVD VIDEOS can be limited according to a predetermined level such as the age of the users. Scenes may be blocked or replaced with different scenes. The same password is used for both Custom Parental Control and Parental Control.

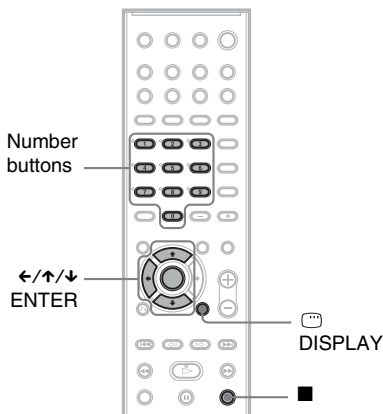

Preventing playback of specific discs [CUSTOM PARENTAL CONTROL]

You can set the same Custom Parental Control password for up to 40 discs. When you set the 41st-disc, the first disc is canceled.

- 1 Insert the disc you want to lock.**
If the disc is playing, press ■ to stop playback.
- 2 Press  DISPLAY while the system is in stop mode.**
The Control Menu appears.

- 3 Press  to select  [PARENTAL CONTROL], then press ENTER.**

The options for [PARENTAL CONTROL] appear.

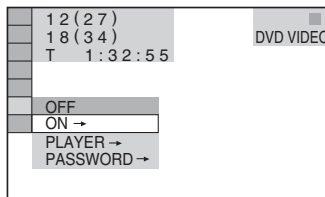

- 4 Press  to select [ON ->], then press ENTER.**

■ **If you have not entered a password**
The display for registering a new password appears.

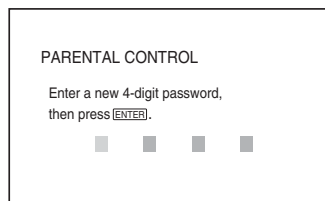

Enter a 4-digit password using the number buttons, then press ENTER.
The display for confirming the password appears.

■ **When you have already registered a password**
The display for entering the password appears.

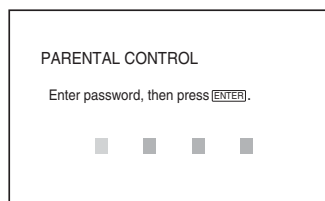

- 5 Enter or re-enter your 4-digit password using the number buttons, then press ENTER.**

[Custom parental control is set.] appears and the screen returns to the Control Menu.

To turn off the Custom Parental Control function

- 1 Follow steps 1 through 3 of “Preventing playback of specific discs [CUSTOM PARENTAL CONTROL].”
- 2 Press \uparrow/\downarrow to select [OFF \rightarrow], then press ENTER.
- 3 Enter your 4-digit password using the number buttons, then press ENTER.

To play a disc for which Custom Parental Control is set

- 1 Insert the disc for which Custom Parental Control is set.
The [CUSTOM PARENTAL CONTROL] display appears.

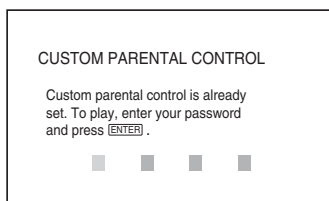

- 2 Enter your 4-digit password using the number buttons, then press ENTER.
The system is ready for playback.

Tip

- If you forget your password, enter the 6-digit number “199703” using the number buttons when the [CUSTOM PARENTAL CONTROL] display asks you for your password, then press ENTER. The display will ask you to enter a new 4-digit password.

Limiting playback for children [PARENTAL CONTROL]

(DVD only)

Playback of some DVD VIDEOS can be limited according to a predetermined level such as the age of the users. The [PARENTAL CONTROL] function allows you to set a playback limitation level.

- 1 Press \square DISPLAY while the system is in stop mode.

The Control Menu appears.

- 2 Press \uparrow/\downarrow to select  [PARENTAL CONTROL], then press ENTER.

The options for [PARENTAL CONTROL] appear.

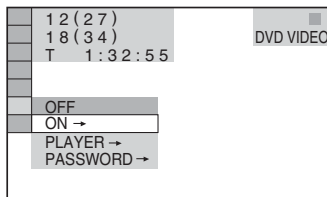

- 3 Press \uparrow/\downarrow to select [PLAYER \rightarrow], then press ENTER.

■ **If you have not entered a password**
The display for registering a new password appears.

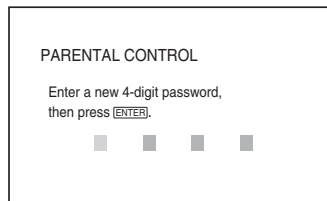

Enter a 4-digit password using the number buttons, then press ENTER.

The display for confirming the password appears.

■ **When you have already registered a password**
The display for entering the password appears.

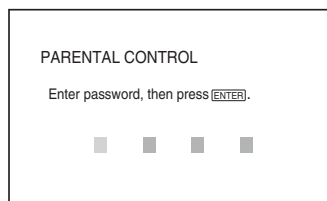

continued

- 4** Enter or re-enter your 4-digit password using the number buttons, then press **ENTER**.

The display for setting the playback limitation level appears.

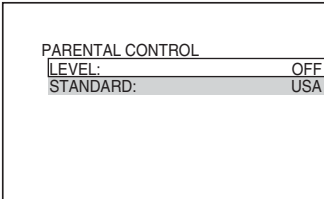

- 5** Press **↑/↓** to select **[STANDARD]**, then press **ENTER**.

The selection items for **[STANDARD]** are displayed.

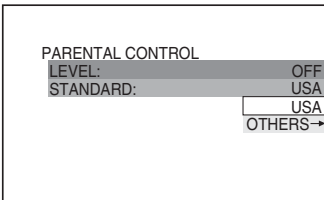

- 6** Press **↑/↓** to select a geographic area as the playback limitation level, then press **ENTER**.

The area is selected.

When you select **[OTHERS →]**, select and enter a standard code in the table on page 55 using the number buttons.

- 7** Press **↑/↓** to select **[LEVEL]**, then press **ENTER**.

The selection items for **[LEVEL]** are displayed.

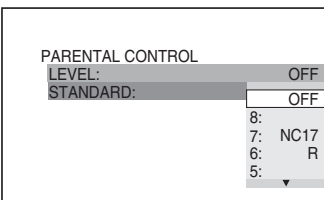

- 8** Press **↑/↓** to select the level you want, then press **ENTER**.

Parental Control setting is complete.

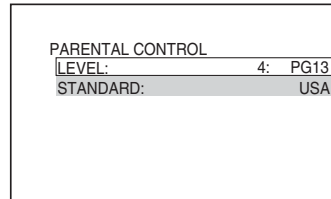

The lower the value, the stricter the limitation.

To turn off the Parental Control function

Set **[LEVEL]** to **[OFF]** in Step 8.

To play a disc for which Parental Control is set

- 1** Insert the disc and press **▷**.

The display for entering your password appears.

- 2** Enter your 4-digit password using the number buttons, then press **ENTER**.

The system starts playback.

Tip

- If you forget your password, remove the disc and repeat steps 1 to 3 of “Preventing playback of specific discs [CUSTOM PARENTAL CONTROL].” When you are asked to enter your password, enter “199703” using the number buttons, then press **ENTER**. The display will ask you to enter a new 4-digit password. After you enter a new 4-digit password, replace the disc in the system and press **▷**. When the display for entering your password appears, enter your new password.

Note

- When you play discs which do not have the Parental Control function, playback cannot be limited on this system.
- Depending on the disc, you may be asked to change the parental control level while playing the disc. In this case, enter your password, then change the level. If the Resume Play mode is canceled, the level returns to the previous level.

Area Code

Standard	Code number	Standard	Code number
Argentina	2044	Malaysia	2363
Australia	2047	Mexico	2362
Austria	2046	Netherlands	2376
Belgium	2057	New Zealand	2390
Brazil	2070	Norway	2379
Canada	2079	Pakistan	2427
Chile	2090	Philippines	2424
China	2092	Portugal	2436
Denmark	2115	Russia	2489
Finland	2165	Singapore	2501
France	2174	Spain	2149
Germany	2109	Sweden	2499
India	2248	Switzerland	2086
Indonesia	2238	Thailand	2528
Italy	2254	United Kingdom	2184
Japan	2276		
Korea	2304		

- 6** To confirm your password, re-enter it using the number buttons, then press ENTER.

If you make a mistake entering your password

Press ← before you press ENTER and input the correct number.

Changing the password

- 1** Press  DISPLAY while the system is in stop mode.

The Control Menu appears.

- 2** Press ↑/↓ to select  [PARENTAL CONTROL], then press ENTER.

The options for [PARENTAL CONTROL] appear.

- 3** Press ↑/↓ to select [PASSWORD →], then press ENTER.

The display for entering the password appears.

- 4** Enter your 4-digit password using the number buttons, then press ENTER.

- 5** Enter a new 4-digit password using the number buttons, then press ENTER.

Other Operations

Controlling the TV with the Supplied Remote

You can control your TV (SONY only) with the supplied remote.

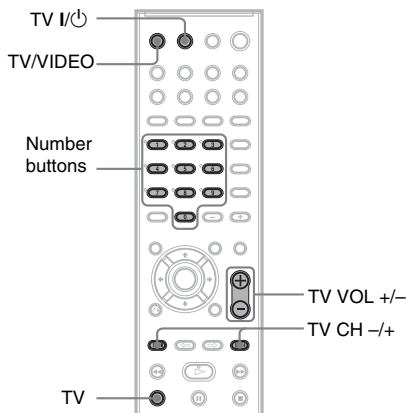

You can select the TV channels by using the number buttons.

-/- is for selecting a channel number greater than 10. (For example, for channel 25, press -/-, then 2 and 5.)

Note

- Depending on the TV, you may not be able to control your TV or to use some of the buttons above.

Controlling TVs with the remote

To control the TV

You can control the TV by using following buttons.

By pressing	You can
TV I/O	Turn the TV on or off.
TV/VIDEO	Switch the TV's input source between the TV and other input sources.
TV VOL +/- while pressing the TV button	Adjust the TV volume.
TV CH +/- while pressing the TV button	Select the TV channel.
Number buttons while pressing the TV button	Select the TV channel.

Using the THEATRE SYNC Function

THEATRE SYNC allows you to turn on your SONY TV and this system, changes the system mode to "DVD," and then switches the TV's input source you set with one button push.

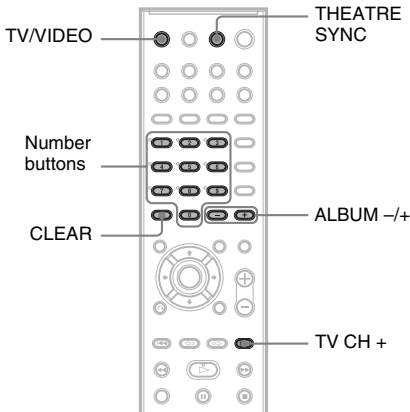

Preparing for the THEATRE SYNC function

Register the TV's input source connected to this system.

Press and hold TV/VIDEO while entering the code for the TV's input source connected to this system (see the table) using the number buttons.

The TV's input source is selected. Set your TV's input to the input you used to connect the system. For details, see the instructions of your TV.

By pressing	Number	TV's input source
TV/VIDEO	0	No input source (Default)
	1	VIDEO1
	2	VIDEO2
	3	VIDEO3
	4	VIDEO4
	5	VIDEO5
	6	VIDEO6
	7	VIDEO7
	8	VIDEO8
	9*	COMPONENT 1 INPUT
	CLEAR*	COMPONENT 2 INPUT
	ALBUM -*	COMPONENT 3 INPUT
	ALBUM +*	COMPONENT 4 INPUT

* Except for North American models.

Operating for the THEATRE SYNC function

Point the remote to the direction of TV and this system, then press THEATRE SYNC once.

If this function does not work, change the transmit time. The transmit time varies depending on the TV.

To change the transmit time

Press and hold TV CH + while entering the code for transmit time (see the table) using the number buttons.

The transmit time from the remote is selected.

By pressing	Number	Transmit time
TV CH +	1	0.5 (Default)
	2	1
	3	1.5
	4	2
	5	2.5
	6	3
	7	3.5
	8	4

Note

- This function is only for SONY TVs. (This function may not work on some SONY TVs.)
- If distance between TV and this system is too far, this function may not work. Install the system near the TV.
- Keep the remote pointed in the direction of the TV and this system while entering the code.

Enjoying the Radio

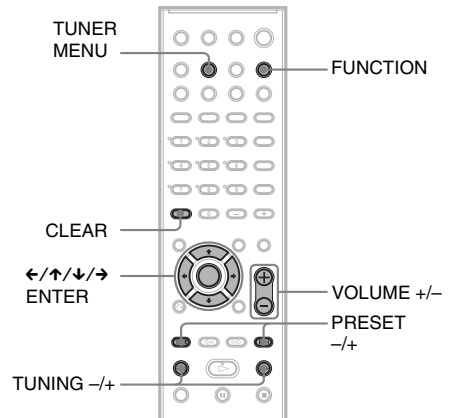

Presetting radio stations

You can preset 20 FM stations, and 10 AM stations. Before tuning, make sure to turn down the volume to minimum.

- 1 Press FUNCTION repeatedly until the band you want appears in the front panel display.**
- 2 Press and hold TUNING + or – until the auto scanning starts.**
Scanning stops when the system tunes in a station. “TUNED” and “ST” (for stereo program) appear in the front panel display.

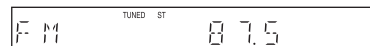

- 3 Press TUNER MENU.**
- 4 Press </>/</> repeatedly until “MEMORY” appears in the front panel display.**
- 5 Press ENTER.**
A preset number appears in the front panel display.

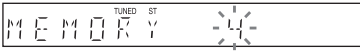

- 6** Press \uparrow/\downarrow to select the preset number you want.

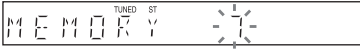

- 7** Press ENTER.
The station is stored.



- 8** Repeat 1 to 7 to store other stations.

To change the preset number

Restart from Step 1.

Listening to the radio

Preset radio stations in the system's memory first (see "Presetting radio stations" (page 58)).

- 1** Press FUNCTION repeatedly until "FM" or "AM" appears in the front panel display.

The last received station is tuned in.

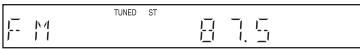

- 2** Press PRESET + or – repeatedly to select the preset station you want.

Each time you press the button, the system tunes in one preset station.

Each time you press TUNER/BAND, the band changes between FM and AM.

- 3** Adjust the volume by pressing VOLUME +/-.

To turn off the radio

Press \mathbb{I}/\mathbb{O} .

To listen to non-preset radio stations

Use manual or automatic tuning in Step 2. For manual tuning, press TUNING + or – repeatedly.

For automatic tuning, press and hold TUNING + or –. Press \blacksquare when you stop the automatic tuning.

Tip

- If an FM program is noisy, press FM MODE so that "MONO" appears in the front panel display. There will be no stereo effect, but the reception will improve. Press the button again to restore the stereo effect.
- To improve reception, reorient the supplied antennas (aerials).
- You can check the frequency by pressing DISPLAY repeatedly (page 43).

Naming preset stations

You can enter a name for preset stations. These names (for example, "XYZ") appear in the system's front panel display when a station is selected.

Note that no more than one name can be entered for each preset station.

- 1** Press FUNCTION repeatedly until "FM" or "AM" appears in the front panel display.

The last station you received is tuned in.

- 2** Press PRESET + or – repeatedly to select the preset station you want to create an index name for.

- 3** Press TUNER MENU.

- 4** Press $\leftarrow/\uparrow/\downarrow/\rightarrow$ repeatedly until "NAME IN" appears in the front panel display.



- 5** Press ENTER.

- 6** Create a name by using the cursor buttons.

Press \uparrow/\downarrow to select a character, then press \rightarrow to move the cursor to the next position.

Letters, numbers, and other symbols can be input for a radio station name.

If you make a mistake

Press \leftarrow/\rightarrow repeatedly until the character to be changed flashes, then press \uparrow/\downarrow to select the desired character.

continued

To erase the character, press ←/→ repeatedly until the character to be erased flashes, then press CLEAR.

7 Press ENTER.

The station name is stored.

Using the Radio Data System (RDS)

What is the Radio Data System?

The Radio Data System (RDS) is a broadcasting service that allows radio stations to send additional information along with the regular program signal. This tuner offers convenient RDS features, such as station name display. RDS is available only for FM stations.*

Note

- RDS may not work properly if the station you are tuned to is not transmitting the RDS signal properly, or if the signal strength is weak.
- * Not all FM stations provide RDS service, nor do they provide the same type of services. If you are not familiar with the RDS system, check with your local radio stations for details on RDS services in your area.

Receiving RDS broadcasts

Simply select a station from the FM band.

When you tune in a station that provides RDS services, the station name* appears in the front panel display.

- * If an RDS broadcast is not received, the station name may not appear in the front panel display.

Using the Sleep Timer

You can set the system to turn off at a preset time, so you can fall asleep listening to music. You can preset the time in 10 minutes decrements.

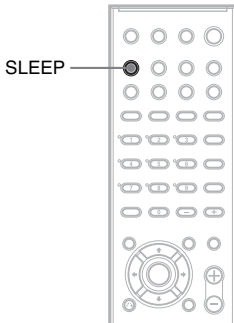

Press SLEEP.

Each time you press this button, the minutes display (the remaining time) changes as follows:

SLEEP 90M → SLEEP 80M → SLEEP 70M
↑
SLEEP OFF ← SLEEP 10M SLEEP 60M ↓

To check the remaining time

Press SLEEP once.

To change the remaining time

Press SLEEP repeatedly to select the desired time.

To cancel the Sleep Timer function

Press SLEEP repeatedly until "SLEEP OFF" appears in the front panel display.

Changing the Brightness of the Front Panel Display

The brightness of the front panel display can be set to either of 2 levels.

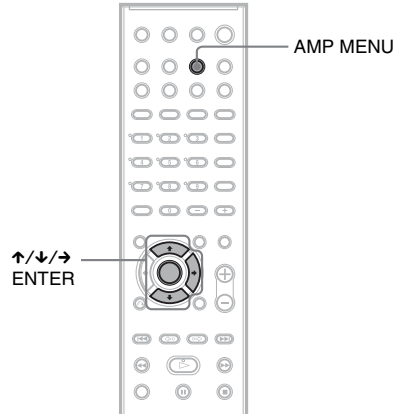

- 1 Press AMP MENU.**
- 2 Press ↑/↓ repeatedly until "DIMMER" appears in the front panel display, then press ENTER or →.**
- 3 Press ↑/↓ to select the brightness of the front panel display.**
- 4 Press ENTER or AMP MENU.**
The AMP menu turns off.

Returning to the Default Settings

You can return the system parameters, such as preset stations, to the default settings.

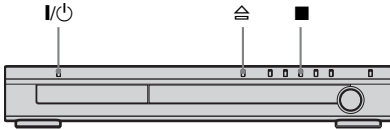

- 1 Press I/⏻ to turn on the system.**
- 2 Press ■, ⏮, and I/⏻ on the system at the same time.**

“COLD RESET” appears in the front panel display and the default settings are returned.

Settings and Adjustments

Using the Setup Display

By using the Setup Display, you can make various adjustments to items such as picture and sound.

For an overall list of Setup Display items, see page 83.

Displayed items differ depending on the country model.

Note

- Playback settings stored in the disc take priority over the Setup Display settings and not all the functions described may work.

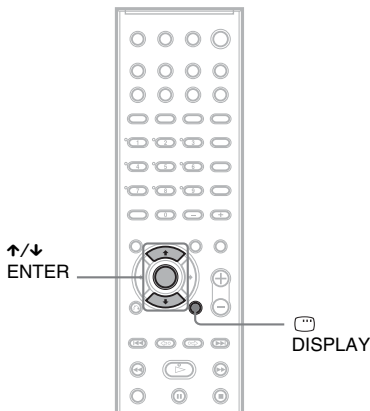

- 1 Press  DISPLAY when the system is in stop mode.**

The Control Menu appears.

- 2 Press \uparrow/\downarrow to select  [SETUP], then press ENTER.**

The options for [SETUP] appear.

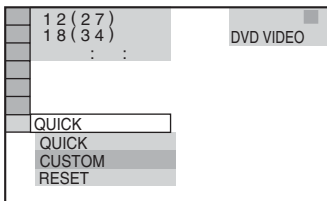

- 3 Press \uparrow/\downarrow to select [CUSTOM], then press ENTER.**

The Setup Display appears.

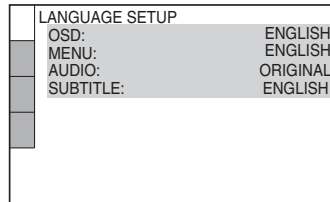

- 4 Press \uparrow/\downarrow to select the setup item from the displayed list: [LANGUAGE SETUP], [SCREEN SETUP], [CUSTOM SETUP], or [SPEAKER SETUP]. Then press ENTER.**

The Setup item is selected.

Example: [SCREEN SETUP]

Selected item

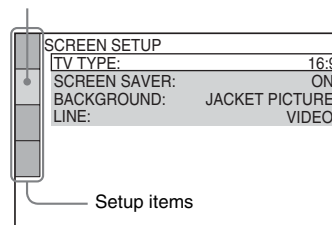

- 5 Select an item using \uparrow/\downarrow , then press ENTER.**

The options for the selected item appear.

Example: [TV TYPE]

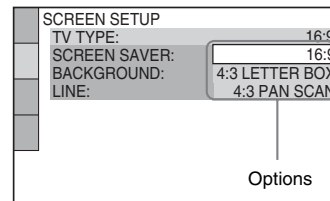

- 6 Select a setting using \uparrow/\downarrow , then press ENTER.**

The setting is selected and setup is complete.

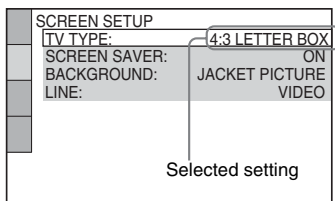

To reset all of the [SETUP] settings

- 1 Select [RESET] in Step 3 and press ENTER.
- 2 Select [YES] using \uparrow/\downarrow .
You can also quit the process and return to the Control Menu by selecting [NO] here.
- 3 Press ENTER.
All the settings explained on pages 64 to 69 return to the default settings. Do not press I/\downarrow while resetting the system as it takes a few seconds to complete.

Note

- When you turn the system on after resetting and no disc is in the system, the guide message appears on the TV screen. To perform the Quick Setup (page 21), press ENTER, to return to normal screen, press CLEAR.

Setting the Display or Sound Track Language

[LANGUAGE SETUP]

[LANGUAGE SETUP] allows you to set various languages for the on-screen display or sound track.

Select [LANGUAGE SETUP] in the Setup Display. To use the display, see “Using the Setup Display” (page 63).

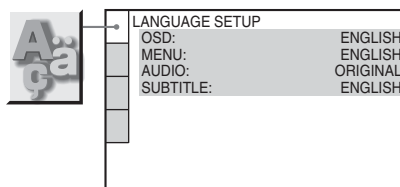

■ [OSD] (On-Screen Display)

Switches the display language on the screen.

■ [MENU] (DVD VIDEO only)

You can select the desired language for the disc's menu.

■ [AUDIO] (DVD VIDEO only)

Switches the language of the sound track. When you select [ORIGINAL], the language given priority in the disc is selected.

■ [SUBTITLE] (DVD VIDEO only)

Switches the language of the subtitle recorded on the DVD VIDEO. When you select [AUDIO FOLLOW], the language for the subtitles changes according to the language you selected for the sound track.

Tip

- If you select [OTHERS \rightarrow] in [MENU], [AUDIO], and [SUBTITLE], select and enter a language code from “Language Code List” (page 78) using the number buttons.

Note

- When you select a language in [MENU], [AUDIO], or [SUBTITLE] that is not recorded on the DVD VIDEO, one of the recorded languages will be automatically selected (depending on the disc, the language may not be selected automatically).

Settings for the Display

[SCREEN SETUP]

Choose settings according to the TV to be connected.

Select [SCREEN SETUP] in the Setup Display. To use the display, see "Using the Setup Display" (page 63).

The default settings are underlined.

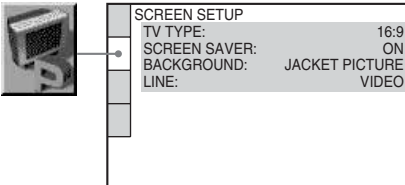

■ [TV TYPE]

Selects the aspect ratio of the connected TV (4:3 standard or wide).

The default setting varies, depending on the country model.

[4:3 LETTER BOX] Select this when you connect a 4:3 screen TV. Displays a wide picture with bands on the upper and lower portions of the screen.

[4:3 PAN SCAN] Select this when you connect a 4:3 screen TV. Automatically displays the wide picture on the entire screen and cuts off the portions that do not fit.

[16:9] Select this when you connect a wide-screen TV or a TV with a wide mode function.

[4:3 LETTER BOX]



[4:3 PAN SCAN]

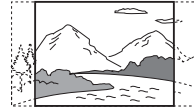

[16:9]

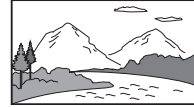

Note

- Depending on the DVD, [4:3 LETTER BOX] may be selected automatically instead of [4:3 PAN SCAN] or vice versa.

■ [SCREEN SAVER]

The screen saver image appears when you leave the system in pause or stop mode for 15 minutes, or when you play back a CD or DATA CD (MP3 audio) for more than 15 minutes. The screen saver will help prevent your display device from becoming damaged (ghosting). Press any button (e.g., button) to cancel the screen saver.

[ON] Turns on the screen saver.

[OFF] Turns off the screen saver.

■ [BACKGROUND]

Selects the background color or picture on the TV screen in stop mode or while playing a CD or DATA CD (MP3 audio).

[JACKET PICTURE] The jacket picture (still picture) appears, but only when the jacket picture is already recorded on the disc (CD-EXTRA, etc.). If the disc does not contain a jacket picture, the [GRAPHICS] picture appears.

[GRAPHICS] A preset picture stored in the system appears.

[BLUE] The background color is blue.

[BLACK] The background color is black.

■ [LINE]

Selects the output method for video signals from the EURO AV \leftrightarrow OUTPUT (TO TV) jack on the rear panel of the system.

[VIDEO] Outputs video signals.

[RGB] Outputs RGB signals.

Note

- If your TV does not accept RGB signals, no picture appears on the TV screen even if you select [RGB]. Refer to the instructions supplied with your TV.

Custom Settings

[CUSTOM SETUP]

Use this to set up playback related and other settings.

Select [CUSTOM SETUP] in the Setup Display. To use the display, see “Using the Setup Display” (page 63).

The default settings are underlined.

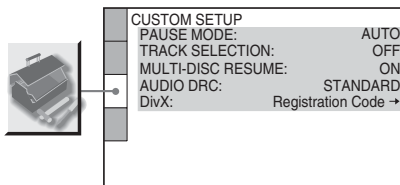

■ [PAUSE MODE] (DVD VIDEO/DVD-RW only)

Selects the picture in pause mode.

[AUTO] The picture, including subjects that move dynamically, is output with no jitter. Normally select this position.

[FRAME] The picture, including subjects that do not move dynamically, is output in high resolution.

■ [TRACK SELECTION] (DVD VIDEO only)

Gives the sound track which contains the highest number of channels priority when you play a DVD VIDEO on which multiple audio formats (PCM, DTS, MPEG audio, or Dolby Digital format) are recorded.

[OFF] No priority given.

[AUTO] Priority given.

Note

- When you set the item to [AUTO], the language may change. The [TRACK SELECTION] setting has higher priority than the [AUDIO] settings in [LANGUAGE SETUP] (page 64). (Depending on the disc, this function may not work.)
- If PCM, DTS, Dolby Digital sound, and MPEG audio tracks have the same number of channels, the system

selects PCM, DTS, Dolby Digital sound, and MPEG audio tracks in this order.

■ **[MULTI-DISC RESUME] (DVD VIDEO/VIDEO CD only)**

Switches the Multi-disc Resume setting on or off.

[ON]	Stores the resume settings in memory for up to 40 discs.
[OFF]	Does not store the resume settings in memory. Playback restarts at the resume point only for the current disc in the system.

■ **[AUDIO DRC] (Dynamic Range Control) (DVD VIDEO/DVD-RW only)**

Narrows the dynamic range of the sound track. Useful for watching movies at low volume late at night.

[OFF]	No compression of dynamic range.
[STANDARD]	Reproduces the sound track with the kind of dynamic range that the recording engineer intended.
[MAX]	Compresses dynamic range at the maximum.

Note

• [AUDIO DRC] only applies to Dolby Digital sources.

■ **[DivX] (except for the United Kingdom models)**

Displays the registration code for this system. For more information, go to <http://www.divx.com> on the Internet.

Settings for the Speakers

[SPEAKER SETUP]

To obtain the best possible surround sound, set for the size of the speakers you have connected and their distance from your listening position. Then use the test tone to adjust the level and the balance of the speakers to the same level.

Select [SPEAKER SETUP] in the Setup Display. For details, see “Using the Setup Display” (page 63).

The default settings are underlined>.

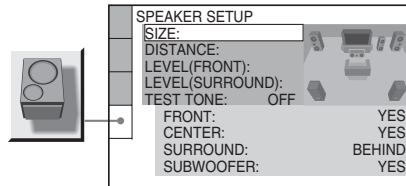

To return to the default setting when changing a setting

Select the item, then press CLEAR. Note that only the [SIZE] setting does not return to the default setting.

■ **[SIZE]**

If you do not connect center or surround speakers, or move the surround speakers, set the parameters for [CENTER] and [SURROUND] and specify the surround speaker position. Since the front speaker setting is fixed, you cannot change them.

Position diagram

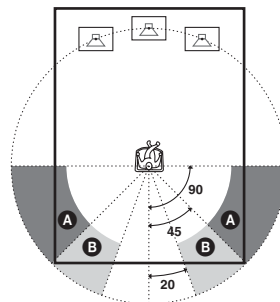

continued

[FRONT]	[YES]
[CENTER]	[YES] : Normally select this. [NONE] : Select this if no center speaker is used.
[SURROUND]	[BEHIND] : Select this if surround speakers are located in section B . [SIDE] : Select this if surround speakers are located in section A . [NONE] : Select this if no surround speaker is used.
[SUBWOOFER]	[YES]

Note

- When you select an item, the sound cuts off for a moment.

■ **[DISTANCE]**

The default distance setting for the speakers in relation to the listening position is shown below. When you set the distance using the Quick Setup (page 21), the settings is automatically displayed.

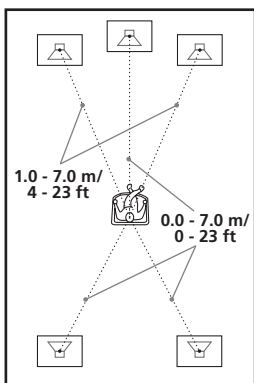

Be sure to change the value in the Setup Display when you move the speakers.

[FRONT] 3.0 m/10 ft*	Front speaker distance from the listening position can be set in 0.2 meter (1 ft) increments from 1.0 to 7.0 meters (4 to 23 ft).
[CENTER] 3.0 m/10 ft* (appears when you set [CENTER] to [YES] in the [SIZE] setting.)	Center speaker distance from the listening position can be set in 0.2 meter (1 ft) increments from 0.0 to 7.0 meters (0 to 23 ft).

[SURROUND] 3.0 m/10 ft* (appears except when you set [SURROUND] to [NONE] in the [SIZE] setting.)	Surround speaker distance from the listening position can be set in 0.2 meter (1 ft) increments from 0.0 to 7.0 meters (0 to 23 ft).
---	--

* When you perform the Quick Setup (page 21), the default settings are changed.

Note

- When you set the distance, the sound cuts off for a moment.
- If all front and surround speakers are not placed at an equal distance from your listening position, set the distance according to the closest speaker.
- Do not place the surround speakers farther away from your listening position than the front speakers.
- Depending on the input stream, the [DISTANCE] setting may not be effective.

■ **[LEVEL (FRONT)]**

You can vary the level of front speakers as follows. Be sure to set [TEST TONE] to [ON] for easy adjustment.

[L] 0 dB	Set this between -6 dB and 0 dB in 1 dB increments.
[R] 0 dB	Set this between -6 dB and 0 dB in 1 dB increments.
[CENTER] 0 dB (appears when you set [CENTER] to [YES] in the [SIZE] setting.)	Set this between -6 dB and +6 dB in 1 dB increments.
[SUBWOOFER] 0 dB	Set this between -6 dB and +6 dB in 1 dB increments.

■ **[LEVEL (SURROUND)]**

You can vary the level of surround speakers as follows. Be sure to set [TEST TONE] to [ON] for easy adjustment.

(This settings appear except when you set [SURROUND] to [NONE] in the [SIZE] setting.)

[L] 0 dB	Set this between -6 dB and +6 dB in 1 dB increments.
[R] 0 dB	Set this between -6 dB and +6 dB in 1 dB increments.

To adjust the volume of all the speakers at one time

Use the VOLUME control on the system, or press VOLUME +/- on the remote.



■ [TEST TONE]

The speakers will emit a test tone to adjust [LEVEL (FRONT)] and [LEVEL (SURROUND)].

[OFF] The test tone is not emitted from the speakers.

[ON] The test tone is emitted from each speaker in sequence while adjusting level. When you select one of the [SPEAKER SETUP] items, the test tone is emitted from each speaker in sequence.

Adjusting the speaker level by using the test tone

- 1** Press  **DISPLAY** when the system is in stop mode.
The Control Menu appears.
- 2** Press \uparrow/\downarrow to select  [SETUP], then press **ENTER**.
The options for [SETUP] appear.
- 3** Press \uparrow/\downarrow to select [CUSTOM], then press **ENTER**.
The Setup Display appears.
- 4** Press \uparrow/\downarrow repeatedly to select [SPEAKER SETUP], then press **ENTER** or \rightarrow .
- 5** Press \uparrow/\downarrow repeatedly to select [TEST TONE], then press **ENTER** or \rightarrow .
- 6** Press \uparrow/\downarrow repeatedly to select [ON], then press **ENTER**.
You will hear the test tone from each speaker in sequence.
- 7** From your listening position, adjust the value of [LEVEL (FRONT)] or [LEVEL (SURROUND)] using $\leftarrow/\uparrow/\downarrow/\rightarrow$.
The test tone is emitted from only the speaker which you are adjusting.
- 8** Press **ENTER** when you have finished making adjustments.

9 Press \uparrow/\downarrow repeatedly to select [TEST TONE], then press **ENTER**.

10 Press \uparrow/\downarrow repeatedly to select [OFF], then press **ENTER**.

Note

- When you adjust the speaker settings, the sound cuts off for a moment.

Additional Information

Precautions

On power sources

- AC power cord (mains lead) must be changed only at the qualified service shop.

On placement

- Place the system in a location with adequate ventilation to prevent heat build-up in the system.
- At high volume, over long periods of time, the cabinet becomes hot to the touch. This is not a malfunction. However, touching the cabinet should be avoided. Do not place the unit in a confined space where ventilation is poor as this may cause overheating.
- Do not block the ventilation slots by putting anything on the system. The system is equipped with a high power amplifier. If the ventilation slots are blocked, the unit can overheat and malfunction.
- Do not place the system on a soft surface such as a rug and do not block the ventilation holes.
- Do not place the system in a location near heat sources, or in a place subject to direct sunlight, excessive dust, or mechanical shock.

On operation

- If the system is brought directly from a cold to a warm location, or is placed in a very damp room, moisture may condense on the lenses inside the system. Should this occur, the system may not operate properly. In this case, remove the disc and leave the system turned on for about half an hour until the moisture evaporates.
- When you move the system, take out any disc. If you don't, the disc may be damaged.

On adjusting volume

- Do not turn up the volume while listening to a section with very low level inputs or no audio signals. If you do, the speakers may be damaged when a peak level section is suddenly played.

On cleaning

- Clean the cabinet, panel, and controls with a soft cloth slightly moistened with a mild detergent solution. Do not use any type of abrasive pad, scouring powder or solvent such as alcohol or benzine.
If you have any questions or problems concerning your system, please consult your nearest Sony dealer.

On cleaning discs, disc/lens cleaner

- Do not use a commercially available cleaning disc or disc/lens cleaner (wet or spray type). These may cause apparatus to malfunction.

On your TV's color

- If the speakers should cause the TV screen to have color irregularity, turn off the TV then turn it on after 15 to 30 minutes. If color irregularity should persist, place the speakers farther away from the set.

IMPORTANT NOTICE

Caution: This system is capable of holding a still video image or on-screen display image on your television screen indefinitely. If you leave the still video image or on-screen display image displayed on your TV for an extended period of time you risk permanent damage to your television screen. Projection televisions are especially susceptible to this.

On moving the system

When you carry the system, use the following procedure to protect the inner mechanism.

- 1 Press FUNCTION repeatedly to select "DVD."
- 2 Make sure that all discs are removed from the system.
- 3 Press ■ and I/⏻ simultaneously. "MECHA LOCK" appears in the front panel display after "STANDBY."
- 4 Remove the AC power cord (mains lead) from the wall outlet (mains).

Notes about the Discs

On handling discs

- To keep the disc clean, handle the disc by its edge. Do not touch the surface.
- Do not stick paper or tape on the disc.



- Do not expose the disc to direct sunlight or heat sources such as hot air ducts, or leave it in a car parked in direct sunlight as the temperature may rise considerably inside the car.
- After playing, store the disc in its case.

On cleaning

- Before playing, clean the disc with a cleaning cloth. Wipe the disc from the center out.



- Do not use solvents such as benzine, thinner, commercially available cleaners, or anti-static spray intended for vinyl LPs.

This system can only play back a standard circular disc. Using neither standard nor circular discs (e.g., card, heart, or star shape) may cause a malfunction.

Do not use a disc that has a commercially available accessory attached, such as a label or ring.

Troubleshooting

If you experience any of the following difficulties while using the system, use this troubleshooting guide to help remedy the problem before requesting repairs. Should any problem persist, consult your nearest Sony dealer.

Note that if service personnel changes some parts during repair, these parts may be retained.

Power

The power is not turned on.

- Check that the AC power cord (mains lead) is connected securely.

If “PROTECT” and “UNPLUG” appears alternately in the front panel display.

Immediately unplug the AC power cord (mains lead) and check the following items.

- Are the + and – speaker cords short-circuited?
- Are you using only the specified speakers?
- Is anything blocking the ventilation holes of the system?

After checking the above items and fixing any problems, connect the AC power cord (mains lead) again and turn on the system. If the cause of the problem cannot be found even after checking all the above items, consult your nearest Sony dealer.

Picture

There is no picture.

- The SCART (EURO AV) cord is not connected securely.
- The SCART (EURO AV) cord is damaged.
- The system is not connected to the correct EURO AV \rightarrow INPUT jack (page 19).
- The video input on the TV is not set so that you can view pictures from the system.
- Check the output method on your system (page 66).

Picture noise appears.

- The disc is dirty or flawed.

Even though you set the aspect ratio in [TV TYPE] of [SCREEN SETUP], the picture does not fill the screen.

- The aspect ratio on the disc is fixed.

Sound

There is no sound.

- The speaker cord is not connected securely.
- Press **MUTING** on the remote if “MUTING ON” is displayed in the front panel display.
- The system is in pause mode or in Slow-motion Play mode. Press \triangleright to return to normal play mode.
- Fast forward or fast reverse is performed. Press \triangleright to return to normal play mode.
- Check the speaker settings (page 67).

The left and right sounds are unbalanced or reversed.

- Check that the speakers and components are connected correctly and securely.

There is no sound from the subwoofer.

- Check the speaker connections and settings (page 14, 67).
- Set the sound field to “AUTO FORMAT DIRECT AUTO” (page 48).

Severe hum or noise is heard.

- Check that the speakers and components are connected securely.
- Check that the connecting cords are away from a transformer or motor, and at least 3 meters (10 ft) away from your TV set or a fluorescent light.
- Move your TV away from the audio components.
- The plugs and jacks are dirty. Wipe them with a cloth slightly moistened with alcohol.
- Clean the disc.

The sound loses stereo effect when you play a VIDEO CD, a CD, or an MP3.

- Set [AUDIO] to [STEREO] by pressing **AUDIO** (page 46).
- Make sure the system is connected properly.

The surround effect is difficult to hear when you are playing a Dolby Digital, DTS, or MPEG audio sound track.

- Make sure the sound field function is on (page 48).
- Check the speaker connections and settings (page 14, 67).
- Depending on the DVD, the output signal may not be the entire 5.1 channel. It may be monaural or stereo even if the sound track is recorded in Dolby Digital or MPEG audio format.

The sound comes from the center speaker only.

- Depending on the disc, the sound may come from the center speaker only.

No sound is heard from the center speaker.

- Check the speaker connections and settings.
- Make sure the sound field function is on (page 48).
- Depending on the source, the effect of the center speaker may be less noticeable.

No sound or only a very low-level sound is heard from the surround speakers.

- Check the speaker connections and settings.
- Make sure the sound field function is on (page 48).
- Depending on the source, the effect of the surround speakers may be less noticeable.

Operation

Radio stations cannot be tuned in.

- Check that the antenna (aerial) is connected securely. Adjust the antenna (aerial) or connect an external antenna (aerial) if necessary.
- The signal strength of the stations is too weak (when tuning in with automatic tuning). Use direct tuning.
- No stations have been preset or the preset stations have been cleared (when tuning by scanning preset stations). Preset the stations (page 58).
- Press **DISPLAY** so that the frequency appears in the front panel display.

The remote does not function.

- There are obstacles between the remote and the system.
- The distance between the remote and the system is too far.
- The remote is not pointed at the remote sensor on the system.
- The batteries in the remote are weak.

The disc does not play.

- There is no disc inserted.
- The disc is upside down.
Insert the disc with the playback side facing down.
- The disc is skewed on the disc tray.
- The system cannot play CD-ROMs, etc. (page 7).
- The region code on the DVD does not match the system.
- Moisture has condensed inside the system and may cause damage to the lenses. Remove the disc and leave the system turned on for about half an hour.

The MP3 audio track cannot be played.

- The DATA CD is not recorded in the MP3 format that conforms to ISO 9660 Level 1/Level 2 or Joliet.
- The MP3 audio track does not have the extension “.MP3.”

- The data is not formatted in MP3 even though it has the extension “.MP3.”
- The data is not MPEG1 Audio Layer 3 data.
- The system cannot play audio tracks in MP3PRO format.
- The [MODE (MP3, JPEG)] setting has been set to [IMAGE (JPEG)] (page 34).
- If you cannot change the [MODE (MP3, JPEG)] setting, re-load the disc or turn the system off, then on.
- The DATA CD contains a DivX video file. (Except for the United Kingdom models.)
- This system cannot play MP3 audio files recorded on DATA DVDs.

The JPEG image file cannot be played.

- The DATA CD is not recorded in a JPEG format that conforms to ISO 9660 Level 1/Level 2, or Joliet.
- It has an extension other than “.JPEG” or “.JPG.”
- It is larger than 3,072 (width) × 2,048 (height) in normal mode, or more than 2,000,000 pixels in Progressive JPEG which is mainly used on the Internet WEB site.
- It does not fit the screen (those images are reduced).
- The [MODE (MP3, JPEG)] setting has been set to [AUDIO (MP3)] (page 34).
- If you cannot change the [MODE (MP3, JPEG)] setting, re-load the disc or turn the system off, then on.
- The DATA CD contains a DivX video file. (Except for the United Kingdom models.)
- This system cannot play JPEG image files recorded on DATA DVDs.

The MP3 audio tracks and JPEG image file starts playing simultaneously.

- [AUTO] has been selected in [MODE (MP3, JPEG)] (page 34).

The DivX video file cannot be played. (Except for the United Kingdom models.)

- The file is not created in DivX format.
- The file has an extension other than “.AVI” or “.DIVX.”
- The DATA CD (DivX video)/DATA DVD is not created in a DivX format that conforms to ISO 9660 Level 1/Level 2 or, Joliet/UDF.
- The DivX video file is larger than 720 (width) × 576 (height).

The titles of album/track/file name are not displayed correctly.

- The system can only display numbers and letters of the alphabets. Other characters are displayed as [*].

A disc does not start playing from the beginning.

- Program play, Shuffle Play, or Repeat Play has been selected.
Press CLEAR to cancel these functions before playing a disc.
- Resume Play has been selected.
During stop, press ■ on the system or the remote and then start playback (page 25).
- The title, DVD or PBC menu automatically appears on the TV screen.

The system starts playing the disc automatically.

- The DVD features an auto playback function.

Playback stops automatically.

- Some discs may contain an auto pause signal.
While playing such a disc, the system stops playback at the auto pause signal.

You cannot perform some functions such as Stop, Search, Slow-motion Play, or Repeat Play.

- Depending on the disc, you may not be able to perform some of the operations above. See the operating manual that came with the disc.

Messages do not appear on the screen in the language you want.

- In the Setup Display, select the desired language for the on-screen display in [OSD] under [LANGUAGE SETUP] (page 64).

The language for the sound track cannot be changed.

- Multilingual tracks are not recorded on the DVD being played.
- The DVD prohibits changing the language for the sound track.

The subtitle language cannot be changed.

- Multilingual subtitles are not recorded on the DVD being played.
- The DVD prohibits changing the subtitles.

The subtitle cannot be turned off.

- The DVD prohibits turning off subtitles.

The angles cannot be changed.

- Multi-angles are not recorded on the DVD being played (page 51).
- The DVD prohibits changing the angles.

A disc cannot be ejected and “LOCKED” appears in the front panel display.

- Contact your Sony dealer or local authorized Sony service facility.

[Data error] appears on the TV screen when playing a DATA CD or DATA DVD.

- The MP3 audio track/JPEG image file/DivX video file* you want to play is broken.
- The data is not MPEG1 Audio Layer 3 data.
- The JPEG image file format does not conform to DCF.
- The JPEG image file has the extension “.JPG” or “.JPEG,” but is not in JPEG format.
- The file you want to play has the extension “.AVI” or “.DIVX” but is not in DivX format, or is in DivX format but does not conform to a DivX Certified profiles.*

* Except for the United Kingdom models.

The system does not work normally.

- Disconnect the AC power cord (mains lead) from the wall outlet (mains), then reconnect after several minutes.

Self-diagnosis Function

(When letters/numbers appear in the display)

When the self-diagnosis function is activated to prevent the system from malfunctioning, a 5-character service number (e.g., C 13 50) with a combination of a letter and 4 digits appears on the screen and the front panel display. In this case, check the following table.



First 3 characters of the service number	Cause and/or corrective action
C 13	The disc is dirty. ➔ Clean the disc with a soft cloth (page 71).
C 31	The disc is not inserted correctly. ➔ Restart the system, then re-insert the disc correctly.
E XX (xx is a number)	To prevent a malfunction, the system has performed the self-diagnosis function. ➔ Contact your nearest Sony dealer or local authorized Sony service facility and give the 5-character service number. Example: E 61 10

Specifications

Amplifier section

Stereo mode (rated)	50 W + 50 W (3 ohms at 1 kHz, 1% THD)
Surround mode (reference)	RMS output power, 10 % THD Front: 67 W + 67 W (with SS-TS60) Center*: 67 W (with SS-CT54) Surround*: 67 W + 67 W (with SS-TS61) Subwoofer*: 65 W (with SS-WS34)

* Depending on the sound field settings and the source, there may be no sound output.

Inputs

TV	Sensitivity: 450 mV Impedance: 50 kilohms
----	--

DVD system

Laser	Semiconductor laser (DVD: $\lambda = 650$ nm) (CD: $\lambda = 790$ nm) Emission duration: continuous
Signal format system	PAL/NTSC
Frequency response (at 2 CH STEREO mode)	DVD (PCM): 2 Hz to 22 kHz (± 1.0 dB) CD: 2 Hz to 20 kHz (± 1.0 dB)
Harmonic distortion	Less than 0.03 %

Tuner section

System	PLL quartz-locked digital synthesizer system
FM tuner section	
Tuning range	87.5 – 108.0 MHz (50 kHz step)
Antenna (aerial)	FM wire antenna (aerial)
Antenna (aerial) terminals	75 ohms, unbalanced
Intermediate frequency	10.7 MHz
AM tuner section	
Tuning range	531 – 1,602 kHz (with the interval set at 9 kHz)
Antenna (aerial)	AM loop antenna (aerial)
Intermediate frequency	450 kHz

Video section

Outputs	Video: 1 V _{p-p} 75 ohms R/G/B: 0.7 V _{p-p} 75 ohms
---------	--

Speakers

Front

Speaker system	Bass reflex, magnetically shielded
Speaker unit	50 mm dia. cone type
Rated impedance	3 ohms
Dimensions (approx.)	68 × 126 × 55 mm (w/h/d)
Mass (approx.)	0.40 kg

Center

Speaker system	Bass reflex, magnetically shielded
Speaker unit	50 mm dia. cone type
Rated impedance	3 ohms
Dimensions (approx.)	125 × 69 × 51 mm (w/h/d)
Mass (approx.)	0.30 kg

Surround

Speaker system	Bass reflex
Speaker unit	50 mm dia. cone type
Rated impedance	3 ohms
Dimensions (approx.)	68 × 126 × 55 mm (w/h/d)
Mass (approx.)	0.30 kg

Subwoofer

Speaker system	Bass reflex, magnetically shielded
Speaker unit	150 mm dia. cone type
Rated impedance	3 ohms
Dimensions (approx.)	169 × 300 × 335 mm (w/h/d)
Mass (approx.)	3.7 kg

General

Power requirements	220 – 240 V AC, 50/60 Hz
Power consumption	On: 95 W Standby: 0.3 W (at the Power Saving mode)
Dimensions (approx.)	430 × 70 × 295 mm (w/h/d) incl. projecting parts
Mass (approx.)	3.6 kg
Supplied accessories	See page 12.

Design and specifications are subject to change without notice.

Glossary

Album

Section of a music piece or an image on a data CD containing MP3 audio tracks or JPEG files.

Chapter

Subdivision of a title on a DVD. A title is composed of several chapters.

DivX®

Digital video technology created by DivX, Inc. Videos encoded with DivX technology are among the highest quality with a relatively small file size.

Dolby Digital

This movie theater sound format for is more advanced than Dolby Surround Pro Logic. In this format, the surround speakers output stereo sound with an expanded frequency range, and a subwoofer channel for deep bass is independently provided. This format is also called "5.1" with the subwoofer channel designed as the 0.1 channel (since it functions only when a deep bass effect is needed). All six channels in this format are recorded separately for superior channel separation. Furthermore, since all the signals are processed digitally, less signal degradation occurs.

Dolby Pro Logic II

Dolby Pro Logic II creates five full-bandwidth output channels from 2 channel sources. This is done using an advanced, high-purity matrix surround decoder that extracts the spatial properties of the original recording without adding any new sounds or tonal colorations.

■ Movie mode

The Movie mode is for use with stereo television shows and all programs encoded in Dolby Surround. The result is enhanced soundfield directionality that approaches the quality of discrete 5.1-channel sound.

■ Music mode

The Music mode is for use with any stereo music recordings, and provides a wide and deep sound space.

Dolby Surround Pro Logic

As one method of decoding Dolby Surround, Dolby Surround Pro Logic produces four channels from 2 channel sound. Compared with the former Dolby Surround system, Dolby Surround Pro Logic reproduces left-to-right panning more naturally and localizes sounds more precisely. To take full advantage of Dolby Surround Pro Logic, you should have one pair of surround speakers and a center speaker. The surround speakers output monaural sound.

DTS

Digital audio compression technology developed by Digital Theater Systems, Inc. This technology conforms to 5.1-channel surround. This format comprises of stereo rear channel and there is discrete subwoofer channel in this format. DTS provides the same 5.1 discrete channels of high quality digital audio. The good channel separation is realized due to the all channel data being recorded discretely and processed in digitally.

DVD

A disc that contains up to 8 hours of moving pictures even though its diameter is the same as a CD.

The data capacity of a single-layer and single-sided DVD, at 4.7 GB (Giga Byte), is 7 times that of a CD. Furthermore, the data capacity of a dual-layer and single-sided DVD is 8.5 GB, a single-layer and double-sided DVD 9.4 GB, and a dual-layer and double-sided DVD 17 GB.

The picture data uses the MPEG 2 format, one of a worldwide standard of digital compression technology. The picture data is compressed to about 1/40 of its original size. The DVD also uses the variable rate coding technology that processes allocated data according to the status of the picture.

The audio data is recorded in Dolby Digital as well as in PCM, allowing you to enjoy more realistic audio presence.

Furthermore, various advanced functions such as the multi-angle, multilingual, and Parental Control functions are provided with the DVD.

DVD-RW

A DVD-RW is a recordable and rewritable disc that is the same size as a DVD VIDEO. The DVD-RW has two different modes: VR mode

and Video mode. DVD-RWs created in Video mode have the same format as a DVD VIDEO, while discs created in VR (Video Recording) mode allow the contents to be programmed or edited.

DVD+RW

A DVD+RW (plus RW) is a recordable and rewritable disc. DVD+RWs use a recording format that is comparable to the DVD VIDEO format.

File

A JPEG image recorded on a DATA CD or a DivX video* on a DATA CD/DATA DVD. ("File" is an exclusive definition for this system.) A single file consists of a single image.

* Except for the United Kingdom models.

Film based software, Video based software

DVDs can be classified as Film based or Video based software. Film based DVDs contain the same images (24 frames per second) that are shown at movie theaters. Video based DVDs, such as television dramas or sit-coms, displays images at 30 frames (or 60 fields) per second.

Multi-angle function

Various angles of a scene, or viewpoints of the video camera are recorded on some DVDs.

Multilingual function

Several languages for the sound or subtitles in a picture are recorded on some DVDs.

Parental Control

A function of the DVD to limit playback of the disc by the age of the users according to the limitation level in each country. The limitation varies from disc to disc; when it is activated, playback is completely prohibited, violent scenes are skipped or replaced with other scenes and so on.

Playback Control (PBC)

Signals encoded on VIDEO CDs (Version 2.0) to control playback.

By using menu screens recorded on VIDEO CDs with PBC functions, you can enjoy playing simple interactive programs, programs with search functions, and so on.

Region Code

This system is used to protect copyrights. A region number is allocated on each DVD system or DVD disc according to the sales region. Each region code is shown on the system as well as on the disc packaging. The system can play discs that match its region code. The system can also play discs with the "Ⓜ" mark. Even when the region code is not shown on the DVD, the region limit may still apply.

Scene

On a VIDEO CD with PBC (playback control) functions, the menu screens, moving pictures and still pictures are divided into sections called "scenes."

Title

The longest section of a picture or music feature on a DVD, movie, etc., in video software, or the entire album in audio software.

Track

Section of a picture or a music piece on a VIDEO CD, CD, or MP3. An album is composed of several tracks (MP3 only).

VIDEO CD

A compact disc that contains moving pictures. The picture data uses the MPEG 1 format, one of a worldwide standard of digital compression technology. The picture data is compressed to about 1/140 of its original size. Consequently, a 12 cm VIDEO CD can contain up to 74 minutes of moving pictures.

VIDEO CDs also contain compact audio data. Sounds outside the range of human hearing are compressed while sounds we can hear are not compressed. VIDEO CDs can hold 6 times the audio information of conventional audio CDs. There are 2 versions of VIDEO CDs.

- Version 1.1: You can play only moving pictures and sounds.
- Version 2.0: You can play high-resolution still pictures and enjoy PBC functions.

This system conforms to both versions.

Language Code List

The language spellings conform to the ISO 639: 1988 (E/F) standard.

Code	Language	Code	Language	Code	Language
1027	Afar	1245	Inupiak	1489	Russian
1028	Abkhazian	1248	Indonesian	1491	Kinyarwanda
1032	Afrikaans	1253	Icelandic	1495	Sanskrit
1039	Amharic	1254	Italian	1498	Sindhi
1044	Arabic	1257	Hebrew	1501	Sangho
1045	Assamese	1261	Japanese	1502	Serbo-Croatian
1051	Aymara	1269	Yiddish	1503	Singhalese
1052	Azerbaijani	1283	Javanese	1505	Slovak
1053	Bashkir	1287	Georgian	1506	Slovenian
1057	Byelorussian	1297	Kazakh	1507	Samoan
1059	Bulgarian	1298	Greenlandic	1508	Shona
1060	Bihari	1299	Cambodian	1509	Somali
1061	Bislama	1300	Kannada	1511	Albanian
1066	Bengali; Bangla	1301	Korean	1512	Serbian
1067	Tibetan	1305	Kashmiri	1513	Siswati
1070	Breton	1307	Kurdish	1514	Sesotho
1079	Catalan	1311	Kirghiz	1515	Sundanese
1093	Corsican	1313	Latin	1516	Swedish
1097	Czech	1326	Lingala	1517	Swahili
1103	Welsh	1327	Laothian	1521	Tamil
1105	Danish	1332	Lithuanian	1525	Telugu
1109	German	1334	Latvian; Lettish	1527	Tajik
1130	Bhutani	1345	Malagasy	1528	Thai
1142	Greek	1347	Maori	1529	Tigrinya
1144	English	1349	Macedonian	1531	Turkmen
1145	Esperanto	1350	Malayalam	1532	Tagalog
1149	Spanish	1352	Mongolian	1534	Setswana
1150	Estonian	1353	Moldavian	1535	Tonga
1151	Basque	1356	Marathi	1538	Turkish
1157	Persian	1357	Malay	1539	Tsonga
1165	Finnish	1358	Maltese	1540	Tatar
1166	Fiji	1363	Burmese	1543	Twi
1171	Faroese	1365	Nauru	1557	Ukrainian
1174	French	1369	Nepali	1564	Urdu
1181	Frisian	1376	Dutch	1572	Uzbek
1183	Irish	1379	Norwegian	1581	Vietnamese
1186	Scots Gaelic	1393	Occitan	1587	Volapük
1194	Galician	1403	(Afan) Oromo	1613	Wolof
1196	Guarani	1408	Oriya	1632	Xhosa
1203	Gujarati	1417	Punjabi	1665	Yoruba
1209	Hausa	1428	Polish	1684	Chinese
1217	Hindi	1435	Pashto; Pushto	1697	Zulu
1226	Croatian	1436	Portuguese		
1229	Hungarian	1463	Quechua	1703	Not specified
1233	Armenian	1481	Rhaeto-Romance		
1235	Interlingua	1482	Kirundi		
1239	Interlingue	1483	Romanian		

Index to Parts and Controls

For more information, refer to the pages indicated in parentheses.

Front panel

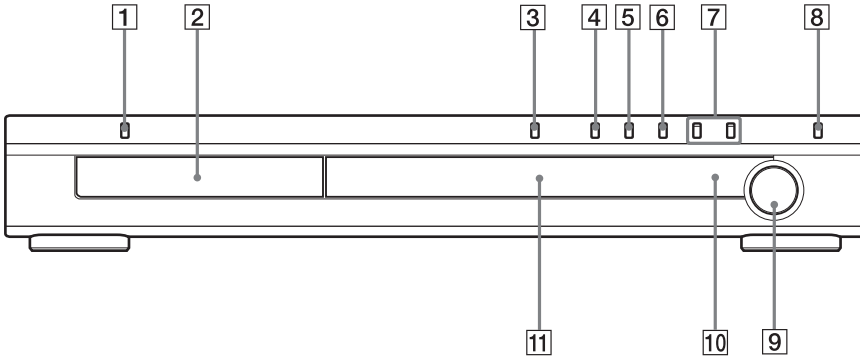

- 1 I/⏻ (on/standby) (20, 24, 62)
- 2 Disc tray (24)
- 3 ≡ (open/close) (24, 62)
- 4 ▷ (play) (24)
- 5 || (pause) (24)
- 6 ■ (stop) (24, 62)

- 7 ⏮/⏭ (24)
- 8 FUNCTION (24)
- 9 VOLUME (24)
- 10 📶 (remote sensor) (12)
- 11 Front panel display (80)

Additional Information

continued

79^{GB}

Front panel display

About the indications in the front panel display

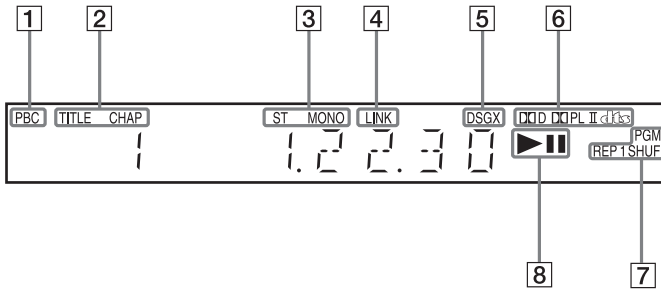

- 1** Lights up during PBC playback. (VIDEO CD only) (29)
- 2** Lights up when the time information of a title or chapter appears in the front panel display. (DVD only)
- 3** Monaural/Stereo effect (Radio only) (59)
- 4** Lights up when 2 channel source is output from the surround speakers. (49)
- 5** Current sound effect (50)
- 6** Current surround format (Except for JPEG)
- 7** Current mode (DVD function only)
- 8** Playing status (DVD function only)

Rear panel

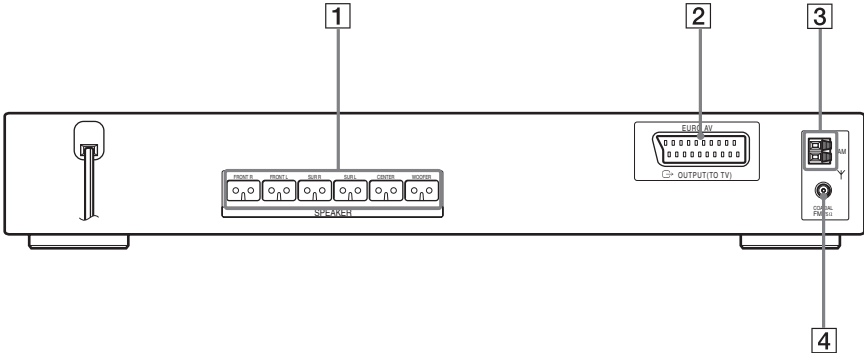

- | | |
|--|-----------------------------------|
| 1 SPEAKER jacks (14) | 3 AM terminal (18) |
| 2 EURO AV  OUTPUT (TO TV) jacks (19) | 4 FM 75Ω COAXIAL jack (18) |

Remote

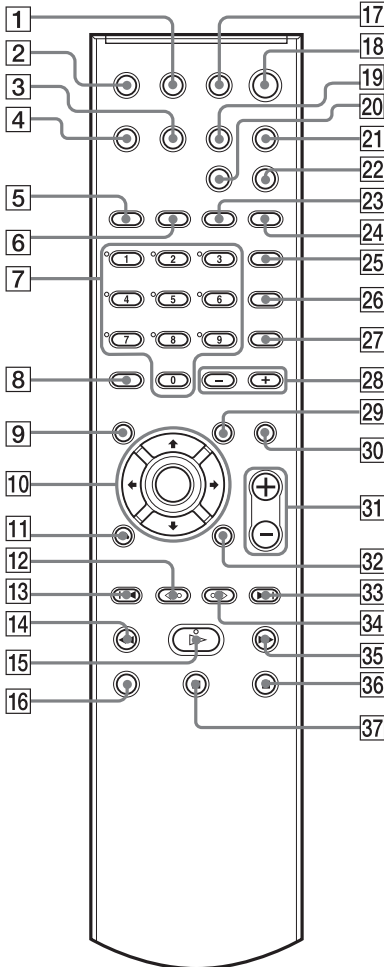

1 TV I/⏻ (on/standby) (56)

2 TV/VIDEO (56)

3 TUNER MENU (58)

4 SLEEP (61)

5 REPEAT/FM MODE (27, 59)

6 TUNER/BAND (59)

7 Number buttons (28, 52, 56)

The number 5 button has a tactile dot.*

8 CLEAR, -/-- (25, 56, 57)

9 TOP MENU (28)

10 ⏪/⏩/⏮/⏭/ENTER (20, 25, 48, 52, 61, 63)

11 ↺ RETURN (29)

12 ◀◀/▶▶ REPLAY, STEP (24)

13 ⏪ PRESET -, TV CH - (21, 24, 56, 59)

14 ◀◀/▶▶ SLOW, TUNING - (38, 58)

15 ▷ (play) (24)

The ▷ button has a tactile dot.*

16 TV (56)

17 THEATRE SYNC (57)

18 I/⏻ (on/standby) (20, 24, 59)

19 AMP MENU (20, 61)

20 DSGX (50)

21 FUNCTION (24)

22 SOUND FIELD (48)

23 DISPLAY (59)

24 PICTURE NAVI (32)

25 AUDIO (46)

26 SUBTITLE (51)

27 ANGLE (51)

28 ALBUM -/+ (24, 57)

29 MENU (28)

30 MUTING (24)

31 VOLUME, TV VOL +/- (24, 56, 59)

The VOLUME, TV VOL + button has a tactile dot.*

32 ☐ DISPLAY (9, 21, 25, 52, 63)

33 ▶▶ PRESET +, TV CH + (21, 24, 56, 59)

34 ⏩/▶▶ ADVANCE, STEP (24)

35 ▶▶/▶▶ SLOW, TUNING + (38, 58)

36 ■ (stop) (24, 52, 59)

37 || (pause) (24)

* Use the tactile dot as a reference when operating the system.

DVD Setup Display List

You can set the following items with the DVD Setup Display.

The order of the displayed items may be different from the actual display.

LANGUAGE SETUP

- OSD — (Select the language you want to use from the displayed language list.)
- MENU — (Select the language you want to use from the displayed language list.)
- AUDIO — (Select the language you want to use from the displayed language list.)
- SUBTITLE — (Select the language you want to use from the displayed language list.)

SCREEN SETUP

- TV TYPE —
 - 16:9
 - 4:3 LETTER BOX
 - 4:3 PAN SCAN
- SCREEN SAVER —
 - ON
 - OFF
- BACKGROUND —
 - JACKET
 - PICTURE
 - GRAPHICS
 - BLUE
 - BLACK
- LINE —
 - VIDEO
 - RGB

CUSTOM SETUP

- PAUSE MODE —
 - AUTO
 - FRAME
- TRACK SELECTION —
 - OFF
 - AUTO
- MULTI-DISC RESUME —
 - ON
 - OFF
- AUDIO DRC —
 - OFF
 - STANDARD
 - MAX
- DivX*

SPEAKER SETUP

- SIZE —
 - FRONT — YES
 - CENTER — YES
 - SURROUND —
 - NONE
 - BEHIND
 - SIDE
 - NONE
 - SUBWOOFER — YES
- DISTANCE —
 - FRONT — 1.0 m – 7.0 m
 - CENTER — 0.0 m – 7.0 m
 - SURROUND — 0.0 m – 7.0 m
- LEVEL (FRONT) —
 - L — -6 dB – 0 dB
 - R — -6 dB – 0 dB
 - CENTER — -6 dB – +6 dB
 - SUBWOOFER — -6 dB – +6 dB
- LEVEL (SURROUND) —
 - L — -6 dB – +6 dB
 - R — -6 dB – +6 dB
- TEST TONE —
 - OFF
 - ON

* Except for the United Kingdom models.

AMP Menu List

You can set the following items with AMP MENU on the remote.

AMP menu

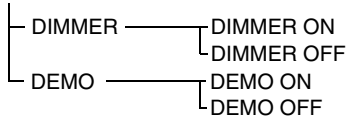

Index

Numerics

- 16:9 65
- 4:3 LETTER BOX 65
- 4:3 PAN SCAN 65
- 5.1 Channel Surround 47

A

- A/V SYNC 38
- Accessories 12
- ALBUM 40
- Album 76
- AMP menu 20
- AMP menu list 84
- ANGLE 51
- Antenna (Aerial) Hookup 18
- AUDIO 64
- AUDIO DRC 67

B

- BACKGROUND 65
- Batteries 12

C

- CHAPTER 40
- Chapter 76
- Connecting the AC power cord (mains lead) 20
- Continuous play 24
- Control Menu 9
- Controlling the TV 56
- CUSTOM 63
- CUSTOM PARENTAL CONTROL 52
- CUSTOM SETUP 66

D

- DATA CD 32, 36
- DATA DVD 36
- DEMO 20
- Demonstration 20
- DIMMER 61
- DISPLAY 42
- Display
 - Setup Display 63
- DISTANCE 68
- DivX® 36, 67, 76
- DOLBY DIGITAL 46
- Dolby Digital 76
- Dolby Pro Logic II 76
- Dolby Surround Pro Logic 76
- DSGX 50

- DTS 46, 76
- DVD 76
- DVD+RW 77
- DVD's menu 28
- DVD-RW 29, 76

E

- EFFECT 35

F

- Fast forward 38
- Fast reverse 38
- FILE 40
- File 77
- Film based software 77
- Front panel 79
- Front panel display 42, 80

H

- Handling discs 71
- Hookup Overview 13

I

- INDEX 40
- Installing the satellite speakers on the wall 16
- Instant Advance 24
- Instant Replay 24
- INTERVAL 35

J

- JPEG 30, 32

L

- Language Code List 78
- LANGUAGE SETUP 64
- LEVEL (FRONT) 68
- LEVEL (SURROUND) 68
- LINE 66
- Locating
 - a specific point by watching the TV screen 38

M

- MENU 64
- MODE (MP3, JPEG) 34
- MP3 30, 32
- Multi Session CD 7
- Multi-angle function 51, 77
- MULTI-DISC RESUME 67
- Multilingual function 77

- Muting 24

N

- Naming preset stations 59

O

- On-screen display
 - Control Menu display 9
 - Setup Display 63
- ORIGINAL 29
- OSD 64

P

- PARENTAL CONTROL 53, 77
- PAUSE MODE 66
- PBC Playback 7, 29, 77
- PICTURE NAVI 41
- PLAY LIST 29
- Preset Station 58
- Program Play 25

Q

- Quick Setup 21

R

- Radio 59
- RDS 60
- Rear panel 81
- Region Code 7, 77
- Remote 12, 56, 82
- Repeat Play 27
- RESET 64
- Resume Play 25

S

- Scan 38
- SCENE 40
- Scene 77
- SCREEN SAVER 65
- SCREEN SETUP 65
- Searching 38
- SETUP 63
- Setup Display 63, 83
- Shuffle Play 27
- SIZE 67
- SLEEP 61
- Slide show 34
- Slow-motion play 39
- Sound Field 48
- SPEAKER SETUP 67
- Speaker Setup 23

continued

Speaker System Hookup 14
SUBTITLE 51, 64

T

TEST TONE 69
THEATRE SYNC 57
TIME/TEXT 41
TITLE 40
Title 77
TRACK 40
Track 77
TRACK SELECTION 66
Troubleshooting 71
TUNER MENU 58
TV Hookup 19
TV TYPE 65

U

Usable discs 6

V

VIDEO CD 77

Free Manuals Download Website

<http://myh66.com>

<http://usermanuals.us>

<http://www.somanuals.com>

<http://www.4manuals.cc>

<http://www.manual-lib.com>

<http://www.404manual.com>

<http://www.luxmanual.com>

<http://aubethermostatmanual.com>

Golf course search by state

<http://golfingnear.com>

Email search by domain

<http://emailbydomain.com>

Auto manuals search

<http://auto.somanuals.com>

TV manuals search

<http://tv.somanuals.com>