

DVD Home Theatre System

Operating Instructions
DAV-DZ170/DZ171/DZ175



HDMI



SUPER AUDIO CD



MP3

WARNING

Caution – The use of optical instruments with this product will increase eye hazard.

Do not install the appliance in a confined space, such as a bookcase or built-in cabinet.

To reduce the risk of fire, do not cover the ventilation opening of the apparatus with newspapers, tablecloths, curtains, etc. Do not place the naked flame sources such as lighted candles on the apparatus. Do not expose batteries or apparatus with battery-installed to excessive heat such as sunshine, fire or the like.

To prevent injury, this apparatus must be securely attached to the floor/wall in accordance with the installation instructions.

Indoor use only.

For the customers in the U.S.A.



To reduce the risk of fire or electric shock, do not expose this apparatus to rain or moisture.



This symbol is intended to alert the user to the presence of uninsulated “dangerous voltage”

within the product’s enclosure that may be of sufficient magnitude to constitute a risk of electric shock to persons.



This symbol is intended to alert the user to the presence of important operating and maintenance (servicing) instructions in the literature accompanying the appliance.

Owner's Record

The model and serial numbers are located on the rear exterior of the unit. Record the serial number in the space provided below. Refer to them whenever you call upon your Sony dealer regarding this product.
Model No. DAV-DZ170/ DAV-DZ171/DAV-DZ175
Serial No. _____

The following FCC statement applies only to the version of this model manufactured for sale in the U.S.A. Other versions may not comply with FCC technical regulations.

NOTE:

This equipment has been tested and found to comply with the limits for a Class B digital device, pursuant to Part 15 of the FCC Rules. These limits are designed to provide reasonable protection against harmful interference in a residential installation. This equipment generates, uses, and can radiate radio frequency energy and, if not installed and used in accordance with the instructions, may cause harmful interference to radio communications. However, there is no guarantee that interference will not occur in a particular installation. If this equipment does cause harmful interference to radio or television reception, which can be determined by turning the equipment off and on, the user is encouraged to try to correct the interference by one or more of the following measures:

- Reorient or relocate the receiving antenna (aerial).
- Increase the separation between the equipment and receiver.
- Connect the equipment into an outlet on a circuit different from that to which the receiver is connected.
- Consult the dealer or an experienced radio/TV technician for help.

CAUTION

You are cautioned that any changes or modifications not expressly approved in this manual could void your authority to operate this equipment.

Important Safety Instructions

- 1) Read these instructions.
- 2) Keep these instructions.
- 3) Heed all warnings.
- 4) Follow all instructions.
- 5) Do not use this apparatus near water.
- 6) Clean only with dry cloth.
- 7) Do not block any ventilation openings. Install in accordance with the manufacturer’s instructions.
- 8) Do not install near any heat sources such as radiators, heat registers, stoves, or other apparatus (including amplifiers) that produce heat.
- 9) Do not defeat the safety purpose of the polarized or grounding-type plug. A polarized plug has two blades with one wider than the other. A grounding type plug has two blades and a third grounding prong. The wide blade or the third prong are provided for your safety. If the provided plug does not fit into your outlet, consult an electrician for replacement of the obsolete outlet.
- 10) Protect the power cord from being walked on or pinched particularly at plugs, convenience receptacles, and the point where they exit from the apparatus.
- 11) Only use attachments/ accessories specified by the manufacturer.
- 12) Use only with the cart, stand, tripod, bracket, or table specified by the manufacturer, or sold with the apparatus. When a cart is used, use caution when moving the cart/

apparatus combination to avoid injury from tip-over.



- 13) Unplug this apparatus during lightning storms or when unused for long periods of time.
- 14) Refer all servicing to qualified service personnel. Servicing is required when the apparatus has been damaged in any way, such as power-supply cord or plug is damaged, liquid has been spilled or objects have fallen into the apparatus, the apparatus has been exposed to rain or moisture, does not operate normally, or has been dropped.

For the customers in Canada

To reduce the risk of fire or electric shock, do not expose this apparatus to dripping or splashing, and do not place objects filled with liquids, such as vases, on the apparatus.

Precautions

On power sources

- The unit is not disconnected from the mains as long as it is connected to the AC outlet, even if the unit itself has been turned off.
- As the main plug is used to disconnect the unit from the mains, connect the unit to an easily accessible AC outlet. Should you notice an abnormality in the unit, disconnect the main plug from the AC outlet immediately.

Copyrights

This system incorporates with Dolby* Digital and Dolby Pro Logic (II) adaptive matrix surround decoder and the DTS** Digital Surround System.

* Manufactured under license from Dolby Laboratories. Dolby, Pro Logic, and the double-D symbol are trademarks of Dolby Laboratories.

** Manufactured under license under U.S. Patent #'s: 5,451,942; 5,956,674; 5,974,380; 5,978,762; 6,487,535 & other U.S. and worldwide patents issued & pending. DTS and DTS Digital Surround are registered trademarks and the DTS logos and Symbol are trademarks of DTS, Inc. © 1996-2008 DTS, Inc. All Rights Reserved.

This system incorporates High-Definition Multimedia Interface (HDMI™) technology. HDMI, the HDMI logo and High-Definition Multimedia Interface are trademarks or

registered trademarks of HDMI Licensing LLC.

“DVD-RW,” “DVD-R,” “DVD+RW,” “DVD+R,” “DVD VIDEO,” and the “CD” logos are trademarks.

“BRAVIA” is a trademark of Sony Corporation.

“PLAYSTATION” is a trademark of Sony Computer Entertainment Inc.

MPEG Layer-3 audio coding technology and patents licensed from Fraunhofer IIS and Thomson.

iPod is a trademark of Apple Inc., registered in the U.S. and other countries.

“Made for iPod” means that an electronic accessory has been designed to connect specifically to iPod and has been certified by the developer to meet Apple performance standards.

Apple is not responsible for the operation of this device or its compliance with safety and regulatory standards.

About MPEG-4 Visual

THIS PRODUCT IS LICENSED UNDER THE MPEG-4 VISUAL PATENT PORTFOLIO LICENSE FOR THE PERSONAL AND NON-COMMERCIAL USE OF A CONSUMER FOR DECODING VIDEO IN COMPLIANCE WITH THE MPEG-4 VISUAL STANDARD ("MPEG-4 VIDEO") THAT WAS ENCODED BY A CONSUMER ENGAGED IN A PERSONAL AND NON-COMMERCIAL ACTIVITY AND/OR WAS OBTAINED FROM A VIDEO PROVIDER LICENSED BY MPEG LA TO PROVIDE MPEG-4 VIDEO. NO LICENSE IS GRANTED OR SHALL BE IMPLIED FOR ANY OTHER USE. ADDITIONAL INFORMATION INCLUDING THAT RELATING TO PROMOTIONAL, INTERNAL AND COMMERCIAL USES AND LICENSING MAY BE OBTAINED FROM MPEG LA, LLC. SEE [HTTP://WWW.MPEGLA.COM](http://www.mpegla.com)

About These Operating Instructions

- The instructions in these Operating Instructions describe the controls on the remote. You can also use the controls on the unit if they have the same or similar names as those on the remote.
- The Control Menu items may vary depending on the area.
- "DVD" may be used as a general term for a DVD VIDEO, DVD+RW/ DVD+R, and DVD-RW/ DVD-R.
- Measurements are expressed in feet (ft) for North American models.
- The default setting is underlined.

Table of Contents

Precautions	3
About These Operating Instructions	4
Playable Discs/Files on a USB Device	6
Package Contents	10
Index to Parts and Control	11
Guide to the Control Menu	16

Getting Started

Step 1: Installing the System.....	19
Step 2: Connecting the System... 21	21
Step 3: Setting up the System.....	26

Playback

Playing a Disc	30
Playing Files on a Disc/USB Device	30
Other Playback Operations	32
Selecting the Playback Mode.....	35
Displaying the Information of a Disc/ USB Device	39
Enjoying the Audio/Video of the Connected Component	40

Tuner

Presetting Radio Stations	42
Listening to the Radio.....	42

Sound Effect

Enjoying Surround Sound.....	44
Selecting the Sound Effect.....	46

Convenient Functions

Using the Control for HDMI Function for “BRAVIA” Sync	47
Transferring Songs onto a USB Device	49
Using the sleep timer	51
Adjusting the Delay Between the Picture and Sound	51
Enjoying Multiplex Broadcast Sound	52
Changing the Input Level of the Sound from Connected Components	52











Settings

Changing the Brightness of the Front Panel Display.....	53
Setting the Demonstration Mode to On/Off	53
Reperforming the Quick Setup.....	53
Set the System to Standby Mode Automatically	53
Performing Further Settings	54

Additional Information

Precautions.....	62
Troubleshooting.....	64
Specifications.....	70
Index	75

Playable Discs/Files on a USB Device

Type	Disc logo	Characteristics	Icon
DVD VIDEO	     	<ul style="list-style-type: none"> • DVD VIDEO • DVD-R/DVD-RW in DVD VIDEO format or video mode • DVD+R/DVD+RW in DVD VIDEO format 	DVD-V
VR (Video Recording) mode	 	<ul style="list-style-type: none"> • DVD-R/DVD-RW in VR (Video Recording) mode (except for DVD-R DL) 	DVD-VR
VIDEO CD		<ul style="list-style-type: none"> • VIDEO CD (Ver. 1.1 and 2.0 discs) • Super VCD • CD-R/CD-RW/CD-ROM in video CD format or Super VCD format 	VIDEO CD
Super Audio CD	 SUPER AUDIO CD	<ul style="list-style-type: none"> • Super Audio CD 	Super Audio CD
CD		<ul style="list-style-type: none"> • Audio CD • CD-R/CD-RW in audio CD format 	CD
DATA CD	–	<ul style="list-style-type: none"> • CD-R/CD-RW/CD-ROM in DATA CD format that contains the following kinds of files and conforms to ISO 9660¹⁾ Level 1/Level 2, or Joliet (extended format). <ul style="list-style-type: none"> – MP3 files²⁾³⁾ – JPEG image files⁴⁾ – MPEG4 video files 	DATA CD
DATA DVD	–	<ul style="list-style-type: none"> • DVD-ROM/DVD-R/DVD-RW/DVD+R/DVD+RW in DATA DVD format that contains the following kinds of files and conforms to UDF (Universal Disk Format). <ul style="list-style-type: none"> – MP3 files²⁾³⁾ – JPEG image files⁴⁾ – MPEG4 video files 	DATA DVD

Type	Disc logo	Characteristics	Icon
USB device	–	<ul style="list-style-type: none"> • USB device that contains the following kinds of files. <ul style="list-style-type: none"> – MP3 files²⁾³⁾ or WMA/AAC files³⁾ – JPEG image files⁴⁾ – MPEG4 video files 	

¹⁾A logical format of files and folders on CD-ROMs, defined by ISO (International Organization for Standardization).

²⁾MP3 (MPEG1 Audio Layer 3) is a standard format defined by ISO/MPEG for compressed audio data. MP3 files must be in MPEG1 Audio Layer 3 format.

³⁾Files with copyright protection (Digital Rights Management) cannot be played by the system.

⁴⁾JPEG image files must conform to the DCF image file format. (DCF “Design rule for Camera File system”: Image standards for digital cameras regulated by Japan Electronics and Information Technology Industries Association (JEITA).)

Notes on discs

This product is designed to playback discs that conform to the Compact Disc (CD) standard. DualDiscs and some music discs encoded with copyright protection technologies do not conform to the Compact Disc (CD) standard, therefore, these discs may not be compatible with this product.

Example of discs that the system cannot play

The system cannot play the following discs:

- CD-ROM/CD-R/CD-RW other than those recorded in the formats listed on page 6
- CD-ROM recorded in PHOTO CD format
- Data part of CD-Extra
- CD Graphics disc
- DVD Audio
- DATA CD/DATA DVD that does not contain MP3 files, JPEG image files, or MPEG4 video files
- DATA CD/DATA DVD that is created in Packet Write format
- DVD-RAM
- Blu-ray Disc

Also, the system cannot play the following discs:

- A DVD VIDEO with a different region code (page 8)
- A disc that has a non-standard shape (e.g., card, heart)
- A disc with paper or stickers on it
- A disc that has the adhesive of cellophane tape or a sticker stuck on it

Notes about CD-R/CD-RW/DVD-R/DVD-RW/DVD+R/DVD+RW

In some cases, CD-R/CD-RW/DVD-R/DVD-RW/DVD+R/DVD+RW cannot be played on this system due to the recording quality or physical condition of the disc, or the characteristics of the recording device and authoring software.

The disc will not play if it has not been correctly finalized. For more information, refer to the operating instructions for the recording device.

Note that some playback functions may not work with some DVD+RWs/DVD+Rs, even if they have been correctly finalized. In this case, view the disc by normal playback. Also some DATA CDs/DATA DVDs created in Packet Write format cannot be played.

Notes about Multi Session CD

- This system can play a Multi Session CD when an MP3 file is contained in the first session. Any subsequent MP3 files recorded in later sessions can also be played.
- This system can play a Multi Session CD when a JPEG image file is contained in the first session. Any subsequent JPEG image files recorded in later sessions can also be played.
- If MP3 files and JPEG image files in music CD format or video CD format are recorded in the first session, only the first session will be played.

Region code

Your system has a region code printed on the rear of the unit and will only play a DVD labeled with the same region code.

A DVD VIDEO labeled  will also play on this system.

If you try to play any other DVD VIDEO, the message [Playback prohibited by area limitations.] will appear on the TV screen. Depending on the DVD VIDEO, no region code indication may be given even though playing the DVD VIDEO is prohibited by area restrictions.

Notes about playback operations of a DVD or VIDEO CD

Some playback operations on a DVD or VIDEO CD may be intentionally set by software producers. Since this system will play a DVD or VIDEO CD according to the disc contents the software producers designed, some playback features may not be available. Be sure to read the operating instructions of the DVD or VIDEO CD.

Notes about playable files

- The system can recognize up to 200 folders, including albums (folders) that do not contain audio files, JPEG image files, or video files. When more than 200 folders are on the DATA CD/DATA DVD/USB device or more than 150 files are in a folder, folders/files that are recognized by the system differ depending on the folder configuration.
- The system can play the following files.

File	Extension of the file
MP3 file	“.mp3”
WMA file*	“.wma”
AAC file*	“.m4a”
JPEG image file	“.jpg” or “.jpeg”
MPEG4 video file	“.mp4” or “.m4v”

* USB device only.

The system will attempt to play any data with the extensions above, even if it is not in MP3/WMA/AAC/JPEG/MPEG4 format. Playing this data may generate a loud noise which could damage your speaker system.

- The following can increase the time it takes to start playback:
 - when a DATA CD/DATA DVD/USB device is recorded with a complicated tree structure.
 - when the audio files, JPEG image files, or video files in another folder have just been played.
- Some files on DATA CDs/DATA DVDs/USB devices cannot be played by the system depending on the file format.
- The system can play to a depth of 8 folders only.
- The system may not be able to play an audio file, JPEG image file, or video file depending on the file type.
- Files recorded by a device such as a computer may not be played in the order in which they were recorded.
- Folders that have no audio files, JPEG image files, or video files are skipped.
- Compatibility with all MP3/WMA/AAC encoding/writing software, recording devices, and recording media cannot be guaranteed.
- Compatibility with all MPEG4 video encoding/writing software, recording devices, and recording media cannot be guaranteed.
- The playback order may not be applicable depending on the software used for creating the audio file, JPEG image file, or video file, or if there are more than 200 folders or 150 files in each folder.

Notes about USB devices

- This system supports Mass Storage Class (MSC) devices.
- This system is not guaranteed to operate with all USB devices or memories.
- Although there are variety of complex functions for USB devices, the playable contents of USB devices connected to the system are music, photo, and video contents only. For details, refer to the operating instructions of the USB device.
- When a USB device is inserted, the system reads all the files on the USB device. If there are many folders or files on the USB device, it may take a long time to finish reading the USB device.
- Do not connect the system and the USB device through a USB hub.
- With some connected USB devices, there may be a delay before an operation is performed by this system.
- The playback order for the system may differ from the playback order of the connected USB device.
- Always turn off the system before removing the USB device. Removing the USB device while the system is on may corrupt the data on the USB device.
- Before using a USB device, make sure that no virus-ridden files are on the USB device.

Package Contents

Main unit

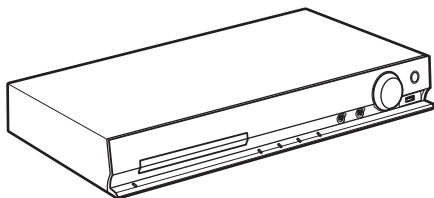

Speaker packages

- DAV-DZ170/DAV-DZ171

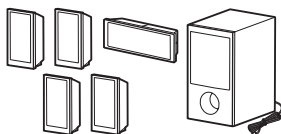

- DAV-DZ175

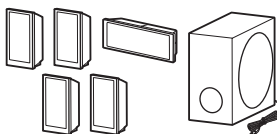

- Speaker cords (1 set)
(red/white/green/gray/blue)



- Foot pads (1 set)



Accessories

- Remote commander
(remote) (1)

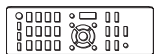

- R6 (size AA) batteries (2)



- Video cord (1)



- FM wire antenna (aerial) (1)



or



- Calibration mic (1)



- HDMI cable (1)
(DAV-DZ171 only)

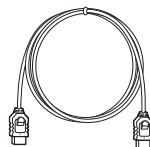

- Operating Instructions
- Quick Setup Guide
- Easy Setup Disc (DVD)

Index to Parts and Control

For more information, refer to the pages indicated in parentheses.

Front panel

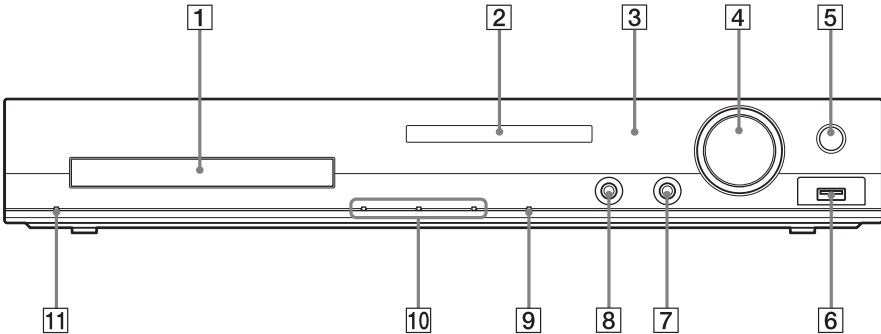

1 Disc tray

2 Front panel display (page 12)

3  (remote sensor)

Receives the remote signal. Point the remote toward here when using the remote.

4 MASTER VOLUME control

Adjusts the system's volume.

5 REC TO USB (page 49)

Transfers tracks/MP3 files onto a USB device.

Lights up during transfer of tracks/MP3 files.

6  (USB) port (pages 24, 30)

Used for connecting a USB device or iPod.

7 AUDIO IN jack (page 24)

Used for connecting other components, such as a portable audio source.

8 A.CAL MIC jack (page 26)

Used for connecting the calibration mic.

9 FUNCTION

Selects the playback source.

10 Play operation buttons

 (open/close)

Opens or closes the disc tray.

 (play)

Starts or re-starts playback.

 (stop)

Stops playback and remembers the stop point (resume point).

11  (on/standby)

Turns on the unit, or sets it to standby mode.

Front panel display

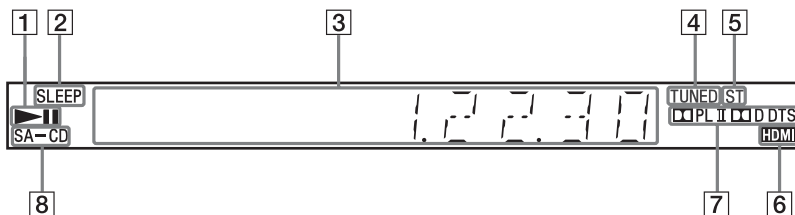

- 1** **Playing status indicator**
- 2** **SLEEP indicator**
Flashes when the sleep timer is set.
- 3** **System status display**
- 4** **TUNED indicator (Radio only)**
Lights up when a station is received.
- 5** **ST indicator (Radio only)**
Lights up when stereo sound is received.
- 6** **HDMI indicator**
Lights up when a signal is established between a TV and the unit via HDMI.
- 7** **Surround format indicator**
- 8** **SA-CD indicator**
Lights up when a Super Audio CD/CD is loaded.

Rear panel

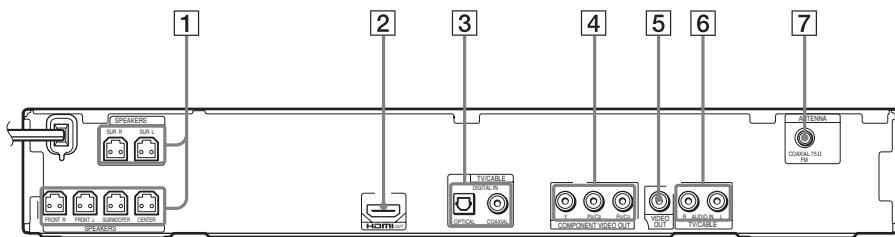

- | | |
|---|--|
| 1 SPEAKERS jacks (page 21) | 5 VIDEO OUT jack (page 22) |
| 2 HDMI OUT jack (page 22) | 6 TV/CABLE (AUDIO IN R/L) jacks (page 22) |
| 3 TV/CABLE (DIGITAL IN OPTICAL/ COAXIAL) jacks (page 22) | 7 ANTENNA (COAXIAL 75Ω FM) jack (page 24) |
| 4 COMPONENT VIDEO OUT jacks (page 22) | |

Remote control

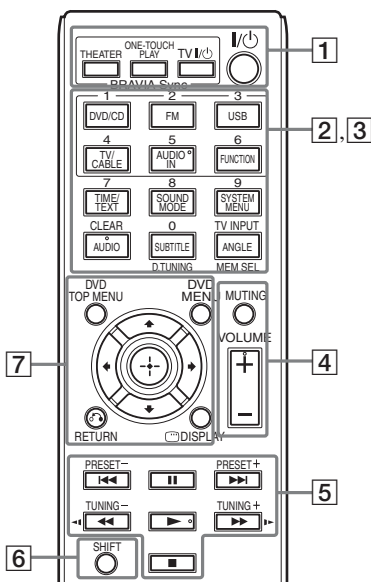

Number 5/AUDIO IN, VOLUME +, AUDIO, and ► buttons have a tactile dot. Use the tactile dot as a reference when operating the remote.

1 THEATER (page 47)

Switches to the optimum video mode for watching movies automatically.

ONE-TOUCH PLAY (page 47)

Activates One-Touch Play.

TV I/⏻ (on/standby)*

Turns on your TV or sets it to standby mode.

I/⏻ (on/standby) (page 26)

Turns on the system or sets it to standby mode.

2 Buttons with black/white text labels

Function selection buttons (pages 30, 40, 42)

Select the playback source.

The system is turned on automatically when you press the function selection button while the system is turned off.

DVD/CD

FM

USB

TV/CABLE

AUDIO IN

FUNCTION

Selects the functions in sequence.

TIME/TEXT (page 39)

Changes the information in the front panel display.

SOUND MODE (page 46)

Selects the sound mode.

SYSTEM MENU (pages 42, 44, 51, 53)

Enters the system menu.

AUDIO (page 34)

Selects the audio format/track.

SUBTITLE (page 34)

Selects the subtitle language when multilingual subtitles are recorded on a DVD VIDEO.

ANGLE (page 34)

Switches to other viewing angles when multi-angles are recorded on a DVD VIDEO.

D.TUNING (page 42)

Selects the radio frequencies.

MEM SEL (pages 30, 49)

Selects the USB device's memory number for playback or transfer.

- 3** Buttons with pink text labels (The following buttons work when you press and hold SHIFT (**6**)).

Number buttons (pages 33, 42)

Enters the title/chapter numbers, radio frequencies, etc.

CLEAR (pages 32, 35, 51)

Clears the entry field.

TV INPUT*

Switches your TV's input source.

- 4** **MUTING**

Turns off the sound temporarily.

VOLUME +/- (page 30)

Adjusts the volume.

- 5** **Playback operation buttons**

See "Other Playback Operations" (page 32).

◀◀/▶▶ (previous/next)

◀◀/▶▶ (fast reverse/fast forward)

◀|/▶ (slow)

▶ (play)

|| (pause)

■ (stop)

Radio operation buttons

See "Listening to the Radio" (page 42).

PRESET +/-

TUNING +/-

- 6** **SHIFT**

Press and hold this button to use buttons with pink text labels (**3**).

- 7** **DVD TOP MENU (page 34)**

Opens or closes the DVD's Top Menu.

DVD MENU (page 34)

Opens or closes the DVD's menu.

←/↑/↓/→

Moves the highlight to a displayed item.

⊕ (ENTER)

Enters the selected item.

↶ RETURN (page 31)

Returns to the previous display.

Ⓜ DISPLAY (pages 16, 26, 30, 32, 35, 47, 49, 54)

Displays the playback information on the TV screen.

* Works with Sony TVs only. Depending on your TV, you may not be able to use some of the buttons.

To insert the batteries

Insert two R6 (size AA) batteries (supplied) by matching the ⊕ and ⊖ ends on the batteries to the markings inside the compartment.

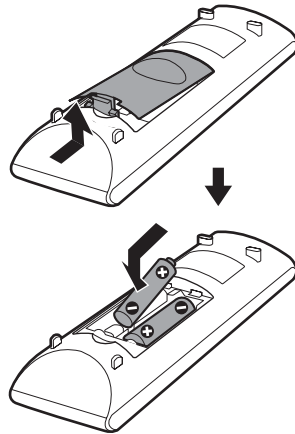

Note

- Do not leave the remote in an extremely hot or humid place.
- Do not use a new battery with an old one.
- Do not drop any foreign object into the remote casing, particularly when replacing the batteries.
- If you do not intend to use the remote for an extended period of time, remove the batteries to avoid possible damage from battery leakage and corrosion.

Guide to the Control Menu

You can use the Control Menu to select a function and to view related information.

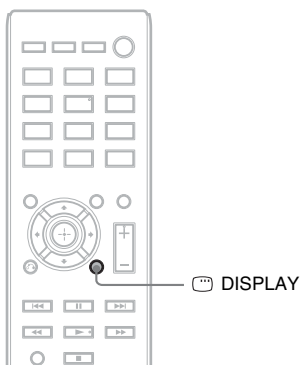

Press  DISPLAY while using the “DVD/CD” or “USB” function.

Each time you press  DISPLAY, the Control Menu changes:

① → ② → ③ → ① → ...

- ① Control Menu 1
- ② Control Menu 2 (appears when available)
- ③ Control Menu off

Control Menu



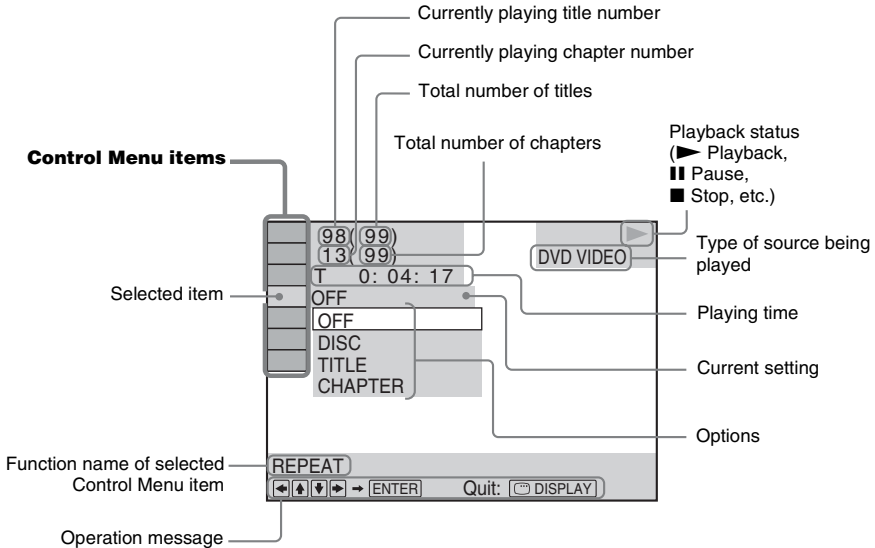































































Example: Control Menu 1 when playing a DVD VIDEO.



List of Control Menu items

The Control Menu 1 and 2 will show different items depending on the source. For details, see the pages in parentheses in the chart below.

Item	Item Name, Function, Relevant Source
	[TITLE] (page 33)/[SCENE] (page 33)/[TRACK] (page 33) You can select the title, scene, or track to be played. DVD-V DVD-VR VIDEO CD
	[CHAPTER] (page 33)/[INDEX] (page 33) You can select the chapter or index to be played. DVD-V DVD-VR VIDEO CD
	[INDEX] (page 33) You can display the index and select the index to be played. Super Audio CD
	[TRACK] (page 33) You can select the track to be played. Super Audio CD C D DATA CD DATA DVD USB
	[ORIGINAL/PLAY LIST] (page 35) You can select the type of titles (DVD-RW/DVD-R) to be played, the [ORIGINAL] one, or an edited [PLAY LIST]. DVD-VR
	[TIME] (page 33) You can check the elapsed time and the remaining playback time. You can play from a desired point by inputting the time code (DVD VIDEO/DVD-VR only). DVD-V DVD-VR VIDEO CD Super Audio CD C D DATA CD DATA DVD USB
	[MULTI/2CH] (page 35) You can select the playback area on a Super Audio CD when available. Super Audio CD
	[SUPER AUDIO CD/CD LAYER] (page 35) You can select the playback layer on a Super Audio CD when available. Super Audio CD



	[PROGRAM] (page 35) You can select the track to play in the order you want.  
	[SHUFFLE] (page 36) You can play the tracks/files in random order.      
	[REPEAT] (page 37) You can play the entire disc/USB device (all titles/all tracks/all folders/all files) repeatedly or one title/chapter/track/folder/file repeatedly.        
	[A/V SYNC] (page 51) You can adjust the delay between the picture and sound.      
	[DISC MENU] (page 34) You can display the DVD's menu. 
	[BROWSING] (page 31) You can display the list of folders/JPEG image files.   
	[SETUP] (page 54) [CUSTOM] In addition to the Quick Setup setting, you can adjust various other settings. [QUICK] (page 26) You can make basic adjustments. Use the Quick Setup to select the desired language of the on-screen display, the aspect ratio of your TV, and start the Auto Calibration.        
	[FOLDER] (page 33) You can select the folder to be played.   
	[FILE] (page 33) You can select the JPEG image file or video file to be played.   
 1)	[DATE] (page 40) You can display the date the picture was taken by a digital camera.   
 1)	[INTERVAL] (page 38) You can select the duration for which the slides are displayed on the TV screen.   
 1)	[EFFECT] (page 37) You can select the effects to be used for changing slides during a slide show.   
	[MEDIA] (page 32) You can select the playback priority of different types of media (MP3/AAC ²⁾ /WMA ²⁾ file, JPEG image file, video file, or both MP3 and JPEG image files ³⁾ to be played on a DATA CD/DATA DVD/USB device.   
	[USB TRANSFER] (page 49) You can transfer tracks on an audio CD or MP3 files on a DATA CD/DATA DVD onto a USB device. 

¹⁾These items are not displayed when playing a DATA CD/DATA DVD/USB device with video files.

²⁾USB device only.

³⁾DATA CD/DATA DVD only.

Tip

- The Control Menu icon indicator lights up in yellow  →  when you select any item except [OFF] ([PROGRAM], [SHUFFLE], [REPEAT], and [A/V SYNC] only). The [ORIGINAL/PLAY LIST] indicator lights up in yellow when you select [PLAY LIST] (default setting). The [MULTI/2CH] indicator lights up in yellow when you select the multi-channel playback area on a Super Audio CD.

Step 1: Installing the System

How to position the system

Install the system by referring to the illustration below.

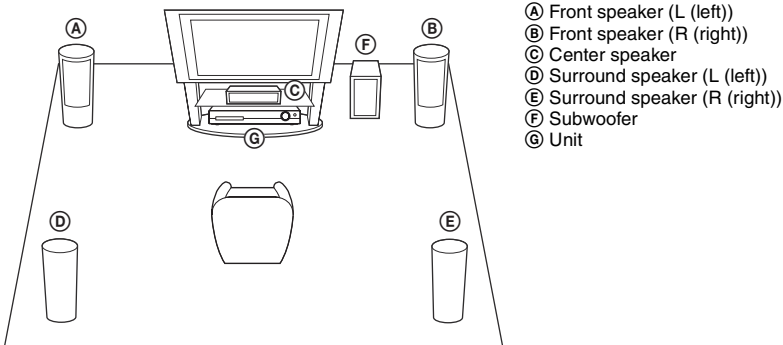

To attach the foot pads to the subwoofer

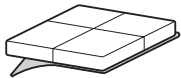

Remove the foot pads from the protective cover.

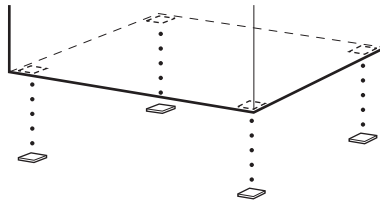

Note

- Use caution when placing the speakers and/or speaker stands attached to the speakers on a specially treated (waxed, oiled, polished, etc.) floor, as staining or discoloration may result.

When installing the speakers on a wall

Caution

- Contact a screw shop or installer for information regarding the wall material or screws to be used.
- Use screws that are suitable for the wall material and strength. As a plaster board wall is especially fragile, attach the screws securely to a beam. Install the speakers on a vertical and flat wall where reinforcement is applied.
- Sony is not responsible for accidents or damage caused by improper installation, insufficient wall strength or improper screw installation, natural calamity, etc.

- 1 Connect the speaker cord with the color tube to \oplus , and the speaker cord without the color tube to \ominus .**



Color tube
 Front left speaker (L): White
 Front right speaker (R): Red
 Center speaker: Green
 Surround left speaker (L): Blue
 Surround right speaker (R): Gray

- 2 Prepare screws (not supplied) that are suitable for the hole on the back of each speaker. See the illustrations below.**

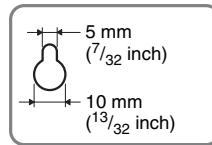
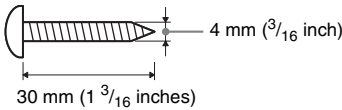

Hole on the back of the speaker

- 3 Fasten the screws to the wall, then hang the speaker on the wall.**

Depth of fastened screw

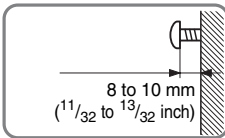

For the center speaker

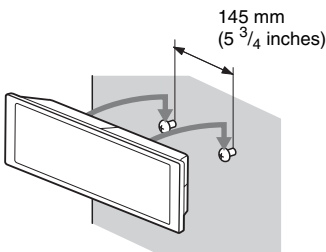

For the other speakers

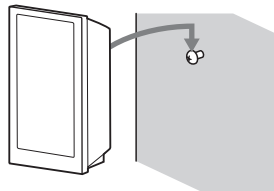

Step 2: Connecting the System

Connecting the speakers

- 1 Insert the connectors of the speaker cords to match the color of the **SPEAKERS** jacks of the unit until they click.

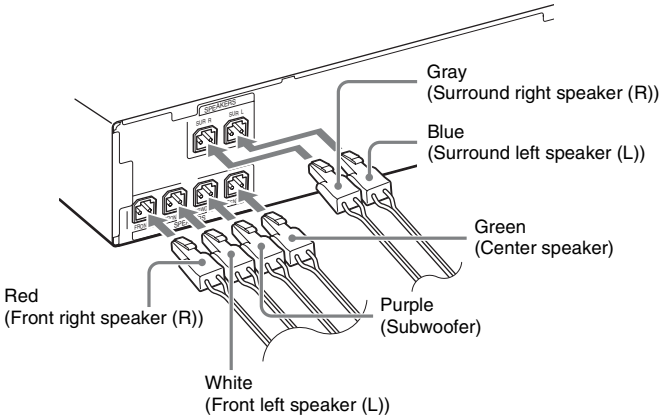

- 2 Connect the speaker cord with the color tube to \oplus , and the speaker cord without the color tube to \ominus .

The subwoofer speaker cord is fixed to the subwoofer.

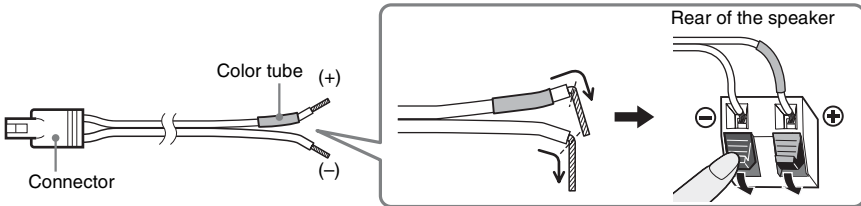

Note

- Do not catch the speaker cord insulation (rubber covering) in the speaker terminals.

Connecting your TV/cable box

When connecting to a TV only

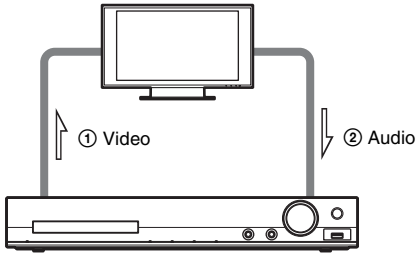

When connecting to a TV and cable box

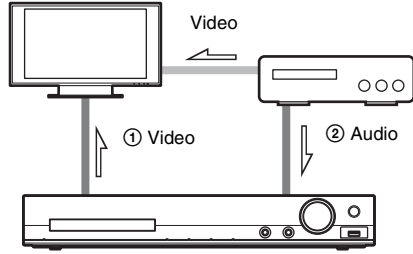

① Connecting the video to your TV

Depending on the jacks on your TV, select one of the connection methods.

■ Method 1: Video cord (supplied) connection

This is the basic connection.

■ Method 2: HDMI cable* connection

Picture quality will be improved compared to Method 1.

■ Method 3: Component video cable (not supplied) connection

Picture quality will be improved compared to Method 1.

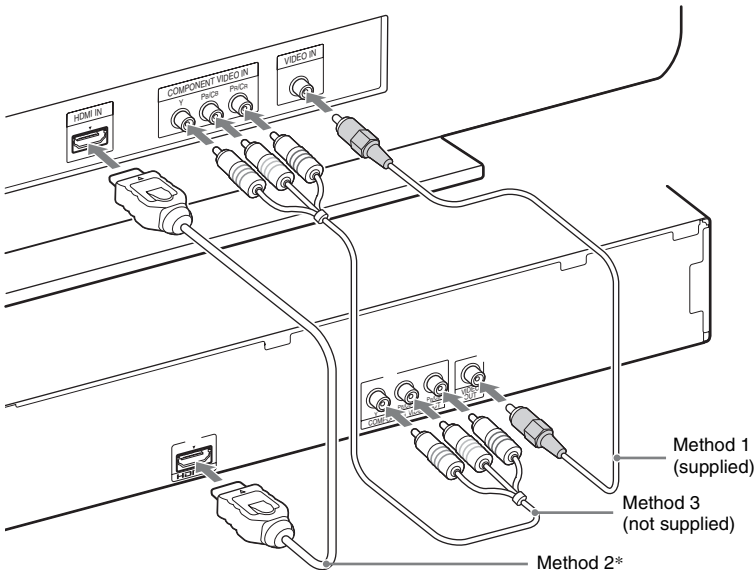

* The HDMI cable is supplied with DAV-DZ171 only.

② Connecting the audio from your TV/cable box

To listen to TV or cable box sound via the system, select one of the connection methods.

■ Method 1: Audio cord (not supplied) connection

This is the basic connection and sends an analog audio signal.

■ Method 2: Digital optical cord (not supplied) connection

Sound quality will be improved compared to Method 1.

■ Method 3: Digital coaxial cord (not supplied) connection

Sound quality will be improved compared to Method 1.

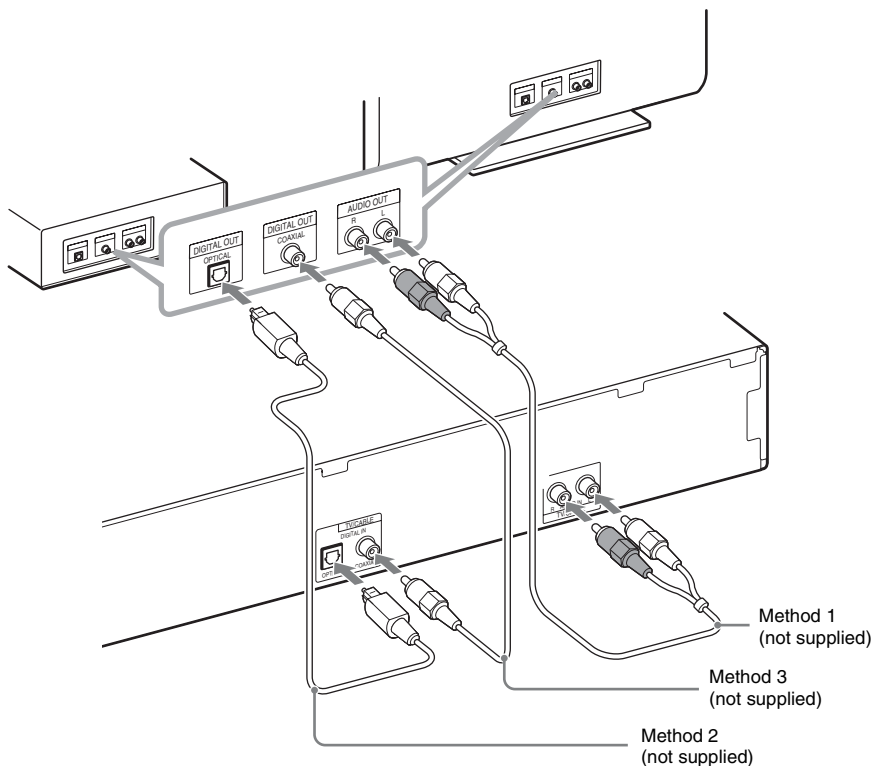

Note

- The system can accept both digital and analog signals. Digital signals have priority over analog signals. (COAXIAL has priority over OPTICAL.) If the digital signal ceases, the analog signal will be processed after a few seconds.

Tip

- You can connect another component, such as a VCR, digital satellite receiver, or PlayStation, to the TV/CABLE jacks instead of your TV.

Connecting the other components

You can enjoy connected components via the system's speakers.

Connected component	Required cord for connection
Portable audio source (not supplied)	A Stereo mini-plug cord (not supplied)
USB device (not supplied)	B USB connector (not supplied)

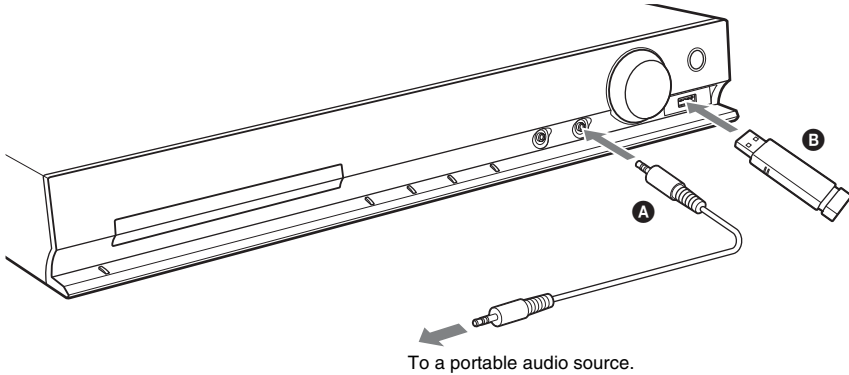

Connecting the antenna (aerial)

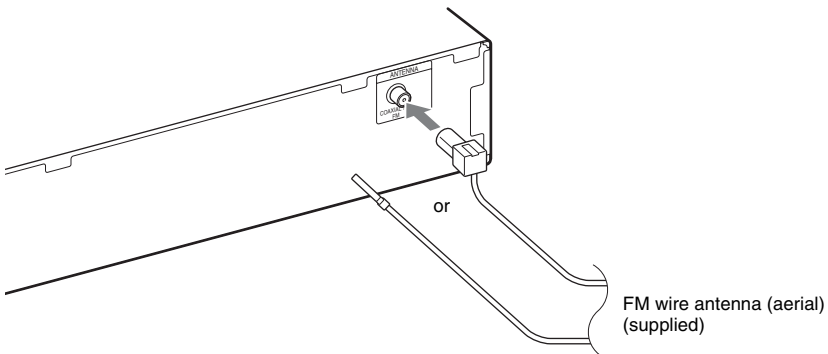

Note

- After connecting the FM wire antenna (aerial), extend and keep it as horizontal as possible.

Connecting the AC power cord (mains lead)

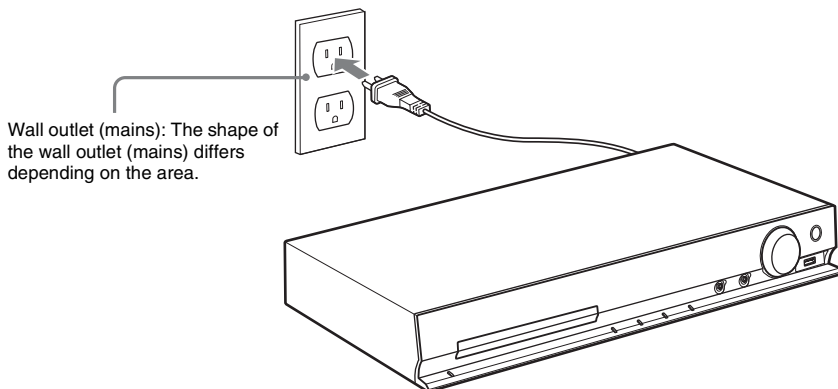

Wall outlet (mains): The shape of the wall outlet (mains) differs depending on the area.

Step 3: Setting up the System

Performing the Quick Setup

Displayed items vary depending on the area.

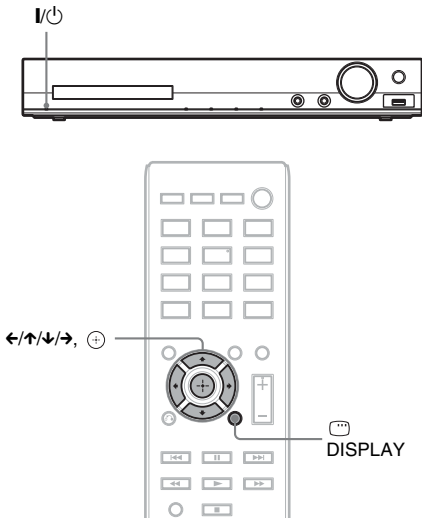

- 1** Turn on your TV.
- 2** Switch the input selector on your TV so that the signal from the system appears on the TV screen.
- 3** Press **I/⏻** to turn the system on.
- 4** Press **+** without inserting a disc or connecting a USB device.

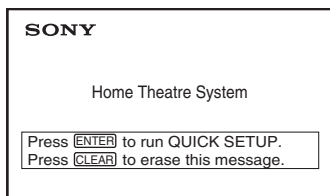

Note

- If this message does not appear, press DVD/CD. If this message still does not appear, recall the Quick Setup display (page 53).

- 5** Press **↑/↓** to select a language, then press **+**.

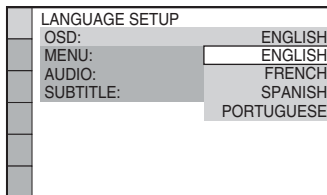

- 6** Press **↑/↓** to select the setting that matches your TV type, then press **+**.

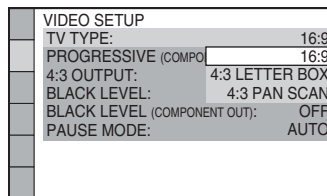

- **[16:9]**: This aspect ratio is for a wide-screen TV or a 4:3 standard TV with a wide-screen mode (page 55)
- **[4:3 LETTER BOX]** or **[4:3 PAN SCAN]**: This aspect ratio is for a 4:3 standard TV (page 55)

- 7** Press **↑/↓** to select the Control for HDMI setting, then press **+**.

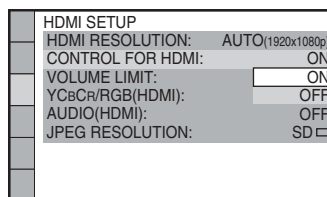

- **[ON]**: The Control for HDMI function is set to on.
- **[OFF]**: The Control for HDMI function is set to off.

- 8** Press \leftarrow/\rightarrow to select the speaker formation image as the speakers are actually positioned, then press \oplus .

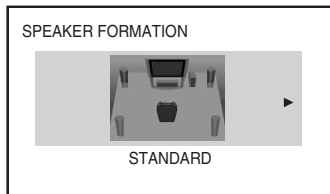

- [STANDARD]: Select this when you install all the speakers normally.
- [NO CENTER]: Select this when you install the front and surround speakers only.
- [NO SURROUND]: Select this when you install the center and front speakers only.
- [FRONT ONLY]: Select this when you install the front speakers only.
- [ALL FRONT]: Select this when you install all the speakers in front of the listening position.
- [ALL FRONT - NO CENTER]: Select this when you install the front and surround speakers in front of the listening position.

- 9** Connect the calibration mic (supplied) to the A.CAL MIC jack on the front panel.

Set up the calibration mic at ear level using a tripod, etc. (not supplied).

The front of each speaker should face the calibration mic, and there should be no obstruction between the speakers and the calibration mic.

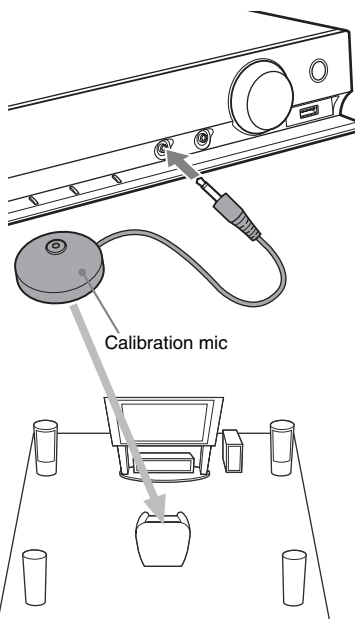

- 10** Press \leftarrow/\rightarrow to select [YES], then press \oplus .

Be quiet during the measurement.

Note

- Loud test sounds are output when [AUTO CALIBRATION] starts. You cannot turn the volume down. Give consideration to children and neighbors.
- The environment of the room in which the system is installed may affect measurements. When the measurements differ considerably from the status of the speaker installation, perform the speaker settings manually by following "Settings for the speakers" (page 60).

- 11** Unplug the calibration mic, press \leftarrow/\rightarrow to select [YES], then press \oplus .

To quit the Quick Setup

Press ☰ DISPLAY in any Step.

Setting the type of video output to match your TV

Depending on the connection of your TV (page 22), select the type of video output of the system.

To select the type of video signal output from the HDMI OUT jack

When you connect the unit and your TV with an HDMI cable, select the type of video signals output from the HDMI OUT jack.

1 Press DVD/CD.

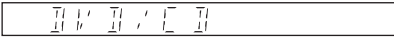

2 Press **DISPLAY** while the system is in stop mode.

3 Press **↑/↓** to select **SETUP**, then press **+**.

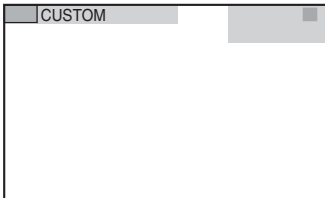

4 Press **↑/↓** to select **[CUSTOM]**, then press **+**.

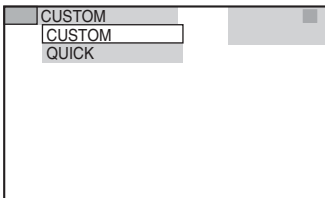

5 Press **↑/↓** to select **[HDMI SETUP]**, then press **+**.

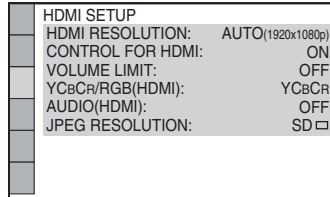

6 Press **↑/↓** to select **[HDMI RESOLUTION]**, then press **+**.

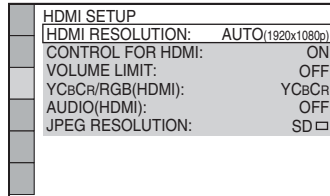

7 Press **↑/↓** to select the desired setting, then press **+**.

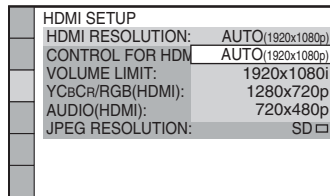

- **[AUTO (1920 × 1080p)]**: The system outputs the optimal video signal for the connected TV.
- **[1920 × 1080i]**: The system outputs 1920 × 1080i* video signals.
- **[1280 × 720p]**: The system outputs 1280 × 720p* video signals.
- **[720 × 480p]****: The system outputs 720 × 480p* video signals.

* i: interlace, p: progressive

** Depending on the area, [720 × 480/576p] may appear and the system may output 720 × 576p video signals.

To select the type of video signal output from the COMPONENT VIDEO OUT jacks

When you connect the unit and your TV with a component video cable, select the type of video signals output from the COMPONENT VIDEO OUT jacks.

1 Press DVD/CD.

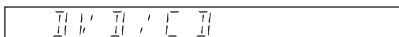

2 Press DISPLAY while the system is in stop mode.

3 Press \uparrow/\downarrow to select [SETUP], then press \oplus .

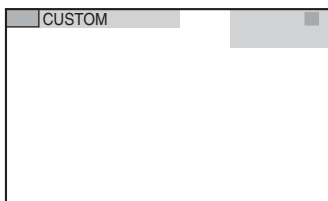

4 Press \uparrow/\downarrow to select [CUSTOM], then press \oplus .

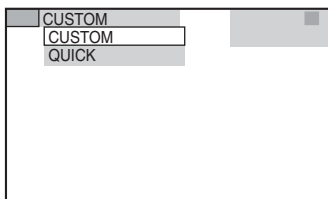

5 Press \uparrow/\downarrow to select [VIDEO SETUP], then press \oplus .

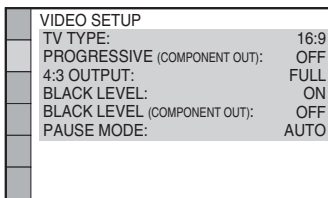

6 Press \uparrow/\downarrow to select [PROGRESSIVE (COMPONENT OUT)], then press \oplus .

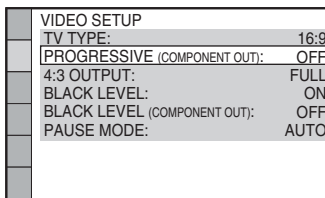

7 Press \uparrow/\downarrow to select the desired setting, then press \oplus .

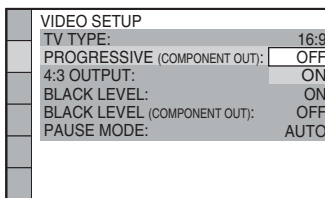

[OFF]: The system does not output progressive signals. Select this setting when:

- your TV does not accept progressive signals, or,
- your TV is connected via jacks other than the COMPONENT VIDEO OUT jacks.

[ON]: The system outputs progressive signals. Select this setting when:

- your TV accepts progressive signals, and,
- your TV is connected via the COMPONENT VIDEO OUT jacks.

When you select [ON], the confirmation display appears. Follow the Steps below.

8 Press \leftarrow/\rightarrow to select [START], then press \oplus .

The system outputs a progressive signal for about 5 seconds. Check that the screen is displayed correctly.

9 Press \leftarrow/\rightarrow to select [YES], then press \oplus .

The system outputs a progressive signal. When you select [NO], the system does not output a progressive signal.

Playing a Disc

DVD-V DVD-VR VIDEO CD Super Audio CD CD

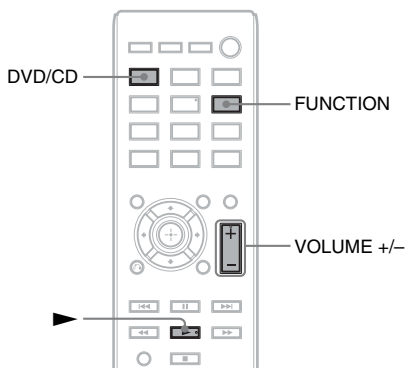
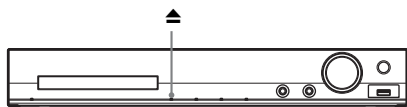

- 1** Press **DVD/CD**.
You can also select this function by pressing **FUNCTION** repeatedly.
- 2** Press **▲** to open the disc tray.
- 3** Place a disc on the tray, then press **▲**.

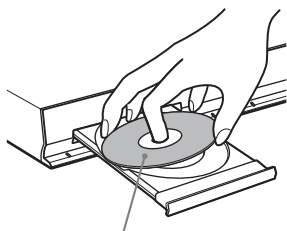

With the label side up.

- 4** Press **▶** to start playback.
- 5** Press **VOLUME +/-** to adjust the volume.

Playing Files on a Disc/USB Device

DATA CD DATA DVD USB

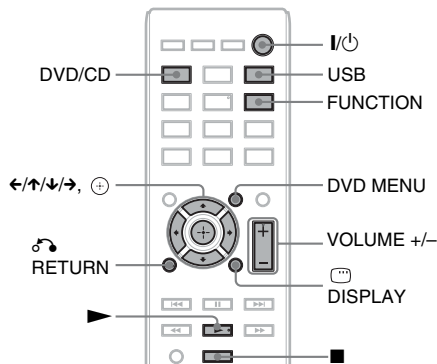
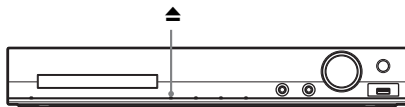

- 1** Press **DVD/CD** or **USB**.
 - **DVD/CD**: For a disc.
 - **USB**: For a USB device.
 You can also select the function by pressing **FUNCTION** repeatedly.
- 2** Load the source.
 - **For a disc**
Place a disc on the tray by pressing **▲** to open/close the disc tray.
 - **For a USB device**
Connect a USB device to the **↔** (USB) port.

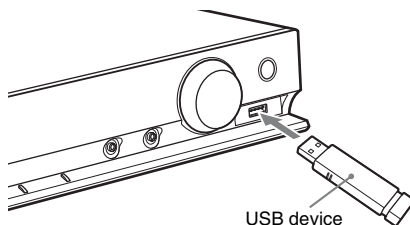

Note

- It may take about 10 seconds before “READING” appears in the front panel display depending on the type of USB device.

[FOLDER LIST] appears on the TV screen. If [FOLDER LIST] does not appear, press DVD MENU.

3 Press \uparrow/\downarrow to select a folder.

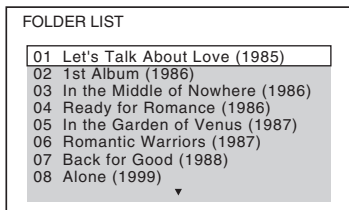

4 Press \blacktriangleright to start playback.

■ For video or audio files

The system starts playback of files in the selected folder.

■ For JPEG image files

The system starts a slide show of files in the selected folder.

5 Press VOLUME +/- to adjust the volume.

To select the playback source of the USB device

You can select the memory number for playback depending on the USB device.

Press MEM SEL.

Selected memory number

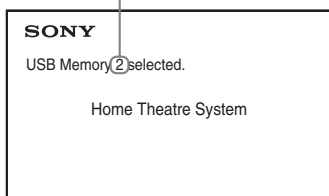
**Note**

- When the memory cannot be selected, [Operation not possible.] appears on the TV screen.
- The memory number changes depending on the USB device.

To remove the USB device

- 1 Press \blacksquare to stop playback.
- 2 Press I/power to turn off the system.
- 3 Remove the USB device.

Playing a specific file

DATA CD DATA DVD USB

1 Select a folder by following Steps in “Playing Files on a Disc/USB Device” (page 30).

2 Press \oplus to display the file list.

3 Select a file.

To return to the folder list, press RETURN .

■ For video or audio files

Press \uparrow/\downarrow to select a file.



■ For JPEG files

Press $\leftarrow/\uparrow/\downarrow/\rightarrow$ to select an image.

1	2	3	4
5	6	7	8
9	10	11	12
13	14	15	16

4 Start playback.

■ For video or audio files

Press \blacktriangleright to start playback from the selected file.

■ For JPEG image files

Press \blacktriangleright to start a slide show beginning with the selected file. Press \oplus to display only the selected file.

To turn on/off the list of folders/files

Press DVD MENU.

To display the list of folders/files using the Control Menu

- 1 Press DISPLAY.
- 2 Press \uparrow/\downarrow to select [BROWSING], then press \oplus .
- 3 Press \uparrow/\downarrow to select the desired list, then press \oplus .
 - [FOLDER LIST]: A list of folders appears. To display a list of files, press \uparrow/\downarrow to select a folder, then press \oplus .
 - [PICTURE LIST] (JPEG image files only): A thumbnail list of the JPEG image files in the folder appears.

When different file types are on a disc/USB device

DATA CD **DATA DVD** **USB**

You can select the file type that is played with priority when mixed media (audio files, JPEG image files, or video files) are on the disc/USB device.

- 1 Press DISPLAY.
- 2 Press \uparrow/\downarrow to select [MEDIA], then press \oplus .
- 3 Press \uparrow/\downarrow to select a setting, then press \oplus .
 - [MUSIC/PHOTO] (DATA CD/DATA DVD only): You can play both JPEG image files and MP3 files in the same folder as a slide show.
 - [MUSIC]: Audio file playback has priority.
 - [VIDEO]: Video file playback has priority.
 - [PHOTO]: JPEG image file playback has priority. You can play JPEG image files as a slide show.

The default setting differs depending on the source.

For details of the playback priority of file types under the [MEDIA] setting, see “Playback Priority of File Types” (page 73).

Other Playback Operations

Playback operation buttons on the remote

DVD-V **DVD-VR** **VIDEO CD** **Super Audio CD** **CD**
DATA CD **DATA DVD** **USB**

Depending on the type of disc/file, the function may not work.

To	Press
Stop	
Pause	
Return to normal playback or resume playback after pause	
Cancel the resume point	twice.
Skip the current chapter, track, file, or scene	or • : go to the beginning. • Press twice in a second to go to the previous item. • : go to the next item.
Skip the current JPEG image file	or during playback. • : go to the previous file. • : go to the next item.
Locate a point quickly	or while playing a disc. • : fast reverse scan. • : fast forward scan. Each time you press or during scan, the scan speed changes.

To	Press
Watch frame by frame	<p>II, then press ◀ /◀◀ or ▶▶/▶ .</p> <ul style="list-style-type: none"> ◀ /◀◀: slow-motion play (reverse). ▶▶/▶ : slow-motion play (forward). <p>Each time you press ◀ /◀◀ or ▶▶/▶ during slow-motion play, the playback speed changes.</p>
Rotate a JPEG image file	<p>↑/↓ while viewing a JPEG image file.</p> <p>Press CLEAR while holding down SHIFT to return to normal view.</p>

Tip

- When playing files, you can select the next folder by continuing to press **▶▶|** (→ for JPEG image files) after the last file on the current folder, but you cannot return to the previous folder by pressing **◀◀|** (← for JPEG image files). To return to the previous folder, select the folder from the folder list.
- You cannot rotate the JPEG image file when you set [JPEG RESOLUTION] in [HDMI SETUP] to [(1920 × 1080i) HD □] or [(1920 × 1080i) HD] (page 56).

Playing a specific title/ chapter/track/scene, etc.

To select the title/chapter/track/ scene/index/folder/file number for playback



- 1 Press **DISPLAY**.
- 2 Press **↑/↓** to select the search method, then press **+**.
 - [TITLE/SCENE/TRACK]
 - [CHAPTER/INDEX]
 - [TRACK]
 - [INDEX]
 - [FOLDER]
 - [FILE]

Example: [CHAPTER]
 [** (**)] is selected (** refers to a number).
 The number in parentheses indicates the total number of titles, chapters, tracks, indexes, scenes, folders, or files.

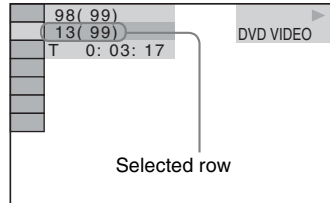

Note

- If [MEDIA] is set to [MUSIC/PHOTO] and [FILE] does not appear, press **DISPLAY** again.

3 Press **↑/↓** to select the desired number of the title, chapter, track, scene, etc., then press **+**.

You can also select the number by pressing the number buttons while holding down **SHIFT**.

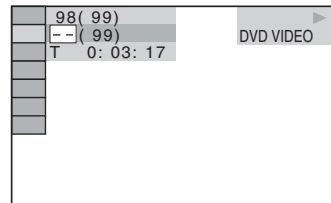

If you make a mistake, press **CLEAR** while holding down **SHIFT** to cancel the number.

To select a scene using the time code



- 1 Press **DISPLAY**.
- 2 Press **↑/↓** to select [TIME], then press **+**.
- 3 Input the time code using the number buttons while holding down **SHIFT**, then press **+**.

For example, to find a scene at 2 hours, 10 minutes, and 20 seconds after the beginning: press 2, 1, 0, 2, 0 ([2:10:20]) while holding down **SHIFT**.

Note

- You cannot search for a scene on a DVD+RW using the time code.

Changing angles

DVD-V

Press **ANGLE** during playback to select the desired angle.

Displaying subtitles

DVD-V **DVD-VR**

Press **SUBTITLE** during playback to select the desired subtitle language.

Changing the audio

DVD-V **DVD-VR** **VIDEO CD** **C D** **DATA CD****DATA DVD** **USB**

Press **AUDIO** repeatedly during playback to select the sound.

■ DVD VIDEO

You can toggle audio format or language when the source contains multiple audio formats or multilingual audio.

When 4 digits are displayed, they indicate a language code. See “Language Code List” (page 74) to confirm which language the code represents.

When the same language is displayed two or more times, the DVD VIDEO is recorded in multiple audio formats.

Example:

Dolby Digital 5.1 channel

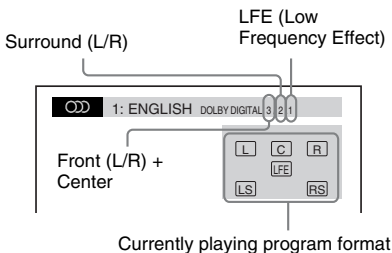
**■ DVD-VR**

You can toggle audio tracks when a disc contains multiple audio tracks.

■ VIDEO CD/CD/DATA CD (MP3 file)/DATA DVD (MP3 file)/USB device (audio file)

You can change the sound track.

- [STEREO]: The stereo sound.
- [1/L]: The sound of the left channel (monaural).
- [2/R]: The sound of the right channel (monaural).

■ Super VCD

You can change the sound track.

- [1:STEREO]: The stereo sound of audio track 1.
- [1:1/L]: The sound of the left channel of audio track 1 (monaural).
- [1:2/R]: The sound of the right channel of audio track 1 (monaural).
- [2:STEREO]: The stereo sound of audio track 2.
- [2:1/L]: The sound of the left channel of audio track 2 (monaural).
- [2:2/R]: The sound of the right channel of audio track 2 (monaural).

Using the DVD's menu

DVD-V

When you play a DVD which contains several titles, you can select the title you want using **DVD TOP MENU**.

When you play a DVD that allows you to select items such as the language for the subtitles and the language for the sound, select these items using **DVD MENU**.

- 1 Press **DVD TOP MENU** or **DVD MENU**.
- 2 Press **←/↑/↓/→** to select the item you want to play or change, then press **+**.

You can also select the number by pressing the number buttons while holding down **SHIFT**.

To display the DVD's menu on the Control Menu



- 1 Press **DISPLAY**.

- 2 Press \uparrow/\downarrow to select  [DISC MENU], then press \oplus .
- 3 Press \uparrow/\downarrow to select [MENU] or [TOP MENU], then press \oplus .

Selecting an original title or edited title on a DVD-VR

DVD-VR



This function is only available for DVD-VRs with a playlist created.

- 1 Press  DISPLAY while the system is in stop mode.
- 2 Press \uparrow/\downarrow to select  [ORIGINAL/PLAY LIST], then press \oplus .
- 3 Press \uparrow/\downarrow to select a setting, then press \oplus .
 - [PLAY LIST]: You can play the titles in the order of the existing playlist.
 - [ORIGINAL]: You can play the titles as they were originally recorded.

Selecting a playback area for a Super Audio CD

Super Audio CD



Some Super Audio CDs consist of a 2 channel playback area and a multi-channel playback area. You can select the playback area you want to listen to.

- 1 Press  DISPLAY while the system is in stop mode.
- 2 Press \uparrow/\downarrow to select  [MULTI/2CH], then press \oplus .
- 3 Press \uparrow/\downarrow to select the setting, then press \oplus .
 - [MULTI]: You can play the multi-channel playback area.
 - [2CH]: You can play the 2 channel playback area.

Changing a playback layer for a hybrid Super Audio CD

Super Audio CD

Some Super Audio CDs consist of a Super Audio CD layer and a CD layer. You can change the playback layer you want to listen to.

- 1 Press  DISPLAY while the system is in stop mode.
- 2 Press \uparrow/\downarrow to select  [SUPER AUDIO CD/CD LAYER], then press \oplus .
 - When the current layer is the CD layer
[SUPER AUDIO CD] appears.
 - When the current layer is the Super Audio CD layer
[CD] appears.
- 3 Press \oplus to change the layer.
 - [SUPER AUDIO CD]: You can play the Super Audio CD layer.
When the system is playing a Super Audio CD layer, "SA-CD" lights up in the front panel display.
 - [CD]: You can play the CD layer.
When the system is playing a CD layer, "CD" lights up in the front panel display.

Note

- Super Audio CD audio signals are not output from the HDMI OUT jack.

Selecting the Playback Mode

Playing in programmed order

(Program Play)

VIDEO CD CD

You can play the contents of a disc in the order you want by arranging the order of the tracks on the disc to create your own program. You can program up to 99 tracks.

- 1 Press **DISPLAY**.
- 2 Press **↑/↓** to select **[PROGRAM]**, then press **+**.
- 3 Press **↑/↓** to select **[SET →]**, then press **+**.

Total time of the programmed tracks

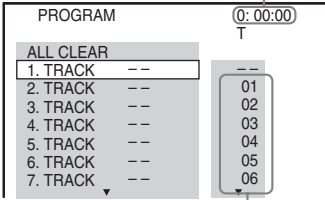

Tracks recorded on a disc

- 4 Press **→**.
The cursor moves to the track row [T] (in this case, [01]).

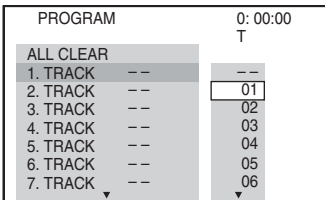

- 5 Select the track you want to program.

Ex. To set track 2 as the first programmed track

Press **↑/↓** to select [02] under [T], then press **+**.

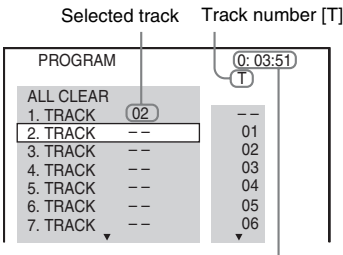

Total time of the programmed tracks

- 6 To program other tracks, repeat Steps 4 to 5.
- 7 Press **▶** to start Program Play.

To return to normal playback

Press CLEAR while holding down SHIFT when the display for the program setting is not displayed on the TV screen, or select [OFF] in Step 3. To play the same program again, select [ON] in Step 3 and press **+**.

To change or cancel a program

- 1 Follow Steps 1 to 3 of “Playing in programmed order.”
- 2 Press **↑/↓** to select the program number of the track you want to change or cancel.

If you want to delete the track from the program, press CLEAR while holding down SHIFT.

- 3 Follow Step 5 of “Playing in programmed order” for new programming.

To cancel a program, select [--] under [T], then press **+**.

To cancel all of the tracks in the programmed order

- 1 Follow Steps 1 to 3 of “Playing in programmed order.”
- 2 Press **↑** and select [ALL CLEAR], then press **+**.

Playing in random order

(Shuffle Play)

VIDEO CD Super Audio CD C D DATA CD DATA DVD

USB

Note

• The same song may be played repeatedly when you are playing MP3 files.

- 1 Press **DISPLAY** during playback.
- 2 Press **↑/↓** to select **[SHUFFLE]**, then press **+**.

3 Press \uparrow/\downarrow to select the item to be shuffled.

■ VIDEO CD/Super Audio CD/CD

- [OFF]: Off.
- [TRACK]: You can shuffle tracks on the disc.

■ During Program Play

- [OFF]: Off.
- [ON]: You can shuffle tracks selected in Program Play.

■ DATA CD (audio files only)/DATA DVD (audio files only)/USB device (audio files only)

- [OFF]: Off.
- [ON (MUSIC)]: You can shuffle audio files in the folder on the current disc/USB device. When no folder is selected, the audio files in the first folder are shuffled.

4 Press \oplus to start Shuffle Play.

To return to normal playback

Press CLEAR while holding down SHIFT, or select [OFF] in Step 3.

Note

- You cannot use Shuffle Play with a VIDEO CD or Super VCD with PBC playback.

Playing repeatedly

(Repeat Play)



1 Press DISP DISPLAY during playback.

2 Press \uparrow/\downarrow to select REPEAT [REPEAT], then press \oplus .

3 Press \uparrow/\downarrow to select the item to be repeated, then press \oplus .

■ DVD VIDEO/DVD-VR

- [OFF]: Off.
- [DISC]: You can repeat all of the titles on the disc.
- [TITLE]: You can repeat the current title on a disc.
- [CHAPTER]: You can repeat the current chapter on a disc.

■ VIDEO CD/Super Audio CD/CD

- [OFF]: Off.
- [DISC]: You can repeat all of the tracks on the disc.
- [TRACK]: You can repeat the current track.

■ DATA CD/DATA DVD/USB device

- [OFF]: Off.
- [DISC] (DATA CD/DATA DVD only): You can repeat all of the folders on the disc.
- [MEMORY] (USB device only): You can repeat all of the folders on the USB device.
- [FOLDER]: You can repeat the current folder.
- [TRACK] (audio files only): You can repeat the current file.
- [FILE] (video files only): You can repeat the current file.

4 Press \blacktriangleright to start Repeat Play.

To return to normal playback

Press CLEAR while holding down SHIFT, or select [OFF] in Step 3.

Note

- You cannot use Repeat Play with a VIDEO CD or Super VCD with PBC playback.

Selecting an effect for the slide show



1 Press DISP DISPLAY repeatedly until EFFECT [EFFECT] appears on the control menu.

2 Press \uparrow/\downarrow to select EFFECT [EFFECT], then press \oplus .

3 Press \uparrow/\downarrow to select a setting, then press \oplus .

- [MODE 1]: The JPEG image file sweeps in from the top to the bottom of the TV screen.
- [MODE 2]: The JPEG image file stretches out from the left to the right of the TV screen.

- [MODE 3]: The JPEG image file stretches out from the center of the TV screen.
- [MODE 4]: The JPEG image files randomly cycle through the effects.
- [MODE 5]: The next JPEG image file slides over the previous image.
- [OFF]: Off.

Note

- The [EFFECT] setting is not effective when you set [JPEG RESOLUTION] in [HDMI SETUP] to [(1920 × 1080i) HD] or [(1920 × 1080i) HD] (page 56).
- The [EFFECT] setting cannot be selected when you are playing a disc that does not contain JPEG image files or a USB device, or when you set [MEDIA] to a setting that cannot play JPEG image files.

Selecting the slide show duration

DATA CD DATA DVD USB

- 1 Press DISPLAY repeatedly until [INTERVAL] appears on the control menu.
- 2 Press \uparrow/\downarrow to select [INTERVAL], then press \oplus .
- 3 Press \uparrow/\downarrow to select a setting, then press \oplus .
 - [NORMAL]: You can set to the standard duration.
 - [FAST]: You can set the duration shorter than [NORMAL].
 - [SLOW 1]: You can set the duration longer than [NORMAL].
 - [SLOW 2]: You can set the duration longer than [SLOW 1].

Note

- Some JPEG image files may take longer to display than the option you selected, especially progressive JPEG image files or JPEG image files of 3,000,000 pixels or more.
- The [INTERVAL] setting cannot be selected when you are playing a disc that does not contain JPEG image files or a USB device, or when you set [MEDIA] to a setting that cannot play JPEG image files.

Playing a slide show with sound

DATA CD DATA DVD

- 1 Prepare a folder on a disc which contains both MP3 files and JPEG image files.
The MP3 files and JPEG image files must not be in separate folders. For details of making the disc, refer to the instructions of your PC, software, etc.
- 2 Press DISPLAY.
- 3 Press \uparrow/\downarrow to select [MEDIA], then press \oplus .
- 4 When [MUSIC/PHOTO] is selected, go to Step 5. When other than [MUSIC/PHOTO] is selected, press \uparrow/\downarrow to select [MUSIC/PHOTO], then press \oplus .
- 5 If the folder list does not appear, press DVD MENU.
You can turn the folder list on/off by pressing DVD MENU repeatedly.
- 6 Press \uparrow/\downarrow to select the desired folder and press \blacktriangleright .

Note

- If you play a large MP3 file and JPEG image file at the same time, the sound may skip. Sony recommends that you set the MP3 bit rate to 128 kbps or lower when creating the file. If the sound still skips, reduce the size of the JPEG image file.

Displaying the Information of a Disc/USB Device

Viewing playback information



Press **TIME/TEXT** repeatedly during playback.

Information on the TV screen

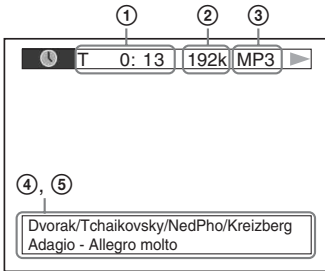

- ① **[T **:**:*/C **:**:*/D **:**:*]**
Playing time of the current title, track/
chapter/disc

[T-:**:*/C-**:**:*/D-**:*:*]**
Remaining time of the current title, track/
chapter/disc

[*::*]**
Playing time of the current scene/video file
- ② **Bit rate**
Appears when playing an audio file.
- ③ **File type**
Appears when playing an audio/video file.
- ④ **Folder/file name**
Appears when playing an audio file/JPEG
image file/video file.
If an MP3 file has an ID3 tag, the system
will display an album name/title name from
the ID3 tag information.
The system can support ID3 ver 1.0/1.1/2.2/

2.3.

ID3 ver 2.2/2.3 tag information display has priority when both ID3 ver 1.0/1.1 and ver 2.2/2.3 tags are used for a single MP3 file.

⑤ Text information

The DVD/Super Audio CD/CD text appears only when text is recorded on the disc. You cannot change the text. If the disc does not contain text, “NO TEXT” appears.

Note

- Depending on the source being played, the system can only display a limited number of characters. Also, depending on the source, not all text characters will be displayed.

Information in the front panel display

Each time you press **TIME/TEXT** during playback, the following information appears. Some displayed items may disappear after a few seconds.

■ DVD VIDEO/DVD-VR

- ① Playing time of the current title
- ② Remaining time of the current title
- ③ Playing time of the current chapter
- ④ Remaining time of the current chapter
- ⑤ Disc name
- ⑥ Title and chapter

■ VIDEO CD (with PBC functions)/Super VCD (with PBC functions)

- ① Playing time of the current item
- ② Disc name
- ③ Scene number

■ VIDEO CD (without PBC functions)/Super Audio CD/CD

- ① Playing time of the current track
- ② Remaining time of the current track
- ③ Playing time of the disc
- ④ Remaining time of the disc
- ⑤ Track name
- ⑥ Track and index*

* VIDEO CD/Super Audio CD only.

■ Super VCD (without PBC functions)

- ① Playing time of the current track
- ② Track text
- ③ Track and index number

■ DATA CD/DATA DVD/USB device (audio file)

① Playing time and current track number

② Track (file) name*

* If an MP3 file has an ID3 tag, the system will display a title name from the ID3 tag information. The system can support ID3 ver 1.0/1.1/2.2/2.3. ID3 ver 2.2/2.3 tag information display has priority when both ID3 ver 1.0/1.1 and ver 2.2/2.3 tags are used for a single MP3 file.

■ DATA CD (video file)/DATA DVD (video file)/USB device (video file)

① Playing time of the current file

② Current file name

③ Current album and file number



Note

- The system can only display the first level of the DVD/CD text, such as the disc name or title.
- The disc name or track name may not be displayed depending on the text.
- Playing time of MP3 files and video files may not be displayed correctly.

Viewing the date information of a JPEG image file

DATA CD DATA DVD USB

You can check the date information during playback when the Exif* tag is recorded in the JPEG image file.

Press  **DISPLAY** repeatedly until  **[DATE]** appears on the control menu.

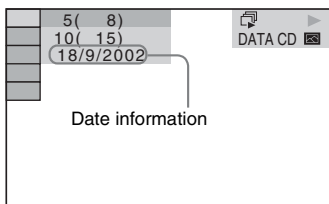

* “Exchangeable Image File Format” is a digital camera image format defined by the Japan Electronics and Information Technology Industries Association (JEITA).

Enjoying the Audio/Video of the Connected Component

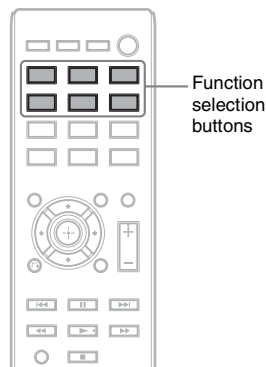

1 Use the function selection buttons to select the desired function.

The selected item appears in the front panel display.

Button	Source
DVD/CD	Disc that is played by the system
FM	FM radio
USB	USB device or iPod that is connected to the  (USB) port.
TV/CABLE	TV or cable box
AUDIO IN	Portable audio source that is connected to the AUDIO IN jack on the front panel

You can also select the desired function by pressing **FUNCTION** repeatedly.

2 Prepare the source.

- DVD/CD: Insert the disc into the unit (page 30).
- TUNER FM: Select the radio program (page 42).
- USB: Connect the USB device directly (page 30), or iPod via a USB cable (page 41).
- TV/CABLE: Select the channel on the TV or cable box.
- AUDIO IN: Connect the portable audio source via an audio cord (stereo mini-plug cord) (page 24).

3 Operate the connected component.

To enjoy a cable box, select the input of the cable box via the TV to which it is connected.

iPod models that can be operated via USB

You can operate an iPod using the buttons on the remote by connecting the iPod via the  (USB) port to the system.

The battery of the iPod is charged via the system.

The iPod models that can be operated via USB are as follows. Update your iPod with the latest software before using it with the system.



iPod nano
5th generation (video camera)



iPod touch
2nd generation



iPod classic



iPod nano
4th generation (video)



iPod touch
1st generation



iPod nano
3rd generation
(video)



iPod nano
2nd generation
(aluminum)

Remote buttons for operating an iPod connected to the system are as follows:

Press	Operation
	Same operation as the button of the iPod.
	Pause.
	Fast reverse or forward.
	Same operation as the buttons of the iPod.
	Same operation as the MENU button of the iPod.
	Same operation as the Click Wheel of the iPod.
	Same operation as the Center button of the iPod.

Note

- The iPod is charged when connected to the system while the system is turned on.
- You cannot transfer songs onto the iPod.
- Sony cannot accept responsibility in the event that data recorded to iPod is lost or damaged when using an iPod connected to this unit.
- This product has been designed specifically to work with iPod and has been certified to meet Apple performance standards.

Presetting Radio Stations

You can preset 20 FM stations.

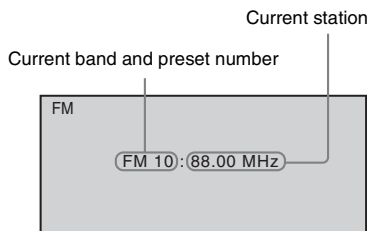

- 1** Press **FM**.
- 2** Press and hold **TUNING +/-** until the auto scanning starts.

Scanning stops when the system tunes in a station. "TUNED" appears in the front panel display. When a stereo program is received, "ST" also appears in the front panel display.

- 3** Press **SYSTEM MENU**.
- 4** Press **↑/↓** to select "MEMORY."
- 5** Press **⊕** or **→**.

A preset number appears in the front panel display.

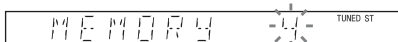

- 6** Press **↑/↓** to select the preset number you want.

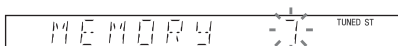

- 7** Press **⊕**.
"COMPLETE" appears in the front panel display, and the station is stored.
- 8** Repeat Steps 2 to 7 to store other stations.
- 9** Press **SYSTEM MENU**.

To change the preset number

Select the desired preset number by pressing **PRESET +/-** (page 42), then perform the procedure from Step 3.

Listening to the Radio

Preset radio stations in the system's memory first (see "Presetting Radio Stations" (page 42)).

- 1** Press **FM**.
- 2** Press **PRESET +/-** repeatedly to select the preset station.
- 3** Adjust the volume by pressing **VOLUME +/-**.

To listen to radio stations when you know the frequencies

Press **D.TUNING** in Step 2, press the number buttons while holding down **SHIFT** to select the frequencies, then press **⊕**.

To listen to non-preset radio stations

Use manual or automatic tuning in Step 2. For manual tuning, press **TUNING +/-** repeatedly.

For automatic tuning, press and hold **TUNING +/-**. The automatic tuning stops automatically when the system receives the radio station. To stop the automatic tuning manually, press **TUNING +/-** or **■**.

If an FM program is noisy

If an FM program is noisy, you can select monaural reception. There will be no stereo effect, but reception will improve.

- 1** Press **SYSTEM MENU**.
- 2** Press **↑/↓** to select "FM MODE."

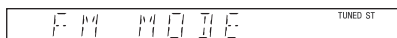

- 3** Press **⊕** or **→**.
- 4** Press **↑/↓** to select "MONO."
 - "STEREO": Stereo reception.
 - "MONO": Monaural reception.

5 Press \oplus .

6 Press SYSTEM MENU.



Tuner

Enjoying Surround Sound

You can enjoy surround sound simply by selecting one of the system's pre-programmed surround settings.

Enjoying TV sound with the 5.1 channel surround sound effect

- 1** Press **SYSTEM MENU**.
- 2** Press **↑/↓** to select **"SUR.SETTING,"** then press **⊕** or **→**.
The selected item appears in the front panel display.
- 3** Press **↑/↓** to select **"PRO LOGIC,"** then press **⊕**.
- 4** Press **SYSTEM MENU**.

Note

- When TV program sound is monaural, sound is output only from the center speaker.

Selecting surround settings based on your listening preference

- 1** Press **SYSTEM MENU**.
- 2** Press **↑/↓** to select **"SUR.SETTING,"** then press **⊕** or **→**.
The selected item appears in the front panel display.
- 3** Press **↑/↓** to select the surround setting you want, then press **⊕**.
See the table below for surround setting descriptions.
- 4** Press **SYSTEM MENU**.

About speaker output

The table below describes the options when you connect all the speakers to the unit and you set [SPEAKER FORMATION] to [STANDARD] (page 57).

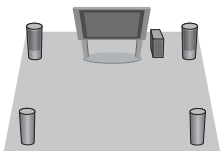
Sound from	Surround setting	Effect
	"A.F.D. MULTI" (AUTO FORMAT DIRECT MULTI)	<ul style="list-style-type: none"> • 2 channel source: The system outputs 2 channel sound from the front and surround speakers by assigning the 2 channel sound to the surround left and right channels. • Multi-channel source: The system outputs sound from the speakers depending on the number of channels of the source.

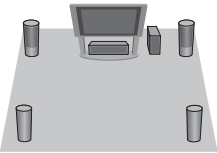
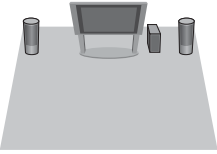
Sound from	Surround setting	Effect
	"PRO LOGIC" "PLII MOVIE" "PLII MUSIC"	<ul style="list-style-type: none"> • 2 channel source: The system simulates surround sound from 2 channel sources and outputs sound from all the speakers. <ul style="list-style-type: none"> – "PRO LOGIC" performs Dolby Pro Logic decoding. – "PLII MOVIE" performs Dolby Pro Logic II movie mode decoding. – "PLII MUSIC" performs Dolby Pro Logic II music mode decoding. • Multi-channel source: The system outputs sound from the speakers depending on the number of channels of the source.
	"2CH STEREO"	The system outputs the sound from the front speakers and subwoofer regardless of sound format or number of channels. Multi-channel surround formats are downmixed to 2 channels.
Depending on the source.	"A.F.D. STD" (AUTO FORMAT DIRECT STANDARD)	The system discriminates the sound format of the source and presents sound as it was recorded/encoded.

Note

- You cannot select the surround settings while the system is loading a disc.
- Depending on the input stream, the surround settings may not be effective.

Selecting the Sound Effect

Selecting the effect to suit the source

Press **SOUND MODE** repeatedly during playback until the desired mode appears in the front panel display.

- **“AUTO”**: The system automatically selects “MOVIE” or “MUSIC” to produce the sound effect depending on the source. “AUTO” appears in the front panel display.
- **“MOVIE”**: The system provides the sound for movies. “MOVIE” appears in the front panel display.
- **“MUSIC”**: The system provides the sound for music. “MUSIC” appears in the front panel display.

Note

- When you play a Super Audio CD, this function does not work.

Enhancing compressed sound

You can enhance compressed sound such as an MP3 file.

This effect is activated automatically when all the following conditions are satisfied:

- The function is set to “AUDIO IN” or “USB.”
- “SUR.SETTING” is set to “A.F.D. STD” or “A.F.D. MULT” (page 44).

To turn off the sound effect

Select other than “A.F.D. STD” or “A.F.D. MULT” for “SUR.SETTING” (page 44).

Using the Control for HDMI Function for “BRAVIA” Sync

This function is available on TVs with the “BRAVIA” Sync function.

By connecting Sony components that are compatible with the Control for HDMI function with an HDMI cable, operation is simplified as below:

- System Power Off (page 47)
- One-Touch Play (page 48)
- Theater Mode (page 48)
- System Audio Control (page 48)
- Volume Limit (page 48)
- Remote Easy Control (page 48)
- Language Follow (page 48)

Control for HDMI is a mutual control function standard used by CEC (Consumer Electronics Control) for HDMI (High-Definition Multimedia Interface).

Note

- Depending on the connected component, the Control for HDMI function may not work. Refer to the operating instructions of the component.

Preparing the Control for HDMI function

(Control for HDMI - Easy Setting)

If your TV is compatible with the Control for HDMI - Easy Setting function, you can set the system’s [CONTROL FOR HDMI] function automatically by setting your TV. For details, refer to the operating instructions of your TV.

If your TV is not compatible with the Control for HDMI - Easy Setting function, set the Control for HDMI function of the system and TV manually.

- 1** Make sure that the system and your TV are connected with an HDMI cable.
- 2** Turn on your TV and press **I/⏻** to turn on the system.
- 3** Switch the input selector on your TV so that the signal from the system through the HDMI input appears on the TV screen.
- 4** Set the Control for HDMI function of your TV.
For details of the setting of your TV, refer to the operating instructions of your TV.
- 5** On the system, press **DVD/CD**.
- 6** Press **☐ DISPLAY** while the system is in stop mode.
- 7** Press **↑/↓** to select **📺 [SETUP]**, then press **+**.
- 8** Press **↑/↓** to select **[CUSTOM]**, then press **+**.
- 9** Press **↑/↓** to select **[HDMI SETUP]**, then press **+**.
- 10** Press **↑/↓** to select **[CONTROL FOR HDMI]**, then press **+**.
- 11** Press **↑/↓** to select **[ON]**, then press **+**.

Turning the system off in sync with your TV

(System Power Off)

When you turn your TV off by using the POWER button on your TV’s remote or TV **I/⏻** on the system’s remote, the system turns off automatically.

Note

- This function depends on the settings of your TV. For details, refer to the operating instructions of your TV.
- Depending on the status of the system (ex. while playing a CD), the system may not turn off automatically.

Watching a DVD by a single button press

(One-Touch Play)

Press ONE-TOUCH PLAY

Your TV turns on, your TV's function is set to the HDMI input to which the system is connected, and the system starts playing a disc automatically.

The System Audio Control function is also activated automatically.

Using the Theater Mode

(Theater Mode)

If your TV is compatible with the Theater Mode, you can enjoy optimal image and sound quality suited for movies, and the System Audio Control function is activated automatically.

Press THEATER.

Enjoying TV sound from the speakers by this system

(System Audio Control)

To use this function, connect the system and your TV with an audio cord and an HDMI cable (page 22).

Press **I/⏻** to turn on the system while your TV is turned on.

The System Audio Control function is activated. TV sound is output from the system speakers, and the volume of your TV's speakers is minimized automatically.

Note

- While your TV is in PAP (picture and picture) mode, the System Audio Control function will not work. When your TV exits PAP mode, the output method of your TV returns to the one before PAP mode.
- When you turn the system on by pressing the function selection button, video and sound may not match.
- Depending on the TV, when you adjust the system's volume, the volume level appears on the TV screen. In this case, the volume levels that appear on the TV screen and the front panel display of the system may differ.

Tip

- You can also operate the System Audio Control function via the TV menu.
- You can operate the volume and mute control of the system via the TV remote.

Limiting the volume level of TV sound from the system's speakers

(Volume Limit)

When the System Audio Control function is activated and TV sound is output from the system's speakers, the volume level is limited to the level that is set in [VOLUME LIMIT]. For details, see [VOLUME LIMIT] (page 56).

Operating the system via the TV remote

(Remote Easy Control)

You can control the basic functions of the system via the TV remote when the system's video output is displayed on the TV screen. For details, refer to the operating instructions of the TV.

Changing the language for the system's on-screen display in sync with your TV

(Language Follow)

When you change the language for the on-screen display of your TV, the system's on-screen display language is also changed.

Note

- When the system's on-screen display is displayed, this function does not work.

Transferring Songs onto a USB Device

You can transfer songs on an audio CD onto a USB device by encoding to MP3 format. You can also transfer MP3 files on a DATA CD/ DATA DVD onto a USB device. For connecting the USB device, see “Playing Files on a Disc/USB Device” (page 30).

The transferred music is limited to private use only. Use of the music beyond this limit requires permission of the copyright holders.

Notes on USB transferring

- Do not connect the unit and the USB device through a USB hub.
- Make sure there is enough space in the USB device for transferring.
- Do not remove the USB device during transferring.
- When you are transferring tracks from an audio CD, the tracks are recorded as 128 kbps MP3 files.
- When you are transferring MP3 files from a DATA CD/DATA DVD, the MP3 files are transferred with the same bit rate as the original MP3 files.
- CD text information is not transferred in the created MP3 files.
- If you stop a transfer from an audio CD halfway, the MP3 file that was being created is deleted.
- Transferring stops automatically if:
 - the USB device runs out of space during transfer.
 - the number of folders on the USB device reaches the limit for the number that the system can recognize.
- You can store up to 150 files in a folder.
- You can store up to 199 folders in a single USB device.
- If a folder or file that you are trying to transfer already exists on the USB device with the same name, a sequential number is added after the name without overwriting the original folder or file.

To select the transfer destination of the USB device

You can select the memory number for transfer depending on the USB device.

Press MEM SEL.

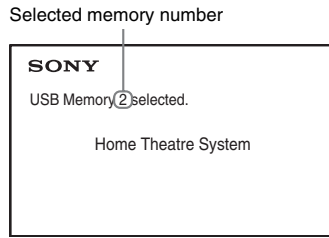

Note

- When the memory cannot be selected, [Operation not possible.] appears on the TV screen.
- The memory number changes depending on the USB device.
- Select a transfer destination before transfer.

Folder and file generation rules

When transferring onto a USB device, a “MUSIC” folder is created directly below the “ROOT”. Folders and files are generated within this “MUSIC” folder as follows according to the transferring method and source.

- When transferring multiple tracks on an audio CD or multiple MP3 files on a DATA CD/ DATA DVD

Source	Folder name	File name
MP3	Same as the transferring source ¹⁾	
Audio CD	“FLDR001” ²⁾	“TRACK001” ³⁾

- When transferring a single track on an audio CD or a single MP3 file on a DATA CD/ DATA DVD

Source	Folder name	File name
MP3	“REC1-MP3” ⁴⁾	Same as the transferring source ¹⁾
Audio CD	“REC1-CD” ⁴⁾	“TRACK001” ³⁾

¹⁾Up to 64 characters of the name are assigned (including the extension).

²⁾Folders are assigned in numeric order thereafter.

³⁾Files are assigned in numeric order thereafter.

4) A new file is transferred in the “REC1-MP3” or “REC1-CD” folder each time single-track transferring is performed.

Transferring tracks on an audio CD or MP3 files on a DATA CD/DATA DVD onto a USB device

- 1 Load an audio CD/DATA CD/DATA DVD.
- 2 Press **DISPLAY** while the system is in stop mode.
- 3 Press **↑/↓** to select **[USB TRANSFER]**, then press **+**.

■ For an audio CD

Press **+** and skip to Step 5.

■ For a DATA CD/DATA DVD

Follow the next Step.

- 4 Press **↑/↓** to select **[TRACK]** or **[FOLDER]**, then press **+**.
 - **[TRACK]**: The folder list appears. Press **↑/↓** to select the desired folder, then press **+**.
 - **[FOLDER]**: The folders recorded on the DATA CD/DATA DVD appear. You can transfer all MP3 files in the folder.
- 5 Press **←/↑/↓/→** to select **[■ ALL]** (for an audio CD) or **[☑ ALL]** (for a DATA CD/DATA DVD), then press **+**.
To deselect all tracks, select **[□ ALL]**, then press **+**.
- 6 Press **←/↑/↓/→** to select **[START]**, then press **+**.
To cancel transferring, press **■**.

To select individual tracks/MP3 files/folders

Press **↑/↓** to highlight the track/MP3 file/folder, then press **+** to add a check in Step 5.

To cancel the selection, highlight the track/MP3 file/folder, then press **+** to remove the check.

■ For an audio CD

Remaining space of the USB device

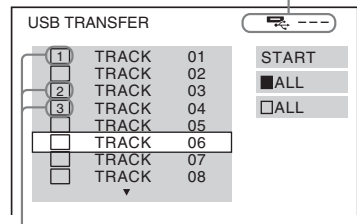

Tracks to be transferred.

■ For a DATA CD/DATA DVD

Remaining space of the USB device



MP3 files/folders to be transferred.

Transferring by single button press

You can transfer tracks/MP3 files simply onto a USB device by using REC TO USB.

- 1 Load an audio CD/DATA CD/DATA DVD.
- 2 Press **■**.
To transfer all tracks, skip to Step 4.
To transfer a single track, follow the next Step.
- 3 Select the desired track/MP3 file, then press **▶**.
- 4 Press **REC TO USB** on the unit.
REC TO USB lights up and “READING” appears in the front panel display. Then, “PUSH PLAY” and the remaining space of the USB device appear alternately in the front panel display.

5 Press **▶** to start transferring.

When transferring is completed, "COMPLETE" appears in the front panel display and playback of the disc and USB device stops automatically.

To cancel transferring, press **■**.

Erasing audio files on a USB device

You can erase audio files ("mp3," "wma," or "m4a") on the USB device.

1 Press **USB**.

2 Press **↑/↓** to select a folder.

3 Select the audio file(s).

■ To erase all audio files in a folder

Press **CLEAR** while holding down **SHIFT**.

■ To erase an audio file

Press **⊕** and press **↑/↓** to select the desired audio file, then press **CLEAR** while holding down **SHIFT**.

4 Press **←/→** to select **[YES]**, then press **⊕**.

To cancel, select **[NO]**, then press **⊕**.

Note

- Do not remove the USB device while erasing.
- If the folder to be erased contains non-audio format files or sub folders, these are erased from the list on the TV screen, but are not erased from the USB device.

Using the sleep timer

You can set the system to turn off at a preset time, so you can fall asleep listening to music.

1 Press **SYSTEM MENU**.

2 Press **↑/↓** to select "SLEEP," then press **⊕** or **→**.

The selected item appears in the front panel display.

3 Press **↑/↓** to select a setting, then press **⊕**.

The minutes display (the remaining time) changes by 10 minutes.

4 Press **SYSTEM MENU**.

Adjusting the Delay Between the Picture and Sound

[A/V SYNC]

DVD-V **DVD-VR** **VIDEO CD** **DATA CD** **DATA DVD**

When the sound does not match the pictures on the TV screen, you can adjust the delay between the picture and sound.

1 Press **⏏** **DISPLAY**.

2 Press **↑/↓** to select **[A/V SYNC]**, then press **⊕**.

3 Press **↑/↓** to select a setting, then press **⊕**.

- **[OFF]**: Off.
- **[ON]**: You can adjust the delay between the picture and sound.

Note

- Depending on the input stream, [A/V SYNC] may not be effective.

Enjoying Multiplex Broadcast Sound

(DUAL MONO)

You can enjoy multiplex broadcast sound when the system receives or plays a Dolby Digital multiplex broadcast signal.

Note

- To receive a Dolby Digital signal, you need to connect a TV or other component to the unit with a digital optical or digital coaxial cord (page 22).

Press AUDIO repeatedly to select the audio signal.

The selected item appears in the front panel display.

- “MAIN”: Sound of the main language will be output.
- “SUB”: Sound of the sub language will be output.
- “MAIN+SUB”: Mixed sound of both the main and sub languages will be output.

Changing the Input Level of the Sound from Connected Components

The sound distortion of the connected component may be improved by reducing the input level.

1 Press **TV/CABLE** or **AUDIO IN**.

2 Press **SYSTEM MENU**.

3 Press **↑/↓** to select “**ATTENUATE**,” then press **⊕** or **→**.

4 Press **↑/↓** to select a setting, then press **⊕**.

- “ATT ON”: You can attenuate the input level.
- “ATT OFF”: Normal input level.

This setting is made separately for each function.

5 Press **SYSTEM MENU**.

Changing the Brightness of the Front Panel Display

- 1** Press **SYSTEM MENU**.
- 2** Press **↑/↓** to select “DIMMER,” then press **⊕** or **→**.
The selected item appears in the front panel display.
- 3** Press **↑/↓** to select the brightness of the front panel display, then press **⊕**.
 - “DIMMER OFF”: The front panel display is bright.
 - “DIMMER ON”: The front panel display is dim.
- 4** Press **SYSTEM MENU**.

Setting the Demonstration Mode to On/Off

You can turn on/off the demonstration in the front panel display while the system is in standby mode.

- 1** Press **SYSTEM MENU**.
- 2** Press **↑/↓** to select “DEMO,” then press **⊕** or **→**.
The selected item appears in the front panel display.
- 3** Press **↑/↓** to select a setting, then press **⊕**.
 - “DEMO OFF”: Off.
 - “DEMO ON”: On.
- 4** Press **SYSTEM MENU**.

Reperforming the Quick Setup

- 1** Press **DVD/CD**.
- 2** Press **DISPLAY** while the system is in stop mode.
- 3** Press **↑/↓** to select **[SETUP]**, then press **⊕**.
- 4** Press **↑/↓** to select **[QUICK]**, then press **⊕**.
Perform the Quick Setup following the procedure of “Performing the Quick Setup” (page 26).

Set the System to Standby Mode Automatically

The system enters standby mode automatically when you do not operate the system for about 30 minutes and the system is not outputting sound for about 30 minutes. “AUTO STBY” begins to flash in the front panel display about 2 minutes before the system enters standby mode.

You can turn the auto standby function on/off.

- 1** Press **SYSTEM MENU**.
- 2** Press **↑/↓** to select “AUTO STBY,” then press **⊕** or **→**.
The selected item appears in the front panel display.
- 3** Press **↑/↓** to select the setting, then press **⊕**.
 - “ON”: On.
 - “OFF”: Off.
- 4** Press **SYSTEM MENU**.

Performing Further Settings

You can make various adjustments to items such as picture and sound.

Displayed items vary depending on the area.

Note

- Playback settings stored in the disc take priority over the Setup Display settings and not all the functions described may work.

- 1** Press DVD/CD.
- 2** Press **DISPLAY** while the system is in stop mode.
- 3** Press \uparrow/\downarrow to select **[SETUP]**, then press \oplus .
- 4** Press \uparrow/\downarrow to select **[CUSTOM]**, then press \oplus .
- 5** Press \uparrow/\downarrow to select the setup item, then press \oplus .
 - [LANGUAGE SETUP] (page 54)
 - [VIDEO SETUP] (page 55)
 - [HDMI SETUP] (page 56)
 - [AUDIO SETUP] (page 57)
 - [SYSTEM SETUP] (page 58)
 - [SPEAKER SETUP] (page 60)

Example: [VIDEO SETUP]

Selected item

VIDEO SETUP	
TV TYPE:	16:9
PROGRESSIVE (COMPONENT OUT):	OFF
4:3 OUTPUT:	FULL
BLACK LEVEL:	ON
BLACK LEVEL (COMPONENT OUT):	OFF
PAUSE MODE:	AUTO

Setup items

- 6** Press \uparrow/\downarrow to select an item, then press \oplus .



The options for the selected item appear.

Example: [TV TYPE]

VIDEO SETUP	
TV TYPE:	16:9
PROGRESSIVE (COMPONENT OUT):	16:9
4:3 OUTPUT:	4:3 LETTER BOX
BLACK LEVEL:	4:3 PAN SCAN
BLACK LEVEL (COMPONENT OUT):	OFF
PAUSE MODE:	AUTO

Options

- 7** Press \uparrow/\downarrow to select a setting, then press \oplus .

The setting is selected and setup is complete.

Example: [4:3 LETTER BOX]

VIDEO SETUP	
TV TYPE:	4:3 LETTER BOX
PROGRESSIVE (COMPONENT OUT):	OFF
4:3 OUTPUT:	FULL
BLACK LEVEL:	ON
BLACK LEVEL (COMPONENT OUT):	OFF
PAUSE MODE:	AUTO

Selected setting

To reset all of the [SETUP] settings

To reset all of the [SETUP] settings, see [RESET] (page 59).

Setting the display or sound track language

[LANGUAGE SETUP]

Set various languages for the on-screen display or sound track.

■ [OSD] (On-Screen Display)

You can switch the display language on the TV screen.

■ [MENU]

You can switch the language for the disc's menu.

[AUDIO] DVD-V

You can switch the language of the sound track. When you select [ORIGINAL], the language given priority on the disc is selected.

[SUBTITLE] DVD-V

You can switch the language of the subtitles recorded on the DVD VIDEO. When you select [AUDIO FOLLOW], the language for the subtitles changes according to the language you selected for the sound track.

Note

• When you select a language in [MENU], [AUDIO], or [SUBTITLE] that is not recorded on the DVD VIDEO, one of the recorded languages will be automatically selected (depending on the disc, the language may not be selected automatically).

Tip

• If you select [OTHERS →] in [MENU], [AUDIO], and [SUBTITLE], select and enter a language code from “Language Code List” (page 74) using the number buttons.

Settings for the display

[VIDEO SETUP]

Select settings according to your TV.

[TV TYPE]

You can select the aspect ratio of the connected TV.

[16:9]: Select this when you connect a wide-screen TV or a TV with a wide-screen mode.



[4:3 LETTER BOX]: Select this when you connect a 4:3 standard TV. The system displays a wide picture with bands on the upper and lower portions of the TV screen.



[4:3 PAN SCAN]: Select this when you connect a 4:3 standard TV. The system automatically displays a wide picture on the entire screen and cuts off the portions that do not fit.

**[PROGRESSIVE (COMPONENT OUT)]**

You can set the progressive signal that is output from the COMPONENT VIDEO OUT jacks to on/off. For details, see “To select the type of video signal output from the COMPONENT VIDEO OUT jacks” (page 29).

[OFF]: The system outputs interlace signals.

[ON]: The system outputs progressive signals. When you select [ON], follow the Steps below.

- 1** Select [ON], then press **+**.
- 2** Press **←/→** to select [START], then press **+**.
The system outputs a progressive signal for about 5 seconds. Check that the screen is displayed correctly.
- 3** Press **←/→** to select [YES], then press **+**.
The system outputs a progressive signal. If you select [NO], the system will not output a progressive signal.

Note

• [PROGRESSIVE (COMPONENT OUT)] is effective only when you connect the unit and TV with a component video cable (page 22).

[4:3 OUTPUT]

When you use a 16:9 aspect ratio TV, you can adjust the aspect ratio to watch 4:3 aspect ratio signals. If you can change the aspect ratio on your TV, change the setting on your TV, not the system.

[FULL]: Select this when you can change the aspect ratio on your TV.

[NORMAL]: Select this when you cannot change the aspect ratio on your TV. A 16:9 aspect ratio signal with black bands on left and right sides of the image appears.

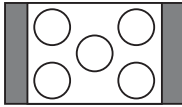

16:9 aspect ratio TV

Note

- [4:3 OUTPUT] is effective only when you set [TV TYPE] in [VIDEO SETUP] to [16:9].

■ **[BLACK LEVEL]**

You can select the black level (setup level) for the video signals output from the jacks other than COMPONENT VIDEO OUT/HDMI OUT.

[ON]: The standard level.

[OFF]: You can lower the standard black level. Use this when the picture becomes too white.

■ **[BLACK LEVEL (COMPONENT OUT)]**

You can select the black level (setup level) for the video signals output from the COMPONENT VIDEO OUT jacks.

You cannot select this and the setting is not effective when the system outputs a progressive signal.

[OFF]: You can set the black level of the output signal to the standard level.

[ON]: You can raise the standard black level. Use this when the picture becomes too black.

■ **[PAUSE MODE] DVD-V**

(DVD VIDEO/DVD-R/DVD-RW only)

You can select the picture in pause mode.

[AUTO]: The picture, including subjects that move dynamically, is output with no jitter. This setting is for normal usage.

[FRAME]: The picture, including subjects that do not move dynamically, is output in high resolution.

Settings for HDMI

[HDMI SETUP]

■ **[HDMI RESOLUTION]**

You can select the type of video signal that is output from the HDMI OUT jack.

[AUTO (1920 × 1080p)]: The system outputs the optimal video signal for the connected TV.

[1920 × 1080i]: The system outputs 1920 × 1080i* video signals.

[1280 × 720p]: The system outputs 1280 × 720p* video signals.

[720 × 480p]**: The system outputs 720 × 480p* video signals.

* i: interlace, p: progressive

** Depending on the area, [720 × 480/576p] may appear.

■ **[CONTROL FOR HDMI]**

This function is available when you connect the system and TV that is compatible with the Control for HDMI function with an HDMI cable.

[ON]: On. You can operate mutually between components that are connected with an HDMI cable.

[OFF]: Off.

■ **[VOLUME LIMIT]**

When the System Audio Control (page 48) is activated, loud sound may be output depending on the volume level of the system. You can prevent this by limiting the maximum level of the volume when the System Audio Control function activates.

[OFF]: Off.

[LEVEL3]: Maximum volume level is set to 10.

[LEVEL2]: Maximum volume level is set to 15.

[LEVEL1]: Maximum volume level is set to 20.

Note

- This function is available only when [CONTROL FOR HDMI] is set to [ON].

■ [YCbCr/RGB (HDMI)]

You can select the type of HDMI signal output from the HDMI OUT jack.

[YCbCr]: The system outputs YCbCr signals.

[RGB]: The system outputs RGB signals.

■ [AUDIO (HDMI)]

You can select the audio output status from the HDMI OUT jack.

[OFF]: The system does not output sound from the HDMI OUT jack.

[ON]: The system outputs audio signals by converting Dolby Digital, DTS, or 96 kHz/24-bit PCM signals to 48 kHz/16-bit PCM.

Note

- When you set the function to other than “DVD/CD” or “USB,” the system does not output the sound from the HDMI OUT jack even if you set [AUDIO (HDMI)] to [ON].

■ [JPEG RESOLUTION]

You can select the resolution of JPEG image files output from the HDMI OUT jack.

[SD]: The system outputs standard resolution with a black frame.

[HD]: The system outputs HD resolution with a black frame.

[HD]: The system outputs the HD resolution without a black frame.

[(1920 × 1080i) HD]: The system outputs full size HD resolution with a black frame.

[(1920 × 1080i) HD]: The system outputs full size HD resolution without a black frame.

Note

- [JPEG RESOLUTION] is effective only when you set [TV TYPE] in [VIDEO SETUP] to [16:9], and you set [HDMI RESOLUTION] in [HDMI SETUP] to other than [720 × 480p] or [720 × 480/576p].
- You can select [(1920 × 1080i) HD] or [(1920 × 1080i) HD] only when you set [HDMI RESOLUTION] in [HDMI SETUP] to [1920 × 1080i].
- The HDMI signal will stop momentarily when:
 - the system is loading or unloading a DATA CD or DATA DVD.
 - you connect or remove a USB device.

Settings for the audio**[AUDIO SETUP]****■ [SPEAKER FORMATION]**

Depending on the shape of the room, you may not be able to install some speakers. For better surround sound, Sony recommends that first you decide the position of the speakers.

1 Press ←/→ to select a setting, then press .

- [STANDARD]: Select this when you install all the speakers normally.
- [NO CENTER]: Select this when you install the front and surround speakers only.
- [NO SURROUND]: Select this when you install the center and front speakers only.
- [FRONT ONLY]: Select this when you install the front speakers only.
- [ALL FRONT]: Select this when you install all the speakers in front of the listening position.
- [ALL FRONT - NO CENTER]: Select this when you install the front and surround speakers in front of the listening position.

2 Press ←/→ to select [YES] or [NO], then press .

- [YES]: Continue with [AUTO CALIBRATION]. Follow the Steps of [AUTO CALIBRATION] below.
- [NO]: Exit [SPEAKER FORMATION].

■ [AUTO CALIBRATION]

D. C. A. C. (Digital Cinema Auto Calibration) can set the appropriate surround sound automatically.

1 Connect the calibration mic (supplied) to the A.CAL MIC jack on the front panel.

Set up the calibration mic at ear level using a tripod, etc. (not supplied).

The front of each speaker should face the calibration mic, and there should be no

obstruction between the speakers and the calibration mic.

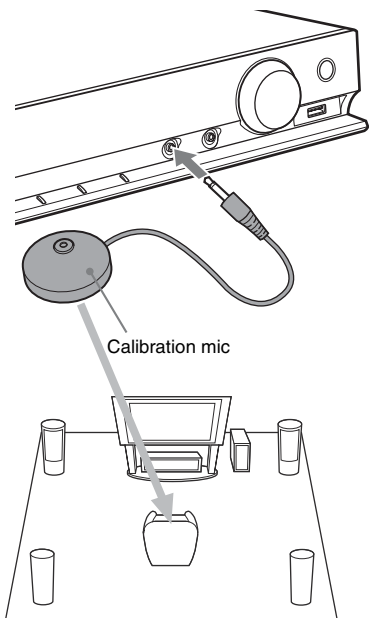

2 Press \leftarrow/\rightarrow to select [YES], then press \oplus .

[AUTO CALIBRATION] starts.
Be quiet during the measurement.

Note

- The environment of the room in which the system is installed may affect measurements. When the measurements differ considerably from the status of the speaker installation, perform the speaker settings manually by following "Settings for the speakers" (page 60).

3 Press \leftarrow/\rightarrow to select [YES] or [NO], then press \oplus .

4 Disconnect the calibration mic when the measurement completes correctly.

Note

- The system outputs a loud test sound when [AUTO CALIBRATION] starts. You cannot turn the volume down. Give consideration to children and neighbors.
- The measurement for [SUBWOOFER] is always [YES] and [SPEAKER SETUP] returns to the default setting when you perform [AUTO CALIBRATION].

[AUDIO DRC] DVD-V

You can compress the dynamic range of the sound track. [AUDIO DRC] is useful for watching movies at low volume late at night.

[OFF]: No compression of dynamic range.

[STANDARD]: The system reproduces the sound track with the kind of dynamic range that the recording engineer intended.

[MAX]: The system compresses dynamic range fully.

Note

- [AUDIO DRC] works only for Dolby Digital.

[TRACK SELECTION] DVD-V

You can give the sound track which contains the highest number of channels priority when multiple audio formats (PCM, DTS, Dolby Digital, or MPEG audio) are recorded.

[OFF]: Off.

[AUTO]: The system selects the sound track automatically according to the priority.

Note

- When you set the item to [AUTO], the language may change. The [TRACK SELECTION] setting has higher priority than the [AUDIO] settings in [LANGUAGE SETUP] (page 54). (Depending on the disc, this function may not work.)

Other Settings

[SYSTEM SETUP]

[SCREEN SAVER]

You can reduce the damage to the display device (ghosting). Press any button (e.g., \blacktriangleright) to cancel the screen saver.

[ON]: The screen saver image appears if you do not operate the system for about 15 minutes.

[OFF]: Off.

[BACKGROUND]

You can select the background color or picture on the TV screen.

[JACKET PICTURE]: The jacket picture (still picture) appears, but only when the jacket picture is already recorded on the disc (CD-EXTRA, etc.). If the disc does not contain a jacket picture, a preset picture stored in the system appears.

[GRAPHICS]: A preset picture stored in the system appears.

[BLUE]: The background is blue.

[BLACK]: The background is black.

■ [PARENTAL CONTROL]

The [PARENTAL CONTROL] function allows you to restrict playback of DVDs that have ratings. Scenes may be blocked or replaced with different scenes.

1 Enter or re-enter your 4-digit password using the number buttons, then press \oplus .

2 Press \uparrow/\downarrow to select [STANDARD], then press \oplus .

3 Press \uparrow/\downarrow to select a geographic area as the playback limitation level, then press \oplus .

When you select [OTHERS \rightarrow], select and enter a standard code from “Parental Control Area Code List” (page 74) using the number buttons.

4 Press \uparrow/\downarrow to select [LEVEL], then press \oplus .

5 Press \uparrow/\downarrow to select the desired level, then press \oplus .

The lower the value, the stricter the limitation.

To turn off the [PARENTAL CONTROL] function

Set [LEVEL] to [OFF] in Step 5.

To play a disc for which [PARENTAL CONTROL] is set

When you load the disc and press \blacktriangleright , the display for entering your password appears. Enter your 4-digit password using the number buttons, then press \oplus .

Tip

• If you forget your password, enter “199703” using the number buttons, then press \oplus . The display will ask you to enter a new 4-digit password. After you

enter a new 4-digit password, replace the disc in the unit and press \blacktriangleright . When the display for entering your password appears, enter your new password.

Changing the password

1 Enter your 4-digit password using the number buttons, then press \oplus .

2 Press \uparrow/\downarrow to select [CHANGE PASSWORD \rightarrow], then press \oplus .

3 Enter a new 4-digit password using the number buttons, then press \oplus .

If you make a mistake entering your password, press \leftarrow before you press \oplus , then input the correct number.

4 To confirm your password, re-enter it using the number buttons, then press \oplus .

■ [MULTI-DISC RESUME] **DVD-V** **VIDEO CD**

This system recalls the point where you stopped the disc the last time it was played and resumes playback from that point the next time you insert the same disc.

[ON]: The system stores the resume points in memory for up to 10 discs.

[OFF]: The system does not store the resume points in memory. Playback restarts at the resume point only for the current disc in the unit.

Note

• When the resume playback memory is full, the resume playback point for the earliest disc is deleted.

■ [RESET]

You can return the [SETUP] settings other than [PARENTAL CONTROL] to the default settings.

Press \leftarrow/\rightarrow to select [YES], then press \oplus .

You can also quit the process and return to the Control Menu by selecting [NO] here. Do not press \mathbf{I}/\mathbf{O} while resetting the system as it takes a few seconds to complete.

Note

• The [MEDIA], [INTERVAL], [EFFECT], and [MULTI/2CH] settings also return to the default settings.

Settings for the speakers

[SPEAKER SETUP]

You can adjust the speaker settings manually without performing the Quick Setup.

Select the speakers you will use, set the speaker distance from your listening position, and then adjust the sound level for each speaker. You can adjust the sound level by using the [TEST TONE] function.

■ [CONNECTION]

[FRONT]

[YES]

[CENTER]

[YES]: Normally select this.

[NONE]: Select this if no center speaker is used.

[SURROUND]

[YES]: Normally select this.

[NONE]: Select this if no surround speakers are used.

[SUBWOOFER]

[YES]

Note

• When you change the [CONNECTION] setting, the [STANDARD] of [SPEAKER FORMATION] setting remains the same, but the other settings of [SPEAKER FORMATION] return to [STANDARD].

■ [DISTANCE (FRONT)]

Set the distance of the front and center speakers from the listening position.

For the best possible surround sound, place all speakers at the same distance from the listening position. The distance can be between 1.0 to 7.0 meters¹⁾ (3 to 23 ft) for the front speakers, and 0.0 to 7.0 meters²⁾ (0 to 23 ft) for the center speaker.

If you cannot place the center speaker at the same distance, you can move the center speaker up to 1.6 meters closer to the listening position.

[L/R] 3.0 m/10 ft: Set the front speaker distance.

[CENTER] 3.0 m/10 ft: Set the center speaker distance.

¹⁾0.9 to 6.9 meters for North American models.

²⁾0.0 to 6.9 meters for North American models.

■ [DISTANCE (SURROUND)]

Set the distance for the surround speakers from the listening position.

For the best possible surround sound, place all speakers at the same distance from the listening position. The distance can be between 1.0 to 7.0 meters* (0 to 23 ft).

If you cannot place surround speakers at the same distance, you can move the surround speakers up to 5.0 meters (16 ft) closer to the listening position.

[L/R] 3.0 m/10 ft: Set the surround speaker distance.

* 0.0 to 6.9 meters for North American models.

Note

• Depending on the input stream, the [DISTANCE] setting may not be effective.

■ [LEVEL (FRONT)]

You can adjust the sound level of the front speakers, center speaker, and subwoofer. You can set the parameters from -6.0 dB to 0 dB for [L/R], and from -6.0 dB to +6.0 dB for [CENTER] and [SUBWOOFER]. Be sure to set [TEST TONE] to [ON] for easy adjustment.

[L/R] 0.0 dB: Set the front speaker level.

[CENTER] 0.0 dB: Set the center speaker level.

[SUBWOOFER] +2.0 dB: Set the subwoofer level.

■ [LEVEL (SURROUND)]

You can adjust the sound level of the surround speakers. You can set the parameter from -6.0 dB to +6.0 dB. Set [TEST TONE] to [ON] for easy adjustment.

[L/R] 0.0 dB: Set the surround speaker level.

■ [TEST TONE]

You can adjust the sound level of the speakers by using the [TEST TONE] function.

[OFF]: The test tone is not emitted from the speakers.

[ON]: The test tone is emitted from each speaker in sequence while adjusting the level.

Adjust the sound level as follows.

- 1** Set the [TEST TONE] to [ON].
- 2** Press ←/↑/↓/→ repeatedly to select the desired speaker and the level, then press ⊕.
- 3** Repeat Step 2.
- 4** Press ←/↑/↓/→ to set [TEST TONE] to [OFF] after adjusting the speaker level.

Precautions

On power sources

- Unplug the unit from the wall outlet (mains) if you do not intend to use it for an extended period of time. To disconnect the cord, pull it out by the plug, never by the cord.

On placement

- Place the system in a location with adequate ventilation to prevent heat build-up in the system.
- At high volume, over long periods of time, the cabinet becomes hot to the touch. This is not a malfunction. However, touching the cabinet should be avoided. Do not place the system in a confined space where ventilation is poor as this may cause overheating.
- Do not block the ventilation slots by putting anything on the system. The system is equipped with a high power amplifier. If the ventilation slots are blocked, the system can overheat and malfunction.
- Do not place the system on surfaces (rugs, blankets, etc.) or near materials (curtains, draperies) that may block the ventilation slots.
- Do not install the system near heat sources such as radiators, or air ducts, or in a place subject to direct sunlight, excessive dust, mechanical vibration, or shock.
- Do not install the system in an inclined position. It is designed to be operated in a horizontal position only.
- Keep the system and discs away from components with strong magnets, such as microwave ovens, or large loudspeakers.
- Do not place heavy objects on the system.

On operation

- If the system is brought directly from a cold to a warm location, or is placed in a very damp room, moisture may condense on the lenses inside the unit. Should this occur, the system may not operate properly. In this case, remove the disc and leave the system turned on for about half an hour until the moisture evaporates.
- If anything falls into the cabinet, unplug the unit and have it checked by qualified personnel before operating it any further.

On adjusting volume

- Do not turn up the volume while listening to a section with very low level inputs or no audio signals. If you do, the speakers may be damaged when a peak level section is suddenly played.

On cleaning

- Clean the cabinet, panel, and controls with a soft cloth slightly moistened with a mild detergent solution. Do not use any type of abrasive pad, scouring powder or solvent such as alcohol or benzine.
If you have any questions or problems concerning your system, please consult your nearest Sony dealer.

On cleaning discs, disc/lens cleaners

- **Do not use cleaning discs or disc/lens cleaners (including wet or spray types). These may cause the apparatus to malfunction.**

On your TV's color

- If the speakers should cause your TV screen to have color irregularity, turn off the TV then turn it on after 15 to 30 minutes. If color irregularity should persist, place the speakers further away from your TV set.

IMPORTANT NOTICE

Caution: This system is capable of holding a still video image or on-screen display image on your television screen indefinitely. If you leave the still video image or on-screen display image displayed on your TV for an extended period of time you risk permanent damage to your television screen. Projection televisions are especially susceptible to this.

On moving the system

- Before moving the system, make sure that there is no disc inserted, and remove the AC power cord (mains lead) from the wall outlet (mains).

Notes about the Discs

On handling discs

- To keep the disc clean, handle the disc by its edge. Do not touch the surface.
- Do not stick paper or tape on the disc.



- Do not expose the disc to direct sunlight or heat sources such as hot air ducts, or leave it in a car parked in direct sunlight as the temperature may rise considerably inside the car.
- After playing, store the disc in its case.

On cleaning

- Before playing, clean the disc with a cleaning cloth.
Wipe the disc from the center out.



- Do not use solvents such as benzine, thinner, commercially available cleaners, or anti-static spray intended for vinyl LPs.

This system can only play a standard circular disc. Using neither standard nor circular discs (e.g., card, heart, or star shape) may cause a malfunction.

Do not use a disc that has a commercially available accessory attached, such as a label or ring.

Troubleshooting

If you experience any of the following difficulties while using the system, use this troubleshooting guide to help remedy the problem before requesting repairs. Should any problem persist, consult your nearest Sony dealer.

Note that if service personnel changes some parts during repair, these parts may be retained.

General

Symptom	Problems and solutions
The power is not turned on.	<ul style="list-style-type: none">• Check that the AC power cord (mains lead) is connected securely.
The remote does not function.	<ul style="list-style-type: none">• The distance between the remote and the unit is too far.• The batteries in the remote are weak.
The system does not work normally.	<ul style="list-style-type: none">• Disconnect the AC power cord (mains lead) from the wall outlet (mains), then reconnect after several minutes.• Perform the following procedure. (Note that the system parameters, such as preset stations, return to the default settings.)<ol style="list-style-type: none">① Press I/⏻ to turn on the system.② Press ▶, FUNCTION, and I/⏻ on the unit at the same time. "COLD RESET" appears in the front panel display.
After performing [AUTO CALIBRATION], [NONE] appears in the [Measurement Complete.] display.	<ul style="list-style-type: none">• Check the speaker connection (page 21).• Do not install the speaker in another room.

Picture

Symptom	Problems and solutions
There is no picture.	<ul style="list-style-type: none">• The video input on your TV is not set so that you can view pictures from the system.• Check the output method on your system.
There is no picture when you make an HDMI cable connection.	<ul style="list-style-type: none">• The unit is connected to an input device that is not HDCP (High-bandwidth Digital Content Protection) compliant ("HDMI" on the front panel does not light up).• If the HDMI OUT jack is used for video output, change the type of video signal output from the HDMI OUT jack (page 56). Connect your TV and the unit using a video jack other than HDMI OUT, and switch your TV's input to the connected video input so that you can see the on-screen displays. Change the type of video signal output from the HDMI OUT jack, and switch your TV's input back to HDMI. If the picture still does not appear, repeat the Steps and try other options.
There is no picture when you make a component video cable connection.	<ul style="list-style-type: none">• You have set progressive format but your TV cannot accept the signal in progressive format. In this case, return the setting to interlace format (the default setting) (pages 28, 55).• You have set [PROGRESSIVE (COMPONENT OUT)] in [VIDEO SETUP] to [ON] (page 55) even though your TV cannot accept the progressive signal. In this case, disconnect the HDMI cable from the unit and then set to [OFF].• Even if your TV is compatible with progressive format (525p/625p) signals, the image may be affected when you set progressive format. In this case, return the setting to interlace format (the default setting) (pages 28, 55).

Symptom	Problems and solutions
Picture noise appears.	<ul style="list-style-type: none"> • If the picture output from your system goes through your VCR to get to your TV, the copy-protection signal applied to some DVD programs could affect picture quality. Connect the unit directly to your TV.
An image is not displayed on the entire TV screen.	<ul style="list-style-type: none"> • Check the setting of [TV TYPE] in [VIDEO SETUP] (page 55). • The aspect ratio on the disc is fixed.
Color irregularity occurs on the TV screen.	<p>The system's speakers contain magnet parts, so magnetic distortion may occur. When color irregularity occurs on the TV screen, check the following items.</p> <ul style="list-style-type: none"> • Install the speakers at least 0.3 meters (1.0 ft) from your TV set. • If the color irregularity persists, turn off your TV set once, then turn it on after 15 to 30 minutes. • Make sure that no magnetic object (magnetic latch on a TV stand, health care device, toy, etc.) is placed near the speakers. • Reposition the speakers farther away from your TV set.
Playback picture becomes distorted.	<ul style="list-style-type: none"> • Set [YCbCr] in [YCbCr/RGB (HDMI)] to [RGB] (page 57).

Sound

Symptom	Problems and solutions
There is no sound.	<ul style="list-style-type: none"> • The speaker cord is not connected securely. • Check the speaker settings (page 60).
There is no sound when the component (digital satellite receiver, PlayStation 3, etc.) is connected directly to your TV via HDMI.	<ul style="list-style-type: none"> • Check the following status. <ul style="list-style-type: none"> – Connect an audio cable from the AUDIO OUT (audio out) jack of your TV to the system (page 22) and select the "TV/CABLE" function. – Disable your TV's speakers.
There is no sound from the DIGITAL IN OPTICAL/ COAXIAL jack.	<ul style="list-style-type: none"> • The sampling frequency of the input stream is more than 48 kHz.
Severe hum or noise is heard.	<ul style="list-style-type: none"> • Move your TV away from the audio components. • Clean the disc.
The sound loses stereo effect when you play a VIDEO CD, a CD, or an audio file.	<ul style="list-style-type: none"> • Select stereo sound by pressing AUDIO (page 34).
There is no sound or the volume level is very low from a certain speaker or all the speakers.	<ul style="list-style-type: none"> • Check the surround setting (page 44). • Check the speaker connections and settings (pages 21, 60). • Depending on the DVD, the output signal may not be the entire 5.1 channel. • A 2 channel source is being played.
The sound comes from the center speaker only.	<ul style="list-style-type: none"> • Depending on the disc, the sound may come from the center speaker only.
There is no system sound from your TV.	<ul style="list-style-type: none"> • Set [AUDIO (HDMI)] in [HDMI SETUP] to [ON] (page 57). • The HDMI OUT jack does not output Super Audio CD sound. • Perform the following procedure. <ol style="list-style-type: none"> ① Turn the system off and on again. ② Turn the connected component off and on again. ③ Disconnect and then connect the HDMI cable again.
The sound of files played from a DATA CD/DATA DVD/USB device is distorted.	<ul style="list-style-type: none"> • The bit rate used when encoding the audio files was low. Transfer audio files encoded with higher bit rates onto the DATA CD/DATA DVD/USB device.

Symptom	Problems and solutions
There is noise or the sound skips while playing a USB device.	<ul style="list-style-type: none"> • Copy the files to your computer, format the USB device in FAT12, FAT16, or FAT32 format, and transfer the files to the USB device again.

Disc playback

Symptom	Problems and solutions
A disc does not play.	<ul style="list-style-type: none"> • The region code on the DVD does not match the system. • Moisture has condensed inside the unit and may cause damage to the lenses. Remove the disc and leave the unit turned on for about half an hour.
The language for the sound track or subtitle cannot be changed.	<ul style="list-style-type: none"> • Set the language via the disc's menu.
A disc does not start playing from the beginning.	<ul style="list-style-type: none"> • While in stop mode, press ■ on the unit or the remote and then start playback (page 32).
A DATA CD/DATA DVD cannot be played.	<ul style="list-style-type: none"> • The DATA CD is not recorded in ISO 9660 Level 1/Level 2, or Joliet. • The DATA DVD is not recorded in UDF (Universal Disk Format).
A file cannot be played.	<ul style="list-style-type: none"> • The extension of the file name or file format is not correct. See "Playable Discs/Files on a USB Device" (page 6). • Check the [MEDIA] setting (page 32). • The system can play to a depth of 8 folders only. • Check that the number of folders is 200 or less. • Check that the number of audio files/JPEG image files in the folder is 150 or less.
A JPEG image file cannot be viewed.	<ul style="list-style-type: none"> • The JPEG image file is larger than 3,072 (width) × 2,048 (height) pixels in normal format, or more than 2,000,000 pixels in progressive format which is mainly used on Internet Web sites.
A video file cannot be played.	<ul style="list-style-type: none"> • The video file is larger than 720 (width) × 576 (height).
The titles of folders/files/file names are not displayed correctly.	<ul style="list-style-type: none"> • The system can only display numbers and letters of the alphabet. Other characters are displayed as [_].
File names are not displayed properly.	<ul style="list-style-type: none"> • The character codes that can be displayed by this system are numbers and letters of the alphabet only. Other characters are not displayed correctly.

USB playback

Symptom	Problems and solutions
A USB device does not start playing from the beginning.	<ul style="list-style-type: none"> • While in stop mode, press ■ on the unit or the remote and then start playback (page 32).
A USB device cannot be played.	<ul style="list-style-type: none"> • USB devices formatted with file systems other than FAT12, FAT16, or FAT32 are unsupported.* * This system supports FAT12, FAT16, and FAT32, but some USB devices may not support all of these. For details, refer to the operating instructions of the USB device or contact the manufacturer. • If you use a partitioned USB device, only audio files on the first partition can be played.

Symptom	Problems and solutions
A file cannot be played.	<ul style="list-style-type: none"> • The extension of the file name or file format is not correct. See “Playable Discs/ Files on a USB Device” (page 6). • Check the [MEDIA] setting (page 32). • The system can play to a depth of 8 folders only. • Check that the number of folders is 200 or less. • Check that the number of audio files/JPEG image files in the folder is 150 or less. • Files that are encrypted or protected by passwords, etc. cannot be played.
A JPEG image file cannot be viewed.	<ul style="list-style-type: none"> • The JPEG image file is larger than 3,072 (width) × 2,048 (height) pixels in normal format, or more than 2,000,000 pixels in progressive format which is mainly used on Internet Web sites.
A video file cannot be played.	<ul style="list-style-type: none"> • The video file is larger than 720 (width) × 576 (height).
A WMA file cannot be played.	<ul style="list-style-type: none"> • A WMA file that is in WMA DRM, WMA Lossless, or WMA PRO format cannot be played.
An AAC file cannot be played.	<ul style="list-style-type: none"> • An AAC file that is in AAC DRM or AAC Lossless format cannot be played.
The titles of folders/files/file names are not displayed correctly.	<ul style="list-style-type: none"> • The system can only display numbers and letters of the alphabet. Other characters are displayed as [_].
File names are not displayed properly.	<ul style="list-style-type: none"> • The character codes that can be displayed by this system are numbers and letters of the alphabet only. Other characters are not displayed correctly.
It takes time until playback starts.	<ul style="list-style-type: none"> • After the system reads all files on the USB device, playback may take more time than usual if: <ul style="list-style-type: none"> – there are many folders or files on the USB device. – the folder or file organization structure is very complex. – the memory capacity is very large. – the file size is extremely large. – the internal memory is fragmented. • The system is playing an audio file in AAC format.
A USB device which has been used on another device does not work.	<ul style="list-style-type: none"> • It may be recorded in an unsupported format. If so, first take the precaution of backing up important files on the USB device by copying them to your computer hard disk. Next, format the USB device in FAT12, FAT16, or FAT32 format, and transfer the files to the USB device again.

Audio track/file transfer

Symptom	Problems and solutions
You cannot start transferring onto a USB device.	<ul style="list-style-type: none"> • The following problems may have occurred. <ul style="list-style-type: none"> – The USB device is full. – The number of audio files and folders on the USB device has reached the upper limit. – The USB device is write-protected.
Transferring stops before it is finished.	<ul style="list-style-type: none"> • The communication speed of the USB device is extremely slow. Connect a USB device that this system can play. • If the transferring and erasing operations are repeated multiple times, the file structure within the USB device becomes complex. Follow the procedure in the operating instructions of the USB device to format the USB device. If the problem persists, contact your nearest Sony dealer. • The USB device is full. • The number of audio files and folders on the USB device has reached the upper limit.

Symptom	Problems and solutions
Transferring to a USB device results in an error.	<ul style="list-style-type: none"> • The USB device was disconnected or the power was turned off during erasing. Delete the partially-erased file. If this does not fix the problem, the USB device may be broken. Follow the procedure in the operating instructions of the USB device to format the USB device. If the problem persists, contact your nearest Sony dealer. • Check if the USB device is write-protected.
Audio files or folders on the USB device cannot be erased.	



Tuner

Symptom	Problems and solutions
Radio stations cannot be tuned in.	<ul style="list-style-type: none"> • Check that the antenna (aerial) is connected securely. Adjust the antenna (aerial) or connect an external antenna (aerial) if necessary. • The signal strength of the stations is too weak (when tuning in with automatic tuning). Use direct tuning.
FM reception is poor.	<ul style="list-style-type: none"> • Use a 75-ohm coaxial cable (not supplied) to connect the unit to an outdoor FM antenna (aerial).

Control for HDMI

Symptom	Problems and solutions
The Control for HDMI function does not work.	<ul style="list-style-type: none"> • Set [CONTROL FOR HDMI] in [HDMI SETUP] to [ON] (page 56). • Make sure that the connected component is compatible with the [CONTROL FOR HDMI] function. • Check the connected component's setting for the Control for HDMI function. Refer to the operating instructions of the component. • If you change the HDMI connection, connect and disconnect the AC power cord (mains lead), or have a power failure, set [CONTROL FOR HDMI] in [HDMI SETUP] to [OFF], then set to [ON] (page 56). • For details, see "Using the Control for HDMI Function for "BRAVIA" Sync" (page 47).
No sound is output from the system and TV while using the System Audio Control function.	<ul style="list-style-type: none"> • Make sure that the connected TV is compatible with the System Audio Control function. • For details, see "Using the Control for HDMI Function for "BRAVIA" Sync" (page 47).

Messages

Symptom	Problems and solutions
"PROTECTOR" and "PUSH POWER" appear alternately.	<ul style="list-style-type: none"> • Press  to turn off the system, and check the following items after "STANDBY" disappears. <ul style="list-style-type: none"> – Are the + and – speaker cords short-circuited? – Is anything blocking the ventilation holes of the system? – After checking the above items and fixing any problems, turn on the system. If the cause of the problem cannot be found even after checking all the above items, consult your nearest Sony dealer.
"OVERLOAD," "REMOVE USB," then "PUSH POWER" appear.	<ul style="list-style-type: none"> • A problem has been detected with the level of electrical current from the  (USB) port. Turn off the system and remove the USB device from the  (USB) port. Make sure there is no problem with the USB device. If this display pattern persists, contact your nearest Sony dealer.

Symptom	Problems and solutions
"LOCKED" appears and a disc cannot be ejected.	<ul style="list-style-type: none"> • Contact your Sony dealer or local authorized Sony service facility.
"DATA ERROR" appears.	<ul style="list-style-type: none"> • The file you want to play is broken. • The file format does not match the extension of the file name. See "Playable Discs/Files on a USB Device" (page 6). • The JPEG image file format does not conform to DCF.
"READING" is displayed for a long time while playing.	<ul style="list-style-type: none"> • The reading process can take a long time if: <ul style="list-style-type: none"> – there are many folders or files on the USB device. – the folder or file organization structure is very complex. – the memory capacity is very large. – the internal memory is fragmented.

Self-diagnosis Function

(When letters/numbers appear in the display)

When the self-diagnosis function is activated to prevent the system from malfunctioning, a 5-character service number (e.g., C 13 50) with a combination of a letter and 4 digits appears on the TV screen or front panel display. In this case, check the following table.

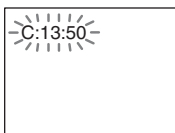

First 3 characters of the service number	Cause and/or corrective action
C 13	The disc is dirty. ➔Clean the disc with a soft cloth (page 63).
E XX (XX is a number)	To prevent a malfunction, the system has performed the self-diagnosis function. ➔Contact your nearest Sony dealer or local authorized Sony service facility and give the 5-character service number. Example: E 61 10

When the version number appears on the TV screen

When you turn on the system, the version number [VER.X.XX] (X is a number) may appear on the TV screen. Although this is not a malfunction and for Sony service use only, normal system operation will not be possible. Turn off the system, and then turn on the system again to operate.



Specifications

AUDIO POWER SPECIFICATIONS for the U.S. model

POWER OUTPUT AND TOTAL HARMONIC DISTORTION:

(FTC)

Front L + Front R

With 3 ohms loads, both channels driven, from 180 - 20,000 Hz; rated 84 watts per channel minimum RMS power, with no more than 1% total harmonic distortion from 250 milli watts to rated output.

Amplifier Section

U.S. models:

POWER OUTPUT (reference):

Front L/Front R/Center/
Surround L/Surround R:
167 watts (per channel at 3 ohms, 1 kHz)
Subwoofer: 165 watts (at 3 ohms, 80 Hz)

Other models:

POWER OUTPUT (rated):

Front L + Front R 108 W + 108 W (at 3 ohms, 1 kHz, 1% THD)

POWER OUTPUT (reference):

Front L/Front R/Center/
Surround L/Surround R:
167 watts (per channel at 3 ohms, 1 kHz)
Subwoofer: 165 watts (at 3 ohms, 80 Hz)

Inputs (Analog)

TV/CABLE (AUDIO IN) Sensitivity: 450/250 mV
AUDIO IN Sensitivity: 250/125 mV

Inputs (Digital)

TV/CABLE (COAXIAL IN/OPTICAL IN)
Impedance: 75 ohms/-
Input Stream: Dolby
Digital 5.1ch/DTS 5.1ch/
Linear PCM 2ch
(Sampling Frequency: less than 48 kHz)

Super Audio CD/DVD System

Laser Diode Properties

Emission Duration:
Continuous
Laser Output: Less than
44.6 μW

* This output is the value measurement at a distance of 200 mm from the objective lens surface on the Optical Pick-up Block with 7 mm aperture.

Signal format system NTSC

USB Section

↔ (USB) port:

Maximum current: 500 mA

Tuner Section

System PLL quartz-locked digital synthesizer

Tuning range

North American models: 87.5 MHz - 108.0 MHz
(100 kHz step)

Other models: 87.5 MHz - 108.0 MHz (50 kHz step)

Antenna (aerial) FM wire antenna (aerial)

Antenna (aerial) terminals 75 ohms, unbalanced

Intermediate frequency 10.7 MHz

Video Section

Outputs

VIDEO: 1 V_{p-p} 75 ohms

COMPONENT:

Y: 1 V_{p-p} 75 ohms

P_B/C_B, P_R/C_R: 0.7 V_{p-p}

75 ohms

HDMI OUT: Type A (19 pin)

Speakers

Front (SS-TS102)

Speaker system

Speaker unit

Rated impedance

Dimensions (approx.)

Full range Bass reflex

65 mm (2 5/8 in) cone type

3 ohms

103 mm × 164 mm × 85 mm (4 1/8 in × 6 1/2 in × 3 3/8 in) (w/h/d)

Mass (approx.)

0.5 kg (1 lb 2 oz)

Center (SS-CT101)

Speaker system

Speaker unit

Rated impedance

Dimensions (approx.)

Full range Bass reflex,
Magnetically Shielded

65 mm (2 5/8 in) cone type

3 ohms

265 mm × 94 mm × 70 mm (10 1/2 in × 3 3/4 in × 2 7/8 in) (w/h/d)

Mass (approx.)

0.6 kg (1 lb 6 oz)

Surround (SS-TS102)

Speaker system

Speaker unit

Rated impedance

Dimensions (approx.)

Full range Bass reflex

65 mm (2 5/8 in) cone type

3 ohms

103 mm × 164 mm × 85 mm (4 1/8 in × 6 1/2 in × 3 3/8 in) (w/h/d)

Mass (approx.)

0.5 kg (1 lb 2 oz)

Subwoofer

DAV-DZ170/DAV-DZ171 (SS-WS102)

Speaker system

Speaker unit

Rated impedance

Dimensions (approx.)

Subwoofer Bass reflex

180 mm (7 1/8 in) cone type

3 ohms

225 mm × 395 mm × 315 mm (8 7/8 in × 15 5/8 in × 12 1/2 in) (w/h/d)

Mass (approx.)

6.5 kg (14 lb 6 oz)

DAV-DZ175 (SS-WS101)

Speaker system

Speaker unit

Rated impedance

Dimensions (approx.)

Subwoofer Bass reflex

160 mm (6 3/8 in) cone type

3 ohms

169 mm × 300 mm × 320 mm (6 3/4 in × 11 7/8 in × 12 3/8 in) (w/h/d)

Mass (approx.)

5.3 kg (11 lb 11 oz)

General

Power requirements

Power consumption

120 V AC, 60 Hz

On: 170 W

Standby: 0.2 W*

* Valid when the system is in the following status:

– “DEMO” is set to “OFF.”

– [CONTROL FOR HDMI] is set to [OFF].

Dimensions (approx.)

430 mm × 66 mm × 385 mm (17 in × 2 5/8 in × 15 1/4 in) (w/h/d) incl. projecting parts

Mass (approx.)

4.4 kg (9 lb 12 oz)

Supported file format

MP3 (MPEG 1 Audio Layer-3)

File Extension:

Bitrate:

Sampling frequencies:

mp3

32 kbps - 320 kbps

32/44.1/48 kHz

WMA (USB device only)

File Extension:

Bitrate:

Sampling frequencies:

wma

48 kbps - 192 kbps

44.1 kHz

AAC (USB device only)

File Extension:

Bitrate:

Sampling frequencies:

m4a

48 kbps - 320 kbps

44.1 kHz

MPEG4

File format:

File Extension:

Video codec:

MP4 File Format

mp4/m4v

MPEG4 Simple Profile (AVC is not compatible.)

Bitrate:

Frame rate:

Resolution:

Audio codec:

4 Mbps

30 fps

720 × 576

AAC-LC (HE-AAC is not compatible.)

DRM:

Not compatible

Design and specifications are subject to change without notice.

- Standby power consumption 0.2 W.
- Halogenated flame retardants are not used in the certain printed wiring boards.
- Over 85% power efficiency of amplifier block is achieved with the full digital amplifier, S-Master.

Playback Priority of File Types

The table below describes the playback priority of file types under the [MEDIA] setting.

File type on a disc or USB device	[MEDIA] setting				
	[VIDEO]		[MUSIC/PHOTO]	[PHOTO]	[MUSIC]
	Disc	USB device	Disc	Disc/USB device	Disc/USB device
Video files only	Video files	Video files	Video files	Video files	Video files
JPEG image files only	JPEG image files	JPEG image files	JPEG image files	JPEG image files	JPEG image files
Audio files only	MP3 files	Audio files	MP3 files	Audio files*	Audio files*
Video files and JPEG image files	Video files	Video files	JPEG image files	JPEG image files	Video files
Video files and audio files	Video files	Video files	MP3 files	Audio files*	Audio files*
Audio files and JPEG image files	MP3 files and JPEG image files with slide show	Audio files	MP3 files and JPEG image files with slide show	JPEG image files	Audio files*
Video files, audio files, and JPEG image files	Video files	Video files	MP3 files and JPEG image files with slide show	JPEG image files	Audio files*

* When using a disc, you can play MP3 files only.

Language Code List

The language spellings conform to the ISO 639: 1988 (E/F) standard.

Code Language	Code Language	Code Language	Code Language
1027 Afar	1183 Irish	1347 Maori	1507 Samoan
1028 Abkhazian	1186 Scots Gaelic	1349 Macedonian	1508 Shona
1032 Afrikaans	1194 Galician	1350 Malayalam	1509 Somali
1039 Amharic	1196 Guarani	1352 Mongolian	1511 Albanian
1044 Arabic	1203 Gujarati	1353 Moldavian	1512 Serbian
1045 Assamese	1209 Hausa	1356 Marathi	1513 Siswati
1051 Aymara	1217 Hindi	1357 Malay	1514 Sesotho
1052 Azerbaijani	1226 Croatian	1358 Maltese	1515 Sundanese
1053 Bashkir	1229 Hungarian	1363 Burmese	1516 Swedish
1057 Byelorussian	1233 Armenian	1365 Nauru	1517 Swahili
1059 Bulgarian	1235 Interlingua	1369 Nepali	1521 Tamil
1060 Bihari	1239 Interlingue	1376 Dutch	1525 Telugu
1061 Bislama	1245 Inupiak	1379 Norwegian	1527 Tajik
1066 Bengali;	1248 Indonesian	1393 Occitan	1528 Thai
Bangla	1253 Icelandic	1403 (Afan)Oromo	1529 Tigrinya
1067 Tibetan	1254 Italian	1408 Oriya	1531 Turkmen
1070 Breton	1257 Hebrew	1417 Punjabi	1532 Tagalog
1079 Catalan	1261 Japanese	1428 Polish	1534 Setswana
1093 Corsican	1269 Yiddish	1435 Pashto;	1535 Tonga
1097 Czech	1283 Javanese	Pushto	1538 Turkish
1103 Welsh	1287 Georgian	1436 Portuguese	1539 Tsonga
1105 Danish	1297 Kazakh	1463 Quechua	1540 Tatar
1109 German	1298 Greenlandic	1481 Rhaeto-	1543 Twi
1130 Bhutani	1299 Cambodian	Romance	1557 Ukrainian
1142 Greek	1300 Kannada	1482 Kirundi	1564 Urdu
1144 English	1301 Korean	1483 Romanian	1572 Uzbek
1145 Esperanto	1305 Kashmiri	1489 Russian	1581 Vietnamese
1149 Spanish	1307 Kurdish	1491 Kinyarwanda	1587 Volapük
1150 Estonian	1311 Kirghiz	1495 Sanskrit	1613 Wolof
1151 Basque	1313 Latin	1498 Sindhi	1632 Xhosa
1157 Persian	1326 Lingala	1501 Sangho	1665 Yoruba
1165 Finnish	1327 Laothian	1502 Serbo-	1684 Chinese
1166 Fiji	1332 Lithuanian	Croatian	1697 Zulu
1171 Faroese	1334 Latvian;	1503 Singhalese	
1174 French	Lettish	1505 Slovak	
1181 Frisian	1345 Malagasy	1506 Slovenian	1703 Not specified

Parental Control Area Code List

Code Area	Code Area	Code Area	Code Area
2044 Argentina	2165 Finland	2362 Mexico	2149 Spain
2047 Australia	2174 France	2376 Netherlands	2499 Sweden
2046 Austria	2109 Germany	2390 New Zealand	2086 Switzerland
2057 Belgium	2248 India	2379 Norway	2528 Thailand
2070 Brazil	2238 Indonesia	2427 Pakistan	2184 United
2079 Canada	2254 Italy	2424 Philippines	Kingdom
2090 Chile	2276 Japan	2436 Portugal	
2092 China	2304 Korea	2489 Russia	
2115 Denmark	2363 Malaysia	2501 Singapore	

Index

Numerics

4:3 OUTPUT 55

A

A/V SYNC 51
ANGLE 34
ATTENUATE 52
AUDIO 55
AUDIO (HDMI) 57
AUDIO DRC 58
AUDIO SETUP 57
AUTO CALIBRATION 57
AUTO STBY 53

B

BACKGROUND 58
BLACK LEVEL 56
BLACK LEVEL
(COMPONENT OUT) 56

C

CONTROL FOR HDMI 56
Control for HDMI 47
Control Menu 16
CUSTOM 54

D

D. C. A. C. (Digital Cinema
Auto Calibration) 57
DEMO 53
DIMMER 53
DUAL MONO 52
DVD's menu 34

E

EFFECT 37

F

FM MODE 42
Front panel 11
Front panel display 12

H

HDMI
YCbCr/RGB (HDMI) 57
HDMI RESOLUTION 56
HDMI SETUP 56

I

INTERVAL 38
iPod 40

J

JPEG RESOLUTION 57

L

Language Code List 74
LANGUAGE SETUP 54

M

MEDIA 32, 38
MENU 54
Multi Session CD 8
MULTI-DISC RESUME 59
Multiplex broadcast sound 52

O

OSD 54

P

PARENTAL CONTROL 59
PAUSE MODE 56
Playable discs 6
Program Play 35
PROGRESSIVE
(COMPONENT OUT) 55

Q

Quick Setup 26

R

Rear panel 13
Region code 8
Repeat Play 37
RESET 59

S

SCREEN SAVER 58
SETUP 54
Shuffle Play 36
SLEEP 51
SPEAKER FORMATION 57
SPEAKER SETUP 60
CONNECTION 60
DISTANCE 60
LEVEL 60
SUBTITLE 34, 55
Super Audio CD 35
SYSTEM MENU 42, 44, 51,
52, 53
SYSTEM SETUP 58

T

TEST TONE 60
TIME 33
TRACK SELECTION 58
TV TYPE 55

V

VIDEO SETUP 55
VOLUME LIMIT 56



* 4 1 6 5 4 8 3 1 2 * (1)

Free Manuals Download Website

<http://myh66.com>

<http://usermanuals.us>

<http://www.somanuals.com>

<http://www.4manuals.cc>

<http://www.manual-lib.com>

<http://www.404manual.com>

<http://www.luxmanual.com>

<http://aubethermostatmanual.com>

Golf course search by state

<http://golfingnear.com>

Email search by domain

<http://emailbydomain.com>

Auto manuals search

<http://auto.somanuals.com>

TV manuals search

<http://tv.somanuals.com>