

DVD Home Theatre System

Operating Instructions



MP3

*Digital Direct
Twin Drive Subwoofer*

HDMI™
HIGH-DEFINITION MULTIMEDIA INTERFACE

DAV-DZ810W

WARNING

To reduce the risk of fire or electric shock, do not expose this apparatus to rain or moisture.

Do not install the appliance in a confined space, such as a bookcase or built-in cabinet.

To prevent fire, do not cover the ventilation of the apparatus with news papers, table-cloths, curtains, etc. And don't place lighted candles on the apparatus.

To prevent fire or shock hazard, do not place objects filled with liquids, such as vases, on the apparatus.



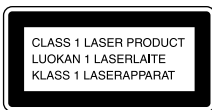

Don't throw away the battery with general house waste, dispose of it correctly as chemical waste.



This appliance is classified as a CLASS 1 LASER product. This marking is located on the rear or bottom exterior.

NOTICE FOR THE CUSTOMERS IN THE UNITED KINGDOM

A moulded plug complying with BS1363 is fitted to this equipment for your safety and convenience.

Should the fuse in the plug supplied need to be replaced, a fuse of the same rating as the supplied one and approved by ASTA or BSI to BS1362, (i.e., marked with mark  or  mark) must be used.

If the plug supplied with this equipment has a detachable fuse cover, be sure to attach the fuse cover after you change the fuse. Never use the plug without the fuse cover.

If you should lose the fuse cover, please contact your nearest Sony service station.

Precautions

Safety

- If anything falls into the cabinet, unplug the unit and have it checked by qualified personnel before operating it any further.
- The unit is not disconnected from the AC power source (mains) as long as it is connected to the wall outlet (mains), even if the unit itself has been turned off.
- Unplug the unit from the wall outlet if you do not intend to use it for an extended period of time. To disconnect the cord, pull it out by the plug, never by the cord.

Installing

- Allow adequate air circulation to prevent internal heat buildup.
- Do not place the unit on surfaces (rugs, blankets, etc.) or near materials (curtains, draperies) that may block the ventilation slots.
- Do not install the unit near heat sources such as radiators, or air ducts, or in a place subject to direct sunlight, excessive dust, mechanical vibration, or shock.
- Do not install the unit in an inclined position. It is designed to be operated in a horizontal position only.
- Keep the unit and discs away from equipment with strong magnets, such as microwave ovens, or large loudspeakers.
- Do not place heavy objects on the unit.
- If the unit is brought directly from a cold to a warm location, moisture may condense inside the DVD Home Theatre System and cause damage to the lenses. When you first install the unit, or when you move it from a cold to a warm location, wait for about 30 minutes before operating the unit.



Disposal of Old Electrical & Electronic Equipment (Applicable in the European Union and other European countries with separate collection systems)

This symbol on the product or on its packaging indicates that this product shall not be treated as household waste. Instead it shall be handed over to the applicable collection point for the recycling of electrical and electronic equipment. By ensuring this product is disposed of correctly, you will help prevent potential negative consequences for the environment and human health, which could otherwise be caused by inappropriate waste handling of this product. The recycling of materials will help to conserve natural resources. For more detailed information about recycling of this product, please contact your local city office, your household waste disposal service or the shop where you purchased the product.

Welcome!

Thank you for purchasing Sony DVD Home Theatre System. Before operating this system, please read this manual thoroughly and retain it for future reference.

Table of Contents

Welcome!	2	Resuming Playback from the Point Where You Stopped the Disc	43
About This Manual	5	(Resume Play)	
This System Can Play the Following Discs	5	Creating Your Own Program	44
Getting Started – BASIC –		(Program Play)	
Step 1: Assembling the Speakers and Installing the Surround Amplifier	9	Playing in Random Order	45
Step 2: Connecting the System and TV	15	(Shuffle Play)	
Step 3: Positioning the System... Step 4: Performing the Quick Setup	19 20	Playing Repeatedly	46
Getting Started – ADVANCED –		(Repeat Play)	
Turning off the Demonstration	24	Using the DVD's Menu	47
Installing the Speakers and the IR transmitter on a Wall	25	Changing the Sound	48
TV Hookup (Advanced)	27	Selecting [ORIGINAL] or [PLAY LIST] on a DVD-R/DVD-RW	50
Other Component Hookup	31	Viewing Information About the Disc	50
Basic Operations		Changing the Angles	53
Playing Discs	33	Displaying the Subtitles	53
Enjoying the Radio or Other Components	34	Adjusting the Delay Between the Picture and Sound	54
Enjoying TV or VCR Sound from All Speakers	35	(A/V SYNC)	
Selecting the Movie or Music Mode	36	Selecting a Playback Area for a Super Audio CD	54
Sound Adjustments		About MP3 Audio Tracks and JPEG Image Files	55
Enjoying Surround Sound by Using Sound Field	37	Playing DATA CDs or DATA DVDs with MP3 Audio Tracks and JPEG Image Files	57
Enjoying Multiplex Broadcast Sound... (DUAL MONO)	39	Playing Audio Tracks and Images as a Slide Show with Sound	59
Various Functions for Playing Discs		Enjoying DivX® Videos	61
Searching for a Particular Point on a Disc	40	Playing VIDEO CDs with PBC Functions (Ver.2.0)	63
(Scan, Slow-motion Play, Freeze Frame)		(PBC Playback)	
Searching for a Title/Chapter/Track/ Scene, etc.	41	Tuner Functions	
Searching by Scene	42	Presetting Radio Stations	64
(Picture Navigation)		Listening to the Radio	64
		Using the Radio Data System (RDS) ...	66
		Other Operations	
		Controlling the TV with the Supplied Remote	67
		Using the THEATRE SYNC Function	68
		Using the Sound Effect	69
		Using the Sleep Timer	70

Changing the Brightness of the Front Panel Display	70
---	----

Advanced Settings and Adjustments







Locking Discs	71
(CUSTOM PARENTAL CONTROL, PARENTAL CONTROL)	
Getting Optimal Surround Sound for a Room	74
(SPEAKER FORMATION)	
Calibrating the Appropriate Settings Automatically	76
(AUTO CALIBRATION)	
Using the Setup Display.....	78
Setting the Display or Sound Track Language	79
[LANGUAGE SETUP]	
Settings for the Display.....	80
[SCREEN SETUP]	
Custom Settings	82
[CUSTOM SETUP]	
Settings for the Speakers.....	83
[SPEAKER SETUP]	
Returning to the Default Settings.....	86

Additional Information

Precautions	87
Notes about the Discs.....	88
Troubleshooting	88
Self-diagnosis Function	92
(When letters/numbers appear in the display)	
Specifications	93
Glossary	94
Language Code List	98
Index to Parts and Controls.....	99
Guide to the Control Menu Display....	102
DVD Setup Display List	105
AMP Menu List	106
Index	107

About This Manual

- The instructions in this manual describe the controls on the remote. You can also use the controls on the system if they have the same or similar names as those on the remote.
- The Control Menu items may be different depending on the area.
- “DVD” may be used as a general term for DVD VIDEOS, DVD+RWs/DVD+Rs, and DVD-RWs/DVD-Rs.
- Measurements are expressed in feet (ft) for North American models.
- The following symbols are used in this manual.







Symbol	Meaning
	Functions available for DVD VIDEOS, DVD-Rs/DVD-RWs in video mode, and DVD+Rs/DVD+RWs
	Functions available for DVD-Rs/DVD-RWs in VR (Video Recording) mode
	Functions available for VIDEO CDs (including Super VCDs or CD-Rs/CD-RWs in video CD format or Super VCD format)
	Functions available for Super Audio CDs
	Functions available for music CDs or CD-Rs/CD-RWs in music CD format
	Functions available for DATA CDs (CD-ROMs/CD-Rs/CD-RWs) containing MP3 ¹⁾ audio tracks, JPEG image files, and DivX ²⁾³⁾ video files
	Functions available for DATA DVDs (DVD-ROMs/DVD-Rs/DVD-RWs/DVD+Rs/DVD+RWs) containing MP3 ¹⁾ audio tracks, JPEG image files, and DivX ²⁾³⁾ video files

¹⁾MP3 (MPEG1 Audio Layer 3) is a standard format defined by ISO/MPEG which compresses audio data.

²⁾DivX[®] is a video file compression technology, developed by DivX, Inc.

³⁾DivX, DivX Certified, and associated logos are trademarks of DivX, Inc. and are used under license.

This System Can Play the Following Discs

Format of discs	Disc logo
DVD VIDEO	
DVD-RW/ DVD-R	
DVD+RW/ DVD+R	
Super Audio CD	 SUPER AUDIO CD
VIDEO CD (Ver. 1.1 and 2.0 discs)/ Audio CD	
CD-RW/CD-R (audio data) (MP3 files) (JPEG files)	

“DVD+RW,” “DVD-RW,” “DVD+R,” “DVD VIDEO,” and the “CD” logos are trademarks.

Note about CDs/DVDs

The system can play CD-ROMs/CD-Rs/CD-RWs recorded in the following formats:

- audio CD format
- video CD format

continued

- MP3 audio tracks, JPEG image files, and DivX video files of format conforming to ISO 9660 Level 1/Level 2, or its extended format, Joliet

The system can play DVD-ROMs/DVD+RWs/DVD-RWs/DVD+Rs/DVD-Rs recorded in the following formats:

- MP3 audio tracks, JPEG image files and DivX video files of format conforming to UDF (Universal Disc Format)

Example of discs that the system cannot play

The system cannot play the following discs:

- CD-ROMs/CD-Rs/CD-RWs other than those recorded in the formats listed on page 5
- CD-ROMs recorded in PHOTO CD format
- Data part of CD-Extras
- DVD Audios
- DATA DVDs that do not contain MP3 audio tracks, JPEG image files, or DivX video files.
- DVD-RAMs

Also, the system cannot play the following discs:

- A DVD VIDEO with a different region code (page 6, 96)
- A disc that has a non-standard shape (e.g., card, heart)
- A disc with paper or stickers on it
- A disc that has the adhesive of cellophane tape or a sticker still left on it

Notes about CD-R/CD-RW/DVD-R/DVD-RW/DVD+R/DVD+RW

In some cases, CD-R/CD-RW/DVD-R/DVD-RW/DVD+R/DVD+RW cannot be played on this system due to the recording quality or physical condition of the disc, or the characteristics of the recording device and authoring software.

The disc will not play if it has not been correctly finalized. For more information, see the operating instructions for the recording device. Note that some playback functions may not work with some DVD+RWs/DVD+Rs, even if they have been correctly finalized. In this case,

view the disc by normal playback. Also some DATA CDs/DATA DVDs created in Packet Write format cannot be played.

Music discs encoded with copyright protection technologies

This product is designed to play back discs that conform to the Compact Disc (CD) standard. Recently, various music discs encoded with copyright protection technologies are marketed by some record companies. Please be aware that among those discs, there are some that do not conform to the CD standard and may not be playable by this product.

Note on DualDisc

A DualDisc is a two sided disc product which mates DVD recorded material on one side with digital audio material on the other side. However, since the audio material side does not conform to the Compact Disc (CD) standard, playback on this product is not guaranteed.

About Multi Session CD

- This system can play Multi Session CDs when an MP3 audio track is contained in the first session. Any subsequent MP3 audio tracks recorded in later sessions can also be played back.
- This system can play Multi Session CDs when a JPEG image file is contained in the first session. Any subsequent JPEG image files recorded in later sessions can also be played back.
- If audio tracks and images in music CD format or video CD format are recorded in the first session, only the first session will be played back.

Region code

Your system has a region code printed on the bottom exterior and will only play DVDs labeled with the same region code.

DVD VIDEOS labeled  will also play on this system.

If you try to play any other DVD VIDEO, the message [Playback prohibited by area limitations.] will appear on the TV screen. Depending on the DVD VIDEO, no region code indication may be given even though playing the DVD VIDEO is prohibited by area restrictions.

Note on playback operations of DVDs and VIDEO CDs

Some playback operations of DVDs and VIDEO CDs may be intentionally set by software producers. Since this system plays DVDs and VIDEO CDs according to the disc contents the software producers designed, some playback features may not be available. Also, refer to the instructions supplied with the DVDs or VIDEO CDs.

Copyrights

This product incorporates copyright protection technology that is protected by U.S. patents and other intellectual property rights. Use of this copyright protection technology must be authorized by Macrovision, and is intended for home and other limited viewing uses only unless otherwise authorized by Macrovision. Reverse engineering or disassembly is prohibited.

This system incorporates with Dolby* Digital and Dolby Pro Logic (II) adaptive matrix surround decoder and the DTS** Digital Surround System.

* Manufactured under license from Dolby Laboratories.
“Dolby,” “Pro Logic,” and the double-D symbol are trademarks of Dolby Laboratories.

** Manufactured under license from Digital Theater Systems, Inc.
“DTS” and “DTS Digital Surround” are trademarks of Digital Theater Systems, Inc.

Getting Started – BASIC –

See Unpacking in Specifications, page 93.

Inserting batteries into the remote

You can control the system using the supplied remote. Insert two R6 (size AA) batteries by matching the \oplus and \ominus ends on the batteries to the markings inside the compartment. When using the remote, point it at the remote sensor  on the system.

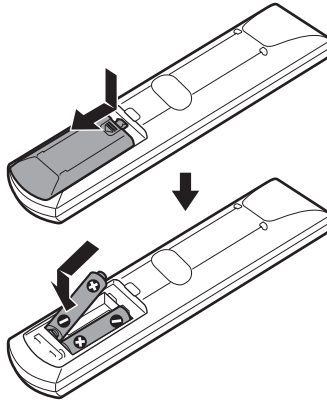

Note

- Do not leave the remote in an extremely hot or humid place.
- Do not use a new battery with an old one.
- Do not drop any foreign object into the remote casing, particularly when replacing the batteries.
- Do not expose the remote sensor to direct light from the sun or lighting apparatus. Doing so may cause a malfunction.
- If you do not intend to use the remote for an extended period of time, remove the batteries to avoid possible damage from battery leakage and corrosion.

Attaching the foot pads to the subwoofer

Attach the supplied foot pads to the bottom of the subwoofer to stabilize the subwoofer and prevent it from slipping.

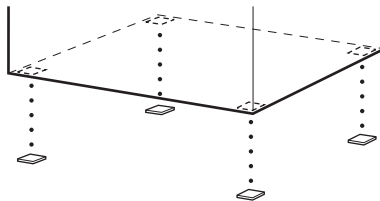

Step 1: Assembling the Speakers and Installing the Surround Amplifier

Before connecting the speakers, attach the speaker stand to the speaker.

About how to connect the speaker cords to the SPEAKER jacks, see page 16.

The IR receiver cord should be used for the surround speaker (L) only. The illustrations below show how to install the surround speaker (L).

Note

- Spread a cloth on the floor to avoid damaging the floor.

Tip

- You can use the speaker without the speaker stand by installing it on the wall (page 25).

1 Secure the post to the base.

The long post is for floor use, the short post is for tabletop use.

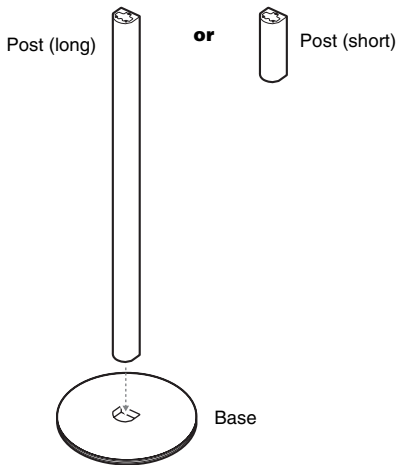

2 Secure the base with the screws.

Screws with washer (long) (3)
(supplied)

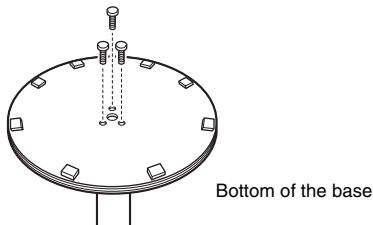

continued

9GB

- 3** Pull the speaker cord out to a straight length of about 700 mm (28 inch). Fold back about 100 mm (4 inch) and twist together.

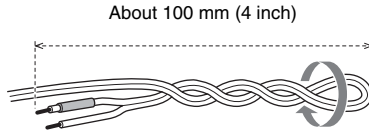

- 4** Draw the IR receiver cord first, and then the speaker cord through the hole on the base. Stand the speaker up, and untwist and straighten out the speaker cord.

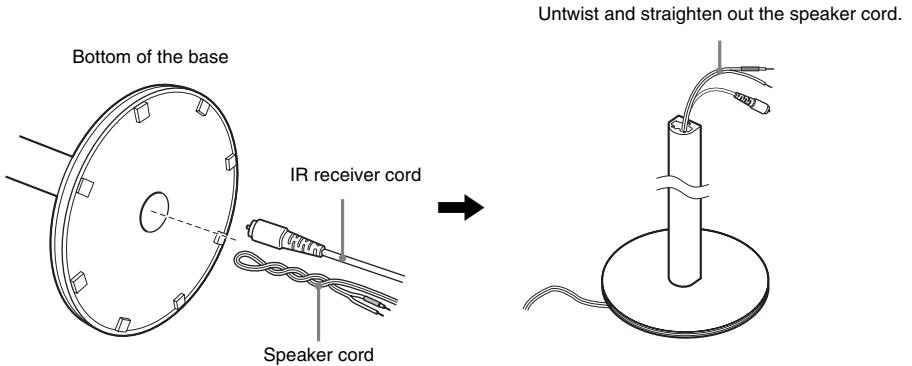

- 5** Secure the pedestal to the post with the screws.

Screws with washer (long) (3)
(supplied)

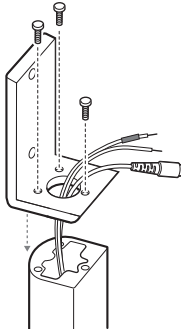

- 6** Connect the IR receiver cord to the speaker and run the cord around the pin.

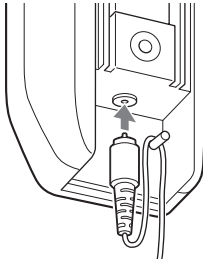

- 7** Connect the speaker cords to the speaker. Then run the cords through the slots (A, B, C, and D) all the way.

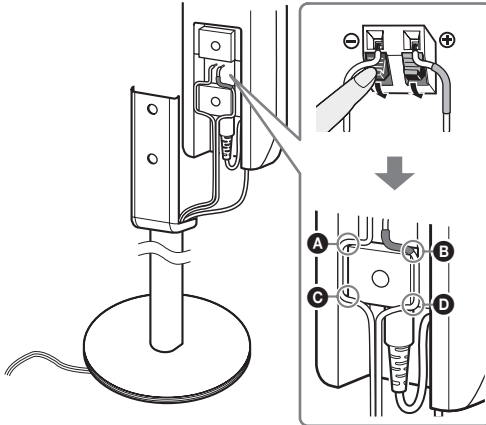

8 Slide the speaker down slowly onto the pedestal.

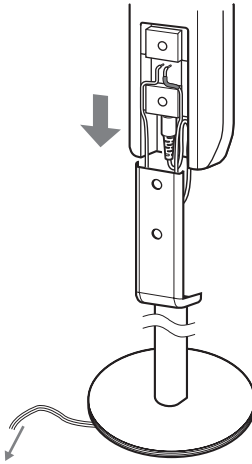

Adjust the length of the speaker cord (and the IR receiver cord).

Note

- Do not catch the speaker cord (and the IR receiver cord) between the speaker and the pedestal.
- Do not drop the speaker when mounting.

9 Secure the speaker with the screws in order ① to ②.

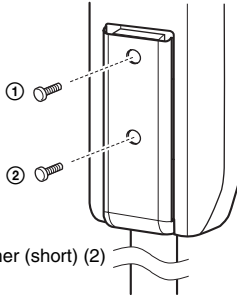

Screws with washer (short) (2)
(supplied)

Installing the surround amplifier (speaker base)

You can put on the surround speaker (L) to the surround amplifier, the surround speaker (R) to the speaker base.

The illustrations below show how to attach the surround speaker (L) to the surround amplifier.

Note

- Lay the surround speakers down when attaching the surround amplifier and speaker base.

1 Attach the spacers.

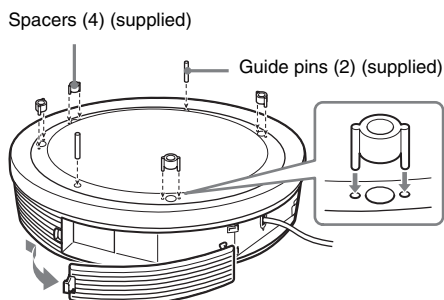

2 Attach the surround amplifier (speaker base) to the surround speaker with the guide pins.

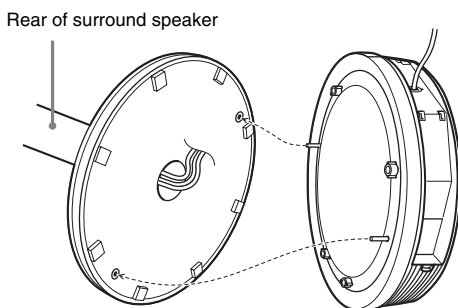

3 Secure the surround amplifier (speaker base) with the screws to the circle marked holes.

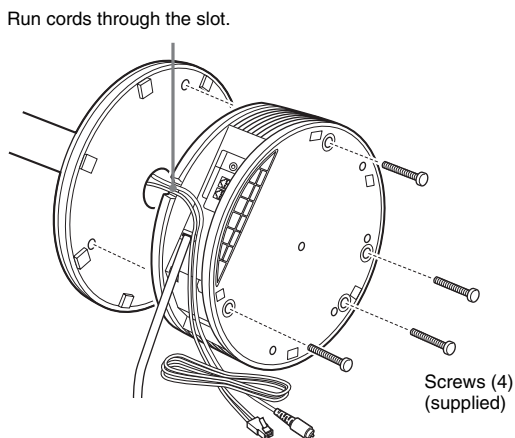

continued

13^{GB}

4 Connect the speaker cords and the IR receiver cord to the surround amplifier.

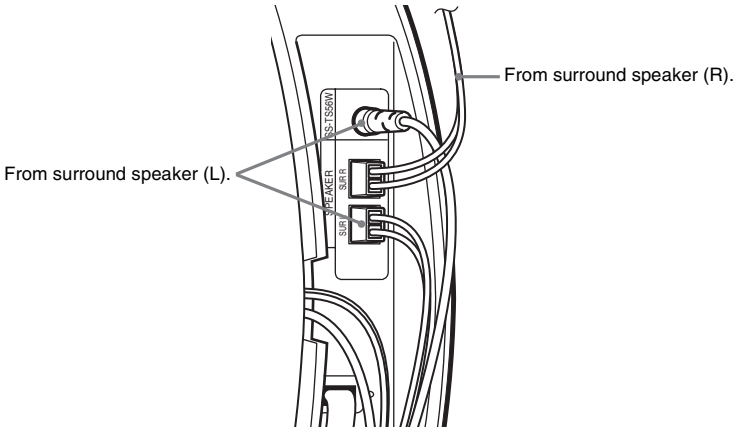

5 Bundle the cords into the storage space. Stand the speaker up.

The speaker base has storage space in the back.

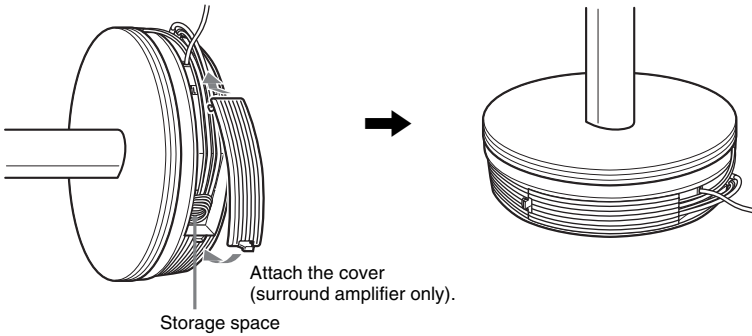

Step 2: Connecting the System and TV

This hookup is the basic connection of the system to the speakers and TV. For other TV connections, see page 27. For other component connection, see page 31.

To accept progressive signals, see page 29.

Refer to the connection diagram below, and read the additional information from ① to ④ on the following pages.

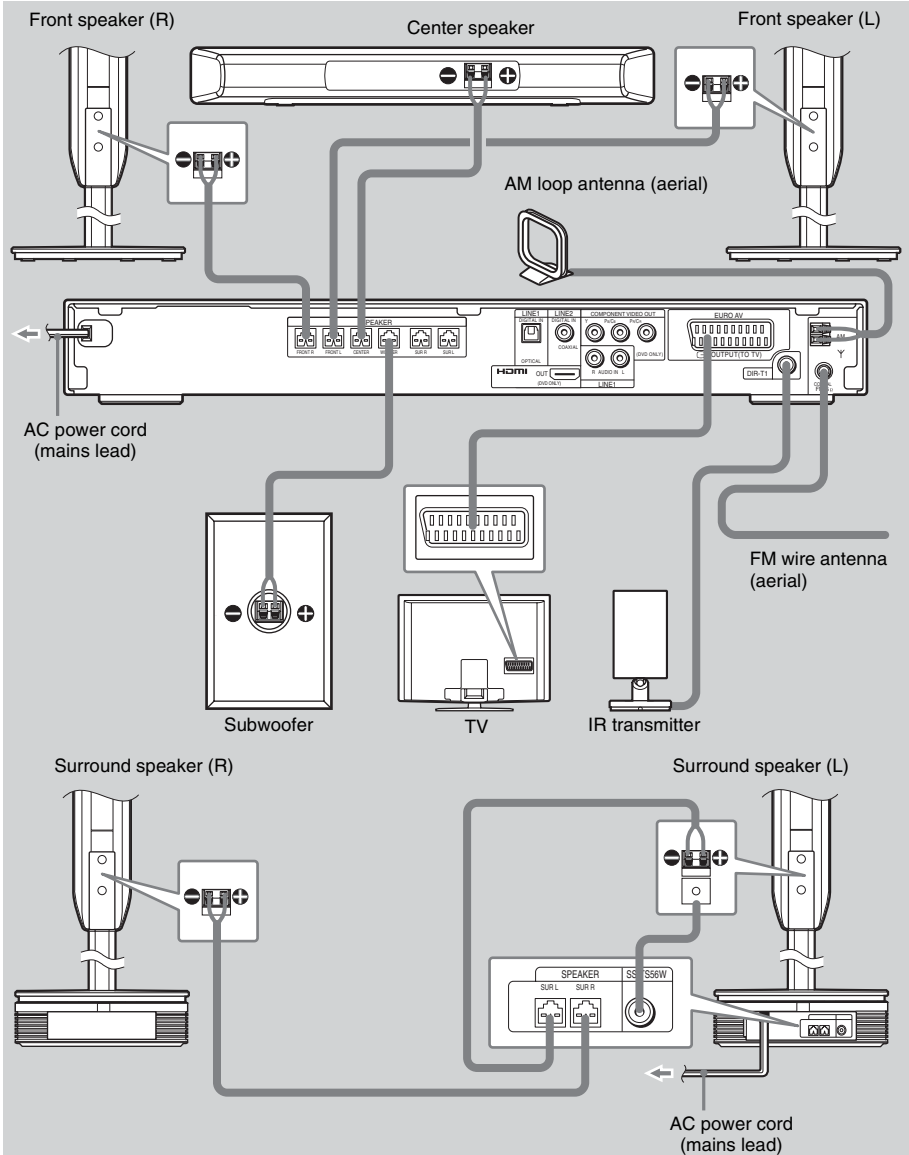

continued

15GB

① Connecting the Speakers

Required cords

The connector and color tube of the speaker cords are the same color as the label of the jacks to be connected.

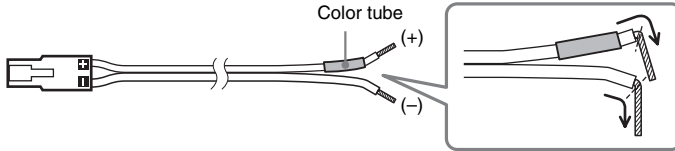

Note

- Do not catch the speaker cord insulation in the SPEAKER jack.

To avoid short-circuiting the speakers

Short-circuiting of the speakers may damage the system. To prevent this, be sure to follow these precautions when connecting the speakers. Make sure the bare wire of each speaker cord does not touch another speaker terminal or the bare wire of another speaker cord, such as shown below.

Stripped speaker cord is touching another speaker terminal.

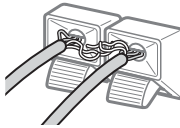

Stripped cords are touching each other due to excessive removal of insulation.

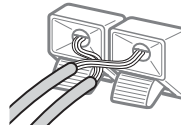

After connecting all the components, speakers, and AC power cord (mains lead), output a test tone to check that all the speakers are connected correctly. For details on outputting a test tone, see page 85. If no sound is heard from a speaker while outputting a test tone, or a test tone is output from a speaker other than the one currently displayed on the Setup Display, the speaker may be short-circuited. If this happens, check the speaker connection again.

Note

- Be sure to match the speaker cord to the appropriate terminal on the components: ⊕ to ⊕, and ⊖ to ⊖. If the cords are reversed, the sound will lack bass and may be distorted.

② Connecting the TV

Required cords

SCART (EURO AV) cord (not supplied)



Be sure to connect the SCART (EURO AV) cord to the EURO AV  OUTPUT (TO TV) jack on the system.

When you connect using the SCART (EURO AV) cord, check that the TV conforms to S video or RGB signals. If the TV conforms to S video, change the input mode of the TV to RGB signals. Refer to the operating instructions supplied with the TV to be connected.

Tip

- When you want to output the TV sound or stereo sound of a 2 channel source from the 6 speakers, select the “Dolby Pro Logic,” “Dolby Pro Logic II MOVIE,” or “Dolby Pro Logic II MUSIC” sound field (page 37).

③ Connecting the Antenna (Aerial)

To connect the AM antenna (aerial)

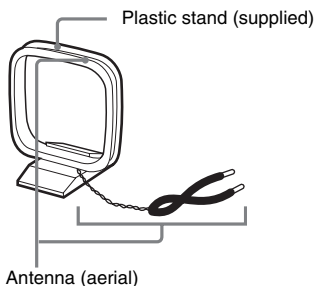

The shape and the length of the antenna (aerial) is designed to receive AM signals. Do not dismantle or roll up the antenna (aerial).

- 1 Remove only the loop part from the plastic stand.
- 2 Set up the AM loop antenna (aerial).

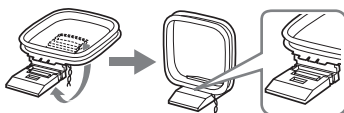

- 3 Connect the cords to the AM antenna (aerial) terminals.

Cord (A) or cord (B) can be connected to either terminal.

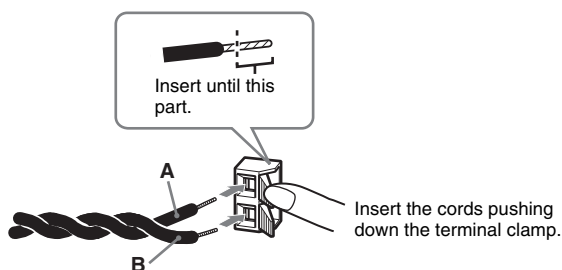
**Note**

- Do not place the AM loop antenna (aerial) near the system or other AV equipment, as noise may result.

Tip

- Adjust the direction of the AM loop antenna (aerial) for best AM broadcast sound.

- 4 Make sure the AM loop antenna (aerial) is connected firmly by pulling softly.

continued

17^{GB}

To connect the FM wire antenna (aerial)

Connect the FM wire antenna (aerial) to the COAXIAL FM 75 Ω jack.

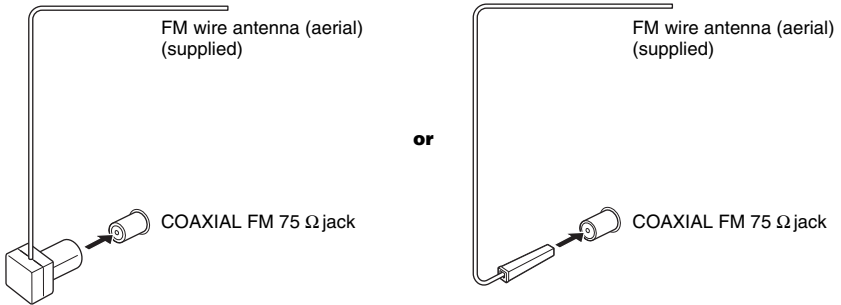

Note

- Be sure to fully extend the FM wire antenna (aerial).
- After connecting the FM wire antenna (aerial), keep it as horizontal as possible.

Tip

- If you have poor FM reception, use a 75-ohm coaxial cable (not supplied) to connect the system to an outdoor FM antenna (aerial) as shown below.

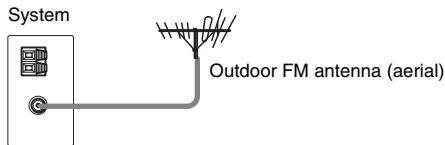

④ Connecting the AC power cord (mains lead)

Before connecting the AC power cord (mains lead) of this system to a wall outlet (mains), connect the speakers to the system.

Install this system so that the power cord can be unplugged from the wall socket immediately in the event of trouble.

Step 3: Positioning the System

Positioning the speakers

For the best possible surround sound, all the speakers other than the subwoofer should be the same distance from the listening position (A). The front speakers can be placed from 0.0 to 7.0 meters (0 to 23 ft) (A) from the listening position.

Install the IR transmitter and IR receiver of the surround speaker (L) in direct line with each other. For details, see “To adjust the IR transmitter and IR receiver of the surround speaker (L)” (page 22).

Place speakers as illustrated below.

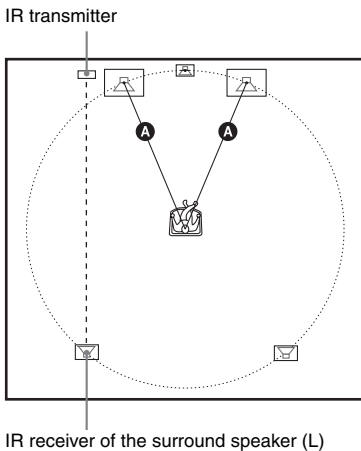

The following diagram indicates the infrared transmission area (the range that the infrared rays can reach).

Top view

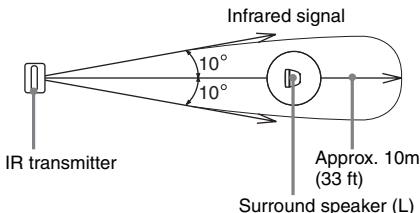

Side view

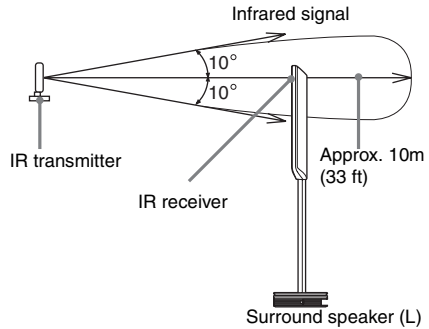

Note

- Do not install the surround speaker (L) (or IR receiver) in a place exposed to direct sunlight or strong light such as an incandescent lamp.
- The cord of the IR transmitter and IR receiver is for this system only.
- Do not step on or place objects other than supplied speakers on the surround amplifier and speaker base.
- When you install the speaker on the surround amplifier or speaker base, make sure the speaker is properly stacked.
- Do not set the speakers in an inclined position.
- Do not place the speakers in locations that are:
 - Extremely hot or cold
 - Dusty or dirty
 - Very humid
 - Subject to vibrations
 - Subject to direct sunlight
- Use caution when placing the speakers and/or speaker stands (not supplied) that are attached with the speakers on a specially treated (waxed, oiled, polished, etc.) floor, as staining or discoloration may result.
- When cleaning, use a soft cloth such as a cleaning cloth for glasses.
- Do not use any type of abrasive pad, scouring powder, or solvent such as alcohol or benzene.
- Do not lean or hang on the speaker, as the speaker may fall down.

Tip

- If transmission is poor, you can also connect the surround speakers to the system by the speaker cords (OPTION) (supplied).
- When you change the positions of the speakers, it is recommended that you change the settings. For details, see “Getting Optimal Surround Sound for a Room” (page 74) and “Calibrating the Appropriate Settings Automatically” (page 76).

Step 4: Performing the Quick Setup

Follow the steps below to make the minimum number of basic adjustments for using the system.

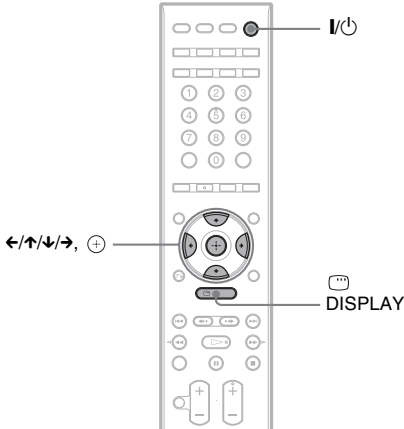

- 1 Turn on the TV.
- 2 Press I/O and POWER on the surround amplifier.

Note

- Disconnect the headphones when you perform the Quick Setup. You cannot operate steps after 12 with the headphones connected.
- Make sure that the function is set to "DVD."

- 3 Switch the input selector on your TV so that the signal from the system appears on the TV screen.

[Press [ENTER] to run QUICK SETUP.] appears at the bottom of the screen. If this message does not appear, display the Quick Setup and perform again (page 22).

- 4 Press ⊕ without inserting a disc.

The Setup Display for selecting the language used in the on-screen display appears.

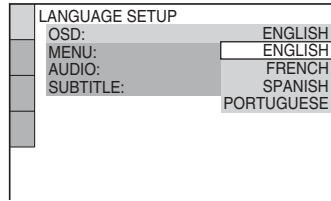

- 5 Press ↑/↓ to select a language.

The system displays the menu and subtitles in the selected language.

- 6 Press ⊕.

The Setup Display for selecting the aspect ratio of the TV to be connected appears.

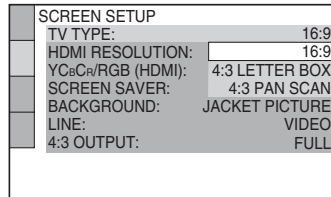

- 7 Press ↑/↓ to select the setting that matches your TV type.

■ If you have a 4:3 standard TV

[4:3 LETTER BOX] or [4:3 PAN SCAN] (page 80)

■ If you have a wide-screen TV or a 4:3 standard TV with a wide-screen mode

[16:9] (page 80)

- 8 Press ⊕.

The Setup Display for selecting the output method for video signals from the EURO AV ⇄ OUTPUT (TO TV) jack on the rear panel of the system appears.

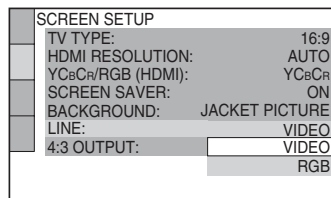

- 9 Press ↑/↓ to select the output method for video signals.

- [VIDEO]: outputs video signals.

- [RGB]: outputs RGB signals.

Note

- If your TV does not accept RGB signals, no picture appears on the TV screen even if you select [RGB]. Refer to the instructions supplied with your TV.

10 Press **+**.

The Setup Display for selecting the speaker formation appears.

11 Press **←/→** to select the speaker formation image as the speakers are actually positioned, then press **+**.

For details, see “Getting Optimal Surround Sound for a Room” (page 74).

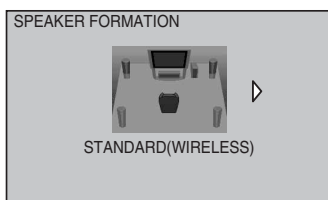
**12** Connect the calibration mic to the **A.CAL MIC** jack on the front panel and press **↑/↓** to select **[YES]**, then press **+**.

Set up the calibration mic at the ear level using a tripod, etc. (not supplied). The front of each speaker should face the calibration mic, and there should be no obstruction between the speakers and the calibration mic. Be quiet during the measurement.

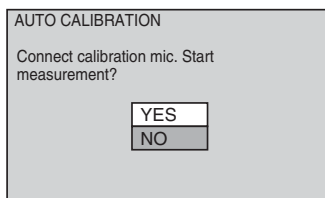
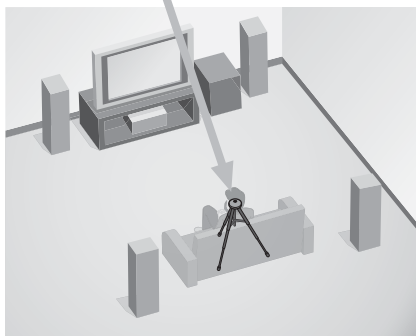
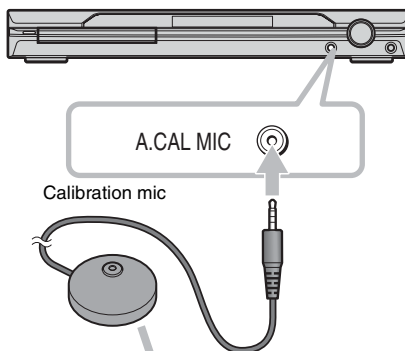

Auto Calibration starts.

Note

- Loud test sound is output when [AUTO CALIBRATION] starts. You cannot turn the volume down. Give consideration to children and neighbor.
- Avoid being in the measurement area and making noise during the measurement (which takes about 1 minute), as it may interfere with measurement.

13 Unplug the calibration mic and press **←/→** to select **[YES]**.

Quick Setup is finished. All connections and setup operations are complete.

continued

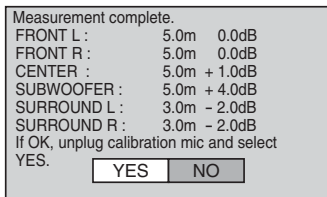
**Note**

- Reflections from walls or the floor may affect measurements.
- If measurement fails, follow the message then retry [AUTO CALIBRATION].

To quit the Quick Setup

Press DISPLAY in any Step.

Tip

- If you change the position of the speakers, reset the speaker settings. See “Getting Optimal Surround Sound for a Room” (page 74) and “Calibrating the Appropriate Settings Automatically” (page 76).
- If you want to change any of the settings, see “Using the Setup Display” (page 78).

To recall the Quick Setup display

- 1 Press DISPLAY when the system is in stop mode.

The Control Menu appears.

- 2 Press to select [SETUP], then press .

The options for [SETUP] appear.

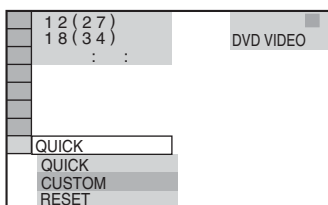

- 3 Press to select [QUICK], then press .

The Quick Setup display appears.

To adjust the IR transmitter and IR receiver of the surround speaker (L)

After connecting the speakers, surround amplifier, IR transmitter, and the AC power cords (mains leads), adjust the wireless system for good transmission.

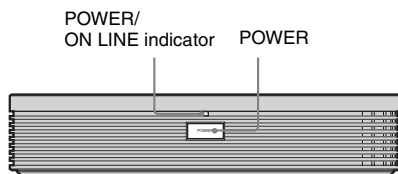
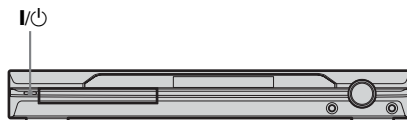

- 1 Press I/O on the system and POWER on the surround amplifier.

The system and surround amplifier turn on and the POWER/ON LINE indicator turns red.

- 2 Orient the IR transmitter and IR receiver of the surround speaker (L) to face each other.

Adjust the position until the POWER/ON LINE indicator turns green.

Tip

- The IR transmitter is movable for easy reorientation.

Note

- Make sure that there is no obstruction such as a person or object between the IR transmitter and the IR receiver of the surround speaker (L). Otherwise, the sound from the surround speakers may be interrupted.
- If the POWER/ON LINE indicator turns red, transmission is not occurring. Adjust the position of the IR transmitter and surround speaker (L) until the POWER/ON LINE indicator turns green.
- If the POWER/ON LINE indicator flashes red, the IR receiver is receiving an infrared ray from another Sony's wireless product. Move the IR transmitter and/or the surround speaker (L) so that the POWER/ON LINE indicator turns green.

To place the surround speaker (L) in the (R) position

Depending on the location of the wall outlet (mains), you can also place the surround speaker (L) (with the IR receiver) in the (R) position if necessary.

- 1** Press AMP MENU.
- 2** Press \uparrow/\downarrow repeatedly until “SL SR REV” appears in the front panel display, then press \oplus or \rightarrow .
- 3** Press \uparrow/\downarrow to select the setting.
 - REV ON: Sets the surround speaker (L) (with the IR receiver) in the (R) position.
 - REV OFF: Sets the surround speaker (L) (with the IR receiver) in the (L) position.
- 4** Press \oplus .

The setting is made.
- 5** Press AMP MENU.

The AMP menu turns off.

Getting Started – ADVANCED –

Turning off the Demonstration

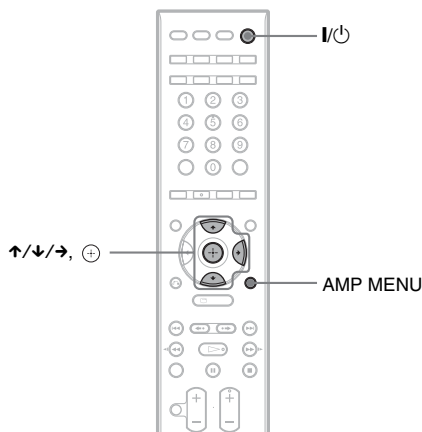

After connecting the AC power cord (mains lead), the demonstration appears in the front panel display. When you press I/⏻ on the remote, the demonstration turns off.

Note

- When you press I/⏻ on the system, the demonstration does not turn off.
- When you set the demonstration mode in the AMP menu to on, the demonstration does not turn off even though you press I/⏻ on the remote. To turn off the demonstration, set the demonstration mode to off, then press I/⏻ on the remote. When the demonstration mode is set to off, the system saves power in standby mode.

Setting the demonstration mode on/off

- 1 Press AMP MENU.**
- 2 Press ↑/↓ repeatedly until “DEMO” appears in the front panel display, then press + or →.**
- 3 Press ↑/↓ to select the setting.**

- DEMO ON: sets the demonstration mode on.

- DEMO OFF: sets the demonstration mode off.

- 4 Press +.**
The setting is reflected.

- 5 Press AMP MENU.**
The AMP menu turns off.

Installing the Speakers and the IR transmitter on a Wall

- 1 Prepare screws (not supplied) that are suitable for the hole on the back of each speaker. See the illustrations below.**

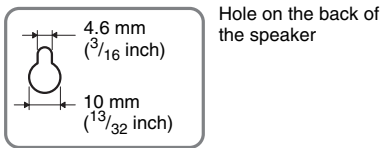
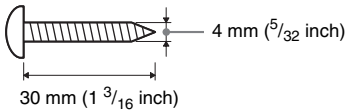

- 2 Fasten the screws to the wall.
For the front and surround speakers**

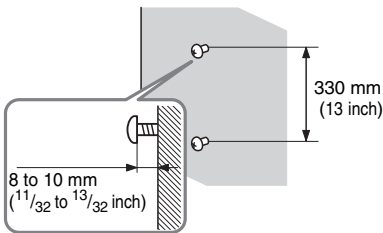

- 3 Hang the speakers on the screws.**

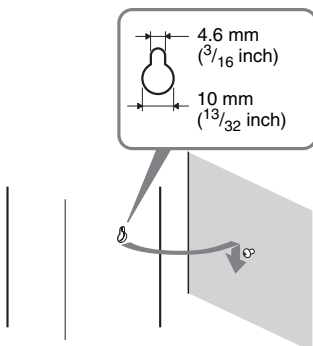

Note

- Use screws that are suitable for the wall material and strength. As a plaster board wall is especially fragile, attach the screws securely to a beam and fasten them to the wall. Install the speakers on a vertical and flat wall where reinforcement is applied.
- Contact a screw shop or installer regarding the wall material or screws to be used.
- Sony is not responsible for accident or damage caused by improper installation, insufficient wall strength or improper screw installation, natural calamity, etc.

Installing the IR transmitter on a wall

You can hang the IR transmitter on a wall when:

- there is an obstruction between the IR transmitter and IR receiver of the surround speaker (L).
- people often pass between the IR transmitter and IR receiver of the surround speaker (L).

When hanging both the IR transmitter and surround speaker (L), adjust the position of the IR transmitter after deciding the position of the surround speaker (L).

- 1 Rotate the stand of the IR transmitter.**

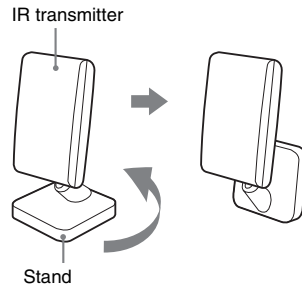

- 2 Install 2 commercially available screws in the wall so that it protrudes 4 mm ($\frac{3}{16}$ inch). Install the screws 30 mm ($1 \frac{3}{16}$ inch) apart.**

continued

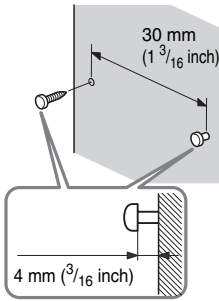

Note

- Use screws suitable for the material and strength of the wall.
- Do not install the IR transmitter to a wall of low strength.
- Sony is not liable for any damage or accident incurred by incorrect installation (i.e. low strength wall, etc.), incorrect use of this product, or natural disaster.
- When connecting/disconnecting the cord, detach the IR transmitter from the wall first.

3 Hang the IR transmitter via hole on the bottom of the stand on the screw.

Make sure that the IR transmitter does not move after installation.

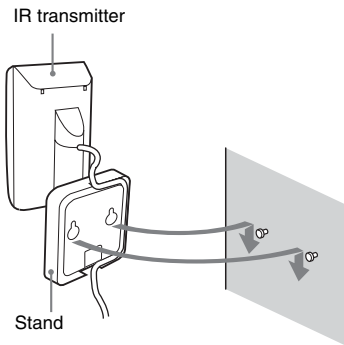

Tip

- You can store the cords in the troughs in the bottom of the stand.

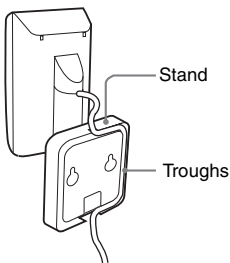

TV Hookup (Advanced)

Select a hookup suitable for the jacks on your TV.

Connecting the video/HDMI* cords

Sends a played back DVD image to a TV.

Check the jacks of your TV, and choose connection method **A**, **B**, or **C**. Picture quality improves in order from **A** (standard) to **C** (HDMI).

B TV with COMPONENT VIDEO IN jacks

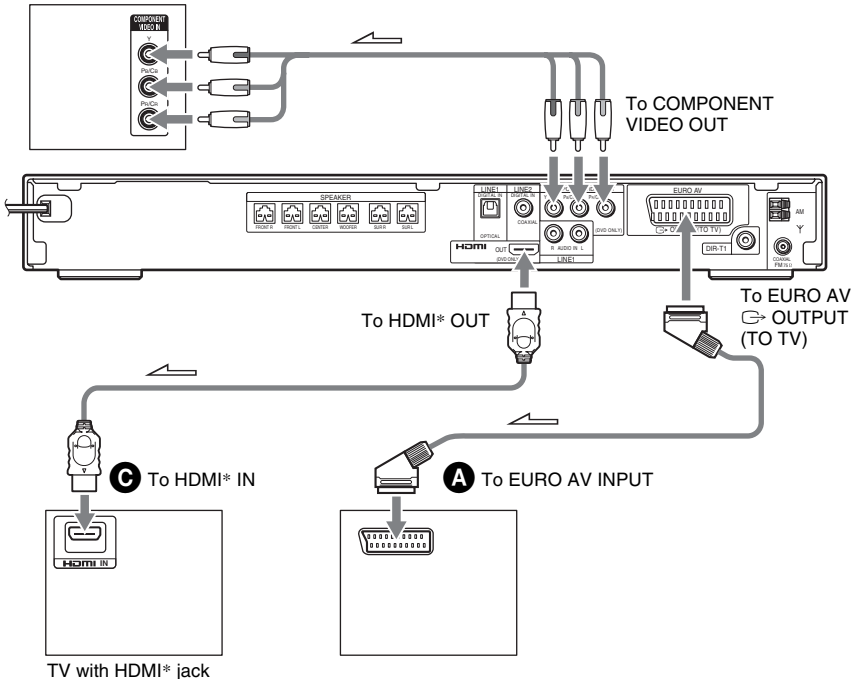

* HDMI (high-definition multimedia interface)

The system is based on version 1.1 of High-Definition Multimedia Interface Specifications.

The system incorporates High-Definition Multimedia Interface (HDMI™) technology.

HDMI, the HDMI logo and High-Definition Multimedia Interface trademarks or registered trademarks of HDMI Licensing LLC.

A To connect to a TV with the SCART (EURO AV) cord (not supplied)



Be sure to connect the SCART (EURO AV) cord to the EURO AV  OUTPUT (TO TV) jack on the system.

When you connect using the SCART (EURO AV) cord, check that the TV conforms to S video or RGB signals. If the TV conforms to S video, change the input mode of the TV to RGB signals. Refer to the operating instructions supplied with the TV to be connected.

B To connect to a TV with the COMPONENT VIDEO IN jacks

Connect a component video cord (not supplied). To use the COMPONENT VIDEO OUT jacks (Y, Pb/Cb, Pr/Cr), your TV monitor must be equipped with via COMPONENT VIDEO IN jacks (Y, Pb/Cb, Pr/Cr). If your TV accepts progressive format signals, you must use this connection and set the output channel of the system to progressive format (page 29).

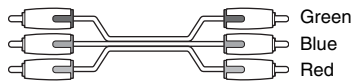

C To connect to a TV with the HDMI (high-definition multimedia interface)/DVI (digital visual interface) input jack

Use a certified HDMI (high-definition multimedia interface) cord (not supplied) to enjoy high quality digital picture and sound through the HDMI OUT (high-definition multimedia interface out) jack. Note that Super Audio CD sound is not output from the HDMI OUT (high-definition multimedia interface out) jack.



To connect to a TV with DVI (digital visual interface) input

Use an HDMI (high-definition multimedia interface)-DVI (digital visual interface) converter cord (not supplied) with an HDMI (high-definition multimedia interface)-DVI (digital visual interface) adaptor (not supplied). The DVI (digital visual interface) jack will not accept any audio signals. Furthermore, you cannot connect the HDMI OUT (high-definition multimedia interface out) jack to DVI (digital visual interface) jacks that are not HDCP (high-bandwidth digital content protection) compliant (e.g., DVI (digital visual interface) jacks on PC displays).

When connecting to a standard 4:3 screen TV

Depending on the disc, the image may not fit your TV screen.
To change the aspect ratio, see page 80.

Does your TV accept progressive signals?

Progressive is the method for displaying TV images which reduces flickering, and sharpens the image. To display using this method, you need to connect to a TV that accepts progressive signals.

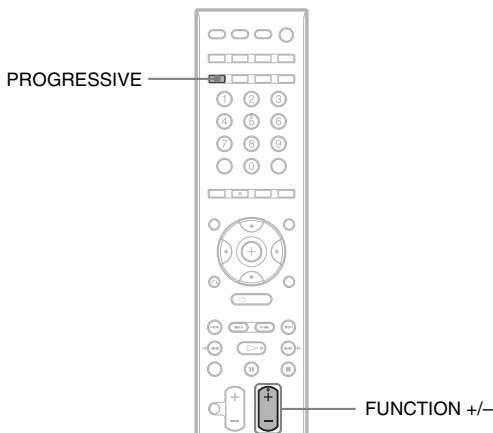

“PROGRE” lights up in the front panel display when the system outputs progressive signals.

1 Press **FUNCTION +/-** repeatedly to select “DVD.”

2 Press **PROGRESSIVE**.

Each time you press PROGRESSIVE, the display changes as follows:

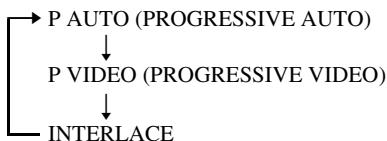

■ P AUTO (PROGRESSIVE AUTO)

Select this setting when:

- your TV accepts progressive signals, and,
- the TV is connected to the COMPONENT VIDEO OUT jacks.

Normally select this under the above condition. This automatically detects the software type, and selects the appropriate conversion method.

Note that the picture will not be clear or no picture will appear if you select these settings when either of the above conditions are not met.

■ P VIDEO (PROGRESSIVE VIDEO)

Select this setting when:

- your TV accepts progressive signals, and,
- the TV is connected to the COMPONENT VIDEO OUT jacks, and,
- you want to fix the conversion method to PROGRESSIVE VIDEO for video-based software.

Select this if the image is not clear when you select PROGRESSIVE AUTO.

Note that the picture will not be clear or no picture will appear if you select these settings when either of the above conditions are not met.

continued

■ INTERLACE

Select this setting when:

- your TV does not accept progressive signals, or,
- your TV is connected to jacks other than the COMPONENT VIDEO OUT jacks (EURO AV ⇄ OUTPUT (TO TV)).

You cannot select NORMAL (INTERLACE) while “HDMI” lights up in the front panel display.

About DVD software types and the conversion method

DVD software can be divided into 2 types: film-based software and video-based software.

Video-based software is derived from TV, such as dramas and sit-coms, and displays images at 30 frames/60 fields per second. Film-based software is derived from film and displays images at 24 frames per second. Some DVD software contains both video and film.

In order for these images to appear natural on your screen when output in progressive format, the progressive signals need to be converted to match the type of DVD software that you are watching.

Note

- When you play video-based software in progressive signal format, sections of some types of images may appear unnatural due to the conversion process when output through the COMPONENT VIDEO OUT jacks. Even though you set to “PROGRESSIVE AUTO” or “PROGRESSIVE VIDEO,” images from the EURO AV ⇄ OUTPUT (TO TV) jack are unaffected as they are output in the interlace format.
- If you set [LINE] in [SCREEN SETUP] to [RGB] (page 81), the system switches to “INTERLACE.” This will happen even though you select “PROGRESSIVE AUTO” or “PROGRESSIVE VIDEO.”
- If you set [LINE] in [SCREEN SETUP] to [RGB] (page 81), the system outputs no component video signals.

Other Component Hookup

You can enjoy sound using the speakers of this system by connecting the AUDIO OUT jacks of another component. For video connection of other components, connect directly to the TV.

Connecting the system and the other component

Outputs the other component through the speakers of this system.

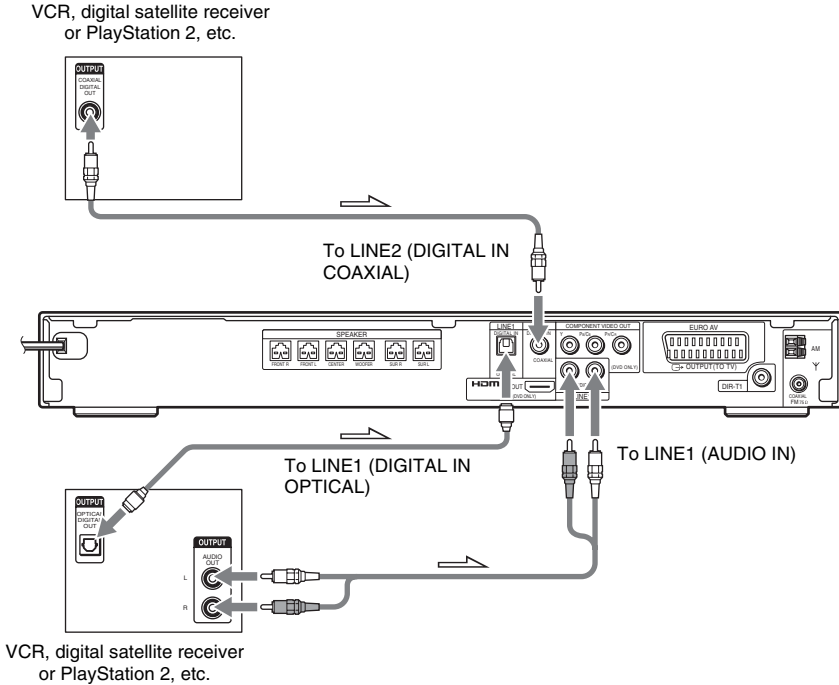

To connect the AUDIO OUT jacks of other component to the LINE1 (AUDIO IN) jacks of this system

Connect the VCR or other components to the LINE1 (AUDIO IN) jacks using the audio cord (not supplied). When connecting a cord, be sure to match the color-coded sleeves to the appropriate jacks on the components.

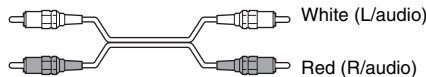

To listen to the portable audio source sound through the system

Connect the audio output jacks of the portable audio source to the AUDIO IN jack on the front panel of the system with the stereo mini-plug cord (not supplied).



continued

Tip

- When listening to MP3 format recordings using a portable audio source, you can enhance the sound. Press FUNCTION +/- to select "AUDIO." Connect the portable audio source. Press SOUND FIELD repeatedly until "A.F.D. STD" appears in the front panel display. To cancel, select other than "A.F.D. STD."

If you connect a digital satellite receiver with an DIGITAL OUT (OPTICAL or COAXIAL) jack

The digital satellite receiver can be connected to the LINE1 (DIGITAL IN OPTICAL) jack or LINE2 (DIGITAL IN COAXIAL) jack instead of the LINE1 (AUDIO IN) jacks of the system. The system can accept both the digital and analog signals. Digital signals have priority over analog signals. If the digital signal ceases, the analog signal will be processed after 2 seconds.

If you connect a digital satellite receiver without an DIGITAL OUT jack

Connect the digital satellite receiver to the LINE1 jacks only of the system.

Note

- Be sure to make connections securely to avoid hum and noise.

Basic Operations

Playing Discs

DVD-V

DVD-VR

VIDEO CD

Support Audio CD

CD

DATA-CD

DATA DVD

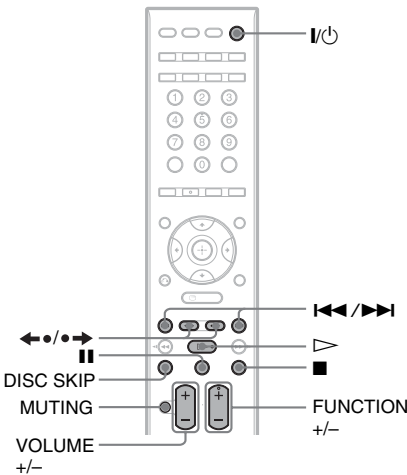
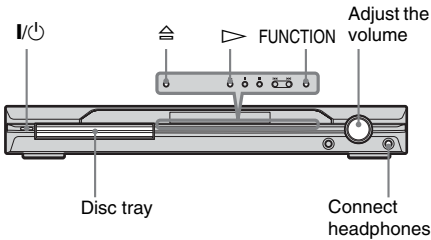

Depending on the DVD VIDEO or VIDEO CD, some operations may be different or restricted. Refer to the operation details supplied with your disc.

- 1 Turn on your TV.**
- 2 Switch the input selector on the TV to this system.**
- 3 Press I/Power.**

The system turns on.

Unless the system is set to "DVD," press FUNCTION +/- to select "DVD."

- 4 Press Play.**

- 5 Load a disc.**

Place one disc on the tray, and then press Play.

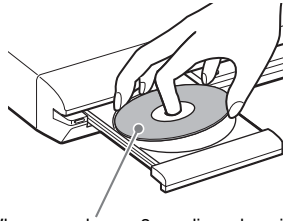

When you play an 8 cm disc, place it on the inner circle of the tray. Be careful that the disc is not skewed on the inner circle of the tray.

Note

- Do not forcibly press the disc tray closed with your finger, as this may cause malfunction.
- Do not place more than one disc on the tray.

- 6 Press Play.**

The system starts playback (continuous play).

Adjust the volume on the system.

The volume level appears on the TV screen and in the front panel display.

Note

- Depending on the system status, the volume level may not appear on the TV screen.

To save the power in standby mode

Press I/Power while the system turns on. To cancel standby mode, press I/Power once.

Additional operations

To	Press
Stop	■
Pause	⏸
Resume play after pause	⏸ or ▷
Go to the next chapter, track, or scene	▶▶ (except for JPEG)
Go back to the preceding chapter, track, or scene	◀◀ (except for JPEG)
Mute the sound	MUTING. To cancel muting, press it again or VOLUME + to adjust the sound volume.

continued

To	Press
Stop play and remove the disc	⏏
Replay the previous scene*	◀• (instant replay) during playback.
Briefly fast forward the current scene**	•▶ (instant advance) during playback.

* DVD VIDEOS/DVD-RWs/DVD-Rs only. The button can be used except for DivX video files.

** DVD VIDEOS/DVD-RWs/DVD-Rs/DVD+RWs/DVD+Rs only. The button can be used except for DivX video files.

Note

- You may not be able to use the Instant Replay or Instant Advance function with some scenes.

Enjoying the Radio or Other Components

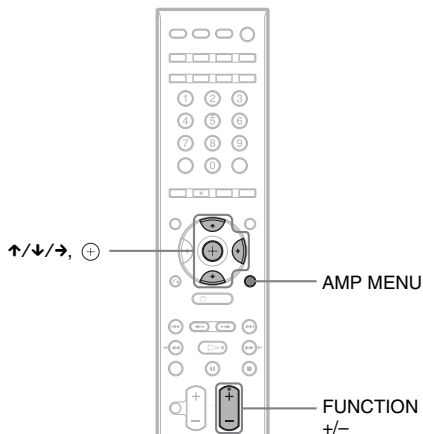

Selecting the connected component

You can use a VCR or other components connected to the LINE 1 jacks on the rear panel. Refer to the operation manual supplied with the components for further information on the operation.

Press FUNCTION +/- repeatedly until "LINE1" appears in the front panel display.

Each time you press FUNCTION +/-, the mode of the system changes in the following sequence.

DVD → TUNER FM → TUNER AM →
LINE1 → LINE2 → TV → AUDIO → ...

Note

- When you use both the LINE 1 (AUDIO IN) jacks (analog connection) and LINE 1 (DIGITAL IN OPTICAL) jack (digital connection) at the same time, the digital connection takes priority.

Changing the input level of the sound from connected components

Distortion may occur when listening to a component connected to the LINE 1 jacks on the rear of the unit or to the AUDIO IN jack on the front panel. This is not a malfunction and will depend on the component connected.

To prevent this, you can change the input level from the sound of the other components.

- 1** Press **FUNCTION +/-** repeatedly until **"LINE1"** or **"AUDIO"** appears in the front panel display.
- 2** Press **AMP MENU**.
- 3** Press **↑/↓** repeatedly until **"ATTENUATE"** appears in the front panel display, then press **⊕** or **→**.
- 4** Press **↑/↓** to select a setting.
 - ATT ON: attenuates the input level. The output level is changed.
 - ATT OFF: normal input level.
- 5** Press **⊕**.
The setting is reflected.
- 6** Press **AMP MENU**.
The AMP menu turns off.

Enjoying TV or VCR Sound from All Speakers

You can enjoy TV or VCR sound from all the speakers in this system.

For details, see "TV Hookup (Advanced)" (page 27) and "Other Component Hookup" (page 31).

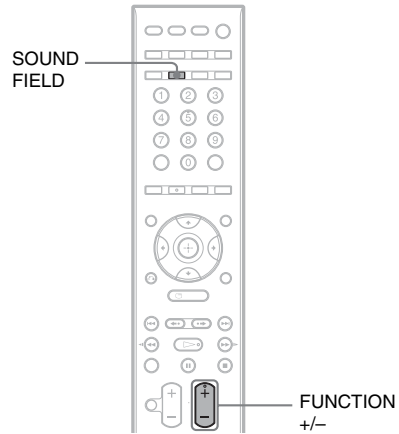

- 1** Press **FUNCTION +/-** repeatedly until **"LINE1," "LINE2,"** or **"TV"** appears in the front panel display.
- 2** Press **SOUND FIELD** repeatedly until the sound field you want appears in the front panel display.

When you want to output the TV sound or stereo sound of a 2 channel source from the 6 speakers, select the "PRO LOGIC," "PLII MOVIE," or "PLII MUSIC" sound field.

For details of sound field, see page 37.

Note

- When you use both the LINE 1 (AUDIO IN) jacks (analog connection) and LINE 1 (DIGITAL IN OPTICAL) jack (digital connection) at the same time, the digital connection takes priority.

Selecting the Movie or Music Mode

DVD-V

DVD-VR

VIDEO CD

Super Audio CD

C D

DATA-CD

DATA DVD

You can choose a suitable sound mode for movies or music.

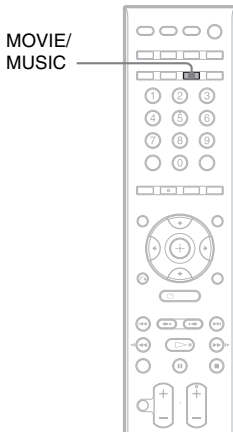

Press MOVIE/MUSIC during playback.

Press MOVIE/MUSIC repeatedly until the mode you want lights up in the front panel display. The default setting is underlined.

- AUTO: selects the mode automatically to produce the sound effect depending on the disc.
- MOVIE: provides the sound for movies.
- MUSIC: provides the sound for music.

Tip

- When the movie or music mode is selected, “MOVIE” or “MUSIC” is displayed in the front panel display.

Sound Adjustments

Enjoying Surround Sound by Using Sound Field

DVD-V

DVD-VR

VIDEO CD

C D

DATA-CD

DATA DVD

You can take advantage of surround sound simply by selecting one of system's pre-programmed sound fields. They bring the exciting and powerful sound of movie theaters into your home.

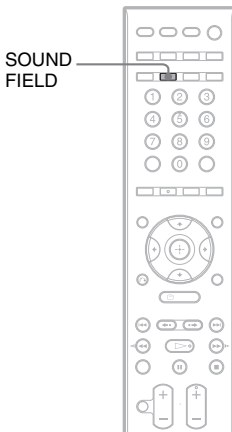

Press SOUND FIELD.

Press SOUND FIELD repeatedly until the sound field you want appears in the front panel display.

All sound field

Sound field	Display
AUTO FORMAT DIRECT STANDARD	A.F.D. STD
AUTO FORMAT DIRECT MULTI	A.F.D. MULTI
Dolby Pro Logic	PRO LOGIC
Dolby Pro Logic II MOVIE	PLII MOVIE
Dolby Pro Logic II MUSIC	PLII MUSIC
CINEMA STUDIO EX A	C. ST. EX A*
CINEMA STUDIO EX B	C. ST. EX B*
CINEMA STUDIO EX C	C. ST. EX C*

Sound field	Display
2 CHANNEL STEREO	2CH STEREO
HEADPHONE THEATER	HP THEATER
HEADPHONE 2 CHANNEL STEREO	HP 2CH

* Use DCS Technology

Automatic outputting of the original sound

■ AUTO FORMAT DIRECT STANDARD

The auto decoding function automatically detects the type of audio signal being input (Dolby Digital, DTS, or standard 2 channel stereo) and performs the proper decoding if necessary. This mode presents the sound as it was recorded/encoded, without adding any effects (e.g. reverberation).

However, if there are no low frequency signals (Dolby Digital LFE, etc.), it will generate a low frequency signal for output to the subwoofer.

Outputting the sound from multiple speakers

■ AUTO FORMAT DIRECT MULTI

This mode lets you enjoy audio playback of all types of discs from multiple speakers.

Outputting 2 channel sources like CDs by 5.1 channel

■ Dolby Pro Logic

Dolby Pro Logic produces five output channels from 2 channel sources. This mode performs Pro Logic decoding to the input signal and output to front, center, and surround speakers.

Meanwhile, the surround channel becomes monaural.

■ Dolby Pro Logic II MOVIE/MUSIC

Dolby Pro Logic II produces five full-bandwidth output channels from 2 channel sources. This is done using an advanced, high-purity matrix surround decoder that extracts the spatial properties of the original recording without adding any new sounds or tonal colorations.

continued

Note

- When the input signal is multi channel source, Dolby Pro Logic and Dolby Pro Logic II MOVIE/MUSIC are canceled and the multi channel source is output directly.
- When the bilingual broadcast sound is input, Dolby Pro Logic and Dolby Pro Logic II MOVIE/MUSIC are not effective.

Enjoying Digital Cinema Sound

About DCS (Digital Cinema Sound)

In collaboration with Sony Pictures Entertainment, Sony measured the sound environment of their studios and integrated the data of the measurement and Sony's own DSP (Digital Signal Processor) technology to develop "Digital Cinema Sound." "Digital Cinema Sound" simulates in a home theater an ideal movie theater sound environment based on the preference of the movie director.

■ CINEMA STUDIO EX A (Cinema Studio EX A)

Reproduces the sound characteristics of the Sony Pictures Entertainment "Cary Grant Theater" cinema production studio. This is a standard mode, great for watching most any type of movie.

■ CINEMA STUDIO EX B (Cinema Studio EX B)

Reproduces the sound characteristics of the Sony Pictures Entertainment "Kim Novak Theater" cinema production studio. This mode is ideal for watching science-fiction or action movies with lots of sound effects.

■ CINEMA STUDIO EX C (Cinema Studio EX C)

Reproduces the sound characteristics of the Sony Pictures Entertainment scoring stage. This mode is ideal for watching musicals or classic films where music is featured in the soundtrack.

About Cinema Studio EX

Cinema Studio EX is ideal for enjoying the movie software encoded with multi channel format, such as the Dolby Digital DVD. This

mode reproduces the sound characteristics of Sony Pictures Entertainment's studios. Cinema Studio EX consists of the following 3 elements.

- Virtual Multi Dimension
Creates 5 sets of virtual speakers surrounding the listener from a single pair of actual surround speakers.
- Screen Depth Matching
In a movie theater, sound seems to come from inside the image reflected on the movie screen. This element creates the same sensation in your listening room by shifting the sound of the front speakers "into" the screen.
- Cinema Studio Reverberation
Reproduces the reverberations peculiar to a movie theater. Cinema Studio EX is the integrated mode which operates these elements simultaneously.

Note

- The virtual speaker effect may cause increased noise in the playback signal.
- When listening with sound fields that employ virtual speakers, you will not be able to hear any sound coming directly from the surround speakers.

Using only the front speaker and subwoofer

■ 2 CHANNEL STEREO

This mode outputs the sound from the front left and right speakers and subwoofer. Standard 2 channel (stereo) sources completely bypass the sound field processing. Multi channel surround formats are downmixed to two channels. This allows you to play any source using only the front left and right speakers and subwoofer.

Enjoying the surround sound by headphones

■ HEADPHONE THEATER

This mode outputs the sound as surround from headphone L/R.

■ HEADPHONE 2 CHANNEL STEREO

This mode outputs the sound from headphone L/R. Standard 2 channel (stereo) sources completely bypass the sound field processing.

Multi channel surround formats are downmixed to two channels.

To turn the surround effect off

Press SOUND FIELD repeatedly until “A.F.D. STD” or “2CH STEREO” appears in the front panel display.

Tip

- The system memorizes the last sound field selected for each function mode.

Whenever you select a function such as DVD or TUNER, the sound field that was last applied to function is automatically applied again. For example, if you listen to DVD with PRO LOGIC as the sound field, then change to another function, and then return to DVD, PRO LOGIC will be applied again.

Enjoying Multiplex Broadcast Sound

(DUAL MONO)

You can enjoy multiplex broadcast sound when the system receive the Dolby Digital multiplex broadcast signal.

Note

- To receive the Dolby Digital signal, you need to connect a digital satellite tuner to the system with an optical cable (page 31) and set the digital output mode of the digital satellite tuner to Dolby Digital.

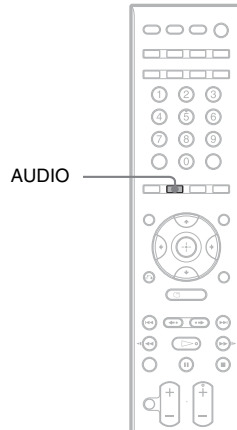

Press AUDIO.

Press AUDIO repeatedly until the signal you want appears in the front panel display. The default setting is underlined.

- MAIN: Sound of the main language will be output.
- SUB: Sound of the sub language will be output.
- MAIN+SUB: Mixed sound of both the main and sub languages will be output.

Various Functions for Playing Discs

Searching for a Particular Point on a Disc

(Scan, Slow-motion Play, Freeze Frame)

DVD-V DVD-VR VIDEO CD Super Audio CD CD

DATA-CD DATA DVD

You can quickly locate a particular point on a disc by monitoring the picture or playing back slowly.

Note

- Depending on the DVD/DivX video/VIDEO CD, you may not be able to do some of the operations described.

Locating a point quickly by playing a disc in fast forward or fast reverse (Scan)

(except for JPEG)

Press ◀◀/◀◀ or ▶▶/▶▶ while playing a disc. When you find the point you want, press ▷ to return to normal speed. Each time you press ◀◀/◀◀ or ▶▶/▶▶ during scan, the playback speed changes. With each press the indication changes as shown below. Actual speeds may differ with some discs.

Playback direction

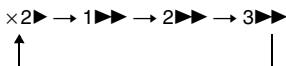

3▶▶ (DVD VIDEO/DVD-VR mode/DivX video/VIDEO CD only)

x2▶▶ (DVD VIDEO/Super Audio CD/CD only)

Opposite direction

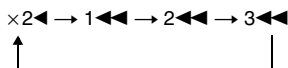

3◀◀ (DVD VIDEO/DVD-VR mode/DivX video/VIDEO CD only)

x2◀◀ (DVD VIDEO only)

With each press, playback speed becomes faster.

Watching frame by frame (Slow-motion Play)

(DVD VIDEO, DVD-R, DVD-RW, DivX video, VIDEO CD only)

Press ◀◀/◀◀ or ▶▶/▶▶ when the system is in pause mode. To return to the normal playback speed, press ▷. Each time you press ◀◀/◀◀ or ▶▶/▶▶ during Slow-motion Play, the playback speed changes. Two speeds are available. With each press the indication changes as follows:

Playback direction

2 ▶▶ ↔ 1 ▶▶

Opposite direction (DVD VIDEO only)

2 ◀◀ ↔ 1 ◀◀

Playing one frame at a time (Freeze Frame)

(except for Super Audio CD, CD, MP3, and JPEG)

When the system is in the pause mode, press ●→ (step) to go to the next frame. Press ◀● (step) to go to the preceding frame (DVD VIDEO/DVD-R/DVD-RW only). To return to normal playback, press ▷.

Note

- You cannot search for a still picture on a DVD-R/ DVD-RW in VR mode.
- For DATA CDs/DATA DVDs, this function works only for DivX video files.

Searching for a Title/ Chapter/Track/Scene, etc.

DVD-V

DVD-VR

VIDEO CD

Super Audio CD

CD

DATA-CD

DATA DVD

You can search a DVD by title or chapter, and you can search a VIDEO CD/Super Audio CD/CD/DATA CD/DATA DVD by track, index, or scene. As titles and tracks are assigned unique numbers on the disc, you can select the desired one by entering its number. Or, you can search for a scene using the time code.

1 Press  **DISPLAY**. (When playing a DATA CD/DATA DVD with JPEG image files, press  **DISPLAY** twice.)

The Control Menu appears.

2 Press  to select the search method.

The display will show different items depending on the disc.

 [TITLE], [TRACK], [SCENE]

 [CHAPTER], [INDEX]

 [TIME/TEXT]

Select [TIME/TEXT] to search for a starting point by inputting the time code.

 [TRACK]

 [INDEX]

 [ALBUM]

 [FILE]

Example: when you select  [CHAPTER]

[** (**)] is selected (** refers to a number).

The number in parentheses indicates the total number of titles, chapters, tracks, indexes, scenes, albums or files.

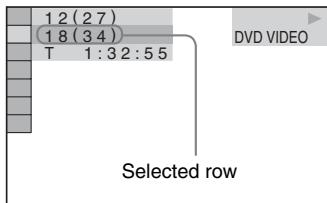

3 Press .

[** (**)] changes to [-- (**)].

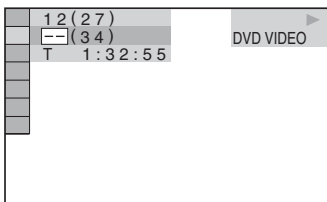

4 Press  or the number buttons to select the title, chapter, track, index, scene, etc., number you want to search for.

If you make a mistake

Cancel the number by pressing CLEAR, then select another number.

5 Press .

The system starts playback from the selected number.

To search for a scene using the time code (DVD VIDEO and DVD-VR mode only)

1 In Step 2, select  [TIME/TEXT].

[T **:**:**] (playing time of the current title) is selected.

2 Press .

[T **:**:**] changes to [T --:--:--].

3 Input the time code using the number buttons, then press .

For example, to find the scene at 2 hours, 10 minutes, and 20 seconds after the beginning, just enter [2:10:20].

Tip

- When the Control Menu display is turned off, you can search for a chapter (DVD VIDEO/DVD-R/DVD-RW), track (VIDEO CD/Super Audio CD/CD), or file (DATA CD/DATA DVD (DivX video)) by pressing the number buttons and \oplus .

Note

- You cannot search for a scene on a DVD+RW/DVD+R using the time code.

Searching by Scene

(Picture Navigation)

DVD-V **VIDEO CD**

You can divide the screen into 9 subscreens and find the desired scene quickly.

1 Press PICTURE NAVI during playback.

The following display appears.

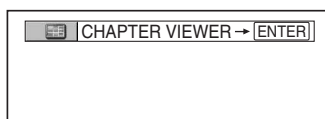

2 Press PICTURE NAVI repeatedly to select an item.

- [TITLE VIEWER] (DVD VIDEO only)
- [CHAPTER VIEWER] (DVD VIDEO only)
- [TRACK VIEWER] (VIDEO CD/Super VCD only)

3 Press \oplus .

The first scene of each title, chapter, or track appears as follows.

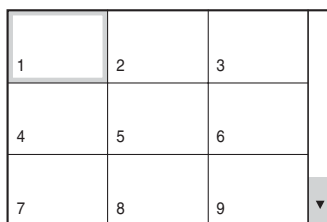

4 Press $\leftarrow/\uparrow/\downarrow/\rightarrow$ to select a title, chapter, or track, and press \oplus .

Playback starts from the selected scene.

To return to normal play during setting

Press \leftarrow RETURN or ☺ DISPLAY.

Note

- Depending on the disc, you may not be able to select some items.

Resuming Playback from the Point Where You Stopped the Disc

(Resume Play)



When you stop the disc, the system remembers the point where you pressed ■ and “RESUME” appears in the front panel display. As long as you do not remove the disc, Resume Play will work even if the system enters standby mode by pressing I/⏻.

1 While playing a disc, press ■ to stop playback.

“RESUME” appears in the front panel display.

If “RESUME” does not appear, Resume Play is not available.

2 Press ▷.

The system starts playback from the point where you stopped the disc in Step 1.

Note

- Depending on where you stop the disc, the system may not resume playback from exactly the same point.
- The point where you stopped playing may be cleared when:
 - you eject the disc.
 - the system enters standby mode (DATA CD/ DATA DVD only).
 - you change or reset the settings on the Setup Display.
 - you change the function by pressing FUNCTION +/-.
 - you disconnect the AC power cord (mains lead).
- For DVD-Rs/DVD-RWs in VR mode, VIDEO CDs, CDs, Super Audio CDs, DATA CDs, and DATA DVDs, the system remembers the resume playback point for the current disc.
- Resume Play does not work during Program Play and Shuffle Play.
- This function may not work properly with some discs.

Tip

- To play from the beginning of the disc, press ■ twice, then press ▷.

To enjoy a disc that is played before by resume playback (Multi-disc Resume) (DVD VIDEO, VIDEO CD only)

This system stores the point where you stopped the disc for up to 40 discs and resumes playback the next time you insert the same disc. If you store a resume playback point for the 41st disc, the resume playback point for the first disc is deleted.

To activate this function, set [MULTI-DISC RESUME] in [CUSTOM SETUP] to [ON]. For details, see “[MULTI-DISC RESUME] (DVD VIDEO/VIDEO CD only)” (page 82).

Tip

- To play from the beginning of the disc, press ■ twice, then press ▷.

Note

- If [MULTI-DISC RESUME] in [CUSTOM SETUP] is set to [OFF] (page 82), the resume point is cleared when you change the function by pressing FUNCTION +/-.

Creating Your Own Program

(Program Play)

VIDEO CD Super Audio CD CD

You can play the contents of a disc in the order you want by arranging the order of the tracks on the disc to create your own program. You can program up to 99 tracks.

1 Press DISPLAY.

The Control Menu appears.

2 Press to select [PROGRAM], then press .

The options for [PROGRAM] appear.

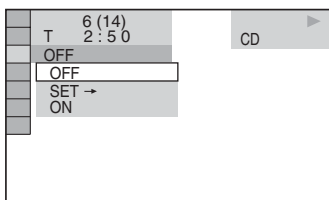

3 Press to select [SET ->], then press .

[TRACK] is displayed when you play a VIDEO CD, Super Audio CD, or CD.

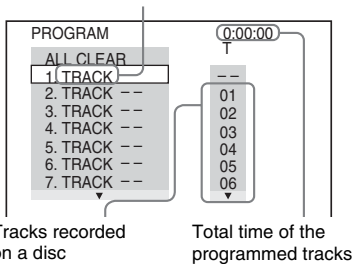

4 Press .

The cursor moves to the track row [T] (in this case, [01]).

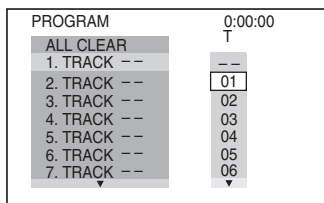

5 Select the track you want to program.

For example, select track [02].

Press to select [02] under [T], then press . The track number may be displayed in 3 digits for a Super Audio CD.

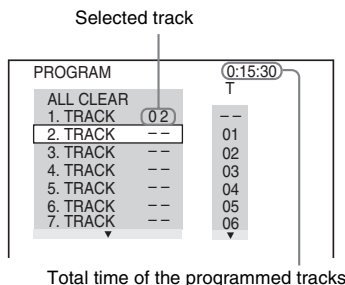

6 To program other tracks, repeat steps 4 to 5.

The programmed tracks are displayed in the selected order.

7 Press to start Program Play.

Program Play starts.

When the program ends, you can restart the same program again by pressing .

To return to normal play

Press CLEAR, or select [OFF] in Step 3. To play the same program again, select [ON] in Step 3 and press .

To turn off the Control Menu

Press DISPLAY repeatedly until the Control Menu is turned off.

To change or cancel a program

- 1 Follow steps 1 to 3 of “Creating Your Own Program.”
- 2 Select the program number of the track you want to change or cancel using \uparrow/\downarrow . If you want to delete the track from the program, press CLEAR.
- 3 Follow Step 5 for new programming. To cancel a program, select [--] under [T], then press \oplus .

To cancel all of the tracks in the programmed order

- 1 Follow steps 1 to 3 of “Creating Your Own Program.”
- 2 Press \uparrow and select [ALL CLEAR].
- 3 Press \oplus .

Playing in Random Order

(Shuffle Play)

VIDEO CD **Super Audio CD** **CD** **DATA-CD** **DATA DVD**

You can have the system “shuffle” tracks. Subsequent “shuffling” may produce a different playing order.

Note

- Same song may be played repeatedly during MP3 playback.

- 1 Press \square **DISPLAY** during playback. The Control Menu appears.
- 2 Press \uparrow/\downarrow to select  **[SHUFFLE]**, then press \oplus . The options for [SHUFFLE] appear.

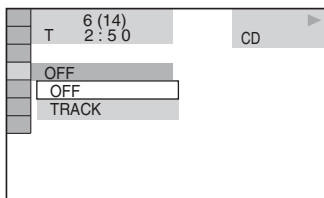

- 3 Press \uparrow/\downarrow to select the item to be shuffled.
 - When playing a VIDEO CD, Super Audio CD, or CD
 - [TRACK]: shuffles tracks on the disc.
 - When Program Play is activated
 - [ON]: shuffles tracks selected in Program Play.
 - When playing a DATA CD (except for DivX) or DATA DVD (except for DivX)
 - [ON]: shuffles MP3 audio tracks in the album on the current disc. When no album is selected, the first album will play in random order.

Note

- A track already played is also selected in random order.

- 4 Press \oplus . Shuffle Play starts.

continued

To return to normal play

Press CLEAR, or select [OFF] in Step 3.

To turn off the Control Menu

Press  DISPLAY repeatedly until the Control Menu is turned off.

Note

- You cannot use this function with VIDEO CDs and Super VCDs with PBC playback.

Playing Repeatedly

(Repeat Play)



You can play all the titles, tracks or albums on a disc or a single title, chapter, track, or album repeatedly.

You can use a combination of Shuffle or Program Play modes.

1 Press DISPLAY during playback.

The Control Menu appears.

2 Press to select [REPEAT], then press .

The options for [REPEAT] appear.

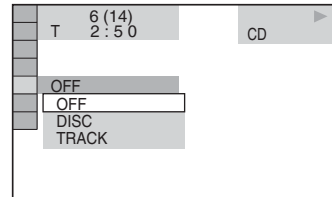

3 Press to select the item to be repeated.

The default setting is underlined.

■ When playing a DVD VIDEO or DVD-VR

- [OFF]: does not play repeatedly.
- [DISC]: repeats all of the titles on the disc.
- [TITLE]: repeats the current title on a disc.
- [CHAPTER]: repeats the current chapter.

■ When playing a VIDEO CD, Super Audio CD, or CD

- [OFF]: does not play repeatedly.
- [DISC]: repeats all of the tracks on the disc.
- [TRACK]: repeats the current track.

■ When playing a DATA CD or DATA DVD

- [OFF]: does not play repeatedly.
- [DISC]: repeats all of the albums on the disc.

- [ALBUM]: repeats the current album.
- [TRACK] (MP3 audio tracks only): repeats the current track.
- [FILE] (DivX video files only): repeats the current file.

4 Press \oplus .

The item is selected.

To return to normal play, press CLEAR, or select [OFF] in Step 3.

To turn off the Control Menu

Press DISP DISPLAY repeatedly until the Control Menu is turned off.

Note

- You cannot use this function with VIDEO CDs and Super VCDs with PBC playback.
- When playing a DATA CD/DATA DVD which contains MP3 audio track and JPEG image files, and their playing time are not the same, the audio sound will not match the image.
- When [MODE (MP3, JPEG)] is set to [IMAGE (JPEG)] (page 59), you cannot select [TRACK].

Using the DVD's Menu

DVD-V

A DVD is divided into a lot of sections, which make up a picture or music feature. These sections are called "titles." When you play a DVD which contains several titles, you can select the title you want using TOP MENU. When you play DVDs that allow you to select items such as the language for the subtitles and the language for the sound, select these items using MENU.

1 Press TOP MENU or MENU.

The disc's menu appears on the TV screen. The contents of the menu vary from disc to disc.

2 Press $\leftarrow/\uparrow/\downarrow/\rightarrow$ or the number buttons to select the item you want to play or change.

3 Press \oplus .

Changing the Sound

DVD-V

DVD-VR

VIDEO CD

CD

DATA-CD

DATA DVD

When playing a DVD VIDEO or DATA CD/ DATA DVD (DivX video files) recorded in multiple audio formats (PCM, Dolby Digital, MPEG audio, or DTS), you can change the audio format. If the DVD VIDEO is recorded with multilingual tracks, you can also change the language.

With VIDEO CDs, CDs, DATA CDs, or DATA DVDs, you can select the sound from the right or left channel and listen to the sound of the selected channel through both the right and left speakers.

1 Press AUDIO during playback.

The following display appears.

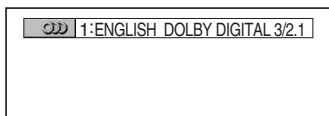

2 Press AUDIO repeatedly to select the desired audio signal.

■ When playing a DVD VIDEO

Depending on the DVD VIDEO, the choice of language varies.

When 4 digits are displayed, they indicate a language code. Refer to “Language Code List” (page 98) to see which language the code represents. When the same language is displayed two or more times, the DVD VIDEO is recorded in multiple audio formats.

■ When playing a DVD-VR

The types of sound tracks recorded on a disc are displayed. The default setting is underlined.

Example:

- [1: MAIN] (main sound)
- [1: SUB] (sub sound)
- [1: MAIN+SUB] (main and sub sound)
- [2: MAIN]
- [2: SUB]

- [2: MAIN+SUB]

Note

- [2: MAIN], [2: SUB], and [2: MAIN+SUB] do not appear when one audio stream is recorded on the disc.

■ When playing a VIDEO CD, CD, DATA CD (MP3 audio), or DATA DVD (MP3 audio)

The default setting is underlined.

- [STEREO]: the standard stereo sound
- [1/L]: the sound of the left channel (monaural)
- [2/R]: the sound of the right channel (monaural)

■ When playing a DATA CD (DivX video) or DATA DVD (DivX video)

The choice of DATA CD or DATA DVD audio signal formats differ, depending on the DivX video file contained on the disc. The format is shown in the display.

■ When playing a Super VCD

The default setting is underlined.

- [1:STEREO]: the stereo sound of the audio track 1
- [1:1/L]: the sound of the left channel of the audio track 1 (monaural)
- [1:2/R]: the sound of the right channel of the audio track 1 (monaural)
- [2:STEREO]: the stereo sound of the audio track 2
- [2:1/L]: the sound of the left channel of the audio track 2 (monaural)
- [2:2/R]: the sound of the right channel of the audio track 2 (monaural)

Note

- While playing a Super VCD on which the audio track 2 is not recorded, no sound will come out when you select [2:STEREO], [2:1/L], or [2:2/R].
- You cannot change the sound for Super Audio CDs.

Checking the audio signal format

(DVD, DivX video only)

If you press AUDIO repeatedly during playback, the format of the current audio signal (PCM, Dolby Digital, DTS, etc.) appears as shown below.

■ When playing a DVD

Example:

Dolby Digital 5.1 ch

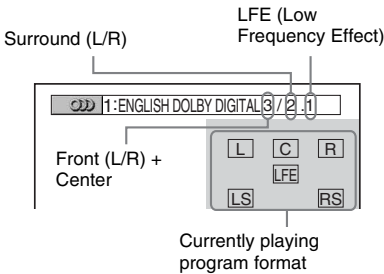

Example:

Dolby Digital 3 ch

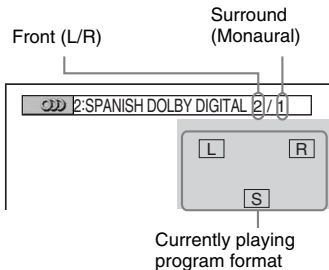

■ When playing a DATA CD (DivX video) or DATA DVD (DivX video)

Example:

MP3 audio

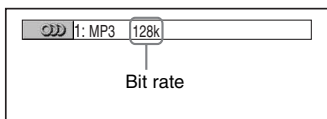

About audio signals

Audio signals recorded in a disc contain the sound elements (channels) shown below. Each channel is output from a separate speaker.

- Front (L)
- Front (R)
- Center
- Surround (L)
- Surround (R)
- Surround (Monaural): This signal can be either the Dolby Surround Sound processed signals or the Dolby Digital sound's monaural Surround audio signals.
- LFE (Low Frequency Effect) signal

Selecting [ORIGINAL] or [PLAY LIST] on a DVD-R/DVD-RW

DVD-VR

Some DVD-Rs/DVD-RWs in VR (Video Recording) mode have two types of titles for playback: originally recorded titles ([ORIGINAL]) and titles that can be created on recordable DVD players for editing ([PLAY LIST]). You can select the type of title to be played.

- 1 Press **DISPLAY** when the system is in stop mode.

The Control Menu appears.

- 2 Press **↑/↓** to select **[ORIGINAL/PLAY LIST]**, then press **+**.

The options for [ORIGINAL/PLAY LIST] appear.

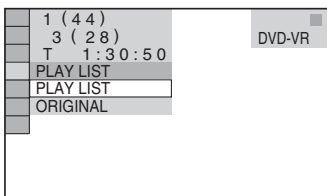

- 3 Press **↑/↓** to select a setting.

The default setting is underlined.

- **[PLAY LIST]**: plays the titles created from [ORIGINAL] for editing.
- **[ORIGINAL]**: plays the titles originally recorded.

- 4 Press **+**.

Viewing Information About the Disc

DVD-V

DVD-VR

VIDEO CD

Super Audio CD

CD

DATA CD

DATA DVD

Viewing the playing time and remaining time in the front panel display

You can check disc information, such as the remaining time, total number of titles in a DVD, tracks in a VIDEO CD, Super Audio CD, CD, or MP3, file name of a DivX video using the front panel display (page 100).

Press DISPLAY.

Each time you press DISPLAY while playing the disc, the display changes ① → ② → ... → ① → ...

Some displayed items may disappear after a few seconds.

When playing a DVD VIDEO or DVD-R/DVD-RW

- ① Playing time and number of the current title
- ② Remaining time of the current title
- ③ Playing time and number of the current chapter
- ④ Remaining time of the current chapter
- ⑤ Disc name
- ⑥ Title and chapter

When playing a DATA CD (DivX video) or DATA DVD (DivX video)

- ① Playing time of the current file
- ② Current file name
- ③ Current album and file number

When playing a VIDEO CD (without PBC functions), Super Audio CD, or CD

- ① Playing time of the current track
- ② Remaining time of the current track
- ③ Playing time of the disc
- ④ Remaining time of the disc
- ⑤ Disc name
- ⑥ Track and index*

* VIDEO CD only.

When playing a DATA CD (MP3 audio) or DATA DVD (MP3 audio)

- ① Playing time and current track number
- ② Track (file) name

Tip

• When playing VIDEO CDs with PBC functions, the playing time is displayed.

Note

- The system can only display the first level of the DVD/CD text, such as the Disc name or title.
- If an MP3 file name cannot be displayed, “**” will appear in the front panel display instead.
- The disc name or track name may not be displayed depending on the text.
- Playing time of MP3 audio tracks and DivX video files may not be displayed correctly.

Checking the playing time and remaining time

You can check the playing time and remaining time of the current title, chapter, or track, and the total playing time or remaining time of the disc. You can also check the DVD text and MP3 folder name/file name recorded on the disc.

1 Press DISPLAY during playback.

The following display appears.

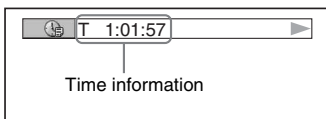

2 Press DISPLAY repeatedly to change the time information.

The display and the kinds of time that you can check depend on the disc you are playing.

■ When playing a DVD VIDEO or DVD-RW

- T **.*:*.**
Playing time of the current title
- T_**.*:*.**
Remaining time of the current title
- C **.*:*.**
Playing time of the current chapter

- C_**.*:*.**

Remaining time of the current chapter

■ When playing a VIDEO CD (with PBC functions)

- **.*:*.**

Playing time of the current scene

■ When playing a VIDEO CD (without PBC functions), Super Audio CD, or CD

- T **.*:*.**

Playing time of the current track

- T_**.*:*.**

Remaining time of the current track

- D **.*:*.**

Playing time of the current disc

- D_**.*:*.**

Remaining time of the current disc

■ When playing a DATA CD (MP3 audio) or DATA DVD (MP3 audio)

- T **.*:*.**

Playing time of the current track

■ When playing a DATA CD (DivX video) or DATA DVD (DivX video)

- **.*:*.**

Playing time of the current file

Note

- Only alphabetical letters and numbers can be displayed.
- Depending on the type of disc being played, the system can only display a limited number of characters. Also, depending on the disc, not all text characters will be displayed.

Checking the play information of the disc

To check DVD/Super Audio CD/CD text

Press DISPLAY repeatedly in Step 2 to display text recorded on the DVD/Super Audio CD/CD. The DVD/Super Audio CD/CD text appears only when text is recorded in the disc. You cannot change the text. If the disc does not contain text, "NO TEXT" appears.

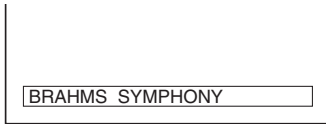

To check DATA CD/DATA DVD (MP3 audio/DivX video) text

By pressing DISPLAY while playing MP3 audio tracks or DivX video files on a DATA CD/DATA DVD, you can display the name of the album/track/file, and the audio bit rate (the amount of data per second of the current audio) on your TV screen.

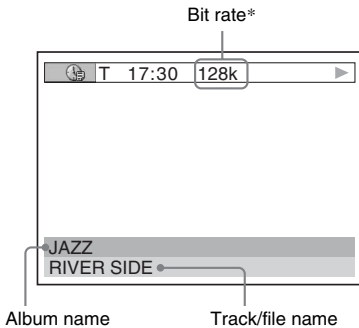

* Appears when:

- playing an MP3 audio track on DATA CDs/DATA DVDs.
- playing a DivX video file that contains MP3 audio signals on DATA CDs/DATA DVDs.

Checking the date information

(JPEG only)

You can check the date information during playback when the Exif* tag is recorded in the JPEG image data.

Press **DISPLAY** twice during playback.

The Control Menu appears.

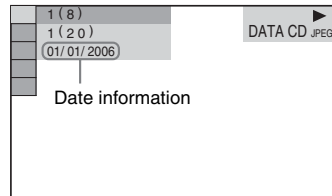

* "Exchangeable Image File Format" is a digital camera image format defined by the Japan Electronics and Information Technology Industries Association (JEITA).

Tip

• Date information is [DD/MM/YYYY].

DD: Day

MM: Month

YYYY: Year

Changing the Angles

DVD-V

If various angles (multi-angles) for a scene are recorded on a DVD VIDEO, you can change the viewing angle.

Press ANGLE during playback.

Each time you press ANGLE, the angle changes.

Note

- Depending on the DVD VIDEO, you may not be able to change the angle even if multi-angles are recorded on the DVD VIDEO.

Displaying the Subtitles

DVD-V

DVD-VR

DATA-CD

DATA DVD

If subtitles are recorded on a disc, you can turn the subtitles on or off while playing. If multilingual subtitles are recorded on the disc, you can change the subtitle language while playing, or turn the subtitles on or off whenever you want.

Press SUBTITLE during playback.

Each time you press SUBTITLE, the subtitle language changes.

Note

- Depending on the DVD VIDEO, you may not be able to change the subtitles even if multilingual subtitles are recorded on it. You also may not be able to turn them off.
- You can change the subtitles if the DivX video file has an “.AVI” or “.DIVX” extension and contains subtitle information within the same file.

Adjusting the Delay Between the Picture and Sound

(A/V SYNC)

DVD-V DVD-VR VIDEO CD DATA-CD DATA DVD

When the sound does not match the pictures on the screen, you can adjust the delay between the picture and sound.

1 Press **DISPLAY** when the system is in stop mode.

The Control Menu appears.

2 Press **↑/↓** to select **[A/V SYNC]**, then press **+**.

The options for [A/V SYNC] appear.

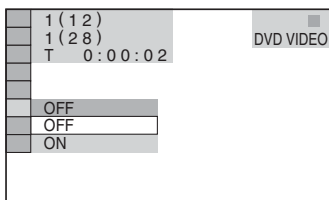

3 Press **↑/↓** to select the setting you want and press **+**.

The default setting is underlined.

- [OFF]: does not adjust.
- [ON]: adjusts the difference between picture and sound.

The selected setting takes effect.

Note

- Depending on the input stream, this function may not be effective.
- Depending on the sound field, this function may not be effective.

Selecting a Playback Area for a Super Audio CD

Super Audio CD

Selecting a playback area on a 2 channel + Multi-channel Super Audio CD

Some Super Audio CDs consist of a 2 channel playback area and a multi-channel playback area. You can select the playback area you want to listen to.

1 Press **DISPLAY** when the system is in stop mode.

The Control Menu appears.

2 Press **↑/↓** to select **[MULTI/2CH]**, then press **+**.

The options for [MULTI/2CH] appear.

3 Press **↑/↓** to select the setting you want and press **+**.

- [MULTI]: plays the multi-channel playback area.
- [2CH]: plays the 2 channel playback area. "MULTI" lights up in the front panel display when playing the multi-channel playback area.

Note

- You cannot change the playback area during playback.

Selecting a playback layer when playing a hybrid Super Audio CD

Some Super Audio CDs consist of an HD layer and a CD layer. You can select the playback layer you want to listen to.

Press SA-CD/CD when the system is in stop mode.

Each time you press the button, an HD layer or a CD layer is alternately selected. When playing a CD layer, "CD" lights up in the front panel display.

Note

- Each play mode function works only within the selected layer or playback area.
- When you select a CD layer, you cannot change a playback area.
- Super Audio CD audio signals are not output from the HDMI OUT (high-definition multimedia interface out) jack.

About MP3 Audio Tracks and JPEG Image Files

DATA-CD **DATA DVD**

What is MP3/JPEG?

MP3 is audio compression technology that satisfies the ISO/MPEG regulations. JPEG is image compression technology.

Discs that the system can play

You can play back DATA CDs (CD-ROMs/CD-Rs/CD-RWs) or DATA DVDs (DVD-Rs/DVD-RWs/DVD+Rs/DVD+RWs/DVD-ROMs) recorded in MP3 (MPEG1 Audio Layer 3) or JPEG format. However, the DATA CDs must be recorded according to ISO 9660 Level 1, Level 2 or Joliet format and DATA DVDs of Universal Disk Format (UDF) for the system to recognize the tracks (or files). You can also play discs recorded in Multi Session.

See the instructions supplied with the CD-R/CD-RW or DVD-R/DVD-RW drives and the recording software (not supplied) for details on the recording format.

About the Multi-Session disc

If MP3 audio tracks or JPEG image files are recorded in the first session, the system will also play MP3 audio tracks or JPEG image files in other sessions. If audio tracks and images in audio CD format or video CD format are recorded in the first session, only the first session will be played back.

Note

- The system may not be able to play some DATA CDs/DATA DVDs created in the Packet Write format.

MP3 audio track or JPEG image file that the system can play

The system can play the MP3 audio tracks or JPEG image files:

continued

- which have the extension “.MP3” (MP3 audio track) or “.JPG”/“.JPEG” (JPEG image file)
 - which conform to the DCF* image file format
- * “Design rule for Camera File system”: Image standards for digital cameras regulated by Japan Electronics and Information Technology Industries Association (JEITA).

Note

- The system will play any data with the extension “.MP3,” “.JPG,” or “.JPEG” even if they are not in MP3 or JPEG format. Playing this data may generate a loud noise which could damage your speaker system.
- The system does not conform to audio in MP3PRO format.

Playback order of MP3 audio tracks or JPEG image files

The playback order of MP3 audio tracks or JPEG image files recorded on a DATA CD or DATA DVD is as follows:

■ Structure of disc contents

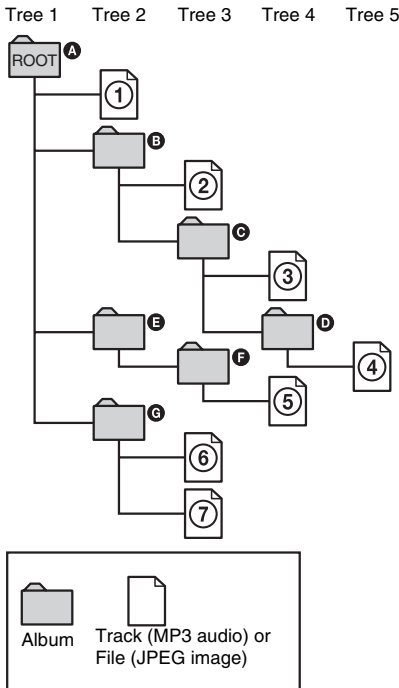

When you insert a DATA CD or DATA DVD and press \triangleright , the numbered tracks (or files) are played sequentially, from ① through ⑦. Any sub-albums/tracks (or files) contained within a currently selected album take priority over the next album in the same tree. (Example: C contains D so ④ is played before ⑤.)

When you press MENU and the list of album names appears (page 57), the album names are arranged in the following order:

A → B → C → D → F → G. Albums that do not contain tracks (or files) (such as album E) do not appear in the list.

Tip

- If you add numbers (01, 02, 03, etc.) to the front of the track (or file) names when you store the tracks (or files) in a disc, the tracks (or files) will be played in that order.
- A disc with many trees takes longer to start playback.

Note

- Playback order may differ from the illustration depending on the software you use to create the DATA CD or DATA DVD, or if there are more than 200 albums and 300 files in each album.
- The system can recognize up to 200 albums, and will not play any albums beyond the 200th.
- The system may take longer time to playback, when progressing to the following album or jump to other album.
- Some type of JPEG files cannot be played.

Playing DATA CDs or DATA DVDs with MP3 Audio Tracks and JPEG Image Files

DATA-CD DATA DVD

Selecting an MP3 audio track or album

1 Load a DATA CD or DATA DVD.

The albums recorded on the DATA CD or DATA DVD appear. When an album is being played, its title is shaded.

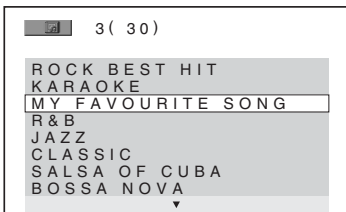

2 Press \uparrow/\downarrow to select an album.

■ When selecting an album

Press \triangleright to start playing the selected album.

■ When selecting a track

Press \oplus .

The list of tracks contained in the album appears.

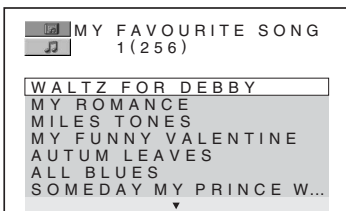

Press \uparrow/\downarrow to select a track and press \oplus .

The selected track starts playing. You can turn the track list off by pressing MENU.

Pressing MENU again will display the album list.

To stop playback

Press \blacksquare .

To play the next or previous MP3 audio track

Press \lll/\ggg . Note that you can select the next album by continuing to press \ggg after the last track on the current album, but that you cannot return to the previous album by pressing \lll . To return to the previous album, select the album from the album list.

To return to the previous display

Press \curvearrowright RETURN.

To turn off the display

Press MENU.

Selecting a JPEG image file or album

1 Load a DATA CD or DATA DVD.

The albums recorded on the DATA CD or DATA DVD appear. When an album is being played, its title is shaded.



2 Press \uparrow/\downarrow to select an album.

■ When selecting an album

Press \triangleright to start playing the selected album.

■ When selecting an image

Press PICTURE NAVI.

Images of files in the album appear in 16 subscreens.

1	2	3	4	
5	6	7	8	
9	10	11	12	
13	14	15	16	

Press ←/↑/↓/→ to select the image you want to view and press ⊕.

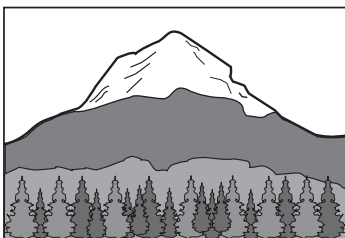

To play the next or previous JPEG image file

Press ←/→ when the Control Menu is not displayed. Note that you can select the next album by continuing to press → after the last image on the current album, but that you cannot return to the previous album by pressing ←. To return to the previous album, select the album from the album list.

To rotate a JPEG image

When a JPEG image file is displayed on the screen, you can rotate the image by 90 degrees. Press ↑/↓ while viewing an image. Each time you press ↑, the image rotates counterclockwise by 90 degrees.

Example of when you press ↑ once:

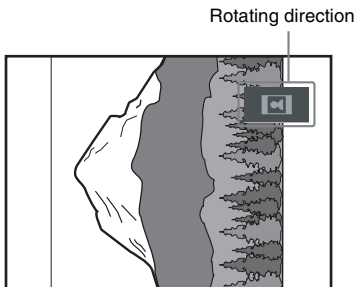

Press CLEAR to return to normal view.

To stop playback

Press ■.

Tip

- A scroll box is displayed at the right side of the screen. To display the additional image files, select the bottom image and press ↓. To return to the previous image, select the top image and press ↑.

Playing Audio Tracks and Images as a Slide Show with Sound

DATA-CD DATA DVD

You can play a slide show with sound by first placing both MP3 and JPEG files in the same album on a DATA CD or DATA DVD. When you play back the DATA CD or DATA DVD, select [AUTO] mode as explained below.

- 1 Load a DATA CD or DATA DVD.**
- 2 Press  DISPLAY when the system is in stop mode.**

The Control Menu appears.

- 3 Press \uparrow/\downarrow to select  [MODE (MP3, JPEG)], then press \oplus .**

The options for [MODE (MP3, JPEG)] appear.

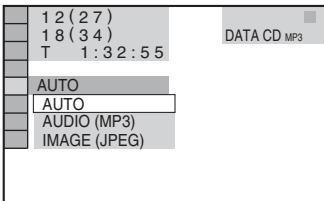

- 4 Press \uparrow/\downarrow to select the setting you want and press \oplus .**

The default setting is underlined.

- [AUTO]: plays both the JPEG image files and MP3 audio tracks in the same album as a slide show.
- [AUDIO (MP3)]: plays only MP3 audio tracks continuously.
- [IMAGE (JPEG)]: plays only JPEG image files as a slide show.

- 5 Press MENU.**

The list of albums recorded on the DATA CD or DATA DVD appears.

- 6 Press \uparrow/\downarrow to select the album you want and press \triangleright .**

The system starts playing the selected album.

You can turn the album list on and off by pressing MENU repeatedly.

Tip

- When you select [AUTO], the system can recognize up to 300 MP3 tracks and 300 JPEG files in a single album. When you select [AUDIO (MP3)] or [IMAGE (JPEG)], the system can recognize up to 600 MP3 and 600 JPEG files in a single album. A maximum of 200 albums can be recognized regardless of the selected mode.

Note

- If you set [MODE (MP3, JPEG)] to [IMAGE (JPEG)] on a disc that contains MP3 tracks only or [AUDIO (MP3)] on a disc that contains JPEG files only, you may not be able to change the [MODE (MP3, JPEG)] setting.
- PICTURE NAVI does not work when [AUDIO (MP3)] is selected.
- If you play large MP3 track data and JPEG image data at the same time, the sound may skip. It is recommended that you set the MP3 bit rate to 128 kbps or lower when creating the file. If the sound still skips, then reduce the size of the JPEG file.

Specifying the slide show duration (JPEG only)

When you play JPEG image files using slide show, you can specify the duration for slides to appear on the screen.

- 1 Press  DISPLAY twice.**

The Control Menu for JPEG appears.

- 2 Press \uparrow/\downarrow to select  [INTERVAL], then press \oplus .**

The options for [INTERVAL] appear.

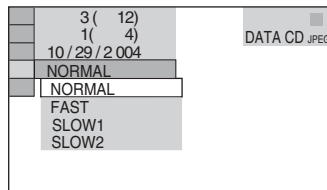

- 3 Press \uparrow/\downarrow to select the setting you want.**

The default setting is underlined.

continued

- [NORMAL]: sets the duration to about 6 to 9 seconds. (Images that are four million pixels or more will lengthen the duration.)
- [FAST]: sets the duration shorter than [NORMAL].
- [SLOW1]: Sets the duration longer than [NORMAL].
- [SLOW2]: Sets the duration longer than [SLOW1].

4 Press \oplus .

The selected setting takes effect.

Note

- Some JPEG files may take longer to display than others, which may make the duration seems longer than the option you selected. Especially progressive JPEG files or JPEG files of 3,000,000 pixels or more.

Selecting an effect for image files in the slide show (JPEG only)

When you play a JPEG image file, you can select the effect to be used when viewing the slide show.

1 Press ☰ DISPLAY twice.

The Control Menu for JPEG appears.

2 Press \uparrow/\downarrow to select ☰ [EFFECT], then press \oplus .

The options for [EFFECT] appear.

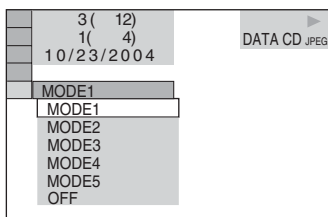

3 Press \uparrow/\downarrow to select the setting you want.

The default setting is underlined.

- [MODE1]: The image sweeps in from top to bottom.
- [MODE2]: The image stretches out from left to right of the screen.
- [MODE3]: The image stretches out from the center of the screen.

- [MODE4]: The images randomly cycle through the effects.
- [MODE5]: The next image slides over the previous image.
- [OFF]: Turns off this function.

4 Press \oplus .

The selected setting takes effect.

Enjoying DivX[®] Videos

DATA-CD DATA DVD

About DivX Video Files

DivX[®] is a video file compression technology, developed by DivX, Inc. This product is an official DivX[®] Certified product. You can play DATA CDs and DATA DVDs that contain DivX[®] video files.

DATA CDs and DATA DVDs that the system can play

Playback of DATA CDs (CD-ROMs/CD-Rs/CD-RWs) and DATA DVDs (DVD-ROMs/DVD-Rs/DVD-RWs/DVD+Rs/DVD+RWs) on this system is subject to certain conditions:

- With DATA CDs/DATA DVDs that contain DivX video files in addition to MP3 audio tracks or JPEG image files, the system plays only the DivX video files.

However, this system only plays DATA CDs whose logical format is ISO 9660 Level 1/Level 2 or Joliet, and DATA DVDs of Universal Disk Format (UDF).

Refer to the instructions supplied with the disc drives and the recording software (not supplied) for details on the recording format.

About playback order of data on DATA CDs or DATA DVDs

See “Playback order of MP3 audio tracks or JPEG image files” (page 56). Note that the playback order may not be applicable, depending on the software used for creating the DivX video file, or if there are more than 200 albums and 600 DivX video files in each album.

Note

- The system may not be able to play some DATA CDs/DATA DVDs created in the Packet Write format.

DivX video files that the system can play

The system can play data that is recorded in DivX format, and which has the extension “.AVI,” or “.DIVX.” The system will not play

files with the extension “.AVI” or “.DIVX” if they do not contain a DivX video.

Tip

- For details about playable MP3 audio tracks or JPEG image files on DATA CDs or DATA DVDs, see “Discs that the system can play” (page 55).

Note

- The system may not play a DivX video file when the file has been combined from two or more DivX video files.
- The system cannot play a DivX video file of size more than 720 (width) × 576 (height) or 2GB.
- Depending on the DivX video file, sound may skip or not match the pictures on the screen.
- The system cannot play some DivX video files that are longer than 3 hours.
- Depending on the DivX video file, the picture may pause or be unclear. In which case, it is recommended that you create the file at a lower bit rate. If the sound is still noisy, MP3 is the recommended audio format. Note, however, this system does not conform to WMA (Windows Media Audio) format.
- Because of the compression technology used for DivX video files, it may take some time after you press \triangleright for the picture to appear.

Selecting an album

1 Press MENU.

A list of albums on the disc appears. Only albums that contain DivX video files are listed.

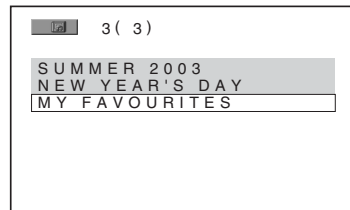

2 Press \uparrow/\downarrow to select the album you want to play.

3 Press \triangleright .

The system starts playing the selected album.

To select DivX video files, see “Selecting a DivX video file” (page 62).

continued

To go to the next or previous page

Press ←/→.

To turn off the display

Press MENU repeatedly.

To stop playback

Press ■.

Tip

- If the number of viewing times is preset, you can play the DivX video files as many times as the preset number. The following occurrences are counted:
 - when the system is turned off.
 - when another file is played.
 - when the disc tray is opened.

Selecting a DivX video file

1 After Step 2 of “Selecting an album,” press ⊕.

The list of files in the album appears.

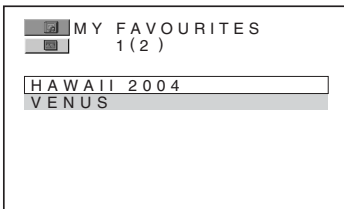

2 Press ↑/↓ to select a file and press ⊕.

The selected file starts playing.

To go to the next or previous page

Press ←/→.

To return to the previous display

Press ↶ RETURN.

To stop playback

Press ■.

To play the next or previous DivX video file without turning on the above file list

You can select the next or previous DivX video file in the same album by pressing ◀◀/▶▶.

You can also select the first file of the next album by pressing ▶▶ during playback of the last file of the current album. Note that you cannot return to the previous album by pressing ◀◀. To return to the previous album, select it from the album list.

Playing VIDEO CDs with PBC Functions (Ver.2.0)

(PBC Playback)

VIDEO CD

With PBC (Playback Control) functions, you can enjoy simple interactive operations, search functions, and other such operations. PBC playback allows you to play VIDEO CDs interactively by following the menu on the TV screen.

- 1 Start playing a VIDEO CD with PBC functions.**
The menu for your selection appears.
- 2 Select the item number you want by the number buttons.**
- 3 Press \oplus .**
- 4 Follow the instructions in the menu for interactive operations.**

Refer to the operation details supplied with the disc, as the operating procedure may differ depending on the VIDEO CD.

To go back to the menu

Press \hookrightarrow RETURN.

Note

- Depending on the VIDEO CD, [Press ENTER] in Step 3 may appear as [Press SELECT] in the instructions supplied with the disc. In this case, press \triangleright .

Tip

- To play without using PBC, press \lll/\ggg or the number buttons while the system is stopped to select a track, then press \triangleright or \oplus . The system starts continuous play. You cannot play still pictures such as a menu. To return to PBC playback, press \blacksquare twice, then press \triangleright .

Tuner Functions

Presetting Radio Stations

You can preset 20 FM stations, and 10 AM stations. Before tuning, make sure to turn down the volume to minimum.

1 Press **FUNCTION +/-** repeatedly until **“TUNER FM”** or **“TUNER AM”** appears in the front panel display.

2 Press and hold **TUNING +** or **-** until the auto scanning starts.

Scanning stops when the system tunes in a station. **“TUNED”** and **“ST”** (for stereo program) appear in the front panel display.

3 Press **MENU**.

4 Press **↑/↓** repeatedly until **“MEMORY”** appears in the front panel display.

5 Press **⊕**.

A preset number appears in the front panel display.



6 Press **↑/↓** to select the preset number you want.



7 Press **⊕**.

The station is stored.



8 Repeat 1 to 7 to store other stations.

To change the preset number

Restart from Step 1.

Listening to the Radio

Preset radio stations in the system's memory first (see "Presetting Radio Stations" (page 64)).

1 Press **FUNCTION +/-** repeatedly until **“TUNER FM”** or **“TUNER AM”** appears in the front panel display.

The last received station is tuned in.

2 Press **PRESET +** or **-** repeatedly to select the preset station you want.

Each time you press the button, the system tunes in one preset station.

3 Adjust the volume by pressing **VOLUME +/-**.

To turn off the radio

Press **I/⏻**.

To listen to non-preset radio stations

Use manual or automatic tuning in Step 2. For manual tuning, press **TUNING +** or **-** repeatedly.

For automatic tuning, press and hold **TUNING +** or **-**. The automatic tuning stops automatically when the system receives the radio station. To stop the automatic tuning manually, press **TUNING +** or **-**.

To listen to radio stations when you know the frequencies

Use direct tuning in Step 2.

1 Press **D.TUNING**.

2 Press the number buttons to select the frequency number you want to listen to.

3 Press **⊕**.

Tip

- If an FM program is noisy, press **MENU**, and select **“FM MODE”** by pressing **↑/↓**, then press **⊕**. Press **↑/↓** to select **“MONO,”** then press **⊕**. There will be no stereo effect, but the reception will improve. To restore the stereo effect, select **“STEREO.”**
- To improve reception, reorient the supplied antennas (aerials).

Naming preset stations

You can enter a name for preset stations. These names (for example, “XYZ”) appear in the system’s front panel display when a station is selected.

Note that no more than one name can be entered for each preset station.

Note

- You cannot enter a name for preset stations of the Radio Data System (RDS) (page 66).

1 Press FUNCTION +/- repeatedly until “TUNER FM” or “TUNER AM” appears in the front panel display.

The last received station is tuned in.

2 Press PRESET + or – repeatedly to select the preset station you want to create an index name for.

3 Press MENU.

4 Press ↑/↓ repeatedly until “NAME IN” appears in the front panel display.

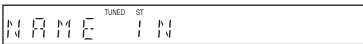

5 Press ⊕.

6 Create a name by using the cursor buttons.

Press ↑/↓ to select a character, then press → to move the cursor to the next position.

Letters, numbers, and other symbols can be input for a radio station name.

If you make a mistake

Press ←/→ repeatedly until the character to be changed flashes, then press ↑/↓ to select the desired character.

To erase the character, press ←/→ repeatedly until the character to be erased flashes, then press CLEAR.

7 Press ⊕.

“COMPLETE” appears in the front panel display, and the station name is stored.

Tip

- You can check the frequency by pressing DISPLAY repeatedly (page 65).

Viewing the station name or frequency in the front panel display

When the system is set to “TUNER AM” or “TUNER FM,” you can check the frequency using the front panel display.

Press DISPLAY.

Each time you press DISPLAY, the display changes as shown.

- ① Station name*
- ② Frequency**

* This is displayed if you have entered a name for a preset station.

** Returns to the original display when several seconds has elapsed.



Using the Radio Data System (RDS)

What is the Radio Data System?

The Radio Data System (RDS) is a broadcasting service that allows radio stations to send additional information along with the regular program signal. This tuner offers convenient RDS features, such as station name display. RDS is available only for FM stations.*

Note

- RDS may not work properly if the station you are tuned to is not transmitting the RDS signal properly, or if the signal strength is weak.
- * Not all FM stations provide RDS service, nor do they provide the same type of services. If you are not familiar with the RDS system, check with your local radio stations for details on RDS services in your area.

Receiving RDS broadcasts

Simply select a station from the FM band.

When you tune in a station that provides RDS services, the station name* appears in the front panel display.

- * If an RDS broadcast is not received, the station name may not appear in the front panel display.

Other Operations

Controlling the TV with the Supplied Remote

By adjusting the remote signal, you can control your TV with the supplied remote.

Note

- When you replace the batteries of the remote, the code number may reset itself to the default (SONY) setting. Reset the appropriate code number.

Controlling TVs with the remote

Press and hold TV I/⏻ while entering your TV's manufacturer's code (see the table) using the number buttons. Then release TV I/⏻.

If you set successfully the manufacturer's code, the TV button flashes twice slowly. If the setting is unsuccessful, the TV button flashes 5 times quickly.

Code numbers of controllable TVs

If more than one code number is listed, try entering them one at a time until you find the one that works with your TV.

TV

Manufacturer	Code number
SONY/AIWA	501 (default)
DAEWOO	503, 506, 515, 544
FISHER	508, 545
GOLDSTAR/LG	503, 515, 517, 544, 568
GRUNDIG	533
HITACHI	503, 514, 515, 517, 544, 557
ITT/NOKIA	521, 522
JVC	516
LOEWE	515
MAGNAVOX	503, 515, 517, 518, 544, 566
MITSUBISHI/MGA	503, 527, 544, 566, 568
PANASONIC	509, 553, 572
PHILIPS	518, 557, 558
PIONEER	509, 525, 551

Manufacturer	Code number
RCA/PROSCAN	503, 510, 544
SAMSUNG	515, 517, 544, 557, 566, 569, 574
SANYO	508, 545, 567
SHARP	517, 535, 565
TELEFUNKEN/ SABA	530, 537, 547, 549, 558
THOMSON	530, 537, 547, 549
TOSHIBA	535, 541, 551
ZENITH	543, 567

CATV

Manufacturer	Code number
SONY	821, 824, 825
HAMLIN/REGAL	836, 837, 838, 839, 840
JERROLD	830, 831
JERROLD/GI	806, 807, 808, 809, 810, 811, 812, 813, 814
OAK	841, 842, 843
PANASONIC	816, 826, 832, 833, 834, 835
PIONEER	828, 829
SCIENTIFIC ATLANTA	815, 816, 817, 844
TOCOM/PHILIPS	830, 831
ZENITH	826, 827

To control the TV

You can control the TV by using following buttons.

By pressing	You can
TV I/⏻	Turn the TV on or off.
TV/VIDEO	Switch the TV's input source between the TV and other input sources.
TV VOL +/-*	Adjust the TV volume.
TV CH +/-*	Select the TV channel.
Number buttons*	Select the TV channel.

* To use these buttons while in the TV mode (the TV button flashes), press the TV button.

-/- is for selecting a channel number greater than 10. (For example, for channel 25, press -/-, then 2 and 5.)

Note

- Depending on the TV, you may not be able to control your TV or to use some of the buttons above.
- The TV mode turns off when you do not operate the remote for 10 seconds.

Using the THEATRE SYNC Function

THEATRE SYNC allows you to turn on your SONY TV and this system, changes the system mode to “DVD,” and then switches the TV’s input source you set with one button push.

Preparing for the THEATRE SYNC function

Register the TV’s input source connected to this system.

Press and hold TV/VIDEO while entering the code for the TV’s input source connected to this system (see the table) using the number buttons.

The TV’s input source is selected.

If you successfully set the TV’s input source code, the TV button flashes twice slowly. If the setting is unsuccessful, the TV button flashes 5 times quickly.

Set your TV’s input to the input you used to connect the system. For details, see the instructions of your TV.

By pressing	Number	TV’s input source
TV/VIDEO	0	No input source (Default)
	1	VIDEO1
	2	VIDEO2
	3	VIDEO3
	4	VIDEO4
	5	VIDEO5
	6	VIDEO6
	7	VIDEO7
	8	VIDEO8
	9*	COMPONENT 1
	CLEAR*	COMPONENT 2
	PICTURE NAVI*	COMPONENT 3
	AUDIO*	COMPONENT 4
	SUBTITLE*	HDMI 1
	ANGLE*	HDMI 2
	SOUND	HDMI 3
	FIELD*	

Using the Sound Effect

Reinforcing bass frequencies

You can reinforce bass frequencies.

Press DYNAMIC BASS.

Bass frequencies are effectively reinforced.

To turn off the sound effect

Press DYNAMIC BASS again.

By pressing	Number	TV's input source
	MOVIE/ MUSIC*	HDMI 4
	DYNAMIC BASS*	HDMI 5

* Except for North American models.

Operating for the THEATRE SYNC function

Point the remote to the direction of TV and this system, then press THEATRE SYNC once.

While transmitting the code from the remote, the TV button flashes.

If this function does not work, change the transmit time. The transmit time varies depending on the TV.

To change the transmit time

Press and hold TV CH +* while entering the code for transmit time (see the table) using the number buttons.

The transmit time from the remote is selected. If you successfully set the transmit time code, the TV button flashes twice slowly. If the setting is unsuccessful, the TV button flashes 5 times quickly.

* Functions as both TV CH + and FUNCTION + button.

By pressing	Number	Transmit time
TV CH +	1	0.5 (Default)
	2	1
	3	1.5
	4	2
	5	2.5
	6	3
	7	3.5
	8	4

Note

- This function is only for SONY TVs. (This function may not work on some SONY TVs.)
- If distance between TV and this system is too far, this function may not work. Install the system near the TV.
- Keep the remote pointed in the direction of the TV and this system while the TV button is flashing.
- Keep the remote pointed in the direction of the TV and this system while entering the code.

Advanced Settings and Adjustments

Locking Discs

(CUSTOM PARENTAL CONTROL, PARENTAL CONTROL)

DVD-V

VIDEO CD

Super Audio CD

C D

You can set 2 kinds of playback restrictions for the desired disc.

- Custom Parental Control

You can set playback restrictions so that the system will not play inappropriate discs.

- Parental Control

Playback of some DVD VIDEOS can be limited according to a predetermined level such as the age of the users. Scenes may be blocked or replaced with different scenes.

The same password is used for both Custom Parental Control and Parental Control.

Preventing playback of specific discs [CUSTOM PARENTAL CONTROL]

You can set the same Custom Parental Control password for up to 40 discs. When you set the 41st-disc, the first disc is canceled.

1 Insert the disc you want to lock.

If the disc is playing, press ■ to stop playback.

2 Press DISPLAY while the system is in stop mode.

The Control Menu appears.

3 Press \uparrow/\downarrow to select [PARENTAL CONTROL], then press

\oplus .

The options for [PARENTAL CONTROL] appear.

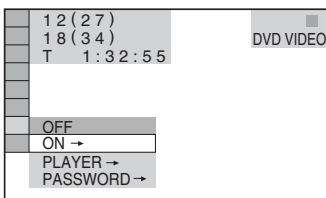

4 Press \uparrow/\downarrow to select [ON →], then press \oplus .

■ If you have not entered a password

The display for registering a new password appears.

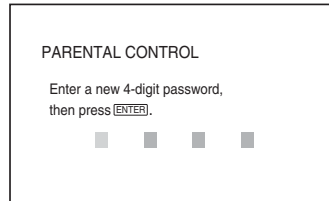

Enter a 4-digit password using the number buttons, then press \oplus .

The display for confirming the password appears.

■ When you have already registered a password

The display for entering the password appears.

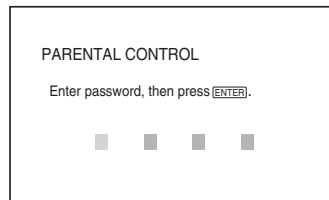

5 Enter or re-enter your 4-digit password using the number buttons, then press \oplus .

[Custom parental control is set.] appears and the screen returns to the Control Menu.

To turn off the Custom Parental Control function

1 Follow steps 1 through 3 of "Preventing playback of specific discs [CUSTOM PARENTAL CONTROL]."

2 Press \uparrow/\downarrow to select [OFF →], then press \oplus .

3 Enter your 4-digit password using the number buttons, then press \oplus .

To play a disc for which Custom Parental Control is set

- 1 Insert the disc for which Custom Parental Control is set.

The [CUSTOM PARENTAL CONTROL] display appears.

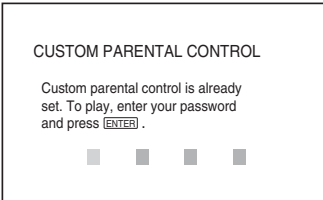

- 2 Enter your 4-digit password using the number buttons, then press (+).

The system is ready for playback.

Tip

- If you forget your password, enter the 6-digit number "199703" using the number buttons when the [CUSTOM PARENTAL CONTROL] display asks you for your password, then press (+). The display will ask you to enter a new 4-digit password.

Limiting playback for children [PARENTAL CONTROL] (DVD only)

Playback of some DVD VIDEOS can be limited according to a predetermined level such as the age of the users. The [PARENTAL CONTROL] function allows you to set a playback limitation level.

- 1 Press (DISPLAY) while the system is in stop mode.

The Control Menu appears.

- 2 Press (UP/DOWN) to select (PARENTAL CONTROL), then press (+).

The options for [PARENTAL CONTROL] appear.

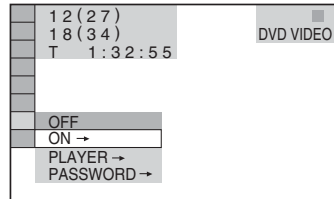

- 3 Press (UP/DOWN) to select [PLAYER ->], then press (+).

■ If you have not entered a password
The display for registering a new password appears.

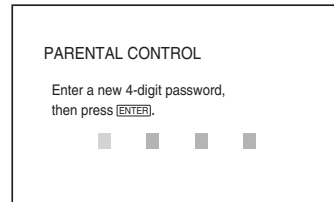

Enter a 4-digit password using the number buttons, then press (+).

The display for confirming the password appears.

■ When you have already registered a password

The display for entering the password appears.

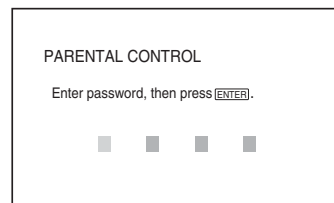

- 4 Enter or re-enter your 4-digit password using the number buttons, then press (+).

The display for setting the playback limitation level appears.

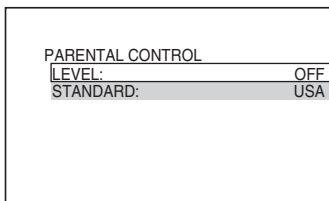

5 Press \uparrow/\downarrow to select [STANDARD], then press \oplus .

The selection items for [STANDARD] are displayed.

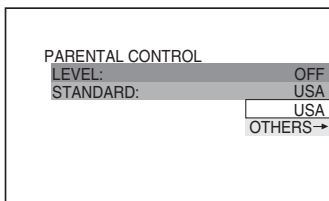

6 Press \uparrow/\downarrow to select a geographic area as the playback limitation level, then press \oplus .

The area is selected.

When you select [OTHERS \rightarrow], select and enter a standard code in the table of "Parental Control Area Code List" (page 98) using the number buttons.

7 Press \uparrow/\downarrow to select [LEVEL], then press \oplus .

The selection items for [LEVEL] are displayed.

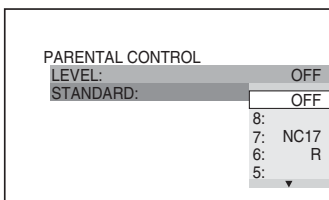

8 Press \uparrow/\downarrow to select the level you want, then press \oplus .

Parental Control setting is complete.

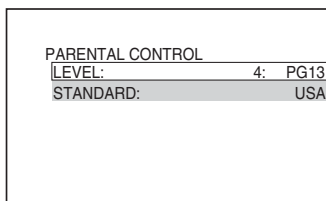

The lower the value, the stricter the limitation.

To turn off the Parental Control function

Set [LEVEL] to [OFF] in Step 8.

To play a disc for which Parental Control is set

1 Insert the disc and press \triangleright .

The display for entering your password appears.

2 Enter your 4-digit password using the number buttons, then press \oplus .

The system starts playback.

Tip

- If you forget your password, remove the disc and repeat steps 1 to 3 of "Preventing playback of specific discs [CUSTOM PARENTAL CONTROL]." When you are asked to enter your password, enter "199703" using the number buttons, then press \oplus . The display will ask you to enter a new 4-digit password. After you enter a new 4-digit password, replace the disc in the system and press \triangleright . When the display for entering your password appears, enter your new password.

Note

- When you play discs which do not have the Parental Control function, playback cannot be limited on this system.
- Depending on the disc, you may be asked to change the parental control level while playing the disc. In this case, enter your password, then change the level. If the Resume Play mode is canceled, the level returns to the previous level.

Changing the password

- 1 Press **DISPLAY** while the system is in stop mode.

The Control Menu appears.

- 2 Press **↑/↓** to select **[PARENTAL CONTROL]**, then press **+**.

The options for [PARENTAL CONTROL] appear.

- 3 Press **↑/↓** to select **[PASSWORD →]**, then press **+**.

The display for entering the password appears.

- 4 Enter your 4-digit password using the number buttons, then press **+**.

- 5 Enter a new 4-digit password using the number buttons, then press **+**.

- 6 To confirm your password, re-enter it using the number buttons, then press **+**.

If you make a mistake entering your password

Press **←** before you press **+** and input the correct number.

Getting Optimal Surround Sound for a Room

(SPEAKER FORMATION)

Depending on the shape of the room, there will be some speakers you cannot install. For the better surround sound, it is recommended that first you decide the position of the speakers.

- 1 Press **FUNCTION +/-** repeatedly until "DVD" appears in the front panel display.

- 2 Press **DISPLAY** when the system is in stop mode.

The Control Menu appears.

- 3 Press **↑/↓** to select **[SPEAKER FORMATION]**, then press **+**.

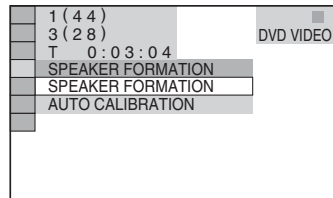

- 4 Press **↑/↓** to select **[SPEAKER FORMATION]**, then press **+**.

The options for [SPEAKER FORMATION] appear.

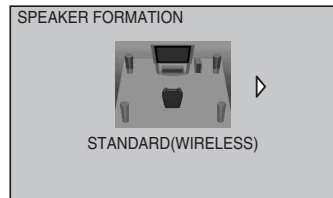

- 5 Press **←/→** to select a setting.

- [STANDARD (WIRELESS)]: when installing the front and center speakers, connecting the system with the speaker

cords and surround speakers using the wireless system.

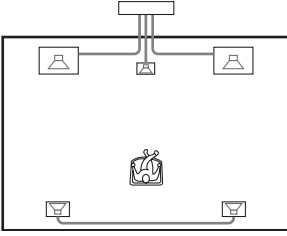

- [NO CENTER]: when installing the front and surround speakers.

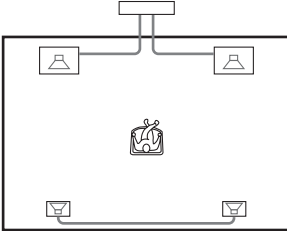

- [NO SURROUND]: when installing the center and front speakers.

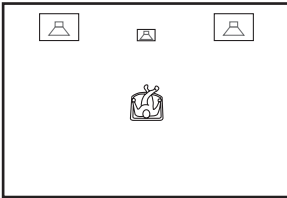

- [FRONT ONLY]: when installing the front speakers.

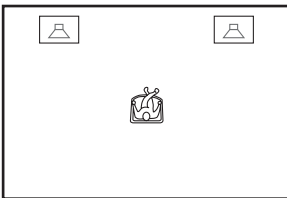

- [ALL FRONT]: when installing all the speakers in front of the listening position.

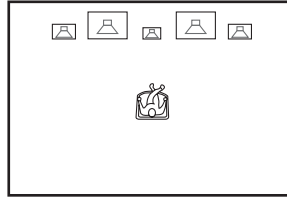

- [ALL FRONT - NO CENTER]: when installing the front and surround speakers in front of the listening position.



- [SECOND ROOM]: when installing the front speakers in one room and surround speakers in another. Connect the surround speakers to the system.

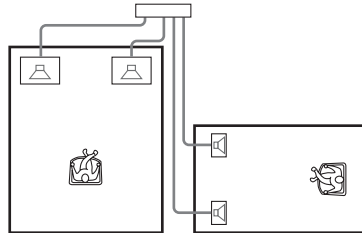

You can also install the speakers as below. Connect the speakers* (impedance 3.0 ohms - not supplied) by the supplied speaker cords (OPTION, 15 m/50 ft. × 2) to the system.

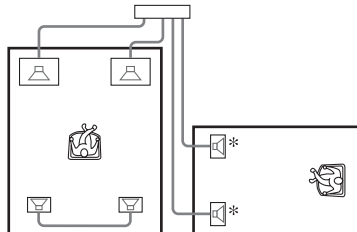

Note

- Speaker sound in the other room is the same as that of the front and surround speakers.
- [STANDARD (WIRED)]: when installing all the speakers and connecting the system by the speaker cords.

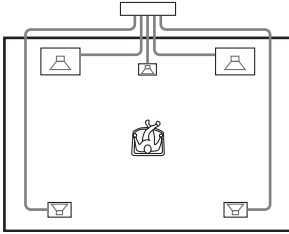
**6** Press **+**.

The selected setting takes effect.

7 Press **↑/↓** to select [YES] or [NO], then press **+**.

- [YES]: continue with [AUTO CALIBRATION], see Step 5 of “Calibrating the Appropriate Settings Automatically” (page 76).
- [NO]: exit [SPEAKER FORMATION].

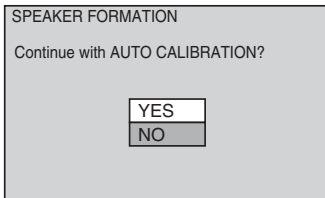
**Note**

- In order to enjoy the surround sound after you change the position of the speakers, it is recommended you set [SPEAKER FORMATION], and then set [AUTO CALIBRATION].
- To set [AUTO CALIBRATION], you need to connect the supplied calibration mic.
- The front panel display indicates the selected [SPEAKER FORMATION]. It does not indicate the speakers which output sound.
- When you change the [SIZE] setting, the [STANDARD (WIRED)] or [STANDARD (WIRELESS)] of [SPEAKER FORMATION] setting remains the same, but the other settings of [SPEAKER FORMATION] return to [STANDARD (WIRELESS)].

Calibrating the Appropriate Settings Automatically

(AUTO CALIBRATION)

D. C. A. C. (Digital Cinema Auto Calibration) can set the appropriate surround sound automatically.

Note

- Loud test sound is output when [AUTO CALIBRATION] starts. You cannot turn the volume down. Give consideration to children and neighbor.

1 Press **FUNCTION +/-** repeatedly until “DVD” appears in the front panel display.**2** Press **DISPLAY** when the system is in stop mode.

The Control Menu appears.

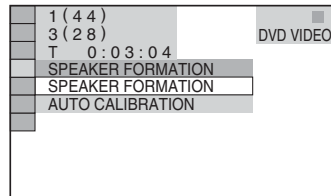
3 Press **↑/↓** to select **[SPEAKER FORMATION]**, then press **+**.**4** Press **↑/↓** to select [AUTO CALIBRATION], then press **+**.

The options for [AUTO CALIBRATION] appear.

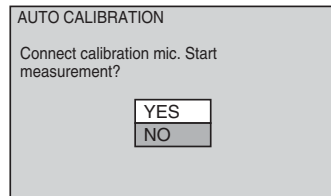

Connect the calibration mic to the A.CAL MIC jack on the front panel, and set it up at the ear level using a tripod, etc. (not supplied). The front of each speaker should

face the calibration mic, and there should be no obstruction between the speakers and the calibration mic. Be quiet during the measurement.

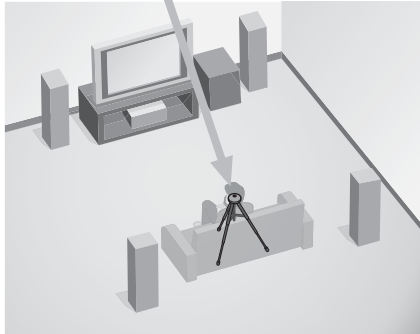
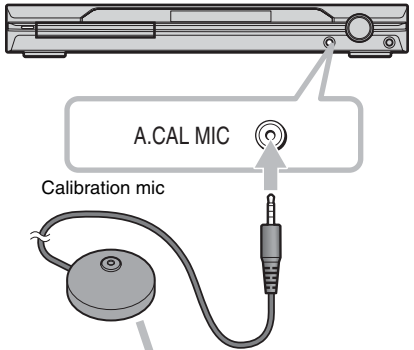

5 Press \uparrow/\downarrow to select [YES], then press \oplus .
Calibration starts.



Note

- Avoid being in the measurement area and making noise during the measurement (about 1 minute), to avoid measurement failure. During the measurement, test signals are output from the speakers.
- Reflections from walls or the floor may affect measurements.

- If an error message appears, follow the message, then select [YES].
An error message appears when:
 - the headphones are connected.
 - the calibration mic is not connected.
 - front speakers are not correctly connected.
 - surround speakers are not correctly connected.
 - front and surround speakers are not correctly connected.
 - subwoofer is not connected.

6 Press \leftarrow/\rightarrow to select [YES] or [NO], then press \oplus .

■ **The measurement is OK.**
Disconnect the calibration mic, then select [YES]. The result is implemented.

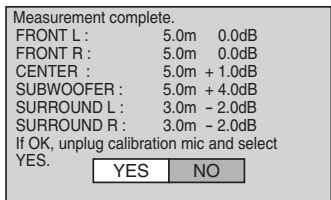

■ **The measurement is not OK.**
Follow the message, then select [YES] to retry.

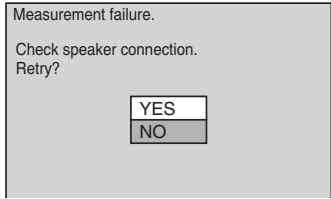

Tip

- You can check the distance between the listening position and each speaker. See page 83.

Note

- While the Auto Calibration function works:
 - do not turn off the power.
 - do not press any button.
 - do not change the volume.
 - do not change the function.
 - do not change the disc.
 - do not insert or eject a disc.
 - do not connect the headphones.
 - do not disconnect the calibration mic.

Using the Setup Display

By using the Setup Display, you can make various adjustments to items such as picture and sound.

For an overall list of Setup Display items, see page 105.

Displayed items differ depending on the country model.

Note

- Playback settings stored in the disc take priority over the Setup Display settings and not all the functions described may work.

1 Press **DISPLAY** when the system is in stop mode.

The Control Menu appears.

2 Press **↑/↓** to select **[SETUP]**, then press **+**.

The options for [SETUP] appear.

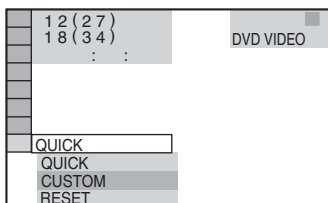

3 Press **↑/↓** to select **[CUSTOM]**, then press **+**.

The Setup Display appears.

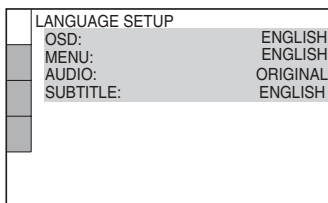

4 Press **↑/↓** to select the setup item from the displayed list: **[LANGUAGE SETUP]**, **[SCREEN SETUP]**, **[CUSTOM SETUP]**, or **[SPEAKER SETUP]**. Then press **+**.

The Setup item is selected.

Example: [SCREEN SETUP]

Selected item

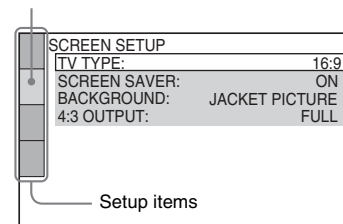

5 Select an item using **↑/↓**, then press



The options for the selected item appear.

Example: [TV TYPE]

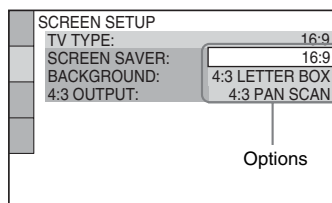

6 Select a setting using **↑/↓**, then press



The setting is selected and setup is complete.

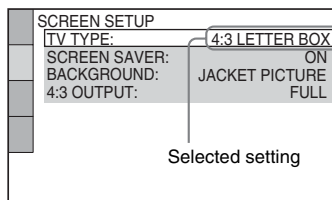

To reset all of the [SETUP] settings

1 Select [RESET] in Step 3 and press **+**.

2 Select [YES] using **↑/↓**.

You can also quit the process and return to the Control Menu by selecting [NO] here.

3 Press **+**.

All the settings explained on pages 79 to 85 return to the default settings. Do not press **I/O** while resetting the system as it takes a few seconds to complete.

Note

- When you turn the system on after resetting and no disc is in the system, the guide message appears on the TV screen. To perform the Quick Setup (page 20), press **+**, to return to normal screen, press CLEAR.

Setting the Display or Sound Track Language

[LANGUAGE SETUP]

[LANGUAGE SETUP] allows you to set various languages for the on-screen display or sound track.

Select [LANGUAGE SETUP] in the Setup Display. To use the display, see “Using the Setup Display” (page 78).

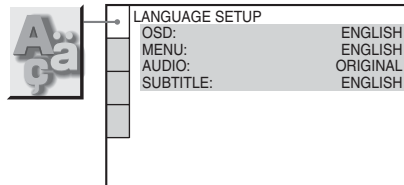

■ [OSD] (On-Screen Display)

Switches the display language on the screen.

■ [MENU] (DVD VIDEO only)

You can select the desired language for the disc's menu.

■ [AUDIO] (DVD VIDEO only)

Switches the language of the sound track.

When you select [ORIGINAL], the language given priority in the disc is selected.

■ [SUBTITLE] (DVD VIDEO only)

Switches the language of the subtitle recorded on the DVD VIDEO.

When you select [AUDIO FOLLOW], the language for the subtitles changes according to the language you selected for the sound track.

Tip

- If you select [OTHERS →] in [MENU], [AUDIO], and [SUBTITLE], select and enter a language code from “Language Code List” (page 98) using the number buttons.

Note

- When you select a language in [MENU], [AUDIO], or [SUBTITLE] that is not recorded on the DVD VIDEO, one of the recorded languages will be automatically selected (depending on the disc, the language may not be selected automatically).

Settings for the Display

[SCREEN SETUP]

Choose settings according to the TV to be connected.

Select [SCREEN SETUP] in the Setup Display. To use the display, see “Using the Setup Display” (page 78).

The default settings are underlined.

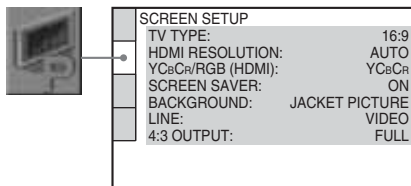

■ [TV TYPE]

Selects the aspect ratio of the connected TV (4:3 standard or wide).

The default setting varies, depending on the country model.

[4:3 LETTER BOX] Select this when you connect a 4:3 screen TV. Displays a wide picture with bands on the upper and lower portions of the screen.

[4:3 PAN SCAN] Select this when you connect a 4:3 screen TV. Automatically displays the wide picture on the entire screen and cuts off the portions that do not fit.

[16:9] Select this when you connect a wide-screen TV or a TV with a wide mode function.

[4:3 LETTER BOX]



[4:3 PAN SCAN]

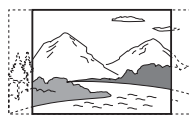

[16:9]

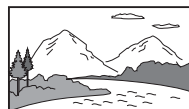

Note

- Depending on the DVD, [4:3 LETTER BOX] may be selected automatically instead of [4:3 PAN SCAN] or vice versa.

■ [HDMI RESOLUTION]

Selects the type of video signals output from the HDMI OUT (high-definition multimedia interface out) jack. When you select [AUTO] (default), the system outputs video signals of the highest resolution acceptable for your TV.

If the picture is not clear, natural or to your satisfaction, try another option that suits the disc and your TV/projector, etc. For details, refer also to the instruction manual supplied with the TV/projector, etc.

[AUTO]	Normally, select this.
[1920 × 1080i*]	Sends 1920 × 1080i video signals.
[1280 × 720p*]	Sends 1280 × 720p video signals.
[720 × 480p*]	Sends 720 × 480p video signals.**

* i: interlace, p: progressive

** Depending on the country, [720 × 480/576p] may appear.

Note

- Even when a setting other than [AUTO] is selected and the connected TV cannot accept the resolution, the system automatically adjusts the video signals that are suitable for the TV.
- When the HDMI indicator on the front panel lights up, images from the LINE OUT (VIDEO) jack is enlarged vertically. (Except when [720 × 480p] is selected.)

■ [YCbCr/RGB (HDMI)]

Selects the type of HDMI signal output from HDMI OUT jack.

[YCbCr]	Outputs YCbCr signals.
[RGB]	Outputs RGB signals.

Note

- If the playback picture becomes distorted, set [YCbCr] to [RGB].
- If the HDMI OUT jack is connected to equipment with a DVI jack, [RGB] signals will be automatically output even when you select [YCbCr].

■ [SCREEN SAVER]

The screen saver image appears when you leave the system in pause or stop mode for 15 minutes, or when you play back a Super Audio CD, CD, DATA CD (MP3 audio), or DATA DVD for more than 15 minutes. The screen saver will help prevent your display device from becoming damaged (ghosting). Press any button (e.g., ▷ button) to cancel the screen saver.

[ON]	Turns on the screen saver.
[OFF]	Turns off the screen saver.

■ [BACKGROUND]

Selects the background color or picture on the TV screen in stop mode or while playing a Super Audio CD, CD, DATA CD (MP3 audio), or DATA DVD.

[JACKET PICTURE]	The jacket picture (still picture) appears, but only when the jacket picture is already recorded on the disc (CD-EXTRA, etc.). If the disc does not contain a jacket picture, the [GRAPHICS] picture appears.
[GRAPHICS]	A preset picture stored in the system appears.
[BLUE]	The background color is blue.
[BLACK]	The background color is black.

■ [LINE]

Selects the output method for video signals from the EURO AV ⇄ OUTPUT (TO TV) jack on the rear panel of the system.

[VIDEO]	Outputs video signals.
[RGB]	Outputs RGB signals.

Note

- If your TV does not accept RGB signals, no picture appears on the TV screen even if you select [RGB]. Refer to the instructions supplied with your TV.
- You cannot select [RGB] while the HDMI indicator is lit. [RGB] automatically switches to [VIDEO] when you turn on any connected HDMI equipment.

■ [4:3 OUTPUT]

This setting is effective only when you set [TV TYPE] in [SCREEN SETUP] to [16:9] (page 80). Adjust to watch 4:3 aspect ratio progressive signals. If you can change the aspect ratio on your progressive format compatible TV, change the setting on your TV, not the system. Note that this setting is effective only for HDMI connection or progressive signals output from the COMPONENT VIDEO OUT jacks.

Note

- This setting is effective only when "P AUTO (PROGRESSIVE AUTO)" or "P VIDEO (PROGRESSIVE VIDEO)" is selected by using PROGRESSIVE (page 29).

[FULL]	Select this when you can change the aspect ratio on your TV.
[NORMAL]	Select this when you cannot change the aspect ratio on your TV. Shows a 16:9 aspect ratio signal with black bands on left and right sides of the image.

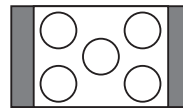

16:9 aspect ratio TV

Custom Settings

[CUSTOM SETUP]

Use this to set up playback related and other settings.

Select [CUSTOM SETUP] in the Setup Display. To use the display, see “Using the Setup Display” (page 78).

The default settings are underlined.

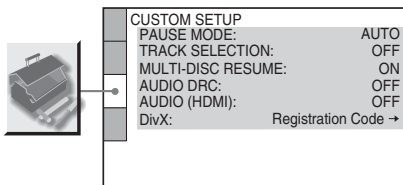

■ [PAUSE MODE] (DVD VIDEO/DVD-R/ DVD-RW only)

Selects the picture in pause mode.

[AUTO] The picture, including subjects that move dynamically, is output with no jitter. Normally select this position.

[FRAME] The picture, including subjects that do not move dynamically, is output in high resolution.

■ [TRACK SELECTION] (DVD VIDEO only)

Gives the sound track which contains the highest number of channels priority when you play a DVD VIDEO on which multiple audio formats (PCM, DTS, MPEG audio, or Dolby Digital format) are recorded.

[OFF] No priority given.

[AUTO] Priority given.

Note

- When you set the item to [AUTO], the language may change. The [TRACK SELECTION] setting has higher priority than the [AUDIO] settings in [LANGUAGE SETUP] (page 79). (Depending on the disc, this function may not work.)
- If PCM, DTS, Dolby Digital sound, and MPEG audio tracks have the same number of channels, the system selects PCM, DTS, Dolby Digital sound, and MPEG audio tracks in this order.

■ [MULTI-DISC RESUME] (DVD VIDEO/ VIDEO CD only)

Switches the Multi-disc Resume setting on or off.

[ON] Stores the resume settings in memory for up to 40 discs.

[OFF] Does not store the resume settings in memory. Playback restarts at the resume point only for the current disc in the system.

■ [AUDIO DRC] (DVD VIDEO only)

Narrows the dynamic range of the sound track. Useful for watching movies at low volume late at night.

[OFF] No compression of dynamic range.

[STANDARD] Reproduces the sound track with the kind of dynamic range that the recording engineer intended.

[MAX] Compresses dynamic range fully.

■ [AUDIO (HDMI)]

Selects the type of audio signal output from the HDMI OUT jack.

[OFF] The sound is not output from the HDMI OUT jack.

[AUTO] Outputs audio signals that is matched to the requested audio stream from the connected TV.

[PCM] Converts Dolby Digital, DTS (digital theater system), or 96 kHz/24 bit PCM (pulse code modulation) signals to 48 kHz/ 16 bit PCM (pulse code modulation).

Note

- A loud noise (or no sound) will be output if you connect the system to a TV that is not compatible with DOLBY DIGITAL/DTS (digital theater system) signals and [AUTO] is selected. In this case, select [PCM].
- When you connect the system and TV with the HDMI cord and [AUTO] or [PCM] is selected, AUDIO DRC, A/V SYNC, DYNAMIC BASS, MOVIE/ MUSIC, and sound field are not applied to the sound that is output from the TV.

■ [DivX]

Displays the registration code for this system.
For more information, go to
<http://www.divx.com> on the Internet.

Settings for the Speakers

[SPEAKER SETUP]

To obtain the best possible surround sound, set for the size of the speakers you have connected and their distance from your listening position. Then use the test tone to adjust the level and the balance of the speakers to the same level.

Select [SPEAKER SETUP] in the Setup Display. For details, see “Using the Setup Display” (page 78).

The default settings are underlined.

Note

- You cannot operate these setup items when you connect headphones to the system.

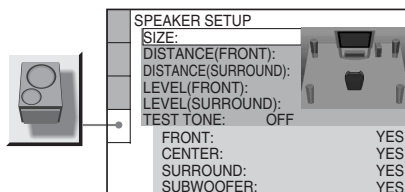

To return to the default setting when changing a setting

Select the item, then press CLEAR. Note that only the [SIZE] setting does not return to the default setting.

■ [SIZE]

If you do not connect center or surround speakers, or move the surround speakers, set the parameters for [CENTER] and [SURROUND]. Since the front speaker and subwoofer setting is fixed, you cannot change them.

[FRONT] [YES]

[CENTER] [YES]: Normally select this.
 [NONE]: Select this if no center speaker is used.

[SURROUND] [YES]: Normally select this.
 [NONE]: Select this if no surround speaker is used.

[SUBWOOFER] [YES]

Note

- When you select an item, the sound cuts off for a moment.
- When you change the [SIZE] setting, the [STANDARD (WIRED)] or [STANDARD (WIRELESS)] of [SPEAKER FORMATION] setting remains the same, but the other settings of [SPEAKER FORMATION] return to [STANDARD (WIRELESS)].

■ [DISTANCE (FRONT)]

The default distance setting for the speakers in relation to the listening position is shown below. When you set the distance using the Quick Setup (page 20), the settings is automatically displayed.

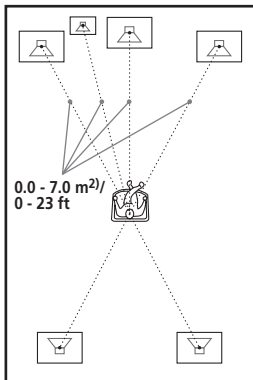

Be sure to change the value in the Setup Display when you move the speakers.

[L/R]
3.0 m/10 ft¹⁾ Front speaker distance from the listening position can be set in 0.2 meter (1 ft) increments from 0.0 to 7.0 meters²⁾ (0 to 23 ft).

[CENTER]
3.0 m/10 ft¹⁾ (appears when you set [CENTER] to [YES] in the [SIZE] setting.) Center speaker distance from the listening position can be set in 0.2 meter (1 ft) increments from 0.0 to 7.0 meters²⁾ (0 to 23 ft).

[SUBWOOFER]
3.0 m/10 ft¹⁾ Subwoofer distance from the listening position can be set in 0.2 meter (1 ft) increments from 0.0 to 7.0 meters²⁾ (0 to 23 ft).

¹⁾When you perform the Quick Setup (page 20), the default settings are changed.

²⁾0.0 to 6.9 meters for North American models.

■ [DISTANCE (SURROUND)]

The default distance setting for the speakers in relation to the listening position is shown below. When you set the distance using the Quick Setup (page 20), the settings is automatically displayed.

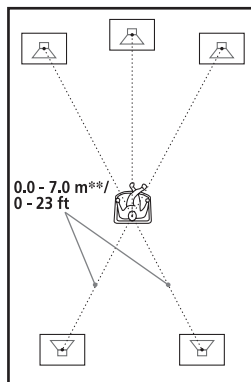

Be sure to change the value in the Setup Display when you move the speakers.

[L/R]
3.0 m/10 ft* (appears when you set [SURROUND] to [YES] in the [SIZE] setting.) Surround speaker distance from the listening position can be set in 0.2 meter (1 ft) increments from 0.0 to 7.0 meters** (0 to 23 ft).

* When you perform the Quick Setup (page 20), the default settings are changed.

** 0.0 to 6.9 meters for North American models.

Note

- When you set the distance, the sound cuts off for a moment.
- Depending on the input stream, the [DISTANCE] setting may not be effective.
- When the speaker distance setting is not in the recommended range, $\Delta\uparrow/\Delta\downarrow$ ** m is displayed (** being the number). $\Delta\uparrow$ indicates over the recommended distance. $\Delta\downarrow$ indicates below.

■ [LEVEL (FRONT)]

You can vary the level of front speakers as follows. Be sure to set [TEST TONE] to [ON] for easy adjustment.

[L/R]
0.0 dB Set this between -15.0 dB and +10.0 dB in 1.0 dB increments.

[CENTER] Set this between -15.0 dB and 0.0 dB
 (appears when you set [CENTER] to [YES] in the [SIZE] setting.)

[SUBWOOFER] Set this between -15.0 dB and 0.0 dB
 +10.0 dB in 1.0 dB increments.

■ [LEVEL (SURROUND)]

You can vary the level of surround speakers as follows. Be sure to set [TEST TONE] to [ON] for easy adjustment.

[L/R] Set this between -15.0 dB and 0.0 dB
 (appears when you set [SURROUND] to [YES] in the [SIZE] setting.)

To adjust the volume of all the speakers at one time

Turn the VOLUME control on the system, or press VOLUME +/- on the remote.

■ [TEST TONE]

The speakers will emit a test tone to adjust [LEVEL (FRONT)] and [LEVEL (SURROUND)].

[OFF] The test tone is not emitted from the speakers.

[ON] The test tone is emitted from each speaker in sequence while adjusting level. When you select one of the [SPEAKER SETUP] items, the test tone is emitted from each speaker in sequence.

Adjusting the speaker level by using the test tone

1 Press  **DISPLAY** when the system is in stop mode.

The Control Menu appears.

2 Press **↑/↓** to select  **[SETUP]**, then press **+**.

The options for [SETUP] appear.

3 Press **↑/↓** to select **[CUSTOM]**, then press **+**.

The Setup Display appears.

4 Press **↑/↓** repeatedly to select **[SPEAKER SETUP]**, then press **+** or **→**.

5 Press **↑/↓** repeatedly to select **[TEST TONE]**, then press **+** or **→**.

6 Press **↑/↓** repeatedly to select **[ON]**, then press **+**.

You will hear the test tone from each speaker in sequence.

7 From your listening position, adjust the value of **[LEVEL (FRONT)]** or **[LEVEL (SURROUND)]** using **←/↑/↓/→**.

The test tone is emitted from only the speaker which you are adjusting.

8 Press **+** when you have finished making adjustments.

9 Press **↑/↓** repeatedly to select **[TEST TONE]**, then press **+**.

10 Press **↑/↓** repeatedly to select **[OFF]**, then press **+**.

Note

- When you adjust the speaker settings, the sound cuts off for a moment.
- The test tone signals are not output from the HDMI OUT jack.

Returning to the Default Settings

You can return the system parameters, such as preset stations, to the default settings.

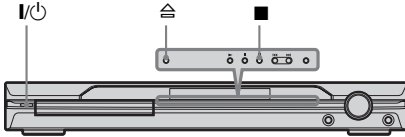

- 1 Press I/⏻ to turn on the system.**
- 2 Press ■, ⏮, and I/⏻ on the system at the same time.**

“COLD RESET” appears in the front panel display and the default settings are returned.

Additional Information

Precautions

On power sources

- AC power cord (mains lead) must be changed only at the qualified service shop.
- The unit is not disconnected from the AC power source (mains) as long as it is connected to the wall outlet (mains), even if the unit itself has been turned off.

On placement

- Place the system in a location with adequate ventilation to prevent heat build-up in the system.
- At high volume, over long periods of time, the cabinet becomes hot to the touch. This is not a malfunction. However, touching the cabinet should be avoided. Do not place the unit in a confined space where ventilation is poor as this may cause overheating.
- Do not block the ventilation slots by putting anything on the system. The system is equipped with a high power amplifier. If the ventilation slots are blocked, the unit can overheat and malfunction.
- Do not place the system on a soft surface such as a rug and do not block the ventilation holes.
- Do not place the system in a location near heat sources, or in a place subject to direct sunlight, excessive dust, or mechanical shock.

On operation

- If the system is brought directly from a cold to a warm location, or is placed in a very damp room, moisture may condense on the lenses inside the system. Should this occur, the system may not operate properly. In this case, remove the disc and leave the system turned on for about half an hour until the moisture evaporates.
- When you move the system, take out any disc. If you don't, the disc may be damaged.

On adjusting volume

- Do not turn up the volume while listening to a section with very low level inputs or no audio signals. If you do, the speakers may be damaged when a peak level section is suddenly played.

On cleaning

- Clean the cabinet, panel, and controls with a soft cloth slightly moistened with a mild detergent solution. Do not use any type of abrasive pad, scouring powder or solvent such as alcohol or benzene.

If you have any questions or problems concerning your system, please consult your nearest Sony dealer.

On cleaning discs, disc/lens cleaner

- Do not use a commercially available cleaning disc or disc/lens cleaner (wet or spray type). These may cause apparatus to malfunction.

On your TV's color

- If the speakers should cause the TV screen to have color irregularity, turn off the TV then turn it on after 15 to 30 minutes. If color irregularity should persist, place the speakers farther away from the set.

IMPORTANT NOTICE

Caution: This system is capable of holding a still video image or on-screen display image on your television screen indefinitely. If you leave the still video image or on-screen display image displayed on your TV for an extended period of time you risk permanent damage to your television screen. Projection televisions are especially susceptible to this.

The nameplate is located on the bottom exterior.

On moving the system

Before moving the system, make sure that there is no disc inserted, and remove the AC power cord (mains lead) from the wall outlet (mains).

Notes about the Discs

On handling discs

- To keep the disc clean, handle the disc by its edge. Do not touch the surface.
- Do not stick paper or tape on the disc.



- Do not expose the disc to direct sunlight or heat sources such as hot air ducts, or leave it in a car parked in direct sunlight as the temperature may rise considerably inside the car.
- After playing, store the disc in its case.

On cleaning

- Before playing, clean the disc with a cleaning cloth.
Wipe the disc from the center out.



- Do not use solvents such as benzine, thinner, commercially available cleaners, or anti-static spray intended for vinyl LPs.

This system can only play back a standard circular disc. Using neither standard nor circular discs (e.g., card, heart, or star shape) may cause a malfunction.

Do not use a disc that has a commercially available accessory attached, such as a label or ring.

Troubleshooting

If you experience any of the following difficulties while using the system, use this troubleshooting guide to help remedy the problem before requesting repairs. Should any problem persist, consult your nearest Sony dealer.

Note that if service personnel changes some parts during repair, these parts may be retained. In the event of a problem with the surround amplifier, have a Sony dealer check the entire system together (system, IR transmitter, and surround speaker (L)).

Power

The power is not turned on.

- Check that the AC power cord (mains lead) is connected securely.

If “PROTECTOR” and “PUSH POWER” appears alternately in the front panel display.

Press I/O to turn off the system, and check the following items after “STANDBY” disappears.

- Are the + and – speaker cords short-circuited?
- Are you using only the specified speakers?
- Is anything blocking the ventilation holes of the system?

After checking the above items and fixing any problems, turn on the system. If the cause of the problem cannot be found even after checking all the above items, consult your nearest Sony dealer.

The POWER/ON LINE indicator does not turn on.

- The + and – speaker cords are short-circuited. In this case, disconnect the AC power cord (mains lead) of the surround amplifier from the wall outlet (mains), reconnect, and then turn the surround amplifier on.

Picture

There is no picture.

- The SCART (EURO AV) cord is not connected securely.
- The SCART (EURO AV) cord is damaged.
- The system is not connected to the correct EURO AV  INPUT jack (page 15, 27).
- The video input on the TV is not set so that you can view pictures from the system.
- Check the output method on your system (page 81).

- You have set progressive format but your TV cannot accept the signal in progressive format. In this case, return the setting to interlace format (the default setting) (page 29).
 - Even if your TV is compatible with progressive format (525p/625p) signals, the image may be affected when you set progressive format. In this case, return the setting to interlace format (the default setting) (page 29).
 - Re-connect the connecting cord securely.
 - The system is connected to an input device that is not HDCP (high-bandwidth digital content protection) compliant (“HDMI” on the front panel does not light up). See page 100.
 - If the HDMI OUT jack is used for video output, changing the [HDMI RESOLUTION] setting in [SCREEN SETUP] may solve the problem (page 80).
Connect the TV and the system using a video jack other than the HDMI OUT, and switch the TV’s input to the connected video input so that you can see the on-screen displays. Change the [HDMI RESOLUTION] setting in [SCREEN SETUP], and switch the TV’s input back to HDMI. If the picture still does not appear, repeat the steps and try other options.
 - You have selected “PROGRESSIVE AUTO” or “PROGRESSIVE VIDEO” using the PROGRESSIVE button on the remote (“PROGRE” lights up in the front panel display) even though your TV cannot accept the progressive signal. In this case, disconnect the HDMI cord from the system and then select “NORMAL (INTERLACE)” so that the PROGRESSIVE indicator turns off.
 - If the signal from the LINE OUT (VIDEO) jack is distorted, change the [HDMI RESOLUTION] setting in [SCREEN SETUP] to [720 × 480p]*.
- * Depending on the country, [720 × 480/576p] may appear.

Picture noise appears.

- The disc is dirty or flawed.

Even though you set the aspect ratio in [TV TYPE] of [SCREEN SETUP], the picture does not fill the screen.

- The aspect ratio on the disc is fixed.

Color irregularity occurs on the TV screen.

The subwoofer and the front speakers in this system are magnetically shielded to prevent magnetic leakage. However, some leakage may occur, as a high-strength magnet is employed. If this happens, check the following items:

- If the speakers are used with a CRT-based TV or projector, install the speakers at least 0.3 m (1.0 ft) from the TV set.
- If the color irregularity persists, turn off the TV set once, then turn it on after 15 to 30 minutes.
- If howling occurs, reposition the speakers farther away from the TV set.
- Make sure that no magnetic object (magnetic latch on a TV stand, health care device, toy, etc.) is placed near the speakers.

Sound

There is no sound.

- The speaker cord is not connected securely.
- Press MUTING on the remote if “MUTING ON” is displayed in the front panel display.
- The system is in pause mode or in Slow-motion Play mode. Press ▷ to return to normal play mode.
- Fast forward or fast reverse is performed. Press ▷ to return to normal play mode.
- Check the speaker settings (page 83).
- Super Audio CD audio signals are not output from the HDMI OUT jack.
- The equipment connected to the HDMI OUT jack does not conform to the audio signal format, in this case set [AUDIO (HDMI)] in [CUSTOM SETUP] to [PCM] (page 82).

No sound is output from the HDMI OUT jack.

- Set [AUDIO (HDMI)] in [CUSTOM SETUP] to [AUTO] or [PCM] (page 82).
- The HDMI OUT jack is connected to a DVI (digital visual interface) device (DVI (digital visual interface) jacks do not accept audio signals).
- The HDMI OUT jack does not output Super Audio CD sound.
- Try the following: ① Turn the system off and on again. ② Turn the connected equipment off and on again. ③ Disconnect and then connect the HDMI cord again.

The left and right sounds are unbalanced or reversed.

- Check that the speakers and components are connected correctly and securely.

There is no sound from the subwoofer.

- Check the speaker connections and settings (page 15, 83).
- Set the sound field to “A.F.D. STD” (page 37).

continued

Severe hum or noise is heard.

- Check that the speakers and components are connected securely.
- Check that the connecting cords are away from a transformer or motor, and at least 3 meters (10 ft) away from your TV set or a fluorescent light.
- Move your TV away from the audio components.
- The plugs and jacks are dirty. Wipe them with a cloth slightly moistened with alcohol.
- Clean the disc.

The sound loses stereo effect when you play a VIDEO CD, a CD, or an MP3.

- Set [AUDIO] to [STEREO] by pressing AUDIO (page 48).
- Make sure the system is connected properly.

The surround effect is difficult to hear when you are playing a Dolby Digital, DTS, or MPEG audio sound track.

- Make sure the sound field function is on (page 37).
- Check the speaker connections and settings (page 15, 83).
- Depending on the DVD, the output signal may not be the entire 5.1 channel. It may be monaural or stereo even if the sound track is recorded in Dolby Digital or MPEG audio format.

The sound comes from the center speaker only.

- Depending on the disc, the sound may come from the center speaker only.

No sound is heard from the center speaker.

- Check the speaker connections and settings.
- Make sure the sound field function is on (page 37).
- Depending on the source, the effect of the center speaker may be less noticeable.

No sound or only a very low-level sound is heard from the surround speakers.

- Check the speaker connections and settings.
- Make sure the sound field function is on (page 37).
- Depending on the source, the effect of the surround speakers may be less noticeable.
- Wireless setting of the surround speaker is not correct (page 22).
- The plasma display may interfere with transmission, in which case, adjust the position of the IR transmitter and IR receiver of the surround speaker (L) (page 22).
- Do not install the surround speaker (L) in a place exposed to direct sunlight or strong light such as an incandescent lamp.
- Clean the surface of the IR transmitter and IR receiver of the surround speaker (L).

There is no sound from the speakers that are indicated in the front panel display.

- The front panel display indicates the selected [SPEAKER FORMATION]. It does not indicate the speakers which output sound (page 37, 74).

Operation

Radio stations cannot be tuned in.

- Check that the antenna (aerial) is connected securely. Adjust the antenna (aerial) or connect an external antenna (aerial) if necessary.
- The signal strength of the stations is too weak (when tuning in with automatic tuning). Use direct tuning.
- No stations have been preset or the preset stations have been cleared (when tuning by scanning preset stations). Preset the stations (page 64).
- Press DISPLAY so that the frequency appears in the front panel display.

The remote does not function.

- There are obstacles between the remote and the system.
- The distance between the remote and the system is too far.
- The remote is not pointed at the remote sensor on the system.
- The batteries in the remote are weak.

The POWER/ON LINE indicator momentarily turns red.

- The indicator momentarily turns red. This is not a malfunction.

The POWER/ON LINE indicator flashes in red.

- Move the wireless system away from any other nearby wireless system(s).
- Point the IR transmitter at the IR receiver of the surround speaker (L).

The disc does not play.

- There is no disc inserted.
- The disc is upside down.
Insert the disc with the playback side facing down.
- The disc is skewed on the disc tray.
- The system cannot play CD-ROMs, etc. (page 5).
- The region code on the DVD does not match the system.
- Moisture has condensed inside the system and may cause damage to the lenses. Remove the disc and leave the system turned on for about half an hour.

The MP3 audio track cannot be played.

- The DATA CD is not recorded in the MP3 format that conforms to ISO 9660 Level 1/Level 2, or Joliet.
- The DATA DVD is not recorded in an MP3 format that conforms to UDF (Universal Disk Format).
- The MP3 audio track does not have the extension “.MP3.”
- The data is not formatted in MP3 even though it has the extension “.MP3.”
- The data is not MPEG1 Audio Layer 3 data.
- The system cannot play audio tracks in MP3PRO format.
- The [MODE (MP3, JPEG)] setting has been set to [IMAGE (JPEG)] (page 59).
- If you cannot change the [MODE (MP3, JPEG)] setting, re-load the disc or turn the system off, then on.
- The DATA CD/DATA DVD contains a DivX video file.

The JPEG image file cannot be played.

- The DATA CD is not recorded in a JPEG format that conforms to ISO 9660 Level 1/Level 2, or Joliet.
- The DATA DVD is not recorded in a JPEG format that conforms to UDF (Universal Disk Format).
- It has an extension other than “.JPEG” or “.JPG.”
- It is larger than 3,072 (width) × 2,048 (height) in normal mode, or more than 2,000,000 pixels in Progressive JPEG which is mainly used on the Internet WEB site.
- It does not fit the screen (those images are reduced).
- The [MODE (MP3, JPEG)] setting has been set to [AUDIO (MP3)] (page 59).
- If you cannot change the [MODE (MP3, JPEG)] setting, re-load the disc or turn the system off, then on.
- The DATA CD/DATA DVD contains a DivX video file.

The MP3 audio tracks and JPEG image file starts playing simultaneously.

- [AUTO] has been selected in [MODE (MP3, JPEG)] (page 59).

The DivX video file cannot be played.

- The file is not created in DivX format.
- The file has an extension other than “.AVI” or “.DIVX.”
- The DATA CD/DATA DVD is not created in a DivX format that conforms to ISO 9660 Level 1/Level 2 or, Joliet/UDF.

- The DivX video file is larger than 720 (width) × 576 (height).

The titles of album/track/file name are not displayed correctly.

- The system can only display numbers and letters of the alphabets. Other characters are displayed as [“*”].

A disc does not start playing from the beginning.

- Program Play, Shuffle Play, or Repeat Play has been selected.
Press CLEAR to cancel these functions before playing a disc.
- Resume Play has been selected.
During stop, press ■ on the system or the remote and then start playback (page 43).
- The title, DVD or PBC menu automatically appears on the TV screen.

The system starts playing the disc automatically.

- The DVD features an auto playback function.

Playback stops automatically.

- Some discs may contain an auto pause signal.
While playing such a disc, the system stops playback at the auto pause signal.

You cannot perform some functions such as Stop, Search, Slow-motion Play, or Repeat Play.

- Depending on the disc, you may not be able to perform some of the operations above. See the operating manual that came with the disc.

Messages do not appear on the screen in the language you want.

- In the Setup Display, select the desired language for the on-screen display in [OSD] under [LANGUAGE SETUP] (page 79).

The language for the sound track cannot be changed.

- Multilingual tracks are not recorded on the DVD being played.
- The DVD prohibits changing the language for the sound track.

The subtitle language cannot be changed.

- Multilingual subtitles are not recorded on the DVD being played.
- The DVD prohibits changing the subtitles.

The subtitle cannot be turned off.

- The DVD prohibits turning off subtitles.

continued

The angles cannot be changed.

- Multi-angles are not recorded on the DVD being played (page 53).
- The DVD prohibits changing the angles.

A disc cannot be ejected and “LOCKED” appears in the front panel display.

- Contact your Sony dealer or local authorized Sony service facility.

[Data error] appears on the TV screen when playing a DATA CD or DATA DVD.

- The MP3 audio track/JPEG image file/DivX video file you want to play is broken.
- The data is not MPEG1 Audio Layer 3 data.
- The JPEG image file format does not conform to DCF.
- The JPEG image file has the extension “.JPG” or “.JPEG,” but is not in JPEG format.
- The file you want to play has the extension “.AVI” or “.DIVX” but is not in DivX format, or is in DivX format but does not conform to a DivX Certified profiles.

The system does not work normally.

- Disconnect the AC power cord (mains lead) from the wall outlet (mains), then reconnect after several minutes.

Self-diagnosis Function

(When letters/numbers appear in the display)

When the self-diagnosis function is activated to prevent the system from malfunctioning, a 5-character service number (e.g., C 13 50) with a combination of a letter and 4 digits appears on the screen and the front panel display. In this case, check the following table.



First 3 characters of the service number**Cause and/or corrective action**

C 13	The disc is dirty. ➔ Clean the disc with a soft cloth (page 88).
C 31	The disc is not inserted correctly. ➔ Restart the system, then re-insert the disc correctly.
E XX (xx is a number)	To prevent a malfunction, the system has performed the self-diagnosis function. ➔ Contact your nearest Sony dealer or local authorized Sony service facility and give the 5-character service number. Example: E 61 10

When displaying the version number on the screen

When you turn on the system, the version number [VER.X.XX] (X is a number) may appear on the screen. Although this is not a malfunction and for Sony service use only, normal system operation will not be possible. Turn off the system, and then turn on the system again to operate.



Specifications

Amplifier section

Stereo mode (rated)	108 W + 108 W (3 ohms at 1 kHz, 1 % THD)
Surround mode (reference)	RMS output power, 10 % THD Front: 143 W + 143 W (with SS-TS55) Center*: 143 W (with SS-CT52) Surround*: 143 W + 143 W** (3 ohms) Subwoofer*: 285 W (with SS-WS52B)

* Depending on the sound field settings and the source, there may be no sound output.

** When connecting the surround speakers to the system by the speaker cords.

Inputs (Analog)

LINE1/TV (AUDIO IN)	Sensitivity: 450/250 mV
AUDIO IN	Sensitivity: 250/125 mV

Inputs (Digital)

LINE1 (OPTICAL IN)/LINE2 (COAXIAL IN)	impedance: \approx 75 ohms
---------------------------------------	------------------------------

Outputs (Analog)

Phones	Accepts low-and high-impedance headphones.
--------	--

Super Audio CD/DVD system

Laser	Semiconductor laser (Super Audio CD/DVD: $\lambda = 650$ nm) (CD: $\lambda = 790$ nm) Emission duration: continuous
Signal format system	PAL

Tuner section

System	PLL quartz-locked digital synthesizer system
FM tuner section	
Tuning range	87.5 – 108.0 MHz (50 kHz step)
Antenna (aerial)	FM wire antenna (aerial)
Antenna (aerial) terminals	75 ohms, unbalanced
Intermediate frequency	10.7 MHz
AM tuner section	
Tuning range	531 – 1,602 kHz (with the interval set at 9 kHz)
Antenna (aerial)	AM loop antenna (aerial)
Intermediate frequency	450 kHz

Video section

Outputs	VIDEO: 1 V _{p-p} 75 ohms COMPONENT: Y: 1 V _{p-p} 75 ohms P _B /C _B , Pr/Cr: 0.7 V _{p-p} 75 ohms R/G/B: 0.7 V _{p-p} 75 ohms HDMI OUT: Type A (19 pin)
---------	--

Speakers

Front/Surround

Speaker system	Bass reflex, magnetically shielded
Speaker unit	Woofer: 70 × 100 mm cone type Tweeter: 25 mm dia. balanced dome type
Rated impedance	3.0 ohms
Dimensions (approx.)	92 × 593 × 80 mm (w/h/d) 280 × 1,200 × 280 mm (w/h/d) with stand (long) 280 × 715 × 280 mm (w/h/d) with stand (short)
Mass (approx.)	1.6 kg 4.0 kg with stand (long) 3.5 kg with stand (short)

Center

Speaker system	Closed, magnetically shielded
Speaker unit	30 × 80 mm dia. cone type
Rated impedance	3.0 ohms
Dimensions (approx.)	380 × 47 × 61 mm (w/h/d)
Mass (approx.)	0.5 kg

Subwoofer

Speaker system	Bass reflex, magnetically shielded
Speaker unit	160 mm dia. cone type
Rated impedance	1.5 ohms
Dimensions (approx.)	240 × 374 × 375 mm (w/h/d)
Mass (approx.)	6.7 kg

General

Power requirements	220 – 240 V AC, 50/60 Hz
Power consumption	On: 170 W Standby: 0.3 W (at the Power Saving mode)
Dimensions (approx.)	430 × 55 × 390 mm (w/h/d) incl. projecting parts
Mass (approx.)	4.0 kg
Surround amplifier (TA-WR4)	
Surround mode (reference)	RMS output power, 10 % THD

	140 W + 140 W (with SS-TS55, SS-TS56W)
Power requirements	220 – 240 V AC, 50/60 Hz
Power consumption	50 W
Dimensions (approx.)	280 × 280 × 60 mm (w/h/d)
Mass (approx.)	1.6 kg

Design and specifications are subject to change without notice.

Unpacking

- Speakers (5)
- Subwoofer (1)
- AM loop antenna (aerial) (1)
- FM wire antenna (aerial) (1)
- Speaker cords (5 m × 5, 3 m × 1)
- Speaker cords (OPTION) (15 m × 2)*
- Remote Commander (remote) (1)
- R6 (size AA) batteries (2)
- Calibration mic (1)
- Foot pads (1 set)
- Posts (long × 4, short × 4)
- Bases (4)
- Pedestal (4)
- Screws with washer (short) (8)
- Screws with washer (long) (24)
- Surround amplifier (1)
- Speaker base (1)
- Spacers (8)
- Guide pins (4)
- Screws (8)
- IR transmitter (1)**
- IR receiver cord (1)**
- Operating Instructions
- Speaker and TV connections (card) (1)

* Use for connecting the surround speakers to the system by the speaker cords.

** The IR receiver cord and IR transmitter are for this system only. You cannot use a commercially available extension cord.

Glossary

Album

Section of a music piece or an image on a data CD containing MP3 audio tracks or JPEG files.

Chapter

Subdivision of a title on a DVD. A title is composed of several chapters.

Digital Cinema Auto Calibration

Digital Cinema Auto Calibration was developed by Sony to automatically measure and adjust the speaker settings to your listening environment in a short period of time.

Digital Direct Twin Drive Subwoofer

Utilizing Sony's proprietary S-Master technology, the Digital Direct Twin Drive Subwoofer features two S-Master Digital Amplifiers that provide dedicated power to a strategically located subwoofer for astounding sound performance. Easy to set up, Digital Direct Twin Drive Subwoofer provides a stable sound field over a much larger listening area without having to adjust frequency levels.

Digital Infrared Audio Transmission

Recent times have been witness to the rapid spread of DVDs, Digital Broadcasting Satellite Receiver and other high-quality media. In order to ensure that the subtle nuances endowed by these high-quality media would be transmitted with no accompanying deterioration, Sony developed a technology called "Digital Infrared Audio Transmission" for the infrared transmission of digital audio signals using no compression, and it introduced it into the system.

This technology transfers digital audio signals using no compression inside the subcarrier frequency band allocated by the IEC (International Electronic Committee) and JEITA (Japan Electronics and Information Technology Industries Association) for hi-fi audio transmission applications. (See Fig. 1)

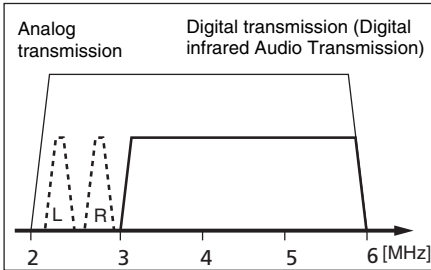

Fig. 1 Signal spectrum for digital infrared audio transmission

DivX®

Digital video technology created by DivX, Inc. Videos encoded with DivX technology are among the highest quality with a relatively small file size.

Dolby Digital

This movie theater sound format is more advanced than Dolby Surround Pro Logic. In this format, the surround speakers output stereo sound with an expanded frequency range, and a subwoofer channel for deep bass is independently provided. This format is also called "5.1" with the subwoofer channel designed as the 0.1 channel (since it functions only when a deep bass effect is needed). All six channels in this format are recorded separately for superior channel separation. Furthermore, since all the signals are processed digitally, less signal degradation occurs.

Dolby Pro Logic II

Dolby Pro Logic II creates five full-bandwidth output channels from 2 channel sources. This is done using an advanced, high-purity matrix surround decoder that extracts the spatial properties of the original recording without adding any new sounds or tonal colorations.

■ Movie mode

The Movie mode is for use with stereo television shows and all programs encoded in Dolby Surround. The result is enhanced soundfield directionality that approaches the quality of discrete 5.1-channel sound.

■ Music mode

The Music mode is for use with any stereo music recordings, and provides a wide and deep sound space.

Dolby Surround Pro Logic

As one method of decoding Dolby Surround, Dolby Surround Pro Logic produces four channels from 2 channel sound. Compared with the former Dolby Surround system, Dolby Surround Pro Logic reproduces left-to-right panning more naturally and localizes sounds more precisely. To take full advantage of Dolby Surround Pro Logic, you should have one pair of surround speakers and a center speaker. The surround speakers output monaural sound.

DTS

Digital audio compression technology developed by Digital Theater Systems, Inc. This technology conforms to 5.1-channel surround. This format comprises of stereo rear channel and there is discrete subwoofer channel in this format. DTS provides the same 5.1 discrete channels of high quality digital audio. The good channel separation is realized due to the all channel data being recorded discretely and processed in digitally.

DVD

A disc that contains up to 8 hours of moving pictures even though its diameter is the same as a CD.

The data capacity of a single-layer and single-sided DVD, at 4.7 GB (Giga Byte), is 7 times that of a CD. Furthermore, the data capacity of a dual-layer and single-sided DVD is 8.5 GB, a single-layer and double-sided DVD 9.4 GB, and a dual-layer and double-sided DVD 17 GB. The picture data uses the MPEG 2 format, one of a worldwide standard of digital compression technology. The picture data is compressed to about 1/40 of its original size. The DVD also uses the variable rate coding technology that processes allocated data according to the status of the picture.

The audio data is recorded in Dolby Digital as well as in PCM, allowing you to enjoy more realistic audio presence.

Furthermore, various advanced functions such as the multi-angle, multilingual, and Parental Control functions are provided with the DVD.

continued

DVD-RW

A DVD-RW is a recordable and rewritable disc that is the same size as a DVD VIDEO. The DVD-RW has two different modes: VR mode and Video mode. DVD-RWs created in Video mode have the same format as a DVD VIDEO, while discs created in VR (Video Recording) mode allow the contents to be programmed or edited.

DVD+RW

A DVD+RW (plus RW) is a recordable and rewritable disc. DVD+RWs use a recording format that is comparable to the DVD VIDEO format.

File

A JPEG image or a DivX video on a DATA CD/ DATA DVD. ("File" is an exclusive definition for this system.) A single file consists of a single image or movie.

Film based software, Video based software

DVDs can be classified as Film based or Video based software. Film based DVDs contain the same images (24 frames per second) that are shown at movie theaters. Video based DVDs, such as television dramas or sit-coms, displays images at 30 frames (or 60 fields) per second.

HDMI (high-definition multimedia interface)

HDMI is an interface that supports both video and audio on a single digital connection. The HDMI connection carries standard to high definition video signals and multi-channel audio signals to AV components such as HDMI equipped TVs, in digital form without degradation. Since the video signals are compatible with the current DVI (digital visual interface) format, HDMI jacks can be connected to DVI (digital visual interface) jacks by way of an HDMI -DVI (digital visual interface) converter cord. The HDMI specification supports HDCP (high-bandwidth digital contents protection), a copy protection technology that incorporates coding technology for digital video signals.

Multi-angle function

Various angles of a scene, or viewpoints of the video camera are recorded on some DVDs.

Multilingual function

Several languages for the sound or subtitles in a picture are recorded on some DVDs.

Parental Control

A function of the DVD to limit playback of the disc by the age of the users according to the limitation level in each country. The limitation varies from disc to disc; when it is activated, playback is completely prohibited, violent scenes are skipped or replaced with other scenes and so on.

Playback Control (PBC)

Signals encoded on VIDEO CDs (Version 2.0) to control playback.

By using menu screens recorded on VIDEO CDs with PBC functions, you can enjoy playing simple interactive programs, programs with search functions, and so on.

Progressive format (sequential scanning)

In contrast to the Interlace format, the progressive format can reproduce 50 - 60 frames per second by reproducing all scanning lines (525 lines for the NTSC system, 625 lines for the PAL system). The overall picture quality increases and still images, text and horizontal lines appear sharper. This format is compatible with the 525 or 625 progressive format.

Region Code

This system is used to protect copyrights. A region number is allocated on each DVD system or DVD disc according to the sales region. Each region code is shown on the system as well as on the disc packaging. The system can play discs that match its region code. The system can also play discs with the "Ⓜ" mark. Even when the region code is not shown on the DVD, the region limit may still apply.

Scene

On a VIDEO CD with PBC (playback control) functions, the menu screens, moving pictures and still pictures are divided into sections called "scenes."

Super Audio CD

Super Audio CD is a new high-quality audio disc standard where music is recorded in the DSD (Direct Stream Digital) format

(conventional CDs are recorded in the PCM format). The DSD format, using a sampling frequency 64 times higher than that of a conventional CD, and with 1-bit quantization, achieves both a wide frequency range and a wide dynamic range across the audible frequency range, and so provides music reproduction extremely faithful to the original sound.

■ Types of Super Audio CDs

There are two types of discs, depending on the Super Audio CD layer and CD layer combination.

- Super Audio CD layer: A high-density signal layer for Super Audio CD
- CD layer¹⁾: A layer that is readable by a conventional CD player

Single layer disc
(a disc with a single Super Audio CD layer)

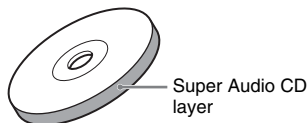

Hybrid disc²⁾
(a disc with a Super Audio CD layer and a CD layer)

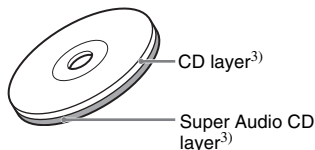

A Super Audio CD layer consists of the 2 channel area or the multi-channel area.

- 2 channel area: An area in which 2 channel stereo tracks are recorded
- Multi-channel area: An area in which multi-channel (up to 5.1 channels) tracks are recorded

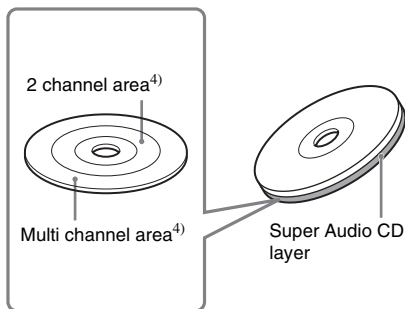

¹⁾You can play the CD layer on a conventional CD player.

²⁾Since both layers are on one side, it is not necessary to turn the disc over.

³⁾To select a layer, see “Selecting a Playback Area for a Super Audio CD” (page 54).

⁴⁾To select an area, see “Selecting a Playback Area for a Super Audio CD” (page 54).

Title

The longest section of a picture or music feature on a DVD, movie, etc., in video software, or the entire album in audio software.

Track

Section of a picture or a music piece on a VIDEO CD, CD, Super Audio CD, or MP3. An album is composed of several tracks (MP3 only).

VIDEO CD

A compact disc that contains moving pictures. The picture data uses the MPEG 1 format, one of a worldwide standard of digital compression technology. The picture data is compressed to about 1/140 of its original size. Consequently, a 12 cm VIDEO CD can contain up to 74 minutes of moving pictures.

VIDEO CDs also contain compact audio data. Sounds outside the range of human hearing are compressed while sounds we can hear are not compressed. VIDEO CDs can hold 6 times the audio information of conventional audio CDs. There are 2 versions of VIDEO CDs.

- Version 1.1: You can play only moving pictures and sounds.
 - Version 2.0: You can play high-resolution still pictures and enjoy PBC functions.
- This system conforms to both versions.

Language Code List

The language spellings conform to the ISO 639: 1988 (E/F) standard.

Code Language	Code Language	Code Language	Code Language
1027 Afar	1183 Irish	1347 Maori	1507 Samoan
1028 Abkhazian	1186 Scots Gaelic	1349 Macedonian	1508 Shona
1032 Afrikaans	1194 Galician	1350 Malayalam	1509 Somali
1039 Amharic	1196 Guarani	1352 Mongolian	1511 Albanian
1044 Arabic	1203 Gujarati	1353 Moldavian	1512 Serbian
1045 Assamese	1209 Hausa	1356 Marathi	1513 Siswati
1051 Aymara	1217 Hindi	1357 Malay	1514 Sesotho
1052 Azerbaijani	1226 Croatian	1358 Maltese	1515 Sundanese
1053 Bashkir	1229 Hungarian	1363 Burmese	1516 Swedish
1057 Byelorussian	1233 Armenian	1365 Nauru	1517 Swahili
1059 Bulgarian	1235 Interlingua	1369 Nepali	1521 Tamil
1060 Bihari	1239 Interlingue	1376 Dutch	1525 Telugu
1061 Bislama	1245 Yidpiak	1379 Norwegian	1527 Tajik
1066 Bengali;	1248 Indonesian	1393 Occitan	1528 Thai
Bangla	1253 Icelandic	1403 (Afan)Oromo	1529 Tigrinya
1067 Tibetan	1254 Italian	1408 Oriya	1531 Turkmen
1070 Breton	1257 Hebrew	1417 Punjabi	1532 Tagalog
1079 Catalan	1261 Japanese	1428 Polish	1534 Setswana
1093 Corsican	1269 Yiddish	1435 Pashto;	1535 Tonga
1097 Czech	1283 Javanese	Pushto	1538 Turkish
1103 Welsh	1287 Georgian	1436 Portuguese	1539 Tsonga
1105 Danish	1297 Kazakh	1463 Quechua	1540 Tatar
1109 German	1298 Greenlandic	1481 Rhaeto-	1543 Twi
1130 Bhutani	1299 Cambodian	Romance	1557 Ukrainian
1142 Greek	1300 Kannada	1482 Kirundi	1564 Urdu
1144 English	1301 Korean	1483 Romanian	1572 Uzbek
1145 Esperanto	1305 Kashmiri	1489 Russian	1581 Vietnamese
1149 Spanish	1307 Kurdish	1491 Kinyarwanda	1587 Volapük
1150 Estonian	1311 Kirghiz	1495 Sanskrit	1613 Wolof
1151 Basque	1313 Latin	1498 Sindhi	1632 Xhosa
1157 Persian	1326 Lingala	1501 Sangho	1665 Yoruba
1165 Finnish	1327 Laothian	1502 Serbo-	1684 Chinese
1166 Fiji	1332 Lithuanian	Croatian	1697 Zulu
1171 Faroese	1334 Latvian;	1503 Singhalese	
1174 French	Lettish	1505 Slovak	
1181 Frisian	1345 Malagasy	1506 Slovenian	1703 Not specified

Parental Control Area Code List

Code Area	Code Area	Code Area	Code Area
2044 Argentina	2165 Finland	2362 Mexico	2149 Spain
2047 Australia	2174 France	2376 Netherlands	2499 Sweden
2046 Austria	2109 Germany	2390 New Zealand	2086 Switzerland
2057 Belgium	2248 India	2379 Norway	2528 Thailand
2070 Brazil	2238 Indonesia	2427 Pakistan	2184 United Kingdom
2079 Canada	2254 Italy	2424 Philippines	
2090 Chile	2276 Japan	2436 Portugal	
2092 China	2304 Korea	2489 Russia	
2115 Denmark	2363 Malaysia	2501 Singapore	

Index to Parts and Controls

For more information, refer to the pages indicated in parentheses.

Front panel

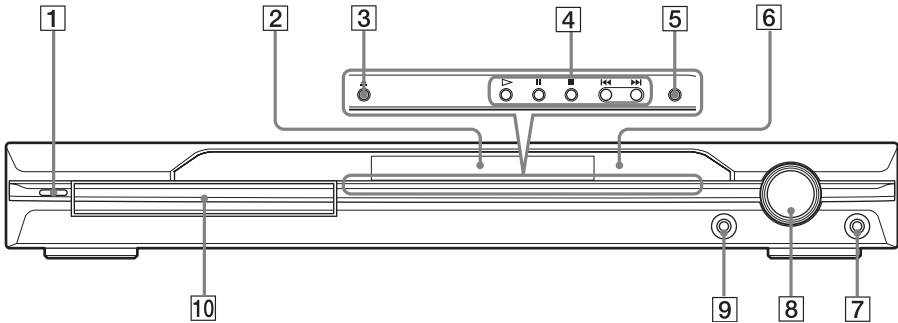

- | | |
|-----------------------------|------------------------------------|
| 1 I/⏻ (on/standby) (33) | 6 (remote sensor) (8) |
| 2 Front panel display (100) | 7 PHONES jack (33) |
| 3 (open/close) (33) | 8 VOLUME control (33) |
| 4 Disc operation (33) | 9 AUDIO IN/A.CAL MIC jack (20, 35) |
| 5 FUNCTION (33) | 10 Disc tray (33) |

Rear panel

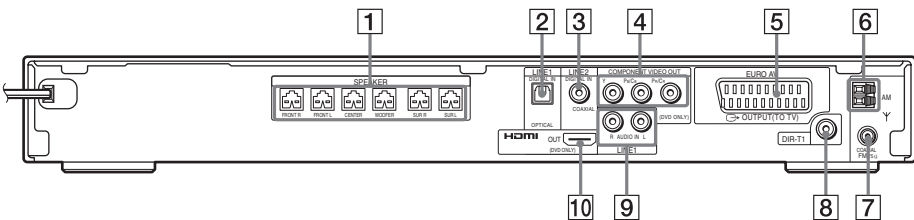

- | | |
|---|-----------------------------------|
| 1 SPEAKER jacks (15) | 6 AM terminal (15) |
| 2 LINE1 (DIGITAL IN OPTICAL) jack (31) | 7 COAXIAL FM 75Ω jack (15) |
| 3 LINE2 (DIGITAL IN COAXIAL) jack (31) | 8 DIR-T1 jack (15) |
| 4 COMPONENT VIDEO OUT jacks (27) | 9 LINE1 (AUDIO IN R/L) jacks (31) |
| 5 EURO AV OUTPUT (TO TV) jack (15, 27) | 10 HDMI OUT jack (27) |

Front panel display

About the indications in the front panel display

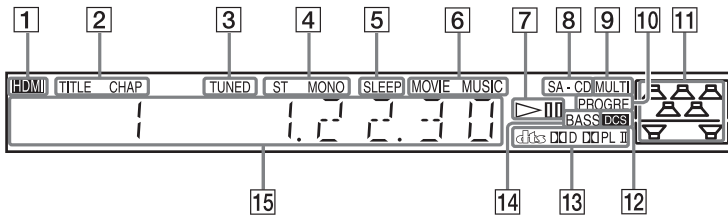

- 1 Lights up when the HDMI OUT jack is correctly connected to HDCP (high-bandwidth digital content protection) compliant device with HDMI or DVI (digital visual interface) input. (27)
- 2 Lights up when the time information of a title or chapter appears in the front panel display. (DVD only) (50)
- 3 Lights up when a station is received. (Radio only) (64)
- 4 Monaural/Stereo effect (Radio only) (64)
- 5 Lights up when the sleep timer is set. (70)
- 6 Lights up when the music or movie mode is selected. (36)
- 7 Playing status (DVD function only)
- 8 Lights up when Super Audio CD/CD is loaded.
- 9 Lights up during MULTI channel playback. (Super Audio CD only) (54)
- 10 Lights up when the system outputs progressive signals (DVD function only). (29)
- 11 Indicates the selected [SPEAKER FORMATION]. (74)
- 12 Lights up when Digital Cinema Sound (DCS) is activated. (37)
- 13 Current surround format (Except for JPEG and Super Audio CD)
- 14 Lights up when the DYNAMIC BASS is selected. (69)
- 15 Displays system's status such as chapter, title, or track number, time information, radio frequency, playing status, sound field, etc.

Surround amplifier

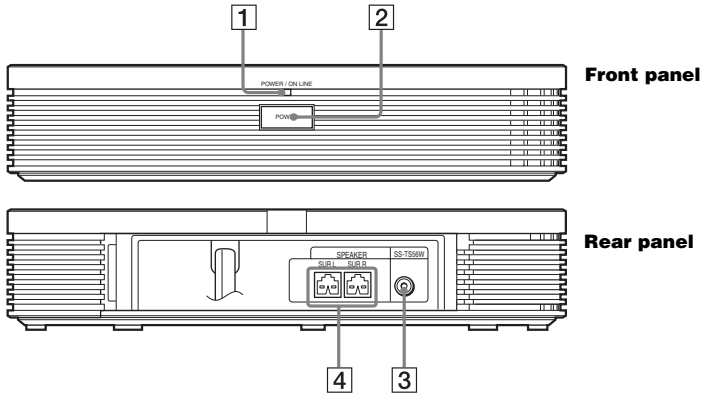

1 POWER/ON LINE indicator (22)

2 POWER (22)

3 SS-TS56W jack (15)

4 SPEAKER jacks (15)

Guide to the Control Menu Display

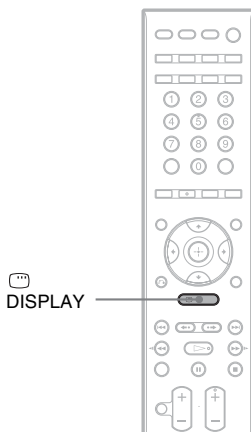

Use the Control Menu to select a function and to view related information. Press  DISPLAY repeatedly to turn on or change the Control Menu display as follows:

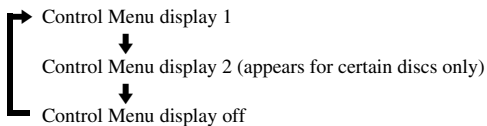

Control Menu display

The Control Menu display 1 and 2 will show different items depending on the disc type. For details about each item, see the pages in parentheses.

Example: Control Menu display 1 when playing a DVD VIDEO.

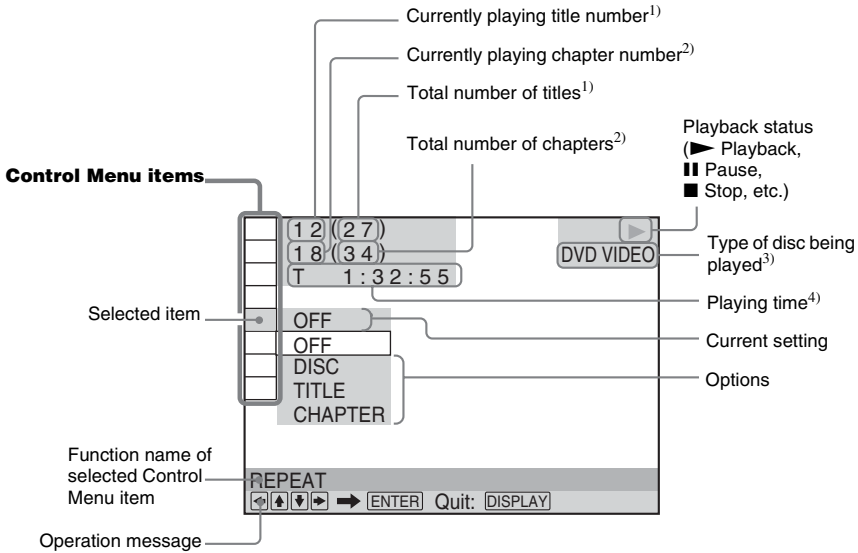

¹⁾Displays the scene number for VIDEO CDs (PBC is on), track number for VIDEO CDs/Super Audio CDs/CDs, album number for DATA CDs/DATA DVDs. DivX video album number for DATA CDs/DATA DVDs.

²⁾Displays the index number for VIDEO CDs/Super Audio CDs, MP3 audio track number, or JPEG image file number for DATA CDs/DATA DVDs. DivX video file number for DATA CDs/DATA DVDs.

³⁾Displays Super VCD as "SVCD." Displays "MP3" in the Control Menu display 1 or "JPEG" in the Control Menu 2 for DATA CDs/DATA DVDs.

⁴⁾Displays the date for JPEG files.















To turn off the display

Press DISPLAY.

List of Control Menu items



Item	Item Name, Function, Relevant Disc Type
	[TITLE] (page 41)/[SCENE] (page 41)/[TRACK] (page 41) Selects the title, scene, or track to be played. DVD-V DVD-VR VIDEO CD
	[CHAPTER] (page 41)/[INDEX] (page 41) Selects the chapter or index to be played. DVD-V DVD-VR VIDEO CD
	[INDEX] (page 41) Displays the index and selects the index to be played. Super Audio CD
	[TRACK] (page 41) Selects the track to be played. CD DATA-CD DATA DVD Super Audio CD
	[ORIGINAL/PLAY LIST] (page 50) Selects the type of titles (DVD-RW/DVD-R) to be played, the [ORIGINAL] one, or an edited [PLAY LIST]. DVD-VR
	[TIME/TEXT] (page 41) Checks the elapsed time and the remaining playback time. Input the time code for picture and music searching. Displays the DVD/CD text or the MP3 track name. DVD-V DVD-VR VIDEO CD CD DATA-CD DATA DVD Super Audio CD

continued

	<p>[SPEAKER FORMATION] (pages 74, 76) Sets the speaker formation./Adjust the level of each speaker automatically.</p> <p>DVD-V DVD-VR VIDEO CD C D DATA-CD DATA DVD Super Audio CD</p>
	<p>[MULTI/2CH] (page 54) Selects the playback area on Super Audio CDs when available.</p> <p>Super Audio CD</p>
	<p>[PROGRAM] (page 44) Selects the track to play in the order you want.</p> <p>VIDEO CD C D Super Audio CD</p>
	<p>[SHUFFLE] (page 45) Plays the track in random order.</p> <p>VIDEO CD C D DATA-CD DATA DVD Super Audio CD</p>
	<p>[REPEAT] (page 46) Plays the entire disc (all titles/all tracks/all albums) repeatedly or one title/chapter/track/album repeatedly.</p> <p>DVD-V DVD-VR VIDEO CD C D DATA-CD DATA DVD Super Audio CD</p>
	<p>[A/V SYNC] (page 54) Adjusts the delay between the picture and sound.</p> <p>DVD-V DVD-VR VIDEO CD DATA-CD DATA DVD</p>
	<p>[PARENTAL CONTROL] (page 71) Sets to prohibit playback on this system.</p> <p>DVD-V DVD-VR VIDEO CD C D DATA-CD DATA DVD Super Audio CD</p>
	<p>[SETUP] (page 78) [QUICK] Setup (page 20) Use Quick Setup to choose the desired language of the on-screen display, the aspect ratio of the TV, and the size of the speakers you are using. [CUSTOM] Setup In addition to the Quick Setup setting, you can adjust various other settings. [RESET] Returns the settings in [SETUP] to the default setting.</p> <p>DVD-V DVD-VR VIDEO CD C D DATA-CD DATA DVD Super Audio CD</p>
	<p>[ALBUM] (page 41) Selects the album to be played.</p> <p>DATA-CD DATA DVD</p>
	<p>[FILE] (page 41) Selects the JPEG image file or DivX video file to be played.</p> <p>DATA-CD DATA DVD</p>
 *	<p>[DATE] (page 52) Displays the date the picture was taken by a digital camera.</p> <p>DATA-CD DATA DVD</p>
 *	<p>[INTERVAL] (page 59) Specifies the duration for which the slides are displayed on the screen.</p> <p>DATA-CD DATA DVD</p>
 *	<p>[EFFECT] (page 59) Selects the effects to be used for changing slides during a slide show.</p> <p>DATA-CD DATA DVD</p>
 *	<p>[MODE (MP3, JPEG)] (page 59) Selects the data type; MP3 audio track (AUDIO), JPEG image file (IMAGE) or both (AUTO) to be played when playing a DATA CD/DATA DVD.</p> <p>DATA-CD DATA DVD</p>

* These items are not displayed when playing a DATA CD/DATA DVD with DivX video file.

Tip

- The Control Menu icon indicator lights up in green  →  when you select any item except [OFF] ([PROGRAM], [SHUFFLE], [REPEAT], and [A/V SYNC] only). The [ORIGINAL/PLAY LIST] indicator lights up in green when you select [PLAY LIST] (default setting). The [MULTI/2CH] indicator lights up in green when you select the multi-channel playback area on a Super Audio CD.

DVD Setup Display List

You can set the following items with the DVD Setup Display.

The order of the displayed items may be different from the actual display.

LANGUAGE SETUP

- OSD*
- MENU*
- AUDIO*
- SUBTITLE*

CUSTOM SETUP

- PAUSE MODE — AUTO — FRAME
- TRACK SELECTION — OFF — AUTO
- MULTI-DISC RESUME — ON — OFF
- AUDIO DRC — OFF — STANDARD — MAX
- AUDIO (HDMI) — OFF — AUTO — PCM
- DivX

SCREEN SETUP

- TV TYPE — 16:9 — 4:3 LETTER BOX — 4:3 PAN SCAN
- HDMI RESOLUTION — AUTO — 1920 × 1080i — 1280 × 720p — 720 × 480/576p
- YC_BC_R/RGB (HDMI) — YC_BC_R — RGB
- SCREEN SAVER — ON — OFF
- BACKGROUND — JACKET — PICTURE — GRAPHICS — BLUE — BLACK
- LINE — VIDEO — RGB
- 4:3 OUTPUT — FULL — NORMAL

SPEAKER SETUP

- SIZE — FRONT — YES — CENTER — YES — NONE — SURROUND — YES — NONE — SUBWOOFER — YES
- DISTANCE (FRONT) — L — 0.0 m – 7.0 m — R — 0.0 m – 7.0 m — CENTER — 0.0 m – 7.0 m — SUBWOOFER — 0.0 m – 7.0 m
- DISTANCE (SURROUND) — L — 0.0 m – 7.0 m — R — 0.0 m – 7.0 m
- LEVEL (FRONT) — L — -15.0 dB – +10.0 dB — R — -15.0 dB – +10.0 dB — CENTER — -15.0 dB – +10.0 dB — SUBWOOFER — -15.0 dB – +10.0 dB
- LEVEL (SURROUND) — L — -15.0 dB – +10.0 dB — R — -15.0 dB – +10.0 dB
- TEST TONE — OFF — ON

* Select the language you want to use from the displayed language list.

AMP Menu List

You can set the following items with AMP MENU on the remote.

AMP menu

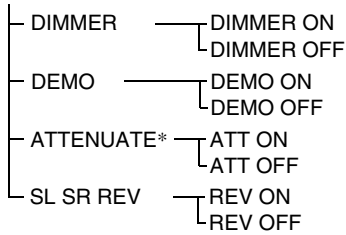

* "ATTENUATE" may not appear depending on the selected function.

Numerics

- 16:9 80
- 4:3 LETTER BOX 80
- 4:3 OUTPUT 81
- 4:3 PAN SCAN 80
- 5.1 Channel Surround 49

A

- A/V SYNC 54
- ALBUM 41
- Album 94
- AMP MENU 24, 35, 70
- AMP menu list 106
- ANGLE 53
- ATTENUATE 35
- AUDIO 79
- AUDIO (HDMI) 82
- AUDIO DRC 82
- Auto Calibration 76, 94

B

- BACKGROUND 81
- Batteries 8

C

- CHAPTER 41
- Chapter 94
- CINEMA STUDIO EX 38
- COLD RESET 86
- COMPONENT VIDEO OUT 29
- Continuous play 33
- Control Menu Display 102
- Controlling the TV 67
- CUSTOM 78
- CUSTOM PARENTAL CONTROL 71
- CUSTOM SETUP 82

D

- D. C. A. C. 76, 94
- DATA CD 57, 61
- DATA DVD 57, 61
- DEMO 24
- Demonstration 24
- Digital Cinema Auto Calibration 76, 94
- Digital Cinema Sound 38
- Digital connection 32
- Digital Direct Twin Drive Subwoofer 94

- Digital Infrared Audio Transmission 94
- DIMMER 70
- DISPLAY 65
- DivX® 61, 83, 95
- Dolby Digital 48, 95
- Dolby Pro Logic II 95
- Dolby Surround Pro Logic 95
- DTS 48, 95
- DUAL MONO 39
- DVD 95
- DVD+RW 96
- DVD's menu 47
- DVD-RW 50, 96
- DVI 28
- DYNAMIC BASS 69

E

- EFFECT 60

F

- Fast forward 40
- Fast reverse 40
- FILE 41
- File 96
- Film based software 96
- Freeze Frame 40
- Front panel 99
- Front panel display 50, 100

H

- Handling discs 88
- HDMI
 - HDMI RESOLUTION 80
 - YCBCR/RGB (HDMI) 81
- HDMI (high-definition multimedia interface) 28, 96

I

- INDEX 41
- Installing the speakers and the IR transmitter on a wall 25
- Instant Advance 33
- Instant Replay 33
- INTERLACE 30
- INTERVAL 59
- IR transmitter 22, 25

J

- JPEG 55, 57

L

- Language Code List 98
- LANGUAGE SETUP 79
- LINE 81
- Listening to other components 34
- Listening to TV sound 35
- Locating a specific point by watching the TV screen 40

M

- MENU 79
- MODE (MP3, JPEG) 59
- MOVIE/MUSIC 36
- MP3 55, 57
- Multi Session CD 6
- Multi-angle function 53, 96
- MULTI-DISC RESUME 82
- Multilingual function 96
- Multiplex broadcast sound 39
- MUTING 33

N

- Naming preset stations 65

O

- OPTICAL (Digital Out) 32
- ORIGINAL 50
- OSD 79
- Other Component Hookup 31

P

- PARENTAL CONTROL 72
- Parental Control 96
- PAUSE MODE 82
- PBC Playback 63
- PICTURE NAVI 42, 57
- PLAY LIST 50
- Playback Control (PBC) 96
- Program Play 44
- PROGRESSIVE AUTO 29
- Progressive format 29, 96
- PROGRESSIVE VIDEO 29

Q

- Quick Setup 20

R

- Radio 64
- Radio Stations 64
- RDS 66

Rear Panel 99
Region Code 6, 96
Remote 8, 67
Repeat Play 46
RESET 78
Resume Play 43

S

Scan 40
SCENE 41
Scene 96
SCREEN SAVER 81
SCREEN SETUP 80
Searching 40
Selecting 36
SETUP 78
Setup Display 78, 105
Shuffle Play 45
SL SR REV 23
SLEEP 70
Slide Show 59
Slow-motion Play 40
Sound Field 37
SPEAKER FORMATION 74
SPEAKER SETUP 83
 DISTANCE 84
 LEVEL 84, 85
 SIZE 83
SUBTITLE 53, 79
Super Audio CD 54, 96
Surround amplifier 101

T

TEST TONE 85
THEATRE SYNC 68
TIME/TEXT 41
TITLE 41
Title 97
TRACK 41
Track 97
TRACK SELECTION 82
Troubleshooting 88
TV Hookup 27
TV TYPE 80

U

Unpacking 94
Usable discs 5

V

VIDEO CD 97

W

Wireless 22

Remote control

ALPHABETICAL ORDER

A - O

- AMP MENU⁴⁾ **7** (24, 35, 70, 106)
- ANGLE **5** (53)
- AUDIO³⁾ **33** (48)
- CLEAR **34** (41, 65, 68, 78)
- D.TUNING **24** (64)
- DISC SKIP¹⁾ **12** (33)
- DISPLAY **2** (50, 65)
- DYNAMIC BASS **3** (69)
- ENTER²⁾ **4** (20, 24, 35, 41, 64, 71)
- FUNCTION +/-³⁾ **10** (29, 33, 34, 43, 64, 74)
- MENU **6** (47, 64)
- MOVIE/MUSIC **23** (36)
- MUTING **28** (33)
- Number buttons³⁾ **17** (41, 64, 67, 71)

P - Z

- PICTURE NAVI **16** (42, 68)
- PRESET +/- **8** **13** (64)
- PROGRESSIVE **18** (29)
- SA-CD/CD **22** (54)
- SLEEP **36** (70)
- SOUND FIELD **35** (37)
- SUBTITLE **24** (53)
- THEATRE SYNC **21** (69)
- TOP MENU **32** (47)
- TUNING +/- **26** **30** (64)
- TV **20** (67)
- TV CH +/-³⁾ **10** (67)
- TV VOL +/- **11** (67)
- TV/VIDEO **19** (67)
- VOLUME +/- **11** (33, 64, 85)

BUTTON DESCRIPTIONS

- 1** (on/standby) **1** (20, 24, 33, 43, 64)
- TV **1** (on/standby) **37** (67)
- 2** (on/standby) **15** (20, 24, 35, 41, 64, 71)
- 3** REPLAY/
ADVANCE **25** (33)
- 4** **13** **8** (33)
- 5** **30** **26** (40)
- 6** **30** **26** (40)
- 7** (play)³⁾ **9** (33, 43, 72)
- 8** (stop) **27** (33, 43, 71)
- 9** (pause) **29** (33)
- 10** DISPLAY⁴⁾ **31** (22, 41, 71, 102)
- 11** RETURN⁴⁾ **14** (42)
- 12** **34** (67)

¹⁾The DISC SKIP button is not available for this model.

²⁾The ENTER button is the same function as the **2** button.

³⁾The **7**, number 5, AUDIO, and FUNCTION + (TV CH +) buttons have tactile dots. Use the tactile dots as references when operating the system.

⁴⁾After pressing the TV button **20**, you can control the menu on a Sony TV. On the menu screen, the **31** DISPLAY button **31** doubles as the MENU button, and the AMP MENU button **7** double as the TOOLS button. Note that depending on the component, you may not be able to use some or all of the buttons.

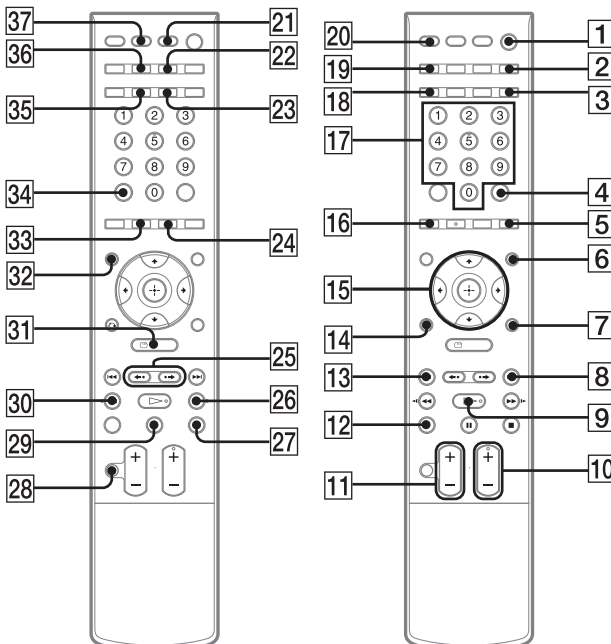

Free Manuals Download Website

<http://myh66.com>

<http://usermanuals.us>

<http://www.somanuals.com>

<http://www.4manuals.cc>

<http://www.manual-lib.com>

<http://www.404manual.com>

<http://www.luxmanual.com>

<http://aubethermostatmanual.com>

Golf course search by state

<http://golfingnear.com>

Email search by domain

<http://emailbydomain.com>

Auto manuals search

<http://auto.somanuals.com>

TV manuals search

<http://tv.somanuals.com>