

# ■ DVD Home Theatre ■ System

Operating Instructions

DAV-HDX275 / HDX276 / HDX475



**HDMI**

*Digital Direct  
Twin Drive Subwoofer*



SUPER AUDIO CD



**MP3**

## WARNING

**To reduce the risk of fire or electric shock, do not expose this apparatus to rain or moisture.**

**Caution – The use of optical instruments with this product will increase eye hazard.**

Do not install the appliance in a confined space, such as a bookcase or built-in cabinet.

To prevent fire, do not cover the ventilation of the apparatus with news papers, table-cloths, curtains, etc. And don't place lighted candles on the apparatus.

To prevent fire or shock hazard, do not place objects filled with liquids, such as vases, on the apparatus.

Batteries or batteries installed apparatus shall not be exposed to excessive heat such as sunshine, fire or the like.

In door use only.

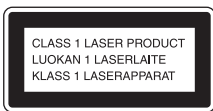

This appliance is classified as a CLASS 1 LASER product. This marking is located on the rear exterior.

## For the customers in the U.S.A

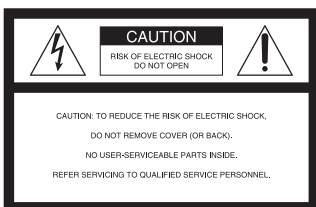

This symbol is intended to alert the user to the presence of uninsulated "dangerous voltage" within the product's enclosure that may be of sufficient magnitude to constitute a risk of electric shock to persons.



This symbol is intended to alert the user to the presence of important operating and maintenance (servicing) instructions in the literature accompanying the appliance.

### Owner's Record

The model and serial numbers are located at the rear exterior of the control unit. Record the serial number in

the space provided below. Refer to them whenever you call upon your Sony dealer regarding this product.

Model No. DAV-HDX275/DAV-HDX276/DAV-HDX475

Serial No. \_\_\_\_\_

Date of Manufacture Marking is located on the bottom exterior.

The following FCC statement applies only to the version of this model manufactured for sale in the USA. Other versions may not comply with FCC technical regulations.

## WARNING

This equipment has been tested and found to comply with the limits for a Class B digital device, pursuant to Part 15 of the FCC Rules. These limits are designed to provide reasonable protection against harmful interference in a residential installation. This equipment generates, uses, and can radiate radio frequency energy and, if not installed and used in accordance with the instructions, may cause harmful interference to radio communications. However, there is no guarantee that interference will not occur in a particular installation. If this equipment does cause harmful interference to radio or television reception, which can be determined by turning the equipment off and on, the user is encouraged to try to correct the interference by one or more of the following measures:

- Reorient or relocate the receiving antenna (aerial).
- Increase the separation between the equipment and receiver.
- Connect the equipment into an outlet on a circuit different from that to which the receiver is connected.
- Consult the dealer or an experienced radio/TV technician for help.

## CAUTION

You are cautioned that any changes or modifications not expressly approved in this manual could void your authority to operate this equipment.

## Important Safety Instructions

- 1) Read these instructions.
- 2) Keep these instructions.
- 3) Heed all warnings.
- 4) Follow all instructions.
- 5) Do not use this apparatus near water.
- 6) Clean only with dry cloth.
- 7) Do not block any ventilation openings. Install in accordance with the manufacturer's instructions.

- 8) Do not install near any heat sources such as radiators, heat registers, stoves, or other apparatus (including amplifiers) that produce heat.
- 9) Do not defeat the safety purpose of the polarized or grounding-type plug. A polarized plug has two blades with one wider than the other. A grounding type plug has two blades and a third grounding prong. The wide blade or the third prong are provided for your safety. If the provided plug does not fit into your outlet, consult an electrician for replacement of the obsolete outlet.
- 10) Protect the power cord from being walked on or pinched particularly at plugs, convenience receptacles, and the point where they exit from the apparatus.
- 11) Only use attachments/accessories specified by the manufacturer.
- 12) Use only with the cart, stand, tripod, bracket, or table specified by the manufacturer, or sold with the apparatus. When a cart is used, use caution when moving the cart/apparatus combination to avoid injury from tip-over.



- 13) Unplug this apparatus during lightning storms or when unused for long periods of time.
- 14) Refer all servicing to qualified service personnel. Servicing is required when the apparatus has been damaged in any way, such as power-supply cord or plug is damaged, liquid has been spilled or objects have fallen into the apparatus, the apparatus has been exposed to rain or moisture, does not operate normally, or has been dropped.

**Note to CATV system installer:**

This reminder is provided to call the CATV system installer's attention to Article 820-40 of the NEC that provides guidelines for proper grounding and, in particular, specifies that the cable ground shall be connected to the grounding system of the building, as close to the point of cable entry as practical.

**Precautions**

**On power sources**

- AC power cord (mains lead) must be changed only at the qualified service shop.
- The unit is not disconnected from the AC power source (mains) as long as it is connected to the wall outlet (mains), even if the unit itself has been turned off.

- Install this system so that the AC power cord (mains lead) can be unplugged from the wall socket immediately in the event of trouble.

**Note on power cord plug shapes (Saudi Arabian model only)**

**For AC 220 V wall sockets**

Make sure that the 13 A 3-pin plug (Type BF) is securely attached to the power cord. (The 13 A 3-pin plug is attached when shipped from the factory.)

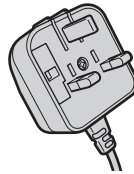

**For AC 127 V wall sockets**

- 1 Remove the 13 A 3-pin plug using a screwdriver.

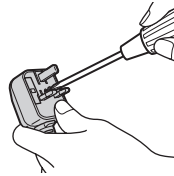

- 2 Attach the supplied parallel blade plug (Type A).

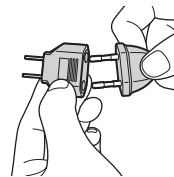

---

## About This Operating Instructions

- The instructions in this Operating Instructions describe the controls on the remote. You can also use the controls on the unit if they have the same or similar names as those on the remote.
- The instructions in this manual are for DAV-HDX275, DAV-HDX276, and DAV-HDX475. DAV-HDX275 is the model used for illustration purposes. Any difference in operation is clearly indicated in the text, for example, “DAV-HDX275 only.”
- The Control Menu items may vary depending on the area.
- “DVD” may be used as a general term for a DVD VIDEO, DVD+RW/DVD+R, and DVD-RW/DVD-R.
- Measurements are expressed in feet (ft) for North American models.
- The default setting is underlined.

---

## About the S-AIR function

### *(DAV-HDX275/DAV-HDX475 only)*

The system is compatible with the S-AIR function, which allows transmission of sound between S-AIR products wirelessly. The following S-AIR products can be used with the system:

- Surround amplifier: You can enjoy surround speaker sound wirelessly.
- S-AIR receiver: You can enjoy system sound in another room.

These S-AIR products can be purchased as an option (the S-AIR product lineup differs depending on the area).

Notes or instructions for the surround amplifier or S-AIR receiver in this operating instructions refer only to when the surround amplifier or S-AIR receiver is used.

For details on the S-AIR function, see “Using an S-AIR Product” (page 77).

# Table of Contents

About This Operating Instructions.....	4
About the S-AIR function.....	4
Playable Discs.....	6

## Getting Started

<b>Step 1: Assembling the Speakers .....</b>	<b>13</b>
<b>Step 2: Positioning the System... ..</b>	<b>18</b>
<b>Step 3: Connecting the System... ..</b>	<b>22</b>
<b>Step 4: Performing the Quick Setup.....</b>	<b>35</b>
<b>Step 5: Enjoying Sound from all the Speakers.....</b>	<b>38</b>

## Sound Adjustment

Enjoying Surround Sound by Using Decoding Mode .....	40
Selecting the Sound Mode .....	42
Enjoying Multiplex Broadcast Sound... ..	42

## Disc

Playing a Disc .....	43
Using Play Mode.....	49
Searching/Selecting a Disc .....	52
Playing MP3 Files/JPEG Image Files... ..	54
Enjoying DivX® Videos.....	57
Adjusting the Delay Between the Picture and Sound .....	59
Restricting Playback of the Disc.....	59
Using the Setup Display.....	61

## Tuner

Presetting Radio Stations .....	70
Listening to the Radio.....	71

## Control for HDMI/External Audio Device

Using the Control for HDMI Function for “BRAVIA” Sync .....	73
Using the DIGITAL MEDIA PORT Adapter .....	76
Using an S-AIR Product .....	77











## Other Operations

Getting Optimal Surround Sound for a Room .....	83
Calibrating the Appropriate Settings Automatically .....	84
Controlling the TV with the Supplied Remote .....	85
Using the Sound Effect.....	86
Using the Sleep Timer .....	86
Changing the Brightness of the Front Panel Display.....	87
Viewing Information About the Disc ...	87
Returning to the Default Settings .....	90

## Additional Information

Precautions.....	91
Notes about the Discs .....	92
Troubleshooting.....	93
Self-diagnosis Function .....	100
Specifications.....	101
Glossary .....	103
Language Code List.....	105
Index to Parts and Control .....	106
Guide to the Control Menu Display ...	110
Index .....	113

# Playable Discs

Type	Disc logo	Characteristics	Icon
DVD VIDEO	     	<ul style="list-style-type: none"> <li>• DVD VIDEO</li> <li>• DVD-R/DVD-RW in DVD VIDEO format or video mode</li> <li>• DVD+R/DVD+RW in DVD VIDEO format</li> </ul>	<b>DVD-V</b>
VR (Video Recording) mode	 	<ul style="list-style-type: none"> <li>• DVD-R/DVD-RW in VR (Video Recording) mode (except for DVD-R DL)</li> </ul>	<b>DVD-VR</b>
Super Audio CD	 SUPER AUDIO CD	<ul style="list-style-type: none"> <li>• Super Audio CD</li> </ul>	<b>Super Audio CD</b>
VIDEO CD		<ul style="list-style-type: none"> <li>• VIDEO CD (Ver. 1.1 and 2.0 discs)</li> <li>• Super VCD</li> <li>• CD-R/CD-RW/CD-ROM in video CD format or Super VCD format</li> </ul>	<b>VIDEO CD</b>
CD		<ul style="list-style-type: none"> <li>• Audio CD</li> <li>• CD-R/CD-RW in audio CD format</li> </ul>	<b>CD</b>
DATA CD	—	<ul style="list-style-type: none"> <li>• CD-R/CD-RW/CD-ROM in DATA CD format, containing MP3 files<sup>1)</sup>, JPEG image files<sup>2)</sup>, and DivX video files<sup>3)4)5)</sup>, and conforming to ISO 9660<sup>6)</sup> Level 1/ Level 2, or Joliet (extended format)</li> </ul>	<b>DATA-CD</b>
DATA DVD	—	<ul style="list-style-type: none"> <li>• DVD-ROM/DVD-R/DVD-RW/ DVD+R/DVD+RW in DATA DVD format, containing MP3 files<sup>1)</sup>, JPEG image files<sup>2)</sup>, and DivX video files<sup>3)4)5)</sup>, and conforming to UDF (Universal Disk Format)</li> </ul>	<b>DATA DVD</b>

<sup>1)</sup>MP3 (MPEG1 Audio Layer 3) is a standard format defined by ISO/MPEG which compresses audio data. MP3 files must be in MPEG1 Audio Layer 3 format.

- <sup>2</sup>)JPEG image files must conform to the DCF image file format. (DCF “Design rule for Camera File system”: Image standards for digital cameras regulated by Japan Electronics and Information Technology Industries Association (JEITA).)
- <sup>3</sup>)Except for United Kingdom and North American models.
- <sup>4</sup>)DivX<sup>®</sup> is a video file compression technology, developed by DivX, Inc.
- <sup>5</sup>)DivX, DivX Certified, and associated logos are trademarks of DivX, Inc. and are used under license.
- <sup>6</sup>)A logical format of files and folders on CD-ROMs, defined by ISO (International Organization for Standardization).
- “DVD-RW,” “DVD+RW,” “DVD+R,” “DVD VIDEO,” and the “CD” logos are trademarks.

## Example of discs that the system cannot play

The system cannot play the following discs:

- CD-ROM/CD-R/CD-RW other than those recorded in the formats listed on page 6
  - CD-ROM recorded in PHOTO CD format
  - Data part of CD-Extra
  - CD Graphics disc
  - DVD Audio
  - DATA DVD that does not contain MP3 files, JPEG image files, or DivX video files\*
- \* Except for United Kingdom and North American models.
- DVD-RAM

Also, the system cannot play the following discs:

- A DVD VIDEO with a different region code (page 8)
- A disc that has a non-standard shape (e.g., card, heart)
- A disc with paper or stickers on it
- A disc that has the adhesive of cellophane tape or a sticker still left on it

## Note about CD-R/CD-RW/DVD-R/DVD-RW/DVD+R/DVD+RW

In some cases, CD-R/CD-RW/DVD-R/DVD-RW/DVD+R/DVD+RW cannot be played on this system due to the recording quality or physical condition of the disc, or the characteristics of the recording device and authoring software.

The disc will not play if it has not been correctly finalized. For more information, refer to the operating instructions for the recording device.

Note that some playback functions may not work with some DVD+RWs/DVD+Rs, even if they have been correctly finalized. In this case, view the disc by normal playback. Also some DATA CDs/DATA DVDs created in Packet Write format cannot be played.

## Music discs encoded with copyright protection technologies

This product is designed to play back discs that conform to the Compact Disc (CD) standard.

Recently, various music discs encoded with copyright protection technologies are marketed by some record companies. Please be aware that among those discs, there are some that do not conform to the CD standard and may not be playable by this product.

## Note on DualDiscs

A DualDisc is a two sided disc product which mates DVD recorded material on one side with digital audio material on the other side. However, since the audio material side does not conform to the Compact Disc (CD) standard, playback on this product is not guaranteed.

## About Multi Session CD

- This system can play a Multi Session CD when an MP3 file is contained in the first session. Any subsequent MP3 files recorded in later sessions can also be played back.
- This system can play a Multi Session CD when a JPEG image file is contained in the first session. Any subsequent JPEG image files recorded in later sessions can also be played back.
- If MP3 files and JPEG image files in music CD format or video CD format are recorded in the first session, only the first session will be played back.

## Region code

Your system has a region code printed on the rear of the unit and will only play a DVD labeled with the same region code.

A DVD VIDEO labeled  will also play on this system.

If you try to play any other DVD VIDEO, the message [Playback prohibited by area limitations.] will appear on the TV screen. Depending on the DVD VIDEO, no region code indication may be given even though playing the DVD VIDEO is prohibited by area restrictions.

## Note about playback operations of a DVD or VIDEO CD

Some playback operations on a DVD or VIDEO CD may be intentionally set by software producers. Since this system will play a DVD or VIDEO CD according to the disc contents the software producers designed, some playback features may not be available. Be sure to read the operating instructions supplied with the DVD or VIDEO CD.

## Copyrights

This product incorporates copyright protection technology that is protected by U.S. patents and other intellectual property rights. Use of this copyright protection technology must be authorized by Macrovision, and is intended for home and other limited viewing uses only unless otherwise authorized by Macrovision. Reverse engineering or disassembly is prohibited.

This system incorporates with Dolby\* Digital and Dolby Pro Logic (II) adaptive matrix surround decoder and the DTS\*\* Digital Surround System.

\* Manufactured under license from Dolby Laboratories.

“Dolby”, “Pro Logic”, and the double-D symbol are trademarks of Dolby Laboratories.

\*\* Manufactured under license from DTS, Inc.

“DTS” and “DTS Digital Surround” are registered trademarks of DTS, Inc.



This system incorporates High-Definition Multimedia Interface (HDMI™) technology. HDMI, the HDMI logo and High-Definition Multimedia Interface are trademarks or registered trademarks of HDMI Licensing LLC.

“BRAVIA” and BRAVIA are trademarks of Sony Corporation.

“S-AIR” and its logo are trademarks of Sony Corporation.

## Getting Started

## Unpacking

## DAV-HDX275/DAV-HDX276

- Front speakers (2)

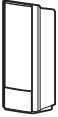

- Center speaker (1)

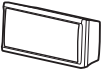

- Surround speakers (2)



- Subwoofer (1)

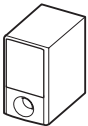

- AM loop antenna (aerial) (1)



- FM wire antenna (aerial) (1)

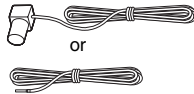

- Speaker cords (6, red/white/  
green/gray/blue/purple)



- Video cord (1)



- Remote commander  
(remote) (1)

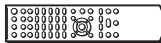

- R6 (size AA) batteries (2)



- Calibration mic (1)



- Foot pads (1 set)



- DIGITAL MEDIA PORT  
adapter (TDM-iP10) (1)  
(North American models only)
- Operating Instructions
- Speaker and TV connections  
(card)

**DAV-HDX475**

- Front speakers (2)



- Center speaker (1)

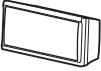

- Surround speakers (2)



- Subwoofer (1)

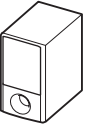

- AM loop antenna (aerial) (1)



- FM wire antenna (aerial) (1)



or



- Speaker cords (6, red/white/green/gray/blue/purple)



- Video cord (1)



- Remote commander (remote) (1)

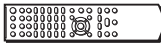

- R6 (size AA) batteries (2)



- Calibration mic (1)



- Foot pads (1 set)



- Posts (2)

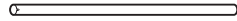

- Bases (2)

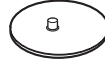

- Mounting plates (2)



- Post covers (2)



- Screws (large, with washer) (4)



- Screws (small) (6)



- DIGITAL MEDIA PORT adapter (TDM-iP10) (1)

- Operating Instructions

- Speaker and TV connections (card)

## Inserting batteries into the remote

Insert two R6 (size AA) batteries (supplied) by matching the ⊕ and ⊖ ends on the batteries to the markings inside the compartment. To use the remote, point it at the remote sensor  on the unit.

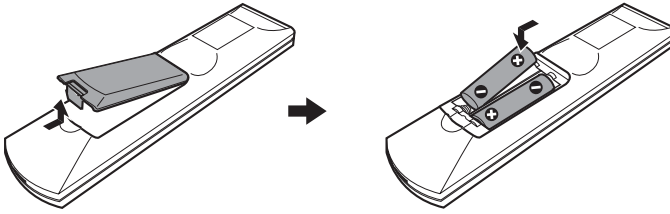

### Note

- Do not leave the remote in an extremely hot or humid place.
- Do not use a new battery with an old one.
- Do not drop any foreign object into the remote casing, particularly when replacing the batteries.
- Do not expose the remote sensor to direct sunlight or lighting apparatus. Doing so may cause a malfunction.
- If you do not intend to use the remote for an extended period of time, remove the batteries to avoid possible damage from battery leakage and corrosion.

## Attaching the foot pads to the subwoofer

Attach the foot pads (supplied) to the bottom of the subwoofer to stabilize the subwoofer and prevent it from slipping.

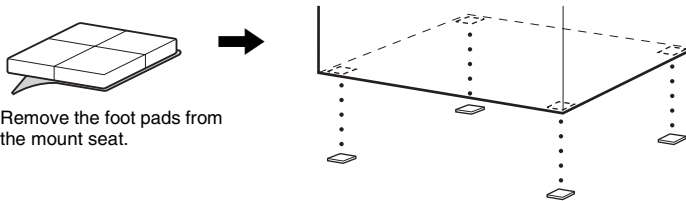

Remove the foot pads from the mount seat.

# Step 1: Assembling the Speakers

## (DAV-HDX475 only)

Before connecting the speakers, attach the speaker stand to the speaker.  
(For the front speakers)

Use the parts as follows:

- Front speakers (2)
- Speaker cords (2, red/white)
- Posts (2)
- Bases (2)
- Mounting plates (2)
- Post covers (2)
- Screws (large, with washer) (4)
- Screws (small) (6)

About how to connect the speaker cords to the SPEAKER jacks, see page 24.

### Note

- Spread a cloth on the floor to avoid damaging the floor when you assemble the speakers.

### Tip

- You can use the speaker without the speaker stand by installing it on the wall (page 18).

## 1 Thread the speaker cord through the hole in the base and post.

The connector and color tube of the speaker cords are the same color as the label of the jacks to be connected.

Use the speaker cords as follows:

- Front speaker (L): White
- Front speaker (R): Red

Be careful with the orientation of the post. Thread the speaker cord (and the speaker system cord) into the end of the post that has two holes.

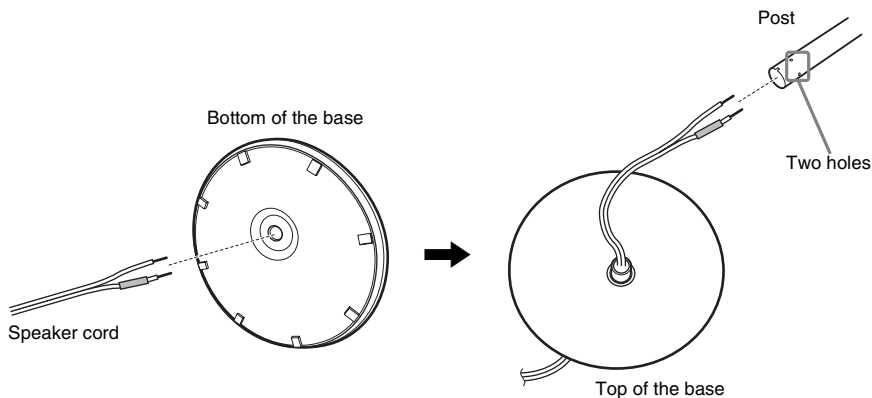

## 2 Attach the post cover to the other end of the post.

Orient the slot toward you, attach the post cover so that the slot of the post engages with the tab of the post cover, then secure with the screw.

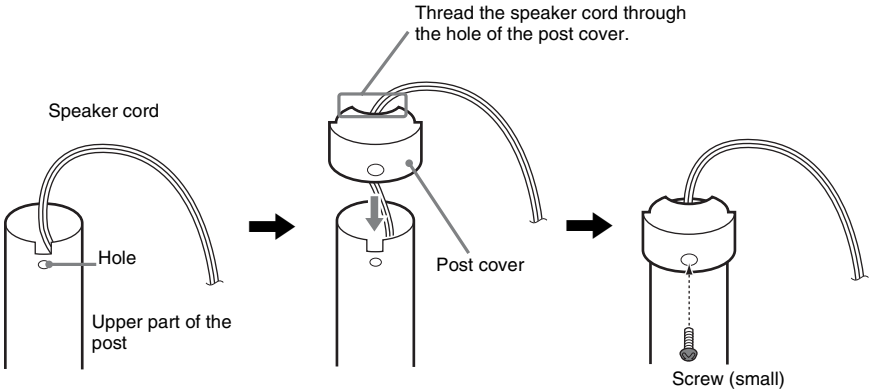

## 3 Lay the post in the slot of the speaker, slide the post to the end of the slot, then secure the post with the mounting plate and screws.

Select the speaker whose jack color on its rear panel matches the color tube of the speaker cord.

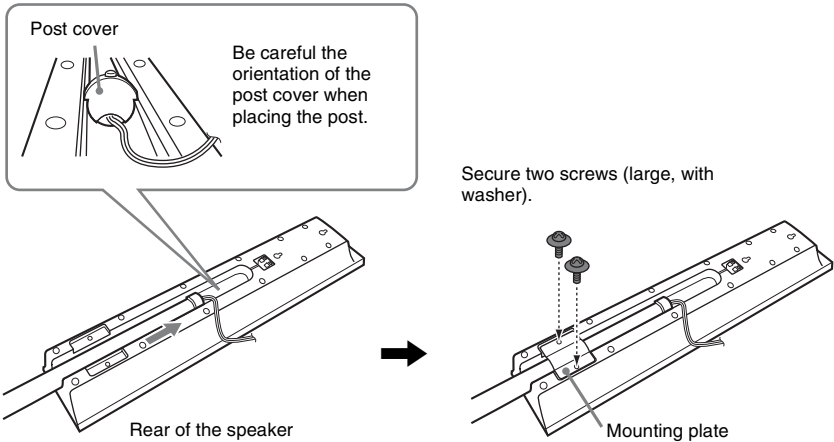

#### 4 Connect the speaker cords to the speaker.

Be sure to match the speaker cords to the appropriate terminals on the speakers: the speaker cord with the color tube to  $\oplus$ , and the speaker cord without the color tube to  $\ominus$ .

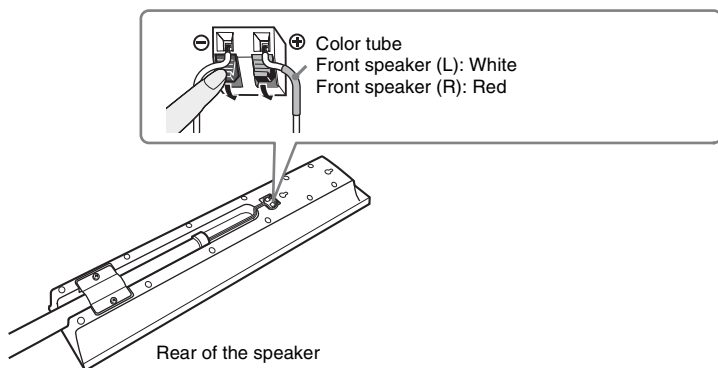

#### 5 Attach the post to the base.

Insert the post so that the slit on the lower part of the post aligns with the projection of the base, then secure the post with the two screws.

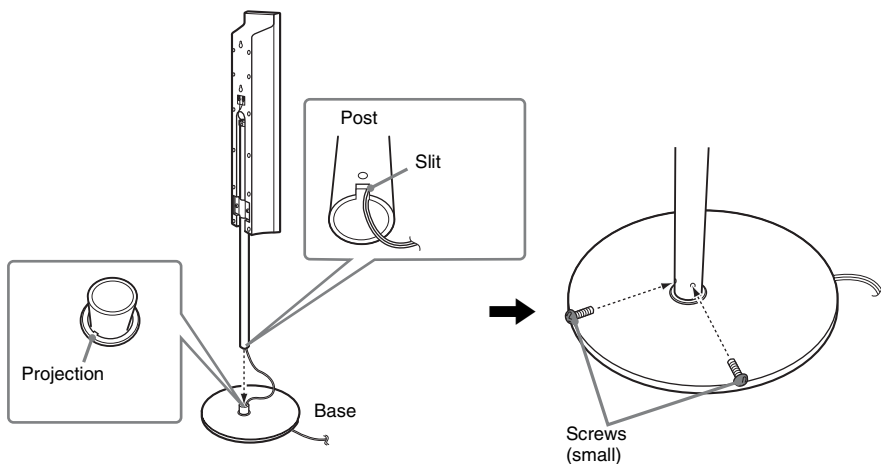

#### Note

- Make sure that the slot on the post aligns with the projection of the base by rotating the post slightly.

## 6 Adjust the height of the speaker.

Loosen (but do not remove) the screws, adjust the height of the speaker, then secure the screws. Adjust the speaker of one side, then adjust another speaker by checking lines as a guide.

### Note

- When adjusting the height of the speaker, grasp the speaker so that the speaker does not fall.

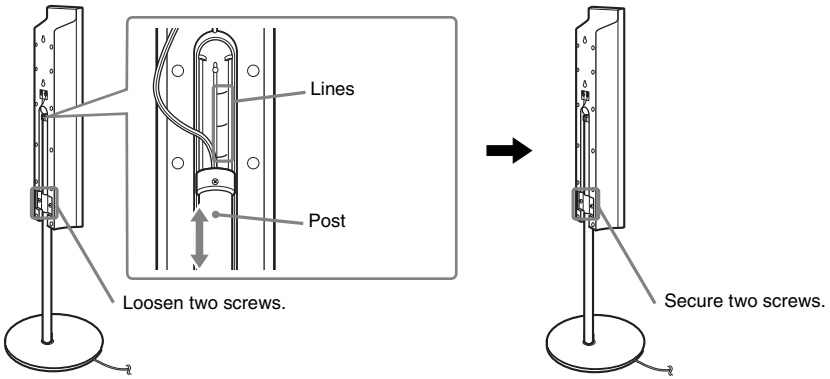

## 7 Take up any speaker cord slack.

Take up slack in the speaker cord by pulling from the bottom of the base.

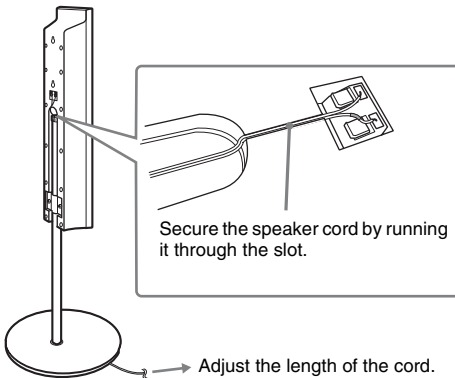



## Fully-assembled illustration

Front speaker (L):  
White label

Front speaker (R):  
Red label

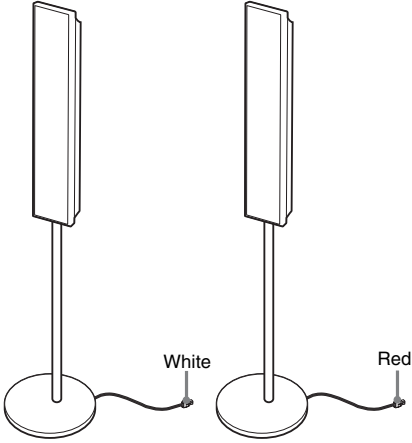

## Step 2: Positioning the System

For the best possible surround sound, all the speakers other than the subwoofer should be placed at the same distance from the listening position (A).

However, this system allows you to place the center speaker up to 1.6 meters (5 ft) closer (B) and the surround speakers up to 5.0 meters (16 ft) closer (C) to the front speakers.

The front speakers can be placed from 1.0 to 7.0 meters (3 to 23 ft) (A) from the listening position.

Place the system as illustrated below.

### DAV-HDX275/DAV-HDX276

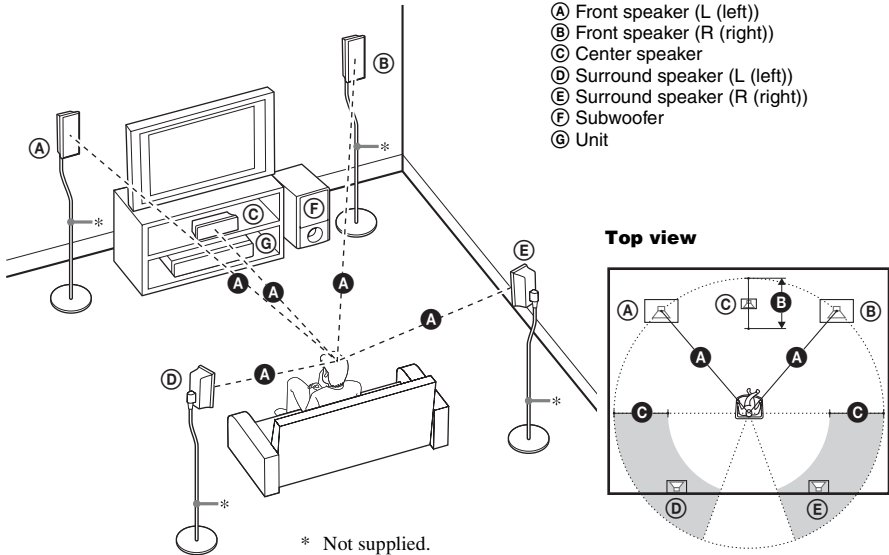

## DAV-HDX475

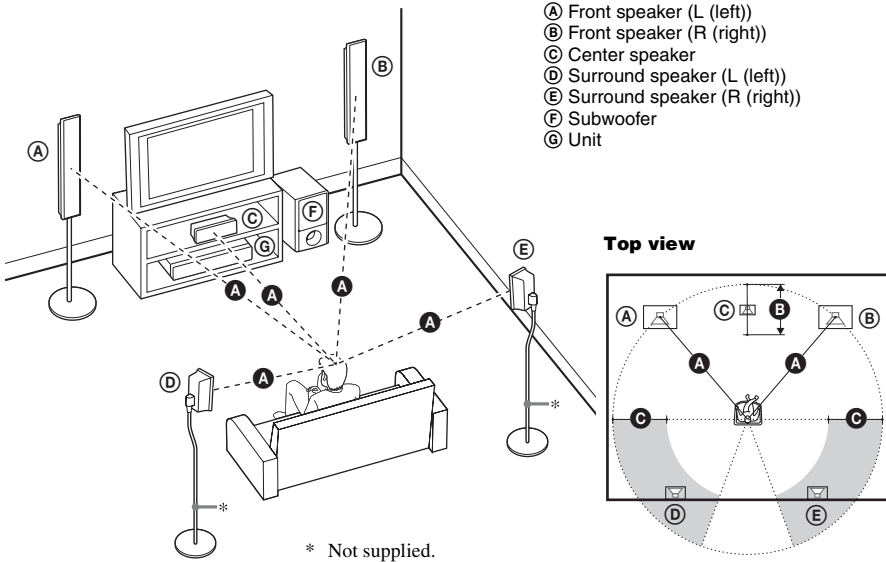

### Note

- Do not set the speakers in an inclined position.
- Do not place the speakers in locations that are:
  - Extremely hot or cold
  - Dusty or dirty
  - Very humid
  - Subject to vibrations
  - Subject to direct sunlight
- Use caution when placing the speakers and/or speaker stands attached to the speakers on a specially treated (waxed, oiled, polished, etc.) floor, as staining or discoloration may result.
- Do not use any type of abrasive pad, scouring powder, or solvent such as alcohol or benzene.
- Do not lean or hang on the speaker, as the speaker may fall down.

### Tip

- When you change the positions of the speakers, Sony recommends that you change the settings. For details, see “Getting Optimal Surround Sound for a Room” (page 83) and “Calibrating the Appropriate Settings Automatically” (page 84).

## To install the speakers on a wall

Before installing the speakers on a wall, connect the speaker cord to the speaker.

Be sure to match the speaker cords to the appropriate terminals on the speakers: the speaker cord with the color tube to  $\oplus$ , and the speaker cord without the color tube to  $\ominus$ .



Color tube  
 Front speaker (L): White  
 Front speaker (R): Red  
 Center speaker: Green  
 Surround speaker (L): Blue  
 Surround speaker (R): Gray

- 1 Prepare screws (not supplied) that are suitable for the hole on the back of each speaker. See the illustrations below.**

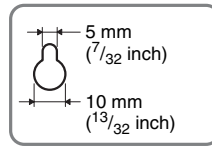
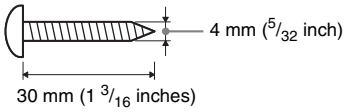

Hole on the back of the speaker

- 2 Fasten the screws to the wall.**

### DAV-HDX275/DAV-HDX276

**For the center speaker**

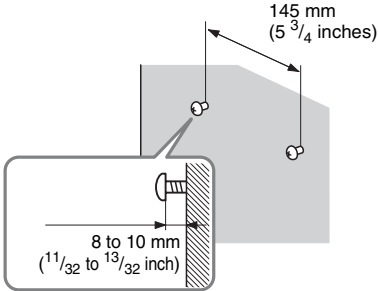

**For the other speakers**

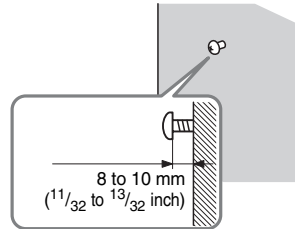

### DAV-HDX475

**For the center speaker**

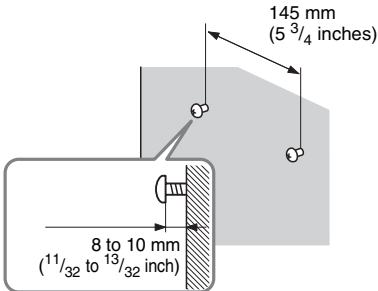

**For the front speakers**

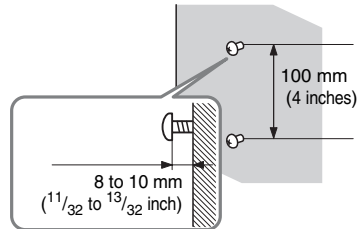

**For the surround speakers**

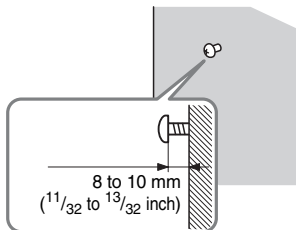

### 3 Hang the speakers on the screws.

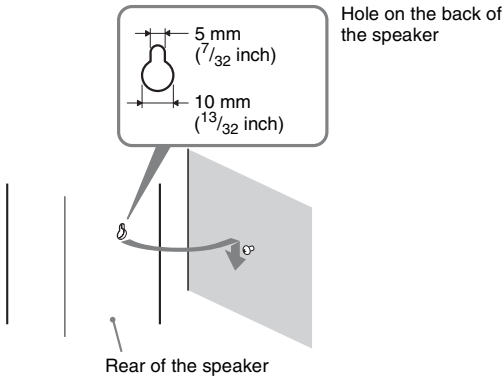

#### Note

- Use screws that are suitable for the wall material and strength. As a plaster board wall is especially fragile, attach the screws securely to a beam and fasten them to the wall. Install the speakers on a vertical and flat wall where reinforcement is applied.
- Contact a screw shop or installer regarding the wall material or screws to be used.
- Sony is not responsible for accident or damage caused by improper installation, insufficient wall strength or improper screw installation, natural calamity, etc.

## Step 3: Connecting the System

See the connection diagram below, and read the additional information from ① to ⑤ on the following pages.

### Note

- Be sure to make connections securely to avoid hum and noise.
- When you connect another component with a volume control, turn up the volume of the other components to a level where sound is not distorted.

### DAV-HDX275/DAV-HDX276

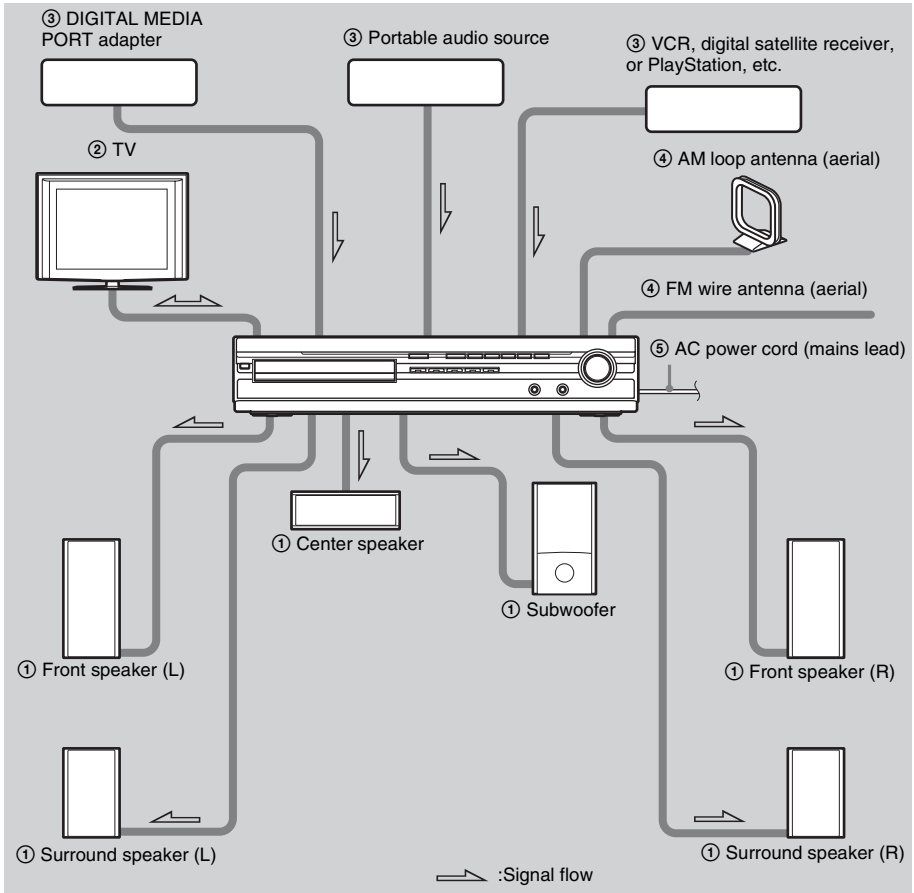

# DAV-HDX475

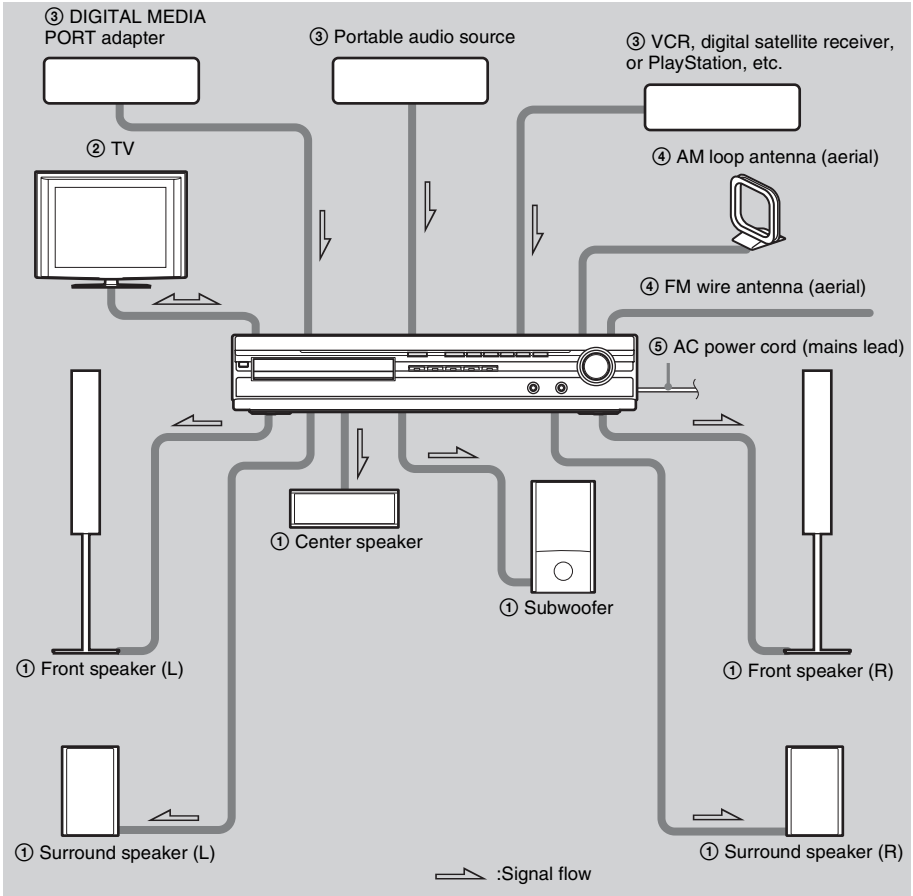

## ① Connecting the Speakers

The connector and color tube of the speaker cords are the same color as the label of the jacks to be connected. Be sure to match the speaker cords to the appropriate terminals on the speakers: the speaker cord with the color tube to  $\oplus$ , and the speaker cord without the color tube to  $\ominus$ . Do not catch the speaker cord insulation in the speaker terminals.

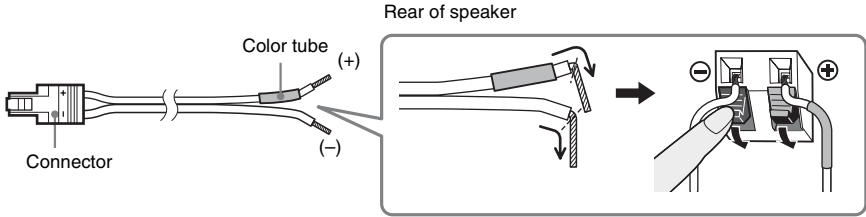

When connecting to the unit, insert the connector until it clicks.

### DAV-HDX276

Rear panel

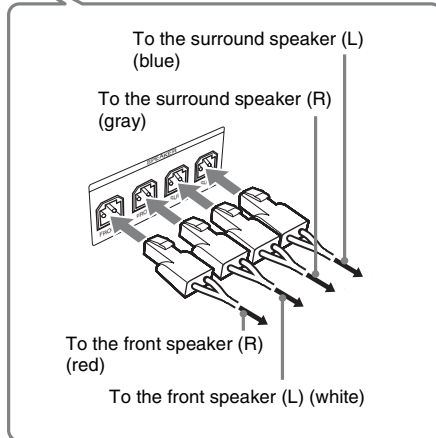
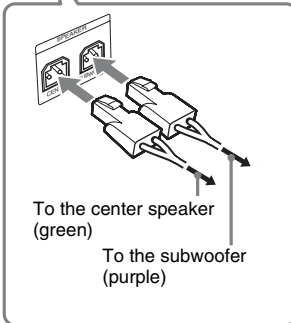
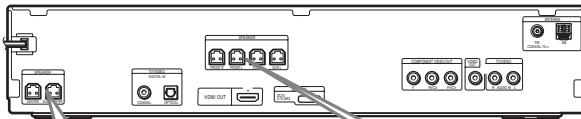



# DAV-HDX275/DAV-HDX475

Rear panel

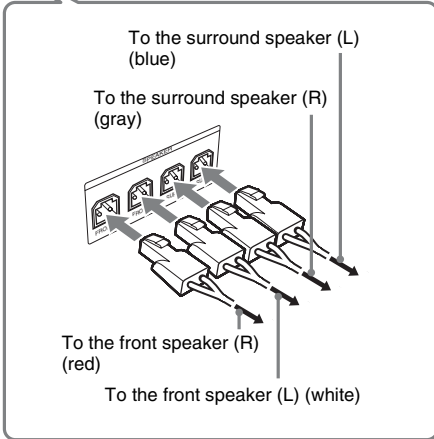
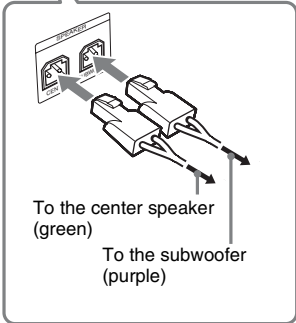
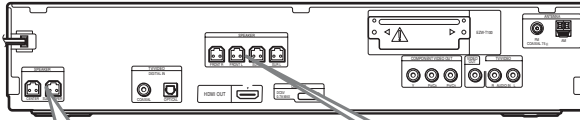

## ② Connecting the TV

Use the parts as follows:

- Video cord (1)

To listen to TV sound from the six speakers of the system, connect the TV and the system with the audio cord (not supplied) (A).

For video output to your TV, check the video input jacks of the TV, and select connection method A, B, or C. Picture quality improves in order from A (standard) to C (HDMI).

When the TV has the digital optical or coaxial output jack, you can improve sound quality by connecting with the digital cord (B).

### DAV-HDX276

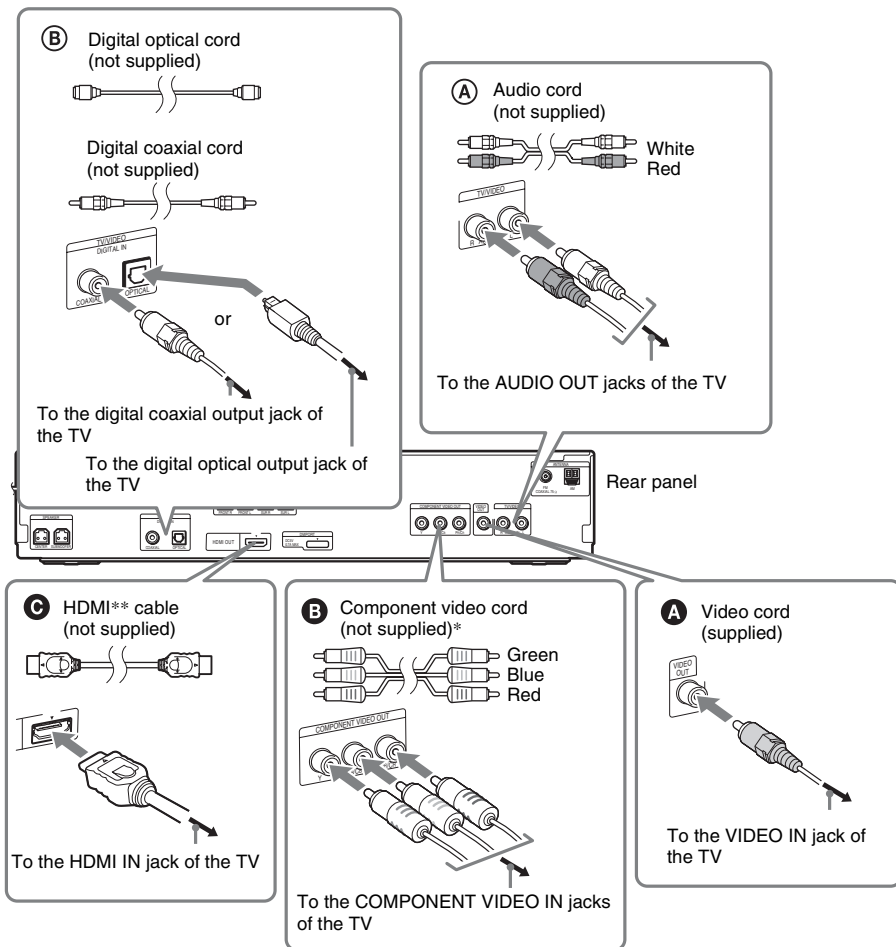

## DAV-HDX275/DAV-HDX475

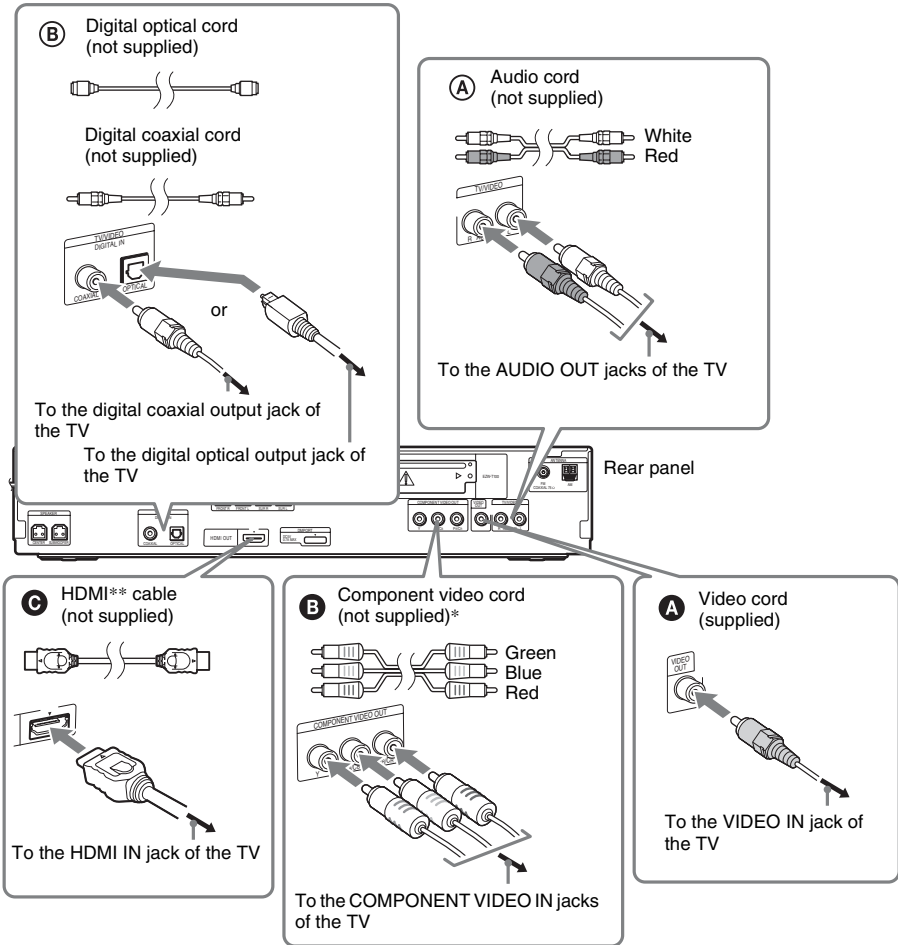

\* If your TV accepts progressive format signals, use this connection and set the output signal of the system to progressive format (page 37).

\*\* HDMI (High-Definition Multimedia Interface)

If your TV has the HDMI jack, use this connection and select the type of output signal (page 37).

### Note

- During the "DMPORT" function, video signal is not output from the HDMI OUT and COMPONENT VIDEO OUT jacks.
- The system can accept both digital and analog signals. Digital signals have priority over analog signals. (COAXIAL has priority over OPTICAL.) If the digital signal ceases, the analog signal will be processed after 2 seconds.

### Tip

- You can connect another component, such as a VCR, digital satellite receiver, or PlayStation, to the TV/VIDEO jacks (A) or (B) instead of the TV.

**To change the color system (PAL or NTSC) (Asian, Australian, and Middle Eastern models only)**

Depending on the TV to be connected, you may be required to select either PAL or NTSC for the color system.

The initial setting of the system for Australian and Middle Eastern models is PAL.

The initial setting of the system for Asian models is NTSC.

- 1 Turn off the system by pressing I/⏻.**
- 2 Turn on the system by pressing I/⏻ while pressing II on the unit.**

Each time you perform this operation, the color system toggles between PAL and NTSC.

“NTSC” lights up in the front panel display when the color system is set to NTSC.

### ③ Connecting the other components

You can enjoy the connected component using the six speakers of the system.

- Portable audio source: **A**
- DIGITAL MEDIA PORT adapter: **B**

#### DAV-HDX276

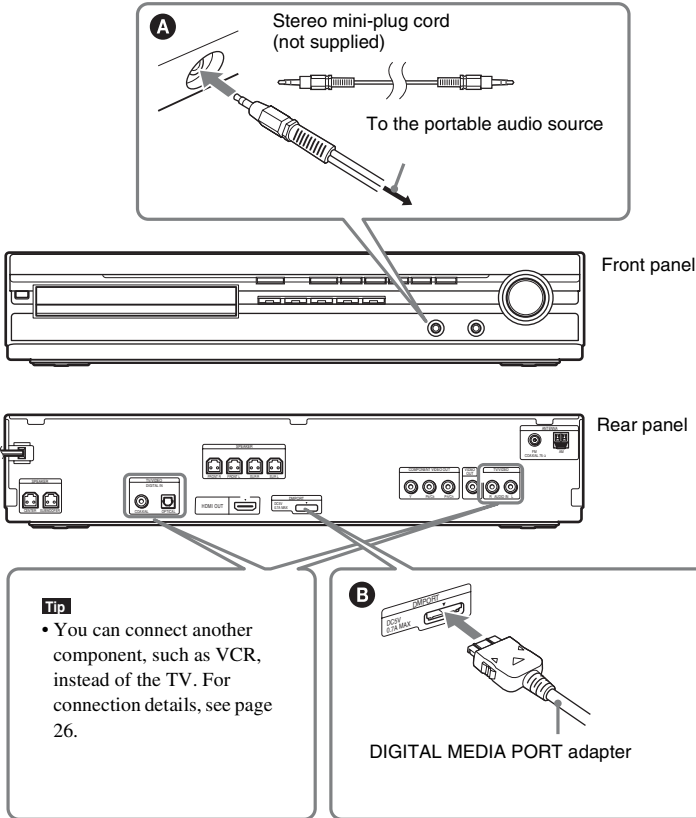

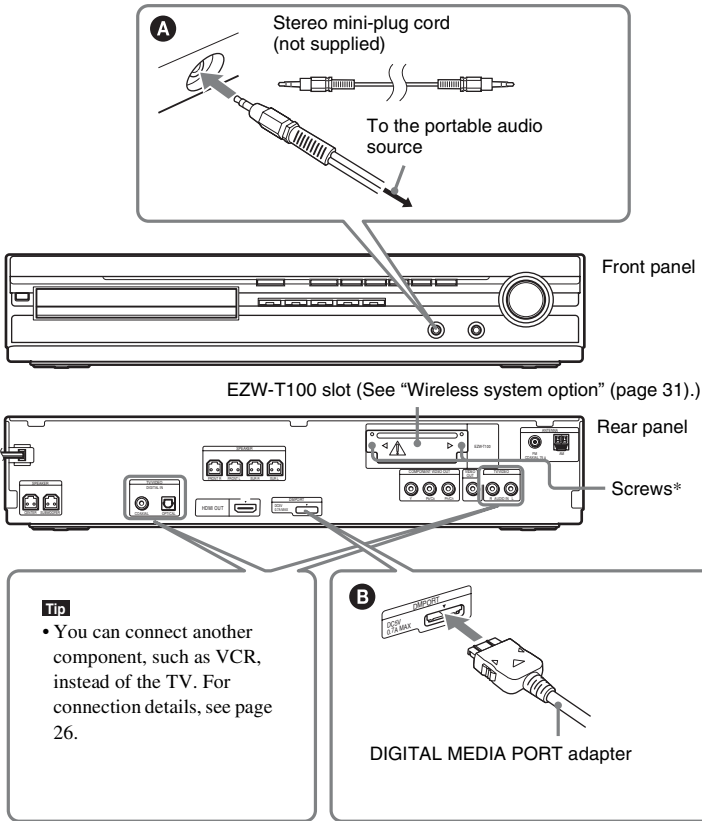
**DAV-HDX275/DAV-HDX475**\* **CAUTION**

Please do not remove the screws before installing the EZW-T100 (page 77).

**To connect the DIGITAL MEDIA PORT adapter**

Connect a DIGITAL MEDIA PORT adapter (TDM-iP10 is supplied for North American models only) to the DMPORT jack. For details, see "Using the DIGITAL MEDIA PORT Adapter" (page 76).

**Note**

- Connect the DIGITAL MEDIA PORT adapter so that the ▼ marks are aligned. When disconnecting, pull out while pressing **A**.

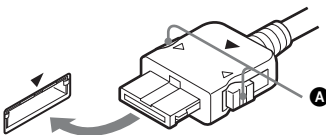

## Wireless system option (DAV-HDX275/DAV-HDX475 only)

By using an S-AIR product (not supplied), you can enjoy wireless performance by transmission from the system. For details, see “Using an S-AIR Product” (page 77) or refer to the operating instructions of the S-AIR product.

### If your TV has multiple audio/video inputs

You can enjoy the sound with the speakers of the system through the connected TV. Connect the components as follows.

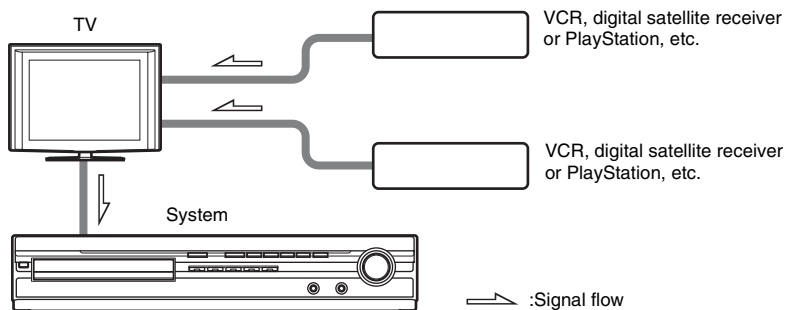

Select the component on the TV. For details, refer to the operating instructions of the TV.  
If the TV does not have multiple audio/video inputs, a switcher will be necessary to receive the sound from more than two components.

## ④ Connecting the antenna (aerial)

### DAV-HDX276

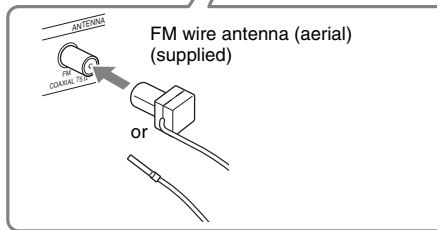
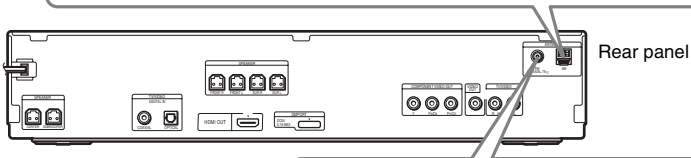
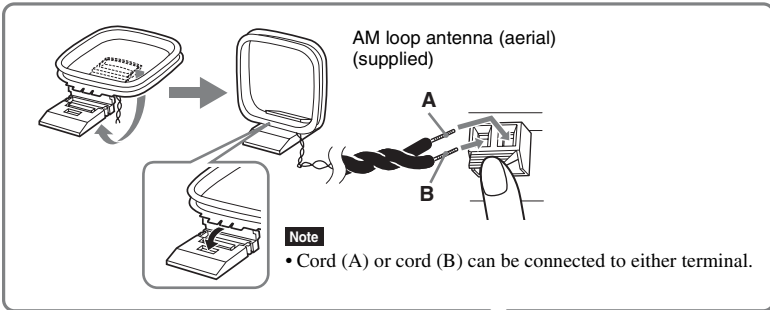



## DAV-HDX275/DAV-HDX475

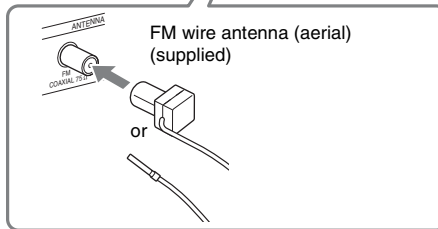
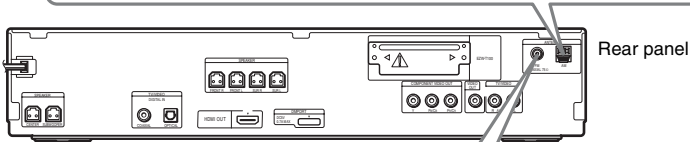
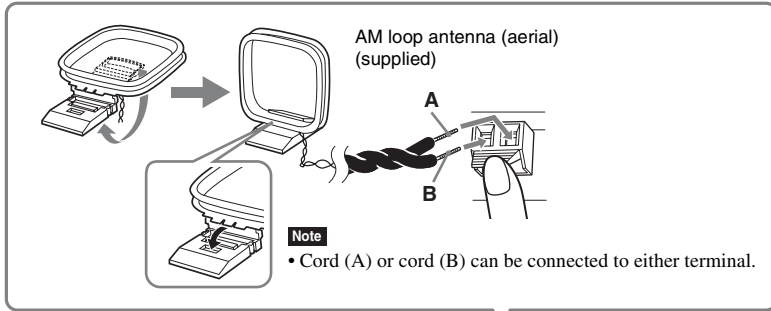

### Note

- Keep the AM loop antenna (aerial) and cord away from the system or other AV components, as noise may result.
- Be sure to fully extend the FM wire antenna (aerial).
- After connecting the FM wire antenna (aerial), keep it as horizontal as possible.

### Tip

- Adjust the direction of the AM loop antenna (aerial) for best AM broadcast sound.
- If you have poor FM reception, use a 75-ohm coaxial cable (not supplied) to connect the unit to an outdoor FM antenna (aerial) as shown below.

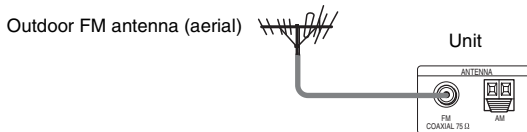

## ⑤ Connecting the AC power cord (mains lead)

Before connecting the AC power cord (mains lead) of the unit to a wall outlet (mains), connect all the speakers to the unit.

### DAV-HDX276

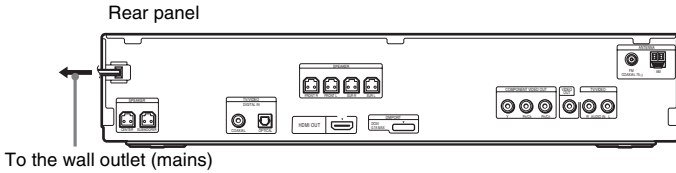

### DAV-HDX275/DAV-HDX475

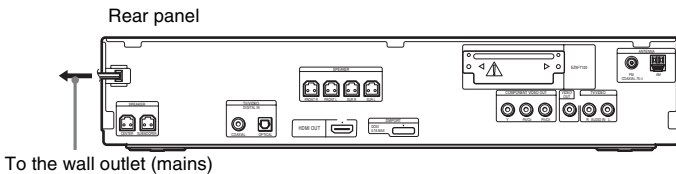

## About the demonstration

After connecting the AC power cord (mains lead), the demonstration appears in the front panel display.

### Setting the demonstration mode to on/off

- 1** Press **I/⏻** on the unit.  
The system turns on.
- 2** Press **SYSTEM MENU**.
- 3** Press **↑/↓** repeatedly until “**DEMO**” appears in the front panel display, then press **⊕** or **→**.
- 4** Press **↑/↓** to select a setting.
  - “**DEMO ON**”: On.
  - “**DEMO OFF**”: Off.
- 5** Press **⊕**.  
The setting is made.
- 6** Press **SYSTEM MENU**.  
The system menu turns off.

#### Tip

- When you purchase the system from new, or if the system is at its factory default settings (ex., after performing “**COLD RESET**” (page 90)), you can turn off the demonstration simply by pressing **I/⏻** on the remote.

## Step 4: Performing the Quick Setup

Follow the Steps below to make the basic adjustments for using the system.

### Note

- When you connect the system and the TV with the component video cord (not supplied) or HDMI cable (not supplied), you need to set the type of video output for matching your TV. For details, see “Setting the type of video output to match your TV” (page 37).

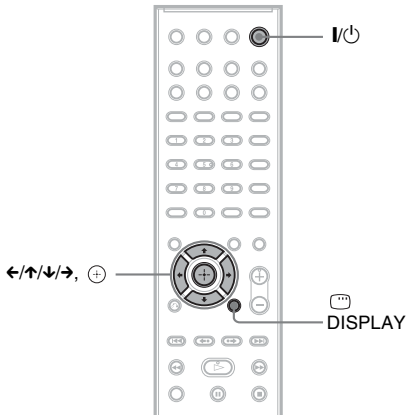

### 1 Turn on the TV.

### 2 Press I/O.

### Note

- Make sure that the function is set to “DVD” (page 38).

### 3 Switch the input selector on your TV so that the signal from the system appears on the TV screen.

[Press [ENTER] to run QUICK SETUP.] appears at the bottom of the TV screen. If this message does not appear, recall the Quick Setup display (page 36) and perform again.

### 4 Press ⊕ without inserting a disc.

The Setup Display for selecting the language used in the on-screen display appears.

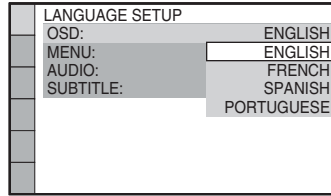

### 5 Press ↑/↓ to select a language.

The system displays the menu and subtitles in the selected language.

### 6 Press ⊕.

The Setup Display for selecting the aspect ratio of the TV to be connected appears.

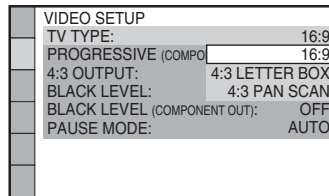

### 7 Press ↑/↓ to select the setting that matches your TV type.

■ If you have a wide-screen TV or a 4:3 standard TV with a wide-screen mode [16:9] (page 63)

■ If you have a 4:3 standard TV [4:3 LETTER BOX] or [4:3 PAN SCAN] (page 63)

### 8 Press ⊕.

The Setup Display for selecting the speaker formation appears.

### 9 Press ←/→ to select the speaker formation image as the speakers are actually positioned.

For details, see “Getting Optimal Surround Sound for a Room” (page 83).

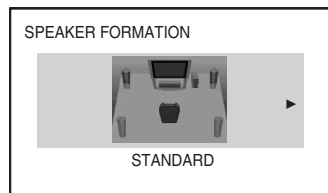

**10** Press  $\oplus$ .

**11** Connect the calibration mic to the **A.CAL MIC** jack on the front panel.

Set up the calibration mic at the ear level using a tripod, etc. (not supplied). The front of each speaker should face the calibration mic, and there should be no obstruction between the speakers and the calibration mic.

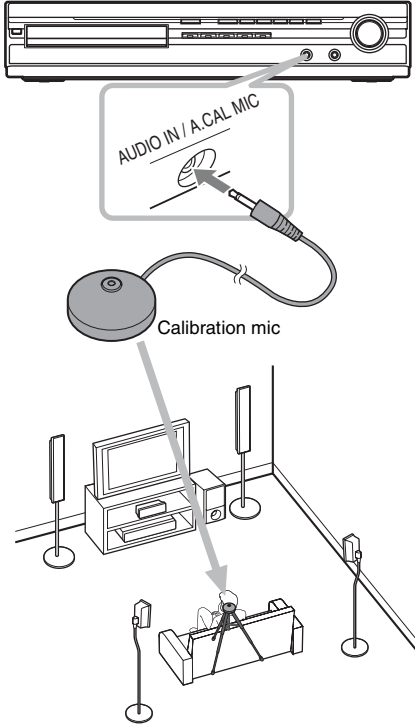

**12** Press  $\leftarrow/\rightarrow$  to select [YES].

**Note**

- Make sure that the headphones are not connected to the unit or surround amplifier\*. You cannot operate following Steps with the headphones connected.

\* DAV-HDX275/DAV-HDX475 only.

**13** Press  $\oplus$ .

[AUTO CALIBRATION] starts.  
Be quiet during the measurement.

**Note**

- Loud test sound is output when [AUTO CALIBRATION] starts. You cannot turn the volume down. Give consideration to children and neighbors.
- Before [AUTO CALIBRATION], install the surround amplifier in the appropriate location. If you install the surround amplifier in an improper location, such as another room, proper measurement will not be obtained. (DAV-HDX275/DAV-HDX475 only.)
- Avoid being in the measurement area and making noise during the measurement (which takes about 3 minutes), as it may interfere with measurement.

**14** Unplug the calibration mic and press  $\leftarrow/\rightarrow$  to select [YES].

**Note**

- The environment of the room in which the system is installed may affect measurements.
- If measurement fails, follow the message then retry [AUTO CALIBRATION].

**15** Press  $\oplus$ .

Quick Setup is finished. All connections and setup operations are complete.

**To quit the Quick Setup**

Press  $\square$  DISPLAY in any Step.

**Tip**

- If you change the position of the speakers, reset the speaker settings. See “Getting Optimal Surround Sound for a Room” (page 83) and “Calibrating the Appropriate Settings Automatically” (page 84).
- If you want to change any of the settings, see “Using the Setup Display” (page 61).

**To recall the Quick Setup display**

**1** Press **FUNCTION +/-** repeatedly until “DVD” appears in the front panel display.

**2** Press  $\square$  **DISPLAY** while the system is in stop mode.

The Control Menu display appears on the TV screen.

**3** Press  $\uparrow/\downarrow$  to select  $\square$  [SETUP], then press  $\oplus$ .

The options for [SETUP] appear.

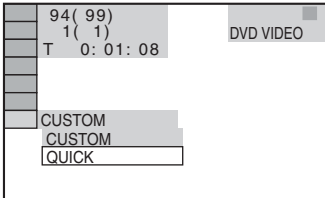

- 4** Press  $\uparrow/\downarrow$  to select [QUICK], then press  $\oplus$ .

The Quick Setup display appears.

## Setting the type of video output to match your TV

Depending on the connection of the TV (page 26), select the type of video output of the system.

### To select the type of video signal output from the HDMI OUT jack

When you connect the unit and the TV with the HDMI cable, select the type of video signals output from the HDMI OUT jack.

For details, refer also to the operating instructions supplied with the TV/projector, etc.

- 1** Press **FUNCTION +/-** repeatedly until "DVD" appears in the front panel display.
- 2** Press **DISPLAY** while the system is in stop mode.  
The Control Menu display appears on the TV screen.
- 3** Press  $\uparrow/\downarrow$  to select **[SETUP]**, then press  $\oplus$ .  
The options for [SETUP] appear.
- 4** Press  $\uparrow/\downarrow$  to select [CUSTOM], then press  $\oplus$ .  
The Setup Display appears.
- 5** Press  $\uparrow/\downarrow$  to select [HDMI SETUP], then press  $\oplus$ .  
The options for [HDMI SETUP] appear.
- 6** Press  $\uparrow/\downarrow$  to select [HDMI RESOLUTION], then press  $\oplus$ .

- 7** Press  $\uparrow/\downarrow$  to select the desired setting, then press  $\oplus$ .

- [AUTO (1920 × 1080p)]: The system outputs the optimal video signal for the connected TV.
  - [1920 × 1080i]: The system outputs 1920 × 1080i\* video signals.
  - [1280 × 720p]: The system outputs 1280 × 720p\* video signals.
  - [720 × 480p]\*\*: The system outputs 720 × 480p\* video signals.
- \* i: interlace, p: progressive  
 \*\* Depending on the country model, [720 × 576p] may appear.

#### Note

- When "HDMI" lights up in the front panel display, images other than [720 × 480p] or [720 × 576p] are stretched vertically.

### Does your TV accept progressive signals?

Progressive is the method for displaying TV images which reduces flickering and sharpens the image. To use this method, you need to connect to a TV that accepts progressive signals.

- 1** Press **FUNCTION +/-** repeatedly until "DVD" appears in the front panel display.
- 2** Press **DISPLAY** while the system is in stop mode.  
The Control Menu display appears on the TV screen.
- 3** Press  $\uparrow/\downarrow$  to select **[SETUP]**, then press  $\oplus$ .  
The options for [SETUP] appear.
- 4** Press  $\uparrow/\downarrow$  to select [CUSTOM], then press  $\oplus$ .  
The Setup Display appears.
- 5** Press  $\uparrow/\downarrow$  to select [VIDEO SETUP], then press  $\oplus$ .  
The options for [VIDEO SETUP] appear.
- 6** Press  $\uparrow/\downarrow$  to select [PROGRESSIVE (COMPONENT OUT)], then press  $\oplus$ .
- 7** Press  $\uparrow/\downarrow$  to select the desired setting, then press  $\oplus$ .

[OFF]: The system does not output progressive signals. Select this setting when:

- your TV does not accept progressive signals, or,
- your TV is connected to jacks other than the COMPONENT VIDEO OUT jacks.

[ON]: The system outputs progressive signals. Select this setting when:

- your TV accepts progressive signals, and,
- the TV is connected to the COMPONENT VIDEO OUT jacks.

When you select [ON], the confirmation display appears. Follow the Steps below.

## 8 Press $\leftarrow/\rightarrow$ to select [START], then press $\oplus$ .

The system outputs the progressive signal for 5 seconds. Check that the screen is displayed correctly.

## 9 Press $\leftarrow/\rightarrow$ to select [YES].

The system outputs the progressive signal. When you select [NO], the system does not output the progressive signal.

## Step 5: Enjoying Sound from all the Speakers

You can enjoy DVD, TV, or VCR sound from all the speakers in this system.

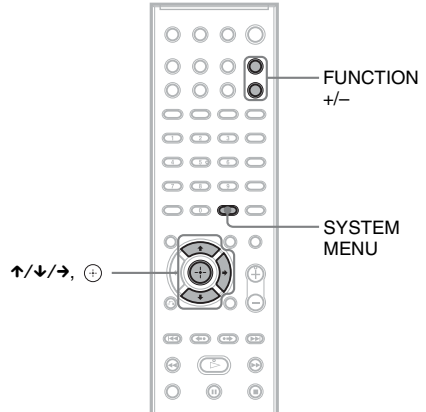

## 1 Press FUNCTION +/- repeatedly until the desired function appears in the front panel display.

Each time you press FUNCTION +/-, the function changes as follows.

“DVD” → “TUNER FM” → “TUNER AM” → “TV/VIDEO” → “DMPort” → “AUDIO” → ...

Function	Source
“DVD”	Disc that is played by the system
“TUNER FM”/ ”TUNER AM”	FM/AM radio (page 70)
“TV/VIDEO”	TV (or the component that is connected to the TV/VIDEO jacks on the rear panel)
“DMPort”	DIGITAL MEDIA PORT adapter (page 76)
“AUDIO”	Portable audio source (that is connected to the AUDIO IN jack on the front panel)

**Note**

- When you use both the TV/VIDEO (AUDIO IN) jacks (analog connection) and TV/VIDEO (COAXIAL or OPTICAL DIGITAL IN) jack (digital connection) at the same time, the digital connection takes priority.

**2 Press SYSTEM MENU.****3 Press  $\uparrow/\downarrow$  repeatedly until “DEC. MODE” appears in the front panel display, then press  $\oplus$  or  $\rightarrow$ .****4 Press  $\uparrow/\downarrow$  repeatedly until the decoding mode you want appears in the front panel display.**

When you want to output the TV sound or stereo sound of a 2 channel source from the six speakers, select the “PRO LOGIC,” “PLII MOVIE,” or “PLII MUSIC” decoding mode.

For details, see page 40.

**5 Press  $\oplus$ .**

The setting is made.

**6 Press SYSTEM MENU.**

The system menu turns off.

**Note**

- Depending on your TV, you may need to turn off your TV’s speaker to enjoy surround sound of the system.

**Tip**

- When listening to audio files using a portable audio source, you can enhance the sound. Press FUNCTION +/- to select “AUDIO.” Connect the portable audio source. Select “A.F.D. STD” for “DEC. MODE.” To cancel, select other than “A.F.D. STD.”

## Changing the input level of the sound from connected components

Distortion may occur when you listen to a component connected to the TV/VIDEO jacks on the rear panel, or to the AUDIO IN jack on the front panel. Distortion is not a malfunction and will depend on the component connected. To prevent distortion, reduce the input level on the unit.

**1 Press FUNCTION +/- repeatedly until “TV/VIDEO” or “AUDIO” appears in the front panel display.****2 Press SYSTEM MENU.****3 Press  $\uparrow/\downarrow$  repeatedly until “ATTENUATE” appears in the front panel display, then press  $\oplus$  or  $\rightarrow$ .****4 Press  $\uparrow/\downarrow$  to select a setting.**

- “ATT ON”: You can attenuate the input level. The output level is changed.
- “ATT OFF”: Normal input level.

**5 Press  $\oplus$ .**

The setting is made.

**6 Press SYSTEM MENU.**

The system menu turns off.

## Enjoying Surround Sound by Using Decoding Mode

You can enjoy surround sound simply by selecting one of the system's pre-programmed decoding modes. They bring exciting and powerful sound of movie theaters into your home.

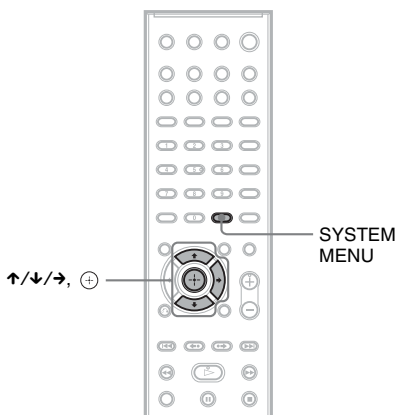

- 1** Press **SYSTEM MENU**.
- 2** Press **↑/↓** repeatedly until “DEC. MODE” appears in the front panel display, then press **⊕** or **→**.
- 3** Press **↑/↓** repeatedly until the decoding mode you want appears in the front panel display.

Display	Decoding mode	Effect
“A.F.D. STD”	AUTO FORMAT DIRECT STANDARD	Presents sound as it was recorded/encoded. Depending on the source, the speakers that output sound will vary.
“A.F.D. MULTI”	AUTO FORMAT DIRECT MULTI	2 channel source: Sound that is recorded in 2 channel (front left and right channel) is also assigned to the surround left and right channel. This mode outputs sound from the front left and right speakers, surround left and right speakers, and subwoofer. The center speaker does not output any sound. Multi channel source: Depending on the source, speakers that output the sound will vary.
“PRO LOGIC”	Dolby Pro Logic	Performs Pro Logic decoding to the input signal and simulates surround sound from 2 channel sources. This mode outputs sound from all the speakers and subwoofer. Sound may not be output from all speakers depending on the source.



Display	Decoding mode	Effect
“PLII MOVIE”	Dolby Pro Logic II MOVIE	Performs Pro Logic II movie mode decoding to the input signal and produces five full-bandwidth output channels from 2 channel sources. This setting is ideal for watching videos of overdubbed or old movies. This mode outputs sound from all the speakers and subwoofer. Sound may not be output from all speakers depending on the source.
“PLII MUSIC”	Dolby Pro Logic II MUSIC	Performs Pro Logic II music mode decoding to the input signal and produces five full-bandwidth output channels from 2 channel sources. This setting is ideal for normal stereo sources such as a CD. This mode outputs sound from all the speakers and subwoofer. Sound may not be output from all speakers depending on the source.
“2CH STEREO”	2 CHANNEL STEREO	Outputs the sound from the front left and right speakers and subwoofer. Multi channel surround formats are downmixed to 2 channels.
“HP 2CH”	HEADPHONE 2 CHANNEL STEREO	Outputs the sound from headphone left and right. Multi channel surround formats are downmixed to 2 channels.
“HP VIRTUAL”	HEADPHONE VIRTUAL	Outputs the sound as surround from headphone left and right. This mode is effective only when a multi channel source is played.

#### 4 Press $\oplus$ .

The setting is made.

#### 5 Press SYSTEM MENU.

The system menu turns off.

### To turn the surround effect off

Select “A.F.D. STD” or “2CH STEREO” for “DEC. MODE.”

#### Note

- When the input signal is multi channel source, “PRO LOGIC,” “PLII MOVIE,” and “PLII MUSIC” are canceled and the multi channel source is output directly.
- When the bilingual broadcast sound is input, “PRO LOGIC,” “PLII MOVIE,” and “PLII MUSIC” are not effective.
- Depending on the input stream, the decoding mode may not be effective.
- When you select “A.F.D. MULTI,” the surround or stereo effect may not be effective. In this case, select “A.F.D. STD,” “PRO LOGIC,” “PLII MOVIE,” or “PLII MUSIC.”
- When changing the decoding mode while using the S-AIR receiver, sound from the S-AIR receiver may skip.

# Selecting the Sound Mode

You can select a suitable sound mode for movies or music.

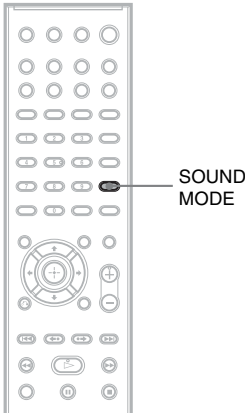

**Press SOUND MODE repeatedly during playback until the desired mode appears in the front panel display.**

- **"AUTO"**: The system selects "MOVIE" or "MUSIC" automatically to produce the sound effect depending on the disc.
- **"MOVIE"**: The system provides the sound for movies.
- **"MUSIC"**: The system provides the sound for music.

**Note**

- You cannot operate these setup items when you connect headphones to the unit or surround amplifier\*.
- \* DAV-HDX275/DAV-HDX475 only.
- When changing the sound mode while using the S-AIR receiver, sound from the S-AIR receiver may skip (DAV-HDX275/DAV-HDX475 only).

# Enjoying Multiplex Broadcast Sound

## (DUAL MONO)

You can enjoy multiplex broadcast sound when the system receives or plays the Dolby Digital multiplex broadcast signal.

**Note**

- To receive the Dolby Digital signal, you need to connect a TV or other component to the unit with an optical or coaxial digital cord (page 26) and set the digital output mode of the TV or other component to Dolby Digital.

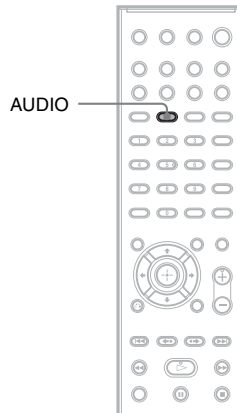

**Press AUDIO repeatedly until the desired signal appears in the front panel display.**

- **"MAIN"**: Sound of the main language will be output.
- **"SUB"**: Sound of the sub language will be output.
- **"MAIN+SUB"**: Mixed sound of both the main and sub languages will be output.

# Playing a Disc

DVD-V

DVD-VR

VIDEO CD

Super Audio CD

C D

DATA-CD

DATA DVD

Depending on the DVD VIDEO or VIDEO CD, some operations may be different or restricted. Refer to the operating instructions supplied with your disc.

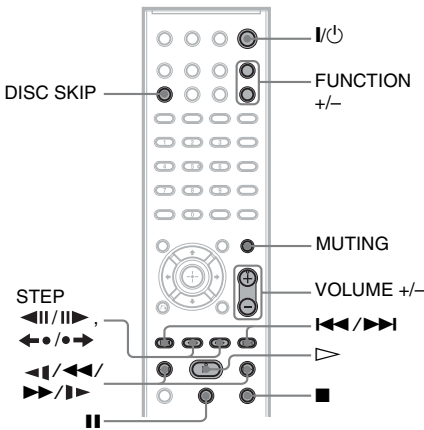
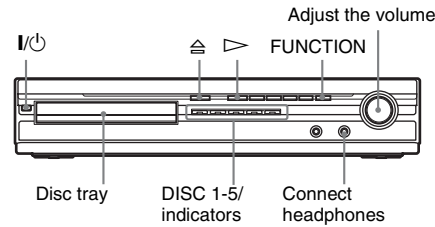

- 1** Turn on your TV.
- 2** Switch the input selector on the TV to this system.
- 3** Press I/Power.  
The system turns on.  
Unless the system is set to "DVD," press FUNCTION +/- to select "DVD."
- 4** Press DISC 1-5.

Press the button of the disc number you want.

When no disc is in the disc stoker you select, "NO DISC" appears in the front panel display. Perform next Step while "\*DISC-1\* (eg., 2-5)" flashes.

- 5** Press

- 6** Load a disc.

Place one disc on the tray, and then press .

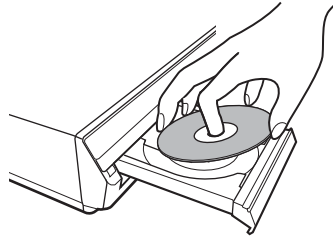

### Note

- When you play an 8 cm disc, place it on the inner circle of the tray. Be careful that the disc is not skewed on the inner circle of the tray.
- Do not forcibly press the disc tray closed with your finger, as this may cause malfunction.
- Do not place more than one disc on the tray.

- 7** Press .

The system starts playback (continuous play) of the disc whose DISC indicator is green.

### ■ To load other discs

Press DISC 1-5 (that is not loaded with a disc) and and load the disc.

### ■ To play back other discs

Press DISC SKIP on the remote or DISC 1-5 on the unit.

- 8** Adjust the volume by using VOLUME +/- – on the remote or the VOLUME control on the unit.

The volume level appears on the TV screen and in the front panel display.

### Note

- Depending on the system status, the volume level may not appear on the TV screen.
- When you set the Control for HDMI function to on, the TV that is connected to the system with an HDMI cable (not supplied) can be sync-operated with the

system. For details, see “Using the Control for HDMI Function for “BRAVIA” Sync” (page 73).

**Tip**

- The DISC 1-5 indicators change their color as follows:
  - Green: the disc is selected, or the disc is being played back.
  - Off: there is no disc.
  - Orange: a disc is loaded in the disc stocker but not selected.
  - The indicator turns off if an unplayable disc is inserted.

### To turn the system off

Press **I/C** while the system is on. The system enters standby mode.

### To save power in standby mode

Press **I/C** while the system is on. To enter power saving mode, make sure that the system is in the following status.

- “DEMO” is set to “OFF” (page 34).
- [CONTROL FOR HDMI] is set to [OFF] (page 73).
- “S-AIR STBY” is set to “OFF” (page 80) (DAV-HDX275/DAV-HDX475 only).

### To use the headphones

Connect the headphones to PHONES jack on the unit. The sound of the system is muted.

You can also connect the headphones to PHONES jack on the surround amplifier. (The sound of the system is muted.) (DAV-HDX275/DAV-HDX475 only)

### Other operations

To	Press
Stop	<b>■</b>
Pause	<b>  </b>
Resume play after pause	<b>  </b> or <b>▷</b>
Go to the next chapter, track, or scene <sup>1)</sup>	<b>▶▶</b>
Go back to the preceding chapter, track, or scene <sup>1)</sup>	<b>◀◀</b> twice in a second. When you press <b>◀◀</b> once, you can go to the beginning of the current chapter, track, or scene.

To	Press
Turn off the sound temporarily	<b>MUTING.</b> To cancel, press it again or <b>VOLUME +</b> to adjust the sound volume.
Change a disc while playing another disc	<b>DISC SKIP</b>
Play the desired disc directly	<b>DISC 1-5</b> on the unit.
Stop play and remove the desired disc	<b>DISC 1-5</b> and <b>⊞</b> on the unit.
Locate a point quickly by playing a disc in fast forward or fast reverse (Scan) <sup>1)2)</sup>	<b>▶▶/  ▶</b> or <b>◀◀/◀◀</b> while playing a disc. Each time you press <b>▶▶/  ▶</b> or <b>◀◀/◀◀</b> during scan, the playback speed changes. To return to normal speed, press <b>▷</b> . Actual speeds may differ with some discs.
Watch frame by frame (Slow-motion Play) <sup>3)</sup>	<b>▶▶/  ▶</b> or <b>◀◀/◀◀<sup>4)</sup></b> while the system is in pause mode. Each time you press <b>▶▶/  ▶</b> or <b>◀◀/◀◀<sup>4)</sup></b> during Slow-motion Play, the playback speed changes. Two speeds are available. To return to normal playback speed, press <b>▷</b> .
Play one frame at a time (Freeze Frame) <sup>3)5)6)</sup>	<b>STEP   ▶</b> to go to the next frame while the system is in pause mode. Press <b>STEP ◀  </b> to go to the preceding frame while the system is in pause mode (DVD VIDEO/DVD-R/DVD-RW only). To return to normal playback, press <b>▷</b> .
Replay the previous scene <sup>7)</sup>	<b>◀●</b> (instant replay) during playback.
Briefly fast forward the current scene <sup>8)</sup>	<b>●▶</b> (instant advance) during playback.

<sup>1)</sup>Except for JPEG image files.

<sup>2)</sup>Scan speeds may differ with some discs.

<sup>3)</sup>DVD VIDEO, DVD-R, DVD-RW, VIDEO CD only.

<sup>4)</sup>Except for VIDEO CDs.

<sup>5)</sup>You cannot search for a still picture on a DVD-VR.

<sup>6)</sup>For a DATA CD/DATA DVD, this function works only for DivX video files (except for United Kingdom and North American models).

<sup>7)</sup>DVD VIDEO/DVD-RW/DVD-R only.

The button can be used except for DivX video files (except for United Kingdom and North American models).

<sup>8)</sup>DVD VIDEO/DVD-RW/DVD-R/DVD+RW/DVD+R only.

The button can be used except for DivX video files (except for United Kingdom and North American models).

#### Note

- You may not be able to use the instant replay or instant advance function with some scenes.
- Noise may come from the disc changer when changing discs or turning the system on/off. However, this is just noise produced by the operation of the internal mechanisms and does not indicate a malfunction.

## To turn on/off the DISC 1-5 indicators' illumination

When you do not operate the system for more than 30 minutes, the illumination of the DISC 1-5 indicators starts automatically. You can turn the illumination on/off.

**1** Press **SYSTEM MENU**.

**2** Press **↑/↓** repeatedly until **"ILLUM MODE"** appears in the front panel display, then press **⊕** or **→**.

**3** Press **↑/↓** to select a setting.

- **"ILLUM ON"**: On.
- **"ILLUM OFF"**: Off.

**4** Press **⊕**.

The setting is made.

**5** Press **SYSTEM MENU**.

The system menu turns off.

## Displaying multi-angles and subtitles

### To change the angles

#### DVD-V

If various angles (multi-angles) for a scene are recorded on a DVD VIDEO, you can change the viewing angle.

**Press ANGLE during playback to select the desired angle.**

#### Note

- Depending on the DVD VIDEO, you may not be able to change the angle even if multi-angles are recorded on the DVD VIDEO.

## To display the subtitles

#### DVD-V

#### DVD-VR

#### DATA-CD

#### \* DATA DVD \*

- \* Except for United Kingdom and North American models.

If subtitles are recorded on a disc, you can turn the subtitles on/off during playback. If multilingual subtitles are recorded on the disc, you can change the subtitle language during playback, or turn the subtitles on/off whenever you want.

**Press SUBTITLE during playback to select the desired subtitle language.**

#### Note

- Depending on the DVD VIDEO, you may not be able to change the subtitles even if multilingual subtitles are recorded on the disc. You also may not be able to turn them off.
- You can change the subtitles if the DivX video file has an ".AVI" or ".DIVX" extension and contains subtitle information within the same file (except for United Kingdom and North American models).

## Changing the sound

#### DVD-V

#### DVD-VR

#### VIDEO CD

#### C D

#### DATA-CD

#### DATA DVD

When the system is playing a DVD VIDEO or DATA CD/DATA DVD (DivX video files\*) recorded in multiple audio formats (PCM, Dolby Digital, MPEG audio, or DTS), you can change the audio format. If the DVD VIDEO is recorded with multilingual tracks, you can also change the language.

With a VIDEO CD, CD, DATA CD, or DATA DVD, you can select the sound from the right or left channel and listen to the sound of the selected channel through both the right and left speakers.

You cannot change the sound for a Super Audio CD.

- \* Except for United Kingdom and North American models.

**Press AUDIO repeatedly during playback to select the desired audio signal.**

**■ DVD VIDEO**

Depending on the DVD VIDEO, the choice of language varies.

When 4 digits are displayed, they indicate a language code. See “Language Code List” (page 105) to confirm which language the code represents. When the same language is displayed two or more times, the DVD VIDEO is recorded in multiple audio formats.

**■ DVD-VR**

The types of sound tracks recorded on a disc are displayed.

Example:

- [1: MAIN] (main sound)
- [1: SUB] (sub sound)
- [1: MAIN+SUB] (main and sub sound)
- [2: MAIN]
- [2: SUB]
- [2: MAIN+SUB]

**Note**

- [2: MAIN], [2: SUB], and [2: MAIN+SUB] do not appear when one audio stream is recorded on the disc.

**■ VIDEO CD/CD/DATA CD (MP3 file)/DATA DVD (MP3 file)**

- [STEREO]: The standard stereo sound.
- [1/L]: The sound of the left channel (monaural).
- [2/R]: The sound of the right channel (monaural).

**■ DATA CD (DivX video file) /DATA DVD (DivX video file) (Except for United Kingdom and North American models)**

The choice of DATA CD or DATA DVD audio signal formats differ, depending on the DivX video file contained on the disc. The format is shown in the display.

**■ Super VCD**

- [1:STEREO]: The stereo sound of the audio track 1.
- [1:1/L]: The sound of the left channel of the audio track 1 (monaural).
- [1:2/R]: The sound of the right channel of the audio track 1 (monaural).
- [2:STEREO]: The stereo sound of the audio track 2.

- [2:1/L]: The sound of the left channel of the audio track 2 (monaural).
- [2:2/R]: The sound of the right channel of the audio track 2 (monaural).

**Note**

- While the system is playing a Super VCD on which the audio track 2 is not recorded, no sound will come out when you select [2:STEREO], [2:1/L], or [2:2/R].

**Checking the audio signal format**

**DVD-V**   **DATA-CD** \*   **DATA DVD** \*

\* Except for United Kingdom and North American models.

If you press AUDIO repeatedly during playback, the format of the current audio signal (PCM, Dolby Digital, DTS, etc.) appears as shown below.

**■ DVD**

**Example:**

Dolby Digital 5.1 channel

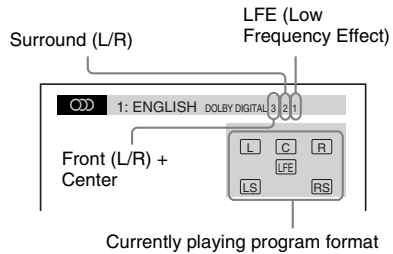

**Example:**

Dolby Digital 3 channel

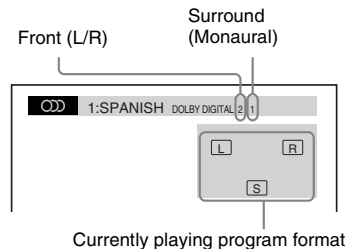

■ DATA CD (DivX video file)/DATA DVD (DivX video file) (Except for United Kingdom and North American models)

**Example:**

MP3 audio

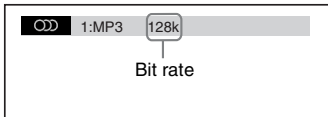

## Selecting a playback area for a Super Audio CD

**Super Audio CD**

You can play the Super Audio CD (page 104) by selecting the playback area.

### To select a playback area on a 2 channel + Multi-channel Super Audio CD

Some Super Audio CDs consist of a 2 channel playback area and a multi-channel playback area. You can select the playback area you want to listen to.

**1 Press DISPLAY while the system is in stop mode.**

The Control Menu display appears on the TV screen.

**2 Press to select [MULTI/2CH], then press .**

The options for [MULTI/2CH] appear.

**3 Press to select the desired setting and press .**

- [MULTI]: You can play the multi-channel playback area.
- [2CH]: You can play the 2 channel playback area.

**Note**

- You cannot change the playback area during playback.

### To change a playback layer when playing a hybrid Super Audio CD

Some Super Audio CDs consist of an HD layer and a CD layer. You can change the playback layer you want to listen to.

**Note**

- When the Super Audio CD does not have the HD layer, you cannot select the playback layer.

**1 Press DISPLAY while the system is in stop mode.**

The Control Menu display appears on the TV screen.

**2 Press to select [SUPER AUDIO CD/CD LAYER], then press .**

■ When the current layer is the CD layer [SUPER AUDIO CD] appears.

■ When the current layer is the HD layer [CD] appears.

**3 Press to change the layer.**

- [SUPER AUDIO CD]: You can play the HD layer. When the system is playing an HD layer, “SA-CD” lights up in the front panel display
- [CD]: You can play the CD layer. When the system is playing a CD layer, “CD” lights up in the front panel display.

**Note**

- Each play mode function works only within the selected layer or playback area.
- When you select a CD layer, you cannot change a playback area.
- Super Audio CD audio signals are not output from the HDMI OUT jack.

## Playing a VIDEO CD with PBC functions (Ver.2.0)

### (PBC Playback)

**VIDEO CD**

With PBC (Playback Control) functions, you can enjoy simple interactive operations, search functions, and other such operations.

PBC playback allows you to play a VIDEO CD interactively by following the menu on the TV screen.

- 1 Start playing a VIDEO CD with PBC functions.**  
The menu for your selection appears.
- 2 Select the item number you want using the number buttons.**
- 3 Press  $\oplus$ .**
- 4 Follow the instructions in the menu for interactive operations.**

Refer to the operating instructions supplied with the disc, as the operating procedure may differ depending on the VIDEO CD.

### To go back to the menu

Press  $\leftarrow$  RETURN.

#### Note

- Depending on the VIDEO CD, [Press ENTER] in Step 3 may appear as [Press SELECT] in the operating instructions supplied with the disc. In this case, press  $\triangleright$ .

#### Tip

- To play without using the PBC function, press  $\blacktriangleleft\blacktriangleleft$  /  $\blacktriangleright\blacktriangleright$  or the number buttons while the system is in stop mode to select a track, then press  $\triangleright$  or  $\oplus$ . The system starts playback. You cannot play still pictures such as a menu. To return to PBC playback, press  $\blacksquare$  twice, then press  $\triangleright$ .

## Resuming playback from the point where you stopped the disc

### (Resume Play)



When you stop the disc, the system remembers the point where you pressed  $\blacksquare$  and “RESUME” appears in the front panel display. As long as you do not remove the disc, Resume Play will work even if the system is set to standby mode by pressing  $\mathbb{I}/\mathbb{C}$ .

- 1 While playing a disc, press  $\blacksquare$  to stop playback.**

“RESUME” appears in the front panel display.

## 2 Press $\triangleright$ .

The system starts playback from the point where you stopped the disc in Step 1.

#### Note

- Depending on where you stop the disc, the system may not resume playback from exactly the same point.
- The point where you stopped playing may be cleared when:
  - you eject the disc.
  - the system enters standby mode (DATA CD/ DATA DVD only).
  - you change or reset the settings on the Setup Display.
  - you change the parental control level.
  - you change the function by pressing FUNCTION +/-.
  - you disconnect the AC power cord (mains lead).
- For a DVD-VR, VIDEO CD, Super Audio CD, CD, DATA CD, or DATA DVD, the system remembers the resume playback point for the current disc.
- The resume point is cleared when you select another disc.
- Resume Play does not work during Program Play and Shuffle Play.
- This function may not work properly with some discs.

#### Tip

- To play from the beginning of the disc, press  $\blacksquare$  twice, then press  $\triangleright$ .

## To enjoy a disc that is played before by resume playback (Multi-disc Resume)

### DVD-V VIDEO CD

This system recalls the point where you stopped the disc the last time it was played and resumes playback from that point the next time you insert the same disc. When the resume playback memory is full, the resume playback point for the earliest disc is deleted.

To activate this function, set [MULTI-DISC RESUME] in [SYSTEM SETUP] to [ON]. For details, see “[MULTI-DISC RESUME] (DVD VIDEO/VIDEO CD only)” (page 67).



**Note**

- This system can store at least 10 resume playback points.
- If [MULTI-DISC RESUME] in [SYSTEM SETUP] is set to [OFF] (page 67), the resume point is cleared when you change the function by pressing FUNCTION +/-.

**Tip**

- To play from the beginning of the disc, press **■** twice, then press **▷**.

# Using Play Mode

## Creating your own program

### (Program Play)



You can play the contents of a disc in the order you want by arranging the order of the tracks on the disc to create your own program. You can program up to 99 tracks.

**Note**

- You can program the track on the current disc only.

#### 1 Press **☰** DISPLAY.

The Control Menu display appears on the TV screen.

#### 2 Press **↑/↓** to select **PROGRAM**, then press **+**.

The options for [PROGRAM] appear.

#### 3 Press **↑/↓** to select [SET →], then press **+**.

Total time of the programmed tracks

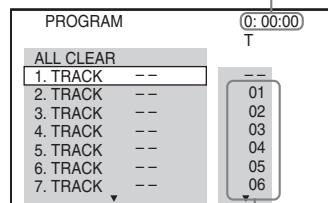

Tracks recorded on a disc

#### 4 Press **→**.

The cursor moves to the track row [T] (in this case, [01]).

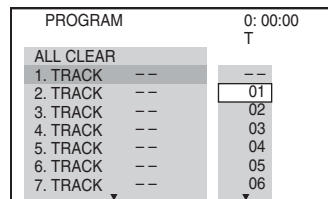

#### 5 Select the track you want to program.

For example, select track [02].

Press  $\uparrow/\downarrow$  to select [02] under [T], then press  $\oplus$ .

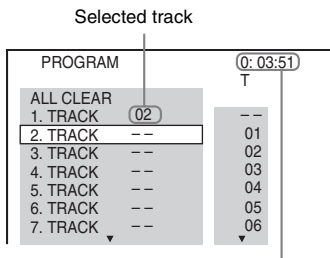

Total time of the programmed tracks

## 6 To program other tracks, repeat Steps 4 to 5.

The programmed tracks are displayed in the selected order.

## 7 Press $\triangleright$ to start Program Play.

Program Play starts.

When the program ends, you can restart the same program again by pressing  $\triangleright$ .

## To return to normal play

Press CLEAR while the display for the program setting is not displayed on the TV screen, or select [OFF] in Step 3. To play the same program again, select [ON] in Step 3 and press  $\oplus$ .

## To turn off the Control Menu display

Press  $\square$  DISPLAY repeatedly until the Control Menu display is turned off.

## To change or cancel a program

### 1 Follow Steps 1 to 3 of “Creating your own program.”

### 2 Press $\uparrow/\downarrow$ to select the program number of the track you want to change or cancel.

If you want to delete the track from the program, press CLEAR.

### 3 Follow Step 5 for new programming.

To cancel a program, select [--] under [T], then press  $\oplus$ .

## To cancel all of the tracks in the programmed order

### 1 Follow Steps 1 to 3 of “Creating your own program.”

### 2 Press $\uparrow$ and select [ALL CLEAR].

### 3 Press $\oplus$ .

## Playing in random order

### (Shuffle Play)

VIDEO CD Super Audio CD C D DATA-CD DATA DVD

You can play the contents on a disc in random order. Subsequent Shuffle Play may produce a different playing order.

#### Note

- Same song may be played repeatedly when you are playing MP3 files.
- You can shuffle the tracks on the current disc only.

### 1 Press $\square$ DISPLAY during playback.

The Control Menu display appears on the TV screen.

### 2 Press $\uparrow/\downarrow$ to select $\square$ [SHUFFLE], then press $\oplus$ .

The options for [SHUFFLE] appear.

### 3 Press $\uparrow/\downarrow$ to select the item to be shuffled.

#### ■ VIDEO CD/Super Audio CD/CD

- [OFF]: Off.
- [TRACK]: You can shuffle tracks on the disc.

#### ■ During Program Play

- [OFF]: Off.
- [ON]: You can shuffle tracks selected in Program Play.

#### ■ DATA CD (except for DivX video file\*)/DATA DVD (except for DivX video file\*)

- [OFF]: Off.
- [ON (MUSIC)]: You can shuffle MP3 files in the folder on the current disc. When no folder is selected, the first folder will play in random order.

\* Except for United Kingdom and North American models.

#### 4 Press **+**.

Shuffle Play starts.

#### To return to normal play

Press CLEAR, or select [OFF] in Step 3.

#### To turn off the Control Menu display

Press **DISP** DISPLAY repeatedly until the Control Menu display is turned off.

##### Note

- You cannot use Shuffle Play with a VIDEO CD or Super VCD with PBC playback.

## Playing repeatedly

### (Repeat Play)



You can play the contents on a disc repeatedly. You can use a combination of Shuffle Play or Program Play modes.

#### 1 Press **DISP** DISPLAY during playback.

The Control Menu display appears on the TV screen.

#### 2 Press **↑/↓** to select **REPEAT**, then press **+**.

The options for [REPEAT] appear.

#### 3 Press **↑/↓** to select the item to be repeated.

##### ■ DVD VIDEO/DVD-VR

- [OFF]: Off.
- [ALL DISCS]: You can repeat all of the discs.
- [ONE DISC]: You can repeat all of the titles on the current disc. (When the system is playing a DVD-VR, you can repeat all of the titles of the selected type.)
- [TITLE]: You can repeat the current title on a disc.
- [CHAPTER]: You can repeat the current chapter.

##### ■ VIDEO CD/Super Audio CD/CD

- [OFF]: Off.

- [ALL DISCS]: You can repeat all of the discs.
- [ONE DISC]: You can repeat all of the tracks on the current disc.
- [TRACK]: You can repeat the current track.

##### ■ DATA CD/DATA DVD

- [OFF]: Off.
- [ALL DISCS]: You can repeat all of the discs.
- [ONE DISC]: You can repeat all of the folders on the current disc.
- [FOLDER]: You can repeat the current folder.
- [TRACK] (MP3 files only): You can repeat the current file.
- [FILE] (DivX video files only): You can repeat the current file (except for United Kingdom and North American models).

#### 4 Press **+**.

The item is selected.

#### To return to normal play

Press CLEAR, or select [OFF] in Step 3.

#### To turn off the Control Menu display

Press **DISP** DISPLAY repeatedly until the Control Menu display is turned off.

##### Note

- You cannot use Repeat Play with a VIDEO CD or Super VCD with PBC playback.
- When the system is playing a DATA CD/DATA DVD which contains MP3 files and JPEG image files, and their playing time is not the same, the audio sound will not match the image.
- When [MODE (MUSIC, IMAGE)] is set to [IMAGE] (page 55), you cannot select [TRACK].

# Searching/Selecting a Disc

## Using the DVD's menu

### DVD-V

A DVD is divided into a lot of sections, which make up a picture or music feature. These sections are called "titles." When you play a DVD which contains several titles, you can select the title you want using DVD TOP MENU.

When you play a DVD that allows you to select items such as the language for the subtitles and the language for the sound, select these items using DVD MENU.

- 1 Press DVD TOP MENU or DVD MENU.**  
The disc's menu appears on the TV screen. The contents of the menu vary depending on the disc.
- 2 Press ←/↑/↓/→ or the number buttons to select the item you want to play or change.**
- 3 Press ⊕.**

## To display the DVD's menu on the Control Menu display

- 1 Press DISPLAY during playback.**  
The Control Menu display appears on the TV screen.
- 2 Press ↑/↓ to select [DISC MENU], then press ⊕.**  
The options for [DISC MENU] appear.
- 3 Press ↑/↓ to select [MENU] or [TOP MENU].**
- 4 Press ⊕.**

## To turn off the Control Menu display

Press DISPLAY repeatedly until the Control Menu display is turned off.

## Selecting [ORIGINAL] or [PLAY LIST] on a DVD-VR

### DVD-VR

This function is only available for DVD-VRs with a playlist created.

- 1 Press DISPLAY while the system is in stop mode.**  
The Control Menu display appears on the TV screen.
- 2 Press ↑/↓ to select [ORIGINAL/PLAY LIST], then press ⊕.**  
The options for [ORIGINAL/PLAY LIST] appear.
- 3 Press ↑/↓ to select a setting.**
  - [PLAY LIST]: You can play the titles created from [ORIGINAL] for editing.
  - [ORIGINAL]: You can play the titles originally recorded.
- 4 Press ⊕.**

## Searching for a title/chapter/track/scene, etc.

### DVD-V DVD-VR VIDEO CD Super Audio CD CD DATA-CD DATA DVD

You can search a DVD VIDEO/DVD-VR by title or chapter, and you can search a VIDEO CD/Super Audio CD/CD/DATA CD/DATA DVD by track, index, or scene. For a DATA CD/DATA DVD, you can search by folder or file. As titles and tracks are assigned unique numbers on the disc, you can select the desired title or track by entering its number. Or, you can search for a scene using the time code.

- 1 Press DISPLAY. (When playing a DATA CD/DATA DVD with JPEG image files, press DISPLAY twice.)**  
The Control Menu display appears on the TV screen.
- 2 Press ↑/↓ to select the search method.**  
Example: [CHAPTER]  
[\*\* (\*\*)] is selected (\*\* refers to a number).

The number in parentheses indicates the total number of titles, chapters, tracks, indexes, scenes, folders, or files.

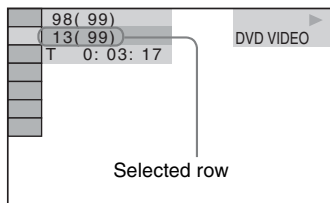

### 3 Press $\oplus$ .

[\*\* (\*\*)] changes to [-- (\*\*)].

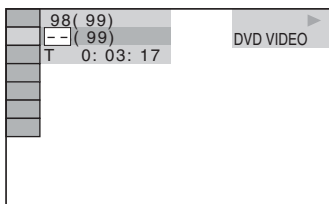

### 4 Press $\uparrow/\downarrow$ or the number buttons to select the desired number of the title, chapter, track, index, scene, etc.

If you make a mistake, press CLEAR to cancel the number.

### 5 Press $\oplus$ .

The system starts playback from the selected number.

#### Tip

- When the Control Menu display is turned off, you can search for a chapter (DVD VIDEO/DVD-R/DVD-RW), track (VIDEO CD/Super Audio CD/CD), or file (DATA CD/DATA DVD (DivX video file))\* by pressing the number buttons and  $\oplus$ .

\* Except for United Kingdom and North American models.

## To search for a scene using the time code

**DVD-V** **DVD-VR**

### 1 In Step 2, select $\downarrow$ [TIME].

[T \*\*: \*\*: \*\*: \*\*] (playing time of the current title) is selected.

### 2 Press $\oplus$ .

[T \*\*: \*\*: \*\*: \*\*] changes to [T --:--:--].

### 3 Input the time code using the number buttons.

For example, to find the scene at 2 hours, 10 minutes, and 20 seconds after the beginning. Press 2, 1, 0, 2, 0 ([2:10:20]).

### 4 Press $\oplus$ .

#### Note

- You cannot search for a scene on a DVD+RW using the time code.

# Playing MP3 Files/JPEG Image Files

**DATA-CD** **DATA DVD**

You can play the MP3 files or JPEG image files:

- which have the extension “.MP3” (MP3 file) or “.JPG”/“.JPEG” (JPEG image file)
  - which conform to the DCF\* image file format
- \* “Design rule for Camera File system”: Image standards for digital cameras regulated by Japan Electronics and Information Technology Industries Association (JEITA).

## Note

- The system will play any data with the extension “.MP3,” “.JPG,” or “.JPEG” even if they are not in MP3 or JPEG format. Playing these data may generate a loud noise which could damage your speaker system.
- The system does not conform to audio in MP3PRO format.
- The system can recognize up to 200 folders, and will not play any folders beyond the 200th. (Depending on the folder configuration, the number of folders that can be recognized by the system may decrease.)
- The system can recognize up to 150 MP3 files/JPEG image files in a folder.
- The system may take longer time to playback, when progressing to the following folder or jump to other folder.
- The system may not play certain types of JPEG image files (ex. a JPEG image file that is less than 8 (width) × 8 (height)).

## Selecting an MP3 file or folder

### 1 Load a DATA CD or DATA DVD.

The folders recorded on the DATA CD or DATA DVD appear. When a folder is being played, its title is shaded.

FOLDER LIST	
01	Let's Talk About Love (1985)
02	1st Album (1986)
03	In the Middle of Nowhere (1986)
04	Ready for Romance (1986)
05	In the Garden of Venus (1987)
06	Romantic Warriors (1987)
07	Back for Good (1988)
08	Alone (1999)

### 2 Press $\uparrow/\downarrow$ to select a folder.

#### ■ To play MP3 files in a folder

Press  $\triangleright$  to start playing the selected folder.

#### ■ To select a MP3 file

Press  $\oplus$ .

The list of files contained in the folder appears.

TRACK LIST	
<input type="checkbox"/>	03 In the Middle of Nowher...
<input checked="" type="checkbox"/>	01_Geronimo_s_Cadillac
	02_Riding_On_A_White_Swan
	03_Give_Me_Peace_On_Earth
	04_Sweet_Little_Shella
	05_Ten_Thousand_Lonely_Drums
	06_Lonely_Tears_In_Chinatown
	07_In_Shaire

Press  $\uparrow/\downarrow$  to select a file and press  $\oplus$ .

The system starts playing the selected file. You can turn the file list off by pressing DVD MENU. Pressing DVD MENU again will display the folder list.

### To stop playback

Press ■.

### To play the next or previous MP3 file

Press  $\triangleright|/|<$ . Note that you can select the next folder by continuing to press  $\triangleright|$  after the last file on the current folder, but that you cannot return to the previous folder by pressing  $|<<$ . To return to the previous folder, select the folder from the folder list.

### To return to the previous display

Press  $\curvearrowright$  RETURN.

### To turn off the display

Press DVD MENU.

## Selecting a JPEG image file or folder

### 1 Load a DATA CD or DATA DVD.

The folders recorded on the DATA CD or DATA DVD appear. When a folder is being played, its title is shaded.

## FOLDER LIST

01 Let's Talk About Love (1985)
02 1st Album (1986)
03 In the Middle of Nowhere (1986)
04 Ready for Romance (1986)
05 In the Garden of Venus (1987)
06 Romantic Warriors (1987)
07 Back for Good (1988)
08 Alone (1999)

## 2 Press $\uparrow/\downarrow$ to select a folder.

### ■ To play JPEG image files in a folder

Press  $\triangleright$  to start playing the selected folder.

### ■ To select a JPEG image file by displaying the subscreens

Press PICTURE NAVI.

Images of JPEG image files in the folder appear in 16 subscreens.

1	2	3	4
5	6	7	8
9	10	11	12
13	14	15	16

Press  $\leftarrow/\uparrow/\downarrow/\rightarrow$  to select the JPEG image file you want to view, then press  $\oplus$ .

To return to normal screen, press  $\text{⏪}$  RETURN.

#### Note

- PICTURE NAVI does not work when you set [MODE (MUSIC, IMAGE)] to [MUSIC].

#### Tip

- A scroll box is displayed at the right side of the TV screen. To display the additional JPEG image files, select the bottom JPEG image file and press  $\downarrow$ . To return to the previous JPEG image file, select the top JPEG image file and press  $\uparrow$ .

## To play the next or previous JPEG image file

Press  $\rightarrow/\leftarrow$  when the Control Menu display is not displayed. Note that you can select the next folder by continuing to press  $\rightarrow$  after the last image on the current folder, but that you cannot return to the previous folder by pressing  $\leftarrow$ . To

return to the previous folder, select the folder from the folder list.

## To rotate a JPEG image file

When a JPEG image file is displayed on the TV screen, you can rotate the JPEG image file by 90 degrees.

Press  $\uparrow/\downarrow$  while viewing a JPEG image file.

Press CLEAR to return to normal view.

#### Note

- You cannot rotate the JPEG image file when you set [JPEG RESOLUTION] in [HDMI SETUP] to [(1920 × 1080i) HD  $\square$ ] or [(1920 × 1080i) HD] (page 65).

## To stop playback

Press  $\blacksquare$ .

## Displaying the list of MP3 files/JPEG image files

### 1 Press $\text{⏪}$ DISPLAY during playback.

The Control Menu display appears on the TV screen.

### 2 Press $\uparrow/\downarrow$ to select $\text{⏪}$ [BROWSING], then press $\oplus$ .

The options for [BROWSING] appear.

### 3 Press $\uparrow/\downarrow$ to select the desired list, then press $\oplus$ .

- [FOLDER LIST]: The list of folders appears. Follow Step 2 of “Selecting an MP3 file or folder” or “Selecting a JPEG image file or folder.”
- [PICTURE LIST]: Images of JPEG image files in the folder appear in 16 subscreens. Follow Step 2 of “Selecting a JPEG image file or folder.”

## Playing MP3 files and JPEG image files as a slide show with sound

You can play a slide show with sound by first placing both MP3 files and JPEG image files in the same folder on a DATA CD or DATA DVD.

### 1 Load a DATA CD or DATA DVD.

## 2 Press DISPLAY while the system is in stop mode.

The Control Menu display appears on the TV screen.

## 3 Press to select [MODE (MUSIC, IMAGE)], then press .

The options for [MODE (MUSIC, IMAGE)] appear.

## 4 Press to select a setting.

- [AUTO]: You can play both the JPEG image files and MP3 files in the same folder as a slide show.
- [MUSIC]: You can play only MP3 files continuously.
- [IMAGE]: You can play only JPEG image files as a slide show.

## 5 Press .

## 6 Press DVD MENU.

The list of folders recorded on the DATA CD or DATA DVD appears.

## 7 Press to select the desired folder and press .

The system starts playing the selected folder.

You can turn the folder list on/off by pressing DVD MENU repeatedly.

### Note

- PICTURE NAVI does not work when [MUSIC] is selected.
- If you play large MP3 file and JPEG image file at the same time, the sound may skip. Sony recommends that you set the MP3 bit rate to 128 kbps or lower when creating the file. If the sound still skips, reduce the size of the JPEG image file.

## To select the slide show duration of JPEG image files

### 1 Press DISPLAY twice.

The Control Menu display appears on the TV screen.

### 2 Press to select [INTERVAL], then press .

The options for [INTERVAL] appear.

### 3 Press to select a setting.

- [NORMAL]: You can set to the standard duration.

- [FAST]: You can set the duration shorter than [NORMAL].
- [SLOW 1]: You can set the duration longer than [NORMAL].
- [SLOW 2]: You can set the duration longer than [SLOW 1].

### 4 Press .

### Note

- Some JPEG image files may take longer to display than the option you selected. Especially progressive JPEG image files or JPEG image files of 3,000,000 pixels or more.
- Duration of interval depends on the [JPEG RESOLUTION] setting in [HDMI SETUP] (page 64).

## To select an effect for JPEG image files in the slide show

### 1 Press DISPLAY twice.

The Control Menu display appears on the TV screen.

### 2 Press to select [EFFECT], then press .

The options for [EFFECT] appear.

### 3 Press to select a setting.

- [MODE 1]: The JPEG image file sweeps in from top to bottom.
- [MODE 2]: The JPEG image file stretches out from left to right of the TV screen.
- [MODE 3]: The JPEG image file stretches out from the center of the TV screen.
- [MODE 4]: The JPEG image files randomly cycle through the effects.
- [MODE 5]: The next JPEG image file slides over the previous image.
- [OFF]: Off.

### 4 Press .

### Note

- The [EFFECT] setting is not effective when you set [JPEG RESOLUTION] in [HDMI SETUP] to [(1920 × 1080i) HD 



# Enjoying DivX<sup>®</sup> Videos

**DATA-CD** **DATA DVD**

*(Except for United Kingdom and North American models)*

## About DivX video files

DivX<sup>®</sup> is a video file compression technology, developed by DivX, Inc. This product is an official DivX<sup>®</sup> Certified product.

You can play a DATA CD or DATA DVD that contains DivX<sup>®</sup> video files.

### A DATA CD or DATA DVD that the system can play

Playback of a DATA CD (CD-ROM/CD-R/CD-RW) or DATA DVD (DVD-ROM/DVD-R/DVD-RW/DVD+R/DVD+RW) on this system is subject to certain conditions:

- With a DATA CD/DATA DVD that contains DivX video files in addition to MP3 audio tracks or JPEG image files, the system plays only the DivX video files.

However, this system only plays a DATA CD of format ISO 9660 Level 1/Level 2 or Joliet, and a DATA DVD of Universal Disk Format (UDF). Refer to the operating instructions supplied with the disc drives and the recording software (not supplied) for details on the recording format.

### About playback order of data on a DATA CD or DATA DVD

Note that the playback order may not be applicable, depending on the software used for creating the DivX video file, or if there are more than 200 folders and 150 DivX video files in each folder.

**Note**

- The system may not be able to play some DATA CDs/DATA DVDs created in the Packet Write format.

### DivX video files that the system can play

The system can play data that is recorded in DivX format, and which has the extension

“.AVI,” or “.DIVX.” The system will not play files with the extension “.AVI” or “.DIVX” if they do not contain a DivX video.

**Tip**

- For details about playable MP3 audio tracks or JPEG image files on a DATA CD or DATA DVD, see “Playable Discs” (page 6).

**Note**

- The system may not play a DivX video file when the file has been combined from two or more DivX video files.
- The system cannot play a DivX video file of size more than 720 (width) × 576 (height) or 2GB.
- Depending on the DivX video file, sound may skip or not match the pictures on the TV screen.
- The system cannot play some DivX video files that are longer than 3 hours.
- Depending on the DivX video file, the picture may pause or be unclear. In which case, it is recommended that you create the file at a lower bit rate. If the sound is still noisy, MP3 is the recommended audio format. Note, however, this system does not conform to WMA (Windows Media Audio) format for playing DivX files.
- Because of the compression technology used for DivX video files, it may take some time after you press  $\triangleright$  for the picture to appear.

## Selecting a folder

### 1 Press DVD MENU.

A list of folders on the disc appears. Only folders that contain DivX video files are listed.

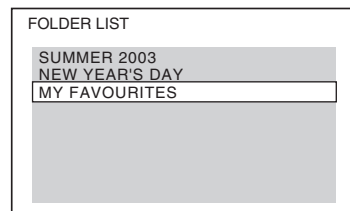

### 2 Press $\uparrow/\downarrow$ to select the folder you want to play.

### 3 Press $\triangleright$ .

The system starts playing the selected folder.

To select DivX video files, see “Selecting a DivX video file” (page 58).

### To go to the next or previous page

Press **•→ / ←•**.

### To turn off the display

Press DVD MENU repeatedly.

### To stop playback

Press **■**.

**◀◀**. To return to the previous folder, select it from the folder list.

#### Tip

- If the number of viewing times is preset, you can play the DivX video files as many times as the preset number. The following occurrences are counted:
  - when the system is turned off.
  - when another file is played.
  - when the disc tray is opened.

## Selecting a DivX video file

### 1 After Step 2 of “Selecting a folder,” press **⊕**.

The list of files in the folder appears.

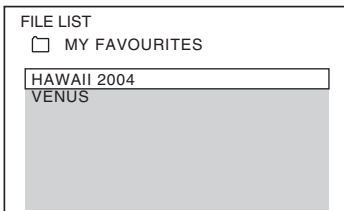

### 2 Press **↑/↓** to select a file and press **⊕**.

The selected file starts playing.

### To go to the next or previous page

Press **•→ / ←•**.

### To return to the previous display

Press **↶** RETURN.

### To stop playback

Press **■**.

### To play the next or previous DivX video file without turning on the above file list

You can select the next or previous DivX video file in the same folder by pressing **▶▶/|◀◀**.

You can also select the first file of the next folder by pressing **▶▶|** during playback of the last file of the current folder. Note that you cannot return to the previous folder by pressing

# Adjusting the Delay Between the Picture and Sound

## [A/V SYNC]

**DVD-V** **DVD-VR** **VIDEO CD** **DATA-CD** \* **DATA DVD** \*

\* Except for United Kingdom and North American models

When the sound does not match the pictures on the TV screen, you can adjust the delay between the picture and sound.

### 1 Press **DISPLAY**.

The Control Menu display appears on the TV screen.

### 2 Press $\uparrow/\downarrow$ to select [A/V SYNC], then press $\oplus$ .

The options for [A/V SYNC] appear.

### 3 Press $\uparrow/\downarrow$ to select a setting.

- [OFF]: Off.
- [ON]: You can adjust the difference between picture and sound.

### 4 Press $\oplus$ .

#### Note

- Depending on the input stream, [A/V SYNC] may not be effective.

# Restricting Playback of the Disc

## [PARENTAL CONTROL]

### DVD-V

Playback of some DVD VIDEOS can be limited according to a predetermined level such as the age of the users. Scenes may be blocked or replaced with different scenes.

You can set the playback restriction by registering a password. When you set the [PARENTAL CONTROL] function to on, you need to enter the password to play restricted discs.

### 1 Press **FUNCTION +/-** repeatedly until "DVD" appears in the front panel display.

### 2 Press **DISPLAY** while the system is in stop mode.

The Control Menu display appears on the TV screen.

### 3 Press $\uparrow/\downarrow$ to select [SETUP], then press $\oplus$ .

The options for [SETUP] appear.

### 4 Press $\uparrow/\downarrow$ to select [CUSTOM], then press $\oplus$ .

The Setup Display appears.

### 5 Press $\uparrow/\downarrow$ to select [SYSTEM SETUP], then press $\oplus$ .

The options for [SYSTEM SETUP] appear.

### 6 Press $\uparrow/\downarrow$ to select [PARENTAL CONTROL $\rightarrow$ ], then press $\oplus$ .

#### ■ If you have not entered a password

The display for registering a new password appears.

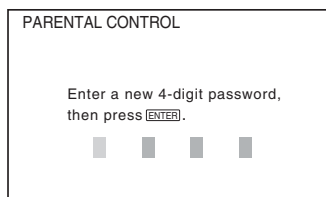

Enter a 4-digit password using the number buttons, then press  $\oplus$ .

The display for confirming the password appears.

**■ When you have already registered a password**

The display for entering the password appears.

**7 Enter or re-enter your 4-digit password using the number buttons, then press  $\oplus$ .**

$\oplus$ .

The display for setting the playback limitation level appears.

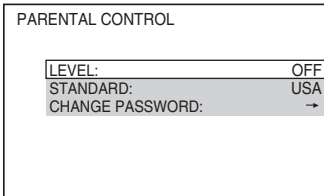

**8 Press  $\uparrow/\downarrow$  to select [STANDARD], then press  $\oplus$ .**

The selection items for [STANDARD] are displayed.

**9 Press  $\uparrow/\downarrow$  to select a geographic area as the playback limitation level, then press  $\oplus$ .**

The area is selected.

When you select [OTHERS  $\rightarrow$ ], select and enter a standard code in the table of "Parental Control Area Code List" (page 105) using the number buttons.

**10 Press  $\uparrow/\downarrow$  to select [LEVEL], then press  $\oplus$ .**

The selection items for [LEVEL] are displayed.

**11 Press  $\uparrow/\downarrow$  to select the desired level, then press  $\oplus$ .**

[PARENTAL CONTROL] setting is complete.

The lower the value, the stricter the limitation.

## To turn off the [PARENTAL CONTROL] function

Set [LEVEL] to [OFF] in Step 11.

## To play a disc for which [PARENTAL CONTROL] is set

**1 Load the disc and press  $\triangleright$ .**

The display for entering your password appears.

**2 Enter your 4-digit password using the number buttons, then press  $\oplus$ .**

The system starts playback.

**Note**

- When you play discs which do not have the [PARENTAL CONTROL] function, playback cannot be limited on this system.
- Depending on the disc, you may be asked to change the parental control level while playing the disc. In this case, enter your password, then change the level. If the Resume Play mode is canceled, the level returns to the previous level.

**Tip**

- If you forget your password, remove the disc and repeat Steps 1 to 7 of "Restricting Playback of the Disc" (page 59). When you are asked to enter your password, enter "199703" using the number buttons, then press  $\oplus$ . The display will ask you to enter a new 4-digit password. After you enter a new 4-digit password, replace the disc in the unit and press  $\triangleright$ . When the display for entering your password appears, enter your new password.

## Changing the password

**1 Press FUNCTION +/- repeatedly until "DVD" appears in the front panel display.**

**2 Press  $\square$  DISPLAY while the system is in stop mode.**

The Control Menu display appears on the TV screen.

**3 Press  $\uparrow/\downarrow$  to select  [SETUP], then press  $\oplus$ .**

The options for [SETUP] appear.

**4 Press  $\uparrow/\downarrow$  to select [CUSTOM], then press  $\oplus$ .**

The Setup Display appears.

- 5** Press **↑/↓** to select **[SYSTEM SETUP]**, then press **+**.  
The options for **[SYSTEM SETUP]** appear.
- 6** Press **↑/↓** to select **[PARENTAL CONTROL →]**, then press **+**.  
The display for entering the password appears.
- 7** Enter your 4-digit password using the number buttons, then press **+**.
- 8** Press **↑/↓** to select **[CHANGE PASSWORD →]**, then press **+**.
- 9** Enter your 4-digit password using the number buttons, then press **+**.
- 10** Enter a new 4-digit password using the number buttons, then press **+**.
- 11** To confirm your password, re-enter it using the number buttons, then press **+**.

### If you make a mistake entering your password

Press **←** before you press **+**, then input the correct number.

## Using the Setup Display

You can make various adjustments of items such as picture and sound.

Displayed items vary depending on the country model.

### Note

- Playback settings stored in the disc take priority over the Setup Display settings and not all the functions described may work.

- 1** Press **FUNCTION +/-** repeatedly until **"DVD"** appears in the front panel display.
- 2** Press **DISPLAY** while the system is in stop mode.  
The Control Menu display appears on the TV screen.
- 3** Press **↑/↓** to select **[SETUP]**, then press **+**.  
The options for **[SETUP]** appear.
- 4** Press **↑/↓** to select **[CUSTOM]**, then press **+**.  
The Setup Display appears.
- 5** Press **↑/↓** to select the setup item, then press **+**.
  - **[LANGUAGE SETUP]** (page 62)
  - **[VIDEO SETUP]** (page 62)
  - **[HDMI SETUP]** (page 64)
  - **[AUDIO SETUP]** (page 65)
  - **[SYSTEM SETUP]** (page 66)
  - **[SPEAKER SETUP]** (page 67)

Example: **[VIDEO SETUP]**

Selected item

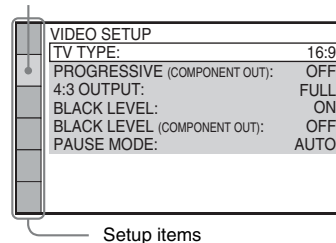

- 6** Press **↑/↓** to select an item, then press **+**.

The options for the selected item appear.

Example: [TV TYPE]

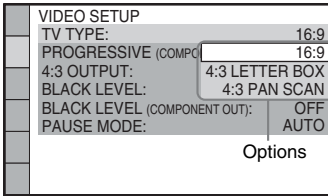

## 7 Press $\uparrow/\downarrow$ to select a setting, then press $\oplus$ .

The setting is selected and setup is complete.

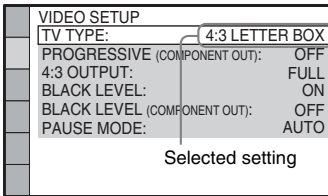

### Note

- When you turn the system on after resetting and no disc is in the unit, the guide message appears on the TV screen. To perform the Quick Setup (page 35), press  $\oplus$ . To return to normal screen, press CLEAR.

## To reset all of the [SETUP] settings

To reset all of the [SETUP] settings, see “Returning the [SETUP] settings to the default” (page 90).

## Setting the display or sound track language

### [LANGUAGE SETUP]

Set various languages for the on-screen display or sound track.

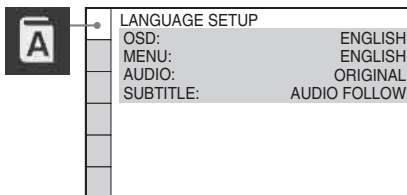

### ■ [OSD] (On-Screen Display)

You can switch the display language on the TV screen.

### ■ [MENU] (DVD VIDEO only)

You can switch the language for the disc's menu.

### ■ [AUDIO] (DVD VIDEO only)

You can switch the language of the sound track. When you select [ORIGINAL], the language given priority in the disc is selected.

### ■ [SUBTITLE] (DVD VIDEO only)

You can switch the language of the subtitle recorded on the DVD VIDEO. When you select [AUDIO FOLLOW], the language for the subtitles changes according to the language you selected for the sound track.

### Note

- When you select a language in [MENU], [AUDIO], or [SUBTITLE] that is not recorded on the DVD VIDEO, one of the recorded languages will be automatically selected (depending on the disc, the language may not be selected automatically).

### Tip

- If you select [OTHERS  $\rightarrow$ ] in [MENU], [AUDIO], and [SUBTITLE], select and enter a language code from “Language Code List” (page 105) using the number buttons.

## Settings for the display

### [VIDEO SETUP]

Select settings according to the TV to be connected.

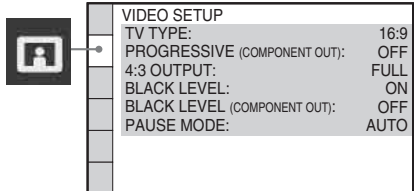

## ■ [TV TYPE]

You can select the aspect ratio of the connected TV.

[16:9]: Select this when you connect a wide-screen TV or a TV with a wide mode function.



[4:3 LETTER BOX]: Select this when you connect a 4:3 screen TV. Displays a wide picture with bands on the upper and lower portions of the TV screen.



[4:3 PAN SCAN]: Select this when you connect a 4:3 screen TV. The system automatically displays the wide picture on the entire screen and cuts off the portions that do not fit.

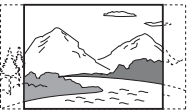

### Note

• Depending on the DVD, [4:3 LETTER BOX] may be selected automatically instead of [4:3 PAN SCAN] or vice versa.

## ■ [PROGRESSIVE (COMPONENT OUT)]

You can set the progressive signal that is output from the COMPONENT VIDEO OUT jacks to on/off. For details, see “Does your TV accept progressive signals?” (page 37).

[OFF]: The system outputs interlace signals.

[ON]: The system outputs progressive signals. When you select [ON], follow the Steps below.

**1** Select [ON], then press **+**.

The confirmation display appears.

**2** Press **↔** to select [START], then press **+**.

The system outputs the progressive signal for 5 seconds. Check that the screen is displayed correctly.

**3** Press **↔** to select [YES].

The system outputs the progressive signal. If you select [NO], the system will not output the progressive signal.

### Note

• [PROGRESSIVE (COMPONENT OUT)] is effective only when you connect the unit and TV with a component video cord (page 26).

## ■ [4:3 OUTPUT]

When you use a 16:9 aspect ratio TV, you can adjust the aspect ratio to watch 4:3 aspect ratio signals. If you can change the aspect ratio on your TV, change the setting on your TV, not the system.

[FULL]: Select this when you can change the aspect ratio on your TV.

[NORMAL]: Select this when you cannot change the aspect ratio on your TV. A 16:9 aspect ratio signal with black bands on left and right sides of the image appears.

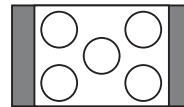

16:9 aspect ratio TV

### Note

• [4:3 OUTPUT] is effective only when you set [TV TYPE] in [VIDEO SETUP] to [16:9].

## ■ [COLOR SYSTEM (VIDEO CD)]

**(Asian, Australian, and Middle Eastern models only)**

You can select the color system when you play a VIDEO CD.

[AUTO]: The system outputs the video signal in the system of the disc, either PAL or NTSC. If your TV uses a DUAL system, select [AUTO].

[PAL]: The system changes the video signal of an NTSC disc and outputs it in the PAL system.

[NTSC]: The system changes the video signal of a PAL disc and outputs it in the NTSC system.

**Note**

- You cannot change the color system of the disc itself.
- You can change the color system of this system according to the connected TV (page 28).

**■ [BLACK LEVEL]****(North American, Mexican, and Latin American models only)**

You can select the black level (setup level) for the video signals output from the jacks other than COMPONENT VIDEO OUT/HDMI OUT.

[ON]: The standard level.

[OFF]: You can lower the standard black level. Use this when the picture becomes too white.

**■ [BLACK LEVEL (COMPONENT OUT)]****(North American, Mexican, and Latin American models only)**

You can select the black level (setup level) for the video signals output from the COMPONENT VIDEO OUT jacks.

You cannot select this and the setting is not effective when the system outputs progressive signal.

[OFF]: You can set the black level of the output signal to the standard level.

[ON]: You can raise the standard black level. Use this when the picture becomes too black.

**■ [PAUSE MODE] (DVD VIDEO/DVD-R/DVD-RW only)**

You can select the picture in pause mode.

[AUTO]: The picture, including subjects that move dynamically, is output with no jitter. Normally select this position.

[FRAME]: The picture, including subjects that do not move dynamically, is output in high resolution.

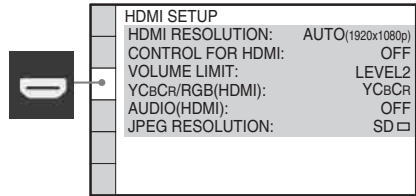
**Settings for the HDMI****[HDMI SETUP]****■ [HDMI RESOLUTION]**

You can select the type of video signal that is output from the HDMI OUT jack. For details, see “To select the type of video signal output from the HDMI OUT jack” (page 37).

[AUTO (1920 × 1080p)]: The system outputs the optimal video signal for the connected TV.

[1920 × 1080i]: The system outputs 1920 × 1080i\* video signals.

[1280 × 720p]: The system outputs 1280 × 720p\* video signals.

[720 × 480p]\*\*: The system outputs 720 × 480p\* video signals.

\* i: interlace, p: progressive

\*\* Depending on the country model, [720 × 576p] may appear.

**■ [CONTROL FOR HDMI]**

You can set the [CONTROL FOR HDMI] function to on/off. This function is available when you connect the system and TV with an HDMI cable. For details, see “Using the Control for HDMI Function for “BRAVIA” Sync” (page 73).

[OFF]: Off.

[ON]: On. You can operate mutually between components that are connected with an HDMI cable.

**Note**

- When you set to [ON] without the HDMI connection of the TV, [Please verify the HDMI connection.] appears and you cannot set to [ON].



## ■ [VOLUME LIMIT]

If you change the output method of the TV to the system speaker on the TV menu or by pressing THEATER/THEATRE\*, the System Audio Control (page 75) is activated and loud sound may be output depending on the volume level of the system. You can prevent this by limiting the maximum level of the volume.

\* The button name differs depending on the area.

[LEVEL3]: Maximum volume level is set to 10.

[LEVEL2]: Maximum volume level is set to 15.

[LEVEL1]: Maximum volume level is set to 20.

[OFF]: Off.

### Note

- This function is available only when [CONTROL FOR HDMI] is set to [ON].

## ■ [YCbCr/RGB (HDMI)]

You can select the type of HDMI signal output from HDMI OUT jack.

[YCbCr]: The system outputs YCbCr signals.

[RGB]: The system outputs RGB signals.

### Note

- If the playback picture becomes distorted, set [YCbCr] to [RGB].
- If the HDMI OUT jack is connected to a component with a DVI jack, [RGB] signals will be automatically output even when you select [YCbCr].

## ■ [AUDIO (HDMI)]

You can select the audio output status from the HDMI OUT jack.

[OFF]: The system does not output the sound from the HDMI OUT jack.

[ON]: The system outputs audio signals by converting Dolby Digital, DTS, or 96 kHz/24 bit PCM signals to 48 kHz/16 bit PCM.

### Note

- When you connect the unit and TV with an HDMI cable and [ON] is selected, [AUDIO DRC], [A/V SYNC], DYNAMIC BASS, "DEC. MODE," and sound mode are not applied to the sound that is output from the TV.
- When you set the function to other than "DVD," the system does not output the sound from the HDMI OUT jack even if you set [AUDIO (HDMI)] to [ON].

## ■ [JPEG RESOLUTION]

You can select the resolution of JPEG image files output from the HDMI OUT jack.

[SD ]: The system outputs standard resolution with a black frame.

[HD ]: The system outputs HD resolution with a black frame.

[HD]: The system outputs the HD resolution without a black frame.

[(1920 × 1080i) HD ]: The system outputs full size HD resolution with a black frame.

[(1920 × 1080i) HD]: The system outputs full size HD resolution without a black frame.

### Note

- [JPEG RESOLUTION] is effective only when you set [TV TYPE] in [VIDEO SETUP] to [16:9], and you set [HDMI RESOLUTION] in [HDMI SETUP] to other than [720 × 480p] or [720 × 576p].
- You can select [(1920 × 1080i) HD ] or [(1920 × 1080i) HD] only when you set [HDMI RESOLUTION] in [HDMI SETUP] to [1920 × 1080i].
- If you select [(1920 × 1080i) HD ] or [(1920 × 1080i) HD], the next image appears after the black screen.
- HDMI signal will stop momentarily when:
  - The system is loading or unloading a DATA CD or DATA DVD.
  - You change the disc from a DATA CD or DATA DVD.
  - You play a DATA CD or DATA DVD to the end and the system stops playback automatically.

## Settings for the audio

### [AUDIO SETUP]

AUDIO SETUP	
S-AIR SETUP:	→
SPEAKER FORMATION:	→
AUTO CALIBRATION:	→
AUDIO DRC:	OFF
TRACK SELECTION:	OFF



---

## ■ [S-AIR SETUP]

### (DAV-HDX275/DAV-HDX475 only)

You can set up the S-AIR setting. For details, see “Using an S-AIR Product” (page 77).

## ■ [ID]

You can set the ID of the system.

## ■ [PAIRING]

You can pair the system and S-AIR sub unit, such as surround amplifier or S-AIR receiver.

### Note

- This function is available only when the S-AIR transmitter (not supplied) is inserted into the unit.

---

## ■ [SPEAKER FORMATION]

You can select the position of the speakers for the better surround sound. For details, see “Getting Optimal Surround Sound for a Room” (page 83).

---

## ■ [AUTO CALIBRATION]

You can calibrate the appropriate settings automatically. For details, see “Calibrating the Appropriate Settings Automatically” (page 84).

---

## ■ [AUDIO DRC] (DVD VIDEO only)

You can compress the dynamic range of the sound track. [AUDIO DRC] is useful for watching movies at low volume late at night.

[OFF]: No compression of dynamic range.

[STANDARD]: The system reproduces the sound track with the kind of dynamic range that the recording engineer intended.

[MAX]: The system compresses dynamic range fully.

### Note

- [AUDIO DRC] works only for Dolby Digital.

---

## ■ [TRACK SELECTION] (DVD VIDEO only)

You can give the sound track which contains the highest number of channels priority when you play a DVD VIDEO on which multiple audio formats (PCM, DTS, Dolby Digital, or MPEG audio) are recorded.

[OFF]: Off.

[AUTO]: The system selects the sound track automatically according to the priority.

### Note

- When you set the item to [AUTO], the language may change. The [TRACK SELECTION] setting has higher priority than the [AUDIO] settings in [LANGUAGE SETUP] (page 62). (Depending on the disc, this function may not work.)
- If PCM, DTS, Dolby Digital sound, and MPEG audio have the same number of channels, the system selects PCM, DTS, Dolby Digital sound, and MPEG audio in this order.

## Other Settings

### [SYSTEM SETUP]

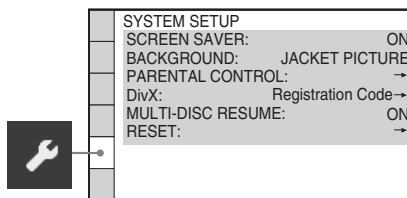

---

## ■ [SCREEN SAVER]

You can reduce the display device damages (ghosting). Press any button (e.g.,  button) to cancel the screen saver.

[ON]: The screen saver image appears if you do not operate the system for about 15 minutes.

[OFF]: Off.

---

## ■ [BACKGROUND]

You can select the background color or picture on the TV screen.

[JACKET PICTURE]: The jacket picture (still picture) appears, but only when the jacket picture is already recorded on the disc (CD-EXTRA, etc.). If the disc does not contain a jacket picture, the [GRAPHICS] picture appears.

[GRAPHICS]: A preset picture stored in the system appears.

[BLUE]: The background is blue.

[BLACK]: The background is black.

## ■ [PARENTAL CONTROL]

You can set the playback restrictions. For details, see “Restricting Playback of the Disc” (page 59).

## ■ [DivX]

**(Except for United Kingdom and North American models)**

You can display the registration code for this system.

For more information, go to <http://www.divx.com> on the Internet.

## ■ [MULTI-DISC RESUME] (DVD VIDEO/VIDEO CD only)

You can set the [MULTI-DISC RESUME] function to on/off.

[ON]: The system stores the resume points in memory for up to 10 discs.

[OFF]: The system does not store the resume points in memory. Playback restarts at the resume point only for the current disc in the unit.

## ■ [RESET]

You can return the [SET UP] settings other than [PARENTAL CONTROL] to the default settings. For details, see “Returning the [SETUP] settings to the default” (page 90).

## Settings for the speakers

### [SPEAKER SETUP]

To obtain the best possible surround sound, set connection of the speakers and their distance from your listening position. Then use the test tone to adjust the level and the balance of the speakers to the same level.

#### Note

- You cannot operate [SPEAKER SETUP] when you connect headphones to the unit or surround amplifier\*.

\* DAV-HDX275/DAV-HDX475 only.

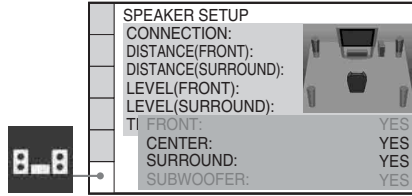

## ■ [CONNECTION]

If you do not connect center or surround speakers, set the parameters for [CENTER] and [SURROUND]. Since the front speaker and subwoofer setting is fixed, you cannot change them.

### [FRONT]

[YES]

### [CENTER]

[YES]: Normally select this.

[NONE]: Select this if no center speaker is used.

### [SURROUND]

[YES]: Normally select this.

[NONE]: Select this if no surround speaker is used.

### [SUBWOOFER]

[YES]

#### Note

- When you change the [CONNECTION] setting, the [STANDARD] of [SPEAKER FORMATION] setting remains the same, but the other settings of [SPEAKER FORMATION] return to [STANDARD].

## ■ [DISTANCE (FRONT)]

When you move the front speakers and center speaker, be sure to set the parameters of the distance (A) from the listening position to the speakers.

You can set the parameters from 1.0 to 7.0 meters<sup>1)</sup> (3 to 23 ft) for the front speakers, from 0.0 to 7.0 meters<sup>2)</sup> (0 to 23 ft) for the center speaker.

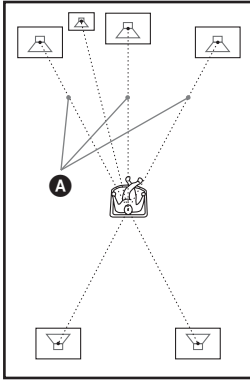

[L/R] 3.0 m/10 ft<sup>3)</sup>: Set the front speaker distance.

[CENTER] 3.0 m/10 ft<sup>3,4)</sup>: Set the center speaker distance (up to 1.6 meters (5 ft) closer to the front speakers).

<sup>1)</sup>0.9 to 6.9 meters for North American models.

<sup>2)</sup>0.0 to 6.9 meters for North American models.

<sup>3)</sup>When you perform the Quick Setup (page 35), the default settings are changed.

<sup>4)</sup>This item appears when you set [CENTER] to [YES] in the [CONNECTION] setting.

### ■ [DISTANCE (SURROUND)]

When you move the surround speakers, be sure to set the parameters of the distance (B) from the listening position to the speakers.

You can set the parameters from 0.0 to 7.0 meters<sup>1)</sup> (0 to 23 ft).

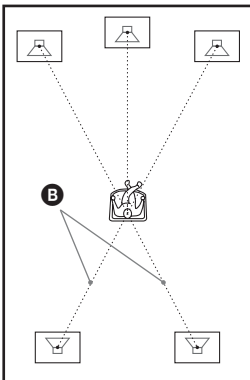

[L/R] 3.0 m/10 ft<sup>2,3)</sup>: Set the surround speaker distance (up to 5.0 meters (16 ft) closer to the front speakers).

<sup>1)</sup>0.0 to 6.9 meters for North American models.

<sup>2)</sup>When you perform the Quick Setup (page 35), the default settings are changed.

<sup>3)</sup>This item appears when you set [SURROUND] to [YES] in the [CONNECTION] setting.

### Note

- If all front and surround speakers are not placed at an equal distance from your listening position, set the distance according to the closest speaker.
- Do not place the surround speakers farther away from your listening position than the front speakers.
- Depending on the input stream, the [DISTANCE] setting may not be effective.

### ■ [LEVEL (FRONT)]

You can adjust the sound level of the front speakers, center speaker, and subwoofer. You can set the parameters from  $-6.0$  dB to  $+6.0$  dB. Be sure to set [TEST TONE] to [ON] for easy adjustment.

[L/R] 0.0 dB: Set the front speaker level.

[CENTER] 0.0 dB\*: Set the center speaker level.

[SUBWOOFER] +2.0 dB: Set the subwoofer level.

\* This item appears when you set [CENTER] to [YES] in the [CONNECTION] setting.

### ■ [LEVEL (SURROUND)]

You can adjust the sound level of the surround speakers. You can set the parameter from  $-6.0$  dB to  $+6.0$  dB. Be sure to set [TEST TONE] to [ON] for easy adjustment.

[L/R] 0.0 dB\*: Set the surround speaker level.

\* This item appears when you set [SURROUND] to [YES] in the [CONNECTION] setting.

### ■ [TEST TONE]

The speakers will emit a test tone to adjust [LEVEL (FRONT)] and [LEVEL (SURROUND)].

[OFF]: The test tone is not emitted from the speakers.

[ON]: The test tone is emitted from each speaker in sequence while adjusting level. When you select one of the [SPEAKER SETUP] items, the test tone is emitted from each speaker in sequence.

Adjust the sound level as follows.

- 1** Set the [TEST TONE] to [ON].
- 2** Press  $\leftarrow/\uparrow/\downarrow/\rightarrow$  repeatedly to select the desired speaker and the level.
- 3** Press  $\oplus$ .
- 4** Repeat Steps 1 to 3.
- 5** Press  $\leftarrow/\uparrow/\downarrow/\rightarrow$  repeatedly to set [TEST TONE] to [OFF] after adjusting the speaker level.

**Note**

- The test tone signals are not output from the HDMI OUT jack.

**Tip**

- To adjust the volume of all the speakers at one time, turn the VOLUME control on the unit, or press VOLUME +/- on the remote.
- To return to the default setting when changing a setting, select the item, then press CLEAR. Note that only the [CONNECTION] setting does not return to the default setting.

## Presetting Radio Stations

You can preset 20 FM stations, and 10 AM stations. Before tuning, make sure to turn down the volume to minimum.

### Tip

- You can operate the tuner function by observing the following display on the TV screen.

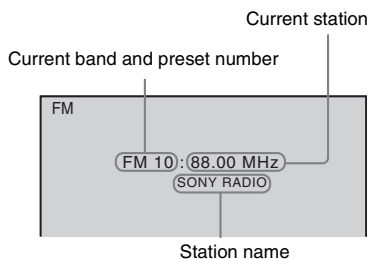

- Press **FUNCTION +/-** repeatedly until **“TUNER FM”** or **“TUNER AM”** appears in the front panel display.

- Press and hold **TUNING +/-** until the auto scanning starts.

Scanning stops when the system tunes in a station. **“TUNED”** and **“ST”** (for stereo program) appear in the front panel display.

- Press **SYSTEM MENU**.

- Press **↑/↓** repeatedly until **“MEMORY”** appears in the front panel display.

- Press **⊕** or **→**.

A preset number appears in the front panel display.

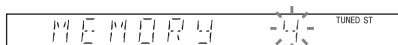

- Press **↑/↓** to select the preset number you want.

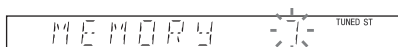

### Tip

- You can select the preset number directly by pressing the number buttons.

- Press **⊖**.

**“COMPLETE”** appears in the front panel display, and the station is stored.

- Repeat Steps 2 to 7 to store other stations.

- Press **SYSTEM MENU**.

The system menu turns off.

### To change the preset number

Restart from Step 2.

### To change the AM tuning interval (except for Russian and Middle Eastern models)

The AM tuning interval can be set to either 10 kHz or 9 kHz.

To change the AM tuning interval, first tune in any AM station, then turn off the system by pressing **I/⏻** on the unit. While holding down **▶▶** on the unit, press **I/⏻** on the unit to turn on the power. If you change the interval, AM preset stations will be erased.

To reset the interval, repeat the same procedure.

# Listening to the Radio

Preset radio stations in the system's memory first (see "Presetting Radio Stations" (page 70)).

- 1 Press **FUNCTION +/-** repeatedly until "TUNER FM" or "TUNER AM" appears in the front panel display.

The last received station is tuned in.

- 2 Press **PRESET +/-** repeatedly to select the preset station.

Each time you press the button, the system tunes in one preset station.

#### Tip

- You can select the preset station number directly by pressing the number buttons.

- 3 Adjust the volume by pressing **VOLUME +/-**.

## To turn off the radio

Press **I/O**.

## To listen to non-preset radio stations

Use manual or automatic tuning in Step 2.

For manual tuning, press **TUNING +/-** repeatedly.

For automatic tuning, press and hold **TUNING +/-**. The automatic tuning stops automatically when the system receives the radio station. To stop the automatic tuning manually, press **TUNING +/-** or **■**.

## To listen to radio stations when you know the frequencies

- 1 Press **FUNCTION +/-** repeatedly until "TUNER FM" or "TUNER AM" appears in the front panel display.

- 2 Press **D.TUNING**.

- 3 Press the number buttons to select the frequencies.

- 4 Press **+**.

#### Tip

- To improve reception, reorient the connected antennas (aerials).

## If an FM program is noisy

If an FM program is noisy, you can select monaural reception. There will be no stereo effect, but reception will improve.

- 1 Press **SYSTEM MENU**.

- 2 Press **↑/↓** repeatedly until "FM MODE" appears in the front panel display.

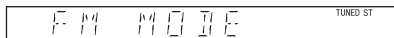

- 3 Press **+** or **→**.

- 4 Press **↑/↓** to select "MONO."

- "STEREO": Stereo reception.
- "MONO": Monaural reception.

- 5 Press **+**.

The setting is made.

- 6 Press **SYSTEM MENU**.

The system menu turns off.

## Naming preset stations

You can enter a name for preset stations. These names (for example, "XYZ") appear in the front panel display when a station is selected.

Only one name can be entered for each preset station.

- 1 Press **FUNCTION +/-** repeatedly until "TUNER FM" or "TUNER AM" appears in the front panel display.

The last received station is tuned in.

- 2 Press **PRESET +/-** repeatedly to select the preset station you want to create an index name for.

- 3 Press **SYSTEM MENU**.

- 4 Press **↑/↓** repeatedly until "NAME IN" appears in the front panel display.

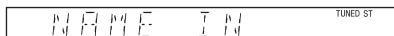

- 5 Press **+** or **→**.

- 6 Create a name by using **←/↑/↓/→**.

Press **↑/↓** to select a character, then press **→** to move the cursor to the next position.



You can input letters, numbers, and other symbols for a radio station.

### If you make a mistake

Press  $\leftarrow/\rightarrow$  repeatedly until the character to be changed flashes, then press  $\uparrow/\downarrow$  to select the desired character.

To erase the character, press  $\leftarrow/\rightarrow$  repeatedly until the character to be erased flashes, then press CLEAR.

## 7 Press $\oplus$ .

“COMPLETE” appears in the front panel display, and the station name is stored.

## 8 Press SYSTEM MENU.

The system menu turns off.

## Viewing the station name or frequency in the front panel display

When the system is set to “TUNER FM” or “TUNER AM,” you can check the frequency using the front panel display.

### Press DISPLAY.

Each time you press DISPLAY, the display changes:

①  $\rightarrow$  ②  $\rightarrow$  ....  $\rightarrow$  ①  $\rightarrow$  ....

### ■ “TUNER FM”

#### When the station name is set

- ① Station name  
Ex. “SONY RADIO”
- ② Frequency  
Ex. “FM1 87.50”
- ③ The “FM MODE” setting  
Ex. “STEREO”

#### When the station name is not set:

- ① Frequency  
Ex. “FM1 87.50”
- ② The “FM MODE” setting  
Ex. “STEREO”

### ■ “TUNER AM”

#### When the station name is set

- ① Station name  
Ex. “SONY RADIO”
- ② Frequency  
Ex. “AM1 576”

#### When the station name is not set:

- ① Frequency  
Ex. “AM1 576”

#### Note

- The system returns to the original display when several seconds has elapsed.



## Control for HDMI/External Audio Device

# Using the Control for HDMI Function for “BRAVIA” Sync

This function is available on TVs with the “BRAVIA” Sync function only.

By connecting Sony components that are compatible with the Control for HDMI function with an HDMI cable (not supplied), operation is simplified as below:

- Theater/Theatre Mode (page 74)
- One-Touch Play (page 74)
- System Power Off (page 75)
- System Audio Control (page 75)
- Volume Limit (page 75)

Control for HDMI is a mutual control function standard used by CEC (Consumer Electronics Control) for HDMI (High-Definition Multimedia Interface).

The Control for HDMI function will not work in the following cases:

- When you connect this system to a component which is not compatible with the Control for HDMI function.
- A component does not have an HDMI jack.

There are convenient buttons on the system’s remote for operating the TV, such as THEATER/THEATRE\*, ONE-TOUCH PLAY, TV I/O. For details, see “Controlling the TV with the Supplied Remote” (page 85) and refer to the operating instructions of the TV.

\* The button name differs depending on the area.

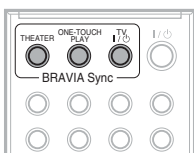

### Note

- Depending on the connected component, the Control for HDMI function may not work. Refer to the operating instructions supplied with the component.
- The Control for HDMI function may not work if you connect a component other than Sony, even if the component is compatible with the Control for HDMI function.

## Preparing for the Control for HDMI function

### (Control for HDMI - Easy Setting)

The system is compatible with the Control for HDMI - Easy Setting function. If the TV is compatible with the Control for HDMI - Easy Setting function, you can set the system’s [CONTROL FOR HDMI] function automatically by setting the TV. For details, refer to the operating instructions of the TV.

If the TV is not compatible with the Control for HDMI - Easy Setting function, set the Control for HDMI function of the system and TV manually.



### Note

- Displayed items vary depending on the country model.

- 1 Make sure that the system and the TV are connected with an HDMI cable.**
- 2 Turn on the TV and press I/O to turn on the system.**
- 3 Switch the input selector on your TV so that the signal from the system through the HDMI input appears on the TV screen.**
- 4 Set the Control for HDMI function of the system and TV.**

For details of the setting of the system, see the following Steps. For details of the setting of the TV, refer to the operating instructions of the TV (depending on the TV, the default setting of the Control for HDMI function is set to off).

## To set the [CONTROL FOR HDMI] function to on/off

- 1 Press FUNCTION +/- repeatedly until "DVD" appears in the front panel display.
- 2 Press  DISPLAY while the system is in stop mode.  
The Control Menu display appears on the TV screen.
- 3 Press  $\uparrow/\downarrow$  to select  [SETUP], then press  $\oplus$ .  
The options for [SETUP] appear.
- 4 Press  $\uparrow/\downarrow$  to select [CUSTOM], then press  $\oplus$ .  
The Setup Display appears.
- 5 Press  $\uparrow/\downarrow$  to select [HDMI SETUP], then press  $\oplus$ .  
The options for [HDMI SETUP] appear.
- 6 Press  $\uparrow/\downarrow$  to select [CONTROL FOR HDMI], then press  $\oplus$ .
- 7 Press  $\uparrow/\downarrow$  to select the setting, then press  $\oplus$ .
  - [OFF]: Off.
  - [ON]: On.

### Note

- When [Please verify the HDMI connection.] appears, make sure the HDMI connection is correct.

## Using the Theater/Theatre Mode

### (Theater/Theatre Mode)

If your TV is compatible with the Theater/Theatre Mode, you can enjoy optimal image suited for movies and the sound is output from the system's speaker automatically by pressing THEATER/THEATRE\*.





\* The button name differs depending on the area.

## Watching DVD by a single button press

### (One-Touch Play)

By only pressing ONE-TOUCH PLAY, the TV turns on, the TV is set for DVD input mode, and the system starts playing a disc automatically.

The One-Touch Play also works when:

- You press  while the disc tray is opened and  appears in the front panel display.
- You close the disc tray by pressing the disc tray.
- You press DVD TOP MENU/DVD MENU and  appears in the front panel display.
- You select the "DVD" function by pressing FUNCTION +/- and  appears in the front panel display.

### Note

- One-Touch Play does not work when you press .

The system and TV work as follows (e.g.):

This system	TV
Turns on. (If not already turned on.)	Turns on. (If not already turned on.)
↓	↓
Switches to "DVD" function.	Switches to HDMI input.
↓	↓
Starts playing the disc and outputs the sound.	Minimizes sound level. (System Audio Control)

### Note

- Make sure the HDMI connection is correct, and set the [CONTROL FOR HDMI] to [ON].
- Depending on the TV, the beginning of the content may not be played back.
- Depending on the disc, playback may take a while to start.

## Turning the system off in sync with the TV

### (System Power Off)

When you turn the TV off by using the POWER button on the TV's remote or TV  on the system's remote, the system turns off automatically.

#### Note

- Before using the System Power Off function, set the function for TV power. For details, refer to the operating instructions of the TV.
- Depending on the status of the system (ex. while other than "DVD" or "TV/VIDEO" function, or playing a CD), the system may not turn off automatically.

## Enjoying TV sound from the speakers in this system

### (System Audio Control)

You can enjoy TV sound in this system by easy operation.

To use this function, connect the system and the TV with an audio cord (not supplied) and an HDMI cable (not supplied) (page 26).

Depending on the TV, when you set the system to the "TV/VIDEO" function, the System Audio Control function is activated. TV sound is output from the system speakers, and the volume of the TV speakers is minimized automatically.

You can use the System Audio Control function as follows:

- While you are watching the TV and the function of the system is switched to "TV/VIDEO," TV sound is output from the system speakers automatically.
- You can control the system's volume by the remote of the TV.
- If you turn the system off or set the function of the system to other than "TV/VIDEO," TV sound is output from the TV speakers.

You can also operate the System Audio Control function from the TV menu. For details, refer to the operating instructions of the TV.

#### Note

- If the TV is turned on before turning on the system, TV sound will not be output for a moment.
- While the TV is in PAP (picture and picture) mode, the System Audio Control function will not work. When the TV exits PAP mode, the output method of the TV returns to the one before PAP mode.
- If you select a TV program during DVD playback with the system, the "TV/VIDEO" function is automatically set to output TV sound.
- When you activate One-Touch Play during watching TV, the System Audio Control function is activated and the TV sound is muted.

#### Tip

- You can connect the system and the TV audio digitally. For details, see (page 29).

## Setting the Maximum Volume Level of the System

### (Volume Limit)

If you change the output method of the TV to the system speaker on the TV menu or by pressing THEATER\* or THEATRE\*, loud sound may be output depending on the volume level of the system. You can prevent this by limiting the maximum level of the volume. For details, see "[VOLUME LIMIT]" (page 65).

\* The button name differs depending on the area.

# Using the DIGITAL MEDIA PORT Adapter

The DIGITAL MEDIA PORT (DMPORT) adapter is for enjoying sound from a portable audio source or computer. By connecting a DIGITAL MEDIA PORT adapter, you can enjoy sound from the connected component on the system.

Available DIGITAL MEDIA PORT adapters vary in each area.

The DIGITAL MEDIA PORT adapter (TDM-iP10\*) is supplied with the system (a DIGITAL MEDIA PORT adapter other than TDM-iP10 is not supplied).

For details on connecting the DIGITAL MEDIA PORT adapter, see “To connect the DIGITAL MEDIA PORT adapter” (page 30).

\* TDM-iP10 is supplied for North American models only.

## Note

- Do not connect an adapter other than the DIGITAL MEDIA PORT adapter.
- Do not connect or disconnect the DIGITAL MEDIA PORT adapter to/from the unit while the system is turned on.
- Depending on the type of DIGITAL MEDIA PORT adapter, the images are also output. In this case, the system outputs the composite video signal only, regardless of the type of video signal.
- When you use the system and the Bluetooth Wireless Audio Adapter (such as TDM-BT1, not supplied) at the same time, transmission distance between the Bluetooth transmitter and Bluetooth Wireless Audio Adapter may be reduced. In this case, place the Bluetooth transmitter as far as possible from the system, or move the Bluetooth Wireless Audio Adapter closer to the Bluetooth transmitter.
- When you use the system and the Wireless Network Audio Adapter (such as TDM-NC1, not supplied) at the same time, place the Wireless Network Audio Adapter as far as possible from the system.

## Playing the connected component on the system

- 1 Press FUNCTION +/- repeatedly until “DMPORT” appears in the front panel display.**
- 2 Start playback of the connected component.**

The sound and images from the connected component are played on the system or connected TV.

For operation details, refer to the operating instructions of the DIGITAL MEDIA PORT adapter.

## Tip

- When listening to MP3 files or other compressed music using a portable audio source, you can enhance the sound. Select “A.F.D. STD” for “DEC. MODE” (page 40). To cancel, select other than “A.F.D. STD.”
- Depending on the type of DIGITAL MEDIA PORT adapter, you may be able to operate a connected component using either the buttons on the remote or the unit. The following illustration shows an example of buttons that can be used in this case.

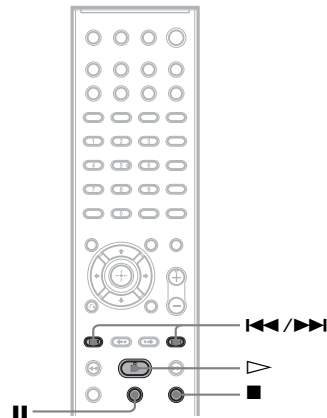

# Using an S-AIR Product

(DAV-HDX275/DAV-HDX475 only)

The unit is compatible with the S-AIR function (page 104), which allows sound transmission between S-AIR products.

When you purchase the S-AIR product, you need to perform the following settings to establish the sound transmission.

## About S-AIR products

There are two types of S-AIR product.

- S-AIR main unit (this unit): This is for transmitting sound. You can use up to three S-AIR main unit. (The number of usable S-AIR main unit depends on the use environment.)
- S-AIR sub unit: This is for receiving sound.
  - Surround amplifier: You can enjoy surround speaker sound wirelessly.
  - S-AIR receiver: You can enjoy system sound in another room.

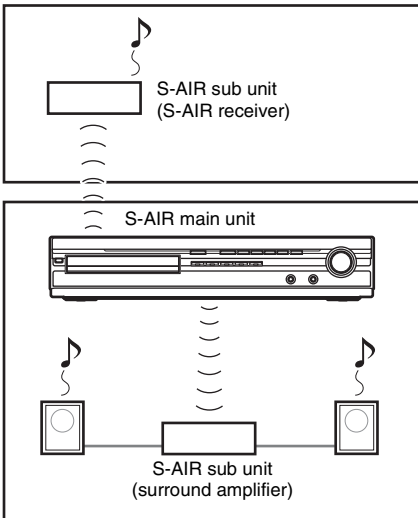

## Inserting the wireless transmitter/transceiver

To make use of the S-AIR function, you need to insert the wireless transmitter (not supplied) into the unit and the wireless transceiver (not supplied) into the S-AIR sub unit.

### Note

- When you insert the wireless transmitter/transceiver, make sure that the AC power cord (mains lead) is not connected to a wall outlet (mains).
- Do not touch the terminals of the wireless transmitter/transceiver.

## To insert the wireless transmitter into the unit

- 1** Remove the screws and detach the slot cover.

Rear of the unit

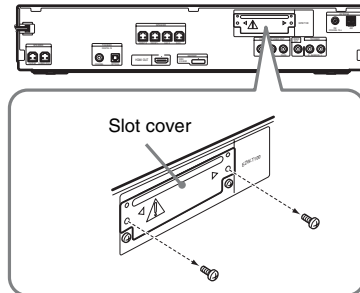

### Note

- Remove the screws from the slot cover bearing the caution mark. Do not remove other screws.
- The slot cover is no longer necessary; however, keep it after detaching.

- 2** Insert the wireless transmitter.

Rear of the unit

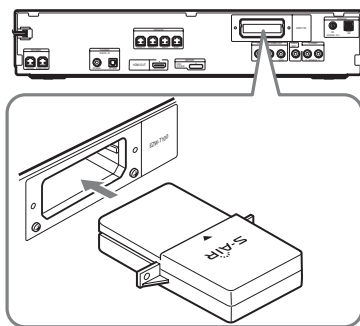

**Note**

- Insert the wireless transmitter with the S-AIR logo facing up.
- Insert the wireless transmitter so that the ▼ marks are aligned.
- Do not insert other than the wireless transmitter into the EZW-T100 slot.

- 3** Make sure to use the same screws to secure the wireless transmitter.

Rear of the unit

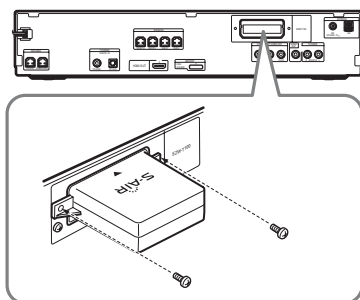

**Note**

- Do not use other screws to fasten the wireless transmitter.

## To insert the wireless transceiver into the S-AIR sub unit

For details on installing the wireless transceiver into the S-AIR sub unit, such as a surround amplifier or S-AIR receiver, see the operating instructions of the S-AIR sub unit.

## Establishing sound transmission between the unit and S-AIR sub unit (ID setting)

*For the surround amplifier  
For the S-AIR receiver*

Simply by matching the ID of the unit and the S-AIR sub unit, you can establish sound transmission. You can use multiple S-AIR main unit by setting a different ID for each component.

### To set the ID of the unit

- 1** Press **I/⏻** on the unit.  
The system turns on.
- 2** Press **FUNCTION +/-** repeatedly until “DVD” appears in the front panel display.
- 3** Press **⏻ DISPLAY** while the system is in stop mode.  
The Control Menu display appears on the TV screen.
- 4** Press **↑/↓** to select **[SETUP]**, then press **+**.  
The options for [SETUP] appear.
- 5** Press **↑/↓** to select **[CUSTOM]**, then press **+**.  
The Setup Display appears.
- 6** Press **↑/↓** to select **[AUDIO SETUP]**, then press **+**.  
The options for [AUDIO SETUP] appear.
- 7** Press **↑/↓** to select **[S-AIR SETUP →]**, then press **+**.

**Note**

- When the wireless transmitter is not inserted in the unit, [S-AIR SETUP] cannot be selected.

- 8** Press **↑/↓** to select **[ID]**, then press **+**.
- 9** Press **↑/↓** to select the desired ID, then press **+**.  
You can select any ID (A, B, or C).  
The confirmation display appears.

## 10 Press ⊕.

Set the S-AIR sub unit to the same ID.  
Sound transmission is established as follows (example):

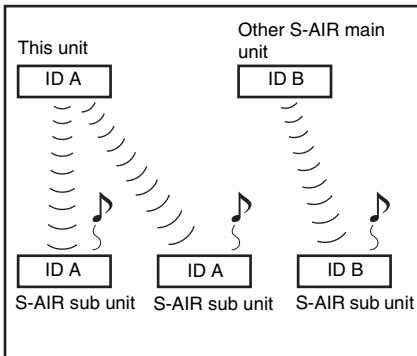

### Tip

- To confirm the current ID, perform Steps 1 to 7 above. When you pair the unit with the S-AIR sub unit (page 80), [(PAIRING)] appears beside ID on the display for selecting ID.

## To set the ID of the surround amplifier

Refer to the operating instructions of the surround amplifier.

## To set the ID of the S-AIR receiver

Refer to the operating instructions of the S-AIR receiver.

### Note

- It is easy to set the same ID for the unit and S-AIR sub unit to establish sound transmission. However, neighbors may also receive your system's sound if IDs are the same, or you may receive the sound from neighbors. To prevent this, you can identify the unit with a specific S-AIR sub unit by performing the pairing operation (page 80).

## Enjoying the system's sound in another room

### For the S-AIR receiver

You can enjoy the system's sound by using the S-AIR receiver. The S-AIR receiver can be

installed anywhere, regardless of the location of the unit, for enjoying the system's sound in another room.

For details of the S-AIR receiver, refer to the operating instructions of the S-AIR receiver.

## 1 Set the ID of the S-AIR receiver to that of the unit.

- To set the ID of the unit, see "To set the ID of the unit" (page 78).
- To set the ID of the S-AIR receiver, refer to the operating instructions of the S-AIR receiver.

### Note

- When you are using another S-AIR sub unit, such as a surround amplifier, do not change the ID of the unit. Set the ID of the S-AIR receiver to the same ID as the unit.
- When you pair the unit and another S-AIR sub unit, such as a surround amplifier, by the pairing operation, you need to perform the pairing operation between the unit and the S-AIR receiver. For details, see "Identifying the unit with a specific S-AIR sub unit (Pairing operation)" (page 80).

## 2 Press S-AIR MODE on the remote.

The S-AIR mode appears in the front panel display. Each time you press S-AIR MODE, the S-AIR mode changes.

- "PARTY": The S-AIR receiver outputs sound according to function set on the unit.
- "SEPARATE": You can set the desired function for the S-AIR receiver while unit functions do not change.

## 3 Select the desired function on the S-AIR receiver.

### ■ When "PARTY" is set

The function changes in the same sequence as you press FUNCTION +/- (page 38).

### ■ When "SEPARATE" is set

The function changes as follows.

"MAIN UNIT" → "TUNER FM" →  
"TUNER AM" → "DMPORT" →  
"AUDIO" → ...

To enjoy the same function as the unit, select “MAIN UNIT.”

When “TUNER FM” or “TUNER AM” is selected on the unit, you can only select the same band for the tuner on the S-AIR receiver. In this case, when you select other than “TUNER FM” or “TUNER AM” on the unit, you can select any band for the tuner on the S-AIR receiver.

#### 4 Adjust the volume on the S-AIR receiver.

##### Note

- When the sound is other than 2 channel stereo, multi channel sound is downmixed to 2 channel.
- The sound of the S-AIR receiver may be cut off by operation of the unit.

### To control the system from the S-AIR receiver

You can control the system from the S-AIR receiver by using the following buttons.

Press	Operation
▷, II, ■, ◀◀/▶▶	Share the same operations on the remote and unit.
S-AIR CH	Change the function of the system.

For details, refer to the operating instructions of the S-AIR receiver.

### Enjoying the S-AIR receiver while the unit is in standby mode

#### For the S-AIR receiver

You can enjoy the S-AIR receiver while the unit is in standby mode by setting “S-AIR STBY” to “ON.”

- 1 Press **SYSTEM MENU**.
- 2 Press **↑/↓** repeatedly until “S-AIR STBY” appears in the front panel display, then press **⊕** or **→**.
- 3 Press **↑/↓** to select the desired setting.

- “ON”: You can enjoy the S-AIR receiver while the unit is in standby mode or turned on.
- “OFF”: You cannot enjoy the S-AIR receiver while the unit is in standby mode. The default setting differs depending on the model.

#### 4 Press **⊕**.

The setting is made.

#### 5 Press **SYSTEM MENU**.

The system menu turns off.

##### Note

- When you set “S-AIR STBY” to “ON,” the power consumption during the standby mode increases.
- When you turn the system off while “S-AIR STBY” is set to “ON,” “S-AIR” flashes (when sound transmission between the unit and S-AIR receiver is not established), or lights up (when sound transmission between the unit and S-AIR receiver is established) in the front panel display.
- If you turn the system off with the disc tray opened while “S-AIR STBY” is set to “ON,” the disc tray may not close automatically.
- When the wireless transmitter is not inserted in the unit, you cannot set “S-AIR STBY.”
- “S-AIR STBY” is set to “OFF” automatically when the wireless transmitter is removed from the unit.

### Identifying the unit with a specific S-AIR sub unit (Pairing operation)

#### For the surround amplifier

#### For the S-AIR receiver

It is easy to set the same ID for the unit and an S-AIR sub unit, such as a surround amplifier or S-AIR receiver, to establish sound transmission. However, neighbors may also receive your system’s sound if IDs are the same, or you may receive the sound from neighbors. To prevent this, you can identify the unit with a specific S-AIR sub unit by performing the pairing operation.

#### When you perform pairing

Before pairing, sound transmission is established by the ID (example).



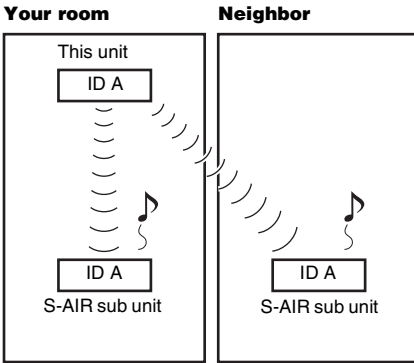

After pairing, sound transmission is established between the paired unit and S-AIR sub unit(s) only.

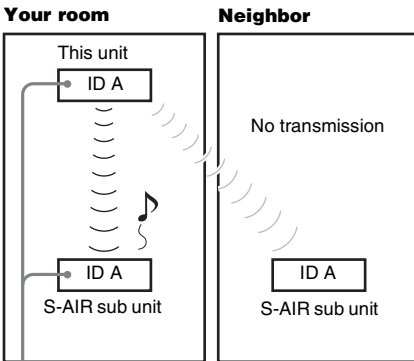

Pairing

- 1 Place the S-AIR sub unit that you want to pair near the unit.**

**Note**

- Remove headphones from the surround amplifier (if connected).

- 2 Match the IDs of the unit and the S-AIR sub unit.**

- To set the ID of the unit, see “To set the ID of the unit” (page 78).
- To set the ID of the S-AIR sub unit, refer to the operating instructions of the S-AIR sub unit.

- 3 Press FUNCTION +/- repeatedly until “DVD” appears in the front panel display.**

- 4 Press DISPLAY while the system is in stop mode.**

The Control Menu display appears on the TV screen.

- 5 Press to select [SETUP], then press .**

The options for [SETUP] appear.

- 6 Press to select [CUSTOM], then press .**

The Setup Display appears.

- 7 Press to select [AUDIO SETUP], then press .**

The options for [AUDIO SETUP] appear.

- 8 Press to select [S-AIR SETUP →], then press .**

**Note**

- When the wireless transmitter is not inserted in the unit, [S-AIR SETUP] cannot be selected.

- 9 Press to select [PAIRING], then press .**

The confirmation display appears.

- 10 Press to select [YES], then press .**

The unit starts pairing.

To not perform pairing, select [NO].

- 11 Start pairing of the S-AIR sub unit.**

**■ For the surround amplifier**

Refer to the operating instructions of the surround amplifier.

When sound transmission is established, the confirmation display appears.

**■ For the S-AIR receiver**

Refer to the operating instructions of the S-AIR receiver.

When sound transmission is established, the confirmation display appears.

**Note**

- Perform the pairing within several minutes after Step 10. If you do not, the pairing is canceled automatically and the confirmation display appears. To perform pairing, select [YES]. To return to the previous display, select [NO].

## 12 Press ←/→ to select the next operation.

### ■ To finish pairing

Select [NO], then press ⊕.

### ■ To perform pairing of another S-AIR sub unit

Select [YES], then press ⊕.

#### Note

- If you perform the pairing operation between the unit and another S-AIR sub unit (page 80), sound transmission established by ID is canceled.
- When you perform pairing, [(PAIRING)] appears beside ID on the display for selecting ID.

## To cancel pairing

Perform the ID setting of the unit according to the procedure of “To set the ID of the unit.” If you select a new ID (you can select the same ID as before), pairing is canceled.

## If sound transmission is unstable

### *For the surround amplifier*

### *For the S-AIR receiver*

If you use multiple wireless systems which sharing the 2.4 GHz band, such as wireless LAN or Bluetooth, the transmission of S-AIR products or other wireless systems may be unstable. In this case, the transmission may be improved by changing the following “RF CHANGE” setting.

## 1 Press SYSTEM MENU.

## 2 Press ↑/↓ repeatedly until “RF CHANGE” appears in the front panel display, then press ⊕ or →.

## 3 Press ↑/↓ to select the desired setting.

- “AUTO”: Normally select this. The system change “RF CHANGE” to “ON” or “OFF” automatically.
- “ON”: The system transmits sound by searching the better channel for transmitting.
- “OFF”: The system transmits sound by fixing the channel for transmitting.

## 4 Press ⊕.

The setting is made.

## 5 Press SYSTEM MENU.

The system menu turns off.

## 6 When you set “RF CHANGE” to “OFF,” select the ID so that sound transmission is most stabilized (page 78).

#### Note

- When the wireless transmitter is not inserted in the unit, you cannot set “RF CHANGE.”
- In most cases, you will not need to change this setting.
- If “RF CHANGE” is set to “OFF,” transmission between the unit and S-AIR sub unit can be performed using one of the following channels.
  - S-AIR ID A: equivalent channel for Wi-Fi channel 1
  - S-AIR ID B: equivalent channel for Wi-Fi channel 6
  - S-AIR ID C: equivalent channel for Wi-Fi channel 11
- The transmission may be improved by changing the transmission channel (frequency) of the other wireless system(s). For details, refer to the operating instructions of the other wireless system(s).

# Getting Optimal Surround Sound for a Room

## [SPEAKER FORMATION]

Depending on the shape of the room, you cannot install some speakers. For the better surround sound, Sony recommends that first you decide the position of the speakers.

- 1** Press **FUNCTION +/-** repeatedly until “DVD” appears in the front panel display.
- 2** Press **DISPLAY** while the system is in stop mode.  
The Control Menu display appears on the TV screen.
- 3** Press **↑/↓** to select **[SETUP]**, then press **+**.  
The options for [SETUP] appear.
- 4** Press **↑/↓** to select **[CUSTOM]**, then press **+**.  
The Setup Display appears.
- 5** Press **↑/↓** to select **[AUDIO SETUP]**, then press **+**.  
The options for [AUDIO SETUP] appear.
- 6** Press **↑/↓** to select **[SPEAKER FORMATION]**, then press **+**.  
The options for [SPEAKER FORMATION] appear.

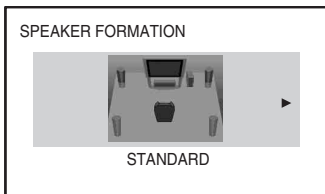

- 7** Press **←/→** to select a setting.
  - [STANDARD]: Select this when you install all the speakers normally.

- [NO CENTER]: Select this when you install the front and surround speakers only.
  - [NO SURROUND]: Select this when you install the center and front speakers only.
  - [FRONT ONLY]: Select this when you install the front speakers only.
  - [ALL FRONT]: Select this when you install all the speakers in front of the listening position.
  - [ALL FRONT - NO CENTER]: Select this when you install the front and surround speakers in front of the listening position.
- 8** Press **+**.  
The setting is made and the confirmation display appears.
  - 9** Press **←/→** to select **[YES]** or **[NO]**, then press **+**.
    - [YES]: Continue with [AUTO CALIBRATION]. Follow the procedure from Step 7 of “Calibrating the Appropriate Settings Automatically” (page 84).
    - [NO]: Exit [SPEAKER FORMATION].

### Note

- In order to enjoy the surround sound after you change the position of the speakers, Sony recommends you set [SPEAKER FORMATION], and then set [AUTO CALIBRATION] (page 84).
- When you change the [CONNECTION] setting in [SPEAKER SETUP] (page 67), the [SPEAKER FORMATION] setting returns to [STANDARD].

# Calibrating the Appropriate Settings Automatically

## [AUTO CALIBRATION]

D. C. A. C. (Digital Cinema Auto Calibration) can set the appropriate surround sound automatically.

### Note

- The system outputs a loud test sound when [AUTO CALIBRATION] starts. You cannot turn the volume down. Give consideration to children and neighbors.
- Make sure that the headphones are not connected to the unit or surround amplifier\*. You cannot operate the following Steps with the headphones connected.

\* DAV-HDX275/DAV-HDX475 only

**1** Press **FUNCTION +/-** repeatedly until "DVD" appears in the front panel display.

**2** Press **DISPLAY** while the system is in stop mode.

The Control Menu display appears on the TV screen.

**3** Press **↑/↓** to select **[SETUP]**, then press **+**.

The options for [SETUP] appear.

**4** Press **↑/↓** to select **[CUSTOM]**, then press **+**.

The Setup Display appears.

**5** Press **↑/↓** to select **[AUDIO SETUP]**, then press **+**.

The options for [AUDIO SETUP] appear.

**6** Press **↑/↓** to select **[AUTO CALIBRATION]**, then press **+**.

The options for [AUTO CALIBRATION] appear.

**7** **Connect the calibration mic (supplied) to the A.CAL MIC jack on the front panel**

Set up the calibration mic at the ear level using a tripod, etc. (not supplied).

The front of each speaker should face the calibration mic, and there should be no

obstruction between the speakers and the calibration mic.

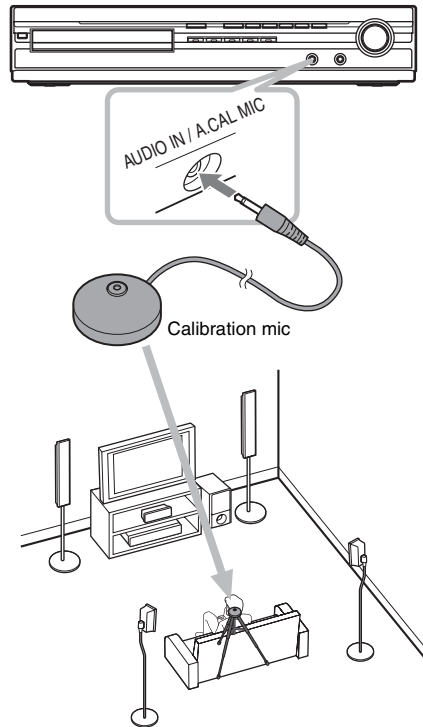

**8** Press **←/→** to select **[YES]**.

**9** Press **+**.

[AUTO CALIBRATION] starts.

Be quiet during the measurement.

### Note

- Before [AUTO CALIBRATION], make sure that the surround amplifier turns on and you install the surround amplifier in the appropriate location. If you install the surround amplifier in an improper location, such as another room, proper measurement will not be obtained. (DAV-HDX275/DAV-HDX475 only.)
- Avoid being in the measurement area and making noise during the measurement (about 3 minute), to avoid measurement failure. During the measurement, test signals are output from the speakers.
- The environment of the room in which the system is installed may affect measurements.

- If an error message appears, follow the message, then select [YES].

An error message appears when:

- the headphones are connected to the unit or surround amplifier\*.
- the calibration mic is not connected.
- front speakers are not correctly connected.
- surround speakers are not correctly connected.
- front and surround speakers are not correctly connected.

\* DAV-HDX275/DAV-HDX475 only.

## 10 Press ←/→ to select [YES] or [NO], then press ⊕.

### ■ The measurement is OK.

Disconnect the calibration mic, then select [YES]. The result is implemented.

### ■ The measurement is not OK.

Follow the message, then select [YES] to retry.

#### Note

- While the Auto Calibration function works:
  - do not turn off the power.
  - do not press any button.
  - do not change the volume.
  - do not change the function.
  - do not change the disc.
  - do not insert or eject a disc.
  - do not connect the headphones to the unit or surround amplifier\*.
  - do not disconnect the calibration mic.
- \* DAV-HDX275/DAV-HDX475 only.
- The measurement for [SUBWOOFER] is always [YES] since the system does not perform subwoofer calibration.

#### Tip

- You can check the distance between the listening position and each speaker. See page 67.

## Controlling the TV with the Supplied Remote

You can control the TV (Sony only) by using following buttons. Use these buttons (other than TV I/⏻, THEATER/THEATRE\*, TV INPUT, and TV VOL +/-) while pressing the TV button.

\* The button name differs depending on the area.

#### Note

- Depending on the TV, you may not be able to control your TV or to use some of the buttons.
- Depending on the area, the name of the button may differ.

By pressing	You can
TV I/⏻	Turn the TV on/off.
THEATER (THEATRE)	Enjoy optimal image suited for movies.
TV INPUT	Switch the TV's input source between the TV and other input sources.
TV VOL +/-	Adjust the TV volume.
TV CH +/-* (PROG +/-*)	Select the TV channel.
Number buttons*, -/-* ENTER*	Select the TV channel.
TOOLS*	Displays the operation menu for the current display.
RETURN*	Return to the previous channel or layer on the menu of the TV.
MENU*	Display the menu of the TV.
MUTING*	Turn off the TV sound temporarily.
←/↑/↓/→*, ⊕ *	Select the item on the menu.

\* Use these buttons while pressing the TV button.

# Using the Sound Effect

## Reinforcing bass frequencies

You can reinforce bass frequencies.

### Press DYNAMIC BASS.

“D. BASS ON” appears in the front panel display and bass frequencies are effectively reinforced.

### To turn off the sound effect

Press DYNAMIC BASS again.

## Enjoying the sound at low volume

You can enjoy sound effects or dialogue, as you would in a movie theater, even at low volume. It is useful for watching movies at night.

### Press NIGHT.

“NIGHT ON” appears in the front panel display and the sound effect is activated.

#### Note

- This effect does not work for a Super Audio CD. When you load a Super Audio CD during “NIGHT ON,” the sound effect turns off automatically.
- When sound is output from the center speaker, this effect is more pronounced, as speech (movie dialog, etc.) is easy to hear. When sound is not output from the center speaker, or you are using the headphones, the system optimally adjusts the volume.

### To turn off the sound effect

Press NIGHT again.

# Using the Sleep Timer

You can set the system to turn off at a preset time, so you can fall asleep listening to music. You can preset the time in 1 or 10-minute increments.

### Press SLEEP.

Each time you press SLEEP, the minutes display (the remaining time) changes by 10-minutes. When you set the sleep timer, “SLEEP” flashes in the front panel display.

### To check the remaining time

Press SLEEP once.

### To change the remaining time

Press SLEEP repeatedly to select the desired time.

### To cancel the sleep timer function

Press SLEEP repeatedly until “SLEEP OFF” appears in the front panel display.

### To set the sleep timer using the system menu

- 1 Press SYSTEM MENU.**
- 2 Press  $\uparrow/\downarrow$  repeatedly until “SLEEP” appears in the front panel display, then press  $\oplus$  or  $\rightarrow$ .**
- 3 Press  $\uparrow/\downarrow$  to select a setting.**

The minutes display (the remaining time) changes in 10-minutes.

**Tip**

  - You can select the remaining time by pressing the number buttons. In this case, you can preset the time in 1-minute increments.
- 4 Press  $\ominus$ .**

The setting is made and “SLEEP” flashes in the front panel display.
- 5 Press SYSTEM MENU.**

The system menu turns off.

# Changing the Brightness of the Front Panel Display

The brightness of the front panel display can be set to either of 2 levels.

- 1 Press SYSTEM MENU.**
- 2 Press  $\uparrow/\downarrow$  repeatedly until "DIMMER" appears in the front panel display, then press  $\oplus$  or  $\rightarrow$ .**
- 3 Press  $\uparrow/\downarrow$  to select the brightness of the front panel display.**
  - "DIMMER OFF": Bright.
  - "DIMMER ON": Dark.
- 4 Press  $\oplus$ .**

The setting is made.
- 5 Press SYSTEM MENU.**

The system menu turns off.

# Viewing Information About the Disc



## Viewing the playing time and remaining time in the front panel display

Press **DISPLAY** repeatedly.

Each time you press **DISPLAY** while playing the disc, the display changes:

① → ② → ... → ① → ...

Some displayed items may disappear after a few seconds.

### ■ DVD VIDEO/DVD-VR

- ① Playing time of the current title
- ② Remaining time of the current title
- ③ Playing time of the current chapter
- ④ Remaining time of the current chapter
- ⑤ Disc name
- ⑥ Title and chapter

### ■ VIDEO CD (without PBC functions)/ Super Audio CD/CD

- ① Playing time of the current track
- ② Remaining time of the current track
- ③ Playing time of the disc
- ④ Remaining time of the disc
- ⑤ Track name
- ⑥ Track and index\*

\* VIDEO CD/Super Audio CD only.

### ■ Super VCD

- ① Playing time of the current track
- ② Track text
- ③ Track and index number

### ■ DATA CD (MP3 file)/DATA DVD (MP3 file)

- ① Playing time and current track number
- ② Track (file) name\*

\* If an MP3 file has the ID3 tag, the system will display a folder name/track (file) name from the ID3 tag information.

The system can support ID3 ver 1.0/1.1/2.2/2.3. ID3 ver 2.2/2.3 tag information display has priority when both ID3 ver 1.0/1.1 and ver 2.2/2.3 tags are used for a single MP3 file.

■ **DATA CD (DivX video file)/DATA DVD (DivX video file) (Except for United Kingdom and North American models)**

- ① Playing time of the current file
- ② Current file name
- ③ Current album and file number

**Note**

- The system can only display the first level of the DVD/CD text, such as the disc name or title.
  - If a file name of the MP3 file cannot be displayed, “\*\*” will appear in the front panel display instead.
  - The disc name or track name may not be displayed depending on the text.
  - Playing time of MP3 files and DivX video files\* may not be displayed correctly.
- \* Except for United Kingdom and North American models.

**Tip**

- When the system is playing a VIDEO CD with PBC functions, the playing time is displayed.

## Viewing the playing time and remaining time on the TV screen

**1 Press DISPLAY during playback.**

The following display appears on the TV screen.

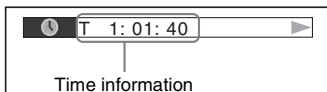

**2 Press DISPLAY repeatedly to change the time information.**

The display and the kinds of time that you can check depend on the disc you are playing.

■ **DVD VIDEO/DVD-VR**

- T \*\*: \*\*: \*\*: \*\*: \*\*  
Playing time of the current title
- T- \*\*: \*\*: \*\*: \*\*: \*\*  
Remaining time of the current title
- C \*\*: \*\*: \*\*: \*\*: \*\*  
Playing time of the current chapter
- C- \*\*: \*\*: \*\*: \*\*: \*\*  
Remaining time of the current chapter

■ **VIDEO CD (with PBC functions)**

- \*\*: \*\*: \*\*: \*\*  
Playing time of the current scene

■ **VIDEO CD (without PBC functions)/Super Audio CD/CD**

- T \*\*: \*\*: \*\*: \*\*  
Playing time of the current track
- T- \*\*: \*\*: \*\*: \*\*  
Remaining time of the current track
- D \*\*: \*\*: \*\*: \*\*  
Playing time of the current disc
- D- \*\*: \*\*: \*\*: \*\*  
Remaining time of the current disc

■ **DATA CD (MP3 file)/DATA DVD (MP3 file)**

- T \*\*: \*\*: \*\*: \*\*  
Playing time of the current track

■ **DATA CD (DivX video file)/DATA DVD (DivX video file) (Except for United Kingdom and North American models)**

- \*\*: \*\*: \*\*: \*\*: \*\*: \*\*  
Playing time of the current file

**Note**

- Characters/marks may not be displayed in some languages.
- Depending on the type of disc being played, the system can only display a limited number of characters. Also, depending on the disc, not all text characters will be displayed.

## Checking the play information of the disc

**To check DVD/Super Audio CD/CD text**

Press DISPLAY repeatedly during playback to display text recorded in the DVD/Super Audio CD/CD.

The DVD/Super Audio CD/CD text appears only when text is recorded in the disc. You cannot change the text. If the disc does not contain text, “NO TEXT” appears.

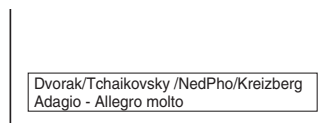



## To check DATA CD/DATA DVD (MP3 file/DivX video file<sup>3)</sup>) text

By pressing DISPLAY while playing MP3 files or DivX video files<sup>3)</sup> on a DATA CD/DATA DVD, you can display the name of the folder/MP3 file/DivX video file<sup>3)</sup>, and the audio bit rate (the amount of data per second of the current audio) on the TV screen.

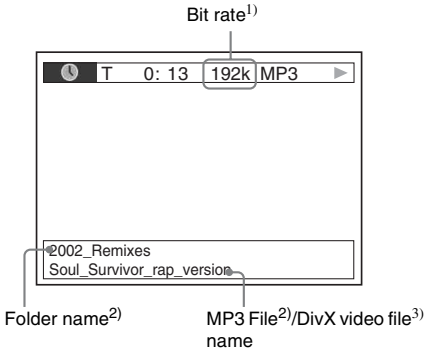

<sup>1)</sup>Appears when:

- playing an MP3 file on a DATA CD/DATA DVD.
- playing a DivX video file that contains MP3 audio signals on a DATA CD/DATA DVD (except for United Kingdom and North American models).

<sup>2)</sup>If an MP3 file has the ID3 tag, the system will display a folder name/track (file) name from the ID3 tag information.

The system can support ID3 ver 1.0/1.1/2.2/2.3. ID3 ver 2.2/2.3 tag information display has priority when both ID3 ver 1.0/1.1 and ver 2.2/2.3 tags are used for a single MP3 file.

<sup>3)</sup>Except for United Kingdom and North American models.

## Checking the date information of JPEG image file

You can check the date information during playback when the Exif\* tag is recorded in the JPEG image file.

**Press**  **DISPLAY twice during playback.**

The Control Menu display appears on the TV screen.

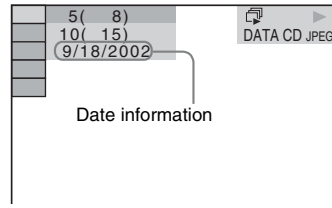

\* “Exchangeable Image File Format” is a digital camera image format defined by the Japan Electronics and Information Technology Industries Association (JEITA).

### Tip

- Date information is [MM/DD/YYYY].  
MM: Month  
DD: Day  
YYYY: Year
- Date information varies depending on the area.

# Returning to the Default Settings

## Returning the system parameters, such as preset stations, to the default settings

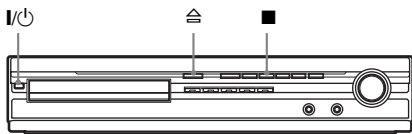



- 1 Press I/⏻ to turn on the system.**
- 2 Press ■, ≡, and I/⏻ on the unit at the same time.**

“COLD RESET” appears in the front panel display and the system returns to default settings.

## Returning the [SETUP] settings to the default

You can return the [SETUP] settings (page 61) other than [PARENTAL CONTROL] to the default settings.



- 1 Press FUNCTION +/- repeatedly until “DVD” appears in the front panel display.**
- 2 Press  DISPLAY while the system is in stop mode.**

The Control Menu display appears on the TV screen.
- 3 Press ↑/↓ to select  [SETUP], then press .**

The options for [SETUP] appear.
- 4 Press ↑/↓ to select [CUSTOM], then press .**

The Setup Display appears.

- 5 Press ↑/↓ to select [SYSTEM SETUP], then press .**

The options for [SYSTEM SETUP] appear.
- 6 Press ↑/↓ to [RESET] and press .**
- 7 Press  to select [YES].**

You can also quit the process and return to the Control Menu display by selecting [NO] here.
- 8 Press .**

Do not press I/⏻ while resetting the system as it takes a few seconds to complete.

### Note

- The [MODE (MUSIC, IMAGE)], [INTERVAL], [EFFECT], and [MULTI/2CH] settings are also return to the default settings.

## Precautions

### On power sources

- Unplug the unit from the wall outlet (mains) if you do not intend to use it for an extended period of time. To disconnect the cord, pull it out by the plug, never by the cord.

### On placement

- Place the system in a location with adequate ventilation to prevent heat build-up in the system.
- At high volume, over long periods of time, the cabinet becomes hot to the touch. This is not a malfunction. However, touching the cabinet should be avoided. Do not place the unit in a confined space where ventilation is poor as this may cause overheating.
- Do not block the ventilation slots by putting anything on the system. The system is equipped with a high power amplifier. If the ventilation slots are blocked, the unit can overheat and malfunction.
- Do not place the unit on surfaces (rugs, blankets, etc.) or near materials (curtains, draperies) that may block the ventilation slots.
- Do not install the unit near heat sources such as radiators, or air ducts, or in a place subject to direct sunlight, excessive dust, mechanical vibration, or shock.
- Do not install the unit in an inclined position. It is designed to be operated in a horizontal position only.
- Keep the unit and discs away from components with strong magnets, such as microwave ovens, or large loudspeakers.
- Do not place heavy objects on the unit.

### On operation

- If the system is brought directly from a cold to a warm location, or is placed in a very damp room, moisture may condense on the lenses inside the control unit. Should this occur, the system may not operate properly. In this case, remove the disc and leave the system turned on for about half an hour until the moisture evaporates.
- When you move the system, take out any disc. If you don't, the disc may be damaged.
- If anything falls into the cabinet, unplug the unit and have it checked by qualified personnel before operating it any further.

### On adjusting volume

- Do not turn up the volume while listening to a section with very low level inputs or no audio signals. If you do, the speakers may be damaged when a peak level section is suddenly played.

### On cleaning

- Clean the cabinet, panel, and controls with a soft cloth slightly moistened with a mild detergent solution. Do not use any type of abrasive pad, scouring powder or solvent such as alcohol or benzene.  
If you have any questions or problems concerning your system, please consult your nearest Sony dealer.

### On cleaning discs, disc/lens cleaners

- **Do not use cleaning discs or disc/lens cleaners (including wet or spray types). These may cause the apparatus to malfunction.**

### On your TV's color

- If the speakers should cause the TV screen to have color irregularity, turn off the TV then turn it on after 15 to 30 minutes. If color irregularity should persist, place the speakers further away from the TV set.

#### IMPORTANT NOTICE

Caution: This system is capable of holding a still video image or on-screen display image on your television screen indefinitely. If you leave the still video image or on-screen display image displayed on your TV for an extended period of time you risk permanent damage to your television screen. Projection televisions are especially susceptible to this.

### On moving the system

- 1 Press FUNCTION repeatedly to select "DVD."**
- 2 Make sure that all discs are removed from the unit.**
- 3 Press  $\triangleright$  and I/O simultaneously. "MECHA LOCK" and "UNPLUG" appear alternately in the front panel display after "STANDBY."**
- 4 Remove the AC power cord (mains lead) from the wall outlet (mains).**

---

# Notes about the Discs

## On handling discs

- To keep the disc clean, handle the disc by its edge. Do not touch the surface.
- Do not stick paper or tape on the disc.



- Do not expose the disc to direct sunlight or heat sources such as hot air ducts, or leave it in a car parked in direct sunlight as the temperature may rise considerably inside the car.
- After playing, store the disc in its case.

## On cleaning

- Before playing, clean the disc with a cleaning cloth. Wipe the disc from the center out.



- Do not use solvents such as benzine, thinner, commercially available cleaners, or anti-static spray intended for vinyl LPs.

This system can only play back a standard circular disc. Using neither standard nor circular discs (e.g., card, heart, or star shape) may cause a malfunction.

Do not use a disc that has a commercially available accessory attached, such as a label or ring.

# Troubleshooting

If you experience any of the following difficulties while using the system, use this troubleshooting guide to help remedy the problem before requesting repairs. Should any problem persist, consult your nearest Sony dealer.

Note that if service personnel changes some parts during repair, these parts may be retained.

When you install the S-AIR sub unit (not supplied), in the event of a problem with the S-AIR function, have a Sony dealer check the entire system together (main unit and S-AIR sub unit).

## Power

Symptom	Remedy
The power is not turned on.	<ul style="list-style-type: none"><li>• Check that the AC power cord (mains lead) is connected securely.</li><li>• Press <b>I/⏻</b> after “STANDBY” disappears from the front panel display.</li></ul>
If “PROTECTOR” and “PUSH POWER” appear alternately in the front panel display.	<p>Press <b>I/⏻</b> to turn off the system, and check the following items after “STANDBY” disappears.</p> <ul style="list-style-type: none"><li>• Are the + and – speaker cords short-circuited?</li><li>• Are you using only the specified speakers?</li><li>• Is anything blocking the ventilation holes of the system?</li><li>• After checking the above items and fixing any problems, turn on the system. If the cause of the problem cannot be found even after checking all the above items, consult your nearest Sony dealer.</li></ul>

## Picture

Symptom	Remedy
There is no picture.	<ul style="list-style-type: none"><li>• The video connecting cords are not connected securely.</li><li>• The video connecting cords are damaged.</li><li>• The unit is not connected to the correct TV input jack (page 26).</li><li>• The video input on the TV is not set so that you can view pictures from the system.</li><li>• Check the output method on your system (page 26).</li><li>• You have set progressive format but your TV cannot accept the signal in progressive format. In this case, return the setting to interlace format (the default setting) (page 37).</li><li>• Even if your TV is compatible with progressive format (525p/625p) signals, the image may be affected when you set progressive format. In this case, return the setting to interlace format (the default setting) (page 37).</li><li>• Re-connect the connecting cord securely.</li><li>• The unit is connected to an input device that is not HDCP (High-bandwidth Digital Content Protection) compliant (“HDMI” on the front panel does not light up) (page 26).</li><li>• If the HDMI OUT jack is used for video output, changing the type of video signal output from the HDMI OUT jack. It may solve the problem (page 37). Connect the TV and the unit using a video jack other than the HDMI OUT, and switch the TV’s input to the connected video input so that you can see the on-screen displays. Change the type of video signal output from the HDMI OUT jack, and switch the TV’s input back to HDMI. If the picture still does not appear, repeat the Steps and try other options.</li><li>• You have set [PROGRESSIVE (COMPONENT OUT)] in [VIDEO SETUP] to [ON] (page 63) even though your TV cannot accept the progressive signal. In this case, disconnect the HDMI cable from the unit and then set to [OFF].</li></ul>
Picture noise appears.	<ul style="list-style-type: none"><li>• The disc is dirty or flawed.</li><li>• If the picture output from your system goes through your VCR to get to your TV, the copy-protection signal applied to some DVD programs could affect picture quality. If you still experience problems even when you connect your unit directly to your TV, try connecting your unit to your TV’s video input (page 26).</li></ul> <p>* Depending on the country model, [720 × 576p] may appear.</p>
Even though you set the aspect ratio in [TV TYPE] of [VIDEO SETUP], the picture does not fill the TV screen.	<ul style="list-style-type: none"><li>• The aspect ratio on the disc is fixed.</li></ul>
Color irregularity occurs on the TV screen.	<p>The subwoofer and the front speakers in this system are magnetically shielded to prevent magnetic leakage. However, some leakage may occur, as a high-strength magnet is employed. If this happens, check the following items:</p> <ul style="list-style-type: none"><li>• If the speakers are used with a CRT-based TV or projector, install the speakers at least 0.3 meters (1.0 ft) from the TV set.</li><li>• If the color irregularity persists, turn off the TV set once, then turn it on after 15 to 30 minutes.</li><li>• If howling occurs, reposition the speakers farther away from the TV set.</li><li>• Make sure that no magnetic object (magnetic latch on a TV stand, health care device, toy, etc.) is placed near the speakers.</li></ul>

## Sound

Symptom	Remedy
There is no sound.	<ul style="list-style-type: none"> <li>• The speaker cord is not connected securely.</li> <li>• Press <b>MUTING</b> on the remote if “MUTING ON” is displayed in the front panel display.</li> <li>• The system is in pause mode or in Slow-motion Play mode. Press <math>\triangleright</math> to return to normal play mode.</li> <li>• Fast forward or fast reverse is performed. Press <math>\triangleright</math> to return to normal play mode.</li> <li>• Check the speaker settings (page 67).</li> <li>• Super Audio CD audio signals are not output from the HDMI OUT jack.</li> <li>• The component connected to the HDMI OUT jack does not conform to the audio signal format, in this case set [AUDIO (HDMI)] in [HDMI SETUP] to [ON] (page 65).</li> </ul>
No sound is output from the HDMI OUT jack.	<ul style="list-style-type: none"> <li>• Set [AUDIO (HDMI)] in [HDMI SETUP] to [ON] (page 65).</li> <li>• The HDMI OUT jack is connected to a DVI (Digital Visual Interface) device (DVI (Digital Visual Interface) jacks do not accept audio signals).</li> <li>• The HDMI OUT jack does not output Super Audio CD sound.</li> <li>• Try the following: ① Turn the system off and on again. ② Turn the connected component off and on again. ③ Disconnect and then connect the HDMI cable again.</li> </ul>
The left and right sounds are unbalanced or reversed.	<ul style="list-style-type: none"> <li>• Check that the speakers and components are connected correctly and securely.</li> </ul>
There is no sound from the subwoofer.	<ul style="list-style-type: none"> <li>• Check the speaker connections and settings (pages 24, 67).</li> <li>• Select “A.F.D. STD” for “DEC. MODE” (page 40).</li> </ul>
Severe hum or noise is heard.	<ul style="list-style-type: none"> <li>• Check that the speakers and components are connected securely.</li> <li>• Check that the connecting cords are away from a transformer or motor, and at least 3 meters (10 ft) away from your TV set or a fluorescent light.</li> <li>• Move your TV away from the audio components.</li> <li>• The plugs and jacks are dirty. Wipe them with a cloth slightly moistened with alcohol.</li> <li>• Clean the disc.</li> </ul>
The sound loses stereo effect when you play a VIDEO CD, a CD, or an MP3 file.	<ul style="list-style-type: none"> <li>• Set [AUDIO] to [STEREO] by pressing <b>AUDIO</b> (page 45).</li> <li>• Make sure the unit is connected properly.</li> </ul>
The surround effect is difficult to hear when you are playing a sound track of Dolby Digital, DTS, or MPEG audio.	<ul style="list-style-type: none"> <li>• Make sure the “DEC. MODE” setting (page 40).</li> <li>• Check the speaker connections and settings (pages 24, 67).</li> <li>• Depending on the DVD, the output signal may not be the entire 5.1 channel. It may be monaural or stereo even if the sound track is recorded in Dolby Digital or MPEG audio format.</li> </ul>
The sound comes from the center speaker only.	<ul style="list-style-type: none"> <li>• Depending on the disc, the sound may come from the center speaker only.</li> </ul>
No sound is heard from the center speaker.	<ul style="list-style-type: none"> <li>• Check the speaker connections and settings (pages 24, 67).</li> <li>• Make sure the “DEC. MODE” setting (page 40).</li> <li>• Depending on the source, the effect of the center speaker may be less noticeable.</li> <li>• A 2 channel source is being played.</li> </ul>

<b>Symptom</b>	<b>Remedy</b>
No sound or only a very low-level sound is heard from the surround speakers.	<ul style="list-style-type: none"> <li>• Check the speaker connections and settings (pages 24, 67).</li> <li>• Make sure the “DEC. MODE” setting (page 40).</li> <li>• Depending on the source, the effect of the surround speakers may be less noticeable.</li> <li>• A 2 channel source is being played.</li> </ul>
There is no sound from the DIGITAL IN COAXIAL/OPTICAL jack.	<ul style="list-style-type: none"> <li>• The sampling frequency of the input signal is more than 48 kHz.</li> </ul>

## **Operation**

<b>Symptom</b>	<b>Remedy</b>
Radio stations cannot be tuned in.	<ul style="list-style-type: none"> <li>• Check that the antenna (aerial) is connected securely. Adjust the antenna (aerial) or connect an external antenna (aerial) if necessary.</li> <li>• The signal strength of the stations is too weak (when tuning in with automatic tuning). Use direct tuning.</li> <li>• No stations have been preset or the preset stations have been cleared (when tuning by scanning preset stations). Preset the stations (page 70).</li> <li>• Press DISPLAY so that the frequency appears in the front panel display.</li> </ul>
Noise is heard on AM radio.	<ul style="list-style-type: none"> <li>• Check the location of the AM loop antenna (aerial) and cord (page 32).</li> </ul>
The remote does not function.	<ul style="list-style-type: none"> <li>• There are obstacles between the remote and the unit.</li> <li>• The distance between the remote and the unit is too far.</li> <li>• The remote is not pointed at the remote sensor on the unit.</li> <li>• The batteries in the remote are weak.</li> </ul>
The disc does not play.	<ul style="list-style-type: none"> <li>• There is no disc inserted.</li> <li>• The disc is upside down. Insert the disc with the playback side facing down.</li> <li>• The disc is skewed on the disc tray.</li> <li>• The system cannot play CD-ROMs, etc. (page 6).</li> <li>• The region code on the DVD does not match the system.</li> <li>• Moisture has condensed inside the unit and may cause damage to the lenses. Remove the disc and leave the unit turned on for about half an hour.</li> </ul>
The MP3 file cannot be played.	<ul style="list-style-type: none"> <li>• The DATA CD is not recorded in the MP3 format that conforms to ISO 9660 Level 1/Level 2, or Joliet.</li> <li>• The DATA DVD is not recorded in an MP3 format that conforms to UDF (Universal Disk Format).</li> <li>• The MP3 file does not have the extension “.MP3.”</li> <li>• The data is not formatted in MP3 even though it has the extension “.MP3.”</li> <li>• The data is not MPEG1 Audio Layer 3 data.</li> <li>• The system cannot play audio tracks in MP3PRO format.</li> <li>• The [MODE (MUSIC, IMAGE)] setting has been set to [IMAGE] (page 55).</li> <li>• If you cannot change the [MODE (MUSIC, IMAGE)] setting, re-load the disc or turn the system off, then on.</li> <li>• The DATA CD/DATA DVD contains a DivX video file (except for United Kingdom and North American models).</li> </ul>



Symptom	Remedy
The JPEG image file cannot be played.	<ul style="list-style-type: none"> <li>• The DATA CD is not recorded in a JPEG format that conforms to ISO 9660 Level 1/Level 2, or Joliet.</li> <li>• The DATA DVD is not recorded in a JPEG format that conforms to UDF (Universal Disk Format).</li> <li>• It has an extension other than “.JPEG” or “.JPG.”</li> <li>• It is larger than 3,072 (width) × 2,048 (height) in normal mode, or more than 2,000,000 pixels in Progressive JPEG image file which is mainly used on the Internet WEB site.</li> <li>• It does not fit the TV screen (those images are reduced).</li> <li>• The [MODE (MUSIC, IMAGE)] setting has been set to [MUSIC] (page 55).</li> <li>• If you cannot change the [MODE (MUSIC, IMAGE)] setting, re-load the disc or turn the system off, then on.</li> <li>• The DATA CD/DATA DVD contains a DivX video file (except for United Kingdom and North American models).</li> </ul>
The MP3 files and JPEG image files starts playing simultaneously.	<ul style="list-style-type: none"> <li>• [AUTO] has been selected in [MODE (MUSIC, IMAGE)] (page 55).</li> </ul>
The DivX video file cannot be played (except for United Kingdom and North American models).	<ul style="list-style-type: none"> <li>• The file is not created in DivX format.</li> <li>• The file has an extension other than “.AVI” or “.DIVX.”</li> <li>• The DATA CD/DATA DVD is not created in a DivX format that conforms to ISO 9660 Level 1/Level 2 or, Joliet/UDF.</li> <li>• The DivX video file is larger than 720 (width) × 576 (height).</li> </ul>
The titles of folder/file/file name are not displayed correctly.	<ul style="list-style-type: none"> <li>• The system can only display numbers and letters of the alphabets. Other characters are displayed as [*].</li> </ul>
A disc does not start playing from the beginning.	<ul style="list-style-type: none"> <li>• Program Play, Shuffle Play, or Repeat Play has been selected. Press CLEAR to cancel these functions before playing a disc.</li> <li>• Resume Play has been selected. During stop, press ■ on the unit or the remote and then start playback (page 48).</li> <li>• The title, DVD or PBC menu automatically appears on the TV screen.</li> </ul>
The system starts playing the disc automatically.	<ul style="list-style-type: none"> <li>• The DVD features an auto playback function.</li> </ul>
Playback stops automatically.	<ul style="list-style-type: none"> <li>• Some discs may contain an auto pause signal. While playing such a disc, the system stops playback at the auto pause signal.</li> </ul>
You cannot perform some functions such as stop, search, Slow-motion Play, or Repeat Play.	<ul style="list-style-type: none"> <li>• Depending on the disc, you may not be able to perform some of the operations above. Refer to the operating instructions supplied with the disc.</li> </ul>
Messages do not appear on the TV screen in the language you want.	<ul style="list-style-type: none"> <li>• In the Setup Display, select the desired language for the on-screen display in [OSD] under [LANGUAGE SETUP] (page 62).</li> </ul>
The language for the sound track cannot be changed.	<ul style="list-style-type: none"> <li>• Multilingual tracks are not recorded on the DVD being played.</li> <li>• The DVD prohibits changing the language for the sound track.</li> </ul>
The subtitle language cannot be changed.	<ul style="list-style-type: none"> <li>• Multilingual subtitles are not recorded on the DVD being played.</li> <li>• The DVD prohibits changing the subtitles.</li> </ul>
The subtitle cannot be turned off.	<ul style="list-style-type: none"> <li>• The DVD prohibits turning off subtitles.</li> </ul>
The angles cannot be changed.	<ul style="list-style-type: none"> <li>• Multi-angles are not recorded on the DVD being played (page 45).</li> <li>• The DVD prohibits changing the angles.</li> </ul>

Symptom	Remedy
A disc cannot be ejected and "LOCKED" appears in the front panel display.	<ul style="list-style-type: none"> <li>• Contact your Sony dealer or local authorized Sony service facility.</li> </ul>
[Data error] appears on the TV screen when playing a DATA CD or DATA DVD.	<ul style="list-style-type: none"> <li>• The MP3 file/JPEG image file/DivX video file you want to play is broken (except for United Kingdom and North American models).</li> <li>• The data is not MPEG1 Audio Layer 3 data.</li> <li>• The JPEG image file format does not conform to DCF.</li> <li>• The JPEG image file has the extension ".JPG" or ".JPEG," but is not in JPEG format.</li> <li>• The file you want to play has the extension ".AVI" or ".DIVX" but is not in DivX format, or is in DivX format but does not conform to a DivX Certified profiles (except for United Kingdom and North American models).</li> </ul>
The system does not work normally.	<ul style="list-style-type: none"> <li>• Disconnect the AC power cord (mains lead) from the wall outlet (mains), then reconnect after several minutes.</li> </ul>
The Control for HDMI function does not work.	<ul style="list-style-type: none"> <li>• When "HDMI" does not light up in the front panel display, check the HDMI connection (page 26).</li> <li>• Set the [CONTROL FOR HDMI] setting in [HDMI SETUP] to [ON] (page 64).</li> <li>• Make sure that the connected component is compatible with the [CONTROL FOR HDMI] function.</li> <li>• Check that the AC power cord (mains lead) of the connected component is connected securely.</li> <li>• Check the connected component's setting for the Control for HDMI function. Refer to the operating instructions supplied with the component.</li> <li>• If you change the HDMI connection, connect and disconnect the AC power cord (mains lead), or have a power failure, set the [CONTROL FOR HDMI] setting in [HDMI SETUP] to [OFF], then set the [CONTROL FOR HDMI] setting in [HDMI SETUP] to [ON] (page 64).</li> <li>• For details, see "Using the Control for HDMI Function for "BRAVIA" Sync" (page 73).</li> </ul>
No sound is output from the system and TV while using the System Audio Control function.	<ul style="list-style-type: none"> <li>• Set the [AUDIO (HDMI)] setting in [CUSTOM SETUP] to [ON] (page 65).</li> <li>• Make sure that the connected TV is compatible with the System Audio Control function.</li> <li>• For details, see "Using the Control for HDMI Function for "BRAVIA" Sync" (page 73).</li> </ul>

## The S-AIR function

### (DAV-HDX275/DAV-HDX475 only)

Symptom	Remedy
S-AIR connection is not established (sound transmission is not established), e.g., the indicator of the S-AIR sub unit does the following: <ul style="list-style-type: none"> <li>• Turns off.</li> <li>• Flashes.</li> <li>• Turns red.</li> </ul>	<ul style="list-style-type: none"> <li>• If you use another S-AIR main unit, place it more than 8 m (26 1/4 feet) away from the unit.</li> <li>• Confirm the ID of the unit and S-AIR sub unit (page 78).</li> <li>• You performed pairing the unit and another S-AIR sub unit. Perform pairing of the desired S-AIR sub unit (page 80).</li> <li>• The unit is paired to another S-AIR sub unit. Cancel pairing.</li> <li>• Install the S-AIR main unit and S-AIR sub unit away from other wireless products.</li> <li>• Stop using another wireless product.</li> <li>• The S-AIR sub unit is turned off. Make sure the AC power cord (mains lead) is connected and turn on the S-AIR sub unit.</li> </ul>

Symptom	Remedy
No sound is heard from the S-AIR product.	<ul style="list-style-type: none"><li>• If you use another S-AIR main unit, place it more than 8 m (26 1/4 feet) away from the unit.</li><li>• Confirm the ID of the unit and S-AIR sub unit (page 78).</li><li>• Confirm the pairing setting (page 80).</li><li>• Install the S-AIR main unit and S-AIR sub unit closer together.</li><li>• Avoid use of equipment that generates electromagnetic energy, such as a microwave oven.</li><li>• Install the S-AIR main unit and S-AIR sub unit away from other wireless products.</li><li>• Stop using another wireless product.</li><li>• Change the “RF CHANGE” setting (page 82).</li><li>• Change the ID settings of the S-AIR main unit and S-AIR sub unit.</li><li>• Turn off the system and S-AIR sub unit, then turn on them.</li></ul>
There is noise or the sound skips.	<ul style="list-style-type: none"><li>• If you use another S-AIR main unit, place it more than 8 m (26 1/4 feet) away from the unit.</li><li>• Install the S-AIR main unit and S-AIR sub unit closer together.</li><li>• Avoid use of equipment that generates electromagnetic energy, such as a microwave oven.</li><li>• Install the S-AIR main unit and S-AIR sub unit away from other wireless products.</li><li>• Stop using another wireless product.</li><li>• Change the “RF CHANGE” setting (page 82).</li><li>• Change the ID settings of the S-AIR main unit and S-AIR sub unit.</li></ul>

# Self-diagnosis Function

*(When letters/numbers appear in the display)*

When the self-diagnosis function is activated to prevent the system from malfunctioning, a 5-character service number (e.g., C 13 50) with a combination of a letter and 4 digits appears on the TV screen or front panel display. In this case, check the following table.



## When displaying the version number on the TV screen

When you turn on the system, the version number [VER.X.XX] (X is a number) may appear on the TV screen. Although this is not a malfunction and for Sony service use only, normal system operation will not be possible. Turn off the system, and then turn on the system again to operate.



First 3 characters of the service number	Cause and/or corrective action
C 13	The disc is dirty. ➔Clean the disc with a soft cloth (page 92).
C 31	The disc is not inserted correctly. ➔Restart the system, then re-insert the disc correctly.
E XX (XX is a number)	To prevent a malfunction, the system has performed the self-diagnosis function. ➔Contact your nearest Sony dealer or local authorized Sony service facility and give the 5-character service number. Example: E 61 10

# Specifications

## AUDIO POWER SPECIFICATIONS

### for the US model

#### POWER OUTPUT AND TOTAL HARMONIC DISTORTION:

With 3 ohms loads, both channels driven, from 180 - 20,000 Hz; rated 84 watts per channel minimum RMS power, with no more than 0.7% total harmonic distortion from 250 milli watts to rated output.

### Amplifier Section

#### US models:

Surround mode (reference) RMS output power  
FL/FR/C/SL/SR\*: 143 watts (per channel at 3 ohms, 1 kHz, 10% THD)  
Subwoofer\*: 285 watts (at 1.5 ohms, 80 Hz, 10% THD)

#### Other models:

Stereo mode (rated) 108 W + 108 W (at 3 ohms, 1 kHz, 1% THD)

Surround mode (reference) RMS output power  
FL/FR/C/SL/SR\*: 143 watts (per channel at 3 ohms, 1 kHz, 10% THD)  
Subwoofer\*: 285 watts (at 1.5 ohms, 80 Hz, 10% THD)

\* Depending on the decoding mode settings and the source, there may be no sound output.

#### Inputs (Analog)

TV/VIDEO (AUDIO IN) Sensitivity: 450/250 mV  
AUDIO IN Sensitivity: 250/125 mV

#### Inputs (Digital)

TV/VIDEO (COAXIAL IN/OPTICAL IN)  
Impedance: 75 ohms/-

#### Outputs (Analog)

Phones Accepts low- and high-impedance headphones.

### Super Audio CD/DVD System

Laser Semiconductor laser  
(Super Audio CD/DVD:  $\lambda = 650$  nm)  
(CD:  $\lambda = 790$  nm)  
Emission duration: continuous

#### Signal format system

North American models: NTSC

Other models: NTSC/PAL

### Tuner Section

System PLL quartz-locked digital synthesizer

#### FM tuner section

Tuning range  
North American models: 87.5 MHz - 108.0 MHz (100 kHz step)

Other models: 87.5 MHz - 108.0 MHz (50 kHz step)

Antenna (aerial) FM wire antenna (aerial)

Antenna (aerial) terminals 75 ohms, unbalanced

Intermediate frequency 10.7 MHz

#### AM tuner section

##### Tuning range

North American, Mexican, and Latin American models:  
530 kHz - 1,710 kHz (with the interval set at 10 kHz)  
531 kHz - 1,710 kHz (with the interval set at 9 kHz)

European, Russian, and Middle Eastern models:  
531 kHz - 1,602 kHz (with the interval set at 9 kHz)

Australian and New Zealand models:  
531 kHz - 1,710 kHz (with the interval set at 9 kHz)  
530 kHz - 1,710 kHz (with the interval set at 10 kHz)

Other models:  
531 kHz - 1,602 kHz (with the interval set at 9 kHz)  
530 kHz - 1,610 kHz (with the interval set at 10 kHz)

Antenna (aerial) AM loop antenna (aerial)  
Intermediate frequency 450 kHz

### Video Section

Outputs VIDEO: 1 Vp-p 75 ohms  
COMPONENT:  
Y: 1 Vp-p 75 ohms  
Pb/Cb, Pr/Cr: 0.7 Vp-p 75 ohms  
HDMI OUT: Type A (19 pin)

### Speakers

#### Front (DAV-HDX275/DAV-HDX276) (SS-TS81)

Speaker system Full range Bass reflex, Magnetically Shielded  
Speaker unit 65 mm (2 5/8 in) cone type  
Rated impedance 3 ohms  
Dimensions (approx.) 103 mm  $\times$  225 mm  $\times$  82 mm (4 1/8 in  $\times$  8 7/8 in  $\times$  3 1/4 in) (w/h/d)  
Mass (approx.) 0.7 kg (1 lb 9 oz)

## Front (DAV-HDX475) (SS-TS82)

Speaker system	Full range Bass reflex, Magnetically Shielded
Speaker unit	65 mm (2 5/8 in) cone type
Rated impedance	3 ohms
Dimensions (approx.)	108 mm × 540 mm × 78 mm (4 3/8 in × 21 3/8 in × 3 1/8 in) (w/h/d) 290 mm × 1,045 mm - 1,230 mm × 290 mm (11 1/2 in × 41 1/4 in - 48 1/2 in × 11 1/2 in) (w/h/d) with stand
Mass (approx.)	1.2 kg (2 lb 11 oz) 2.9 kg (6 lb 7 oz) with stand

## Center (SS-CT80)

Speaker system	Full range Bass reflex, Magnetically Shielded
Speaker unit	65 mm (2 5/8 in) cone type
Rated impedance	3 ohms
Dimensions (approx.)	265 mm × 93 mm × 71 mm (10 1/2 in × 3 3/4 in × 2 7/8 in) (w/h/d)
Mass (approx.)	0.7 kg (1 lb 9 oz)

## Surround (SS-TS80)

Speaker system	Full range Bass reflex, Magnetically Shielded
Speaker unit	65 mm (2 5/8 in) cone type
Rated impedance	3 ohms
Dimensions (approx.)	103 mm × 164 mm × 82 mm (4 1/8 in × 6 1/2 in × 3 1/4 in) (w/h/d)
Mass (approx.)	0.6 kg (1 lb 6 oz)

## Subwoofer (SS-WS82)

Speaker system	Subwoofer Bass reflex
Speaker unit	160 mm (6 3/8 in) cone type
Rated impedance	1.5 ohms
Dimensions (approx.)	225 mm × 395 mm × 325 mm (8 7/8 in × 15 5/8 in × 12 7/8 in) (w/h/d)
Mass (approx.)	6.1 kg (14 lb 6 oz)

## General

Power requirements	
North American models:	120 V AC, 60 Hz
Other models:	220 V - 240 V AC, 50/60 Hz
Power consumption	
DAV-HDX275	On: 165 W Standby: 0.3 W (at the Power Saving mode)
DAV-HDX276	On: 160 W

	Standby: 0.3 W (at the Power Saving mode)
DAV-HDX475	On: 165 W Standby: 0.3 W (at the Power Saving mode)
Output voltage (DIGITAL MEDIA PORT)	DC 5 V
Output current (DIGITAL MEDIA PORT)	700 mA
Dimensions (approx.)	430 mm × 85 mm × 415 mm (17 in × 3 3/8 in × 16 3/8 in) (w/h/d) incl. projecting parts
Mass (approx.)	5.2 kg (11 lb 8 oz)

Design and specifications are subject to change without notice.



- Standby power consumption 0.3 W.
- Halogenated flame retardants are not used in the printed wiring boards.
- Over 85% power efficiency of amplifier block is achieved with the full digital amplifier, S-master.

# Glossary

## **Digital Cinema Auto Calibration**

Digital Cinema Auto Calibration was developed by Sony to automatically measure and adjust the speaker settings to your listening environment in a short period of time.

## **Digital Direct Twin Drive Subwoofer**

Utilizing Sony proprietary S-master technology, the Digital Direct Twin Drive Subwoofer features two S-master Digital Amplifiers that provide dedicated power to a strategically located subwoofer for astounding sound performance. Easy to set up, Digital Direct Twin Drive Subwoofer provides a stable sound field over a much larger listening area without having to adjust frequency levels.

## **Dolby Digital**

This movie theater sound format is more advanced than Dolby Surround Pro Logic. In this format, the surround speakers output stereo sound with an expanded frequency range, and a subwoofer channel for deep bass is independently provided. This format is also called "5.1" with the subwoofer channel designed as the 0.1 channel (since it functions only when a deep bass effect is needed). All six channels in this format are recorded separately for superior channel separation. Furthermore, since all the signals are processed digitally, less signal degradation occurs.

## **Dolby Pro Logic II**

Dolby Pro Logic II creates five full-bandwidth output channels from 2 channel sources. This is done using an advanced, high-purity matrix surround decoder that extracts the spatial properties of the original recording without adding any new sounds or tonal colorations.

## **■ Music mode**

The Movie mode is for use with stereo television shows and all programs encoded in Dolby Surround. The result is enhanced sound field directionality that approaches the quality of discrete 5.1-channel sound.

## **■ Music mode**

The Music mode is for use with any stereo music recordings, and provides a wide and deep sound space.

## **Dolby Surround Pro Logic**

As one method of decoding Dolby Surround, Dolby Surround Pro Logic produces four channels from 2 channel sound. Compared with the former Dolby Surround system, Dolby Surround Pro Logic reproduces left-to-right panning more naturally and localizes sounds more precisely. To take full advantage of Dolby Surround Pro Logic, you should have one pair of surround speakers and a center speaker. The surround speakers output monaural sound.

## **DTS**

Digital audio compression technology developed by DTS, Inc. This technology conforms to 5.1-channel surround. This format comprises of stereo rear channel and there is discrete subwoofer channel in this format. DTS provides the same 5.1 discrete channels of high quality digital audio. The good channel separation is realized due to the all channel data being recorded discretely and processed in digitally.

## **HDMI (High-Definition Multimedia Interface)**

HDMI is an interface that supports both video and audio on a single digital connection, allowing you to enjoy high quality digital picture and sound. The HDMI specification supports HDCP (High-bandwidth Digital Content Protection), a copy protection technology that incorporates coding technology for digital video signals.

## **Interlace format (Interlaced scanning)**

The Interlace format is the NTSC standard method for displaying TV images at 30 frames per second. Each frame is scanned twice - alternately between the even numbered scanning lines and then odd numbered scanning lines, at 60 times per second.

## **Parental Control**

A function of the DVD to limit playback of the disc by the age of the users according to the limitation level in each country. The limitation

varies from disc to disc; when it is activated, playback is completely prohibited, violent scenes are skipped or replaced with other scenes and so on.

**Progressive format (sequential scanning)**

In contrast to the Interlace format, the progressive format can reproduce 50 - 60 frames per second by reproducing all scanning lines (525 lines for the NTSC system). The overall picture quality increases and still images, text and horizontal lines appear sharper. This format is compatible with the 525 or 625 progressive format.

**S-AIR (Sony Audio Interactive Radio frequency)**

Recent times have seen the rapid spread of DVD media, Digital Broadcasting, and other high-quality media.

To ensure that the subtle nuances of these high-quality media are transmitted with no deterioration, Sony has developed a technology called "S-AIR" for the radio transmission of digital audio signals with no compression, and has incorporated this technology into the EZW-RT10/EZW-T100.

This technology transfers digital audio signals with no compression using the 2.4 GHz band range of ISM band (Industrial, Scientific, and Medical band), such as wireless LANs and Bluetooth applications.

**Super Audio CD**

Super Audio CD is a new high-quality audio disc standard where music is recorded in the DSD (Direct Stream Digital) format (conventional CD is recorded in the PCM format). The DSD format, using a sampling frequency 64 times higher than that of a conventional CD, and with 1-bit quantization, achieves both a wide frequency range and a wide dynamic range across the audible frequency range, and so provides music reproduction extremely faithful to the original sound.

**Super Audio CD types**

There are two types of discs, depending on the Super Audio CD layer and CD layer combination.

- Super Audio CD layer: A high-density signal layer for Super Audio CD
- CD layer<sup>1)</sup>: A layer that is readable by a conventional CD player

Single layer disc (a disc with a single Super Audio CD layer)

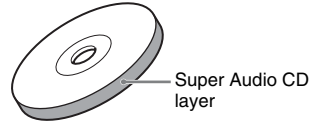

Hybrid disc<sup>2)</sup> (a disc with a Super Audio CD layer and a CD layer)

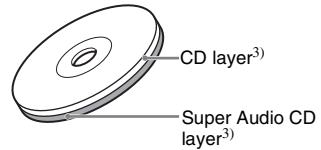

A Super Audio CD layer consists of the 2 channel area or the multi-channel area.

- 2 channel area: An area in which 2 channel stereo tracks are recorded
- Multi-channel area: An area in which multi-channel (up to 5.1 channels) tracks are recorded

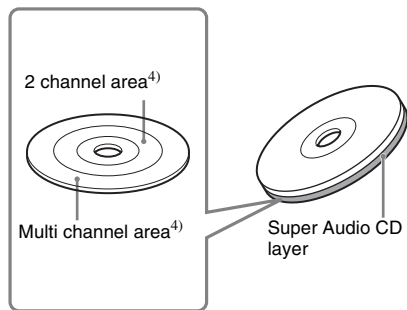

<sup>1)</sup>You can play the CD layer on a conventional CD player.

<sup>2)</sup>Since both layers are on one side, it is not necessary to turn the disc over.

<sup>3)</sup>To select a layer, see "To change a playback layer when playing a hybrid Super Audio CD" (page 47).

<sup>4)</sup>To select an area, see "To select a playback area on a 2 channel + Multi-channel Super Audio CD" (page 47).



# Language Code List

The language spellings conform to the ISO 639: 1988 (E/F) standard.

Code Language	Code Language	Code Language	Code Language
1027 Afar	1183 Irish	1347 Maori	1507 Samoan
1028 Abkhazian	1186 Scots Gaelic	1349 Macedonian	1508 Shona
1032 Afrikaans	1194 Galician	1350 Malayalam	1509 Somali
1039 Amharic	1196 Guarani	1352 Mongolian	1511 Albanian
1044 Arabic	1203 Gujarati	1353 Moldavian	1512 Serbian
1045 Assamese	1209 Hausa	1356 Marathi	1513 Siswati
1051 Aymara	1217 Hindi	1357 Malay	1514 Sesotho
1052 Azerbaijani	1226 Croatian	1358 Maltese	1515 Sundanese
1053 Bashkir	1229 Hungarian	1363 Burmese	1516 Swedish
1057 Byelorussian	1233 Armenian	1365 Nauru	1517 Swahili
1059 Bulgarian	1235 Interlingua	1369 Nepali	1521 Tamil
1060 Bihari	1239 Interlingue	1376 Dutch	1525 Telugu
1061 Bislama	1245 Inupiak	1379 Norwegian	1527 Tajik
1066 Bengali; Bangla	1248 Indonesian	1393 Occitan	1528 Thai
1067 Tibetan	1253 Icelandic	1403 (Afan)Oromo	1529 Tigrinya
1070 Breton	1254 Italian	1408 Oriya	1531 Turkmen
1079 Catalan	1257 Hebrew	1417 Punjabi	1532 Tagalog
1093 Corsican	1261 Japanese	1428 Polish	1534 Setswana
1097 Czech	1269 Yiddish	1435 Pashto;	1535 Tonga
1103 Welsh	1283 Javanese	Pushto	1538 Turkish
1105 Danish	1287 Georgian	1436 Portuguese	1539 Tsonga
1109 German	1297 Kazakh	1463 Quechua	1540 Tatar
1130 Bhutani	1298 Greenlandic	1481 Rhaeto-	1543 Twi
1142 Greek	1299 Cambodian	Romance	1557 Ukrainian
1144 English	1300 Kannada	1482 Kirundi	1564 Urdu
1145 Esperanto	1301 Korean	1483 Romanian	1572 Uzbek
1149 Spanish	1305 Kashmiri	1489 Russian	1581 Vietnamese
1150 Estonian	1307 Kurdish	1491 Kinyarwanda	1587 Volapük
1151 Basque	1311 Kirghiz	1495 Sanskrit	1613 Wolof
1157 Persian	1313 Latin	1498 Sindhi	1632 Xhosa
1165 Finnish	1326 Lingala	1501 Sangho	1665 Yoruba
1166 Fiji	1327 Laothian	1502 Serbo-	1684 Chinese
1171 Faroese	1332 Lithuanian	Croatian	1697 Zulu
1174 French	1334 Latvian;	1503 Singhalese	
1181 Frisian	Lettish	1505 Slovak	
	1345 Malagasy	1506 Slovenian	1703 Not specified

Additional Information

## Parental Control Area Code List

Code Area	Code Area	Code Area	Code Area
2044 Argentina	2165 Finland	2362 Mexico	2149 Spain
2047 Australia	2174 France	2376 Netherlands	2499 Sweden
2046 Austria	2109 Germany	2390 New Zealand	2086 Switzerland
2057 Belgium	2248 India	2379 Norway	2528 Thailand
2070 Brazil	2238 Indonesia	2427 Pakistan	2184 United Kingdom
2079 Canada	2254 Italy	2424 Philippines	
2090 Chile	2276 Japan	2436 Portugal	
2092 China	2304 Korea	2489 Russia	
2115 Denmark	2363 Malaysia	2501 Singapore	

# Index to Parts and Control

For more information, refer to the pages indicated in parentheses.

## Front panel

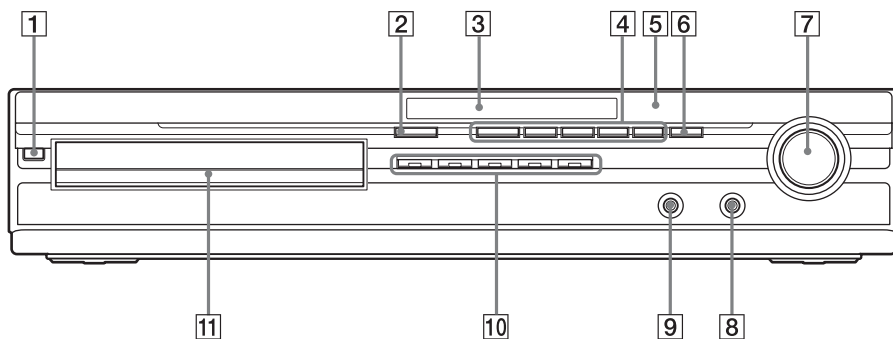

- |                                      |   |
|--------------------------------------|---|
| <b>1</b> I/O (on/standby) (35, 90)   | <b>7</b> VOLUME control (43)                  |
| <b>2</b> ≡ (open/close) (43)         | <b>8</b> PHONES jack (43)                     |
| <b>3</b> Front panel display (108)   | <b>9</b> AUDIO IN/A.CAL MIC jack (29, 35, 84) |
| <b>4</b> Play operation buttons (43) | <b>10</b> DISC 1-5 buttons/indicators (43)    |
| <b>5</b> □ (remote sensor) (12)      | <b>11</b> Disc tray (43)                      |
| <b>6</b> FUNCTION (38)               |   |

## Rear panel

### DAV-HDX276

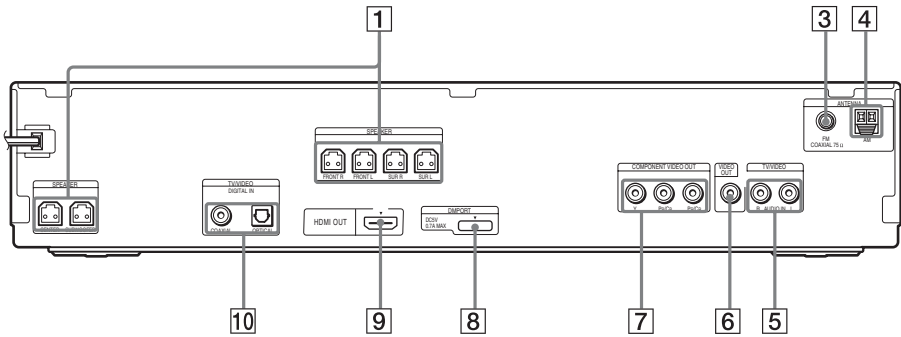

### DAV-HDX275/DAV-HDX475

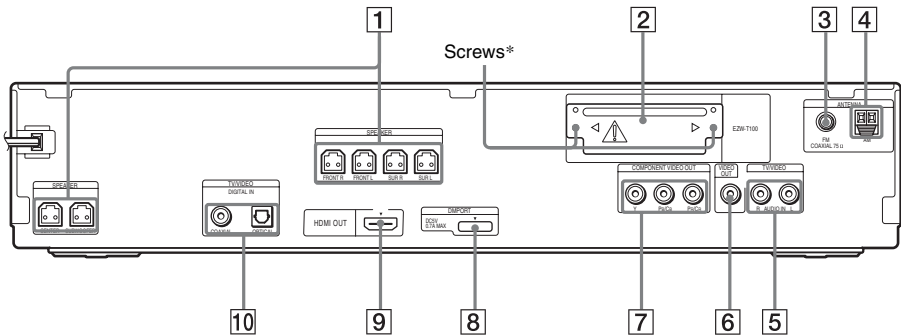

- |  |  |
|--|--|
| <b>1</b> SPEAKER jacks (24)                              | <b>7</b> COMPONENT VIDEO OUT jacks (26)                    |
| <b>2</b> EZW-T100 slot (DAV-HDX275/DAV-HDX475 only) (30) | <b>8</b> DMPORT (DIGITAL MEDIA PORT) jack (29, 76)         |
| <b>3</b> FM COAXIAL 75Ω jack (32)                        | <b>9</b> HDMI OUT jack (26)                                |
| <b>4</b> AM terminal (32)                                | <b>10</b> TV/VIDEO (DIGITAL IN COAXIAL/OPTICAL) jacks (26) |
| <b>5</b> TV/VIDEO (AUDIO IN R/L) jacks (26, 29)          |  |
| <b>6</b> VIDEO OUT jack (26)                             |  |

**\* ⚠ CAUTION**

Please do not remove the screws before installing the EZW-T100.

## Front panel display

### About the indications in the front panel display

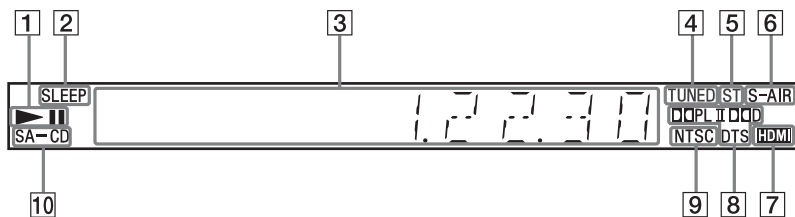

- 1 Playing status
- 2 Flashes when the sleep timer is set. (86)
- 3 Displays system's status such as chapter, title, or track number, time information, radio frequency, playing status, decoding mode, etc.
- 4 Lights up when a station is received. (Radio only) (70)
- 5 Stereo/Monaural effect (Radio only) (71)
- 6 Lights up when the S-AIR transmitter (not supplied) is inserted in the unit and the system transmits the sound. (DAV-HDX275/DAV-HDX475 only) (77)
- 7 Lights up when the HDMI OUT jack is correctly connected to HDCP (High-bandwidth Digital Content Protection) compliant device with HDMI or DVI (Digital Visual Interface) input. (26)
- 8 Current surround format (Except for JPEG image file)
- 9 Lights up when the color system is set to NTSC. (Asian, Australian, and Middle Eastern models only)
- 10 Lights up when Super Audio CD/CD is loaded. (47)

# Remote control

ALPHABETICAL ORDER		BUTTON DESCRIPTIONS
<b>A - O</b>	<b>P - Z</b>	
ANGLE <b>3</b> (45)	PICTURE NAVI <b>15</b> (54)	Number buttons <b>14</b> (47, 70, 85)
AUDIO <b>16</b> (45)	PRESET +/- <b>27</b> (71)	⏻ (on/standby) <b>1</b> (34, 35, 43)
CLEAR <b>32</b> (49, 61, 71)	PROG +/- <sup>2)</sup> <b>27</b> (85)	TV ⏻ (on/standby) <b>19</b> (85)
D.TUNING <b>22</b> (71)	S-AIR MODE <sup>3)</sup> <b>4</b>	⏪/⏩/⏴/⏵ ⊕ <b>12</b> (34, 35, 47, 49, 70, 83)
DISC SKIP <b>33</b> (43)	SLEEP <b>17</b> (86)	⏮•/•/⏭ REPLAY/ADVANCE <b>9</b> (43)
DISPLAY <b>21</b> (72, 87)	SOUND MODE <b>5</b> (42)	⏮⏪⏩⏭ <b>27</b> (43)
DVD MENU <b>25</b> (52)	SUBTITLE <b>22</b> (45)	⏮⏪ <b>10</b> (43)
DVD TOP MENU <b>13</b> (52)	SYSTEM MENU <b>24</b> (34, 39, 86, 87)	STEP ⏮⏪⏩⏭ <b>9</b> (43)
DYNAMIC BASS <b>6</b> (86)	THEATER/THEATRE <sup>4)</sup> <b>18</b> (73)	SLOW ⏮⏪⏩⏭ <b>10</b> (43)
ENTER <sup>1)</sup> <b>24</b> (34, 35, 47, 49, 70, 83)	TOOLS <b>26</b> (85)	▷ (play) <b>30</b> (43)
FUNCTION +/- <b>2</b> (38, 43)	TUNING +/- <b>10</b> (70)	■ (stop) <b>28</b> (43)
MENU <b>25</b> (85)	TV <b>29</b> (85)	⏸ (pause) <b>11</b> (43)
MUTING <b>7</b> (43)	TV CH +/- <sup>5)</sup> <b>27</b> (85)	⏻ DISPLAY <sup>6)</sup> <b>26</b> (35, 47, 49, 83)
NIGHT <b>23</b> (86)	TV INPUT <b>20</b> (85)	↶ RETURN <b>31</b> (47, 85)
ONE-TOUCH PLAY <b>35</b> (74)	TV VOL +/- <b>34</b> (85)	-/- <sup>2)</sup> <b>32</b> (85)
	VOLUME +/- <b>8</b> (43)	○ <sup>5)</sup> <b>32</b> (85)

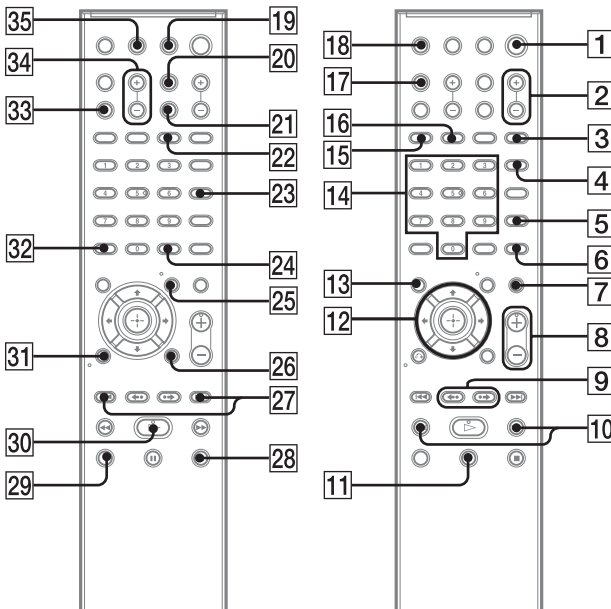

<sup>1)</sup>The ENTER button has the same function as the ⊕ button. When you operate the TV, the ENTER button is used for selecting a channel, and the ⊕ button is used for selecting menu items (page 85).

<sup>2)</sup>Except for North American models.

<sup>3)</sup>DAV-HDX275/DAV-HDX475 only.

<sup>4)</sup>The button name differs depending on the area.

<sup>5)</sup>North American models only.

<sup>6)</sup>This button is available for the "DVD" or "DMPORT" function. Depending on the DIGITAL MEDIA PORT adapter, this button may not work.

# Guide to the Control Menu Display

You can use the Control Menu display to select a function and to view related information.

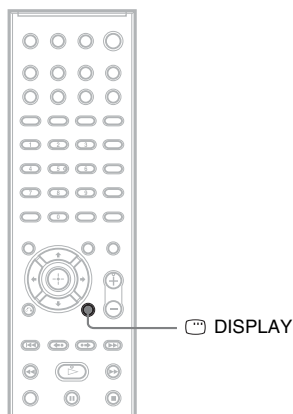

Press  **DISPLAY** repeatedly.

Each time you press  **DISPLAY**, the Control Menu display changes:

① → ② → ... → ① → ...

- ① Control Menu display 1
- ② Control Menu display 2 (appears when available)
- ③ Control Menu display off

#### Note

- The Control Menu Display appears during the “DVD” or “DMPORT” function. Depending on the DIGITAL MEDIA PORT adapter, the Control Menu Display may not appear.

## Control Menu display

The Control Menu display 1 and 2 will show different items depending on the disc type. For details, see the pages in parentheses.

Example: Control Menu display 1 when playing a DVD VIDEO.

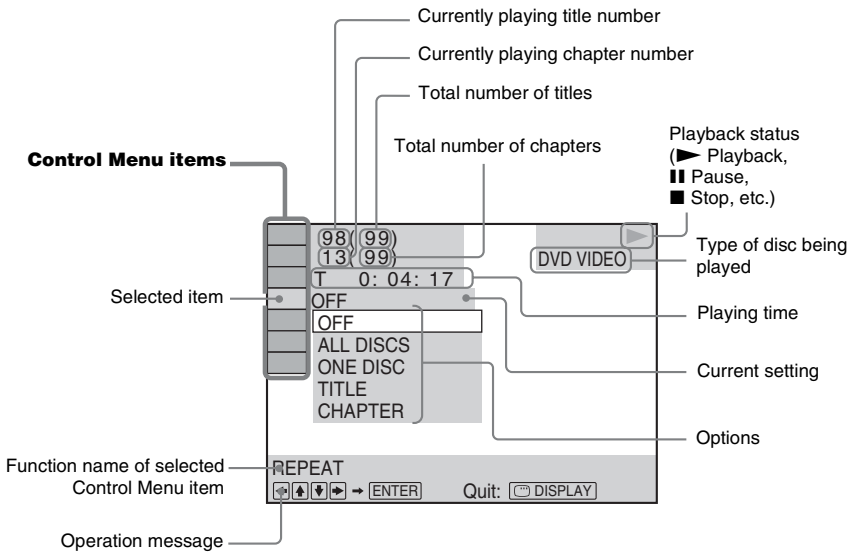























































## To turn off the display

Press [DISPLAY].

## List of Control Menu items



Item	Item Name, Function, Relevant Disc Type
	[TITLE] (page 52)/[SCENE] (page 52)/[TRACK] (page 52) You can select the title, scene, or track to be played. <span style="float: right;">DVD-V DVD-VR VIDEO CD</span>
	[CHAPTER] (page 52)/[INDEX] (page 52) You can select the chapter or index to be played. <span style="float: right;">DVD-V DVD-VR VIDEO CD</span>
	[INDEX] (page 52) You can display the index and select the index to be played. <span style="float: right;">Super Audio CD</span>
	[TRACK] (page 52) You can select the track to be played. <span style="float: right;">CD DATA-CD DATA DVD Super Audio CD</span>
	[ORIGINAL/PLAY LIST] (page 52) You can select the type of titles (DVD-RW/DVD-R) to be played, the [ORIGINAL] one, or an edited [PLAY LIST]. <span style="float: right;">DVD-VR</span>
	[TIME] (page 53) You can check the elapsed time and the remaining playback time. Input the time code for picture and music searching. The system displays the DVD/Super Audio CD/CD text or the MP3 file name. <span style="float: right;">DVD-V DVD-VR VIDEO CD CD DATA-CD DATA DVD Super Audio CD</span>
	[MULTI/2CH] (page 47) You can select the playback area on a Super Audio CD when available. <span style="float: right;">Super Audio CD</span>
	[SUPER AUDIO CD/CD LAYER] (page 47) You can select the playback layer on a Super Audio CD when available. <span style="float: right;">Super Audio CD</span>

	<b>[PROGRAM] (page 49)</b> You can select the track to play in the order you want.  
	<b>[SHUFFLE] (page 50)</b> You can play the track/file in random order.     
	<b>[REPEAT] (page 51)</b> You can play the entire disc (all titles/all tracks/all folders/all files) repeatedly or one title/chapter/track/folder/file repeatedly.       
	<b>[A/V SYNC] (page 59)</b> You can adjust the delay between the picture and sound.      <sup>1)</sup>
	<b>[DISC MENU] (page 52)</b> You can display the DVD's menu. 
	<b>[BROWSING] (page 55)</b> You can display the list of folders/JPEG image files.  
	<b>[SETUP] (page 61)</b> [QUICK] (page 35) You can make the basic adjustments. Use Quick Setup to select the desired language of the on-screen display, the aspect ratio of the TV, and select yes or no to start the Auto Calibration. [CUSTOM] In addition to the Quick Setup setting, you can adjust various other settings.       
	<b>[FOLDER] (page 52)</b> You can select the folder to be played.  
	<b>[FILE] (page 52)</b> You can select the JPEG image file or DivX video file <sup>1)</sup> to be played.  
 <sup>2)</sup>	<b>[DATE] (page 89)</b> You can display the date the picture was taken by a digital camera.  
 <sup>2)</sup>	<b>[INTERVAL] (page 56)</b> You can select the duration for which the slides are displayed on the TV screen.  
 <sup>2)</sup>	<b>[EFFECT] (page 56)</b> You can select the effects to be used for changing slides during a slide show.  
 <sup>2)</sup>	<b>[MODE (MUSIC, IMAGE)] (page 55)</b> You can select the data type; MP3 file, JPEG image file, or both to be played when playing a DATA CD/DATA DVD.  

<sup>1)</sup>Except for United Kingdom and North American models.

<sup>2)</sup>These items are not displayed when playing a DATA CD/DATA DVD with DivX video file (except for United Kingdom and North American models).

**Tip**

- The Control Menu icon indicator lights up in yellow  →  when you select any item except [OFF] ([PROGRAM], [SHUFFLE], [REPEAT], and [A/V SYNC] only). The [ORIGINAL/PLAY LIST] indicator lights up in yellow when you select [PLAY LIST] (default setting).



# Index

## Numerics

- 4:3 OUTPUT 63
- 5.1 Channel Surround 46

## A

- A/V SYNC 59
- ANGLE 45
- ATTENUATE 39
- AUDIO 62
- AUDIO (HDMI) 65
- AUDIO DRC 66
- AUDIO SETUP 65
- AUTO CALIBRATION 66, 84, 103

## B

- BACKGROUND 66
- BLACK LEVEL 64
- BLACK LEVEL (COMPONENT OUT) 64

## C

- COLD RESET 90
- COLOR SYSTEM (VIDEO CD) 63
- CONTROL FOR HDMI 64
- Control for HDMI 73
- Control Menu Display 110
- CUSTOM 61, 90

## D

- D. C. A. C. (Digital Cinema Auto Calibration) 84, 103
- DATA CD 57
- DATA DVD 57
- DEC. MODE 40
- DEMO 34
- Digital Direct Twin Drive Subwoofer 103
- DIGITAL MEDIA PORT 76
- DIMMER 87
- DISC SKIP 44
- DISPLAY 72
- DivX® 57, 67
- Dolby Digital 45, 103
- Dolby Pro Logic II 103
- Dolby Surround Pro Logic 103
- DTS 45, 103
- DUAL MONO 42
- DVD's menu 52
- DYNAMIC BASS 86

## E

- EFFECT 56

## F

- FM MODE 71
- Front panel 106
- Front panel display 87, 108

## H

- HDMI YCBCR/RGB (HDMI) 65
- HDMI (High-Definition Multimedia Interface) 103
- HDMI RESOLUTION 64
- HDMI SETUP 64

## I

- ILLUM MODE 45
- Instant Advance 44
- Instant Replay 44
- Interlace format 103
- INTERVAL 56

## J

- JPEG image file 54
- JPEG RESOLUTION 65

## L

- Language Code List 105
- LANGUAGE SETUP 62

## M

- MENU 62
- MODE (MUSIC, IMAGE) 56
- MP3 file 54
- Multi Session CD 8
- MULTI-DISC RESUME 67
- Multiplex broadcast sound 42

## N

- Naming preset stations 71
- NIGHT 86

## O

- ORIGINAL 52
- OSD 62

## P

- PARENTAL CONTROL 59, 67, 103
- PAUSE MODE 64

- PBC Playback 47
- PICTURE NAVI 55
- PLAY LIST 52
- Playable discs 6
- Program Play 49
- PROGRESSIVE (COMPONENT OUT) 63
- Progressive format 37, 104

## Q

- Quick Setup 35

## R

- Rear panel 107
- Region Code 8
- Remote 12
- Repeat Play 51
- RESET 67, 90
- Resume Play 48
- RF CHANGE 82

## S

- S-AIR 104
- S-AIR SETUP 66
- S-AIR STBY 80
- SCREEN SAVER 66
- SETUP 61, 90
- Shuffle Play 50
- SLEEP 86
- Slide Show 55
- Sound Mode 42
- SPEAKER FORMATION 66, 83
- SPEAKER SETUP 67
  - CONNECTION 67
  - DISTANCE 67, 68
  - LEVEL 68
- SUBTITLE 45, 62
- Super Audio CD 47, 104
- SYSTEM MENU 34, 39, 40, 45, 71, 80, 82, 86, 87
- SYSTEM SETUP 66

## T

- TEST TONE 68
- TIME 53
- TRACK SELECTION 66
- TV TYPE 63

## V

- VIDEO SETUP 62
- VOLUME LIMIT 65







\* 3 2 8 3 0 3 1 1 1 \* (1)

## Free Manuals Download Website

<http://myh66.com>

<http://usermanuals.us>

<http://www.somanuals.com>

<http://www.4manuals.cc>

<http://www.manual-lib.com>

<http://www.404manual.com>

<http://www.luxmanual.com>

<http://aubethermostatmanual.com>

Golf course search by state

<http://golfingnear.com>

Email search by domain

<http://emailbydomain.com>

Auto manuals search

<http://auto.somanuals.com>

TV manuals search

<http://tv.somanuals.com>