



# DAV-LF1H

## DVD Home Theatre System

### Operating Instructions

## WARNING

**To reduce the risk of fire or electric shock, do not expose this apparatus to rain or moisture.**

**Caution – The use of optical instruments with this product will increase eye hazard.**

Do not install the appliance in a confined space, such as a bookcase or built-in cabinet.

To prevent fire, do not cover the ventilation of the apparatus with news papers, table-cloths, curtains, etc. And don't place lighted candles on the apparatus.

To prevent fire or shock hazard, do not place objects filled with liquids, such as vases, on the apparatus.

## For the customers in the U.S.A

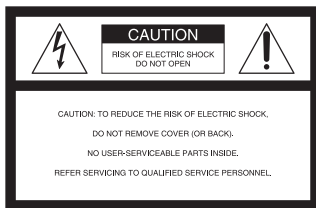

This symbol is intended to alert the user to the presence of uninsulated "dangerous voltage" within the product's enclosure that may be of sufficient magnitude to constitute a risk of electric shock to persons.



This symbol is intended to alert the user to the presence of important operating and maintenance (servicing) instructions in the literature accompanying the appliance.

### Owner's Record

The model and serial numbers are located at the rear exterior of the control unit. Record the serial number in the space provided below. Refer to them whenever you call upon your Sony dealer regarding this product.

Model No. DAV-LF1H

Serial No. \_\_\_\_\_

## WARNING

This equipment has been tested and found to comply with the limits for a Class B digital device, pursuant to Part 15 of the FCC Rules. These limits are designed to provide reasonable protection against harmful interference in a residential installation. This equipment generates, uses, and can radiate radio frequency energy and, if not installed and used in accordance with the instructions, may cause harmful interference to radio communications. However, there is no guarantee that interference will not occur in a particular installation. If this equipment does cause harmful interference to radio or television reception, which can be determined by turning the equipment off and on, the user is encouraged to try to correct the interference by one or more of the following measures:

- Reorient or relocate the receiving antenna (aerial).
- Increase the separation between the equipment and receiver.
- Connect the equipment into an outlet on a circuit different from that to which the receiver is connected.
- Consult the dealer or an experienced radio/TV technician for help.

## CAUTION

You are cautioned that any changes or modifications not expressly approved in this manual could void your authority to operate this equipment.

## Important Safety Instructions

- 1) Read these instructions.
- 2) Keep these instructions.
- 3) Heed all warnings.
- 4) Follow all instructions.
- 5) Do not use this apparatus near water.
- 6) Clean only with dry cloth.
- 7) Do not block any ventilation openings. Install in accordance with the manufacturer's instructions.
- 8) Do not install near any heat sources such as radiators, heat registers, stoves, or other apparatus (including amplifiers) that produce heat.
- 9) Do not defeat the safety purpose of the polarized or grounding-type plug. A polarized plug has two blades with one wider than the other. A grounding type plug has two blades and a third grounding prong. The wide blade or the third prong are provided for your safety. If the provided plug does not fit into your outlet, consult an electrician for replacement of the obsolete outlet.
- 10) Protect the power cord from being walked on or pinched particularly at plugs, convenience receptacles, and the point where they exit from the apparatus.

- 11) Only use attachments/accessories specified by the manufacturer.
- 12) Use only with the cart, stand, tripod, bracket, or table specified by the manufacturer, or sold with the apparatus. When a cart is used, use caution when moving the cart/apparatus combination to avoid injury from tip-over.



- 13) Unplug this apparatus during lightning storms or when unused for long periods of time.
- 14) Refer all servicing to qualified service personnel. Servicing is required when the apparatus has been damaged in any way, such as power-supply cord or plug is damaged, liquid has been spilled or objects have fallen into the apparatus, the apparatus has been exposed to rain or moisture, does not operate normally, or has been dropped.

**Note to CATV system installer:**

This reminder is provided to call the CATV system installer's attention to Article 820-40 of the NEC that provides guidelines for proper grounding and, in particular, specifies that the cable ground shall be connected to the grounding system of the building, as close to the point of cable entry as practical.

**For the customers in Canada**

**CAUTION**

TO PREVENT ELECTRIC SHOCK, MATCH WIDE BLADE OF PLUG TO WIDE SLOT, FULLY INSERT.

**Precautions**

**On power sources**

- AC power cord (mains lead) must be changed only at the qualified service shop.
- The unit is not disconnected from the AC power source (mains) as long as it is connected to the wall outlet (mains), even if the unit itself has been turned off.
- Install this system so that the AC power cord (mains) can be unplugged from the wall socket immediately in the event of trouble.

## Welcome!

Thank you for purchasing Sony DVD Home Theatre System. Before operating this system, please read this manual thoroughly and retain it for future reference.

# Table of Contents

Welcome! .....	3	Resuming Playback from the Point Where You Stopped the Disc.....	54 (Resume Play)
About This Manual .....	6	Creating Your Own Program.....	55 (Program Play)
This System Can Play the Following Discs .....	6	Playing in Random Order.....	57 (Shuffle Play)
<b>Getting Started – BASIC –</b>		Playing Repeatedly .....	58 (Repeat Play)
<b>Step 1: Assembling the system...11</b>		Using the DVD's Menu.....	59
<b>Step 2: Connecting the System...22</b>		Changing the Sound .....	59
<b>Step 3: Connecting the TV .....27</b>		Selecting [ORIGINAL] or [PLAY LIST] on a DVD-R/DVD-RW.....	61
<b>Step 4: Positioning the System ...28</b>		Changing the Display Mode.....	62 (INFORMATION MODE)
<b>Step 5: Performing the Quick   Setup .....</b>	<b>30</b>	Viewing Information About the Disc ...	63
<b>Getting Started</b>		Changing the Angles .....	65
<b>– ADVANCED –</b>		Displaying the Subtitles.....	66
Using the IR Receiver.....	33	Adjusting the Delay Between the Picture and Sound.....	66 (A/V SYNC)
Installing the IR Transmitter and the IR Receiver on a Wall .....	34	Selecting a Playback Area for a Super Audio CD .....	67
TV Hookup (Advanced) .....	36	About MP3 Audio Tracks and JPEG Image Files .....	68
Other Component Hookup.....	40	Playing DATA CDs or DATA DVDs with MP3 Audio Tracks and JPEG Image Files .....	69
<b>Basic Operations</b>		Playing Audio Tracks and Images as a Slide Show with Sound .....	71
<b>Playing Discs.....42</b>		Playing VIDEO CDs with PBC Functions (Ver.2.0) .....	73 (PBC Playback)
<b>Enjoying the Radio or Other   Components .....</b>	<b>44</b>	<b>Tuner Functions</b>	
<b>Enjoying TV or VCR Sound from All   Speakers .....</b>	<b>46</b>	Presetting Radio Stations.....	75
<b>Selecting the Movie or Music   Mode.....</b>	<b>47</b>	Listening to the Radio .....	76
<b>Sound Adjustments</b>			
Enjoying Surround Sound by Using Sound Field.....	48		
Adjusting the Bass and Treble Level....	50		
<b>Various Functions for Playing Discs</b>			
Searching for a Particular Point on a Disc .....	51 (Scan, Slow-motion Play, Freeze Frame)		
Searching for a Title/Chapter/Track/ Scene, etc. ....	52		
Searching by Scene.....	53 (Picture Navigation)		

## Other Operations

Controlling the TV with the Supplied Remote .....	78
Using the THEATRE SYNC Function .....	80
Enjoying Multiplex Broadcast Sound .....	81
(DUAL MONO)	
Using the Sound Effect .....	82
Using the Sleep Timer .....	82
Changing the Brightness of the Front Panel Display .....	83

## Advanced Settings and Adjustments







Locking Discs .....	84
(CUSTOM PARENTAL CONTROL, PARENTAL CONTROL)	
Calibrating the Appropriate Settings Automatically .....	87
(AUTO CALIBRATION)	
Using the Setup Display.....	90
Setting the Display or Sound Track Language .....	91
[LANGUAGE SETUP]	
Settings for the Display .....	92
[SCREEN SETUP]	
Custom Settings .....	95
[CUSTOM SETUP]	
Settings for the Speakers.....	97
[SPEAKER SETUP]	
Returning to the Default Settings.....	100

## Additional Information

Precautions.....	101
Notes about the Discs .....	102
Troubleshooting.....	102
Self-diagnosis Function .....	106
(When letters/numbers appear in the display)	
Specifications.....	107
Glossary .....	109
Language Code List.....	113
Index to Parts and Controls .....	114
Guide to the Control Menu Display ...	120
DVD Setup Display List.....	123
AMP Menu List .....	124
Index .....	125







## About This Manual

- The instructions in this manual describe the controls on the remote. You can also use the controls on the control unit if they have the same or similar names as those on the remote.
- The Control Menu items may be different depending on the area.
- “DVD” may be used as a general term for DVD VIDEOS, DVD+RWs/DVD+Rs, and DVD-RWs/DVD-Rs.
- Measurements are expressed in feet (ft) for North American models.
- The following symbols are used in this manual.

Symbol	Meaning
	Functions available for DVD VIDEOS, DVD-Rs/DVD-RWs in video mode, and DVD+Rs/DVD+RWs
	Functions available for DVD-Rs/DVD-RWs in VR (Video Recording) mode
	Functions available for VIDEO CDs (including Super VCDs or CD-Rs/CD-RWs in video CD format or Super VCD format)
	Functions available for Super Audio CDs
	Functions available for music CDs or CD-Rs/CD-RWs in music CD format
	Functions available for DATA CDs (CD-ROMs/CD-Rs/CD-RWs) containing MP3* audio tracks, JPEG image files
	Functions available for DATA DVDs (DVD-ROMs/DVD-Rs/DVD-RWs/DVD+Rs/DVD+RWs) containing MP3* audio tracks, JPEG image files

\* MP3 (MPEG1 Audio Layer 3) is a standard format defined by ISO/MPEG which compresses audio data.

## This System Can Play the Following Discs

Format of discs	Disc logo
DVD VIDEO	
DVD-RW/ DVD-R	
DVD+RW/ DVD+R	
Super Audio CD	 SUPER AUDIO CD
VIDEO CD (Ver. 1.1 and 2.0 discs)/CD Graphics (Latin American models only)/ Audio CD	
CD-RW/CD-R (audio data) (MP3 files) (JPEG files)	

“DVD+RW,” “DVD-RW,” “DVD+R,” “DVD VIDEO,” and the “CD” logos are trademarks.

---

## Note about CDs/DVDs

The system can play CD-ROMs/CD-Rs/CD-RWs recorded in the following formats:

- audio CD format
- video CD format
- MP3 audio tracks and JPEG image files of format conforming to ISO 9660 Level 1/Level 2, or its extended format, Joliet

The system can play DVD-ROMs/DVD+RWs/DVD-RWs/DVD+Rs/DVD-Rs recorded in the following formats:

- MP3 audio tracks, JPEG image files of format conforming to UDF (Universal Disc Format)

---

## Example of discs that the system cannot play

The system cannot play the following discs:

- CD-ROMs/CD-Rs/CD-RWs other than those recorded in the formats listed on page 6
- CD-ROMs recorded in PHOTO CD format
- Data part of CD-Extras
- DVD Audios
- DATA DVDs that do not contain MP3 audio tracks or JPEG image files.
- DVD-RAMs
- A DVD VIDEO with a different region code (page 9, 111).
- A disc that has a non-standard shape (e.g., card shaped, heart shaped).
- A disc that has a commercially available accessory attached, such as a label or ring.

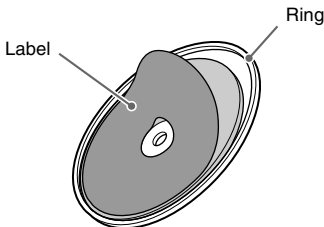

- An adapter to convert an 8 cm disc to standard size.

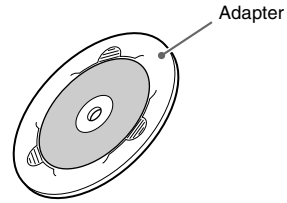

- A disc with paper or stickers on it.
- A disc that has the adhesive of cellophane tape or a sticker still left on it.

## Notes about CD-R/CD-RW/DVD-R/DVD-RW/DVD+R/DVD+RW

In some cases, CD-R/CD-RW/DVD-R/DVD-RW/DVD+R/DVD+RW cannot be played on this system due to the recording quality or physical condition of the disc, or the characteristics of the recording device and authoring software.

The disc will not play if it has not been correctly finalized. For more information, see the operating instructions for the recording device. Note that some playback functions may not work with some DVD+RWs/DVD+Rs, even if they have been correctly finalized. In this case, view the disc by normal playback. Also some DATA CDs/DATA DVDs created in Packet Write format cannot be played.

## Music discs encoded with copyright protection technologies

This product is designed to play back discs that conform to the Compact Disc (CD) standard. Recently, various music discs encoded with copyright protection technologies are marketed by some record companies. Please be aware that among those discs, there are some that do not conform to the CD standard and may not be playable by this product.

## Note on DualDisc

A DualDisc is a two sided disc product which mates DVD recorded material on one side with digital audio material on the other side. However, since the audio material side does not conform to the Compact Disc (CD) standard, playback on this product is not guaranteed.

---

## About Multi Session CD

- This system can play Multi Session CDs when an MP3 audio track is contained in the first session. Any subsequent MP3 audio tracks recorded in later sessions can also be played back.
- This system can play Multi Session CDs when a JPEG image file is contained in the first session. Any subsequent JPEG image files recorded in later sessions can also be played back.
- If audio tracks and images in music CD format or video CD format are recorded in the first session, only the first session will be played back.

---

## About the Super Audio CD

Super Audio CD is a new high-quality audio disc standard where music is recorded in the DSD (Direct Stream Digital) format (conventional CDs are recorded in the PCM format). The DSD format, using a sampling frequency 64 times higher than that of a conventional CD, and with 1-bit quantization, achieves both a wide frequency range and a wide dynamic range across the audible frequency range, and so provides music reproduction extremely faithful to the original sound.

### Types of Super Audio CDs

There are two types of discs, depending on the Super Audio CD layer and CD layer combination.

- Super Audio CD layer: A high-density signal layer for Super Audio CD
- CD layer<sup>1)</sup>: A layer that is readable by a conventional CD player

Single layer disc  
(a disc with a single Super Audio CD layer)

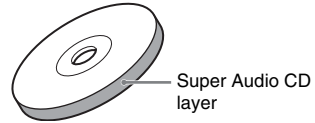

Hybrid disc<sup>2)</sup>  
(a disc with a Super Audio CD layer and a CD layer)

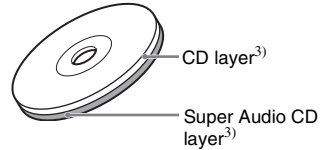

A Super Audio CD layer consists of the 2 channel area or the multi-channel area.

- 2 channel area: An area in which 2 channel stereo tracks are recorded
- Multi-channel area: An area in which multi-channel (up to 5.1 channels) tracks are recorded

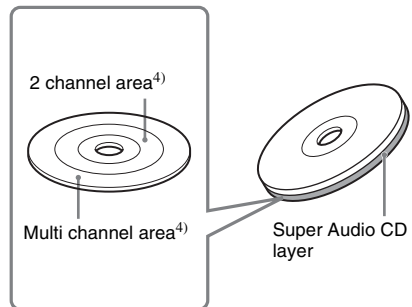

<sup>1)</sup>You can play the CD layer on a conventional CD player.

<sup>2)</sup>Since both layers are on one side, it is not necessary to turn the disc over.

<sup>3)</sup>To select a layer, see "Selecting a Playback Area for a Super Audio CD" (page 67).

<sup>4)</sup>To select an area, see "Selecting a Playback Area for a Super Audio CD" (page 67).



---

## Region code

Your system has a region code printed on the rear of the unit and will only play DVDs labeled with the same region code.

DVD VIDEOS labeled  will also play on this system.

If you try to play any other DVD VIDEO, the message [Playback prohibited by area limitations.] will appear on the TV screen.

Depending on the DVD VIDEO, no region code indication may be given even though playing the DVD VIDEO is prohibited by area restrictions.

---

## Note on playback operations of DVDs and VIDEO CDs

Some playback operations of DVDs and VIDEO CDs may be intentionally set by software producers. Since this system plays DVDs and VIDEO CDs according to the disc contents the software producers designed, some playback features may not be available. Also, refer to the instructions supplied with the DVDs or VIDEO CDs.

---

## Copyrights

This product incorporates copyright protection technology that is protected by U.S. patents and other intellectual property rights. Use of this copyright protection technology must be authorized by Macrovision, and is intended for home and other limited viewing uses only unless otherwise authorized by Macrovision. Reverse engineering or disassembly is prohibited.

This system incorporates with Dolby\* Digital and Dolby Pro Logic (II) adaptive matrix surround decoder and the DTS\*\* Digital Surround System.

\* Manufactured under license from Dolby Laboratories.  
“Dolby,” “Pro Logic,” and the double-D symbol are trademarks of Dolby Laboratories.

\*\* Manufactured under license from Digital Theater Systems, Inc. “DTS” and “DTS Digital Surround” are registered trademarks of Digital Theater Systems, Inc.

## Getting Started – BASIC –

See Unpacking in Specifications, page 109.

### Inserting batteries into the remote

You can control the system using the supplied remote. Insert two R6 (size AA) batteries by matching the ⊕ and ⊖ ends on the batteries to the markings inside the compartment. When using the remote, point it at the remote sensor on the control unit.

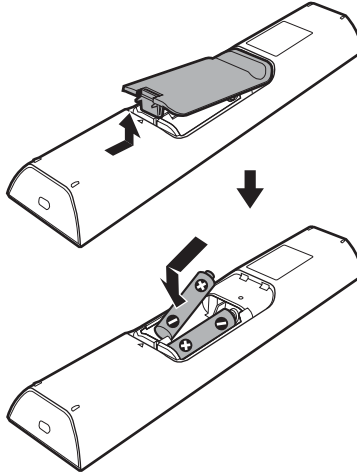

#### Note

- Do not leave the remote in an extremely hot or humid place.
- Do not use a new battery with an old one.
- Do not drop any foreign object into the remote casing, particularly when replacing the batteries.
- Do not expose the remote sensor to direct light from the sun or lighting apparatus. Doing so may cause a malfunction.
- If you do not intend to use the remote for an extended period of time, remove the batteries to avoid possible damage from battery leakage and corrosion.

## Step 1: Assembling the system

Before connecting, attach the stands to the control unit and the speakers.

### Tip

- We recommend that you spread a cloth on the floor to avoid damaging the floor when assembling.

### Assembling the control unit

Attach the stand to the control unit.

Use the parts illustrated below.

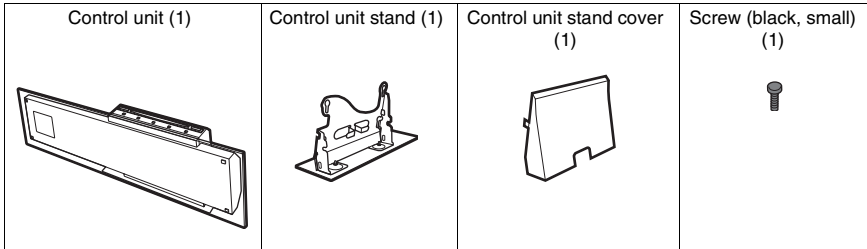

### Tip

- You can install the control unit on a wall using an optional kit (not supplied).

- 1** Hook the studs of the control unit on the keyslots of the control unit stand, then secure the control unit with the screw.

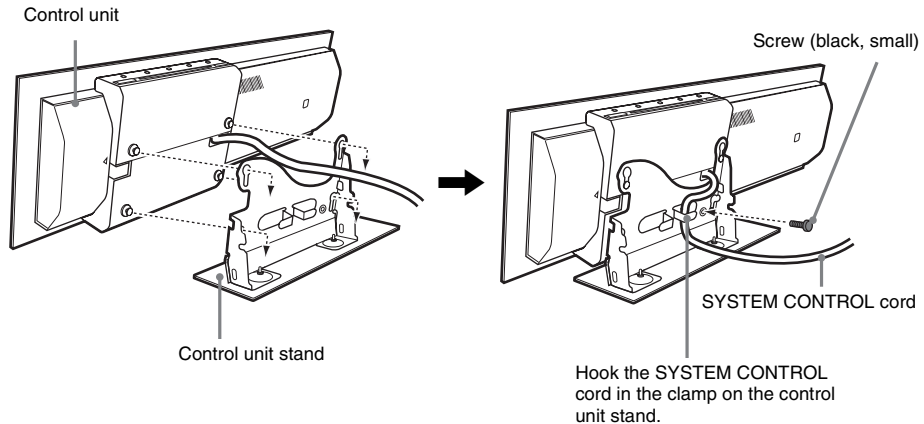

continued

11<sup>US</sup>

## 2 Attach the control unit stand cover to the control unit stand.

Snap the control unit stand cover onto the speaker stand.

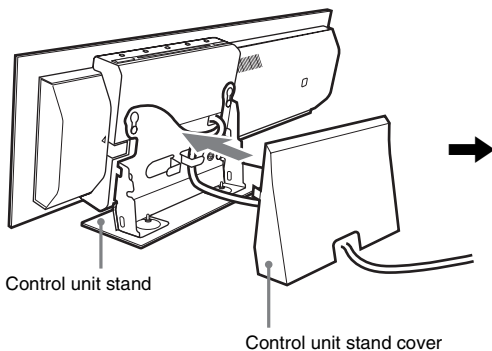

Draw the SYSTEM CONTROL cord through the opening of the control unit stand cover.

## Assembling the speakers

Attach the stands and connect the speaker cords to the center speaker, front speakers, and surround speakers.

### About connecting speaker cord

The connector and color tube of the speaker cords are the same color as the label of the speaker to be connected.

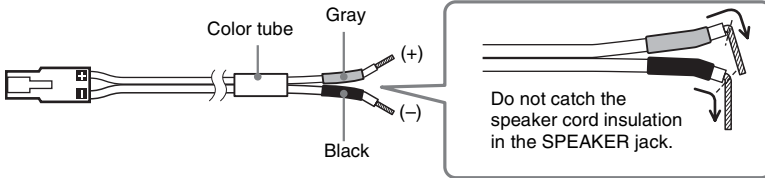

### To avoid short-circuiting the speakers

Short-circuiting of the speakers may damage the system. To prevent this, be sure to follow these precautions when connecting the speakers. Make sure the bare wire of each speaker cord does not touch another speaker terminal or the bare wire of another speaker cord, such as shown below.

Stripped speaker cord is touching another speaker terminal.

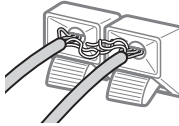

Stripped cords are touching each other due to excessive removal of insulation.

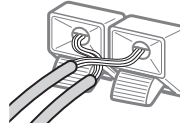





#### Note

- Be sure to match the speaker cord to the appropriate terminal on the components:  $\oplus$  to  $\oplus$ , and  $\ominus$  to  $\ominus$ . If the cords are reversed, the sound will lack bass and may be distorted.

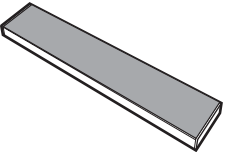
### To assemble the center speaker

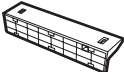
Use the parts illustrated below.

Center speaker (1)  Label on the rear of the speaker: Green	Adjuster (1) 	Center speaker base (1) 	Speaker cord (green) (1) 	Screws (silver, large) (2) 
--	---	--	---	---

#### Tip

- You can install the center speaker on a wall using an optional kit (not supplied).

continued

13<sup>US</sup>

# 1 Secure the adjuster and center speaker base with the screws.

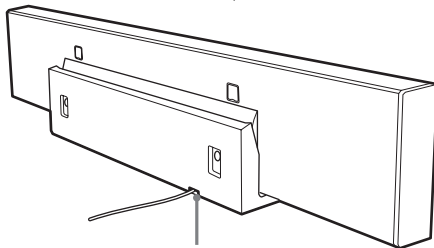
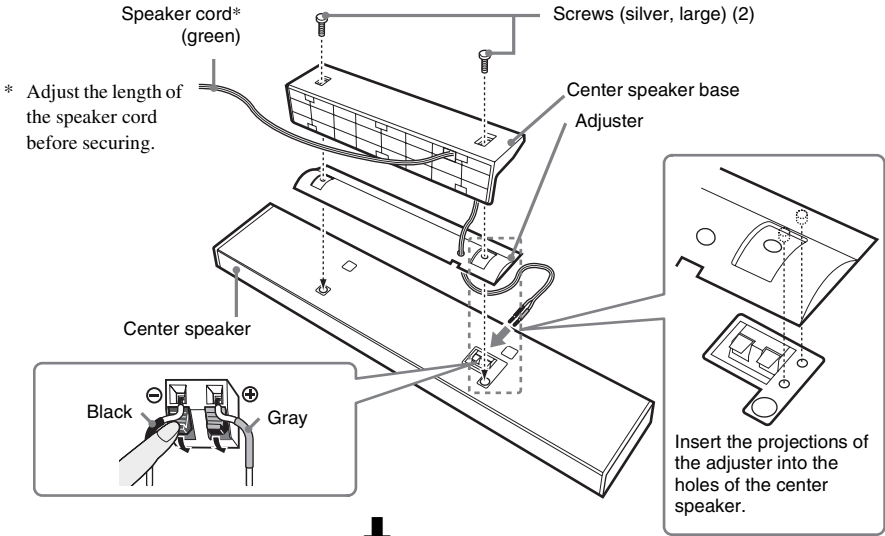

Draw out the speaker cord through the slit on the center speaker base.

## To adjust the angle of the center speaker

You can set the angle by adjusting the position of the screws.

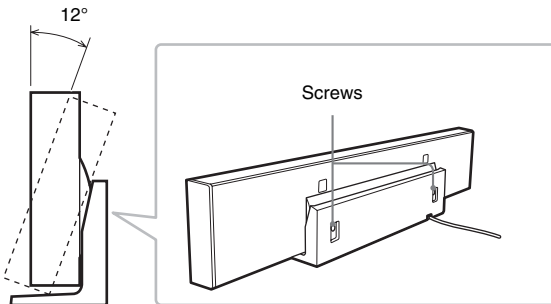

## To assemble the front and surround speakers

Attach the speaker stands to the front and surround speakers. The procedure of assembling for the surround speaker (L) (the left surround speaker) is slightly different from the others. (The surround speaker (L) has the IR receiver.) Any difference in procedure is clearly indicated in the text, for example, “For the surround speaker (L).”

Use the parts illustrated below.

Front speakers and surround speaker (R) <sup>1)</sup> (3)	Surround speaker (L) <sup>2)</sup> (1)                      IR receiver	Post (4)	Base (4)	Speaker adaptor <sup>3)</sup> (4)	Speaker adaptor cover <sup>3)</sup> (4)
			Speaker cords (3) (white, red, gray)	Cord clamp (1)	Screws silver, small (8) black, large (12) black, medium (1)

<sup>1)</sup> The front speakers and surround speaker (R) are identical. To discriminate between the speakers, see the label on the rear of each speaker.

Front speaker (L) (left front speaker): White label

Front speaker (R) (right front speaker): Red label

Surround speaker (R) (right surround speaker): Gray label

<sup>2)</sup> Surround speaker (L) (left surround speaker): Blue label

<sup>3)</sup> When unpacking, the speaker adaptor cover is attached to the speaker adaptor.

### Tip

- You can install the front speakers and the surround speakers on a wall using an optional kit (not supplied).

continued

15<sup>US</sup>

## Fully-assembled illustration

The speaker that has the IR receiver is the surround speaker (L) (left surround speaker), the speaker that is connected to the surround speaker (L) is the surround speaker (R) (right surround speaker), and others are the front speakers.

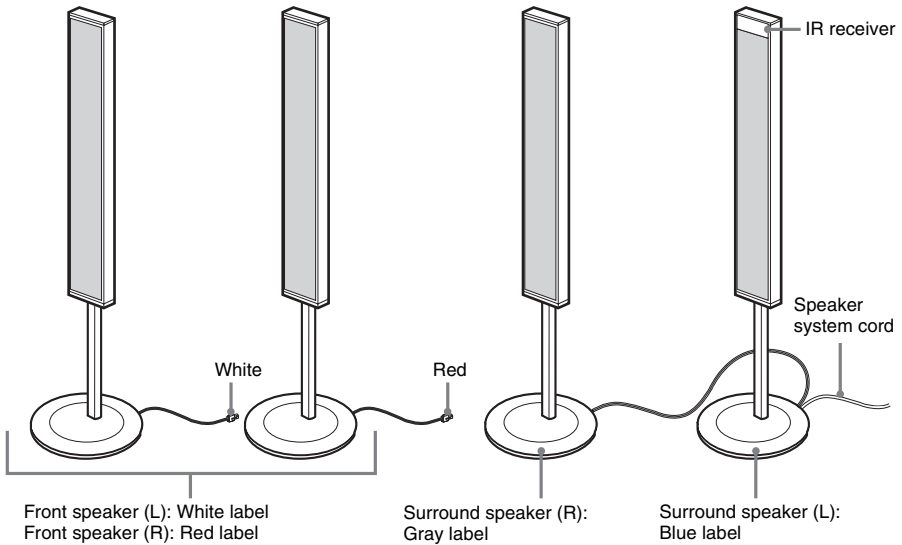

## 1 Insert the post into the base, and secure the base with screws. (for all speakers)

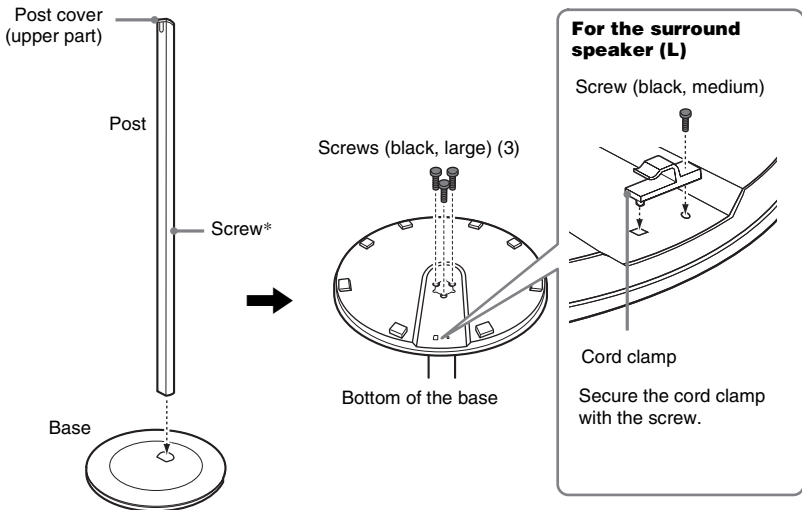

\* Do not remove the screw that is attached to the post. The screw is to prevent the speaker from slipping.



- 2** Remove the post cover, slide the speaker adaptor onto the post, adjust the height of the speaker adaptor, and secure it with the screws. (for all speakers)

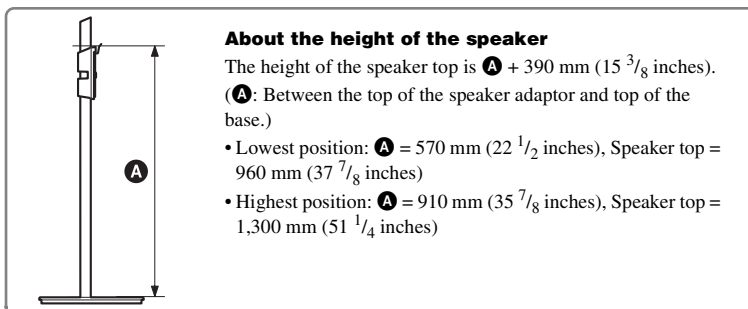
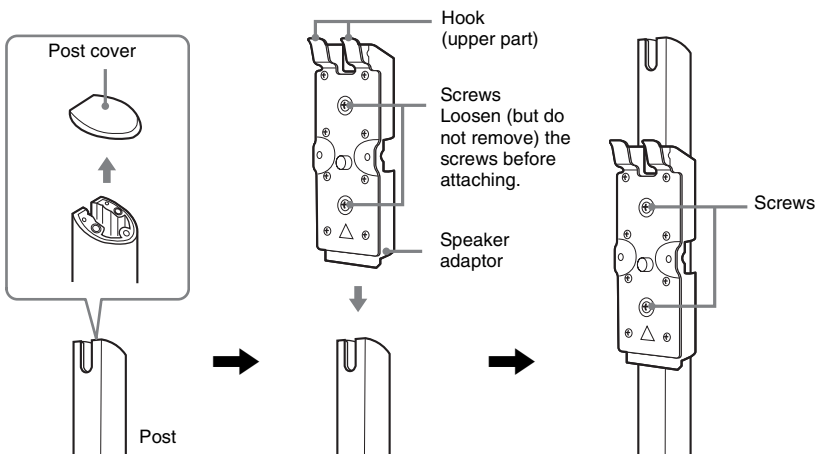

**Note**

- Keep the post cover handy, so you can replace it later.

- 3** (For the surround speaker (L))  
 Connect the connector of the speaker cord to the speaker.

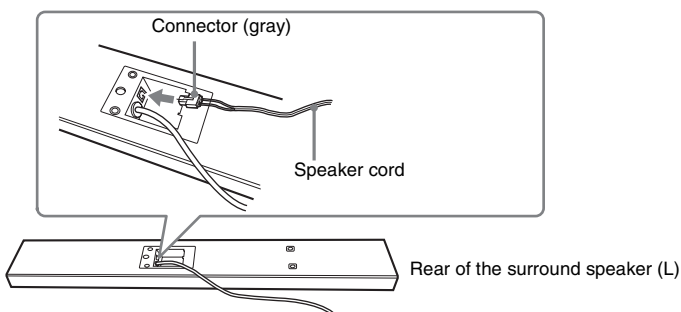

continued

17<sup>US</sup>

**4 (For the surround speaker (L))**

Draw the speaker cord first, then draw the speaker system cord into the post.

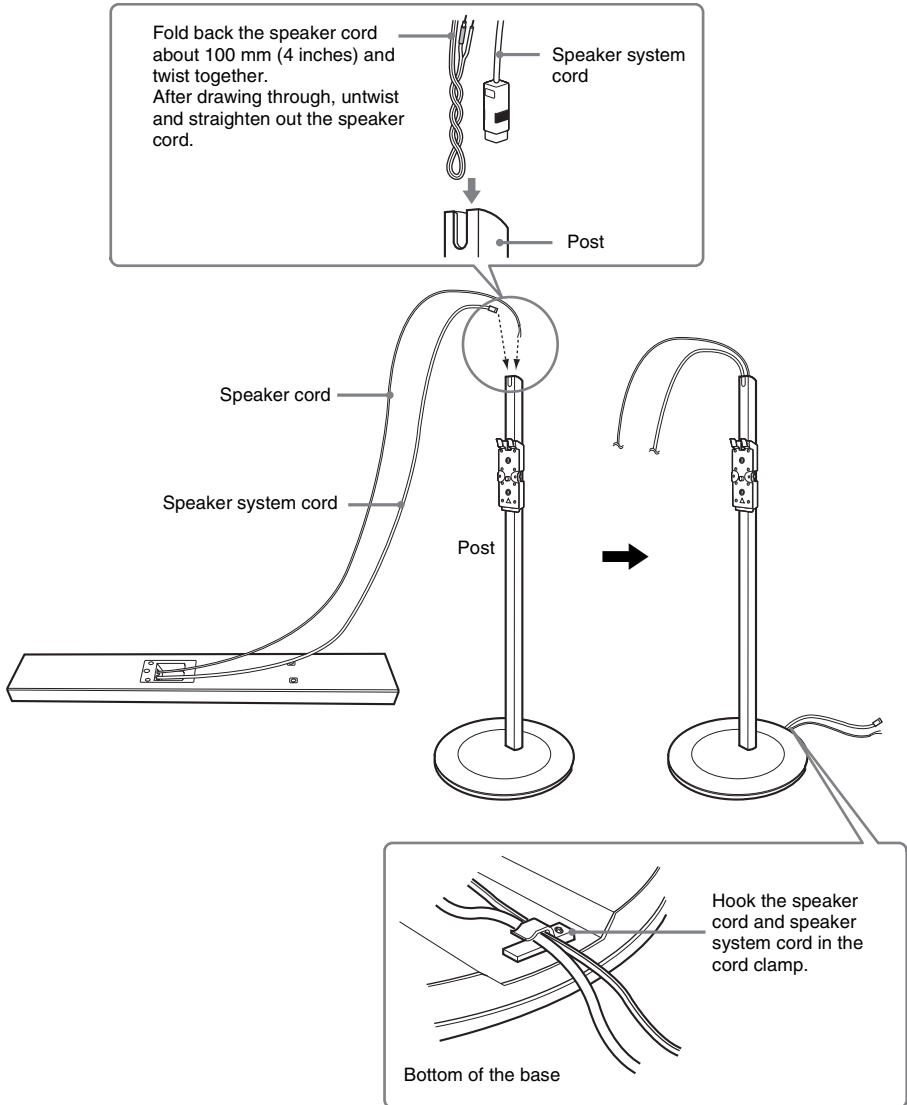
**Tip**

- Tilt the post so that the cords are drawn smoothly.

For the next procedure of the surround speaker (L), skip to step 7.

**5 (For the front speakers and surround speaker (R))**  
**Draw the speaker cord into the post.**

Fold back the speaker cord about 100 mm (4 inches) and twist together. After drawing through, untwist and straighten out the speaker cord.

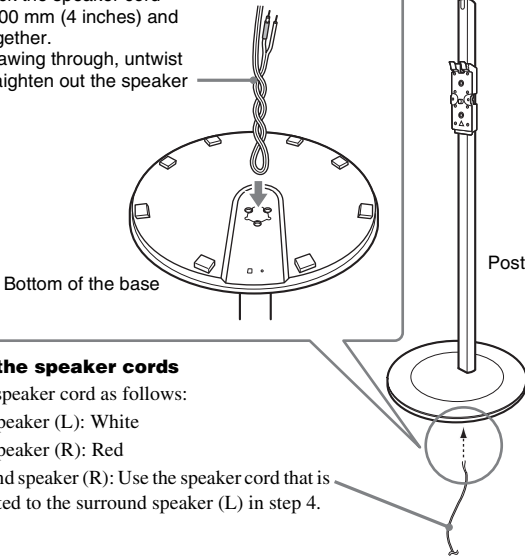

**About the speaker cords**

Use the speaker cord as follows:

- Front speaker (L): White
- Front speaker (R): Red
- Surround speaker (R): Use the speaker cord that is connected to the surround speaker (L) in step 4.

**6 (For the front speakers and surround speaker (R))**  
**Connect the speaker cord to the speaker.**

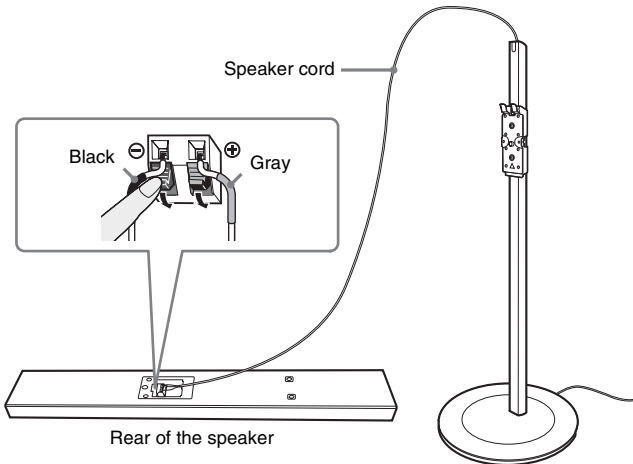

*continued*

19<sup>US</sup>

## 7 Attach the speaker to the speaker adaptor. (for all speakers)

Hook the speaker on the hooks of the speaker adaptor.

Draw the cord(s) between the hooks of the speaker adaptor and between the slit of the post.

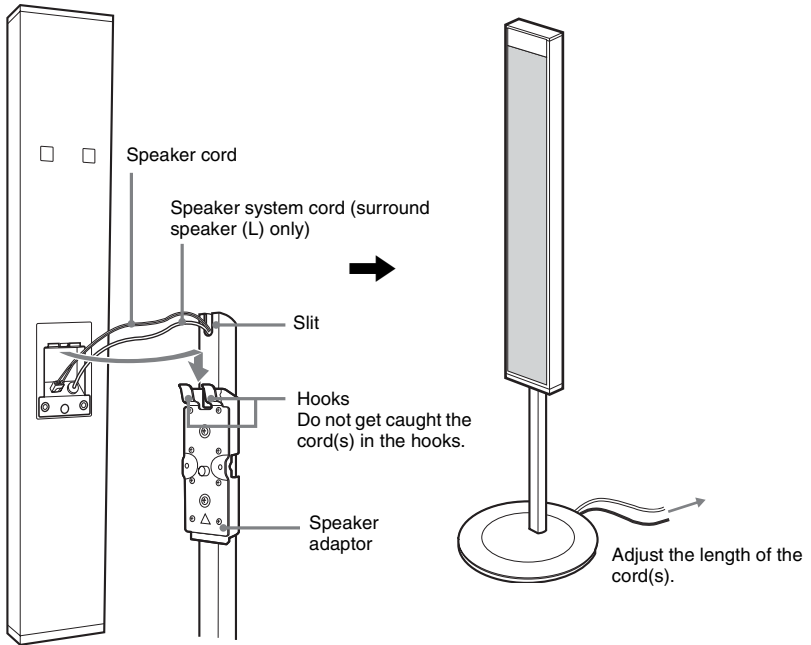

## 8 Secure the speaker with the screws. (for all speakers)

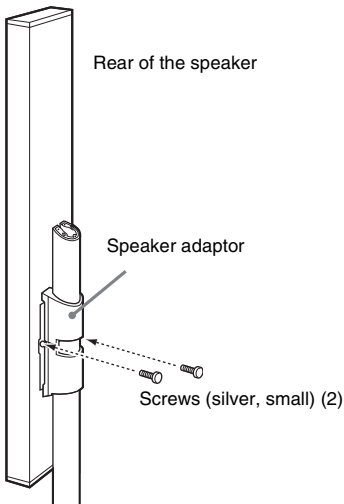

**9** Attach the speaker adaptor cover to the speaker adaptor until it clicks, and attach the post cover. (for all speakers)

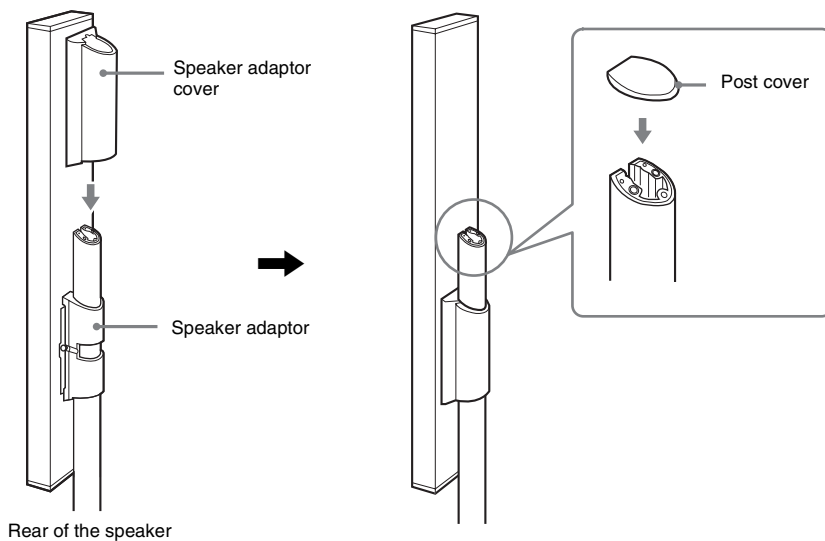

**Note**

- Do not insert the speaker adaptor cover at a slant. Insert the speaker adaptor cover straight down so that the lower part is fixed.

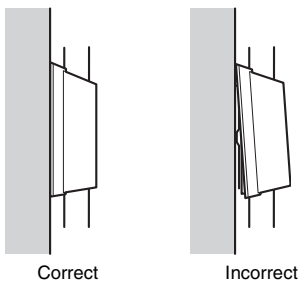

## Step 2: Connecting the System

This hookup is the basic connection of the system. For TV connections, see pages 27 and 36. For other component connection, see page 40.

Refer to the connection diagram below, and read the additional information from ① to ⑥ on the following pages.

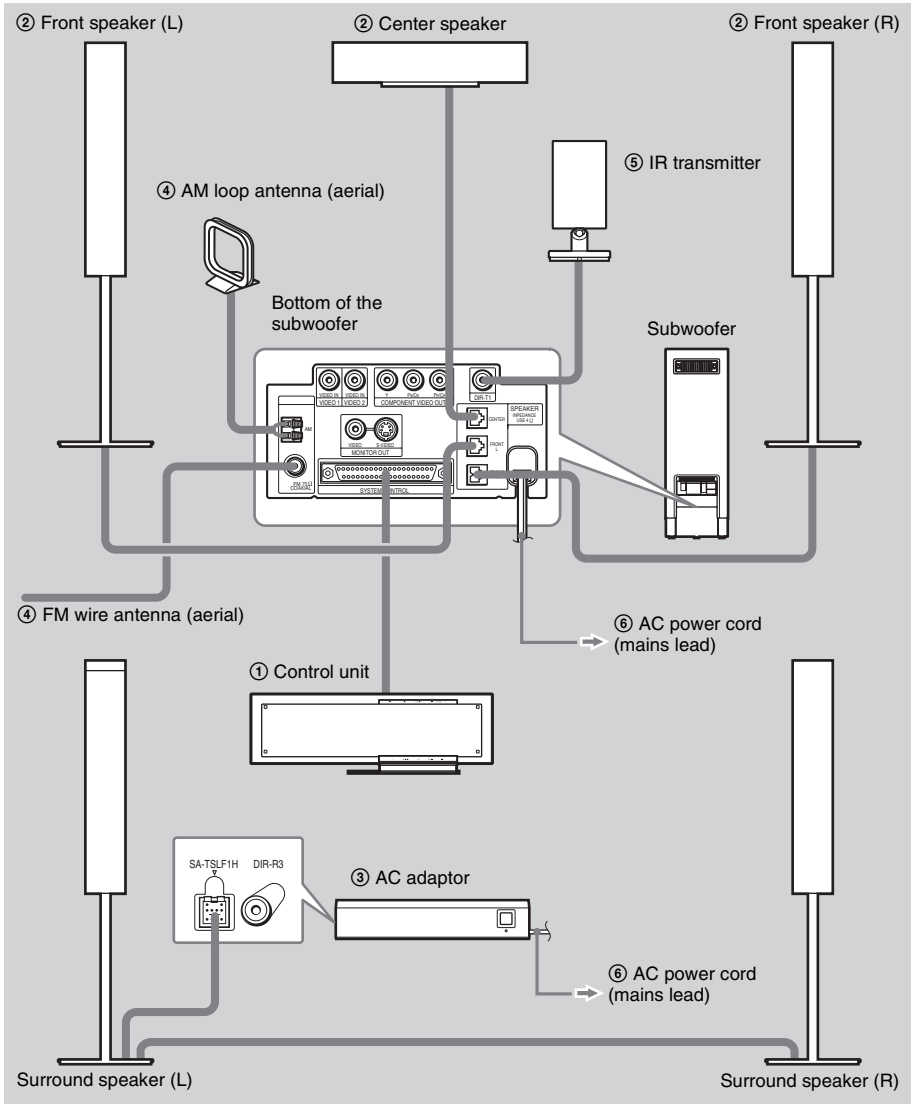

**Note on handling the subwoofer**

- Do not place your hand into the slit of the subwoofer when lifting it. The speaker driver may be damaged. When lifting, hold the bottom of the subwoofer.

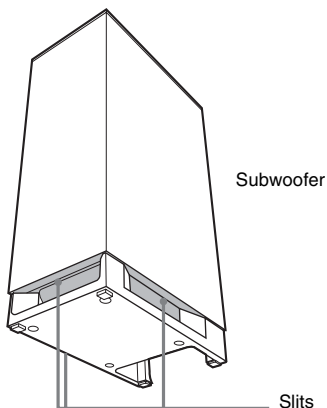
**① Connecting the Control unit**

Connect the system connector of the control unit to the SYSTEM CONTROL jack of the subwoofer. Insert the plug of the SYSTEM CONTROL cord, then secure the screws of the plug.

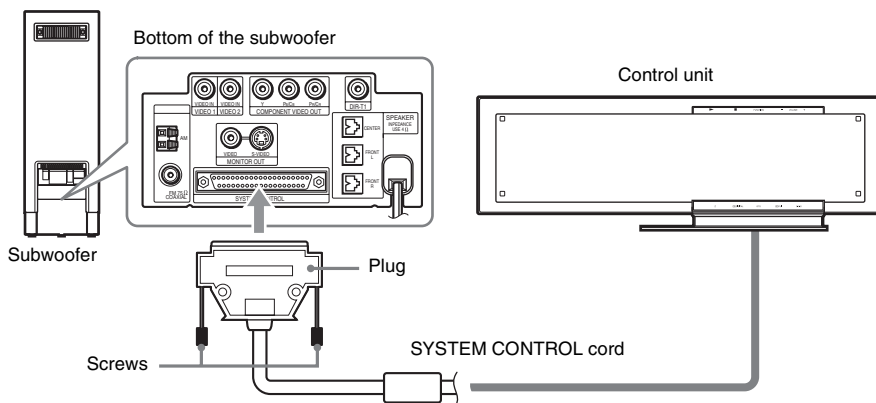

## ② Connecting the Speakers

### To connect the front and center speakers

Connect the connectors of the speaker cords to the correspond SPEAKER jacks. The connectors of the speaker cords are the same color as the jacks to be connected.

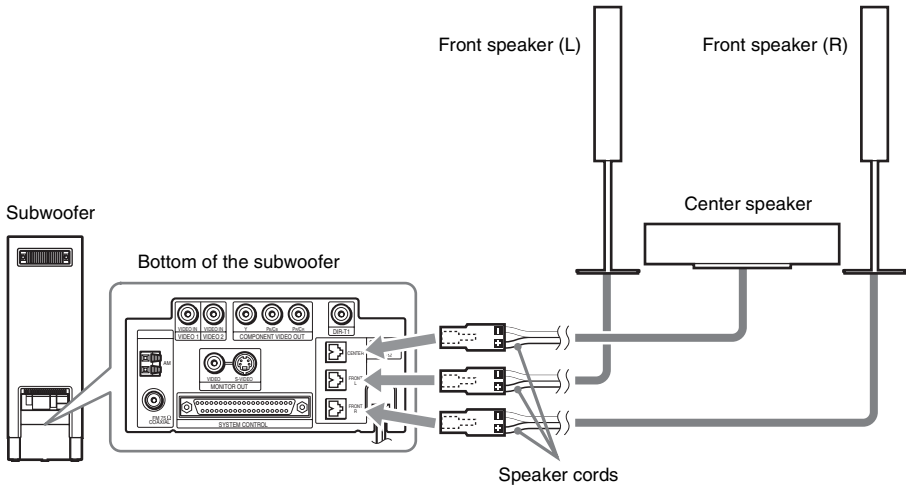

## ③ Connecting the AC adaptor

Connect the speaker system cord of the surround speaker (L) to the SA-TSLF1H jack of the AC adaptor.

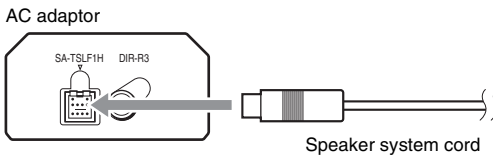



## ④ Connecting the Antenna (Aerial)

### To connect the AM antenna (aerial)

The shape and the length of the antenna (aerial) is designed to receive AM signals. Do not dismantle or roll up the antenna (aerial).

- 1** Remove only the loop part.
- 2** Set up the AM loop antenna (aerial).

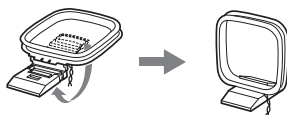

### 3 Connect the cords to the AM antenna (aerial) terminals.

Cord (A) or cord (B) can be connected to either terminal.

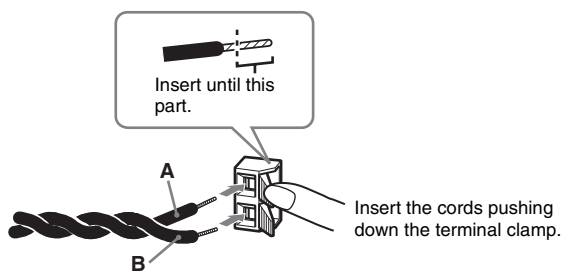

#### Note

- Do not place the AM loop antenna (aerial) near the system or other AV equipment, as noise may result.

#### Tip

- Adjust the direction of the AM loop antenna (aerial) for best AM broadcast sound.

### 4 Make sure the AM loop antenna (aerial) is connected firmly by pulling softly.

### To connect the FM wire antenna (aerial)

Connect the FM wire antenna (aerial) to the FM 75 Ω COAXIAL jack.

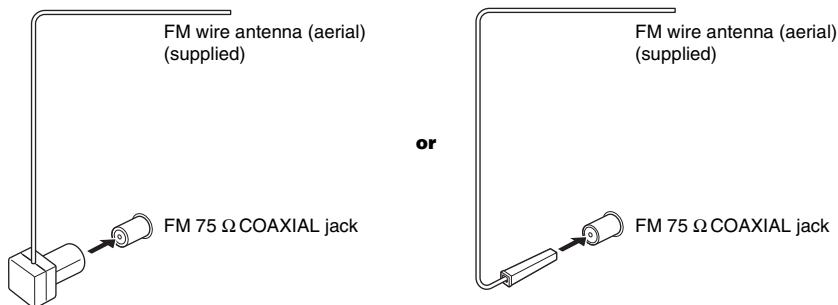

#### Note

- Be sure to fully extend the FM wire antenna (aerial).

- After connecting the FM wire antenna (aerial), keep it as horizontal as possible.

**Tip**

- If you have poor FM reception, use a 75-ohm coaxial cable (not supplied) to connect the system to an outdoor FM antenna (aerial) as shown below.

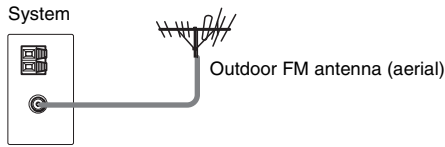

## ⑤ Connecting the IR transmitter

Transmits the sound by the infrared signals. Connect it to the DIR-T1 jack of the subwoofer.

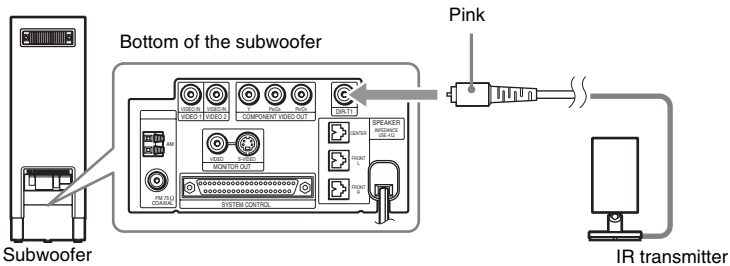

## ⑥ Connecting the AC power cords (mains leads)

Before connecting the AC power cords (mains leads) of the subwoofer and the AC adaptor to a wall outlet (mains), connect the front and center speakers to the subwoofer and surround speaker (R) to the surround speaker (L) (page 22).

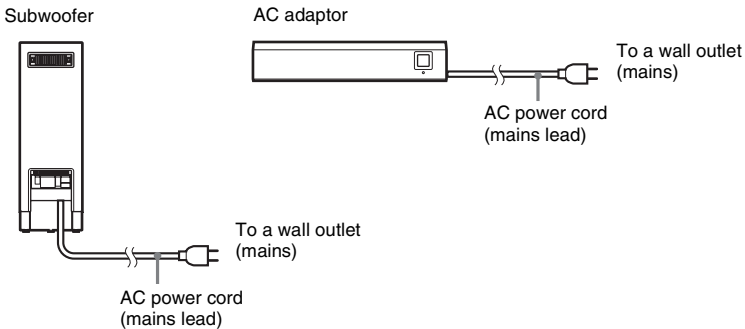

## Step 3: Connecting the TV

This hookup is the basic connection of the system and TV. For other TV connections, see page 36. For other component connection, see page 40.

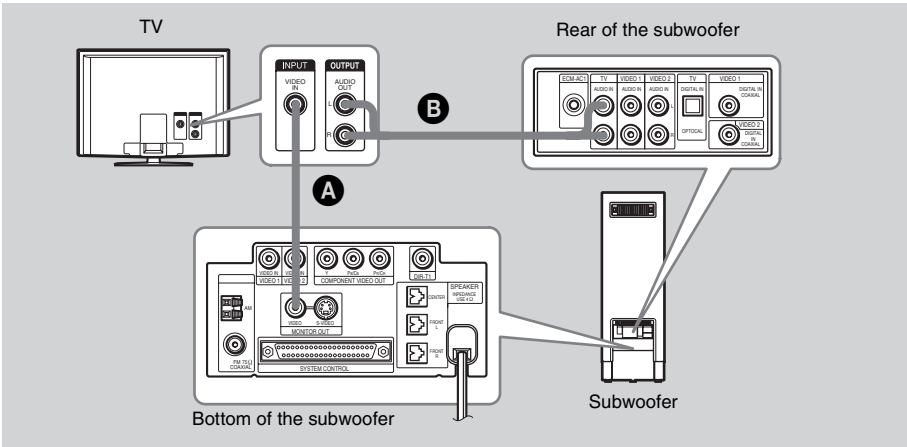

### Required cords

#### A Video cord



This connection sends the image to the TV. Connect the MONITOR OUT (VIDEO) jack of the subwoofer to the VIDEO IN jack of the TV.

#### B Audio cord (not supplied)

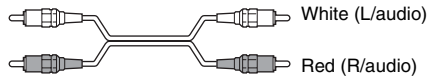

This connection sends TV sound to the system. You can enjoy TV sound from the speakers with the connection. Connect the TV (AUDIO IN) jacks of the subwoofer to the AUDIO OUT jacks of the TV.

#### Note

- When connecting the jack, insert the plug into the jack as far as it will go.

#### Example

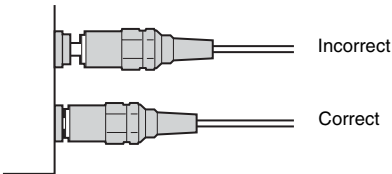

## Step 4: Positioning the System

### Positioning the speakers

For the best possible surround sound, all the speakers other than the subwoofer should be the same distance from the listening position (A). All the speakers can be placed from 0.0 to 6.9 meters (0 to 23 ft) (A) from the listening position.

Install the IR transmitter and IR receiver of the surround speaker (L) in direct line with each other. For details, see “Adjusting the IR transmitter and IR receiver of the surround speaker (L)” (page 29).

Place speakers as illustrated below.

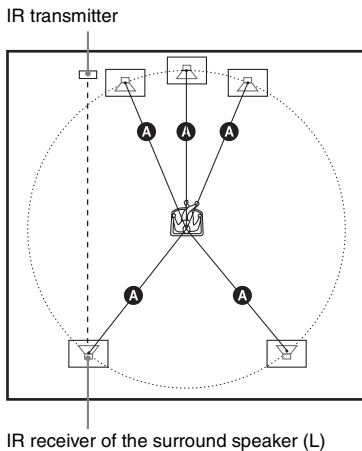

The following diagram indicates the infrared transmission area (the range that the infrared rays can reach).

#### Top view

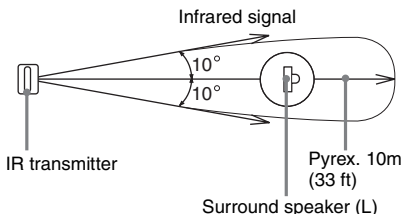

#### Side view

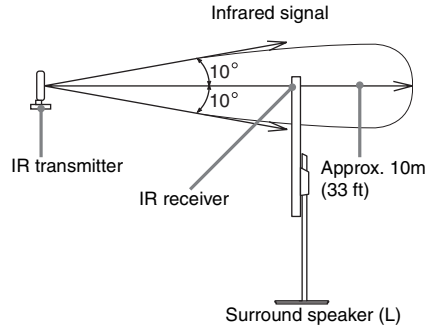

#### Note

- Do not install the surround speaker (L) in a place exposed to direct sunlight or strong light such as an incandescent lamp.
- The cord of the IR transmitter is for this system only.
- Do not set the speakers in an inclined position.
- Do not place the speakers in locations that are:
  - Extremely hot or cold
  - Dusty or dirty
  - Very humid
  - Subject to vibrations
  - Subject to direct sunlight
- Use caution when placing the speakers and/or speaker stands (not supplied) that are attached with the speakers on a specially treated (waxed, oiled, polished, etc.) floor, as staining or discoloration may result.
- When cleaning, use a soft cloth such as a cleaning cloth for glasses.
- Do not use any type of abrasive pad, scouring powder, or solvent such as alcohol or benzene.
- Do not lean or hang on the speaker, as the speaker may fall down.

#### Tip

- You can install the IR transmitter on a wall for better positioning. For details, see page 34.
- You can swap the surround speaker (L) and (R) positions, depending on the wall outlet and speaker layout (page 99).
- When you change the positions of the speakers, it is recommended that you change the settings. For details, see “Calibrating the Appropriate Settings Automatically” (page 87).

- Depending on the speaker layout (i.e. when placing the surround speaker (L) toward the listening position, etc.), or when there is obstruction, such as a person or object between the IR transmitter and the IR receiver of the surround speaker (L), you can use the external IR receiver (supplied) instead. The IR receiver is compact and easy to install. For details, see “Using the IR Receiver” (page 33).

## Adjusting the IR transmitter and IR receiver of the surround speaker (L)

Adjust the wireless system for good transmission.

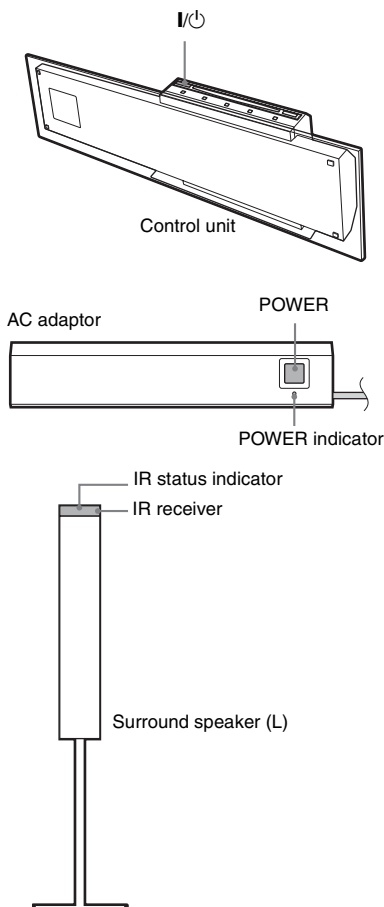

### 1 Press POWER on the AC adaptor, then press I/⏻ on the control unit.

The AC adaptor and system turn on.

The POWER indicator of the AC adaptor lights up and the IR status indicator of the surround speaker (L) turns orange.

### 2 Orient the IR transmitter and the IR receiver of the surround speaker (L) to face each other.

Adjust the position until the IR status indicator turns green.

#### Tip

- The IR transmitter is movable for easy reorientation.
- You can install the IR transmitter on a wall for better positioning. For details, see page 33.

#### Note

- Make sure that there is no obstruction such as a person or object between the IR transmitter and the IR receiver of the surround speaker (L). Otherwise, the sound from the surround speakers may be interrupted.
- If the IR status indicator turns orange, transmission is not occurring. Adjust the position of the IR transmitter and surround speaker (L) until the IR status indicator turns green.
- If the IR status indicator flashes orange, the IR receiver is receiving an infrared ray from another Sony's wireless product. Move the IR transmitter and/or the surround speaker (L) so that the IR status indicator turns green.

## Step 5: Performing the Quick Setup

Follow the steps below to make the minimum number of basic adjustments for using the system.

When using the remote, point it at the remote sensor on the control unit.

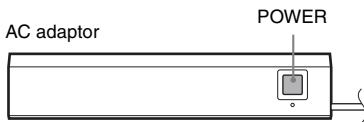
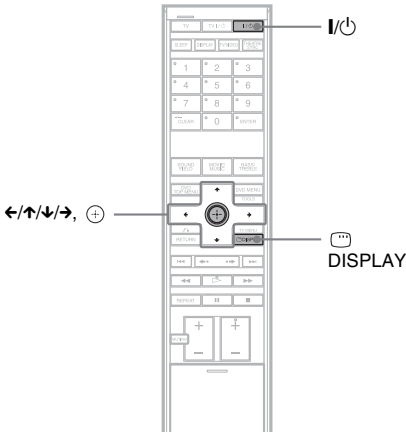

- 1** Turn on the TV.
  - 2** Press **I/⏻** on the remote and **POWER** on the AC adaptor.  
The system and AC adaptor turn on.
- Note**
- Make sure that the function is set to “DVD.”
- 3** Switch the input selector on your TV so that the signal from the system appears on the TV screen.

[Press [ENTER] to run QUICK SETUP.] appears at the bottom of the screen. If this message does not appear, display the Quick Setup and perform again (page 32).

- 4** Press **+/-** without inserting a disc.

The Setup Display for selecting the language used in the on-screen display appears.

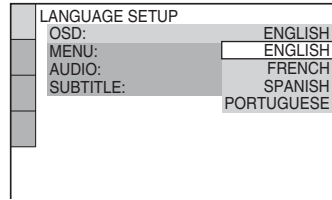

- 5** Press **↑/↓** to select a language.

The system displays the menu and subtitles in the selected language.

- 6** Press **+/-**.

The Setup Display for selecting the aspect ratio of the TV to be connected appears.

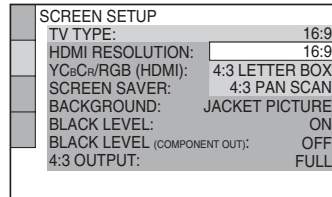

- 7** Press **↑/↓** to select the setting that matches your TV type.

■ If you have a wide-screen TV or a 4:3 standard TV with a wide-screen mode [16:9] (page 92)

■ If you have a 4:3 standard TV [4:3 LETTER BOX] or [4:3 PAN SCAN] (page 92)

- 8** Press **+/-**.

The [AUTO CALIBRATION] display appears.

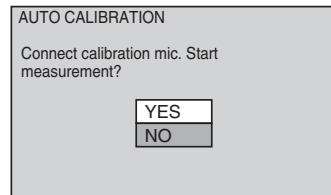

## 9 Connect the calibration mic to the ECM-AC1 jack on the rear of the subwoofer and set up the calibration mic at the ear level using a tripod, etc. (not supplied).

The front of each speaker should face the calibration mic, and there should be no obstruction between the speakers and the calibration mic.

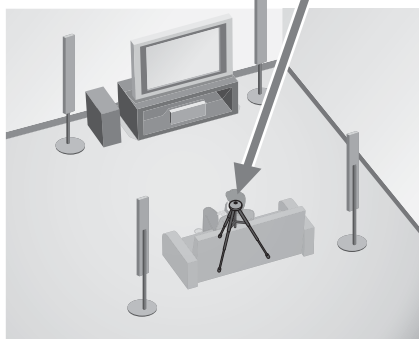
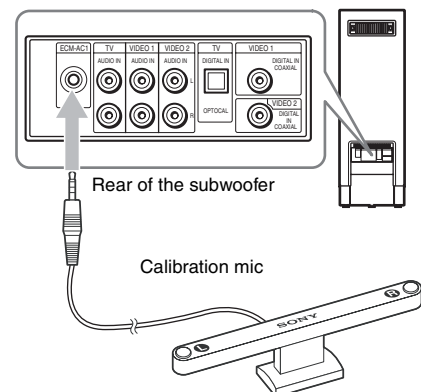

### Note

- Place the calibration mic so that the “FRONT” side of it is pointed toward the front speakers.

## 10 Press $\uparrow/\downarrow$ to select [YES], then press $\oplus$ -

[AUTO CALIBRATION] starts. Be quiet during the measurement.

### Note

- Loud test sound is output when [AUTO CALIBRATION] starts. You cannot turn the volume down. Give consideration to children and neighbor.

- Avoid being in the measurement area and making noise during the measurement (which takes about 1 minute), as it may interfere with measurement.
- If the sound of the surround speakers is not output, adjust the wireless system. See “Adjusting the IR transmitter and IR receiver of the surround speaker (L)” (page 29).
- When you install the surround speaker (L) to the right position, the system sets the “SL SR REVERSE” setting (page 99) to “ON” automatically.

## 11 Unplug the calibration mic and press $\leftarrow$ $\rightarrow$ to select [YES].

Quick Setup is finished. All connections and setup operations are complete.

Measurement complete.			
FRONT L :	16ft	4.8m	0.0dB
FRONT R :	16ft	4.8m	0.0dB
CENTER :	16ft	4.8m	+ 1.0dB
SUBWOOFER :	16ft	4.8m	+ 4.0dB
SURROUND L :	10ft	3.0m	- 2.0dB
SURROUND R :	10ft	3.0m	- 2.0dB
If OK, unplug calibration mic and select YES.			
		<input type="button" value="YES"/>	<input type="button" value="NO"/>

### Note

- Reflections from walls or the floor may affect measurements.
- If measurement fails, follow the message then retry [AUTO CALIBRATION].

## To quit the Quick Setup

Press  $\text{DISP}$  DISPLAY in any Step.

### Tip

- If you cancel [AUTO CALIBRATION], perform the speaker settings in “Settings for the Speakers” (page 97).
- If you change the position of the speakers, reset the speaker settings. See “Calibrating the Appropriate Settings Automatically” (page 87).
- If you want to change any of the settings, see “Using the Setup Display” (page 90).
- For details on [AUTO CALIBRATION] and the error messages of [AUTO CALIBRATION], see “Calibrating the Appropriate Settings Automatically” (page 87).



continued

31<sup>US</sup>

**To recall the Quick Setup display**



- 1 Press  DISPLAY when the system is in stop mode.

The Control Menu appears.

- 2 Press  to select  [SETUP], then press .

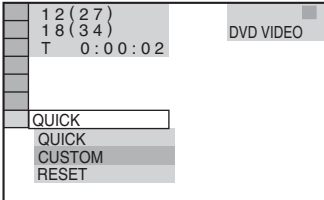
The options for [SETUP] appear.



- 3 Press  to select [QUICK], then press .

The Quick Setup display appears.



## Getting Started – ADVANCED –

### Using the IR Receiver

Depending on the speaker layout (i.e. when placing the surround speaker (L) toward the listening position, etc.), or when there is obstruction, such as a person or object between the IR transmitter and the IR receiver of the surround speaker (L), you can use the external IR receiver (supplied) instead. The IR receiver is compact and easy to install.

When using the IR receiver stand, attach the stand so that both delta marks on the IR receiver and stand are aligned.

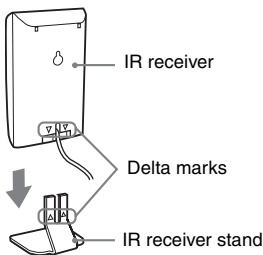

### To connect the IR receiver

Connect the cord of the IR receiver to the DIR-R3 jack of the AC adaptor.

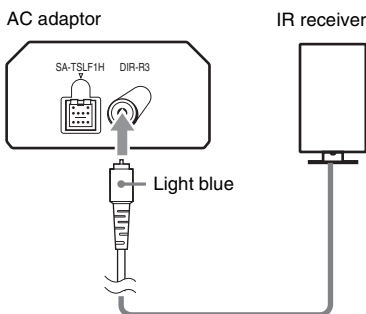

#### Note

- When you connect the IR receiver to the AC adaptor, the IR receiver is activated and the IR receiver of the surround speaker (L) is not activated automatically.
- When using the IR receiver, install it following the guidelines of the IR receiver of the surround speaker (L).

## Installing the IR Transmitter and the IR Receiver on a Wall

You can hang the IR transmitter and IR receiver on a wall when:

- there is an obstruction between the IR transmitter and the IR receiver.
- people often pass between the IR transmitter and the IR receiver.

When hanging both the IR transmitter and IR receiver, adjust the position of the IR transmitter after deciding the position of the IR receiver.

### Installing the IR transmitter on a wall

1 Rotate the stand of the IR transmitter.

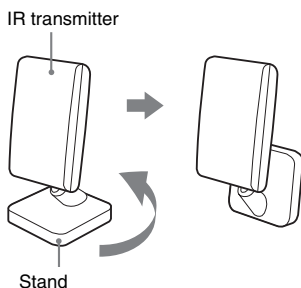

2 Install 2 commercially available screws in the wall so that it protrudes 4 mm ( $\frac{3}{16}$  inches).

Install the screws 30 mm ( $1\frac{3}{16}$  inches) apart.

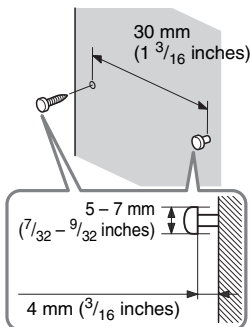

3 Hang the IR transmitter via hole on the bottom of the stand on the screw.

Make sure that the IR transmitter does not move after installation.

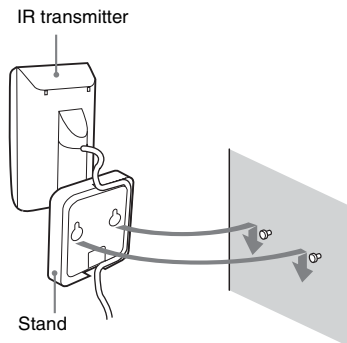

#### Tip

- You can store the cords in the troughs in the bottom of the stand.

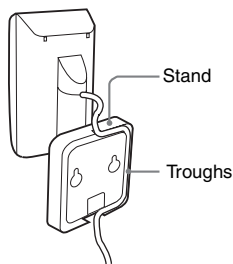

#### Note

- Use screws suitable for the material and strength of the wall.
- Do not install the IR transmitter to a wall of low strength.
- Sony is not liable for any damage or accident incurred by incorrect installation (i.e. low strength wall, etc.), incorrect use of this product, or natural disaster.
- When connecting/disconnecting the cord, detach the IR transmitter from the wall first.

## Installing the IR receiver on a wall

- 1 Install a commercially available screw in the wall so that it protrudes 4 mm ( $\frac{3}{16}$  inches).

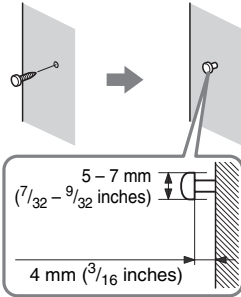

- 2 Detach the IR receiver stand and hang it via hole on the rear side of the IR receiver on the screw.

Make sure that the IR receiver does not move after installation.

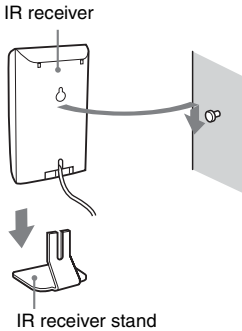

### Tip

- When reattaching the IR receiver stand to the IR receiver, attach the stand so that both delta marks on the IR receiver and stand are aligned (page 33).

# TV Hookup (Advanced)

Select a hookup suitable for the jacks on your TV.

## Connecting the video/HDMI\* cords

Sends a played back DVD image to a TV.

Check the jacks of your TV, and choose connection method **A**, **B**, or **C**. Picture quality improves in order from **A** (standard) to **C** (component).

For the TV that has the HDMI jack, connect the TV and the control unit with the HDMI cord (not supplied).

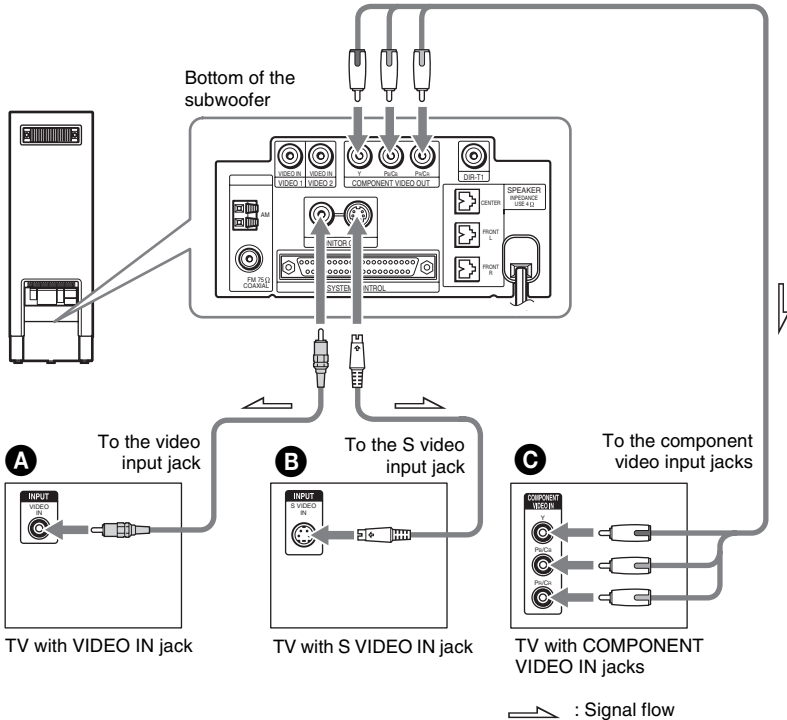

\* HDMI (high-definition multimedia interface)

The system is based on version 1.1 of High-Definition Multimedia Interface Specifications.

The system incorporates High-Definition Multimedia Interface (HDMI™) technology.

HDMI, the HDMI logo and High-Definition Multimedia Interface trademarks or registered trademarks of HDMI Licensing LLC.

### **A** To connect to a TV with the VIDEO IN jack

Connect the video cord.



### **B To connect to a TV with the S VIDEO IN jack**

Connect an S video cord (not supplied). When using the S video jack instead of the video jacks, your TV monitor must also be connected via an S video jack. S video signals are on a separate bus from the video signals and will not be output through the video jacks.



### **C To connect to a TV with the COMPONENT VIDEO IN jacks**

Connect a component video cord (not supplied). To use the COMPONENT VIDEO OUT jacks (Y, Pb/Cb, Pr/Cr) instead of the video jacks, your TV monitor must be equipped with via COMPONENT VIDEO IN jacks (Y, Pb/Cb, Pr/Cr). If your TV accepts progressive format signals, you must use this connection and set the output channel of the system to progressive format (page 94).



### **To connect to a TV with the HDMI (high-definition multimedia interface)/DVI (digital visual interface) IN jack**

Use a certified HDMI (high-definition multimedia interface) cord (not supplied) to enjoy high quality digital picture and sound through the HDMI OUT (high-definition multimedia interface out) jack. Note that Super Audio CD sound is not output from the HDMI OUT (high-definition multimedia interface out) jack.



- 1 Remove the control unit stand cover and the HDMI jack cover from the control unit.

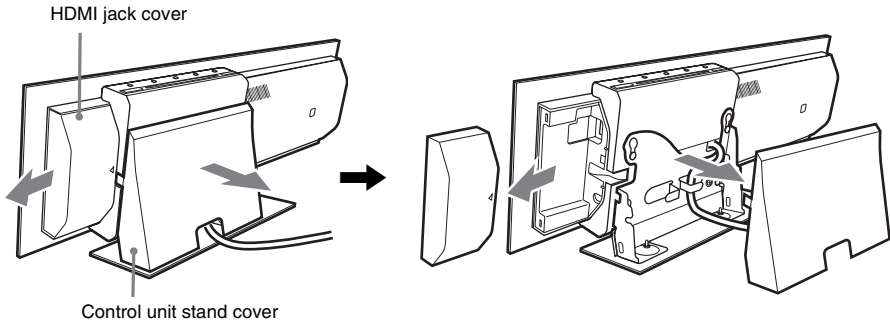

continued

**2** Connect the HDMI cord.

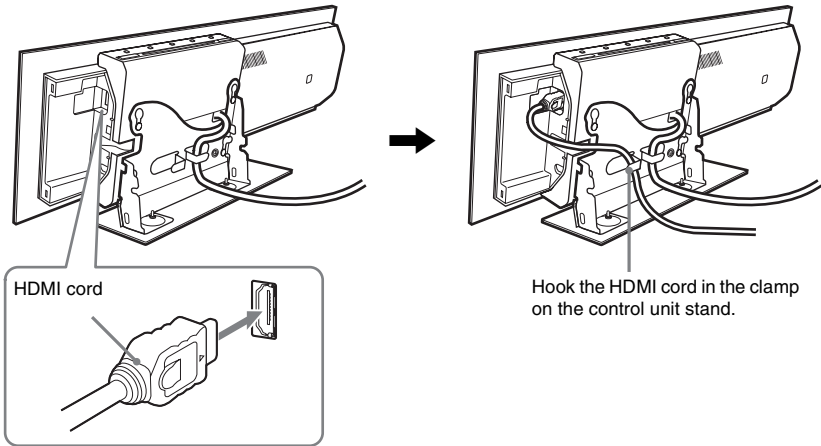

**3** Attach the control unit stand cover and the HDMI jack cover to the control unit.

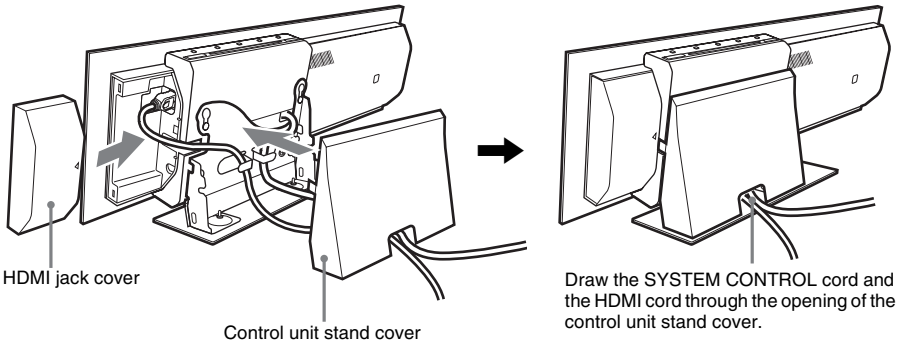

**4** Connect the HDMI cord to the TV.

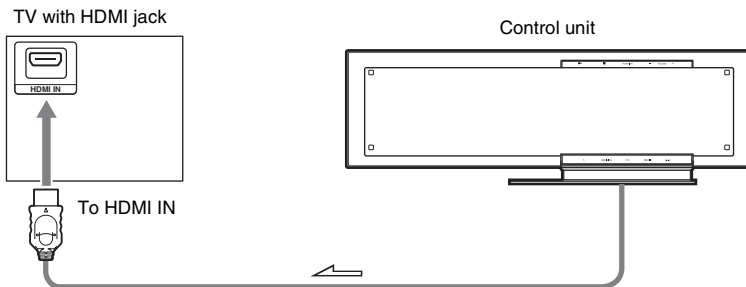

### To connect to a TV with DVI (digital visual interface) input

Use an HDMI (high-definition multimedia interface)-DVI (digital visual interface) converter cord (not supplied) with an HDMI (high-definition multimedia interface)-DVI (digital visual interface) adaptor (not supplied). The DVI (digital visual interface) jack will not accept any audio signals. Furthermore, you cannot connect the HDMI OUT (high-definition multimedia interface out) jack to DVI (digital visual interface) jacks that are not HDCP (high-bandwidth digital content protection) compliant (e.g., DVI (digital visual interface) jacks on PC displays).

## Connecting the TV with the digital optical cord

The TV with the digital optical out jack (such as the TV that has digital satellite tuner, etc.) can be connected to the TV (DIGITAL IN OPTICAL) jack instead of the TV (AUDIO IN) jacks of the rear of the subwoofer.

The system can accept both the digital and analog signals. Digital signals have priority over analog signals. If the digital signal ceases, the analog signal will be processed after 2 seconds.

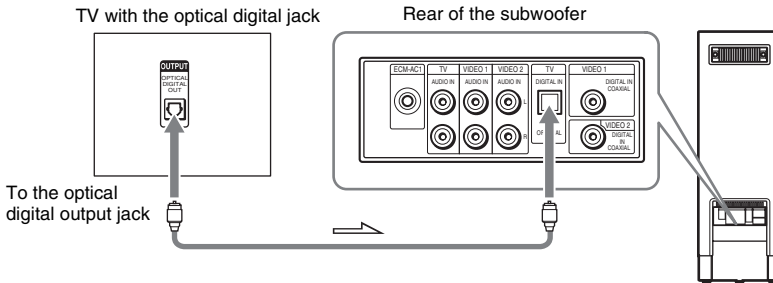

#### Tip

- When connecting the digital optical cord, insert the connector until it clicks.

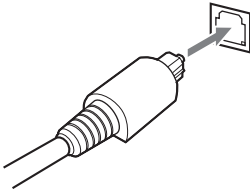

## Other Component Hookup

You can enjoy other component by connecting the VIDEO/AUDIO OUT jacks of another component.

### Connecting the system and the other component

Outputs the other component through the speakers of this system.

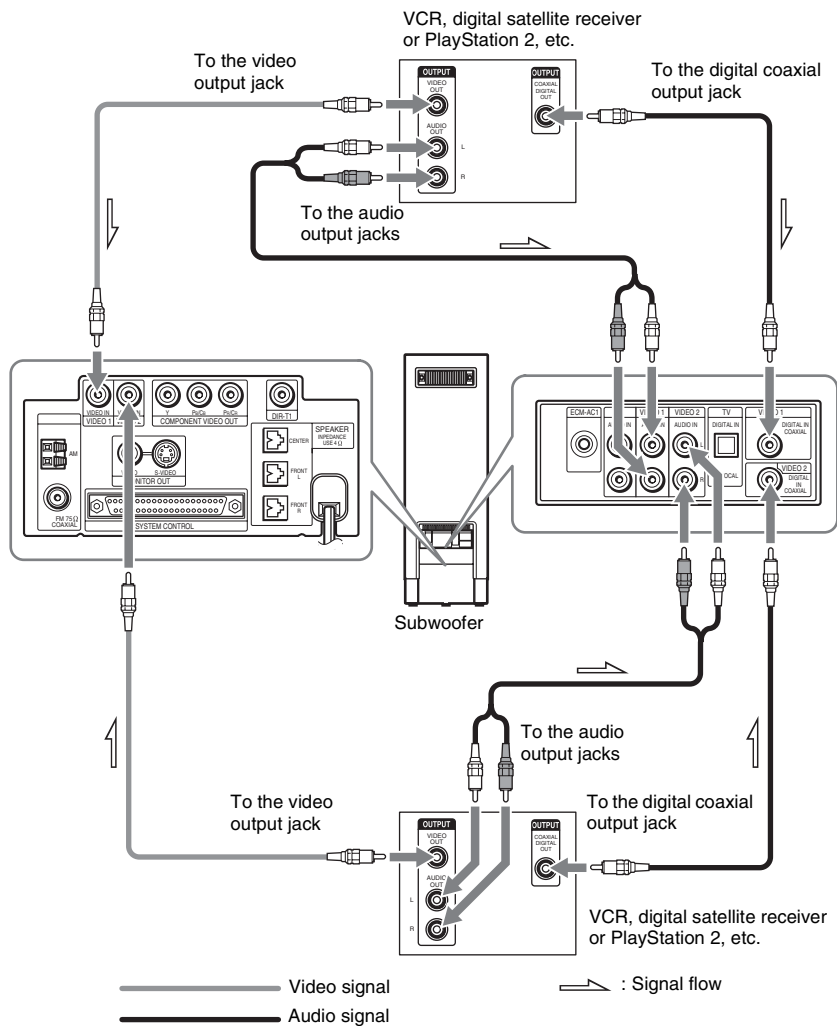

#### Note

- Make sure that the connected jack combinations are correct; if you connect the audio cords to VIDEO 1 (AUDIO IN), you should connect the video cord to VIDEO 1 (VIDEO IN).



**Tip**

- When you connect both the analogue and digital cord for the VIDEO 1 or 2 connection, the digital signals have priority over the analogue signals.

### To connect the VIDEO OUT jacks of other component to the VIDEO 1 or 2 (VIDEO IN) jacks of this system

Connect the VCR or other components to the VIDEO 1 or 2 (VIDEO IN) jacks using the video cord.

**Note**

- The video signal that is input from the VIDEO IN jack is not output from the S VIDEO OUT jack.

### To connect the AUDIO OUT jacks of other component to the VIDEO 1 or 2 (AUDIO IN) jacks of this system

Connect the VCR or other components to the VIDEO 1 or 2 (AUDIO IN) jacks using the audio cord (not supplied). When connecting a cord, be sure to match the color-coded sleeves to the appropriate jacks on the components.

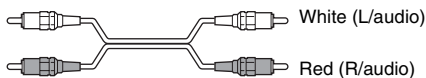

### If you connect a digital satellite receiver with an DIGITAL OUT (COAXIAL) jack

The digital satellite receiver can be connected to the VIDEO 1 or 2 (DIGITAL IN COAXIAL) jack instead of the VIDEO 1 or 2 (AUDIO IN) jacks of the system.

The system can accept both the digital and analog signals. Digital signals have priority over analog signals. If the digital signal ceases, the analog signal will be processed after 2 seconds.



### If you connect a digital satellite receiver without an DIGITAL OUT jack

Connect the digital satellite receiver to the VIDEO 1 or 2 jacks only of the system.

**Note**

- Be sure to make connections securely to avoid hum and noise.

## Basic Operations

### Playing Discs

DVD-V DVD-VR VIDEO CD Super Audio CD C D DATA-CD DATA DVD

Depending on the DVD or VIDEO CD, some operations may be different or restricted. Refer to the operation details supplied with your disc.

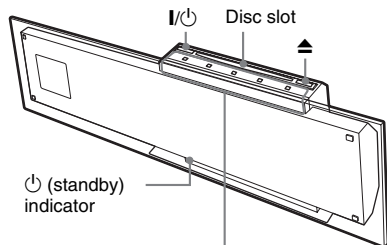

#### Soft-touch buttons/indicators

(▶/■)/FUNCTION/VOLUME +/-

These buttons function when the soft-touch button indicators are lit. When any soft-touch button is touched, the indicators light up, then touch the desired button.

#### Note

- These buttons work by touching lightly. Do not press them strongly.
- The soft-touch button indicators turn off when you do not press the soft-touch buttons for several seconds.

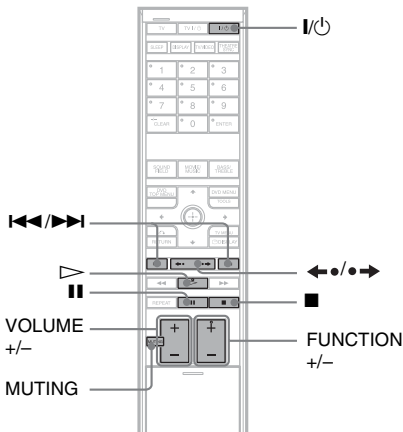

- 1 Turn on your TV.**
- 2 Switch the input selector on the TV to this system.**
- 3 Press I/⏻ on the control unit.**

The system turns on.

Unless the mode of the system is set to "DVD," press FUNCTION +/- on the remote or FUNCTION (soft-touch button) on the control unit to select "DVD."

"No Disc" appears in the front panel display and the system is ready for loading the disc.

- 4 Load a disc.**

Push the disc into the disc slot until the disc is pulled in automatically.

Labeled side facing to the front

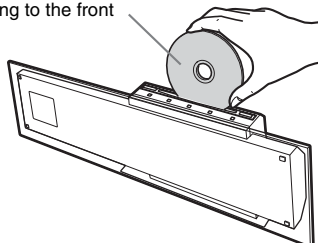

The disc is drawn into the control unit automatically and the following indication appears in the front panel display.

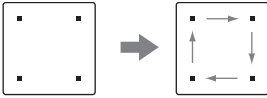



## 5 Press on the remote or (soft-touch button) on the control unit.











The system starts playback (continuous play).

Adjust the volume on the remote or touch VOLUME +/- (soft-touch button) on the control unit.

### To save the power in standby mode

Press  while the system turns on. To cancel standby mode, press  once.

### Additional operations

To	Press
Stop	 on the remote or  (soft-touch button) on the control unit.
Pause	
Resume play after pause	 or 
Go to the next chapter, track, or scene	 (except for JPEG)
Go back to the preceding chapter, track, or scene	 (except for JPEG)
Mute the sound	MUTING. To cancel muting, press it again or VOLUME + to adjust the sound volume.
Stop play and remove the disc	
Replay the previous scene*	 (instant replay) during playback.
Briefly fast forward the current scene**	 (instant advance) during playback.

\* DVD VIDEOS/DVD-RWs/DVD-Rs only.

\*\* DVD VIDEOS/DVD-RWs/DVD-Rs/DVD+RWs/DVD+Rs only.

#### Note

- You may not be able to use the Instant Replay or Instant Advance function with some scenes.

## Enjoying the Radio or Other Components

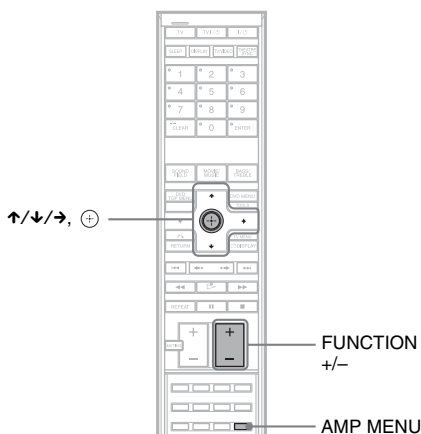

With the cover opened.

### Selecting the connected component

You can use a TV, VCR, or other components connected to the TV, VIDEO 1, or VIDEO 2 jacks on the subwoofer. Refer to the operation manual supplied with the components for further information on the operation.

**Press FUNCTION +/- repeatedly until "TV," "VIDEO 1," or "VIDEO 2" appears in the front panel display.**

Each time you press FUNCTION +/-, the mode of the system changes in the following sequence.

DVD → FM → AM → TV → VIDEO 1 → VIDEO 2 → DVD → ...

#### Note

- When you use both the TV (AUDIO IN) jacks (analog connection) and TV (DIGITAL IN OPTICAL) jack (digital connection), or the VIDEO 1 or 2 (AUDIO IN) jacks (analog connection) and VIDEO 1 or 2 (DIGITAL IN COAXIAL) jack (digital connection) at the same time, the digital connection takes priority.

### Changing the input level of the sound from connected components

You can change the input sensitivity of the AUDIO IN (VIDEO 1, VIDEO2, TV) jacks on the rear panel.

- 1** Press FUNCTION +/- repeatedly until "TV," "VIDEO 1," or "VIDEO 2" appears in the front panel display.
- 2** Press AMP MENU.
- 3** Press ↑/↓ repeatedly until "ATTENUATE" appears in the front panel display, then press ⊕ or →.

**4 Press ↑/↓ to select a setting.**

The default setting is underlined.

- ON: attenuates the input level. Set this if distortion occurs during listening.
- OFF: normal input level. Set this if the input level is low.

**5 Press ⊕.****6 Press AMP MENU.**

The AMP menu turns off.

## Enjoying TV or VCR Sound from All Speakers

You can enjoy TV or VCR sound from all the speakers in this system.

For details, see “TV Hookup (Advanced)” (page 36) and “Other Component Hookup” (page 40).

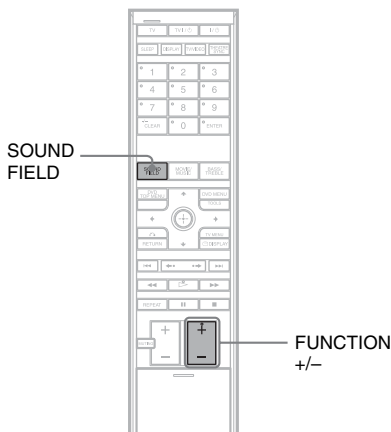

- 1** Press **FUNCTION +/-** repeatedly until “TV,” “VIDEO 1,” or “VIDEO 2” appears in the front panel display.
- 2** Press **SOUND FIELD** repeatedly until the sound field you want appears in the front panel display.

When you want to output the TV sound or stereo sound of a 2 channel source from the 6 speakers, select the “Pro Logic II Movie” or “Pro Logic II Music” sound field.

For details of sound field, see page 48.

### Note

- When you use both the TV (AUDIO IN) jacks (analog connection) and TV (DIGITAL IN OPTICAL) jack (digital connection), or the VIDEO 1 or 2 (AUDIO IN) jacks (analog connection) and VIDEO 1 or 2 (DIGITAL IN COAXIAL) jack (digital connection) at the same time, the digital connection takes priority.

# Selecting the Movie or Music Mode

DVD-V

DVD-VR

VIDEO CD

Super Audio CD

C D

DATA-CD

DATA DVD

You can choose a suitable sound mode for movies or music.

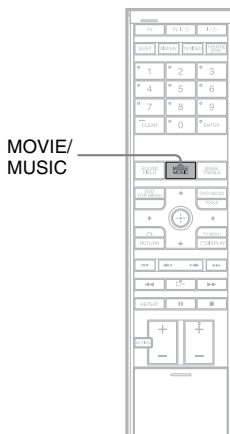

## Press MOVIE/MUSIC during playback.

Press MOVIE/MUSIC repeatedly until the mode you want appears in the front panel display. The default setting is underlined.

- Auto: selects the mode automatically to produce the sound effect depending on the disc.
- Movie: provides the sound for movies.
- Music: provides the sound for music.

### Tip

- When the movie or music mode is selected, “MOVIE” or “MUSIC” is displayed in the front panel display.

## Sound Adjustments

# Enjoying Surround Sound by Using Sound Field

DVD-V

DVD-VR

VIDEO CD

C D

DATA-CD

DATA DVD

You can take advantage of surround sound simply by selecting one of system's pre-programmed sound fields. They bring the exciting and powerful sound of movie theaters into your home.

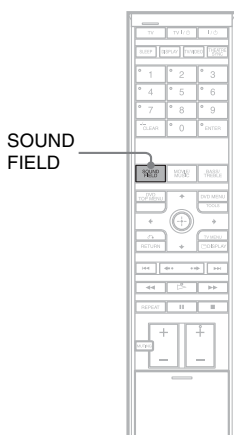

### Press SOUND FIELD.

Press SOUND FIELD repeatedly until the sound field you want appears in the front panel display.

### All sound field

Sound field	Display
AUTO FORMAT DIRECT STANDARD	Auto Format Direct Standard
AUTO FORMAT DIRECT MULTI	Auto Format Direct Multi
Dolby Pro Logic II MOVIE	Pro Logic II Movie
Dolby Pro Logic II MUSIC	Pro Logic II Music
CINEMA STUDIO EX	Cinema Studio EX*
LIVE CONCERT	Live Concert
SPORTS STADIUM	Sports Stadium

Sound field	Display
PORTABLE AUDIO	Portable Audio
ENHANCER	Enhancer
2 CHANNEL STEREO	2Channel Stereo

\* Use DCS Technology

## Automatic outputting of the original sound

### ■ AUTO FORMAT DIRECT STANDARD

The auto decoding function automatically detects the type of audio signal being input (Dolby Digital, DTS, or standard 2 channel stereo) and performs the proper decoding if necessary. This mode presents the sound as it was recorded/encoded, without adding any effects (e.g. reverberation).

However, if there are no low frequency signals (Dolby Digital LFE, etc.), it will generate a low frequency signal for output to the subwoofer.

## Outputting the sound from multiple speakers

### ■ AUTO FORMAT DIRECT MULTI

This mode lets you enjoy audio playback of all types of discs from multiple speakers.

#### Note

- The sound is not output from multiple speakers depending on the source.

## Outputting 2 channel sources like CDs by 5.1 channel

### ■ Dolby Pro Logic II MOVIE/MUSIC

Dolby Pro Logic II produces five full-bandwidth output channels from 2 channel sources. This is done using an advanced, high-purity matrix surround decoder that extracts the spatial properties of the original recording without adding any new sounds or tonal colorations.

#### Note

- When the input signal is multi channel source, "Dolby Pro Logic II Movie/Music" are canceled and the multi channel source is output directly.
- When the bilingual broadcast sound is input, "Dolby Pro Logic II Movie/Music" are not effective.



## Enjoying Digital Cinema Sound

### About DCS (Digital Cinema Sound)

In collaboration with Sony Pictures Entertainment, Sony measured the sound environment of their studios and integrated the data of the measurement and Sony's own DSP (Digital Signal Processor) technology to develop "Digital Cinema Sound." "Digital Cinema Sound" simulates in a home theater an ideal movie theater sound environment based on the preference of the movie director.

#### ■ CINEMA STUDIO EX

Reproduces the sound characteristics of the Sony Pictures Entertainment "Kim Novak Theater" cinema production studio. This mode is ideal for watching science-fiction or action movies with lots of sound effects.

### About Cinema Studio EX

Cinema Studio EX is ideal for enjoying the movie software encoded with multi channel format, such as the Dolby Digital DVD. This mode reproduces the sound characteristics of Sony Pictures Entertainment's studios. Cinema Studio EX consists of the following 3 elements.

- Virtual Multi Dimension  
Creates 5 sets of virtual speakers surrounding the listener from a single pair of actual surround speakers.
- Screen Depth Matching  
In a movie theater, sound seems to come from inside the image reflected on the movie screen. This element creates the same sensation in your listening room by shifting the sound of the front speakers "into" the screen.
- Cinema Studio Reverberation  
Reproduces the reverberations peculiar to a movie theater. Cinema Studio EX is the integrated mode which operates these elements simultaneously.

#### Note

- The virtual speaker effect may cause increased noise in the playback signal.

- When listening with sound fields that employ virtual speakers, you will not be able to hear any sound coming directly from the surround speakers.

## Enjoying the surround sound

#### ■ LIVE CONCERT

This mode reproduces the acoustics of a 300-seats live house.

#### ■ SPORTS STADIUM

This mode reproduces the feeling of a large open-air stadium.

#### ■ PORTABLE AUDIO ENHANCER

This mode reproduces a clear enhanced sound image from your portable audio device. This mode is ideal for MP3 and other compressed music.

## Using only the front speaker and subwoofer

#### ■ 2 CHANNEL STEREO

This mode outputs the sound from the front left and right speakers and subwoofer. Standard 2 channel (stereo) sources completely bypass the sound field processing. Multi channel surround formats are downmixed to two channels. This allows you to play any source using only the front left and right speakers and subwoofer.

### To turn the surround effect off

Press SOUND FIELD repeatedly until "Auto Format Direct Standard" or "2Channel Stereo" appears in the front panel display.

#### Tip

- The system memorizes the last sound field selected for each function mode.

# Adjusting the Bass and Treble Level

You can adjust the bass and treble level easily.

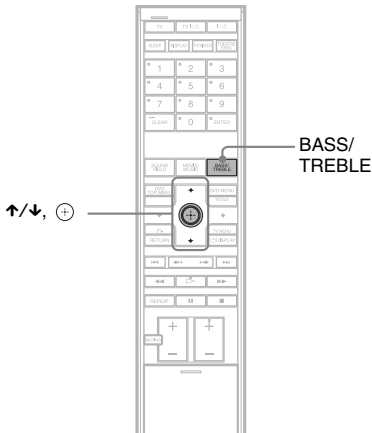

**1 Press BASS/TREBLE repeatedly until “Bass Level” or “Treble Level” appears in the front panel display.**

- Bass Level: adjusts the bass level (-6 – +6, 1 increments).
- Treble Level: adjusts the treble level (-6 – +6, 1 increments).

**2 Press ↑/↓ to adjust.**

The adjusted value appears in the front panel display.

**3 Press ⊕.**

## Various Functions for Playing Discs

# Searching for a Particular Point on a Disc

*(Scan, Slow-motion Play, Freeze Frame)*

DVD-V DVD-VR VIDEO CD Super Audio CD CD

DATA-CD DATA DVD

You can quickly locate a particular point on a disc by monitoring the picture or playing back slowly.

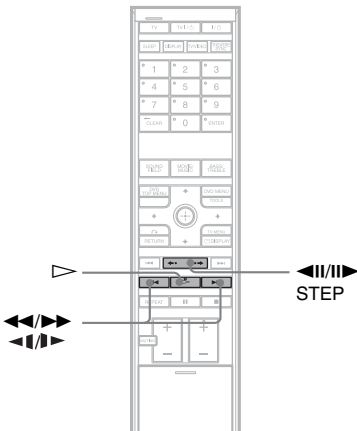

### Note

• Depending on the DVD/VIDEO CD, you may not be able to do some of the operations described.

## Locating a point quickly by playing a disc in fast forward or fast reverse (Scan)

**(except for JPEG)**

Press  $\lll$  or  $\ggg$  while playing a disc. When you find the point you want, press  $\triangleright$  to return to normal speed. Each time you press  $\lll$  or  $\ggg$  during scan, the playback speed changes. With each press the indication changes as shown below. Actual speeds may differ with some discs.

Playback direction

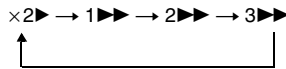

$\ggg$  (DVD VIDEO/DVD-VR mode/VIDEO CD only)

$\ggg$  (DVD VIDEO/Super Audio CD/CD only)

Opposite direction

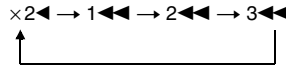

$\lll$  (DVD VIDEO/DVD-VR mode/VIDEO CD only)

$\lll$  (DVD VIDEO only)

With each press, playback speed becomes faster.

## Watching frame by frame (Slow-motion Play)

**(DVD VIDEO, DVD-RW, VIDEO CD only)**

Press  $\lll$  or  $\ggg$  when the system is in pause mode. To return to the normal playback speed, press  $\triangleright$ . Each time you press  $\lll$  or  $\ggg$  during Slow-motion Play, the playback speed changes. Two speeds are available. With each press the indication changes as follows:

Playback direction

$\ggg \leftrightarrow \ggg$

Opposite direction (DVD VIDEO/DVD-RW only)

$\lll \leftrightarrow \lll$

## Playing one frame at a time (Freeze Frame)

**(except for Super Audio CD, CD, MP3, and JPEG)**

When the system is in the pause mode, press  $\lll$  STEP to go to the next frame. Press  $\ggg$  STEP to go to the preceding frame (DVD VIDEO/DVD-RW only). To return to normal playback, press  $\triangleright$ .

### Note

• You cannot search for a still picture on a DVD-R/ DVD-RW in VR mode.

# Searching for a Title/ Chapter/Track/Scene, etc.



You can search a DVD by title or chapter, and you can search a VIDEO CD/Super Audio CD/CD/DATA CD/DATA DVD by track, index, or scene. As titles and tracks are assigned unique numbers on the disc, you can select the desired one by entering its number. Or, you can search for a scene using the time code.

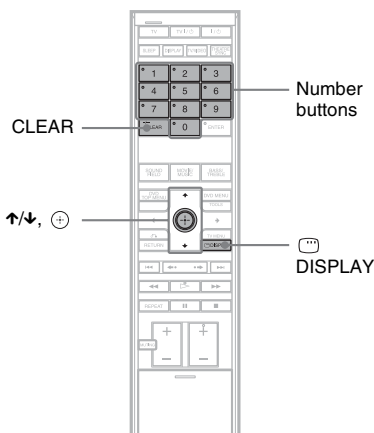

**1** Press DISPLAY. (When playing a DATA CD/DATA DVD with JPEG image files, press DISPLAY twice.)

The Control Menu appears.

**2** Press to select the search method.

■ When playing a DVD VIDEO/DVD-RW

[TITLE]

[CHAPTER]

[TIME/TEXT]

Select [TIME/TEXT] to search for a starting point by inputting the time code.

■ When playing a VIDEO CD/Super VCD without PBC Playback

[TRACK]

[INDEX]

■ When playing a VIDEO CD/Super VCD with PBC Playback

[SCENE]

■ When playing a Super Audio CD

[TRACK]

[INDEX]

■ When playing a CD

[TRACK]

■ When playing a DATA CD (MP3 audio)

[ALBUM]

[TRACK]

■ When playing a DATA CD (JPEG file)

[ALBUM]

[FILE]

Example: when you select [CHAPTER]

[\*\* (\*\*)] is selected (\*\* refers to a number).

The number in parentheses indicates the total number of titles, chapters, tracks, indexes, scenes, albums or files.

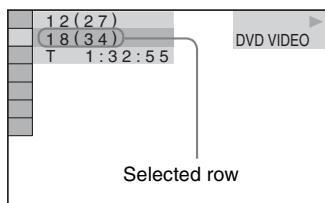

**3** Press **+**.

[\*\* (\*\*)] changes to [- - (\*\*)].

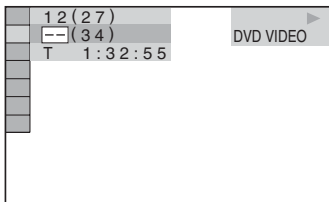

**4** Press **↑/↓** or the number buttons to select the title, chapter, track, index, scene, etc., number you want to search for.

**If you make a mistake**

Cancel the number by pressing CLEAR, then select another number.

**5** Press **+**.

The system starts playback from the selected number.

**To search for a scene using the time code (DVD VIDEO and DVD-VR mode only)**

**1** In Step 2, select **[TIME/TEXT]**.  
[T \*\*: \*\*: \*\*: \*\*] (playing time of the current title) is selected.

**2** Press **+**.  
[T \*\*: \*\*: \*\*: \*\*] changes to [T - -: - -: -:].

**3** Input the time code using the number buttons, then press **+**.  
For example, to find the scene at 2 hours, 10 minutes, and 20 seconds after the beginning, just enter [2:10:20].

**Tip**  
• When the Control Menu display is turned off, you can search for a chapter (DVD VIDEO/DVD-RW) or track (VIDEO CD/Super Audio CD/CD) by pressing the number buttons and **+**.

**Note**  
• You cannot search for a scene on a DVD+RW/DVD+R using the time code.

**Searching by Scene**

**(Picture Navigation)**

**DVD-V VIDEO CD**

You can divide the screen into 9 subscreens and find the desired scene quickly.

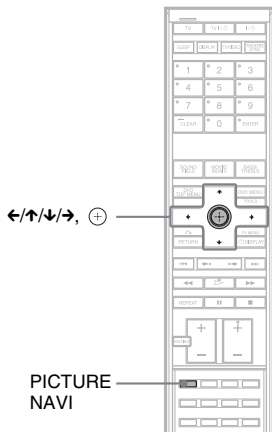

With the cover opened.

**1** Press **PICTURE NAVI** during playback. The following display appears.

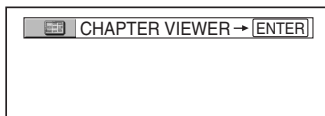

**2** Press **PICTURE NAVI** repeatedly to select an item.

- [TITLE VIEWER] (DVD VIDEO only)
- [CHAPTER VIEWER] (DVD VIDEO only)
- [TRACK VIEWER] (VIDEO CD/Super VCD only)

### 3 Press $\oplus$ .

The first scene of each title, chapter, or track appears as follows.

1	2	3
4	5	6
7	8	9

### 4 Press $\leftarrow/\uparrow/\downarrow/\rightarrow$ to select a title, chapter, or track, and press $\oplus$ .

Playback starts from the selected scene.

### To return to normal play during setting

Press  $\leftarrow$  RETURN or  $\text{DISP}$  DISPLAY.

#### Note

- Depending on the disc, you may not be able to select some items.

## Resuming Playback from the Point Where You Stopped the Disc

### (Resume Play)

DVD-V DVD-VR VIDEO CD Super Audio CD C D  
DATA-CD DATA DVD

When you stop the disc, the system remembers the point where you pressed  $\blacksquare$  and “Resume” appears in the front panel display. As long as you do not remove the disc, Resume Play will work even if the system enters standby mode by pressing  $\text{I/O}$ .

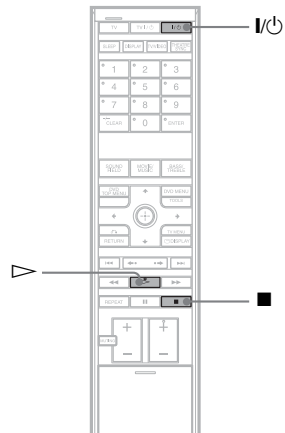

### 1 While playing a disc, press $\blacksquare$ to stop playback.

“Resume” appears in the front panel display.

If “Resume” does not appear, Resume Play is not available.

### 2 Press $\blacktriangleright$ .

The system starts playback from the point where you stopped the disc in Step 1.

## To enjoy a disc that is played before by resume playback (Multi-disc Resume) (DVD VIDEO, VIDEO CD only)

This system stores the point where you stopped the disc for up to 40 discs and resumes playback the next time you insert the same disc. If you store a resume playback point for the 41st disc, the resume playback point for the first disc is deleted.

To activate this function, set [MULTI-DISC RESUME] in [CUSTOM SETUP] to [ON]. For details, see “[MULTI-DISC RESUME] (DVD VIDEO/VIDEO CD only)” (page 96).

### Tip

- To play from the beginning of the disc, press **■** twice, then press **▷**.

### Note

- If [MULTI-DISC RESUME] in [CUSTOM SETUP] is set to [OFF] (page 96), the resume point is cleared when you change the function by pressing FUNCTION +/-.
- Depending on where you stop the disc, the system may not resume playback from exactly the same point.
- The point where you stopped playing may be cleared when:
  - you eject the disc.
  - the system enters standby mode (DATA CD/DATA DVD only).
  - you change or reset the settings on the Setup Display.
  - you change the function by pressing FUNCTION +/-.
  - you disconnect the AC power cord (mains lead).
- For DVD-Rs/DVD-RWs in VR mode, VIDEO CDs, CDs, Super Audio CDs, DATA CDs, and DATA DVDs, the system remembers the resume playback point for the current disc.
- Resume Play does not work during Program Play and Shuffle Play.
- This function may not work properly with some discs.

## Creating Your Own Program

### (Program Play)

**VIDEO CD** **Super Audio CD** **CD**

You can play the contents of a disc in the order you want by arranging the order of the tracks on the disc to create your own program. You can program up to 99 tracks.

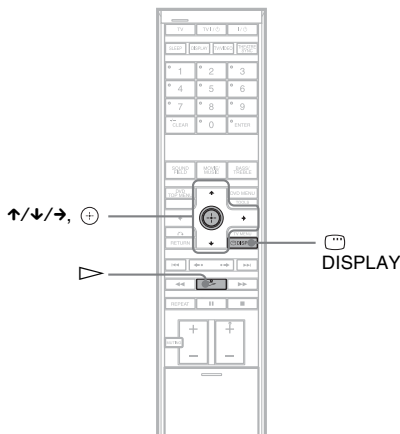

### 1 Press **DISPLAY**.

The Control Menu appears.

### 2 Press **↑/↓** to select **[PROGRAM]**, then press **+**.

The options for [PROGRAM] appear.

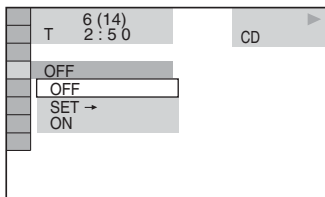

- 3** Press  $\uparrow/\downarrow$  to select [SET  $\rightarrow$ ], then press  $\oplus$ .

[TRACK] is displayed when you play a VIDEO CD, Super Audio CD, or CD.

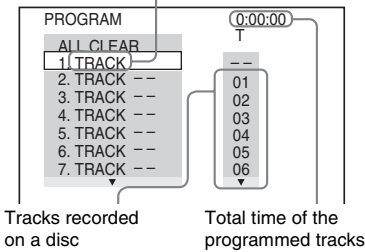

- 4** Press  $\rightarrow$ .  
The cursor moves to the track row [T] (in this case, [01]).

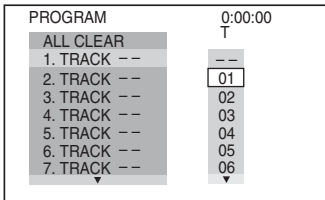

- 5** Select the track you want to program.  
For example, select track [02].  
Press  $\uparrow/\downarrow$  to select [02] under [T], then press  $\oplus$ . The track number may be displayed in 3 digits for a Super Audio CD.

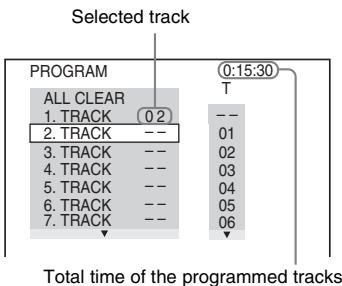

- 6** To program other tracks, repeat steps 4 to 5.  
The programmed tracks are displayed in the selected order.

- 7** Press  $\triangleright$  to start Program Play.  
Program Play starts.  
When the program ends, you can restart the same program again by pressing  $\triangleright$ .

**To return to normal play**

Press CLEAR, or select [OFF] in Step 3. To play the same program again, select [ON] in Step 3 and press  $\oplus$ .

**To turn off the Control Menu**

Press  $\text{☺}$  DISPLAY repeatedly until the Control Menu is turned off.

**To change or cancel a program**

- Follow steps 1 to 3 of "Creating Your Own Program."
- Select the program number of the track you want to change or cancel using  $\uparrow/\downarrow$ . If you want to delete the track from the program, press CLEAR.
- Follow Step 5 for new programming. To cancel a program, select [--] under [T], then press  $\oplus$ .

**To cancel all of the tracks in the programmed order**

- Follow steps 1 to 3 of "Creating Your Own Program."
- Press  $\uparrow$  and select [ALL CLEAR].
- Press  $\oplus$ .



# Playing in Random Order

## (Shuffle Play)

VIDEO CD Super Audio CD CD DATA-CD DATA DVD

You can have the system “shuffle” tracks. Subsequent “shuffling” may produce a different playing order.

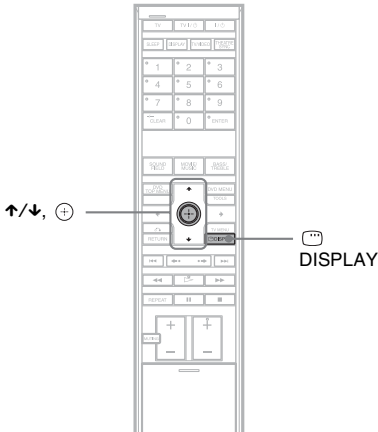

### Note

• Same song may be played repeatedly during MP3 playback.

**1** Press **DISPLAY** during playback. The Control Menu appears.

**2** Press **↑/↓** to select **[SHUFFLE]**, then press **⊕**.

The options for [SHUFFLE] appear.

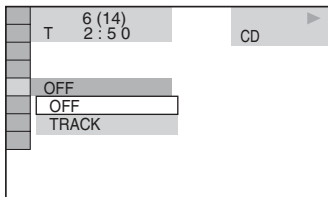

**3** Press **↑/↓** to select the item to be shuffled.

■ When playing a VIDEO CD, Super Audio CD, or CD

• [TRACK]: shuffles tracks on the disc.

■ When Program Play is activated

• [ON]: shuffles tracks selected in Program Play.

■ When playing a DATA CD or DATA DVD

• [ON]: shuffles MP3 audio tracks in the album on the current disc. When no album is selected, the first album will play in random order.

### Note

• A track already played is also selected in random order.

**4** Press **⊕**.

Shuffle Play starts.

## To return to normal play

Press CLEAR, or select [OFF] in Step 3.

## To turn off the Control Menu

Press **DISPLAY** repeatedly until the Control Menu is turned off.

### Note

• You cannot use this function with VIDEO CDs and Super VCDs with PBC playback.

# Playing Repeatedly

## (Repeat Play)

**DVD-V**   **DVD-VR**   **VIDEO CD**   **Super Audio CD**   **CD**

**DATA-CD**   **DATA DVD**

You can play all the titles, tracks or albums on a disc or a single title, chapter, track, or album repeatedly.

You can use a combination of Shuffle or Program Play modes.

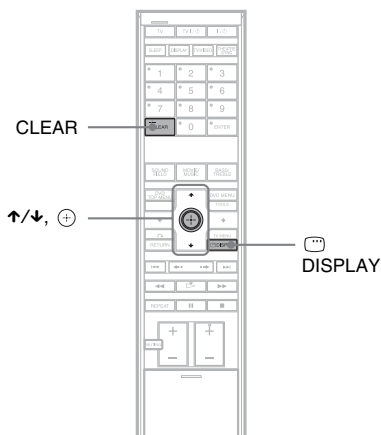

### 1 Press DISPLAY during playback.

The Control Menu appears.

### 2 Press to select [REPEAT], then press .

The options for [REPEAT] appear.

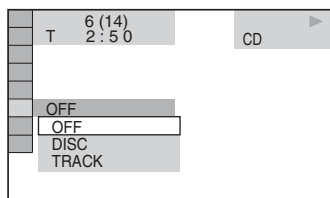

### 3 Press to select the item to be repeated.

The default setting is underlined.

#### ■ When playing a DVD VIDEO or DVD-VR

- [OFF]: does not play repeatedly.
- [DISC]: repeats all of the titles on the disc.
- [TITLE]: repeats the current title on a disc.
- [CHAPTER]: repeats the current chapter.

#### ■ When playing a VIDEO CD, Super Audio CD, or CD

- [OFF]: does not play repeatedly.
- [DISC]: repeats all of the tracks on the disc.
- [TRACK]: repeats the current track.

#### ■ When playing a DATA CD or DATA DVD

- [OFF]: does not play repeatedly.
- [DISC]: repeats all of the albums on the disc.
- [ALBUM]: repeats the current album.
- [TRACK] (MP3 audio tracks only): repeats the current track.

### 4 Press .

The item is selected.

To return to normal play, press CLEAR, or select [OFF] in Step 3.

## To turn off the Control Menu

Press  DISPLAY repeatedly until the Control Menu is turned off.

#### Note

- You can quickly display the [REPEAT] status. Press REPEAT on the remote.
- You cannot use this function with VIDEO CDs and Super VCDs with PBC playback.
- When playing a DATA CD/DATA DVD which contains MP3 audio track and JPEG image files, and their playing time are not the same, the audio sound will not match the image.
- When [MODE (MP3, JPEG)] is set to [IMAGE (JPEG)] (page 71), you cannot select [TRACK].

## Using the DVD's Menu

### DVD-V

A DVD is divided into a lot of sections, which make up a picture or music feature. These sections are called "titles." When you play a DVD which contains several titles, you can select the title you want using DVD TOP MENU.

When you play DVDs that allow you to select items such as the language for the subtitles and the language for the sound, select these items using DVD MENU.

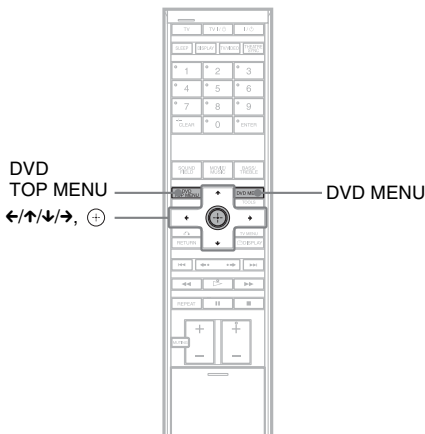

- 1 Press DVD TOP MENU or DVD MENU.**  
The disc's menu appears on the TV screen. The contents of the menu vary from disc to disc.
- 2 Press ←/↑/↓/→ or the number buttons to select the item you want to play or change.**
- 3 Press +.**

## Changing the Sound

### DVD-V

### DVD-VR

### VIDEO CD

### C D

### DATA-CD

### DATA DVD

When playing a DVD VIDEO recorded in multiple audio formats (PCM, Dolby Digital, MPEG audio, or DTS), you can change the audio format. If the DVD VIDEO is recorded with multilingual tracks, you can also change the language.

With VIDEO CDs, CDs, DATA CDs, or DATA DVDs, you can select the sound from the right or left channel and listen to the sound of the selected channel through both the right and left speakers.



With the cover opened.

- 1 Press AUDIO during playback.**  
The following display appears.

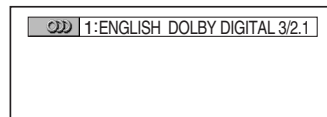

- 2 Press AUDIO repeatedly to select the desired audio signal.**

### ■ When playing a DVD VIDEO

Depending on the DVD VIDEO, the choice of language varies.

When 4 digits are displayed, they indicate a language code. Refer to “Language Code List” (page 113) to see which language the code represents. When the same language is displayed two or more times, the DVD VIDEO is recorded in multiple audio formats.

### ■ When playing a DVD-VR

The types of sound tracks recorded on a disc are displayed. The default setting is underlined.

Example:

- [1: MAIN] (main sound)
- [1: SUB] (sub sound)
- [1: MAIN+SUB] (main and sub sound)
- [2: MAIN]
- [2: SUB]
- [2: MAIN+SUB]

#### Note

- [2: MAIN], [2: SUB], and [2: MAIN+SUB] do not appear when one audio stream is recorded on the disc.

### ■ When playing a VIDEO CD, CD, DATA CD (MP3 audio), or DATA DVD (MP3 audio)

The default setting is underlined.

- [STEREO]: the standard stereo sound
- [1/L]: the sound of the left channel (monaural)
- [2/R]: the sound of the right channel (monaural)

### ■ When playing a Super VCD

The default setting is underlined.

- [1:STEREO]: the stereo sound of the audio track 1
- [1:1/L]: the sound of the left channel of the audio track 1 (monaural)
- [1:2/R]: the sound of the right channel of the audio track 1 (monaural)
- [2:STEREO]: the stereo sound of the audio track 2
- [2:1/L]: the sound of the left channel of the audio track 2 (monaural)
- [2:2/R]: the sound of the right channel of the audio track 2 (monaural)

#### Note

- While playing a Super VCD on which the audio track 2 is not recorded, no sound will come out when you select [2:STEREO], [2:1/L], or [2:2/R].
- You cannot change the sound for Super Audio CDs.

## Checking the audio signal format

### (DVD VIDEO only)

If you press AUDIO repeatedly during playback, the format of the current audio signal (PCM, Dolby Digital, DTS, etc.) appears as shown below.

### ■ When playing a DVD

#### Example:

Dolby Digital 5.1 ch

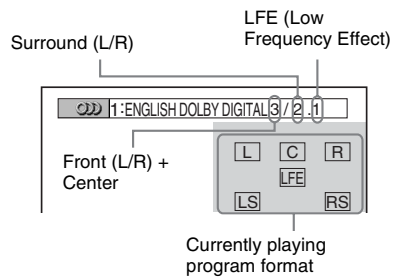

#### Example:

Dolby Digital 3 ch

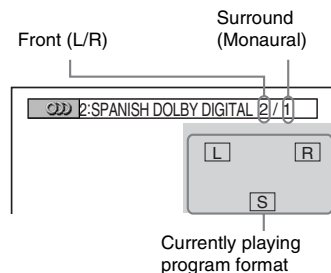

## About audio signals

Audio signals recorded in a disc contain the sound elements (channels) shown below. Each channel is output from a separate speaker.

- Front (L)
- Front (R)
- Center
- Surround (L)
- Surround (R)
- Surround (Monaural): This signal can be either the Dolby Surround Sound processed signals or the Dolby Digital sound's monaural Surround audio signals.
- LFE (Low Frequency Effect) signal

## Selecting [ORIGINAL] or [PLAY LIST] on a DVD-R/ DVD-RW

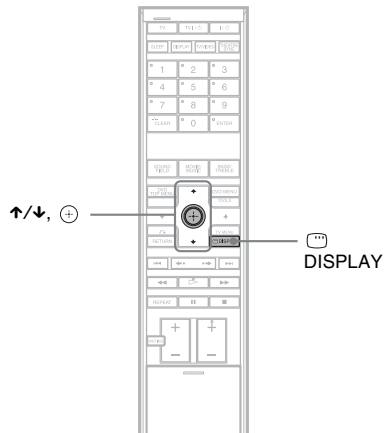

### DVD-VR

Some DVD-Rs/DVD-RWs in VR (Video Recording) mode have two types of titles for playback: originally recorded titles ([ORIGINAL]) and titles that can be created on recordable DVD players for editing ([PLAY LIST]). You can select the type of title to be played.



- 1** Press  **DISPLAY** when the system is in stop mode.

The Control Menu appears.

- 2** Press ↑/↓ to select  [ORIGINAL/PLAY LIST], then press .

The options for [ORIGINAL/PLAY LIST] appear.

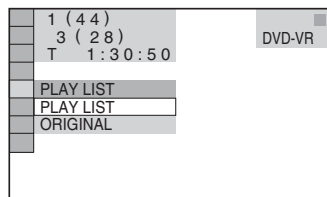

continued

### 3 Press $\uparrow/\downarrow$ to select a setting.

The default setting is underlined.

- PLAY LIST: plays the titles created from [ORIGINAL] for editing.
- [ORIGINAL]: plays the titles originally recorded.

### 4 Press $\oplus$ .

## Changing the Display Mode

### (INFORMATION MODE)

You can change the displayed information in the front panel display.

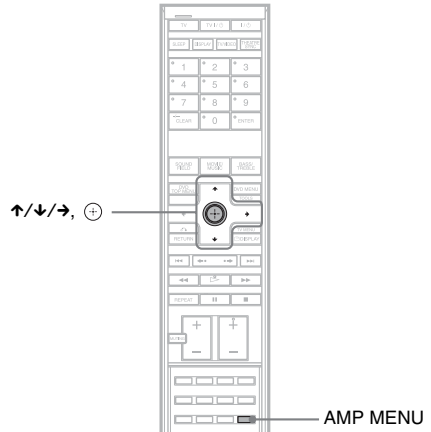

With the cover opened.

### 1 Press AMP MENU.

### 2 Press $\uparrow/\downarrow$ repeatedly until "INFORMATION MODE" appears in the front panel display, then press $\oplus$ or $\rightarrow$ .

### 3 Press $\uparrow/\downarrow$ to select a setting.

The default setting is underlined.

- DETAIL: displays information fully such as the kind of disc, track number, repeat mode information, radio frequency, etc., for the selected function. For details of the displayed information, see "Front Panel Display" (page 115).
- STANDARD: displays information such as the kind of disc, track number, etc., for the selected function (more basic than DETAIL).
- SIMPLE: displays the selected function name only.

### 4 Press $\oplus$ .

### 5 Press AMP MENU.

The AMP menu turns off.

## Viewing Information About the Disc

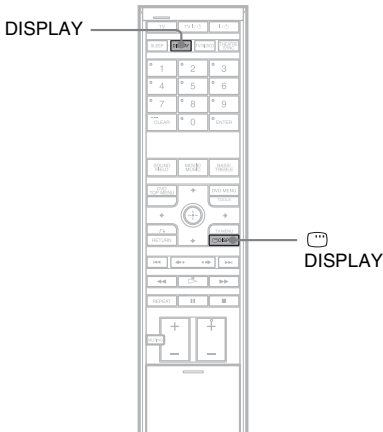

### Viewing the playing time and remaining time in the front panel display

You can check disc information, such as the remaining time, total number of titles in a DVD, tracks in a VIDEO CD, Super Audio CD, CD, or MP3 using the front panel display (page 115). Information appears only when “INFORMATION MODE” is set to “DETAIL” (page 62).

#### Press DISPLAY.

Each time you press DISPLAY while playing the disc, the display changes ① → ② → ... → ① → ...

Some displayed items may disappear after a few seconds.

#### When playing a DVD VIDEO or DVD-RW

- ① Playing time and number of the current title
- ② Remaining time and number of the current title

- ③ Playing time and number of the current chapter
- ④ Remaining time and number of the current chapter
- ⑤ Disc name
- ⑥ Title and chapter

#### When playing a VIDEO CD (without PBC functions), Super Audio CD, or CD

- ① Playing time and number of the current track
  - ② Remaining time and number of the current track
  - ③ Playing time of the disc
  - ④ Remaining time of the disc
  - ⑤ Disc name
  - ⑥ Track and index\*
- \* VIDEO CD only.

#### When playing a DATA CD (MP3 audio) or DATA DVD (MP3 audio)

- ① Playing time and number of the current track
- ② Track (file) name

#### Tip

- When playing VIDEO CDs with PBC functions, the playing time is displayed.

#### Note

- The system can only display the first level of the DVD/CD text, such as the Disc name or title.
- If an MP3 file name cannot be displayed, “\*” will appear in the front panel display instead.
- The disc name or track name may not be displayed depending on the text.
- Playing time of MP3 audio tracks may not be displayed correctly.

### Checking the playing time and remaining time

You can check the playing time and remaining time of the current title, chapter, or track, and the total playing time or remaining time of the disc. You can also check the DVD text and MP3 folder name/file name recorded on the disc.

# 1 Press DISPLAY during playback.

The following display appears.

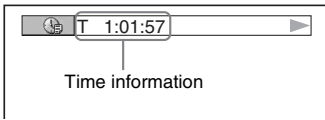

# 2 Press DISPLAY repeatedly to change the time information.

The display and the kinds of time that you can check depend on the disc you are playing.

## ■ When playing a DVD VIDEO or DVD-RW

- T \*\*: \*\*: \*\*  
Playing time of the current title
- T\_ \*\*: \*\*: \*\*  
Remaining time of the current title
- C \*\*: \*\*: \*\*  
Playing time of the current chapter
- C\_ \*\*: \*\*: \*\*  
Remaining time of the current chapter

## ■ When playing a VIDEO CD (with PBC functions)

- \*\*: \*\*: \*\*  
Playing time of the current scene

## ■ When playing a VIDEO CD (without PBC functions), Super Audio CD, or CD

- T \*\*: \*\*: \*\*  
Playing time of the current track
- T\_ \*\*: \*\*: \*\*  
Remaining time of the current track
- D \*\*: \*\*: \*\*  
Playing time of the current disc
- D\_ \*\*: \*\*: \*\*  
Remaining time of the current disc

## ■ When playing a DATA CD (MP3 audio) or DATA DVD (MP3 audio)

- T \*\*: \*\*: \*\*  
Playing time of the current track

### Note

- Only alphabetical letters and numbers can be displayed.
- Depending on the type of disc being played, the system can only display a limited number of characters. Also, depending on the disc, not all text characters will be displayed.

## Checking the play information of the disc

### To check DVD/Super Audio CD/CD text

Press DISPLAY repeatedly in Step 2 to display text recorded on the DVD/Super Audio CD/CD. The DVD/Super Audio CD/CD text appears only when text is recorded in the disc. You cannot change the text. If the disc does not contain text, "NO TEXT" appears.



### To check DATA CD/DATA DVD (MP3 audio) text

By pressing DISPLAY while playing MP3 audio tracks on a DATA CD/DATA DVD, you can display the name of the album/track, and the audio bit rate (the amount of data per second of the current audio) on your TV screen.

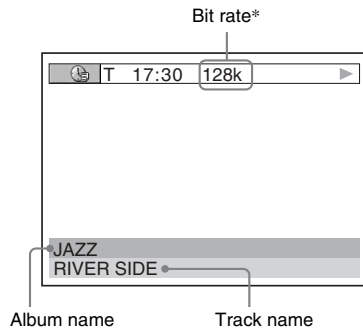

\* Appears when:

- playing an MP3 audio track on DATA CDs/DATA DVDs.



## Checking the date information

### (JPEG only)

You can check the date information during playback when the Exif\* tag is recorded in the JPEG image data.

Press **DISPLAY** twice during playback.

The Control Menu appears.

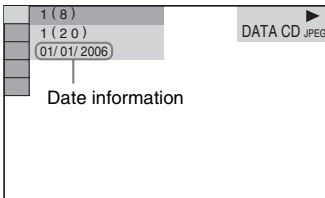

\* “Exchangeable Image File Format” is a digital camera image format defined by the Japan Electronics and Information Technology Industries Association (JEITA).

#### Tip

- Date information is [MM/DD/YYYY].  
MM: Month  
DD: Day  
YYYY: Year
- Date information differs depending on the area.

## Changing the Angles

### DVD-V

If various angles (multi-angles) for a scene are recorded on a DVD VIDEO, you can change the viewing angle.

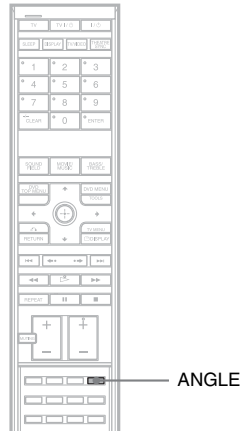

With the cover opened.

**Press ANGLE during playback.**

Each time you press ANGLE, the angle changes.

#### Note

- Depending on the DVD VIDEO, you may not be able to change the angle even if multi-angles are recorded on the DVD VIDEO.

## Displaying the Subtitles

DVD-V DVD-VR

If subtitles are recorded on a disc, you can turn the subtitles on or off while playing. If multilingual subtitles are recorded on the disc, you can change the subtitle language while playing, or turn the subtitles on or off whenever you want.

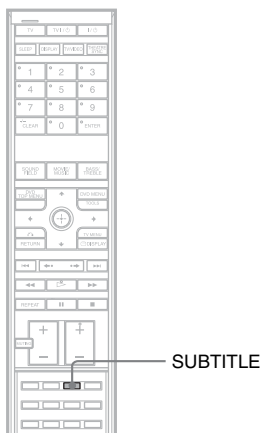

With the cover opened.

### Press SUBTITLE during playback.

Each time you press SUBTITLE, the subtitle language changes.

#### Note

- Depending on the DVD VIDEO, you may not be able to change the subtitles even if multilingual subtitles are recorded on it. You also may not be able to turn them off.

## Adjusting the Delay Between the Picture and Sound

### (A/V SYNC)

DVD-V DVD-VR VIDEO CD

When the sound does not match the pictures on the screen, you can adjust the delay between the picture and sound.

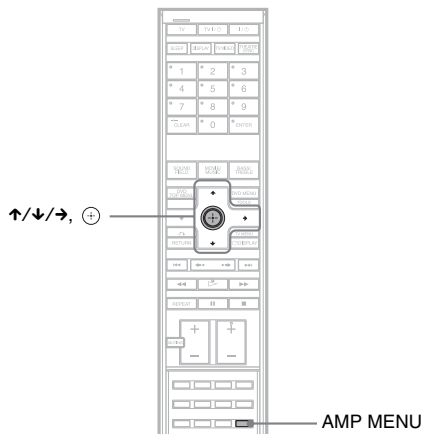

With the cover opened.

- 1 Press AMP MENU.**
- 2 Press  $\uparrow/\downarrow$  repeatedly until "A/V SYNC" appears in the front panel display, then press  $\oplus$  or  $\rightarrow$ .**
- 3 Press  $\uparrow/\downarrow$  to select a setting.**

The default setting is underlined.

  - OFF: does not adjust.
  - SHORT: adjusts the difference between picture and sound by 70 msec.
  - LONG: adjusts the difference between picture and sound by 140 msec.
- 4 Press  $\oplus$ .**
- 5 Press AMP MENU.**

The AMP menu turns off.

#### Note

- Depending on the input stream, this function may not be effective.

## Selecting a Playback Area for a Super Audio CD

Super Audio CD

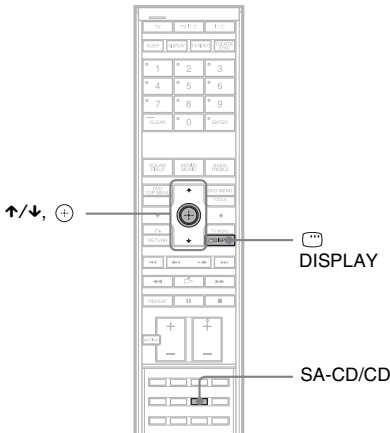

With the cover opened.

## Selecting a playback area on a 2 channel + Multi-channel Super Audio CD

Some Super Audio CDs consist of a 2 channel playback area and a multi-channel playback area. You can select the playback area you want to listen to.

**1** Press **DISPLAY** when the system is in stop mode.

The Control Menu appears.

**2** Press **↑/↓** to select **MULTI/2CH**, then press **+**.

The options for [MULTI/2CH] appear.

**3** Press **↑/↓** to select the setting you want and press **+**.

- [MULTI]: plays the multi-channel playback area.
- [2CH]: plays the 2 channel playback area. "MULTI" lights up in the front panel display when playing the multi-channel playback area.

### Note

- You cannot change the playback area during playback.

## Selecting a playback layer when playing a hybrid Super Audio CD

Some Super Audio CDs consist of an HD layer and a CD layer. You can select the playback layer you want to listen to.

**Press SA-CD/CD when the system is in stop mode.**

Each time you press the button, an HD layer or a CD layer is alternately selected. When playing a CD layer, "CD" lights up in the front panel display.

### Note

- Each play mode function works only within the selected layer or playback area.
- When you select a CD layer, you cannot change a playback area.
- Super Audio CD audio signals are not output from the HDMI OUT (high-definition multimedia interface out) jack.

# About MP3 Audio Tracks and JPEG Image Files

DATA-CD DATA DVD

## What is MP3/JPEG?

MP3 is audio compression technology that satisfies the ISO/MPEG regulations. JPEG is image compression technology.

## Discs that the system can play

You can play back DATA CDs (CD-ROMs/CD-Rs/CD-RWs) or DATA DVDs (DVD-Rs/DVD-RWs/DVD+Rs/DVD+RWs/DVD-ROMs) recorded in MP3 (MPEG1 Audio Layer 3) or JPEG format. However, the DATA CDs must be recorded according to ISO 9660 Level 1, Level 2 or Joliet format and DATA DVDs of Universal Disk Format (UDF) for the system to recognize the tracks (or files). You can also play discs recorded in Multi Session.

See the instructions supplied with the CD-R/CD-RW or DVD-R/DVD-RW drives and the recording software (not supplied) for details on the recording format.

## About the Multi-Session disc

If MP3 audio tracks or JPEG image files are recorded in the first session, the system will also play MP3 audio tracks or JPEG image files in other sessions. If audio tracks and images in audio CD format or video CD format are recorded in the first session, only the first session will be played back.

### Note

- The system cannot play some DATA CDs/DATA DVDs created in the Packet Write format.

## MP3 audio track or JPEG image file that the system can play

The system can play the MP3 audio tracks or JPEG image files:

- which have the extension “.MP3” (MP3 audio track) or “.JPG”/“.JPEG” (JPEG image file)
- which conform to the DCF\* image file format
- \* “Design rule for Camera File system”: Image standards for digital cameras regulated by Japan Electronics and Information Technology Industries Association (JEITA).

### Note

- The system will play any data with the extension “.MP3,” “.JPG,” or “.JPEG” even if they are not in MP3 or JPEG format. Playing this data may generate a loud noise which could damage your speaker system.
- The system does not conform to audio in MP3PRO format.

## Playback order of MP3 audio tracks or JPEG image files

The playback order of MP3 audio tracks or JPEG image files recorded on a DATA CD or DATA DVD is as follows:

### ■ Structure of disc contents

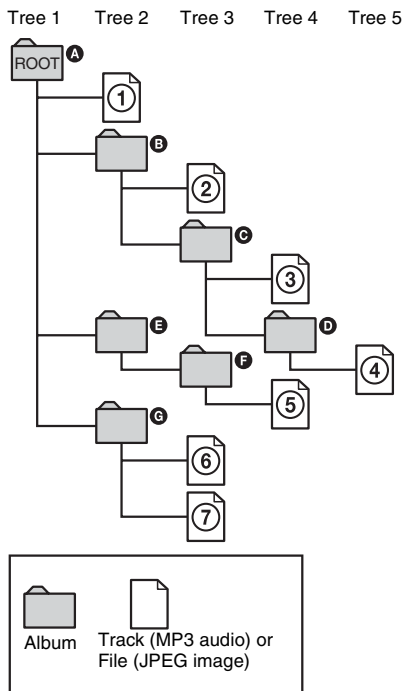

When you insert a DATA CD or DATA DVD, the numbered tracks (or files) are played sequentially, from ① through ⑦. Any sub-albums/tracks (or files) contained within a currently selected album take priority over the next album in the same tree. (Example: ⑥ contains ① so ④ is played before ⑤.)

When you press DVD MENU and the list of album names appears (page 69), the album names are arranged in the following order: ① → ② → ③ → ④ → ⑤ → ⑥. Albums that do not contain tracks (or files) (such as album ②) do not appear in the list.

**Tip**

- If you add numbers (01, 02, 03, etc.) to the front of the track (or file) names when you store the tracks (or files) in a disc, the tracks (or files) will be played in that order.
- A disc with many trees takes longer to start playback.

**Note**

- Playback order may differ from the illustration depending on the software you use to create the DATA CD or DATA DVD, or if there are more than 200 albums and 300 files in each album.
- The system can recognize up to 200 albums, and will not play any albums beyond the 200th.
- The system may take longer time to playback, when progressing to the following album or jump to other album.
- Some type of JPEG files cannot be played.

# Playing DATA CDs or DATA DVDs with MP3 Audio Tracks and JPEG Image Files

DATA-CD DATA DVD

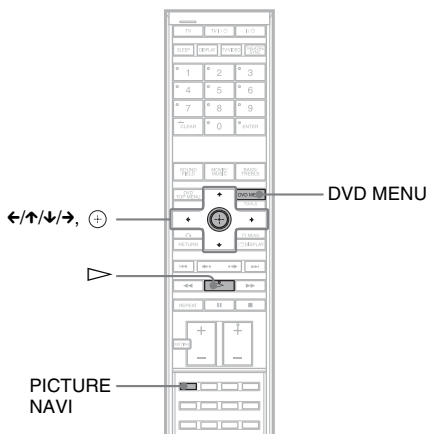

With the cover opened.

Various Functions for Playing Discs

## Selecting an MP3 audio track or album

### 1 Load a DATA CD or DATA DVD.

The system starts playing from the first album.

### 2 Press DVD MENU.

The albums recorded on the DATA CD or DATA DVD appear. When an album is being played, its title is shaded.



continued

### 3 Press $\uparrow/\downarrow$ to select an album.

#### ■ When selecting an album

Press  $\triangleright$  to start playing the selected album.

#### ■ When selecting a track

Press  $\oplus$ .

The list of tracks contained in the album appears.

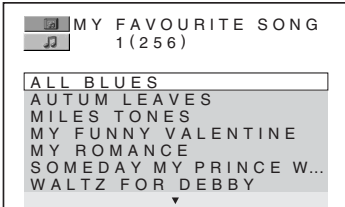

Press  $\uparrow/\downarrow$  to select a track and press  $\oplus$ .  
The selected track starts playing. You can turn the track list off by pressing DVD MENU. Pressing DVD MENU again will display the album list.

### To stop playback

Press  $\blacksquare$ .

### To play the next or previous MP3 audio track

Press  $\lll/\ggg$ . Note that you can select the next album by continuing to press  $\ggg$  after the last track on the current album, but that you cannot return to the previous album by pressing  $\lll$ . To return to the previous album, select the album from the album list.

### To return to the previous display

Press  $\curvearrowright$  RETURN.

### To turn off the display

Press DVD MENU.

## Selecting a JPEG image file or album

### 1 Load a DATA CD or DATA DVD.

The system starts playing from the first album.

### 2 Press DVD MENU.

The albums recorded on the DATA CD or DATA DVD appear. When an album is being played, its title is shaded.

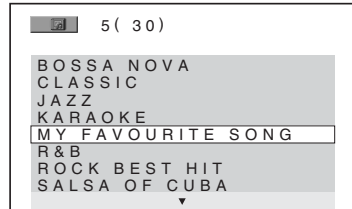

### 3 Press $\uparrow/\downarrow$ to select an album.

#### ■ When selecting an album

Press  $\triangleright$  to start playing the selected album.

#### ■ When selecting an image

Press PICTURE NAVI.

Images of files in the album appear in 16 subscreens.

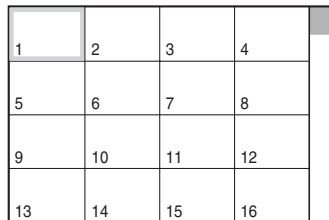

Press  $\leftarrow/\uparrow/\downarrow/\rightarrow$  to select the image you want to view and press  $\oplus$ .

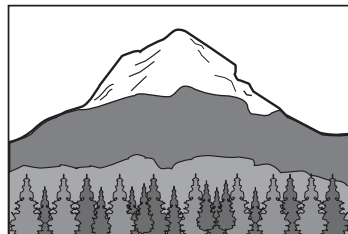

## To play the next or previous JPEG image file

Press ←/→ when the Control Menu is not displayed. Note that you can select the next album by continuing to press → after the last image on the current album, but that you cannot return to the previous album by pressing ←. To return to the previous album, select the album from the album list.

## To rotate a JPEG image

When a JPEG image file is displayed on the screen, you can rotate the image by 90 degrees. Press ↑/↓ while viewing an image. Each time you press ↑, the image rotates counterclockwise by 90 degrees.

Example of when you press ↑ once:

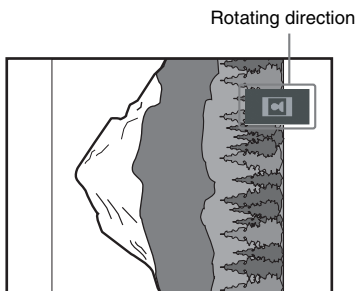

Press CLEAR to return to normal view.

## To stop playback

Press ■.

### Tip

- A scroll box is displayed at the right side of the screen. To display the additional image files, select the bottom image and press ↓. To return to the previous image, select the top image and press ↑.

# Playing Audio Tracks and Images as a Slide Show with Sound

**DATA-CD** **DATA DVD**

You can play a slide show with sound by first placing both MP3 and JPEG files in the same album on a DATA CD or DATA DVD. When you play back the DATA CD or DATA DVD, select [AUTO] mode as explained below.

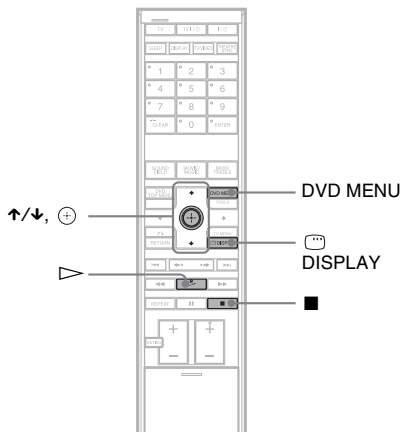

- 1 Load a DATA CD or DATA DVD.**  
The system starts playing from the first album.
- 2 Press ■.**  
The system stops playback.
- 3 Press DISPLAY when the system is in stop mode.**  
The Control Menu appears.
- 4 Press ↑/↓ to select [MODE (MP3, JPEG)], then press +.**  
The options for [MODE (MP3, JPEG)] appear.

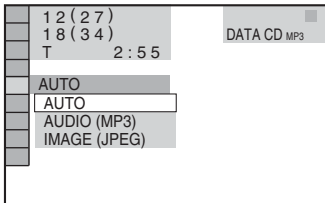

**5 Press  $\uparrow/\downarrow$  to select the setting you want and press  $\oplus$ .**

The default setting is underlined.

- [AUTO]: plays both the JPEG image files and MP3 audio tracks in the same album as a slide show.
- [AUDIO (MP3)]: plays only MP3 audio tracks continuously.
- [IMAGE (JPEG)]: plays only JPEG image files as a slide show.

**6 Press DVD MENU.**

The list of albums recorded on the DATA CD or DATA DVD appears.

**7 Press  $\uparrow/\downarrow$  to select the album you want and press  $\triangleright$ .**

The system starts playing the selected album.

You can turn the album list on and off by pressing DVD MENU repeatedly.

**Tip**

- When you select [AUTO], the system can recognize up to 300 MP3 tracks and 300 JPEG files in a single album. When you select [AUDIO (MP3)] or [IMAGE (JPEG)], the system can recognize up to 600 MP3 and 600 JPEG files in a single album. A maximum of 200 albums can be recognized regardless of the selected mode.

**Note**

- If you set [MODE (MP3, JPEG)] to [IMAGE (JPEG)] on a disc that contains MP3 tracks only or [AUDIO (MP3)] on a disc that contains JPEG files only, you may not be able to change the [MODE (MP3, JPEG)] setting.
- PICTURE NAVI does not work when [AUDIO (MP3)] is selected.
- If you play large MP3 track data and JPEG image data at the same time, the sound may skip. It is recommended that you set the MP3 bit rate to 128 kbps or lower when creating the file. If the sound still skips, then reduce the size of the JPEG file.

## Specifying the slide show duration

### (JPEG only)

When you play JPEG image files using slide show, you can specify the duration for slides to appear on the screen.

**1 Press  $\text{DISP}$  DISPLAY twice.**

The Control Menu for JPEG appears.

**2 Press  $\uparrow/\downarrow$  to select  [INTERVAL], then press  $\oplus$ .**

The options for [INTERVAL] appear.

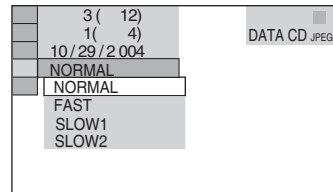

**3 Press  $\uparrow/\downarrow$  to select the setting you want.**

The default setting is underlined.

- [NORMAL]: sets the duration to about 6 to 9 seconds. (Images that are four million pixels or more will lengthen the duration.)
- [FAST]: sets the duration shorter than [NORMAL].
- [SLOW1]: Sets the duration longer than [NORMAL].
- [SLOW2]: Sets the duration longer than [SLOW1].

**4 Press  $\oplus$ .**

The selected setting takes effect.

**Note**

- Some JPEG files may take longer to display than others, which may make the duration seems longer than the option you selected. Especially progressive JPEG files or JPEG files of 3,000,000 pixels or more.



## Selecting an effect for image files in the slide show

(JPEG only)

When you play a JPEG image file, you can select the effect to be used when viewing the slide show.

- 1** Press **DISPLAY** twice.  
The Control Menu for JPEG appears.
- 2** Press  $\uparrow/\downarrow$  to select [EFFECT], then press  $\oplus$ .  
The options for [EFFECT] appear.

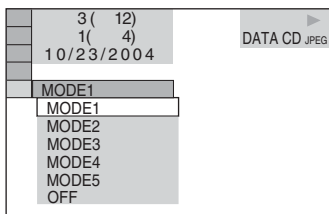

- 3** Press  $\uparrow/\downarrow$  to select the setting you want.  
The default setting is underlined.
  - [MODE1]: The image sweeps in from top to bottom.
  - [MODE2]: The image stretches out from left to right of the screen.
  - [MODE3]: The image stretches out from the center of the screen.
  - [MODE4]: The images randomly cycle through the effects.
  - [MODE5]: The next image slides over the previous image.
  - [OFF]: Turns off this function.
- 4** Press  $\oplus$ .  
The selected setting takes effect.

## Playing VIDEO CDs with PBC Functions (Ver.2.0)

(PBC Playback)

### VIDEO CD

With PBC (Playback Control) functions, you can enjoy simple interactive operations, search functions, and other such operations. PBC playback allows you to play VIDEO CDs interactively by following the menu on the TV screen.

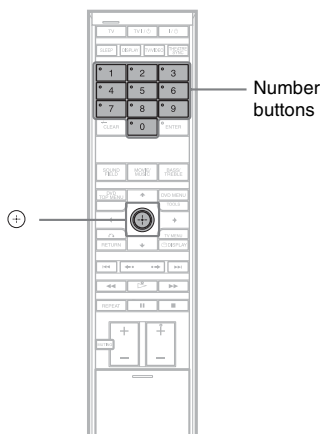

- 1** Start playing a VIDEO CD with PBC functions.  
The menu for your selection appears.
- 2** Select the item number you want by the number buttons.
- 3** Press  $\oplus$ .
- 4** Follow the instructions in the menu for interactive operations.  
Refer to the operation details supplied with the disc, as the operating procedure may differ depending on the VIDEO CD.







### To go back to the menu

Press RETURN.

**Note**

- Depending on the VIDEO CD, [Press ENTER] in Step 3 may appear as [Press SELECT] in the instructions supplied with the disc. In this case, press .

**Tip**

- To play without using PBC, press /  or the number buttons while the system is stopped to select a track, then press  or . The system starts continuous play. You cannot play still pictures such as a menu. To return to PBC playback, press  twice, then press .

## Tuner Functions

# Presetting Radio Stations

You can preset 20 FM stations, and 10 AM stations. Before tuning, make sure to turn down the volume to minimum.

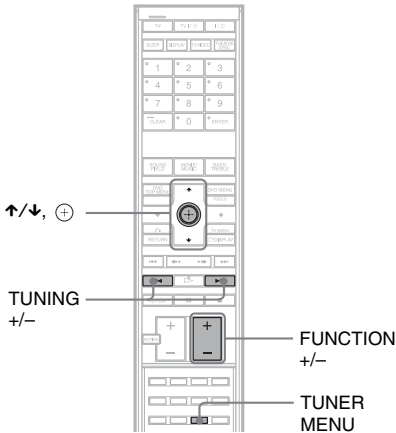

With the cover opened.

- 1 Press FUNCTION +/- repeatedly until "FM" or "AM" appears in the front panel display.**
- 2 Press and hold TUNING + or - until the auto scanning starts.**  
Scanning stops when the system tunes in a station. "TUNED" and "ST" (for stereo program) appear in the front panel display.
- 3 Press TUNER MENU.**
- 4 Press ↑/↓ repeatedly until "Memory?" appears in the front panel display.**
- 5 Press ⊕.**  
A preset number appears in the front panel display.

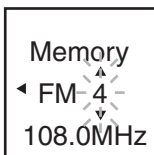

- 6 Press ↑/↓ to select the preset number you want.**

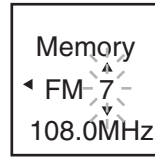

- 7 Press ⊕.**  
The station is stored.



- 8 Press TUNER MENU.**
- 9 Repeat 1 to 8 to store other stations.**

### To change the preset number

Restart from Step 1.

### To change the AM tuning interval

The AM tuning interval can be set to either 10 kHz or 9 kHz.

To change the AM tuning interval, first tune in any AM station, then turn off the system by pressing I/⏻ on the control unit. While holding down FUNCTION on the control unit, press I/⏻ on the control unit to turn on the power. If you change the interval, AM preset stations will be erased.

To reset the interval, repeat the same procedure.

## Listening to the Radio

Preset radio stations in the system's memory first (see "Presetting Radio Stations" (page 75)).

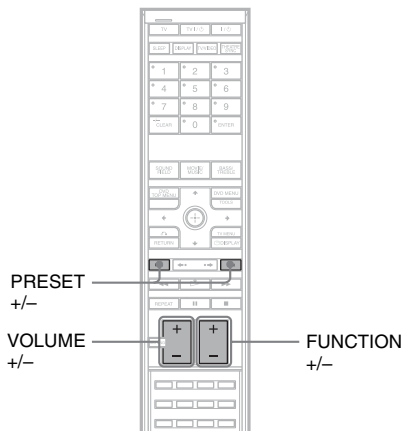

With the cover opened.

- 1 Press FUNCTION +/- repeatedly until "FM" or "AM" appears in the front panel display.**

The last received station is tuned in.

- 2 Press PRESET + or - repeatedly to select the preset station you want.**

Each time you press the button, the system tunes in one preset station.

- 3 Adjust the volume by pressing VOLUME +/-.**

### To turn off the radio

Press I/O.

### To listen to non-preset radio stations

Use manual or automatic tuning in Step 2. For manual tuning, press TUNING + or - repeatedly.

For automatic tuning, press and hold TUNING + or -. The automatic tuning stops automatically when the system receives the radio station. To stop the automatic tuning manually, press TUNING + or -.

## To listen to radio stations when you know the frequencies

Use direct tuning in Step 2.

- 1 Press DIRECT TUNING.**
- 2 Press the number buttons to select the frequency number you want to listen to.**  
For example, to input "98.0MHz," press the number buttons in the following order:  
9 → 8 → 0
- 3 Press ⊕.**

#### Tip

- If an FM program is noisy, press FM MODE so that "MONO" appears in the front panel display. There will be no stereo effect, but the reception will improve. Press the button again to restore the stereo effect. (Or press TUNER MENU and select "FM Mode?" by pressing ↑/↓, then press ⊕. Press ↑/↓ to select "MONO," then press ⊕. To return, select "STEREO.")
- To improve reception, reorient the supplied antennas (aerials).

## Naming preset stations

You can enter a name for preset stations. These names (for example, "XYZ") appear in the system's front panel display when a station is selected.

Note that no more than one name can be entered for each preset station.

- 1 Press FUNCTION +/- repeatedly until "FM" or "AM" appears in the front panel display.**

The last received station is tuned in.

- 2 Press PRESET + or - repeatedly to select the preset station you want to create an index name for.**

- 3 Press TUNER MENU.**

- 4 Press ↑/↓ repeatedly until "Name In?" appears in the front panel display.**

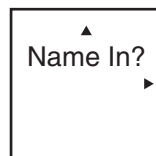

- 5 Press ⊕.**

**6 Create a name by using ←/↑/↓/→.**

Press ↑/↓ to select a character, then press → to move the cursor to the next position.

Letters, numbers, and other symbols can be input for a radio station name.

**If you make a mistake**

Press ←/→ repeatedly until the character to be changed flashes, then press ↑/↓ to select the desired character.

To erase the character, press ←/→ repeatedly until the character to be erased flashes, then press CLEAR.

**7 Press ⊕.**

“Complete” appears in the front panel display, and the station name is stored.

**8 Press TUNER MENU.**

## Other Operations

# Controlling the TV with the Supplied Remote

By adjusting the remote signal, you can control your TV with the supplied remote.

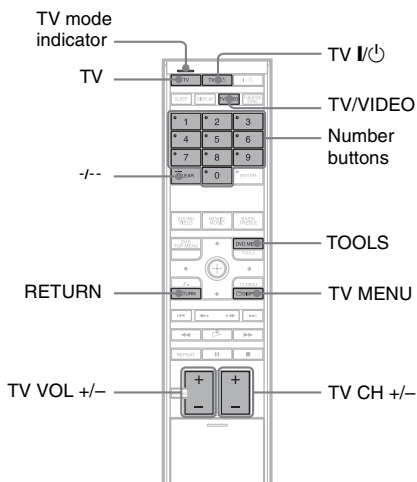

### Note

- When you replace the batteries of the remote, the code number may reset itself to the default (SONY) setting. Reset the appropriate code number.

## Controlling TVs with the remote

**Press and hold TV I/⏻ while entering your TV's manufacturer's code (see the table) using the number buttons. Then release TV I/⏻.**

If you set successfully the manufacturer's code, the TV button flashes twice slowly. If the setting is unsuccessful, the TV button flashes 5 times quickly.

### Code numbers of controllable TVs

If more than one code number is listed, try entering them one at a time until you find the one that works with your TV.

## TV

Manufacturer	Code number
SONY	501 (default), 502
ADMIRAL	510, 535, 542
AIWA	501, 536, 539
AKAI	503
AOC	503
BCL&HOWELL	535, 542
BROKSONIC	503
CROSLEX	518
CURTIS-MATHES	503, 551, 566, 567
DAEWOO	503, 504, 505, 506, 507, 515
DAYTRON	517
EMERSON	503, 517
FISHER	508, 545
FUJITSU	528
FUNAI	548
GENERAL ELECTRIC	503, 509, 510
GOLDSTAR/LG	503, 512, 515, 517, 568, 576
GRUNDIG	511, 533
HITACHI	503, 513, 514, 515, 517, 557
ITT/NOKIA	521, 522
J.C.PENNY	503, 510, 566
JVC	516, 552
KTV	503, 517
LOEWE	515, 556
LXI (Sears)	503, 508, 510, 517, 518, 551
MAGNAVOX	503, 515, 517, 518, 566
MARANTZ	527
mitsubishi/MGA	503, 519, 527, 566, 568
NEC	503, 520, 527, 554
PANASONIC	509, 524, 553, 572
PHILCO	503, 504, 514, 517, 518
PHILIPS	515, 518, 557
PIONEER	509, 525, 526, 551, 555
PORTLAND	503
QUASAR	509, 535
RADIO SHACK	503, 510, 527, 565, 567
RCA/PROSCAN	503, 510, 523, 529
SAMSUNG	503, 515, 517, 531, 532, 534, 556, 557, 566, 569, 574
SANYO	508, 545, 546, 567
SCOTT	503, 566

Manufacturer	Code number
SHARP	517, 535, 550, 565
SIGNATURE	535, 542, 550
SYLVANIA	503, 518, 566
TELEFUNKEN/ SABA	530, 537, 538, 547, 549, 558
THOMSON	530, 537, 547, 549
TOSHIBA	535, 539, 540, 541, 551
VIDECH	503, 514
WARDS	503, 517, 566
ZENTH	542, 543, 567

## CATV

Manufacturer	Code number
SONY	802, 821, 822, 823, 824, 825, 865
AMSTRAD	845, 846
BSKYB	862
GRUNDING	859, 860
HAMLIN/REGAL	836, 837, 838, 839, 840
HUMAX	846, 847
JERROLD	830, 831
JERROLD/GI	806, 807, 808, 809, 810, 811, 812, 813, 814
MOTOROLA	807, 819
NOKIA	851, 853, 854, 864
OAK	841, 842, 843
PACE	848, 849, 850, 852, 862, 863, 864
PANASONIC	816, 826, 833, 834, 835, 855
PHILIPS	830, 831, 856, 857, 858, 859, 860, 864
PIONEER	828, 829
SCIENTIFIC ATLANTA	815, 816, 817, 844
THOMSON	830, 831, 857, 861, 864, 876
ZENTH	826, 827

## To control the TV

You can control the TV by using following buttons.

By pressing	You can
TV I/⏻	Turn the TV on or off.
TV/VIDEO	Switch the TV's input source between the TV and other input sources.
TV VOL +/-*	Adjust the TV volume.
TV CH +/-*	Select the TV channel.
Number buttons*	Select the TV channel.
TOOLS*	Displays the operation menu for the current display
RETURN*	Return to the previous channel.
TV MENU*	Display the menu of the TV.

\* These buttons change to the TV operation buttons when the remote is in TV mode. The remote is in TV mode when the TV mode indicator (above the TV button) lights up by pressing the TV button.

-/- is for selecting a channel number greater than 10. (For example, for channel 25, press -/-, then 2 and 5.)

### Note

- Depending on the TV, you may not be able to control your TV or to use some of the buttons above.
- The TV mode turns off when you do not operate the remote for 10 seconds.

## Using the THEATRE SYNC Function

THEATRE SYNC allows you to turn on your SONY TV and this system, changes the system mode to "DVD," and then switches the TV's input source you set with one button push.

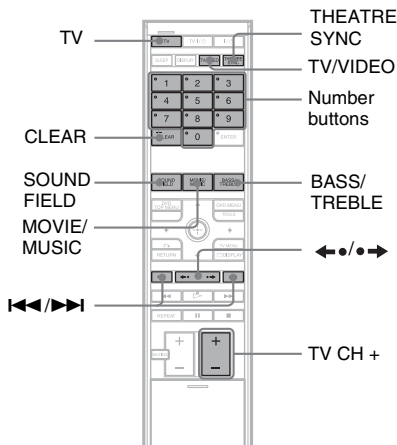

By pressing	Number	TV's input source
TV/VIDEO	0	No input source (Default)
	1	VIDEO1
	2	VIDEO2
	3	VIDEO3
	4	VIDEO4
	5	VIDEO5
	6	VIDEO6
	7	VIDEO7
	8	VIDEO8
	9*	COMPONENT 1
	CLEAR*	COMPONENT 2
	SOUND FIELD*	COMPONENT 3
	MOVIE/MUSIC*	COMPONENT 4
	BASS/TREBLE*	HDMI 1
	⏪*	HDMI 2
	⏩*	HDMI 3
	⏪*	HDMI 4
	⏩*	HDMI 5

## Preparing for the THEATRE SYNC function

Register the TV's input source connected to this system.

**Press and hold TV/VIDEO while entering the code for the TV's input source connected to this system (see the table) using the number buttons.**

The TV's input source is selected.

If you successfully set the TV's input source code, the TV button flashes twice slowly. If the setting is unsuccessful, the TV button flashes 5 times quickly.

Set your TV's input to the input you used to connect the system. For details, see the instructions of your TV.

\* Except for North American models.



## Operating for the THEATRE SYNC function

Point the remote to the direction of TV and this system, then press THEATRE SYNC once.

While transmitting the code from the remote, the TV button flashes.

If this function does not work, change the transmit time. The transmit time varies depending on the TV.

### To change the transmit time

Press and hold TV CH +\* while entering the code for transmit time (see the table) using the number buttons.

The transmit time from the remote is selected. If you successfully set the transmit time code, the TV button flashes twice slowly. If the setting is unsuccessful, the TV button flashes 5 times quickly.

\* Functions as both TV CH + and FUNCTION + button.

By pressing	Number	Transmit time
TV CH +	1	0.5 (Default)
	2	1
	3	1.5
	4	2
	5	2.5
	6	3
	7	3.5
	8	4

#### Note

- This function is only for SONY TVs. (This function may not work on some SONY TVs.)
- If distance between TV and this system is too far, this function may not work. Install the system near the TV.
- Keep the remote pointed in the direction of the TV and this system while the TV button is flashing.
- Keep the remote pointed in the direction of the TV and this system while entering the code.

## Enjoying Multiplex Broadcast Sound

### (DUAL MONO)

You can enjoy multiplex broadcast sound when the system receive the Dolby Digital multiplex broadcast signal.



AUDIO

With the cover opened.

### Press AUDIO.

Press AUDIO repeatedly until the signal you want appears in the front panel display. The default setting is underlined.

- MAIN: Sound of the main language will be output.
- SUB: Sound of the sub language will be output.
- MAIN+SUB: Mixed sound of both the main and sub languages will be output.

#### Note

- To receive the Dolby Digital signal, you need to connect a digital satellite tuner to the system with a digital cord (pages 39, 40) and set the digital output mode of the digital satellite tuner to Dolby Digital.

## Using the Sound Effect

### Enjoying the sound at low volume

You can enjoy sound effects or dialogue, as you would in a movie theater, even at low volume. It is useful for watching movies at night.

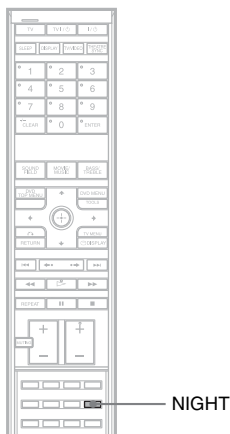

With the cover opened.

#### Press NIGHT.

“Night Mode On” appears in the front panel display and the sound effect is activated.

#### To turn off the sound effect

Press NIGHT again.

## Using the Sleep Timer

You can set the system to turn off at a preset time, so you can fall asleep listening to music. You can preset the time in 10 minutes decrements.



#### Press SLEEP.

Each time you press this button, the minutes display (the remaining time) changes as follows:

Sleep Off → Sleep 90 min → Sleep 80 min  
↑ ↓  
Sleep 10 min ..... Sleep 60 min ← Sleep 70 min

When you set timer, “☹” appears in the front panel display.

#### To check the remaining time

Press SLEEP once.

#### To change the remaining time

Press SLEEP repeatedly to select the desired time.

#### To cancel the Sleep Timer function

Press SLEEP repeatedly until “Sleep Off” appears in the front panel display.

# Changing the Brightness of the Front Panel Display

You can change the brightness of the front panel display.



With the cover opened.

## Press DIMMER.

Each time you press DIMMER, the brightness of the front panel changes as follows:

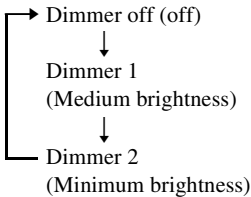

## Advanced Settings and Adjustments

### Locking Discs

#### (CUSTOM PARENTAL CONTROL, PARENTAL CONTROL)

DVD-V VIDEO CD Super Audio CD C D

You can set 2 kinds of playback restrictions for the desired disc.

- Custom Parental Control

You can set playback restrictions so that the system will not play inappropriate discs.

- Parental Control

Playback of some DVD VIDEOS can be limited according to a predetermined level such as the age of the users. Scenes may be blocked or replaced with different scenes.

The same password is used for both Custom Parental Control and Parental Control.

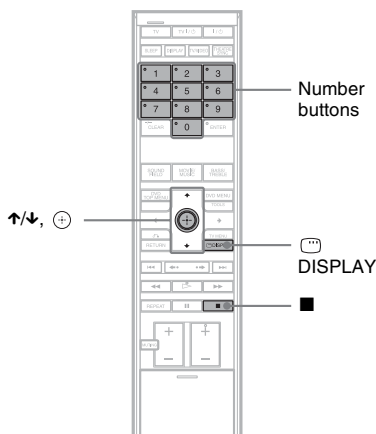

### Preventing playback of specific discs [CUSTOM PARENTAL CONTROL]

You can set the same Custom Parental Control password for up to 40 discs. When you set the 41st-disc, the first disc is canceled.

#### 1 Insert the disc you want to lock.

If the disc is playing, press ■ to stop playback.

#### 2 Press DISPLAY while the system is in stop mode.

The Control Menu appears.

#### 3 Press to select [PARENTAL CONTROL], then press .

The options for [PARENTAL CONTROL] appear.

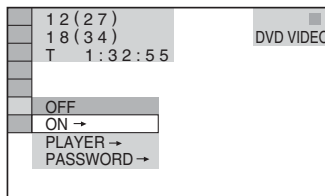

#### 4 Press to select [ON →], then press .

#### ■ If you have not entered a password

The display for registering a new password appears.

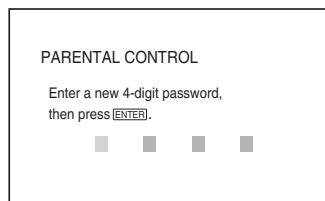



Enter a 4-digit password using the number buttons, then press .

The display for confirming the password appears.



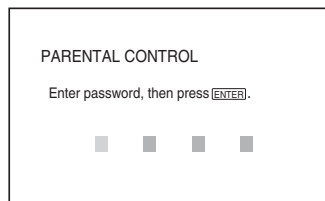

#### ■ When you have already registered a password

The display for entering the password appears.



- 5** Enter or re-enter your 4-digit password using the number buttons, then press  .
- [Custom parental control is set.] appears and the screen returns to the Control Menu.

## To turn off the Custom Parental Control function

- Follow steps 1 through 3 of “Preventing playback of specific discs [CUSTOM PARENTAL CONTROL].”
- Press  to select [OFF ], then press  .
- Enter your 4-digit password using the number buttons, then press  .

## To play a disc for which Custom Parental Control is set

- Insert the disc for which Custom Parental Control is set.
- The [CUSTOM PARENTAL CONTROL] display appears.

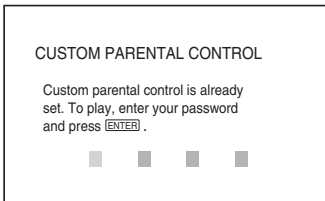

- Enter your 4-digit password using the number buttons, then press  .
- The system is ready for playback.

### Tip

- If you forget your password, enter the 6-digit number “199703” using the number buttons when the [CUSTOM PARENTAL CONTROL] display asks you for your password, then press  . The display will ask you to enter a new 4-digit password.

## Limiting playback for children [PARENTAL CONTROL]

### (DVD VIDEO only)

Playback of some DVD VIDEOS can be limited according to a predetermined level such as the age of the users. The [PARENTAL CONTROL] function allows you to set a playback limitation level.

- Press  **DISPLAY** while the system is in stop mode.

The Control Menu appears.

- Press  to select  [PARENTAL CONTROL], then press  .

The options for [PARENTAL CONTROL] appear.

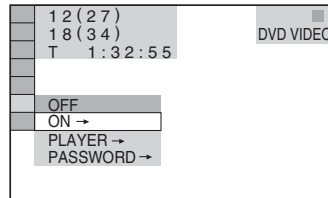

- Press  to select [PLAYER ], then press  .

■ **If you have not entered a password**  
The display for registering a new password appears.

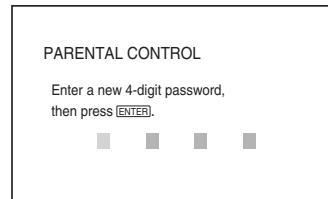

Enter a 4-digit password using the number buttons, then press  .

The display for confirming the password appears.

**■ When you have already registered a password**

The display for entering the password appears.

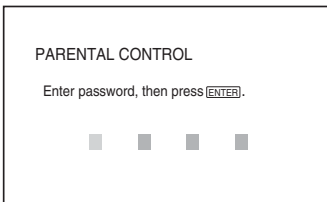

**4 Enter or re-enter your 4-digit password using the number buttons, then press  $\oplus$ .**

The display for setting the playback limitation level appears.

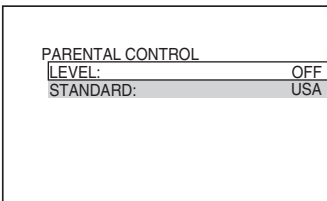

**5 Press  $\uparrow/\downarrow$  to select [STANDARD], then press  $\oplus$ .**

The selection items for [STANDARD] are displayed.

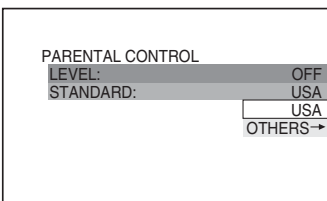

**6 Press  $\uparrow/\downarrow$  to select a geographic area as the playback limitation level, then press  $\oplus$ .**

The area is selected.

When you select [OTHERS →], select and enter a standard code in the table of “Parental Control Area Code List” (page 113) using the number buttons.

**7 Press  $\uparrow/\downarrow$  to select [LEVEL], then press  $\oplus$ .**

The selection items for [LEVEL] are displayed.

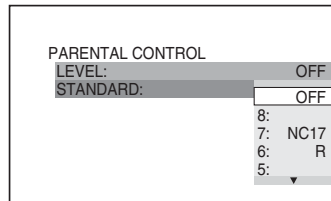

**8 Press  $\uparrow/\downarrow$  to select the level you want, then press  $\oplus$ .**

Parental Control setting is complete.

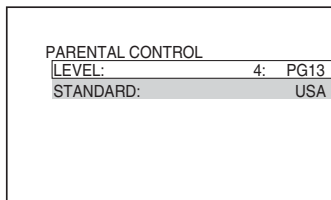

The lower the value, the stricter the limitation.

**To turn off the Parental Control function**

Set [LEVEL] to [OFF] in Step 8.

**To play a disc for which Parental Control is set**

**1** Insert the disc and press  $\triangleright$ .

The display for entering your password appears.

**2** Enter your 4-digit password using the number buttons, then press  $\oplus$ .

The system starts playback.

**Tip**

- If you forget your password, remove the disc and repeat steps 1 to 3 of “Preventing playback of specific discs [CUSTOM PARENTAL CONTROL].” When you are asked to enter your password, enter “199703” using the number buttons, then press  $\oplus$ . The display will ask you to enter a new 4-digit password. After you enter a new 4-digit password, replace the disc in the system and press  $\triangleright$ . When the display for entering your password appears, enter your new password.

**Note**

- When you play discs which do not have the Parental Control function, playback cannot be limited on this system.
- Depending on the disc, you may be asked to change the parental control level while playing the disc. In this case, enter your password, then change the level. If the Resume Play mode is canceled, the level returns to the previous level.

## Changing the password

**1** Press **DISPLAY** while the system is in stop mode.

The Control Menu appears.

**2** Press **↑/↓** to select **[PARENTAL CONTROL]**, then press **+**.

The options for **[PARENTAL CONTROL]** appear.

**3** Press **↑/↓** to select **[PASSWORD →]**, then press **+**.

The display for entering the password appears.

**4** Enter your 4-digit password using the number buttons, then press **+**.

**5** Enter a new 4-digit password using the number buttons, then press **+**.

**6** To confirm your password, re-enter it using the number buttons, then press **+**.

### If you make a mistake entering your password

Press **←** before you press **+** and input the correct number.

## Calibrating the Appropriate Settings Automatically

### (AUTO CALIBRATION)

D. C. A. C. (Digital Cinema Auto Calibration) can set the appropriate surround sound automatically.

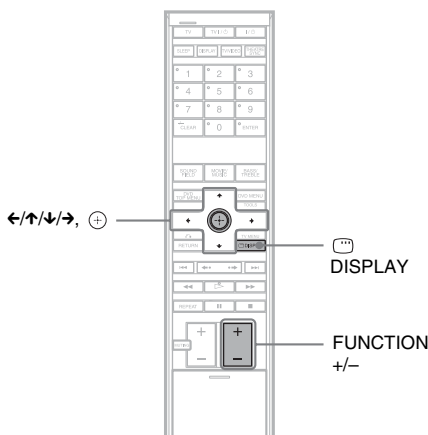
**Note**

- Loud test sound is output when **[AUTO CALIBRATION]** starts. You cannot turn the volume down. Give consideration to children and neighbor.

- 1** Connect the calibration mic to the ECM-AC1 jack on the rear of the subwoofer, and set it up at the ear level using a tripod, etc. (not supplied).

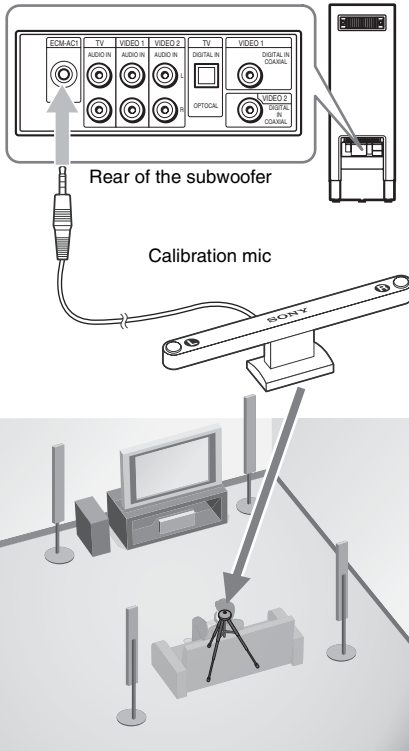

The front of each speaker should face the calibration mic, and there should be no obstruction between the speakers and the calibration mic.

**Note**

- Place the calibration mic so that the “FRONT” side of it is pointed toward the front speakers.

- 2** Press **FUNCTION +/-** repeatedly until “DVD” appears in the front panel display.
- 3** Press **DISPLAY** when the system is in stop mode.  
The Control Menu appears.

- 4** Press **↑/↓** to select **[AUTO CALIBRATION]**.

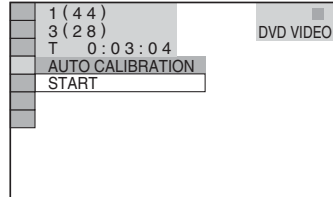

- 5** Press **+/-**.  
The [AUTO CALIBRATION] display appears.

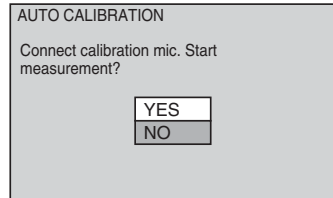

- 6** Press **↑/↓** to select [YES], then press **+/-** to start [AUTO CALIBRATION].

Be quiet during the measurement.



**Note**

- Avoid being in the measurement area and making noise during the measurement (about 1 minute), to avoid measurement failure. During the measurement, test signals are output from the speakers.
- Reflections from walls or the floor may affect measurements.
- When you install the surround speaker (L) to the right position, the system set the “SL SR REVERSE” setting (page 99) to “ON” automatically.



• If an error message appears, follow the message, then select [YES].

An error message appears when:

- the calibration mic is not connected.
- front speakers are not correctly connected.
- surround speakers are not correctly connected.
- front and surround speakers are not correctly connected.
- subwoofer is not connected.

**7 Press ←/↑/↓/→ to select [YES] or [NO], then press (+) .**

**■ The measurement is OK.**

Disconnect the calibration mic, then select [YES]. The result is implemented.

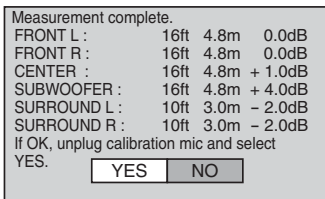

**■ The measurement is not OK.**

Follow the message, then select [YES] to retry.

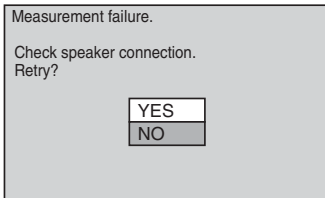

**Tip**

• You can check the distance between the listening position and each speaker. See page 97.

**Note**

- While [AUTO CALIBRATION] works:
  - do not turn off the power.
  - do not press any button.
  - do not change the volume.
  - do not change the function.
  - do not change the disc.
  - do not insert or eject a disc.
  - do not disconnect the calibration mic.

**About error messages for the auto calibration**

If the following message appears during [AUTO CALIBRATION], check “Symptoms and remedies” and retry the auto calibration.

Error message	Symptoms and remedies
Check calibration mic connection.	No channel sound can be detected. Check that the calibration mic is connected properly. If the calibration mic is connected properly, the calibration mic or calibration mic cord may be damaged.
Mic input level overloaded.	The calibration mic or system may be damaged. Contact your Sony dealer or local authorized Sony service facility.
Check front speaker connection.	Front speakers are not connected. Check that the front speakers are connected properly (page 22).
Check surround speaker connection.*	Only one surround speaker is connected. Check that the surround speakers are connected properly (page 22).
Check front and surround speaker connection.	Front speakers are not connected and only one surround speaker is connected. Check that the speakers are connected properly (page 22).
Check subwoofer connection.	The subwoofer is not connected. Check that the subwoofer is connected properly (page 22).
Front left and right speakers are reversed.	Front speakers are not installed properly or front left and right speakers are reversed. Check the front speakers are installed properly (page 22). If the calibration mic is left/right reversed, place the calibration mic properly.

\* If the sound of the surround speakers is not output, adjust the wireless system. See “Adjusting the IR transmitter and IR receiver of the surround speaker (L)” (page 29).

## Using the Setup Display

By using the Setup Display, you can make various adjustments to items such as picture and sound.

For an overall list of Setup Display items, see page 123.

Displayed items differ depending on the country model.

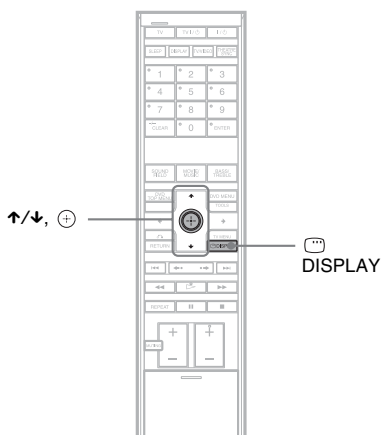

### Note

- Playback settings stored in the disc take priority over the Setup Display settings and not all the functions described may work.

**1** Press **DISPLAY** when the system is in stop mode.

The Control Menu appears.

**2** Press **↑/↓** to select **SETUP**, then press **+**.

The options for [SETUP] appear.

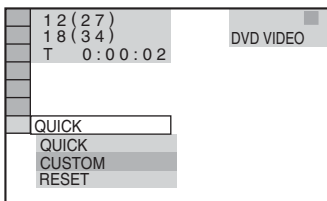

**3** Press **↑/↓** to select [CUSTOM], then press **+**.

The Setup Display appears.

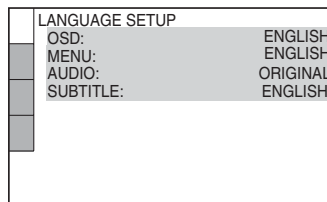

**4** Press **↑/↓** to select the setup item from the displayed list: [LANGUAGE SETUP], [SCREEN SETUP], [CUSTOM SETUP], or [SPEAKER SETUP]. Then press **+**.

The Setup item is selected.

Example: [SCREEN SETUP]

Selected item

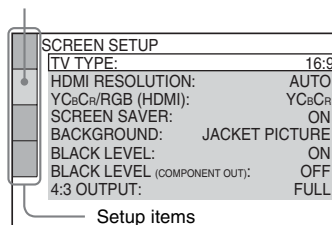

**5** Select an item using **↑/↓**, then press **+**.

The options for the selected item appear.

Example: [TV TYPE]

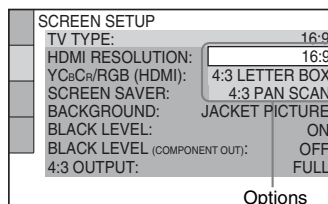

## 6 Select a setting using ↑/↓, then press



The setting is selected and setup is complete.

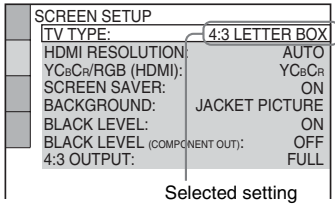

## Setting the Display or Sound Track Language

### [LANGUAGE SETUP]

[LANGUAGE SETUP] allows you to set various languages for the on-screen display or sound track.

Select [LANGUAGE SETUP] in the Setup Display. To use the display, see “Using the Setup Display” (page 90).

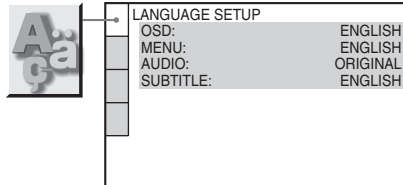

#### ■ [OSD] (On-Screen Display)

Switches the display language on the screen.

#### ■ [MENU] (DVD VIDEO only)

You can select the desired language for the disc's menu.

#### ■ [AUDIO] (DVD VIDEO only)

Switches the language of the sound track.

When you select [ORIGINAL], the language given priority in the disc is selected.

#### ■ [SUBTITLE] (DVD VIDEO only)

Switches the language of the subtitle recorded on the DVD VIDEO.

When you select [AUDIO FOLLOW], the language for the subtitles changes according to the language you selected for the sound track.

#### Tip

- If you select [OTHERS →] in [MENU], [AUDIO], and [SUBTITLE], select and enter a language code from “Language Code List” (page 113) using the number buttons.

#### Note

- When you select a language in [MENU], [AUDIO], or [SUBTITLE] that is not recorded on the DVD VIDEO, one of the recorded languages will be automatically selected (depending on the disc, the language may not be selected automatically).

# Settings for the Display

## [SCREEN SETUP]

Choose settings according to the TV to be connected.

Select [SCREEN SETUP] in the Setup Display. To use the display, see “Using the Setup Display” (page 90).

The default settings are underlined.

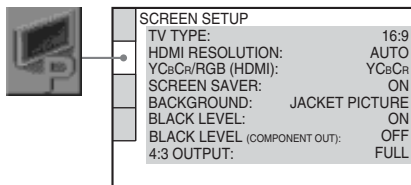

### ■ [TV TYPE]

Selects the aspect ratio of the connected TV (4:3 standard or wide).

**[16:9]** Select this when you connect a wide-screen TV or a TV with a wide mode function.

**[4:3 LETTER BOX]** Select this when you connect a 4:3 screen TV. Displays a wide picture with bands on the upper and lower portions of the screen.

**[4:3 PAN SCAN]** Select this when you connect a 4:3 screen TV. Automatically displays the wide picture on the entire screen and cuts off the portions that do not fit.

[16:9]

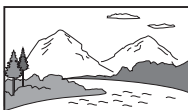

[4:3 LETTER BOX]



[4:3 PAN SCAN]

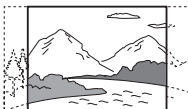

### Note

- Depending on the DVD, [4:3 LETTER BOX] may be selected automatically instead of [4:3 PAN SCAN] or vice versa.

### ■ [HDMI RESOLUTION]

Selects the type of video signals output from the HDMI OUT (high-definition multimedia interface out) jack. When you select [AUTO] (default), the system outputs video signals of the highest resolution acceptable for your TV.

If the picture is not clear, natural or to your satisfaction, try another option that suits the disc and your TV/projector, etc. For details, refer also to the instruction manual supplied with the TV/projector, etc.

<b>[AUTO]</b>	Normally, select this.
<b>[1920 × 1080i*]</b>	Sends 1920 × 1080i video signals.
<b>[1280 × 720p*]</b>	Sends 1280 × 720p video signals.
<b>[720 × 480p*]</b>	Sends 720 × 480p video signals.

\* i: interlace, p: progressive

### Note

- Even when a setting other than [AUTO] is selected and the connected TV cannot accept the resolution, the system automatically adjusts the video signals that are suitable for the TV.
- When the HDMI indicator on the front panel lights up, images from the S VIDEO OUT jack is enlarged vertically. (Except when [720 × 480p] is selected.)

### ■ [YCbCr/RGB (HDMI)]

Selects the type of HDMI signal output from HDMI OUT jack.

<b>[YCbCr]</b>	Outputs YCbCr signals.
<b>[RGB]</b>	Outputs RGB signals.

### Note

- If the playback picture becomes distorted, set [YCbCr] to [RGB].
- If the HDMI OUT jack is connected to equipment with a DVI jack, [RGB] signals will be automatically output even when you select [YCbCr].

■ **[SCREEN SAVER]**

The screen saver image appears when you leave the system in pause or stop mode for 15 minutes, or when you play back a Super Audio CD, CD, DATA CD (MP3 audio), or DATA DVD for more than 15 minutes. The screen saver will help prevent your display device from becoming damaged (ghosting). Press any button (e.g., ▷ button) to cancel the screen saver.

<b>[ON]</b>	Turns on the screen saver.
<b>[OFF]</b>	Turns off the screen saver.

■ **[BACKGROUND]**

Selects the background color or picture on the TV screen in stop mode or while playing a Super Audio CD, CD, DATA CD (MP3 audio), or DATA DVD.

<b>[JACKET PICTURE]</b>	The jacket picture (still picture) appears, but only when the jacket picture is already recorded on the disc (CD-EXTRA, etc.). If the disc does not contain a jacket picture, the [GRAPHICS] picture appears.
<b>[GRAPHICS]</b>	A preset picture stored in the system appears.
<b>[BLUE]</b>	The background color is blue.
<b>[BLACK]</b>	The background color is black.

■ **[BLACK LEVEL]**

Selects the black level (setup level) for the video signals output from the jacks other than COMPONENT VIDEO OUT/HDMI OUT.

<b>[ON]</b>	Sets the black level of the output signal to the standard level.
<b>[OFF]</b>	Lowers the standard black level. Use this when the picture becomes too white.

■ **[BLACK LEVEL (COMPONENT OUT)]**

Selects the black level (setup level) for the video signals output from the COMPONENT VIDEO OUT jacks.

You cannot select this and the setting is not effective when the system outputs progressive signal.

<b>[OFF]</b>	Sets the black level of the output signal to the standard level.
<b>[ON]</b>	Raise the standard black level. Use this when the picture becomes too black.

■ **[4:3 OUTPUT]**

This setting is effective only when you set [TV TYPE] in [SCREEN SETUP] to [16:9] (page 92). Adjust to watch 4:3 aspect ratio progressive signals. If you can change the aspect ratio on your progressive format compatible TV, change the setting on your TV, not the system. Note that this setting is effective only for HDMI connection or progressive signals output from the COMPONENT VIDEO OUT jacks.

**Note**

- This setting is effective only when “PROGRE AUTO (PROGRESSIVE AUTO)” or “PROGRE VIDEO (PROGRESSIVE VIDEO)” is selected by using PROGRESSIVE (page 94).

<b>[FULL]</b>	Select this when you can change the aspect ratio on your TV.
<b>[NORMAL]</b>	Select this when you cannot change the aspect ratio on your TV. Shows a 16:9 aspect ratio signal with black bands on left and right sides of the image.

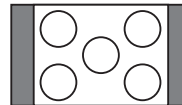

16:9 aspect ratio TV

## Does your TV accept progressive signals?

Progressive is the method for displaying TV images which reduces flickering, and sharpens the image. To display using this method, you need to connect to a TV that accepts progressive signals.

“PROGRE” lights up in the front panel display when the system outputs progressive signals.

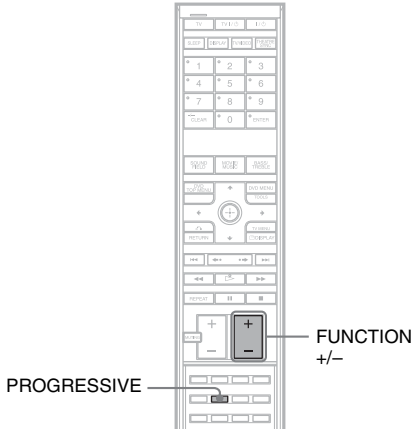

With the cover opened.

- 1 Press FUNCTION +/- repeatedly to select “DVD.”
- 2 Press PROGRESSIVE. Each time you press PROGRESSIVE, the display changes as follows:

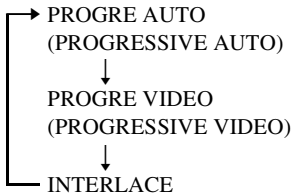

### ■ PROGRE AUTO (PROGRESSIVE AUTO)

Select this setting when:

- your TV accepts progressive signals, and,
- the TV is connected to the COMPONENT VIDEO OUT jacks.

Normally select this under the above condition. This automatically detects the software type, and selects the appropriate conversion method. Note that the picture will not be clear or no picture will appear if you select these settings when either of the above conditions are not met.

### ■ PROGRE VIDEO (PROGRESSIVE VIDEO)

Select this setting when:

- your TV accepts progressive signals, and,
- the TV is connected to the COMPONENT VIDEO OUT jacks, and,
- you want to fix the conversion method to PROGRESSIVE VIDEO for video-based software.

Select this if the image is not clear when you select PROGRESSIVE AUTO.

Note that the picture will not be clear or no picture will appear if you select these settings when either of the above conditions are not met.

### ■ INTERLACE

Select this setting when:

- your TV does not accept progressive signals, or,
- your TV is connected to jacks other than the COMPONENT VIDEO OUT jacks (MONITOR OUT (VIDEO/S VIDEO)).

You cannot select INTERLACE while “HDMI” lights up in the front panel display.

## About DVD software types and the conversion method

DVD software can be divided into 2 types: film-based software and video-based software.

Video-based software is derived from TV, such as dramas and sit-coms, and displays images at 30 frames/60 fields per second. Film-based software is derived from film and displays images at 24 frames per second. Some DVD software contains both video and film.

In order for these images to appear natural on your screen when output in progressive format, the progressive signals need to be converted to match the type of DVD software that you are watching.

### Note

- When you play video-based software in progressive signal format, sections of some types of images may appear unnatural due to the conversion process when output through the COMPONENT VIDEO OUT jacks. Even though you set to "PROGRESSIVE AUTO" or "PROGRESSIVE VIDEO," images from the MONITOR OUT (VIDEO or S VIDEO) jack are unaffected as they are output in the interlace format.

## Custom Settings

### [CUSTOM SETUP]

Use this to set up playback related and other settings.

Select [CUSTOM SETUP] in the Setup Display. To use the display, see "Using the Setup Display" (page 90).

The default settings are underlined.

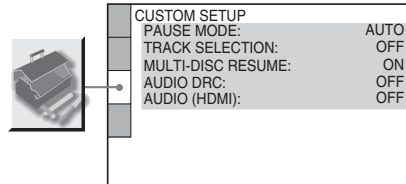

### ■ [PAUSE MODE] (DVD VIDEO/DVD-RW only)

Selects the picture in pause mode.

#### [AUTO]

The picture, including subjects that move dynamically, is output with no jitter. Normally select this position.

#### [FRAME]

The picture, including subjects that do not move dynamically, is output in high resolution.

### ■ [TRACK SELECTION] (DVD VIDEO only)

Gives the sound track which contains the highest number of channels priority when you play a DVD VIDEO on which multiple audio formats (PCM, DTS, MPEG audio, or Dolby Digital format) are recorded.

#### [OFF]

No priority given.

#### [AUTO]

Priority given.

### Note

- When you set the item to [AUTO], the language may change. The [TRACK SELECTION] setting has higher priority than the [AUDIO] settings in [LANGUAGE SETUP] (page 91). (Depending on the disc, this function may not work.)

continued

- If PCM, DTS, Dolby Digital sound, and MPEG audio tracks have the same number of channels, the system selects PCM, DTS, Dolby Digital sound, and MPEG audio tracks in this order.

■ **[MULTI-DISC RESUME] (DVD VIDEO/VIDEO CD only)**

Switches the Multi-disc Resume setting on or off.

---

<b>[ON]</b>	Stores the resume settings in memory for up to 40 discs.
<b>[OFF]</b>	Does not store the resume settings in memory. Playback restarts at the resume point only for the current disc in the system.

---

■ **[AUDIO DRC] (DVD VIDEO only)**

Narrows the dynamic range of the sound track. Useful for watching movies at low volume late at night.

---

<b>[OFF]</b>	No compression of dynamic range.
<b>[STANDARD]</b>	Reproduces the sound track with the kind of dynamic range that the recording engineer intended.
<b>[MAX]</b>	Compresses dynamic range fully.

---

■ **[AUDIO (HDMI)]**

Selects the type of audio signal output from the HDMI OUT jack.

---

<b>[OFF]</b>	The sound is not output from the HDMI OUT jack.
<b>[AUTO]</b>	Outputs audio signals that is matched to the requested audio stream from the connected TV.
<b>[PCM]</b>	Converts Dolby Digital, DTS (digital theater system), or 96 kHz/24 bit PCM (pulse code modulation) signals to 48 kHz/ 16 bit PCM (pulse code modulation).

---

**Note**

- A loud noise (or no sound) will be output if you connect the system to a TV that is not compatible with DOLBY DIGITAL/DTS (digital theater system) signals and [AUTO] is selected. In this case, select [PCM].
- When you connect the system and TV with the HDMI cord and [AUTO] or [PCM] is selected, AUDIO DRC, A/V SYNC, BASS/TREBLE, MOVIE/MUSIC, and sound field are not applied to the sound that is output from the TV.



# Settings for the Speakers

## [SPEAKER SETUP]

To obtain the best possible surround sound, set for the size of the speakers you have connected and their distance from your listening position. Then use the test tone to adjust the level and the balance of the speakers to the same level.

Select [SPEAKER SETUP] in the Setup Display. For details, see “Using the Setup Display” (page 90).

The default settings are underlined.

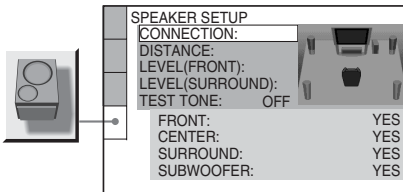

### To return to the default setting when changing a setting

Select the item, then press CLEAR. Note that only the [CONNECTION] setting does not return to the default setting.

#### ■[CONNECTION]

If you do not connect center or surround speakers, or move the surround speakers, set the parameters for [CENTER] and [SURROUND]. Since the front speaker and subwoofer setting is fixed, you cannot change them.

[FRONT]	<u>[YES]</u>
[CENTER]	<u>[YES]</u> : Normally select this. [NONE]: Select this if no center speaker is used.
[SURROUND]	<u>[YES]</u> : Normally select this. [NONE]: Select this if no surround speaker is used.
[SUBWOOFER]	<u>[YES]</u>

#### ■ [DISTANCE]

The default distance setting for the speakers in relation to the listening position is shown below. When you set the distance using the Quick Setup (page 30), the settings is automatically displayed.

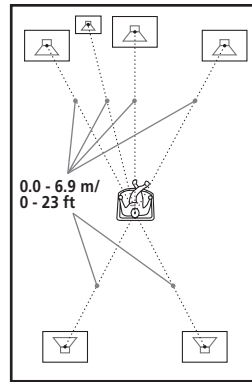

Be sure to change the value in the Setup Display when you move the speakers.

[FRONT L/R] <u>3.0 m/10 ft</u> *	Front speaker distance from the listening position can be set in 0.2 meter (1 ft) increments from 0.0 to 6.9 meters (0 to 23 ft).
[CENTER] <u>3.0 m/10 ft</u> * (appears when you set [CENTER] to [YES] in the [CONNECTION] setting.)	Center speaker distance from the listening position can be set in 0.2 meter (1 ft) increments from 0.0 to 6.9 meters (0 to 23 ft).
[SURROUND L/R] <u>3.0 m/10 ft</u> * (appears when you set [SURROUND] to [YES] in the [CONNECTION] setting.)	Surround speaker distance from the listening position can be set in 0.2 meter (1 ft) increments from 0.0 to 6.9 meters (0 to 23 ft).
[SUBWOOFER] <u>3.0 m/10 ft</u> *	Subwoofer distance from the listening position can be set in 0.2 meter (1 ft) increments from 0.0 to 6.9 meters (0 to 23 ft).

\* When you perform the Quick Setup (page 30), the default settings are changed.

#### Note

- When you set the distance, the sound cuts off for a moment.

- Depending on the input stream, the [DISTANCE] setting may not be effective.
- When the speaker distance setting is not in the recommended range,  $\Delta\uparrow/\Delta\downarrow$  \*\* m is displayed (\*\* being the number).  $\Delta\uparrow$  indicates over the recommended distance.  $\Delta\downarrow$  indicates below.

### ■ [LEVEL (FRONT)]

You can vary the level of front speakers as follows. Be sure to set [TEST TONE] to [ON] for easy adjustment.

<b>[L/R] 0.0 dB</b>	Set this between -15.0 dB and +10.0 dB in 1.0 dB increments.
<b>[CENTER] 0.0 dB</b> (appears when you set [CENTER] to [YES] in the [CONNECTION] setting.)	Set this between -15.0 dB and +10.0 dB in 1.0 dB increments.
<b>[SUBWOOFER] 0.0 dB</b>	Set this between -15.0 dB and +10.0 dB in 1.0 dB increments.

### ■ [LEVEL (SURROUND)]

You can vary the level of surround speakers as follows. Be sure to set [TEST TONE] to [ON] for easy adjustment.

<b>[L/R] 0.0 dB</b> (appears when you set [SURROUND] to [YES] in the [CONNECTION] setting.)	Set this between -15.0 dB and +10.0 dB in 1.0 dB increments.
--	--

## To adjust the volume of all the speakers at one time

Press VOLUME +/- on the remote or touch VOLUME +/- (touch panel button) on the control unit.

### ■ [TEST TONE]

The speakers will emit a test tone to adjust [LEVEL (FRONT)] and [LEVEL (SURROUND)].

<b>[OFF]</b>	The test tone is not emitted from the speakers.
<b>[ON]</b>	The test tone is emitted from each speaker in sequence while adjusting level. When you select one of the [SPEAKER SETUP] items, the test tone is emitted from each speaker in sequence.

## Adjusting the speaker level by using the test tone

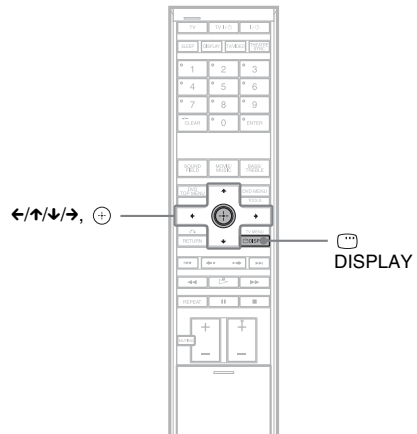

- 1 Press **DISPLAY** when the system is in stop mode.  
The Control Menu appears.
- 2 Press  $\uparrow/\downarrow$  to select **[SETUP]**, then press **+**.  
The options for [SETUP] appear.
- 3 Press  $\uparrow/\downarrow$  to select **[CUSTOM]**, then press **+**.  
The Setup Display appears.
- 4 Press  $\uparrow/\downarrow$  repeatedly to select **[SPEAKER SETUP]**, then press **+** or **→**.
- 5 Press  $\uparrow/\downarrow$  repeatedly to select **[TEST TONE]**, then press **+** or **→**.
- 6 Press  $\uparrow/\downarrow$  repeatedly to select **[ON]**, then press **+**.  
You will hear the test tone from each speaker in sequence.
- 7 From your listening position, adjust the value of **[LEVEL (FRONT)]** or **[LEVEL (SURROUND)]** using  $\leftarrow/\uparrow/\downarrow/\rightarrow$ .  
The test tone is emitted from only the speaker which you are adjusting.
- 8 Press **+** when you have finished making adjustments.

**9** Press  $\uparrow/\downarrow$  repeatedly to select [TEST TONE], then press  $\oplus$ .

**10** Press  $\uparrow/\downarrow$  repeatedly to select [OFF], then press  $\oplus$ .

**Note**

- When you adjust the speaker settings, the sound cuts off for a moment.
- The test tone signals are not output from the HDMI OUT jack.

## Placing the surround speaker (L) in the (R) position

Depending on the location of the wall outlet (mains), you can also place the surround speaker (L) (with the IR receiver) in the (R) position if necessary.

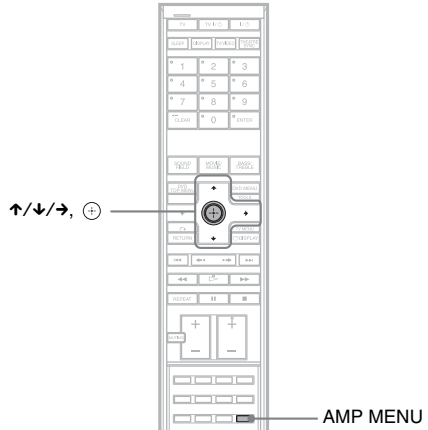

With the cover opened.

- 1** Press AMP MENU.
- 2** Press  $\uparrow/\downarrow$  repeatedly until “SL SR REVERSE” appears in the front panel display, then press  $\oplus$  or  $\rightarrow$ .
- 3** Press  $\uparrow/\downarrow$  to select the setting.  
The default setting is underlined.
  - OFF: Sets the surround speaker (L) (with the IR receiver) in the (L) position.
  - ON: Sets the surround speaker (L) (with the IR receiver) in the (R) position.
- 4** Press  $\oplus$ .
- 5** Press AMP MENU.  
The AMP menu turns off.

## Returning to the Default Settings

### Returning the settings on the Setup Display to the default

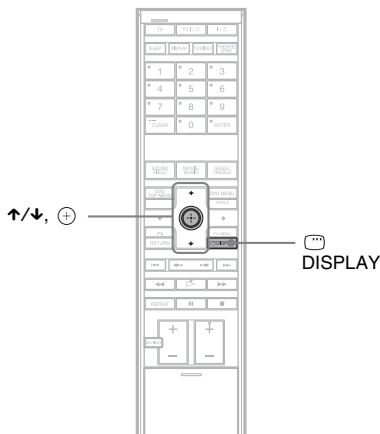

**1** Select [RESET] in Step 3 of “Using the Setup Display” (page 90) and press ⊕.

**2** Select [YES] using ↑/↓.

You can also quit the process and return to the Control Menu by selecting [NO] here.

**3** Press ⊕.

All the settings explained on pages 91 to 99 return to the default settings. Do not press I/⏻ while resetting the system as it takes a few seconds to complete.

#### Note

- When you turn the system on after resetting and no disc is in the control unit, the guide message appears on the TV screen. To perform the Quick Setup (page 30), press ⊕, to return to normal screen, press CLEAR.

### Returning the sound field settings or radio settings to the default

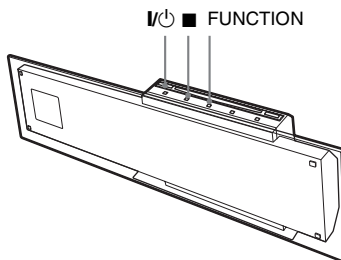

**1** Press I/⏻ to turn on the system.

**2** While pressing ■, press FUNCTION and I/⏻ on the control unit at the same time.

“COLD RESET” appears in the front panel display and the default settings are returned.

## Additional Information

### Precautions

#### On power sources

- Unplug the unit from the wall outlet if you do not intend to use it for an extended period of time. To disconnect the cord, pull it out by the plug, never by the cord.

#### On placement

- Place the system in a location with adequate ventilation to prevent heat build-up in the system.
- At high volume, over long periods of time, the cabinet becomes hot to the touch. This is not a malfunction. However, touching the cabinet should be avoided. Do not place the unit in a confined space where ventilation is poor as this may cause overheating.
- Do not block the ventilation slots by putting anything on the system. The system is equipped with a high power amplifier. If the ventilation slots are blocked, the unit can overheat and malfunction.
- Do not place the unit on surfaces (rugs, blankets, etc.) or near materials (curtains, draperies) that may block the ventilation slots.
- Do not install the unit near heat sources such as radiators, or air ducts, or in a place subject to direct sunlight, excessive dust, mechanical vibration, or shock.
- Do not install the unit in an inclined position. It is designed to be operated in a horizontal position only.
- Keep the unit and discs away from equipment with strong magnets, such as microwave ovens, or large loudspeakers.
- Do not place heavy objects on the unit.

#### On operation

- If the system is brought directly from a cold to a warm location, or is placed in a very damp room, moisture may condense on the lenses inside the control unit. Should this occur, the system may not operate properly. In this case, remove the disc and leave the system turned on for about half an hour until the moisture evaporates.
- When you move the system, take out any disc. If you don't, the disc may be damaged.
- If anything falls into the cabinet, unplug the unit and have it checked by qualified personnel before operating it any further.

#### On adjusting volume

- Do not turn up the volume while listening to a section with very low level inputs or no audio signals. If you do, the speakers may be damaged when a peak level section is suddenly played.

#### On cleaning

- Clean the cabinet, panel, and controls with a soft cloth slightly moistened with a mild detergent solution. Do not use any type of abrasive pad, scouring powder or solvent such as alcohol or benzene.  
If you have any questions or problems concerning your system, please consult your nearest Sony dealer.

#### On cleaning discs, disc/lens cleaner

- **Do not use a commercially available cleaning disc or disc/lens cleaner (wet or spray type). These may cause apparatus to malfunction.**

#### On your TV's color

- If the speakers should cause the TV screen to have color irregularity, turn off the TV then turn it on after 15 to 30 minutes. If color irregularity should persist, place the speakers further away from the TV set.

#### IMPORTANT NOTICE

Caution: This system is capable of holding a still video image or on-screen display image on your television screen indefinitely. If you leave the still video image or on-screen display image displayed on your TV for an extended period of time you risk permanent damage to your television screen. Projection televisions are especially susceptible to this.

#### On moving the system

When you carry the system, use the following procedure to protect the inner mechanism.

- 1 Press FUNCTION +/- repeatedly until "DVD" appears in the front panel display.
- 2 Make sure that a disc is removed from the control unit.
- 3 Press **■**, **▲**, and **I/⏻** simultaneously. "MECHA LOCK" appears in the front panel display after "STANDBY."
- 4 Remove the AC power cord (mains lead) from the wall outlet (mains).

## Notes about the Discs

### On handling discs

- To keep the disc clean, handle the disc by its edge. Do not touch the surface.
- Do not stick paper or tape on the disc.



- Do not expose the disc to direct sunlight or heat sources such as hot air ducts, or leave it in a car parked in direct sunlight as the temperature may rise considerably inside the car.
- After playing, store the disc in its case.

### On cleaning

- Before playing, clean the disc with a cleaning cloth.  
Wipe the disc from the center out.



- Do not use solvents such as benzine, thinner, commercially available cleaners, or anti-static spray intended for vinyl LPs.

## Troubleshooting

If you experience any of the following difficulties while using the system, use this troubleshooting guide to help remedy the problem before requesting repairs. Should any problem persist, consult your nearest Sony dealer.

Note that if service personnel changes some parts during repair, these parts may be retained. In the event of a problem, have a Sony dealer check the entire system together (system, IR transmitter, and surround speaker (L)).

### Power

---

#### The power is not turned on.

- Check that the AC power cords (mains leads) of the subwoofer and the AC adaptor is connected securely.

---

#### The I/O indicator on the control unit flashes.

Press I/O to turn off the system, and check the following items.

- Are the + and - speaker cords short-circuited?
- Are you using only the specified speakers?
- Is anything blocking the ventilation holes of the system?

After checking the above items and fixing any problems, turn on the system. If the cause of the problem cannot be found even after checking all the above items, consult your nearest Sony dealer.

---

#### The IR status indicator on the surround speaker (L) does not turn on.

- Press POWER to turn the AC adaptor off, connect the speakers properly, and then press POWER to turn the AC adaptor on.

### Picture

---

#### There is no picture.

- The video connecting cords are not connected securely.
- The video connecting cords are damaged.
- The system is not connected to the correct TV input jack (page 22, 36).
- The video input on the TV is not set so that you can view pictures from the system.
- You have set progressive format but your TV cannot accept the signal in progressive format. In this case, return the setting to interlace format (the default setting) (page 94).

- The system outputs the video signal, only when the function is set to “DVD.”
- Even if your TV is compatible with progressive format (525p) signals, the image may be affected when you set progressive format. In this case, return the setting to interlace format (the default setting) (page 94).
- The system is connected to an input device that is not HDCP (high-bandwidth digital content protection) compliant (“HDMI” on the front panel does not light up). See page 115.
- If the HDMI OUT jack is used for video output, changing the [HDMI RESOLUTION] setting in [SCREEN SETUP] may solve the problem (page 92).  
Connect the TV and the system using a video jack other than the HDMI OUT, and switch the TV’s input to the connected video input so that you can see the on-screen displays. Change the [HDMI RESOLUTION] setting in [SCREEN SETUP], and switch the TV’s input back to HDMI. If the picture still does not appear, repeat the steps and try other options.
- You have selected “PROGRESSIVE AUTO” or “PROGRESSIVE VIDEO” using the PROGRESSIVE button on the remote (“PROGRE” lights up in the front panel display) even though your TV cannot accept the progressive signal. In this case, disconnect the HDMI cord from the system and then select “INTERLACE” so that the PROGRESSIVE indicator turns off.
- If the signal from the video output jack (except for the HDMI jack) is distorted, change the [HDMI RESOLUTION] setting in [SCREEN SETUP] to [720 × 480p].
- When connecting to the TV with the HDMI cord, you need the proper setting for the HDMI input depending on the TV. Check the HDMI setting of the TV.

---

### Picture noise appears.

- The disc is dirty or flawed.
- If the picture output from your system goes through your VCR to get to your TV, the copy-protection signal applied to some DVD programs could affect picture quality. If you still experience problems even when you connect your system directly to your TV, try connecting your system to your TV’s video input (except for the HDMI jack) (page 36).

---

### Even though you set the aspect ratio in [TV TYPE] of [SCREEN SETUP], the picture does not fill the screen.

- The aspect ratio on the disc is fixed.

---

### Color irregularity occurs on the TV screen.

All speakers in this system are magnetically shielded to prevent magnetic leakage. However, some leakage may occur, as a high-strength magnet is employed. If this happens, check the following items:

- If the speakers are used with a CRT-based TV or projector, install the speakers at least 0.3 m (1.0 ft) from the TV set.
- If the color irregularity persists, turn off the TV set once, then turn it on after 15 to 30 minutes.
- If howling occurs, reposition the speakers further away from the TV set.
- Make sure that no magnetic object (magnetic latch on a TV stand, health care device, toy, etc.) is placed near the speakers.

---

### Sound

---

#### There is no sound.

- The speaker cord is not connected securely.
- Press MUTE on the remote if “Muting On” is displayed in the front panel display.
- The system is in pause mode or in Slow-motion Play mode. Press ▷ to return to normal play mode.
- Fast forward or fast reverse is performed. Press ▷ to return to normal play mode.
- Check the speaker settings (page 97).
- If the connected component’s sound is not output, check the audio output settings of it.

---

#### No sound is output from the HDMI OUT jack.

- Set [AUDIO (HDMI)] in [CUSTOM SETUP] to [AUTO] or [PCM] (page 96).
- The HDMI OUT jack is connected to a DVI (digital visual interface) device (DVI (digital visual interface) jacks do not accept audio signals).
- The HDMI OUT jack does not output Super Audio CD signals.
- Try the following: ① Turn the system off and on again. ② Turn the connected equipment off and on again. ③ Disconnect and then connect the HDMI cord again.
- The equipment connected to the HDMI OUT jack does not conform to the audio signal format, in this case set [AUDIO (HDMI)] in [CUSTOM SETUP] to [PCM] (page 96).

*continued*

---

**The left and right sounds are unbalanced or reversed.**

- Check that the speakers and components are connected correctly and securely.
- Perform [AUTO CALIBRATION] (page 87).

---

**Severe hum or noise is heard.**

- Check that the speakers and components are connected securely.
- Check that the connecting cords are away from a transformer or motor, and at least 3 meters (10 ft) away from your TV set or a fluorescent light.
- Move your TV away from the audio components.
- The plugs and jacks are dirty. Wipe them with a cloth slightly moistened with alcohol.
- Clean the disc.

---

**The sound loses stereo effect when you play a VIDEO CD, a CD, or an MP3.**

- Set [AUDIO] to [STEREO] by pressing AUDIO (page 59).
- Make sure the system is connected properly.

---

**The surround effect is difficult to hear when you are playing a Dolby Digital, DTS, or MPEG audio sound track.**

- Make sure the sound field is not "2Channel Stereo" (page 48).
- Check the speaker connections and settings (page 22, 97).
- Depending on the DVD, the output signal may not be the entire 5.1 channel. It may be monaural or stereo even if the sound track is recorded in Dolby Digital or MPEG audio format.

---

**The sound comes from the center speaker only.**

- Depending on the disc, the sound may come from the center speaker only.

---

**No sound is heard from the center speaker.**

- Check the speaker connections and settings.
- Make sure the sound field is not "2Channel Stereo" (page 48).
- Depending on the source, the effect of the center speaker may be less noticeable.

---

**No sound or only a very low-level sound is heard from the surround speakers.**

- Check the speaker connections and settings.
- Make sure the sound field is not "2Channel Stereo" (page 48).
- Depending on the source, the effect of the surround speakers may be less noticeable.
- Wireless setting of the surround speaker is not correct (page 29).

- The plasma display may interfere with transmission, in which case, adjust the position of the IR transmitter and IR receiver of the surround speaker (L) (page 29).
- Do not install the surround speaker (L) in a place exposed to direct sunlight or strong light such as an incandescent lamp.
- Clean the surface of the IR transmitter and IR receiver of the surround speaker (L).

---

**Operation**

---

**Radio stations cannot be tuned in.**

- Check that the antenna (aerial) is connected securely. Adjust the antenna (aerial) or connect an external antenna (aerial) if necessary.
- The signal strength of the stations is too weak (when tuning in with automatic tuning). Use direct tuning.
- No stations have been preset or the preset stations have been cleared (when tuning by scanning preset stations). Preset the stations (page 75).
- Press DISPLAY so that the frequency appears in the front panel display.

---

**The remote does not function.**

- There are obstacles between the remote and the control unit.
- The distance between the remote and the control unit is too far.
- The remote is not pointed at the remote sensor on the control unit.
- The batteries in the remote are weak.

---

**The IR status indicator on the surround speaker (L) momentarily turns orange.**

- The indicator momentarily turns orange. This is not a malfunction.
- There is obstruction, such as a person or object between the IR transmitter and the IR receiver of the surround speaker (L). Adjust the IR transmitter and the IR receiver of the surround speaker (L) (page 29).

---

**The disc does not play.**

- There is no disc inserted.
- The disc is upside down.  
Insert the disc with the playback side facing down.
- The system cannot play CD-ROMs, etc. (page 6).
- The region code on the DVD does not match the system.
- Moisture has condensed inside the system and may cause damage to the lenses. Remove the disc and leave the system turned on for about half an hour.



---

**The MP3 audio track cannot be played.**

- The DATA CD is not recorded in the MP3 format that conforms to ISO 9660 Level 1/Level 2, or Joliet.
- The DATA DVD is not recorded in an MP3 format that conforms to UDF (Universal Disk Format).
- The MP3 audio track does not have the extension “.MP3.”
- The data is not formatted in MP3 even though it has the extension “.MP3.”
- The data is not MPEG1 Audio Layer 3 data.
- The system cannot play audio tracks in MP3PRO format.
- The [MODE (MP3, JPEG)] setting has been set to [IMAGE (JPEG)] (page 71).
- If you cannot change the [MODE (MP3, JPEG)] setting, re-load the disc or turn the system off, then on.

---

**The JPEG image file cannot be played.**

- The DATA CD is not recorded in a JPEG format that conforms to ISO 9660 Level 1/Level 2, or Joliet.
- The DATA DVD is not recorded in a JPEG format that conforms to UDF (Universal Disk Format).
- It has an extension other than “.JPEG” or “.JPG.”
- It is larger than 3,072 (width) × 2,048 (height) in normal mode, or more than 2,000,000 pixels in Progressive JPEG which is mainly used on the Internet WEB site.
- It does not fit the screen (those images are reduced).
- The [MODE (MP3, JPEG)] setting has been set to [AUDIO (MP3)] (page 71).
- If you cannot change the [MODE (MP3, JPEG)] setting, re-load the disc or turn the system off, then on.

---

**The MP3 audio tracks and JPEG image file starts playing simultaneously.**

- [AUTO] has been selected in [MODE (MP3, JPEG)] (page 71).

---

**The titles of album/track/file name are not displayed correctly.**

- The system can only display numbers and letters of the alphabets. Other characters are displayed as [\*].

---

**A disc does not start playing from the beginning.**

- Program Play, Shuffle Play, or Repeat Play has been selected.  
Press CLEAR to cancel these functions before playing a disc.

- Resume Play has been selected.  
During stop, press ■ on the control unit or the remote and then start playback (page 54).
- The title, DVD or PBC menu automatically appears on the TV screen.

---

**The system starts playing the disc automatically.**

- The DVD features an auto playback function.

---

**Playback stops automatically.**

- Some discs may contain an auto pause signal.  
While playing such a disc, the system stops playback at the auto pause signal.

---

**You cannot perform some functions such as Stop, Search, Slow-motion Play, or Repeat Play.**

- Depending on the disc, you may not be able to perform some of the operations above. See the operating manual that came with the disc.

---

**Messages do not appear on the screen in the language you want.**

- In the Setup Display, select the desired language for the on-screen display in [OSD] under [LANGUAGE SETUP] (page 91).

---

**The language for the sound track cannot be changed.**

- Multilingual tracks are not recorded on the DVD being played.
- The DVD prohibits changing the language for the sound track.

---

**The subtitle language cannot be changed.**

- Multilingual subtitles are not recorded on the DVD being played.
- The DVD prohibits changing the subtitles.

---

**The subtitle cannot be turned off.**

- The DVD prohibits turning off subtitles.

---

**The angles cannot be changed.**

- Multi-angles are not recorded on the DVD being played (page 65).
- The DVD prohibits changing the angles.

---

**A disc cannot be ejected and “LOCKED” appears in the front panel display.**

- Contact your Sony dealer or local authorized Sony service facility.

---

**[Data error] appears on the TV screen when playing a DATA CD or DATA DVD.**

- The MP3 audio track/JPEG image file you want to play is broken.
- The data is not MPEG1 Audio Layer 3 data.
- The JPEG image file format does not conform to DCF.

*continued*

- The JPEG image file has the extension “.JPG” or “.JPEG,” but is not in JPEG format.

---

**The system does not work normally.**

- Disconnect the AC power cord (mains lead) from the wall outlet (mains), then reconnect after several minutes.

---

**“DEMO PLAY” appears in the front panel display.**

- Contact your Sony dealer or local authorized Sony service facility.

## Self-diagnosis Function

### *(When letters/numbers appear in the display)*

When the self-diagnosis function is activated to prevent the system from malfunctioning, a 5-character service number (e.g., C 13 50) with a combination of a letter and 4 digits appears on the screen or the front panel display. In this case, check the following table.

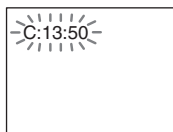

TV screen example

<b>First 3 characters of the service number</b>	<b>Cause and/or corrective action</b>
C 13	The disc is dirty. ➔ Clean the disc with a soft cloth (page 102).
C 31	The disc is not inserted correctly. ➔ Restart the system, then re-insert the disc correctly.
E XX (xx is a number)	To prevent a malfunction, the system has performed the self-diagnosis function. ➔ Contact your nearest Sony dealer or local authorized Sony service facility and give the 5-character service number. Example: E 61 10

### **When displaying the version number on the screen**

When you turn on the system, the version number [VER.X.XX] (X is a number) may appear on the screen. Although this is not a malfunction and for Sony service use only, normal system operation will not be possible. Turn off the system, and then turn on the system again to operate.



# Specifications

## AUDIO POWER SPECIFICATIONS

### for the US model

#### POWER OUTPUT AND TOTAL HARMONIC DISTORTION

(FTC Output Power): Front L/Front R/Center:  
60 W/ch 4 ohms at 170 -  
20,000 Hz, 0.7 % THD  
Surround L/Surround R:  
60 W/ch 3.5 ohms at 170 -  
20,000 Hz, 0.7 % THD  
Subwoofer: 110 W/ch 1.5  
ohms at 40 - 170 Hz, 0.7 %  
THD

#### Amplifier section

Surround mode (reference) Front: 100 W + 100 W  
(RMS OUTPUT POWER,  
10 % THD 1 kHz, 4 ohms)  
Center\*: 100 W (RMS  
OUTPUT POWER, 10 %  
THD 1 kHz, 4 ohms)  
Surround\*: 100 W +  
100 W (RMS OUTPUT  
POWER, 10 % THD 1 kHz,  
3.5 ohms)  
Subwoofer\*: 280 W (RMS  
OUTPUT POWER, 10 %  
THD 100 Hz, 1.5 ohms)

\* Depending on the sound field settings and the source,  
there may be no sound output.

#### Inputs (Analog)

TV, VIDEO 1, VIDEO 2 (AUDIO IN)

Sensitivity: 450/250 mV

#### Inputs (Digital)

VIDEO 1, VIDEO 2 (COAXIAL)

impedance: 75 ohms

#### Super Audio CD/DVD system

##### Laser

Semiconductor laser  
(Super Audio CD/DVD:  
 $\lambda = 645 - 660$  nm)  
(CD:  $\lambda = 770 - 800$  nm)  
Emission duration:  
continuous

#### Signal format system

NTSC

#### Tuner section

##### System

PLL quartz-locked digital  
synthesizer system

##### FM tuner section

Tuning range 87.5 - 108.0 MHz  
(100 kHz step)

##### Antenna (aerial)

FM wire antenna (aerial)

Antenna (aerial) terminals 75 ohms, unbalanced

Intermediate frequency 10.7 MHz

##### AM tuner section

Tuning range 530 - 1,710 kHz (with the  
interval set at 10 kHz)

531 - 1,710 kHz (with the  
interval set at 9 kHz)

##### Antenna (aerial)

AM loop antenna (aerial)

Intermediate frequency 450 kHz

#### Video section

##### Outputs

VIDEO: 1 Vp-p 75 ohms

S VIDEO:

Y: 1 Vp-p 75 ohms

C: 0.286 Vp-p 75 ohms

COMPONENT:

Y: 1 Vp-p 75 ohms

Pb/Cb, Pr/Cr: 0.7 Vp-p  
75 ohms

##### Inputs

VIDEO 1: 1 Vp-p 75 ohms

VIDEO 2: 1 Vp-p 75 ohms

#### Speakers

##### Front

##### Speaker system

Closed, magnetically  
shielded

##### Speaker unit

Woofer: 70 × 120 mm  
(2 7/8 × 4 3/4 inches) cone  
type

Tweeter: 25 mm (1 inch)  
dome type

##### Rated impedance

4 ohms

##### Dimensions (approx.)

105 × 705 × 35 mm  
(4 1/4 × 27 7/8 × 1 1/16 inches)  
(w/h/d)

302 × 1,300 (max) ×  
302 mm

(12 × 51 1/4 (max) ×  
12 inches)

(w/h/d) with stand

2.1 kg (4 lb 11 oz)

5.9 kg (13 lb 1 oz) with  
stand

##### Mass (approx.)

#### Surround (R)

##### Speaker system

Closed, magnetically  
shielded

##### Speaker unit

Woofer: 70 × 120 mm  
(2 7/8 × 4 3/4 inches) cone  
type

Tweeter: 25 mm (1 inch)  
dome type

##### Rated impedance

3.5 ohms

Dimensions (approx.)	105 × 705 × 35 mm (4 1/4 × 27 7/8 × 1 1/16 inches) (w/h/d) 302 × 1,300 (max) × 302 mm (12 × 51 1/4 (max) × 12 inches) (w/h/d) with stand
Mass (approx.)	2.0 kg (4 lb 7 oz) 5.8 kg (12 lb 13 oz) with stand

### Surround (L)

Speaker system	Closed, magnetically shielded
Speaker unit	Woofer: 70 × 120 mm (2 7/8 × 4 3/4 inches) cone type Tweeter: 25 mm (1 inch) dome type
Rated impedance	3.5 ohms
Dimensions (approx.)	105 × 705 × 35 mm (4 1/4 × 27 7/8 × 1 1/16 inches) (w/h/d) 302 × 1,300 (max) × 302 mm (12 × 51 1/4 (max) × 12 inches) (w/h/d) with stand
Mass (approx.)	2.5 kg (5 lb 9 oz) 6.3 kg (13 lb 15 oz) with stand

### Center

Speaker system	Closed, magnetically shielded
Speaker unit	Woofer: 70 × 120 mm (2 7/8 × 4 3/4 inches) dia. cone type Tweeter: 25 mm (1 inch) dome type
Rated impedance	4.0 ohms
Dimensions (approx.)	545 × 105 × 35 mm (21 1/2 × 4 1/4 × 1 1/16 inches) (w/h/d) 545 × 116 × 60 mm (21 1/2 × 4 3/8 × 2 3/8 inches) (w/h/d) with stand
Mass (approx.)	1.9 kg (4 lb 4 oz) 2.1 kg (4 lb 11 oz) with stand

### Subwoofer

Speaker system	Bass reflex, magnetically shielded
Speaker unit	150 mm (6 inches) cone type

Rated impedance	1.5 ohms
Dimensions (approx.)	188 × 573 × 318 mm (7 1/2 × 22 3/8 × 12 3/8 inches) (w/h/d)
Mass (approx.)	14.5 kg (32 lb)
Power requirements	120 V AC, 60 Hz
Power consumption	130 W 0.3 W (at the Power Saving mode)

### Control unit

Dimensions (approx.)	570 × 168 × 56 mm (22 1/2 × 6 3/8 × 2 1/4 inches) (w/h/d) 570 × 188 × 99 mm (22 1/2 × 7 1/2 × 4 inches) (w/h/d) with stand
Mass (approx.)	4.2 kg (9 lb 5 oz) 4.7 kg (10 lb 6 oz) with stand

### AC adaptor

Power requirements	120 V AC, 60 Hz
Power consumption	45 W
Dimensions (approx.)	219 × 44 × 82 mm (8 3/8 × 1 3/4 × 3 1/4 inches) (w/h/d)
Mass (approx.)	0.7 kg (1 lb 9 oz)

Design and specifications are subject to change  
without notice.

## Unpacking

- Control unit (1)
  - Speakers (5)
  - Subwoofer (1)
  - AC adaptor (1)
  - AM loop antenna (aerial) (1)
  - FM wire antenna (aerial) (1)
  - Speaker cords (5 m × 2, 3.5 m × 1, 10 m × 1)  
(16.5 ft. × 2, 11.5 ft. × 1, 33 ft. × 1)
  - Video Cord (1)
  - Remote Commander (remote) (1)
  - R6 (size AA) batteries (2)
  - Calibration mic (1)
  - Posts (4)
  - Bases (4)
  - Speaker adaptors (4)
  - Speaker adaptor covers (4)
  - Cord clamp (1)
  - Adjuster (1)
  - Center speaker base (1)
  - Control unit stand (1)
  - Control unit stand cover (1)
  - Screws (24)
  - IR transmitter (1)\*
  - IR receiver (1)\*\*
  - IR receiver stand (1)\*\*
  - Operating Instructions
  - Quick Start Guide (card) (1)
- \* The IR receiver cord and IR transmitter are for this system only. You cannot use a commercially available extension cord.
- \*\* Used when the IR receiver of the surround speaker (L) cannot receive infrared ray because of the position. For details, see "Using the IR Receiver" (page 33).

## Glossary

### Album

Section of a music piece or an image on a data CD containing MP3 audio tracks or JPEG files.

### Chapter

Subdivision of a title on a DVD. A title is composed of several chapters.

### Digital Cinema Auto Calibration

Digital Cinema Auto Calibration was developed by Sony to automatically measure and adjust the speaker settings to your listening environment in a short period of time.

### Digital Direct Twin Drive Subwoofer

Utilizing Sony's proprietary S-Master technology, the Digital Direct Twin Drive Subwoofer features two S-Master Digital Amplifiers that provide dedicated power to a strategically located subwoofer for astounding sound performance. Easy to set up, Digital Direct Twin Drive Subwoofer provides a stable sound field over a much larger listening area without having to adjust frequency levels.

### Digital Infrared Audio Transmission

Recent times have been witness to the rapid spread of DVDs, Digital Broadcasting Satellite Receiver and other high-quality media. In order to ensure that the subtle nuances endowed by these high-quality media would be transmitted with no accompanying deterioration, Sony developed a technology called "Digital Infrared Audio Transmission" for the infrared transmission of digital audio signals using no compression, and it introduced it into the system.

This technology transfers digital audio signals using no compression inside the subcarrier frequency band allocated by the IEC (International Electronic Committee) and JEITA (Japan Electronics and Information Technology Industries Association) for hi-fi audio transmission applications. (See Fig. 1)

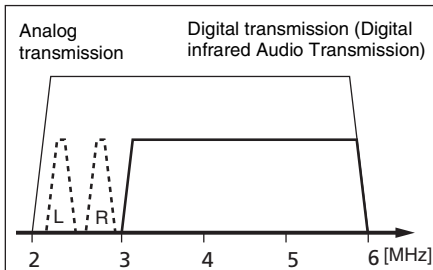

Fig. 1 Signal spectrum for digital infrared audio transmission

### Dolby Digital

This movie theater sound format is more advanced than Dolby Surround Pro Logic. In this format, the surround speakers output stereo sound with an expanded frequency range, and a subwoofer channel for deep bass is independently provided. This format is also called "5.1" with the subwoofer channel designed as the 0.1 channel (since it functions only when a deep bass effect is needed). All six channels in this format are recorded separately for superior channel separation. Furthermore, since all the signals are processed digitally, less signal degradation occurs.

### Dolby Pro Logic II

Dolby Pro Logic II creates five full-bandwidth output channels from 2 channel sources. This is done using an advanced, high-purity matrix surround decoder that extracts the spatial properties of the original recording without adding any new sounds or tonal colorations.

#### ■ Movie mode

The Movie mode is for use with stereo television shows and all programs encoded in Dolby Surround. The result is enhanced soundfield directionality that approaches the quality of discrete 5.1-channel sound.

#### ■ Music mode

The Music mode is for use with any stereo music recordings, and provides a wide and deep sound space.

### DTS

Digital audio compression technology developed by Digital Theater Systems, Inc. This technology conforms to 5.1-channel surround. This format comprises of stereo rear channel and there is discrete subwoofer channel in this format. DTS provides the same 5.1 discrete channels of high quality digital audio. The good channel separation is realized due to the all channel data being recorded discretely and processed in digitally.

### DVD

A disc that contains up to 8 hours of moving pictures even though its diameter is the same as a CD.

The data capacity of a single-layer and single-sided DVD, at 4.7 GB (Giga Byte), is 7 times that of a CD. Furthermore, the data capacity of a dual-layer and single-sided DVD is 8.5 GB, a single-layer and double-sided DVD 9.4 GB, and a dual-layer and double-sided DVD 17 GB.

The picture data uses the MPEG 2 format, one of a worldwide standard of digital compression technology. The picture data is compressed to about 1/40 of its original size. The DVD also uses the variable rate coding technology that processes allocated data according to the status of the picture.

The audio data is recorded in Dolby Digital as well as in PCM, allowing you to enjoy more realistic audio presence.

Furthermore, various advanced functions such as the multi-angle, multilingual, and Parental Control functions are provided with the DVD.

### DVD-RW

A DVD-RW is a recordable and rewritable disc that is the same size as a DVD VIDEO. The DVD-RW has two different modes: VR mode and Video mode. DVD-RWs created in Video mode have the same format as a DVD VIDEO, while discs created in VR (Video Recording) mode allow the contents to be programmed or edited.

### DVD+RW

A DVD+RW (plus RW) is a recordable and rewritable disc. DVD+RWs use a recording format that is comparable to the DVD VIDEO format.

**File**

A JPEG image recorded on a DATA CD/DATA DVD. ("File" is an exclusive definition for this system.) A single file consists of a single image or movie.

**Film based software, Video based software**

DVDs can be classified as Film based or Video based software. Film based DVDs contain the same images (24 frames per second) that are shown at movie theaters. Video based DVDs, such as television dramas or sit-coms, displays images at 30 frames (or 60 fields) per second.

**HDMI (high-definition multimedia interface)**

HDMI is an interface that supports both video and audio on a single digital connection. The HDMI connection carries standard to high definition video signals and multi-channel audio signals to AV components such as HDMI equipped TVs, in digital form without degradation. Since the video signals are compatible with the current DVI (digital visual interface) format, HDMI jacks can be connected to DVI (digital visual interface) jacks by way of an HDMI -DVI (digital visual interface) converter cord. The HDMI specification supports HDCP (high-bandwidth digital contents protection), a copy protection technology that incorporates coding technology for digital video signals.

**Interlace format (Interlaced scanning)**

The Interlace format is the NTSC standard method for displaying TV images at 30 frames per second. Each frame is scanned twice - alternately between the even numbered scanning lines and then odd numbered scanning lines, at 60 times per second.

**Mica-reinforced-cellular-diaphragm**

The Mica-reinforced-cellular-diaphragm is made of a light weight and highly rigid composite material that consists of Mica flake and synthetic fiber. It is constructed with layers of Mica flake. This construction realizes diaphragm with low density and high rigidity at the same time.

In this system, a Mica-reinforced-cellular-diaphragm is used for the subwoofer.

**Multi-angle function**

Various angles of a scene, or viewpoints of the video camera are recorded on some DVDs.

**Multilingual function**

Several languages for the sound or subtitles in a picture are recorded on some DVDs.

**Parental Control**

A function of the DVD to limit playback of the disc by the age of the users according to the limitation level in each country. The limitation varies from disc to disc; when it is activated, playback is completely prohibited, violent scenes are skipped or replaced with other scenes and so on.

**Playback Control (PBC)**

Signals encoded on VIDEO CDs (Version 2.0) to control playback.

By using menu screens recorded on VIDEO CDs with PBC functions, you can enjoy playing simple interactive programs, programs with search functions, and so on.

**Progressive format (sequential scanning)**

In contrast to the Interlace format, the progressive format can reproduce 50 - 60 frames per second by reproducing all scanning lines (525 lines for the NTSC system). The overall picture quality increases and still images, text and horizontal lines appear sharper. This format is compatible with the 525 or 625 progressive format.

**Region Code**

This system is used to protect copyrights. A region number is allocated on each DVD system or DVD disc according to the sales region. Each region code is shown on the system as well as on the disc packaging. The system can play discs that match its region code. The system can also play discs with the "Ⓜ" mark. Even when the region code is not shown on the DVD, the region limit may still apply.

**Scene**

On a VIDEO CD with PBC (playback control) functions, the menu screens, moving pictures and still pictures are divided into sections called "scenes."

**Title**

The longest section of a picture or music feature on a DVD, movie, etc., in video software, or the entire album in audio software.

**Track**

Section of a picture or a music piece on a VIDEO CD, CD, Super Audio CD, or MP3. An album is composed of several tracks (MP3 only).

**VIDEO CD**

A compact disc that contains moving pictures. The picture data uses the MPEG 1 format, one of a worldwide standard of digital compression technology. The picture data is compressed to about 1/140 of its original size. Consequently, a 12 cm VIDEO CD can contain up to 74 minutes of moving pictures.

VIDEO CDs also contain compact audio data. Sounds outside the range of human hearing are compressed while sounds we can hear are not compressed. VIDEO CDs can hold 6 times the audio information of conventional audio CDs. There are 2 versions of VIDEO CDs.

- Version 1.1: You can play only moving pictures and sounds.
- Version 2.0: You can play high-resolution still pictures and enjoy PBC functions.

This system conforms to both versions.



# Language Code List

The language spellings conform to the ISO 639: 1988 (E/F) standard.

Code Language	Code Language	Code Language	Code Language
1027 Afar	1183 Irish	1347 Maori	1507 Samoan
1028 Abkhazian	1186 Scots Gaelic	1349 Macedonian	1508 Shona
1032 Afrikaans	1194 Galician	1350 Malayalam	1509 Somali
1039 Amharic	1196 Guarani	1352 Mongolian	1511 Albanian
1044 Arabic	1203 Gujarati	1353 Moldavian	1512 Serbian
1045 Assamese	1209 Hausa	1356 Marathi	1513 Siswati
1051 Aymara	1217 Hindi	1357 Malay	1514 Sesotho
1052 Azerbaijani	1226 Croatian	1358 Maltese	1515 Sundanese
1053 Bashkir	1229 Hungarian	1363 Burmese	1516 Swedish
1057 Byelorussian	1233 Armenian	1365 Nauru	1517 Swahili
1059 Bulgarian	1235 Interlingua	1369 Nepali	1521 Tamil
1060 Bihari	1239 Interlingue	1376 Dutch	1525 Telugu
1061 Bislama	1245 Inupiak	1379 Norwegian	1527 Tajik
1066 Bengali; Bangla	1248 Indonesian	1393 Occitan	1528 Thai
1067 Tibetan	1253 Icelandic	1403 (Afan)Oromo	1529 Tigrinya
1070 Breton	1254 Italian	1408 Oriya	1531 Turkmen
1079 Catalan	1257 Hebrew	1417 Punjabi	1532 Tagalog
1093 Corsican	1261 Japanese	1428 Polish	1534 Setswana
1097 Czech	1269 Yiddish	1435 Pashto;	1535 Tonga
1103 Welsh	1283 Javanese	Pushto	1538 Turkish
1105 Danish	1287 Georgian	1436 Portuguese	1539 Tsonga
1109 German	1297 Kazakh	1463 Quechua	1540 Tatar
1130 Bhutani	1298 Greenlandic	1481 Rhaeto-	1543 Twi
1142 Greek	1299 Cambodian	Romance	1557 Ukrainian
1144 English	1300 Kannada	1482 Kirundi	1564 Urdu
1145 Esperanto	1301 Korean	1483 Romanian	1572 Uzbek
1149 Spanish	1305 Kashmiri	1489 Russian	1581 Vietnamese
1150 Estonian	1307 Kurdish	1491 Kinyarwanda	1587 Volapük
1151 Basque	1311 Kirghiz	1495 Sanskrit	1613 Wolof
1157 Persian	1313 Latin	1498 Sindhi	1632 Xhosa
1165 Finnish	1326 Lingala	1501 Sangho	1665 Yoruba
1166 Fiji	1327 Laothian	1502 Serbo-	1684 Chinese
1171 Faroese	1332 Lithuanian	Croatian	1697 Zulu
1174 French	1334 Latvian;	1503 Singhalese	
1181 Frisian	Lettish	1505 Slovak	
	1345 Malagasy	1506 Slovenian	1703 Not specified

## Parental Control Area Code List

Code Area	Code Area	Code Area	Code Area
2044 Argentina	2165 Finland	2362 Mexico	2149 Spain
2047 Australia	2174 France	2376 Netherlands	2499 Sweden
2046 Austria	2109 Germany	2390 New Zealand	2086 Switzerland
2057 Belgium	2248 India	2379 Norway	2528 Thailand
2070 Brazil	2238 Indonesia	2427 Pakistan	2184 United Kingdom
2079 Canada	2254 Italy	2424 Philippines	
2090 Chile	2276 Japan	2436 Portugal	
2092 China	2304 Korea	2489 Russia	
2115 Denmark	2363 Malaysia	2501 Singapore	

# Index to Parts and Controls

For more information, refer to the pages indicated in parentheses.

## Front Panel (control unit)

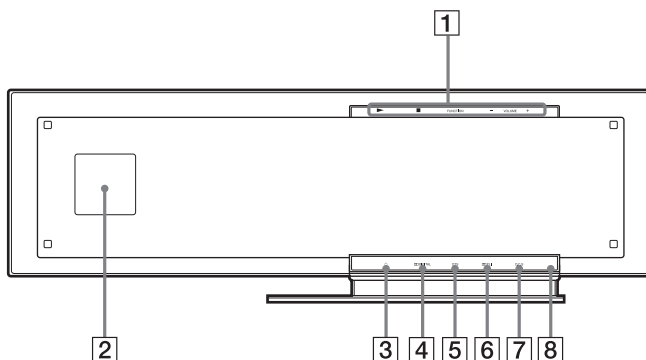

## Top Panel

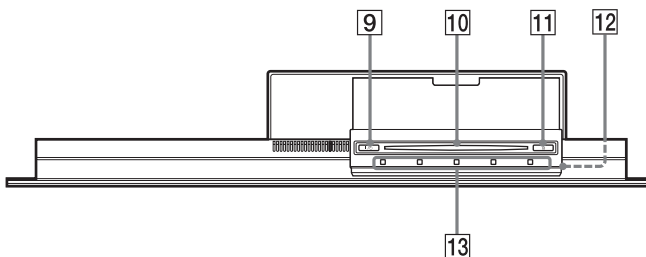

- 1 Soft-touch button indicators (42)
- 2 Front panel display (115)
- 3  $\text{\textcircled{P}}$  (standby) indicator (42)
- 4 DOLBY DIGITAL indicator
- 5 DTS indicator
- 6 DOLBY PRO LOGIC II indicator
- 7 D.C.S. indicator
- 8  $\text{\textcircled{R}}$  (remote sensor) (10)

- 9  $\text{\textcircled{I}}$ / $\text{\textcircled{O}}$  (on/standby) (42)
- 10 Disc slot (42)
- 11  $\text{\texttriangle}$  (eject)/DISC indicator (42)
- 12 HDMI OUT jack (36)
- 13 Soft-touch buttons ( $\text{\textblacktriangleright}$ / $\text{\textblacktriangle}$ /FUNCTION/  
VOLUME  $\text{-/+}$ ) (42)

When you press the soft-touch buttons 13, the soft touch indicators 1 light up.

## Front Panel Display

### When playing back a DVD

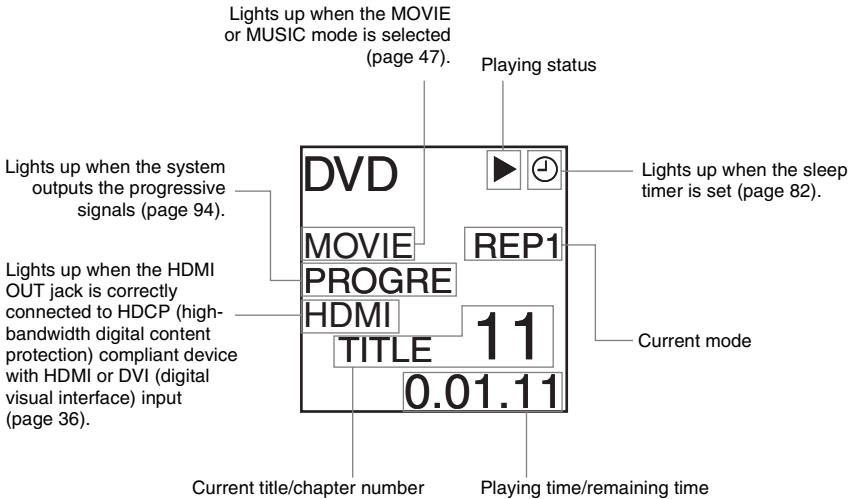

### When playing back a Super Audio CD, CD, VIDEO CD (without PBC functions), or MP3

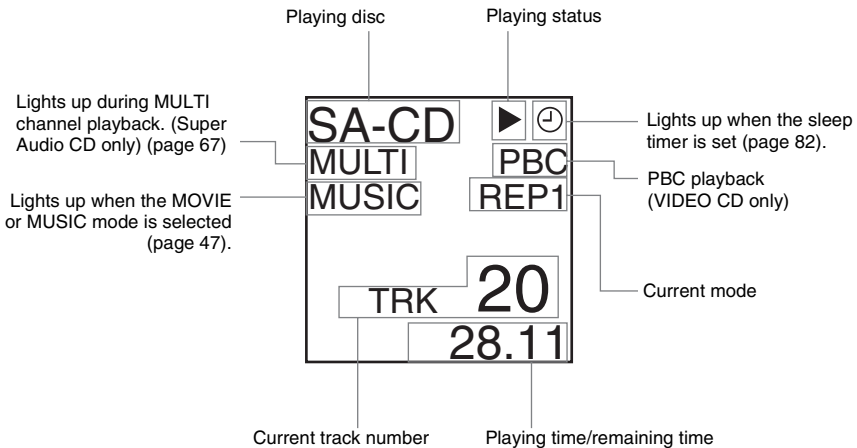

## When listening to the radio

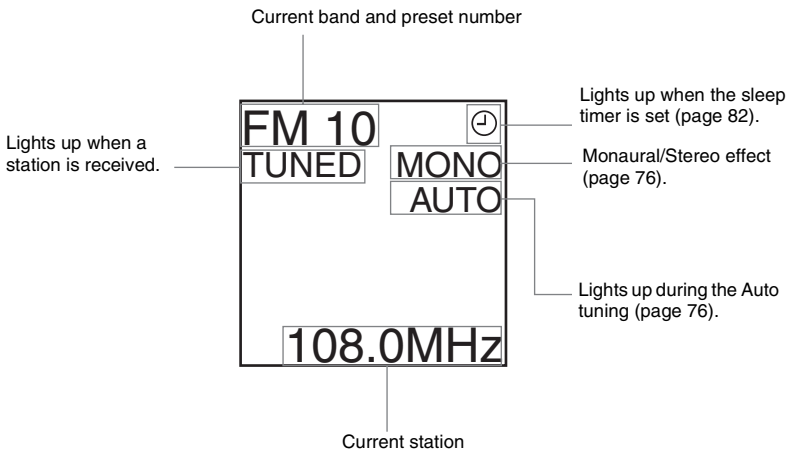

## When playing back a JPEG file

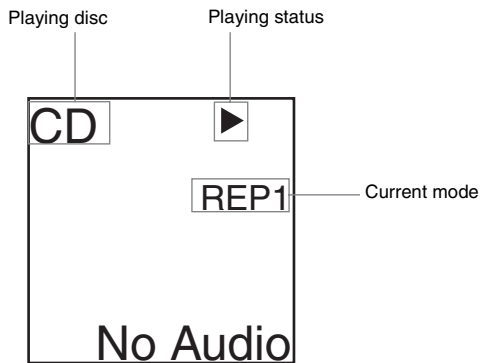

## Subwoofer

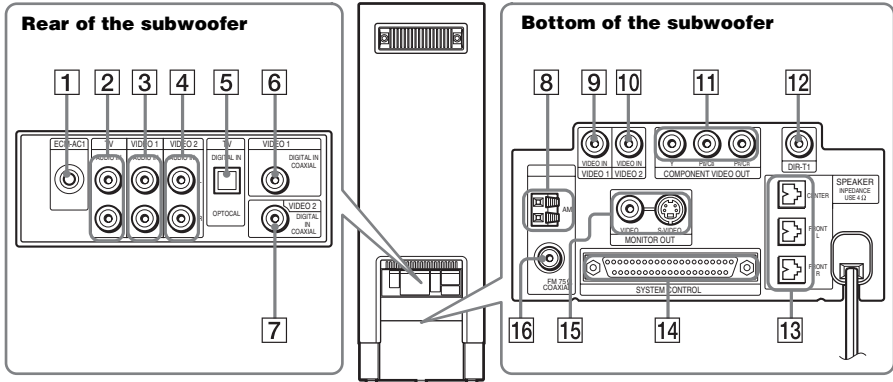

- 1 ECM-AC1 jack (30, 87)
- 2 TV (AUDIO IN L/R) jacks (36)
- 3 VIDEO 1 (AUDIO IN L/R) jacks (40)
- 4 VIDEO 2 (AUDIO IN L/R) jacks (40)
- 5 TV (DIGITAL IN OPTICAL) jack (36)
- 6 VIDEO 1 (DIGITAL IN COAXIAL) jack (40)
- 7 VIDEO 2 (DIGITAL IN COAXIAL) jack (40)
- 8 AM terminal (22)
- 9 VIDEO 1 (VIDEO IN) jack (40)

- 10 VIDEO 2 (VIDEO IN) jack (40)
- 11 COMPONENT VIDEO OUT jacks (36)
- 12 DIR-T1 jack (22)
- 13 SPEAKER jacks (22)
- 14 SYSTEM CONTROL jack (22)
- 15 MONITOR OUT (VIDEO/S VIDEO) jacks (36)
- 16 FM 75Ω COAXIAL jack (22)

## Remote control

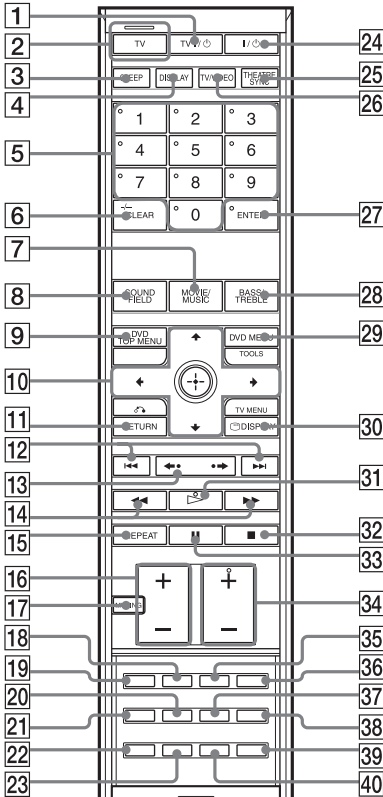

With the cover opened.

- 1 TV I/⏻ (on/standby) (79)
- 2 TV button/TV mode indicator (79)
- 3 SLEEP (82)
- 4 DISPLAY (63)
- 5 Number buttons<sup>2) 3)</sup> (52, 76, 78, 84)
- 6 CLEAR (53, 77, 80)  
-/-<sup>3)</sup> (78)
- 7 MOVIE/MUSIC (47)
- 8 SOUND FIELD (48)
- 9 DVD TOP MENU (59)
- 10 ⏪/⏩/⏮/⏭, ⊕ (ENTER) (30, 44, 52, 75, 84)
- 11 ↻ RETURN<sup>3)</sup> (54)
- 12 ⏮/⏭/⏩/⏪ (42)  
PRESET -/+ (76)
- 13 ⏮/⏭/⏩ (42)  
◀II/II▶ STEP (51)

- 14 ◀◀/▶▶ (51)  
◀II/II▶ (51)  
TUNING -/+ (75)
- 15 REPEAT (58)
- 16 VOLUME +/- (42, 76, 98)  
TV VOL +/-<sup>3)</sup> (79)
- 17 MUTING (42)
- 18 AUDIO (59)
- 19 PICTURE NAVI (53)
- 20 PROGRESSIVE (94)
- 21 DIMMER (83)
- 22 FM MODE (76)
- 23 DIRECT TUNING (76)
- 24 I/⏻ (on/standby) (30, 42, 54, 76)
- 25 THEATRE SYNC (81)
- 26 TV/VIDEO (79)
- 27 ENTER<sup>1) 3)</sup> (30, 44, 52, 75, 84)
- 28 BASS/TREBLE (50)
- 29 DVD MENU (59)  
TOOLS<sup>3)</sup> (79)
- 30 ⏻ DISPLAY (31, 52, 84, 120)  
TV MENU<sup>3)</sup> (79)
- 31 ▷ (play)<sup>2)</sup> (42, 54)
- 32 ■ (stop) (43, 54, 84)
- 33 II (pause) (43)
- 34 FUNCTION +/-<sup>2)</sup> (42, 44, 75)  
TV CH +/-<sup>3)</sup> (79)
- 35 SUBTITLE (66)
- 36 ANGLE (65)
- 37 SA-CD/CD (67)
- 38 NIGHT (82)
- 39 AMP MENU (44, 99, 124)
- 40 TUNER MENU (75)

<sup>1)</sup> The ENTER [27] button is the same function as the ⊕ (ENTER) [10] button.

<sup>2)</sup> The 5, ▷, and FUNCTION + buttons have tactile dots. Use the tactile dots as references when operating the system.

<sup>3)</sup> These buttons change to the TV operation buttons when the remote is in TV mode. The remote is in TV mode when the TV mode indicator [2] lights up by pressing the TV button [2].

---

## AC adaptor

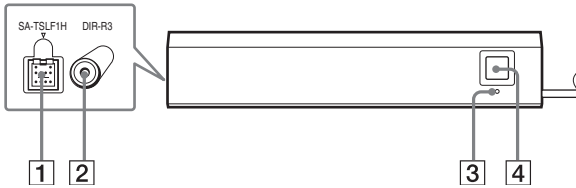

**1** SA-TSLF1H jack (24)

**2** DIR-R3 jack (33)

**3** POWER indicator (29)

**4** POWER (29)

---

## Surround speaker (L)

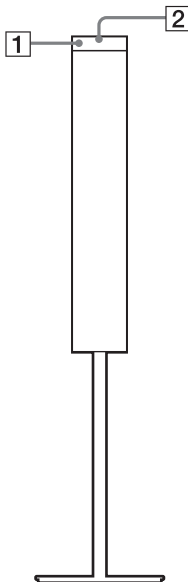

**1** IR receiver (29)

**2** IR status indicator (29)





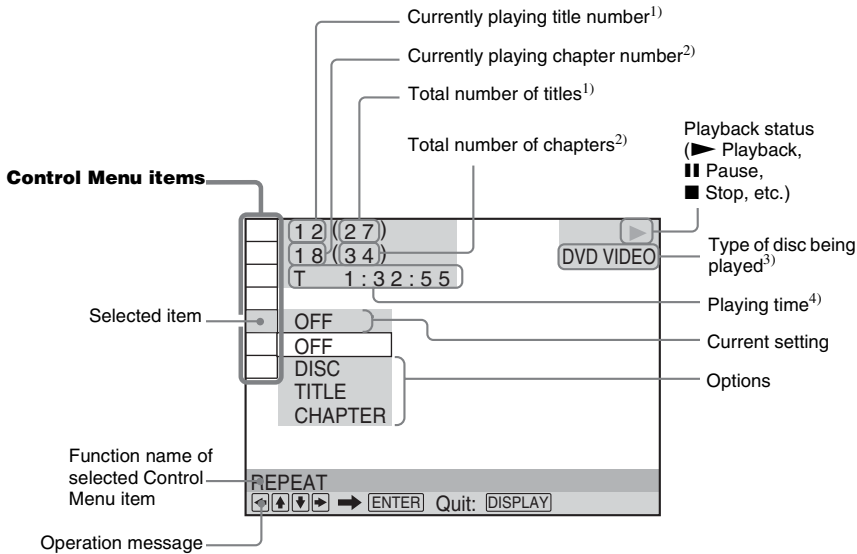

- <sup>1)</sup>Displays the scene number for VIDEO CDs (PBC is on), track number for VIDEO CDs/Super Audio CDs/CDs, album number for DATA CDs/DATA DVDs.
- <sup>2)</sup>Displays the index number for VIDEO CDs/Super Audio CDs, MP3 audio track number, or JPEG image file number for DATA CDs/DATA DVDs.
- <sup>3)</sup>Displays Super VCD as “SVCD.” Displays “MP3” in the Control Menu display 1 or “JPEG” in the Control Menu 2 for DATA CDs/DATA DVDs.
- <sup>4)</sup>Displays the date for JPEG files.















### To turn off the display

Press DISPLAY.



### List of Control Menu items

Item	Item Name, Function, Relevant Disc Type
	<b>[TITLE] (page 52)/[SCENE] (page 52)/[TRACK] (page 52)</b> Selects the title, scene, or track to be played. <span style="float: right;">DVD-V DVD-VR VIDEO CD</span>
	<b>[CHAPTER] (page 52)/[INDEX] (page 52)</b> Selects the chapter or index to be played. <span style="float: right;">DVD-V DVD-VR VIDEO CD</span>
	<b>[INDEX] (page 52)</b> Displays the index and selects the index to be played. <span style="float: right;">Super Audio CD</span>
	<b>[TRACK] (page 52)</b> Selects the track to be played. <span style="float: right;">CD DATA-CD DATA DVD Super Audio CD</span>
	<b>[ORIGINAL/PLAY LIST] (page 61)</b> Selects the type of titles (DVD-RW/DVD-R) to be played, the [ORIGINAL] one, or an edited [PLAY LIST]. <span style="float: right;">DVD-VR</span>

continued

	<p><b>[TIME/TEXT] (page 52)</b>  Checks the elapsed time and the remaining playback time.  Input the time code for picture and music searching.  Displays the DVD/CD text or the MP3 track name.</p> <p>DVD-V DVD-VR VIDEO CD C D DATA-CD DATA DVD Super Audio CD</p>
	<p><b>[AUTO CALIBRATION] (page 87)</b>  Adjust the level of each speaker automatically.</p> <p>DVD-V DVD-VR VIDEO CD C D DATA-CD DATA DVD Super Audio CD</p>
	<p><b>[MULTI/2CH] (page 67)</b>  Selects the playback area on Super Audio CDs when available.</p> <p>Super Audio CD</p>
	<p><b>[PROGRAM] (page 55)</b>  Selects the track to play in the order you want.</p> <p>VIDEO CD C D Super Audio CD</p>
	<p><b>[SHUFFLE] (page 57)</b>  Plays the track in random order.</p> <p>VIDEO CD C D DATA-CD DATA DVD Super Audio CD</p>
	<p><b>[REPEAT] (page 58)</b>  Plays the entire disc (all titles/all tracks/all albums) repeatedly or one title/chapter/track/album repeatedly.</p> <p>DVD-V DVD-VR VIDEO CD C D DATA-CD DATA DVD Super Audio CD</p>
	<p><b>[PARENTAL CONTROL] (page 84)</b>  Sets to prohibit playback on this system.</p> <p>DVD-V DVD-VR VIDEO CD C D DATA-CD DATA DVD Super Audio CD</p>
	<p><b>[SETUP] (page 90)</b>  [QUICK] Setup (page 30)  Use Quick Setup to choose the desired language of the on-screen display, the aspect ratio of the TV, choose [YES] or [NO] to start the [AUTO CALIBRATION].  [CUSTOM] Setup  In addition to the Quick Setup setting, you can adjust various other settings.  [RESET]  Returns the settings in [SETUP] to the default setting.</p> <p>DVD-V DVD-VR VIDEO CD C D DATA-CD DATA DVD Super Audio CD</p>
	<p><b>[ALBUM] (page 52)</b>  Selects the album to be played.</p> <p>DATA-CD DATA DVD</p>
	<p><b>[FILE] (page 52)</b>  Selects the JPEG image file to be played.</p> <p>DATA-CD DATA DVD</p>
	<p><b>[DATE] (page 65)</b>  Displays the date the picture was taken by a digital camera.</p> <p>DATA-CD DATA DVD</p>
	<p><b>[INTERVAL] (page 72)</b>  Specifies the duration for which the slides are displayed on the screen.</p> <p>DATA-CD DATA DVD</p>
	<p><b>[EFFECT] (page 73)</b>  Selects the effects to be used for changing slides during a slide show.</p> <p>DATA-CD DATA DVD</p>
	<p><b>[MODE (MP3, JPEG)] (page 71)</b>  Selects the data type; MP3 audio track (AUDIO), JPEG image file (IMAGE) or both (AUTO) to be played when playing a DATA CD/DATA DVD.</p> <p>DATA-CD DATA DVD</p>

**Tip**

- The Control Menu icon indicator lights up in green  →  when you select any item except [OFF] ([PROGRAM], [SHUFFLE], and [REPEAT] only). The [ORIGINAL/PLAY LIST] indicator lights up in green when you select [PLAY LIST] (default setting). The [MULTI/2CH] indicator lights up in green when you select the multi-channel playback area on a Super Audio CD.

# DVD Setup Display List

You can set the following items with the DVD Setup Display.

The order of the displayed items may be different from the actual display.

The default settings are underlined.

## LANGUAGE SETUP

- OSD\*
- MENU\*
- AUDIO\*
- SUBTITLE\*

## CUSTOM SETUP

- PAUSE MODE — AUTO / FRAME
- TRACK SELECTION — OFF / AUTO
- MULTI-DISC RESUME — ON / OFF
- AUDIO DRC — OFF / STANDARD / MAX
- AUDIO (HDMI) — OFF / AUTO / PCM

## SCREEN SETUP

- TV TYPE — 16:9 / 4:3 LETTER BOX / 4:3 PAN SCAN
- HDMI RESOLUTION — AUTO / 1920 × 1080i / 1280 × 720p / 720 × 480p
- YCbCr/RGB (HDMI) — YCbCr / RGB
- SCREEN SAVER — ON / OFF
- BACKGROUND — JACKET / PICTURE / GRAPHICS / BLUE / BLACK
- BLACK LEVEL — ON / OFF
- BLACK LEVEL (COMPONENT OUT) — OFF / ON
- 4:3 OUTPUT — FULL / NORMAL

## SPEAKER SETUP

- CONNECTION — FRONT — YES / CENTER — YES / NONE / SURROUND — YES / NONE / SUBWOOFER — YES
- DISTANCE — FRONT L — 0 ft – 23 ft / 0.0 m – 6.9 m / FRONT R — 0 ft – 23 ft / 0.0 m – 6.9 m / CENTER — 0 ft – 23 ft / 0.0 m – 6.9 m / SUBWOOFER — 0 ft – 23 ft / 0.0 m – 6.9 m / SURROUND L — 0 ft – 23 ft / 0.0 m – 6.9 m / SURROUND R — 0 ft – 23 ft / 0.0 m – 6.9 m
- LEVEL (FRONT) — L — — — — — -15.0 dB – +10.0 dB / R — — — — — -15.0 dB – +10.0 dB / CENTER — -15.0 dB – +10.0 dB / SUBWOOFER — -15.0 dB – +10.0 dB
- LEVEL (SURROUND) — L — — — — — -15.0 dB – +10.0 dB / R — — — — — -15.0 dB – +10.0 dB
- TEST TONE — OFF / ON

\* Select the language you want to use from the displayed language list.

## AMP Menu List

You can set the following items with AMP MENU on the remote.  
The default settings are underlined.

### AMP menu

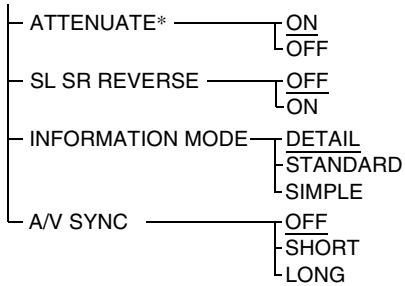

\* "ATTENUATE" may not appear depending on the selected function.

# Index

## Numerics

- 16:9 92
- 4:3 LETTER BOX 92
- 4:3 OUTPUT 93
- 4:3 PAN SCAN 92
- 5.1 Channel Surround 60

## A

- A/V SYNC 66
- ALBUM 52
- Album 109
- AMP MENU 44, 62, 66, 99
- AMP menu list 124
- ANGLE 65
- ATTENUATE 44
- AUDIO 91
- AUDIO (HDMI) 96
- AUDIO DRC 96
- Auto Calibration 87, 109

## B

- BACKGROUND 93
- BASS 50
- Batteries 10
- BLACK LEVEL 93
- BLACK LEVEL  
(COMPONENT OUT) 93

## C

- CHAPTER 52
  - Chapter 109
  - CINEMA STUDIO EX 49
  - COAXIAL (Digital Out) 41
  - COMPONENT VIDEO OUT  
94
  - Continuous play 42
  - Control Menu Display 120
  - Control unit 114
  - Controlling the TV 78
  - CUSTOM 90
  - CUSTOM PARENTAL  
CONTROL 84
  - CUSTOM SETUP 95
- ## D
- D. C. A. C. 87, 109
  - DATA CD 69
  - DATA DVD 69
  - Digital Cinema Auto  
Calibration 87, 109
  - Digital connection 41

- Digital Direct Twin Drive  
Subwoofer 109
- Digital Infrared Audio  
Transmission 109
- DIMMER 83
- Dolby Digital 59, 110
- Dolby Pro Logic II 110
- DTS 59, 110
- DUAL MONO 81
- DVD 110
- DVD+RW 110
- DVD's menu 59
- DVD-RW 61, 110
- DVI 39

## E

- EFFECT 73

## F

- Fast forward 51
- Fast reverse 51
- FILE 52
- File 111
- Film based software 111
- Freeze Frame 51
- Front panel display 63, 115

## H

- Handling discs 102
- HDMI  
HDMI RESOLUTION 92  
YCbCr/RGB (HDMI) 92
- HDMI (high-definition  
multimedia interface) 37, 111

## I

- INDEX 52
- INFORMATION MODE 62
- Installing the speakers and the  
IR Devices on a wall 34
- Instant Advance 43
- Instant Replay 43
- INTERLACE 94
- Interlace format 111
- INTERVAL 72
- IR transmitter 29, 34

## J

- JPEG 68, 69

## L

- Language Code List 113
- LANGUAGE SETUP 91
- Listening to other components  
44
- Listening to TV sound 46
- Locating a specific point by  
watching the TV screen 51

## M

- MENU 91
- Mica-reinforced-cellular-  
diaphragm 111
- MODE (MP3, JPEG) 71
- MOVIE/MUSIC 47
- MP3 68, 69
- Multi Session CD 8
- Multi-angle function 65, 111
- MULTI-DISC RESUME 96
- Multilingual function 111
- Multiplex broadcast sound 81
- MUTING 43

## N

- Naming preset stations 76
- NIGHT 82

## O

- ORIGINAL 61
- OSD 91
- Other Component Hookup 40

## P

- PARENTAL CONTROL 85
- Parental Control 111
- PAUSE MODE 95
- PBC Playback 73
- PICTURE NAVI 53, 70
- PLAY LIST 61
- Playback Control (PBC) 111
- Program Play 55
- PROGRESSIVE AUTO 94
- Progressive format 94, 111
- PROGRESSIVE VIDEO 94

## Q

- Quick Setup 30

*continued*

## **R**

Radio 76  
Radio Stations 75  
Rear Panel 117  
Region Code 9, 111  
Remote 10, 78  
Remote control 118  
Repeat Play 58  
RESET 100  
Resume Play 54

## **S**

S VIDEO 37  
Scan 51  
SCENE 52  
Scene 112  
SCREEN SAVER 93  
SCREEN SETUP 92  
Searching 51  
Selecting 47  
SETUP 90  
Setup Display 90, 123  
Shuffle Play 57  
SL SR REVERSE 99  
SLEEP 82  
Slide Show 71  
Slow-motion Play 51  
Soft-touch button 42  
Sound Field 48  
SPEAKER SETUP 97  
    CONNECTION 97  
    DISTANCE 97  
    LEVEL 98  
SUBTITLE 66, 91  
Super Audio CD 8, 67, 112

## **T**

TEST TONE 98  
THEATRE SYNC 80  
TIME/TEXT 53  
TITLE 52  
Title 112  
TRACK 52  
Track 112  
TRACK SELECTION 95  
TREBLE 50  
Troubleshooting 102  
TV Hookup 36  
TV TYPE 92

## **U**

Unpacking 109  
Usable discs 6

## **V**

VIDEO CD 112

## **W**

Wireless 29



## Free Manuals Download Website

<http://myh66.com>

<http://usermanuals.us>

<http://www.somanuals.com>

<http://www.4manuals.cc>

<http://www.manual-lib.com>

<http://www.404manual.com>

<http://www.luxmanual.com>

<http://aubethermostatmanual.com>

Golf course search by state

<http://golfingnear.com>

Email search by domain

<http://emailbydomain.com>

Auto manuals search

<http://auto.somanuals.com>

TV manuals search

<http://tv.somanuals.com>