

Home Theatre System

Operating Instructions

HT-SF470

HT-SS370

©2010 Sony Corporation

WARNING

To reduce the risk of fire or electric shock, do not expose this apparatus to rain or moisture.

To reduce the risk of fire, do not cover the ventilation opening of the apparatus with newspapers, tablecloths, curtains, etc. Do not place the naked flame sources such as lighted candles on the apparatus.

Do not install the appliance in a confined space, such as a bookcase or built-in cabinet.

To reduce the risk of fire or electric shock, do not expose this apparatus to dripping or splashing, and do not place objects filled with liquids, such as vases, on the apparatus.

As the main plug is used to disconnect the unit from the mains, connect the unit to an easily accessible AC outlet. Should you notice an abnormality in the unit, disconnect the main plug from the AC outlet immediately.

Do not expose batteries or apparatus with battery-installed to excessive heat such as sunshine, fire or the like.

The unit is not disconnected from the mains as long as it is connected to the AC outlet, even if the unit itself has been turned off.

To prevent injury, this apparatus must be securely attached to the floor/wall in accordance with the installation instructions.

For customers in Europe



Disposal of Old Electrical & Electronic Equipment (Applicable in the European Union and other European countries with separate collection systems)

This symbol on the product or on its packaging indicates that this product shall not be treated as household waste. Instead it shall be handed over to the applicable collection point for the recycling of electrical and electronic equipment. By ensuring this product is disposed of correctly, you will help prevent potential negative consequences for the environment and human health, which could otherwise be caused by inappropriate waste handling of this product. The recycling of materials will help to conserve natural resources. For more detailed information about recycling of this product, please contact your local Civic Office, your household waste disposal service or the shop where you purchased the product.



**Disposal of waste batteries
(applicable in the European
Union and other European
countries with separate
collection systems)**

This symbol on the battery or on the packaging indicates that the battery provided with this product shall not be treated as household waste.

On certain batteries this symbol might be used in combination with a chemical symbol. The chemical symbols for mercury (Hg) or lead (Pb) are added if the battery contains more than 0.0005% mercury or 0.004% lead.

By ensuring these batteries are disposed of correctly, you will help prevent potentially negative consequences for the environment and human health which could otherwise be caused by inappropriate waste handling of the battery. The recycling of the materials will help to conserve natural resources.

In case of products that for safety, performance or data integrity reasons require a permanent connection with an incorporated battery, this battery should be replaced by qualified service staff only. To ensure that the battery will be treated properly, hand over the product at end-of-life to the applicable collection point for the recycling of electrical and electronic equipment.

For all other batteries, please view the section on how to remove the battery from the product safely. Hand the battery over to the applicable collection point for the recycling of waste batteries.

For more detailed information about recycling of this product or battery, please contact your local Civic Office, your household waste disposal service or the shop where you purchased the product.

**Notice for customers: The following
information is only applicable to
equipment sold in countries applying
EU Directives.**

The manufacturer of this product is Sony Corporation, 1-7-1 Konan Minato-ku Tokyo, 108-0075 Japan. The Authorized Representative for EMC and product safety is Sony Deutschland GmbH, Hedelfinger Strasse 61, 70327 Stuttgart, Germany. For any service or guarantee matters please refer to the addresses given in separate service or guarantee documents.

About This Manual

- The instructions in this manual are for model HT-SF470 and HT-SS370. In this manual, models of area code SP1 is used for illustration purposes unless stated otherwise. Any difference in operation is clearly indicated in the text, for example, “Models of area code SP1 only”.
- The instructions in this manual describe the controls on the supplied remote. You can also use the controls on the receiver if they have the same or similar names as those on the remote.

About area codes

The area code of the receiver you purchased is shown on the upper left portion of the rear panel (see the illustration below).

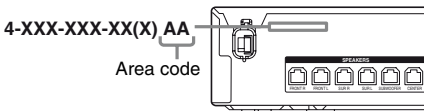

Any differences in operation, according to the area code, are clearly indicated in the text, for example, “Models of area code AA only”.

On Copyrights

This receiver incorporates Dolby* Digital and Pro Logic Surround and the DTS** Digital Surround System.

- * Manufactured under license from Dolby Laboratories. Dolby, Pro Logic, and the double-D symbol are trademarks of Dolby Laboratories.
- ** Manufactured under license under U.S. Patent #'s: 5,451,942; 5,956,674; 5,974,380; 5,978,762; 6,487,535 & other U.S. and worldwide patents issued & pending. DTS and DTS Digital Surround are registered trademarks and the DTS logos and Symbol are trademarks of DTS, Inc. © 1996-2008 DTS, Inc. All Rights Reserved.

This receiver incorporates High-Definition Multimedia Interface (HDMI™) technology. HDMI, the HDMI Logo, and High-Definition Multimedia Interface are trademarks or registered trademarks of HDMI Licensing LLC in the United States and other countries.

“x.v.Colour” and “x.v.Colour” logo are trademarks of Sony Corporation.

“BRAVIA” is a trademark of Sony Corporation.

“PlayStation” is a registered trademark of Sony Computer Entertainment Inc.

“S-AIR” and its logo are trademarks of Sony Corporation.

Table of Contents

Unpacking	6
Description and location of parts	8

Getting Started

1: Installing the speakers.....	15
2: Connecting the speakers	18
3: Connecting the TV	19
4: Connecting the audio/video components	20
5: Connecting the antennas	24
6: Preparing the receiver	24
7: Calibrating the appropriate settings automatically (AUTO CALIBRATION)	25

Playback

Selecting a component	29
Enjoying sound/images from the components connected to the receiver ...	30

Enjoying Surround Sound

Selecting the sound field	33
Enjoying the sound at low volume (NIGHT MODE).....	34

Tuner Operations

Listening to FM/AM radio	35
Presetting radio stations	37
Using the Radio Data System (RDS).....	39
(Models of area code CEL only)	

“BRAVIA” Sync Features

What is “BRAVIA” Sync?	39
Preparing for the “BRAVIA” Sync	40
Playing back components with one-touch operation (One-Touch Play).....	41

Enjoying the TV sound from the speakers connected to the receiver (System Audio Control)	42
Turning off the receiver with the TV (System Power Off).....	43
Using the power saving function (HDMI Signal Pass Through).....	44
Enjoying the TV sound via an HDMI connection (Audio Return Channel).....	45
Enjoying optimum sound field for the selected scene (Scene Select).....	46
Enjoying movies with the optimum sound field (Theatre Mode).....	46

S-AIR Operations

About S-AIR products.....	47
Setting up an S-AIR product	48
Enjoying the system’s sound in another room	52
Stabilizing S-AIR reception	54
Changing the channel for better sound transmission.....	55
Enjoying the S-AIR receiver while the S-AIR main unit is in standby mode	56

Advanced Settings

Changing the input button assignments.....	57
Settings and adjustments using the amplifier menu	58

Additional Information

Glossary	63
Precautions	65
Troubleshooting.....	67
Specifications	72
Index	75

Unpacking

Be sure that you have the following items in your package.

HT-SF470 only

- Receiver (STR-KS470) (1)



- Front speakers (SS-MSP37F) (2)

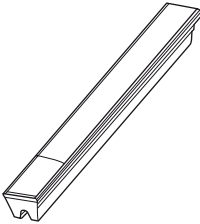

- Center speaker (SS-CNP37) (1)



- Surround speakers (SS-SRP37F) (2)

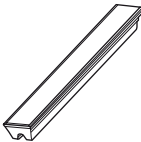

- Subwoofer (SS-WP37) (1)

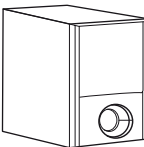

- Speaker cords (5, Red/White/Grey/Blue/Green)



- Foot pads (Big \times 4, Small \times 4)



- Bases (Large \times 2, Small \times 2)



- Posts (Long \times 2, Short \times 2)

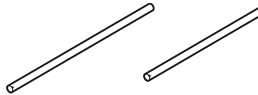

- Post covers (4)



- Brackets (4)



- Screws (Large) (8)



- Screws (Small) (12)



- AM loop antenna (aerial) (1)



- FM wire antenna (aerial) (1)



- R6 (size-AA) batteries (2)



- Optimizer microphone (ECM-AC2) (1)



- Remote commander (RM-AAU074) (1)

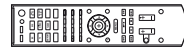

- Operating Instructions (this manual)

- Quick Setup Guide

HT-SS370 only

- Receiver (STR-KS370) (1)

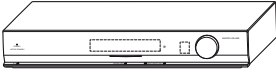

- Front/Surround speakers (SS-TSB101) (4)



- Center speaker (SS-CTB101) (1)

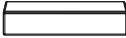

- Subwoofer (SS-WSB101) (1)

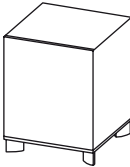

- Speaker cords (5, Red/White/Grey/Blue/Green)



- AM loop antenna (1)



- FM wire antenna (1)



- R6 (size-AA) batteries (2)



- Optimizer microphone (ECM-AC2) (1)



- Remote commander (RM-AAU074) (1)

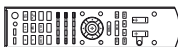

- Operating Instructions (this manual)
- Quick Setup Guide

Inserting batteries into the remote

Insert two R6 (size-AA) batteries in the RM-AAU074 Remote Commander. Observe the correct polarity when installing batteries.

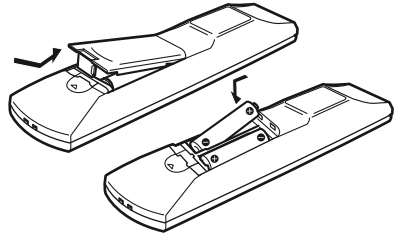

Notes

- Do not leave the remote in an extremely hot or humid place.
- Do not use a new battery with old ones.
- Do not mix manganese batteries and other kinds of batteries.
- Do not expose the remote sensor to direct sunlight or lighting apparatuses. Doing so may cause a malfunction.
- If you do not intend to use the remote for an extended period of time, remove the batteries to avoid possible damage from battery leakage and corrosion.
- When you replace the batteries, the remote buttons may be reset to their initial settings. If this happens, reassign the buttons again (page 57).
- When the remote no longer operates the receiver, replace all the batteries with new ones.

Description and location of parts

Receiver

Front view

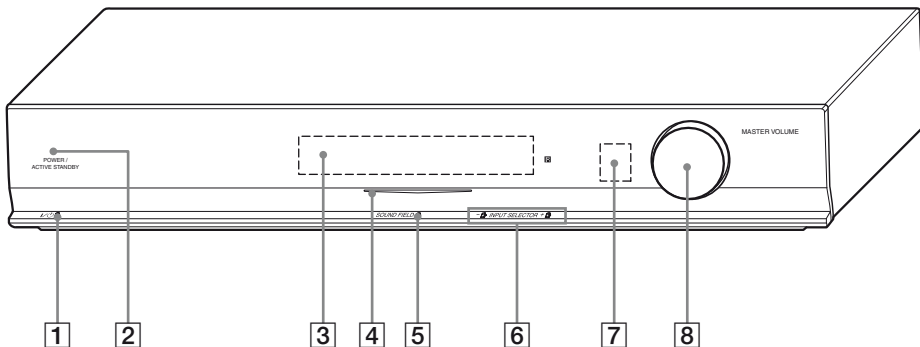

Name	Function
1 I/O (on/standby)	Turns the receiver on or off (page 24, 31, 58).
2 POWER/ACTIVE STANDBY indicator	<p>Lights up as follows:</p> <p>Green: The receiver is turned on.</p> <p>Amber: The receiver is in standby mode, and Control for HDMI or S-AIR standby mode is set to on.</p> <p>Lights off when the receiver is in standby mode, and Control for HDMI and S-AIR standby mode are set to off. If the Control for HDMI is set to on, "PASS THRU" is set to "THRU AUTO" and no signals are detected, the indicator will also light off.</p> <p>Note If the POWER/ACTIVE STANDBY indicator flashes, see page 71.</p>
3 Display	Displays the current status of the selected component or a list of selectable items (page 9).

Name	Function
4 White indicator	Lights up when the receiver is on and DSPL is set to on in DISPLAY function (page 62). Lights off when the receiver is in standby mode or DSPL is set to off in DISPLAY function.
5 SOUND FIELD	Selects the sound field (page 33).
6 INPUT SELECTOR +/-	Selects the input source to playback (page 29, 31, 32, 35, 37, 38).
7 Remote sensor	Receives signals from the remote.
8 MASTER VOLUME	Adjusts the volume level of all speakers at the same time (page 30, 32, 67).

About the indicators on the display

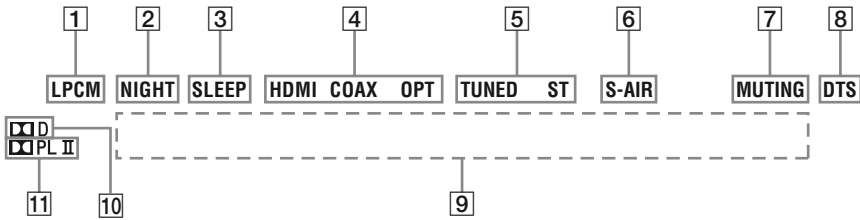

Name	Function
1 LPCM	Lights up when Linear PCM (Pulse Code Modulation) signals are input.
2 NIGHT	Lights up when the Night Mode function is set to on (page 34).
3 SLEEP	Lights up when the sleep timer is activated (page 62).
4 Input indicators	Light up when the digital signal is input.
HDMI	Digital signal is input through the HDMI IN jack.
COAX	Digital signal is input through the COAX IN jack.
OPT	Digital signal is input through the OPT IN jack.
5 Tuning indicators	Light up to indicate the current status of the radio station (page 35).
TUNED ST	When receives a radio station. When broadcasts in stereo mode.
6 S-AIR	Lights up when the S-AIR transmitter (not supplied) is connected.
7 MUTING	Lights up when the muting function is activated.
8 DTS	Lights up when the receiver is decoding DTS signals. Note When playing a DTS format disc, be sure that you have made digital connections.
9 Message display area	Displays the volume level, selected input source, audio input signal, etc.

Name	Function
10 <input type="checkbox"/> D	Lights up when the receiver is decoding Dolby Digital signals. Note When playing a Dolby Digital format disc, be sure that you have made digital connections.
11 Dolby Pro Logic indicators	Lights up one of the respective indicators when the receiver applies Dolby Pro Logic processing to 2 channel signals in order to output the center and surround channel signals.
<input type="checkbox"/> PL	Dolby Pro Logic
<input type="checkbox"/> PLII	Dolby Pro Logic II

continued

9GB

Rear panel

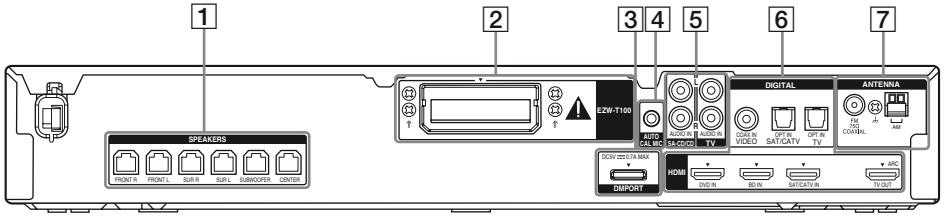

1 SPEAKERS section



Connects to the supplied speakers and subwoofer (page 18).

2 S-AIR



EZW-T100 slot
Connects to a wireless transmitter (not supplied) (page 48).

3 DMPORT



DMPORT jack
Connects to a DIGITAL MEDIA PORT adapter (page 20).

4 AUTO CALIBRATION



AUTO CAL MIC jack
Connects to the supplied optimizer microphone for the Auto Calibration function (page 26).

5 AUDIO INPUT section



White (L) AUDIO IN jacks
Connects to a Super Audio CD player, CD player, etc.



Red (R)

6 DIGITAL INPUT/OUTPUT section



COAX IN jack
Connects to a satellite tuner, etc. (page 23).



OPT IN jacks



HDMI IN/OUT jacks
Connects to a DVD player, satellite tuner, or a Blu-ray Disc player. The image is output to a TV or a projector while the sound can be output from a TV or/and speakers connected to this receiver (page 21).

7 ANTENNA section



FM ANTENNA jack
Connects to the supplied FM wire antenna (aerial) (page 24).



AM ANTENNA terminals
Connects to the supplied AM loop antenna (aerial) (page 24).

Remote commander

You can use the supplied remote RM-AAU074 to operate the receiver and to control the Sony audio/video components that the remote is assigned to operate (page 57).

RM-AAU074

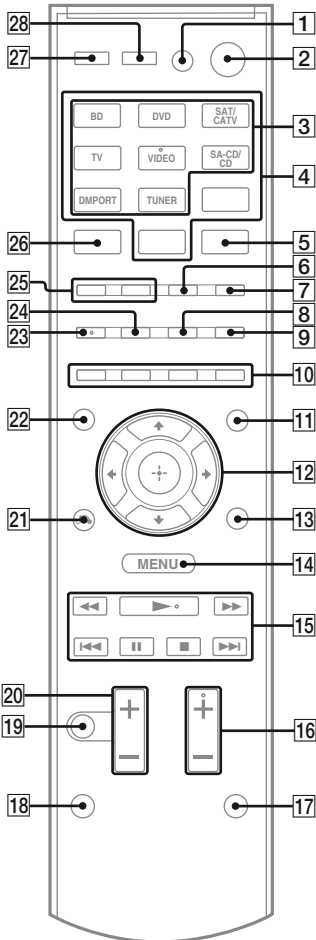

Notes on using SHIFT (17) and TV (18) button

SHIFT (17) button

Press and hold SHIFT (17), then press the button with pink printing that you want to use. Example: Press and hold SHIFT (17), then press ENTER (5).

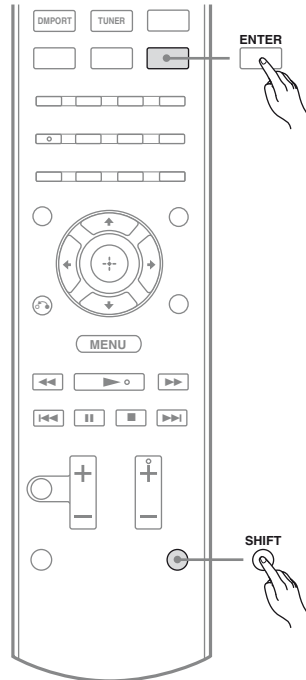

TV (18) button

Press and hold TV (18), then press the button with yellow printing to control the TV. Example: Press and hold TV (18), then press PROG+ (16).

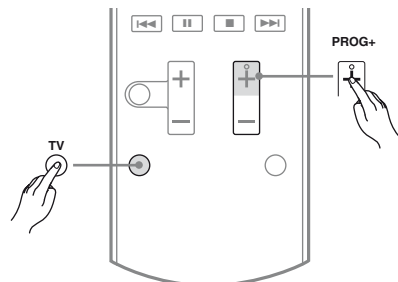

continued

Basic operations

Remote button	Function
2 I/⏻ (on/standby)	Turns the receiver on or off. To turn off all Sony components, press I/⏻ (2) and AV I/⏻ (1) at the same time (SYSTEM STANDBY).
3 Input buttons (VIDEO*)	Selects the component you want to use. The buttons are initial assigned to control Sony components. You can change the button assignments following the steps in "Changing the input button assignments" on page 57.
11 AMP MENU	Displays the menu of the receiver.
12 ⊕, ⬆/⬇/⬅/➡	Press ⬆, ⬇, ⬅ or ➡ to select the menu items. Then, press ⊕ to enter the selection.
16 SOUND FIELD +*/-	Selects a sound field.
19 🔇 (Muting)	Activates the muting function. Press 🔇 again to restore the sound.
20 ▽ +/-	Adjusts the volume level of all speakers at the same time.

Tuner operations

Remote button	Function
4 Numeric buttons (number 5*)	Press and hold SHIFT (17), then press the numeric buttons (4) to preset/tune to the preset stations.
5 ENTER	Press and hold SHIFT (17), then press ENTER (5) to enter the selection.
6 MEMORY	Stores a station.
7 D.TUNING	Enters direct tuning mode.
9 DISPLAY	Displays information during TUNER function.
12 ⊕, ⬆/⬇/⬅/➡	Selects a menu item and enters the selection.

Remote button	Function
14 MENU/HOME	Displays the tuner menu.
15 PRESET +/-	Selects a preset station.
TUNING +/-	Scans a station.

DMPORT operations

Remote button	Function
15 ⏪/⏩	Skips the track.
⏪/⏩	Fast reverse or fast forward.
▶* (playback)/ ⏸ (pause, press again to resume normal playback)/ ■ (stop)	Play mode buttons.

To control the component

1 Press one of the input buttons (TV, BD, DVD or SAT/CATV) (3) to select the component you want to operate.

The component assigned to the selected input button becomes operable.

2 Referring to the following table, press the corresponding button for the operation.

Common operations









Remote button	Function
1 TV I/⏻ AV I/⏻ (on/standby)	Turns on or off the Sony TV or audio/video components that the remote is assigned to operate (page 57). Press I/⏻ (2) and TV I/⏻/AV I/⏻ (1) at the same time to turn off the receiver and other components that the remote is assigned to operate (SYSTEM STANDBY).
4 Numeric buttons (number 5*)	Press and hold SHIFT (17), then press the numeric buttons (4) to select channels and tracks directly.

Remote button	Function
5 ENTER	Press and hold SHIFT (17), then press ENTER (5) to enter the selection.
10 Colour buttons	Displays an operation guide on the TV screen when the colour buttons are available. Follow the operation guide to perform a selected operation.
12 	Selects a menu item and enters the selection.

To control the TV

Press and hold TV (yellow) button (18), then press the button with yellow printing to control the TV.













Remote button	Function
4 Numeric buttons (number 5*)	Selects channel. Press ENTER (5) to change channels immediately.
5  (Previous channel)	Returns to the channel previously watched (for more than five seconds).
9 DISPLAY	<ul style="list-style-type: none"> – Displays the TV's information on the TV screen. (Displays the current channel number, etc.) – Press AMP MENU (11), then press DISPLAY (9) to display the input stream information of the TV when TV is connected via TV OPT IN jack.
i+/? (Info/Text reveal)	<p>In digital mode: Displays brief details of the program currently being watched.</p> <p>In analog mode: Displays information such as current channel number and screen format.</p> <p>In text mode: Reveals hidden information (e.g. answers to a quiz).</p>
13 TOOLS/OPTIONS	Enables you to access various viewing options and change/make adjustments according to the source and screen format.

Remote button	Function
14 MENU/HOME	Allows you to select channels or input sources and change the settings for your TV.
16 PROG +/- 	In TV mode: Selects the next (+) or previous (–) channel. In text mode: Selects the next (A) or previous (E) page.
19  (Muting)	Activates the muting function.
20  +/-	Adjusts the volume level.
21  RETURN/EXIT	Returns to the previous screen of any displayed menu.
22  (Guide)	Displays the guide when you are watching analog or digital channels.
23  * (Audio)	Selects the sound from the speaker for a stereo or bilingual broadcast.
25 DIGITAL	Changes to digital mode.
ANALOG	Changes to analog mode.
26  (Text)	Displays text.
27 THEATRE	Sets the optimal picture settings automatically for watching movies, when you connect a Sony TV that is compatible with the THEATRE button function. Also, audio is automatically switched to the audio output of this receiver when you connect the TV and the receiver with HDMI connection, and the Control for HDMI function is set to on.
28  /  (Input select/Text hold)	In TV mode: Selects the TV input signal. In analog text mode: Holds the current page.





continued

13GB

To control the DVD player/recorder, Blu-ray Disc player/recorder



Remote button	Function
8  (Angle)	Switches to other viewing angles when multi-angle are recorded on a Blu-ray Disc or DVD.
9 DISPLAY	<ul style="list-style-type: none"> – Displays the playback information. – Press AMP MENU (11), then press DISPLAY (9) to display the input stream information for Blu-ray Disc or DVD.
13 TOOLS/ OPTIONS	Enables you to access various viewing options and change/make adjustments according to the source and screen format.
14 MENU/HOME	Displays the menu.
15  	Skips chapter.
	Skips forward to the next available chapter.
	Fast reverse or fast forward the disc when pressed during playback.
 * (playback)/  (pause, press again to resume normal playback)/  (stop)	Play mode buttons.
21  RETURN/ EXIT	Returns to the previous screen of any displayed menu.
22  (Guide)	Displays the guide when you are watching analog or digital channels.
23  * (Audio)	Selects the sound from the speaker for a stereo or bilingual broadcast.
24  (Subtitle)	Selects the subtitle language when multi-lingual subtitles are recorded on a Blu-ray Disc or DVD.
25 TOP MENU POP UP/MENU	Displays the top menu or disc menu.
26 CLEAR	Clear a mistake when you press the incorrect numeric button.

To control the HDD/DVD COMBO

Remote button	Function
14 MENU/HOME	Displays the menu.
15 	Specifies the previous or next chapter or track.
	Fast reverse or fast forward the disc when pressed during playback.
 * (playback)/  (pause, press again to resume normal playback)/  (stop)	Play mode buttons.
25 TOP MENU POP UP/MENU	Displays the top menu or disc menu.

To control the SAT/CATV

Remote button	Function
9 DISPLAY	<ul style="list-style-type: none"> – Displays the information during SAT/CATV function. – Press AMP MENU (11), then press DISPLAY (9) to display the input stream information for satellite tuner or cable television tuner.
14 MENU/HOME	Displays the menu.
22  (Guide)	Displays the guide menu.

* These buttons (number 5/VIDEO, , , PROG +/SOUND FIELD +/() have tactile dots. Use the tactile dots as references when operating the receiver.

Notes

- Some functions explained in this section may not work depending on the model.
- The above explanation is intended to serve as an example only. Therefore, depending on the component, the above operation may not be possible or may operate differently than described. In that case, use the remote commander supplied with the component.

1: Installing the speakers

This receiver allows you to use a 5.1 channel speaker system. To fully enjoy theater-like multi channel surround sound, be sure to connect all the speakers (two front speakers, a center speaker, and two surround speakers) and a subwoofer (5.1 channel). You can place your speakers as shown below.

- A** Front speaker (left)
- B** Front speaker (right)
- C** Center speaker
- D** Surround speaker (left)
- E** Surround speaker (right)
- F** Subwoofer

HT-SF470 only

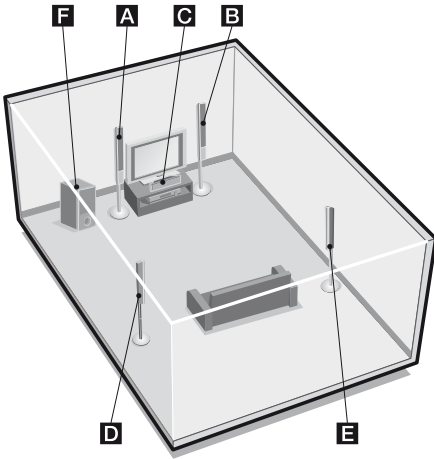

HT-SS370 only

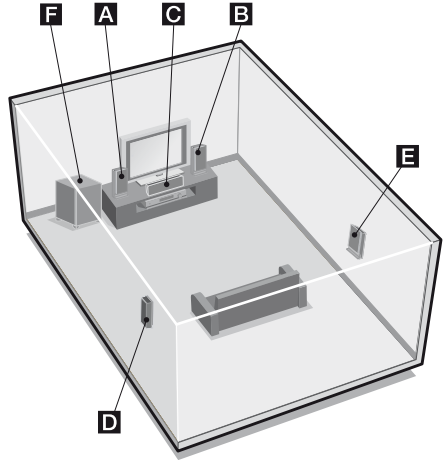

Notes

- Be sure to use the supplied speakers.
- For HT-SF470, do not lean on the speaker as it may fall down.

Tips

- The angle **A** should be the same.

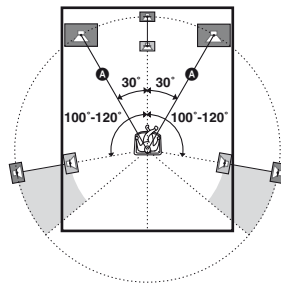

- Since the subwoofer does not emit highly directional signals, you can place it wherever you want.

Installing the speakers on a flat surface

HT-SF470 only

Before you install the center speaker and the subwoofer, be sure to attach the supplied foot pads to prevent vibration or movement as shown in the illustration below.

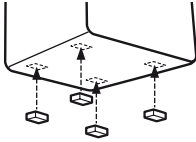

Note

Attach the small foot pads to the center speaker and big foot pads to the subwoofer.

Installing the speakers on the speaker stand

For greater flexibility in positioning the speakers, you are recommended to use the speaker stand as below.

Model	Speaker stand
HT-SF470	Supplied. For details, refer to the supplied Quick Setup Guide.
HT-SS370	Optional WS-FV11 or WS-FV10D speaker stand (available only in certain countries). For details, refer to the operating instructions supplied with the speaker stand.

Installing the speakers on the wall

You can install your speakers on the wall.

- 1 Prepare screws (not supplied) that are suitable for the hook on the back of each speaker. See the illustrations below.**

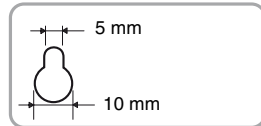
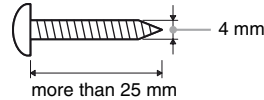

Hook on the back of the speaker

- 2 Fasten the screws to the wall. The screws should protrude 8 mm to 10 mm.**

HT-SF470 only
For the center speaker

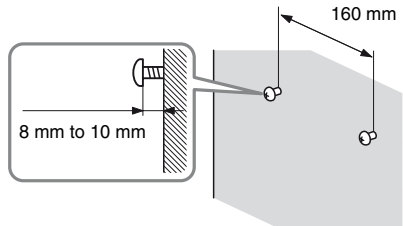

For the front speakers

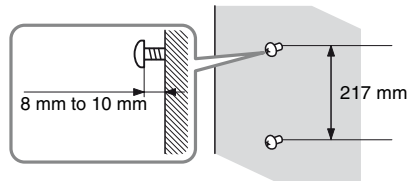

For the surround speakers

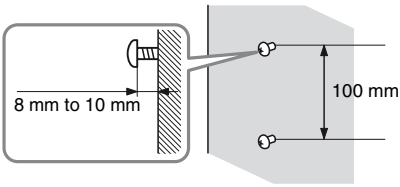

HT-SS370 only For the center speaker

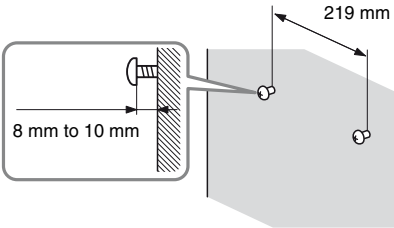

For the front speakers and surround speakers

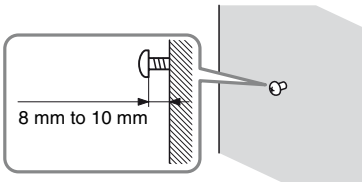

3 Hang the speakers on the screws.

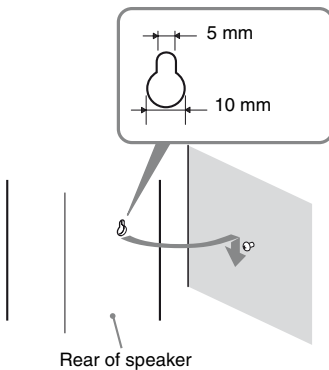

Notes

- Use screws that are suitable for the wall material and strength. As a plaster board wall is especially fragile, attach the screws securely to a beam and fasten them to the wall. Install the speakers on a vertical and flat wall where reinforcement is applied.
- Contact a screw shop or installer regarding the wall material or screws to be used.
- Sony is not responsible for accident or damage caused by improper installation, insufficient wall strength or improper screw installation, natural calamity, etc.
- For HT-SF470, if you install the speakers on the wall, you do not need to attach the supplied speaker stand.

2: Connecting the speakers

Before connecting the cords, be sure to disconnect the AC power cord (mains lead).

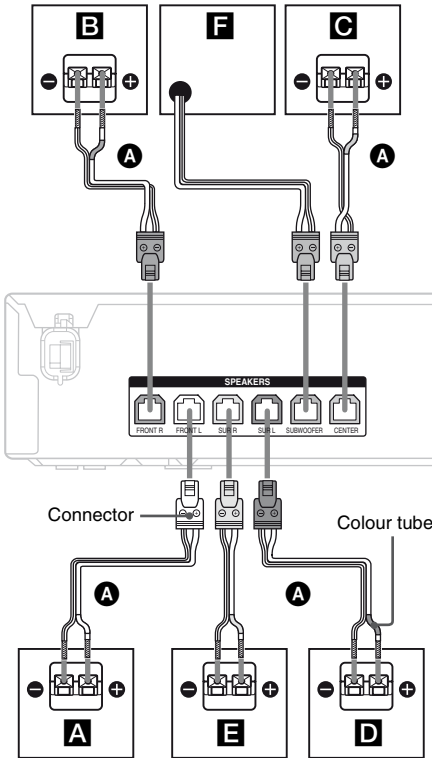

A Speaker cord (supplied)

A Front speaker (left)

B Front speaker (right)

C Center speaker

D Surround speaker (left)

E Surround speaker (right)

F Subwoofer

Notes on speaker cords

- The connector of the speaker cords are the same colour as the speaker jack to be connected. When connecting a speaker cord, be sure to match the coloured connector to the speaker jack on the receiver:

Connector	Speaker jack
Red	FRONT R
White	FRONT L
Grey	SUR R
Blue	SUR L
Purple	SUBWOOFER
Green	CENTER

- Be sure to match the speaker cords to the appropriate terminals on the speakers:
 - the speaker cord with the colour tube to \oplus terminal, and the speaker cord without the colour tube to \ominus terminal (for HT-SS370).
 - the speaker cord with a stripe line to \ominus terminal, and the speaker cord without a stripe line to \oplus terminal (for HT-SF470).

To connect the speakers correctly

Check the speaker type by referring to the speaker label at the rear panel of the speakers.

Character on speaker label	Speaker type	
HT-SF470	HT-SS370	
L	FRONT L	Front left
R	FRONT R	Front right
—*	CENTER	Center
SL	SUR L	Surround left
SR	SUR R	Surround right
—*	—*	Subwoofer

* This speaker does not have character on the speaker label. For details on the speaker type, see page 6 (for HT-SF470) or page 7 (for HT-SS370).

3: Connecting the TV

You can watch the selected input image when you connect the HDMI OUT jack to a TV. Before connecting the cords, be sure to disconnect the AC power cord (mains lead).

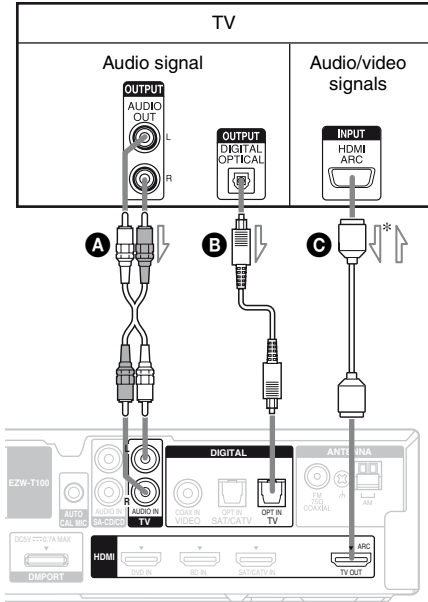

➔ : Signal flow

- A** Audio cord (not supplied)
- B** Optical digital cord (not supplied)
- C** HDMI cable (not supplied)

Sony recommends that you use an HDMI-authorized cable or Sony HDMI cable.

* When you use Audio Return Channel (ARC) function, the audio signal is output from the TV to the receiver.

It is not necessary to connect all the cords. Connect audio and video cords according to the jacks of your components.

Connect	To
A or B	output the TV sound via the speakers connected to the receiver. Be sure to turn off the TV's volume or activate the TV's muting function.
C	output the image to a TV while the sound can be output from a TV or/and speakers connected to the receiver. When the TV is compatible with Audio Return Channel (ARC) function, you can output the TV sound via the speakers connected to the receiver without connecting A or B . For details, see "Enjoying the TV sound via an HDMI connection (Audio Return Channel)" (page 45). Be sure to turn off the TV's volume or activate the TV's muting function.

Notes

- Be sure to turn on the receiver when the video and audio signals of a playback component are being output to a TV via the receiver. Unless the power is turned on, neither video nor audio signals will be transmitted.
- When connecting optical digital cords, insert the plugs straight in until they click into place.
- Do not bend or tie optical digital cords.

Tip

All the digital audio jacks are compatible with 32 kHz, 44.1 kHz, 48 kHz, and 96 kHz sampling frequencies.

4: Connecting the audio/video components

How to hook up your components

This section describes how to hook up your components to this receiver. Before you begin, see “Component to be connected” below for the pages which describe how to connect the audio/video components.

Before connecting the cords, be sure to disconnect the AC power cord (mains lead). After hooking up all your components, proceed to “5: Connecting the antennas” (page 24).

Component to be connected

To connect	See
TV	page 19
Audio components	page 20
<ul style="list-style-type: none"> • Super Audio CD player, CD player • DIGITAL MEDIA PORT adapter 	
Components with HDMI jack	page 21
Video components	page 23
<ul style="list-style-type: none"> • DVD player, DVD recorder • Satellite tuner, cable television tuner 	

Connecting audio components

The following illustration shows how to connect audio components such as Super Audio CD player or CD player and DIGITAL MEDIA PORT adapter.

You can also view the images on the TV screen by connecting the video output of the DIGITAL MEDIA PORT adapter to the video input of the TV. However, depending on the DIGITAL MEDIA PORT adapter, video output may not be possible.

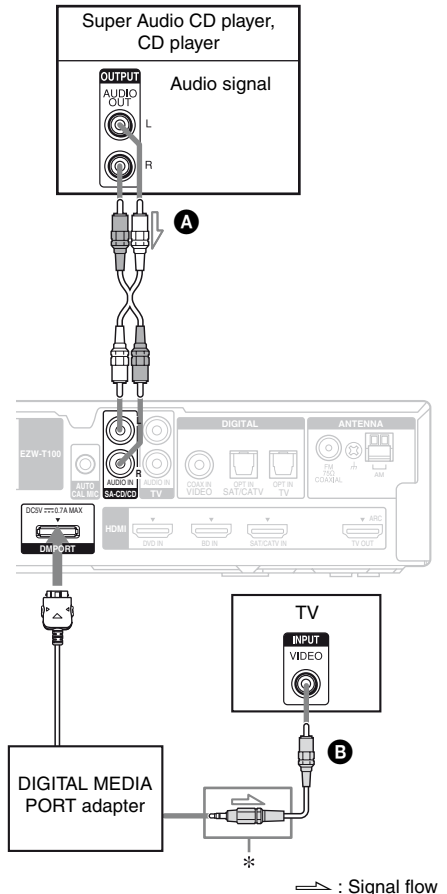

- A** Audio cord (not supplied)
- B** Video cord (not supplied)

* The type of connector varies depending on the DIGITAL MEDIA PORT adapter. For details, refer to the operating instructions supplied with the DIGITAL MEDIA PORT adapter.

Notes on connecting DIGITAL MEDIA PORT adapter

- Do not connect or disconnect the DIGITAL MEDIA PORT adapter while the receiver is turned on.
- Be sure to make DMPORT connections firmly, insert the connector straight in.
- As the connector of the DIGITAL MEDIA PORT adapter is fragile, be sure to handle with care when placing or moving the receiver.
- When connecting the DIGITAL MEDIA PORT adapter, be sure the connector is inserted with the arrow mark facing towards the arrow mark on the DMPORT jack. To detach the DIGITAL MEDIA PORT adapter, press and hold both sides of the connector and then pull out the connector.

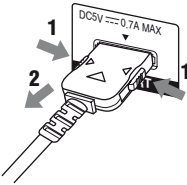

Connecting components with HDMI jacks

HDMI is the abbreviated name for High-Definition Multimedia Interface. It is an interface which transmits video and audio signals in digital format.

Sony recommends that you connect components to the receiver using an HDMI cable.

By connecting Sony “BRAVIA” Sync-compatible components using HDMI cables, operations can be simplified. See ““BRAVIA” Sync Features” (page 39).

HDMI features

- A digital audio signals transmitted by HDMI can be output from the speakers connected to the receiver. This signal supports Dolby Digital, DTS and Linear PCM.
- This receiver supports x.v.Colour, Deep Colour and 3D transmission.

Notes on connecting cables

- Use a High Speed HDMI cable. If you use a Standard HDMI cable, 1080p, Deep Colour or 3D images may not be displayed properly.
- Sony recommends that you use an HDMI authorized cable or Sony HDMI cable.
- We do not recommend using an HDMI-DVI conversion cable. When you connect an HDMI-DVI conversion cable to a DVI-D component, the sound and/or the image may not be output.

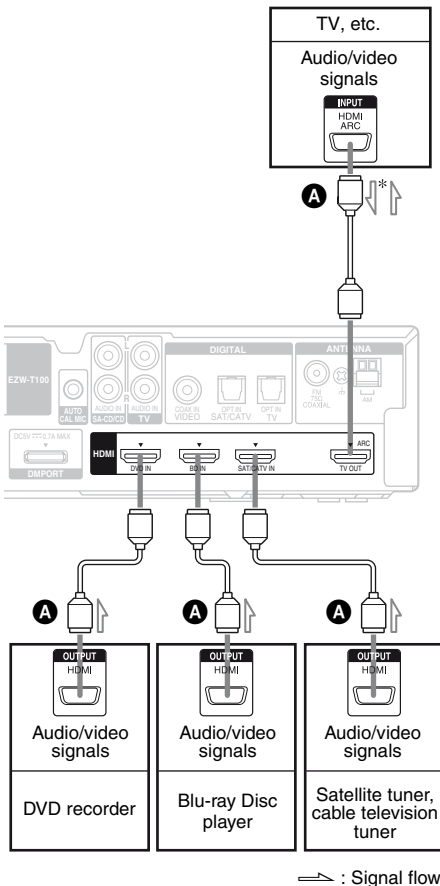

A HDMI cable (not supplied)

Sony recommends that you use an HDMI-authorized cable or Sony HDMI cable.

* When you use Audio Return Channel (ARC) function, the audio signal is output from the TV to the receiver.

Notes

- When the TV is compatible with Audio Return Channel (ARC) function, the TV sound will automatically output from the speakers connected to the receiver. If not, see page 19 for the audio connection of TV to the receiver. Be sure to set "ARC" to "ARC ON" in SET HDMI menu (page 45).
- All the HDMI jacks on the receiver function in the same way. For example, you can connect a "PlayStation 3" etc., to any available HDMI jack.

Notes on HDMI connections

- An audio signal input to the HDMI IN jack is output from the SPEAKERS jacks and HDMI OUT jack. It is not output from any other audio jacks.
- Video signals input to the HDMI IN jack can only be output from the HDMI OUT jack.
- The multi/stereo area audio signals of a Super Audio CD are not output.
- Audio signals (sampling frequency, bit length, etc.) transmitted from an HDMI jack may be suppressed by the connected component. Check the setup of the connected component if the image is poor or the sound does not come out of a component connected via the HDMI cable.
- Sound may be interrupted when the sampling frequency, the number of channels or the audio format of the audio output signals from the playback component is switched.
- When the connected component is not compatible with copyright protection technology (HDCP), the image and/or the sound from the HDMI OUT jack may be distorted or may not be output. In this case, check the specification of the connected component.
- You can enjoy multi channel Linear PCM only with an HDMI connection.
- Set the image resolution of the playback component to 720p, 1080i or 1080p when you output 96 kHz multi channel sound over an HDMI connection.
- You may need to make certain settings on the image resolution of the player before you can enjoy multi channel Linear PCM. Refer to the operating instructions of the player.
- To enjoy 3D images, connect 3D-compatible TV and video components (Blu-ray Disc player, Blu-ray Disc recorder, PlayStation 3, etc.) to the receiver using High Speed HDMI cables, put on 3D glasses, and then play back a 3D-compatible content.

- Depending on the TV or the video component, 3D images may not be displayed. Check the 3D image formats supported by the receiver (page 72).
- Not every HDMI component supports all functions that are defined by the specified HDMI version. For example, components that support HDMI, version 1.4, may not support Audio Return Channel (ARC).
- Refer to the operating instructions of each component connected for details.

Connecting video components

The following illustration shows how to connect video components such as DVD player, DVD recorder, etc.

It is not necessary to connect all the cords. Connect audio and video cords according to the jacks of your components.

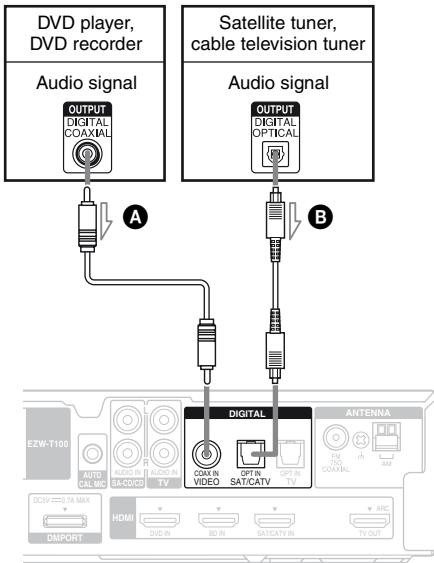

— : Signal flow

- A** Coaxial digital cord (not supplied)
- B** Optical digital cord (not supplied)

Notes

- If you connect a DVD player/recorder, be sure to change the initial setting of the VIDEO button on remote so that you can use the button to control your DVD player/recorder. For details, see “Changing the input button assignments” (page 57).
- To input multi channel digital audio from the DVD player, set the digital audio output setting on the DVD player. Refer to the operating instructions supplied with the DVD player.
- When connecting optical digital cords, insert the plugs straight in until they click into place.
- Do not bend or tie optical digital cords.
- Be sure to connect the video output of the DVD player and DVD recorder to the TV, so that the image is displayed on the TV. Refer to the operating instructions of each connected component for details.
- You cannot do recording on the DVD recorder via this receiver. For details, refer to the operating instructions supplied with the DVD recorder.

Tip

All the digital audio jacks are compatible with 32 kHz, 44.1 kHz, 48 kHz, and 96 kHz sampling frequencies.

5: Connecting the antennas

Connect the supplied AM loop antenna (aerial) and FM wire antenna (aerial).
Before connecting the antennas, be sure to disconnect the AC power cord (mains lead).

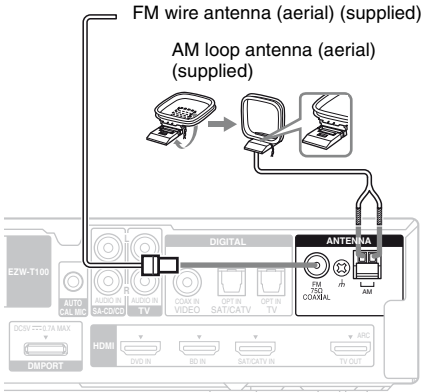

Notes

- To prevent noise pickup, keep the AM loop antenna (aerial) away from the receiver and other components.
- Be sure to fully extend the FM wire antenna (aerial).
- After connecting the FM wire antenna (aerial), keep it as horizontal as possible.

6: Preparing the receiver

Connecting the AC power cord (mains lead)

Connect the AC power cord (mains lead) to a wall outlet.

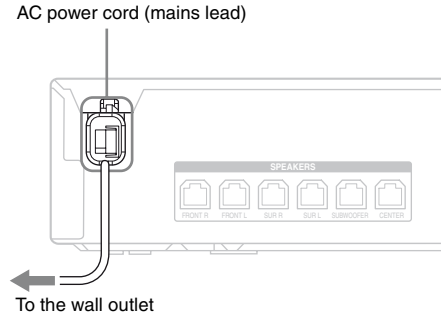

Performing initial setup operations

Before using the receiver for the first time, initialize the receiver by performing the following procedure. This procedure can also be used to return settings you have made to their initial settings.
Be sure to use the buttons on the receiver for this operation.

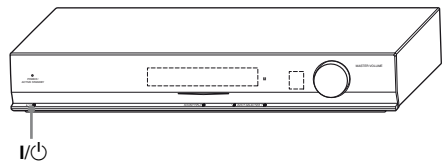

- 1** Press I/O to turn on the receiver.
- 2** Hold down I/O for a few seconds until “CLEARED” appears.

All the settings you have changed or adjusted are reset to the initial settings.

7: Calibrating the appropriate settings automatically

(AUTO CALIBRATION)

This receiver is equipped with DCAC (Digital Cinema Auto Calibration) Technology which allows you to perform automatic calibration as follows:

- Check the connection between each speaker and the receiver.
- Adjust the speaker level.
- Measure the distance of each speaker from your listening position.
- Measure the frequency characteristics.*

* The measurement result is not utilized for signals with a sampling frequency of more than 96 kHz.

The DCAC is designed to obtain proper sound balance in your room. However, you can adjust the speaker levels manually according to your preference. For details, see “To adjust the speaker levels” (page 60).

Before you perform Auto Calibration

Before you perform the Auto Calibration, set up and connect the speakers (page 15, 18).

- The AUTO CAL MIC jack is used for the supplied optimizer microphone only. Do not connect other microphones to this jack. Doing so may damage the receiver and the microphone.
- During the calibration, the sound that comes out of the speakers is very loud. The volume of the sound cannot be adjusted. Pay attention to the presence of children or to the effect on your neighborhood.
- Perform the Auto Calibration in a quiet environment to avoid the effect of noise and to get a more accurate measurement.
- If there are any obstacles in the path between the optimizer microphone and the speakers, the calibration cannot be performed correctly. Remove any obstacles from the measurement area to avoid measurement error.

Notes

- If the muting function has been activated before you perform Auto Calibration, the muting function will be set to off automatically.
- When you use the S-AIR product, disconnect the headphones.

Example: HT-SS370

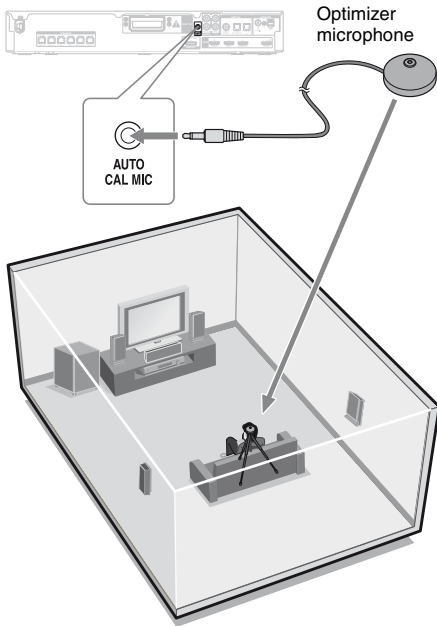

1 Connect the supplied optimizer microphone to the AUTO CAL MIC jack.

2 Set up the optimizer microphone.

Place the optimizer microphone at your listening position. You can also use a stool or tripod so that the optimizer microphone remains at the same height as your ears.

Tip

When you face the speaker towards the optimizer microphone, you will get a more accurate measurement.

Performing Auto Calibration

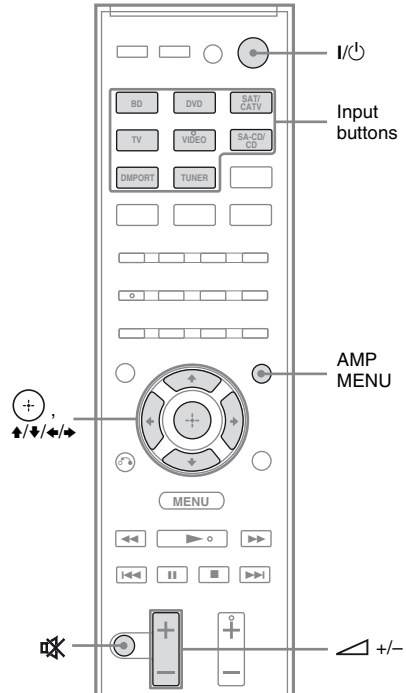

1 Press AMP MENU.

“LEVEL” appears on the display.

2 Press \uparrow/\downarrow repeatedly until “A.CAL MENU” appears, then press \oplus or \rightarrow .

3 Press \uparrow/\downarrow repeatedly until “A.CAL START” appears, then press \oplus .

Measurement starts in a few seconds.

While the time is counting down, stand away from the measurement area to avoid measurement error.

The measurement process will take approximately 30 seconds to complete.

The table below shows the display when measurement starts.

Measurement for	Display
Speaker existence	TONE
Speaker gain, distance, frequency response	T. S. P.
Subwoofer gain and distance	SUBWOOFER

Notes

- If “CHECK MIC” appears, you cannot perform the Auto Calibration. Connect the optimizer microphone, then perform the Auto Calibration again.
- If “PHONES” appears, you cannot perform the Auto Calibration. Disconnect the headphones from the S-AIR product you are using, then perform the Auto Calibration again.

Tips

- When Auto Calibration starts:
 - Stand some distance from the speakers and the listening position to avoid measurement failure. This is because test signals are output from the speakers during measurement.
 - Avoid making noise to get a more accurate measurement.
- The Auto Calibration function will be canceled when you do the following during the measurement process:
 - Press I/\cup or \times .
 - Press input buttons on the remote or INPUT SELECTOR +/- on the receiver.
 - Change the volume level.

Confirming/saving the measurement results

1 Confirm the measurement result.

When the measurement ends, a beep sounds and the measurement result appears on the display.

Measurement result	Display	Explanation
When the measurement process completes properly	SAVE EXIT	Proceed to step 2.
When the measurement process fails	ERROR XXXX	See “When error codes appear” (page 28).

2 Press \uparrow/\downarrow repeatedly to select the item, then press \oplus .

Item	Explanation
SAVE EXIT	Saves the measurement results and exits the setting process.
WRN CHECK	Displays warning concerning the measurement results. See “When you select “WRN CHECK”” (page 28).
DIST INFO	Displays the measurement result for speaker distance.
LEVEL INFO	Displays the measurement result for speaker level.
EXIT	Exits the setting process without saving the measurement results.

Note

After “SAVE EXIT” is displayed for 50 seconds, the measurement result is saved automatically, without the need to save the procedure.

3 Save the measurement result.

Select “SAVE EXIT” in step 2.
The measurement results are saved.

continued

When error codes appear

Try the remedies and perform the Auto Calibration again.

Error code	Cause and remedies
ERROR 32	<ul style="list-style-type: none">The sound received by the optimizer microphone is out of the acceptable range.The optimizer microphone or subwoofer may be damaged. Contact your Sony dealer or local authorized Sony service facility.
ERROR F 33	The front speakers are not connected or either the front left or front right speaker is not connected. Check that the front speakers are connected properly.
ERROR SR33	Either the surround left or surround right speaker is not connected. Check that the surround speakers are connected properly.
ERROR SW33	The subwoofer is not connected or it may be damaged. Contact your Sony dealer or local authorized Sony service facility.

When you select “WRN CHECK”

If a warning on the measurement result is present, detailed information is displayed.

Press **+** or **←** to return to step 2 of “Confirming/saving the measurement results”.

Warning code	Explanation
WARNING 40	The Auto Calibration has completed. However, the noise level is high. You may be able to perform the Auto Calibration properly if you try it again, even though the measurement cannot be performed in all environments. Try to perform the Auto Calibration in a quiet environment.

Warning code	Explanation
WARNING 41	The sound received by the optimizer microphone is out of the acceptable range. The distance between the optimizer microphone and the speakers is too close. Set them away, and then try to perform the Auto Calibration again.
WARNING 42	
WARNING 43	The distance and position of the subwoofer cannot be detected. This may be caused by noise. Try to perform the Auto Calibration in a quiet environment.
NO WARNING	There is no warning information.

When you select “DIST INFO” or “LEVEL INFO”

You can check the speaker distance or speaker level.

Note

The measurement result of a speaker will not appear if the receiver does not recognize that the speaker is connected.

When you have finished

Disconnect the optimizer microphone from the receiver.

Note

If you have changed the position of the speakers, it is recommended that you perform Auto Calibration again in order to enjoy the surround sound.

Clearing the measurement result

You can delete the result of Auto Calibration. If there is no saved data, you cannot perform this operation.

- 1 Press AMP MENU.**
“LEVEL” appears on the display.
- 2 Press \uparrow/\downarrow repeatedly until “A.CAL MENU” appears, then press \oplus or \rightarrow .**
- 3 Press \uparrow/\downarrow repeatedly until “A.CAL CLEAR” appears, then press \oplus or \rightarrow .**
- 4 Press \uparrow/\downarrow repeatedly until “YES” appears, then press \oplus .**

The saved result is deleted.

The settings for speaker distance and speaker level return to their defaults.

Playback

Selecting a component

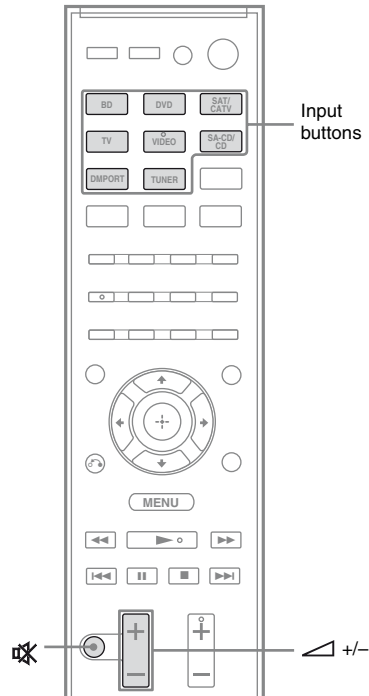

- 1 Press the input button to select a component.**

You can also press INPUT SELECTOR +/- on the receiver.

The selected input appears on the display.

Selected input [Display]	Components that can be played back
BD [BD]	Blu-ray Disc player, etc., connected to the BD jack
DVD [DVD]	DVD recorder, etc., connected to the DVD jack
SAT/CATV [SAT/CATV]	Satellite tuner, cable television tuner, etc., connected to the SAT/CATV jack

continued

Selected input [Display]	Components that can be played back
TV [TV]	TV, etc., connected to the TV jack
VIDEO [VIDEO]	DVD player, DVD recorder, etc., connected to the VIDEO jack
SA-CD/CD [SA-CD/CD]	Super Audio CD player, CD player, etc., connected to the SA-CD/CD jack
DMPORT [DMPORT]	DIGITAL MEDIA PORT adapter connected to the DMPORT jack
TUNER [FM or AM band]	Built-in radio tuner

2 Turn on the component and start playback.

3 Press \triangle +/- to adjust the volume.

You can also use MASTER VOLUME on the receiver.

To activate the muting function

Press \times . "MUTING" lights up and "MUTING ON" appears on the display for a few seconds.

The muting function will be canceled when you do the following.

- Press \times again.
- Increase the volume.
- Turn off the receiver.

To avoid damaging your speakers

Before you turn off the receiver, be sure to turn down the volume level.

Enjoying sound/images from the components connected to the receiver

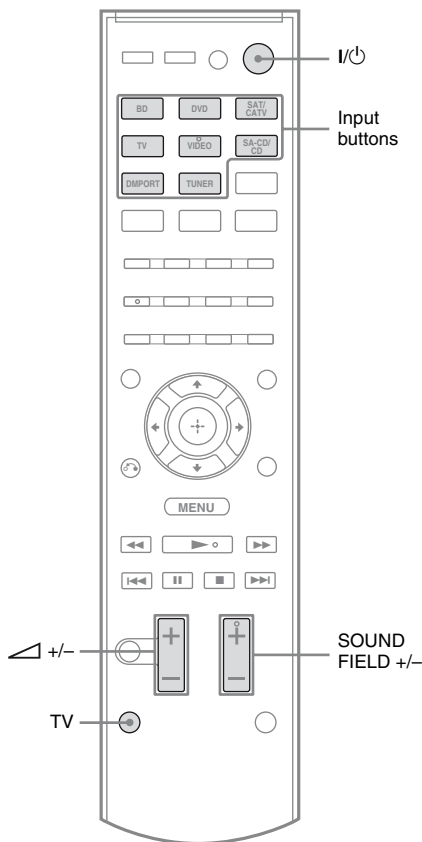

Enjoying TV

1 Turn on the TV and choose a program.

For details, refer to the operating instructions of the TV.

2 Turn on the receiver.

3 Press TV.

You can also press INPUT SELECTOR +/- on the receiver to select "TV".

4 Adjust the volume of the receiver.

Tips

- When you connect a Sony TV, the audio input of the TV is switched and the image from the TV tuner is displayed on the TV screen automatically by pressing the TV button.
- The sound may be output from the TV's speaker. In this case, turn the volume of the TV's speaker down to the minimum.

Enjoying a satellite tuner or cable television tuner

1 Turn on the TV.

2 Turn on the satellite tuner or cable television tuner and the receiver.

3 Press SAT/CATV.

You can also press INPUT SELECTOR +/- on the receiver to select "SAT/CATV".

4 Change the TV input.

For details, refer to the operating instructions of the TV.

5 Adjust the volume of the receiver.

Tip

The sound may be output from the TV's speaker. In this case, turn the volume of the TV's speaker down to the minimum.

Enjoying Blu-ray Disc/DVD

- 1 Turn on the TV.**
- 2 Turn on the Blu-ray Disc player (recorder) or DVD player (recorder), then place the disc on the tray.**
- 3 Turn on the receiver.**
- 4 Press DVD or BD.**

You can also press INPUT SELECTOR +/- on the receiver to select “DVD” or “BD”.
- 5 Change the TV input.**

For details, refer to the operating instructions of the TV.
- 6 Play back the disc.**
- 7 Adjust the volume of the receiver.**

Tip

Even if you playback Dolby True HD, Dolby Digital Plus or DTS-HD with a connected component compatible with these sound formats, the receiver accepts as Dolby Digital or DTS. When you connect the component to the receiver using an HDMI cable to playback these high-quality sound formats, set the connected component to output the sound in multi channel PCM, if possible.

Enjoying a Super Audio CD/CD

- 1 Turn on the Super Audio CD player or CD player, then place the disc on the tray.**
- 2 Turn on the receiver.**
- 3 Press SA-CD/CD.**

You can also press INPUT SELECTOR +/- on the receiver to select “SA-CD/CD”.
- 4 Adjust the volume of the receiver.**

Enjoying a connected component through DMPORT connection

- 1 Turn on the receiver.**
- 2 Press DMPORT.**

You can also press INPUT SELECTOR +/- on the receiver to select “DMPORT”.
- 3 Start playback of the connected component.**

Tip

When listening to MP3 or other compressed music files using a portable audio source, you can enhance the sound. Press SOUND FIELD +/- repeatedly until “P. AUDIO” appears on the display.

Enjoying Surround Sound

Selecting the sound field

This receiver can create multi channel surround sound. You can select one of the optimized sound fields from the system's preprogrammed sound fields.

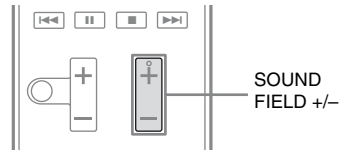

Press SOUND FIELD +/- repeatedly to select the sound field you want.

You can also press SOUND FIELD on the receiver.

Types of sound field available

Sound field for	Sound field [Display]	Effect
A.F.D.	2CH STEREO [2CH STEREO]	When multi channel surround formats are input, the signals are downmixed to 2 channel.
	A.F.D. STANDARD [A.F.D. STD]	Presents the sound as it was recorded/encoded without adding any surround effects. However, this receiver will generate a low frequency signal for output to the subwoofer when there is no LFE signals.
	A.F.D. MULTI [A.F.D. MULTI]	Reproduces sound from any of the format to 2 or more speakers.
	PRO LOGIC [PRO LOGIC]	Performs Dolby Pro Logic decoding. The source recorded in 2 channel format is decoded into 4.1 channels.
	PRO LOGIC II MOVIE [PLII MOVIE]	Performs Dolby Pro Logic II Movie mode decoding. This setting is ideal for movies encoded in Dolby Surround. In addition, this mode can reproduce sound in 5.1 channel for watching videos of overdubbed or old movies.
	PRO LOGIC II MUSIC [PLII MUSIC]	Performs Dolby Pro Logic II Music mode decoding. This setting is ideal for normal stereo sources such as CDs.
Movie	MOVIE-D.C.S.- ^{a)} [MOVIE-D.C.S.-]	Reproduces the sound characteristics of the Sony Pictures Entertainment "Cary Grant Theater" cinema production studio. This is a standard mode, great for watching almost any type of movie.
Music	SPORTS [SPORTS]	Reproduces the feeling of sports broadcasting.
	GAME [GAME]	Reproduces powerful and realistic sound, suited for playing video games.
	NEWS [NEWS]	Reproduces a clearer announcer's voice.
	PORTABLE AUDIO ENHANCER [P. AUDIO]	Reproduces a clear enhanced sound image from your portable audio device. This mode is ideal for MP3 and other compressed music.
Others ^{b)}	HEADPHONE 2CH [HP 2CH]	Outputs the sound from headphone left and right. Multi channel surround formats are downmixed to 2 channels.
	HEADPHONE THEATER [HP THEATER]	Outputs the sound as surround from headphone left and right.

^{a)}D.C.S. technology is used. For details, see "Glossary" (page 63).

^{b)}This decoding mode appears when you connect the headphones to surround amplifier (S-AIR sub unit) (not supplied).

Notes

- The effects provided by the virtual speakers may cause increased noise in the playback signal.
- When listening with sound fields that employ the virtual speakers, you will not be able to hear any sound coming directly from the surround speakers.
- Multi channel Linear PCM is not available for “P. AUDIO”.
- The movie and music mode do not work when:
 - signals with a sampling frequency of more than 48 kHz is input.
 - the multi channel Linear PCM signals are received via an HDMI IN jack.
- The sound is not output from multiple speakers depending on the source.
- Depending on the disc or source, the beginning of the sound may be cut off as the optimum mode is automatically selected. To avoid cutting the sound, select “A.F.D. STD”.
- When the input signal is multi channel source, Dolby Pro Logic II MOVIE/MUSIC are canceled and the multi channel source is output directly.
- When the bilingual broadcast sound is input, Dolby Pro Logic II MOVIE/MUSIC are not effective.
- Depending on the input stream, the decoding mode may not be effective.
- When you select “MOVIE-D.C.S.-” depending on the input stream, Dolby Pro Logic may be applied automatically.
- When changing the sound mode while using the S-AIR receiver (not supplied), sound from the S-AIR receiver (not supplied) may skip.

Tip

You can identify the encoding format of DVD software, etc., by looking at the logo on the package.

Enjoying the sound at low volume (NIGHT MODE)

You can enjoy sound effects and hear the dialog clearly even at a low volume level using this function. This function is useful for enjoying sound at night.

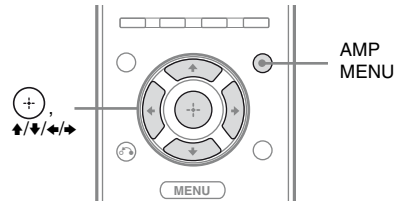

1 Press AMP MENU.

“LEVEL” appears on the display.

2 Press ↑/↓ repeatedly until “AUDIO” appears, then press

⊕ or →.

3 Press ↑/↓ repeatedly until “NIGHT MODE” appears, then press ⊕ or →.

4 Press ↑/↓ repeatedly until “NIGHT ON” appears, then press ⊕.

“NIGHT” lights up on the display.

- NIGHT ON: Turn on the NIGHT MODE.
- NIGHT OFF: Turn off the NIGHT MODE.

The initial setting is “NIGHT OFF”.

5 Press AMP MENU.

The AMP menu turns off.

Tuner Operations

Listening to FM/AM radio

You can listen to FM and AM broadcasts through the built-in tuner. Before operation, be sure you have connected the FM and AM antennas to the receiver (page 24).

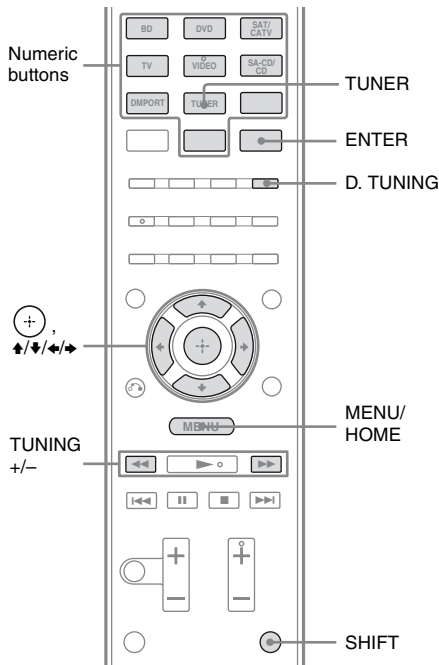

Tuning into a station automatically (Auto Tuning)

- 1 Press TUNER repeatedly to select the FM or AM band.**
You can also press INPUT SELECTOR +/- on the receiver.
- 2 Press and hold TUNING +/- until the auto scanning starts.**
Press TUNING + to scan from low to high frequency; press TUNING - to scan from high to low frequency.
The receiver stops scanning whenever a station is received. To stop the Auto Tuning manually, press TUNING +/-.

If an FM program is noisy

If an FM program is noisy, you can select monaural reception. There will be no stereo effect, but reception will improve.

- 1 Press MENU/HOME.**
- 2 Press +/- repeatedly until "FM MODE" appears, then press (+).**
- 3 Press +/- repeatedly until "MONO" appears, then press (+).**
 - STEREO: Stereo reception.
 - MONO: Monaural reception.The initial setting is "STEREO".
- 4 Press MENU/HOME.**

Tip

To improve reception, reorient the supplied antennas.

Tuning into a station directly (Direct Tuning)

Enter the frequency of a station directly by using the numeric buttons.

- 1 Press TUNER repeatedly to select the FM or AM band.**
You can also press INPUT SELECTOR +/- on the receiver.
- 2 Press D.TUNING.**
- 3 Press and hold SHIFT, then press the numeric buttons to enter the frequency.**
Example 1: FM 102.50 MHz
Select 1 → 0 → 2 → 5 → 0
Example 2: AM 1,350 kHz
Select 1 → 3 → 5 → 0
If you have tuned in an AM station, adjust the direction of the AM loop antenna (aerial) for optimum reception.
- 4 Press and hold SHIFT, then press ENTER.**

If a wrong frequency is entered

“FM ---,--” or “AM ----” appears and then the display returns to the current frequency.

If you cannot tune in a station

Make sure you have entered the right frequency. If not, repeat steps 2 to 4. If you still cannot tune in a station, the frequency is not used in your area.

Changing the AM tuning interval

(Models of area code SP1, TW2, TH1 only)

The AM tuning interval can be set to either 10 kHz or 9 kHz.

- 1 Press TUNER repeatedly until “AM” appears on the display.**
- 2 Press MENU/HOME.**
- 3 Press ↑/↓ repeatedly until “AM STEP” appears on the display, then press ⊕ or →.**
“10K → 9K” or “9K → 10K” appears on the display.
- 4 Press ⊕.**
“COMPLETE” appears on the display.
The AM tuning interval is changed.
- 5 Press MENU/HOME.**

Note

If you change the interval, AM preset stations will be erased.

Presetting radio stations

You can preset up to 20 FM stations and 10 AM stations. Then you can easily tune in the stations you often listen to.

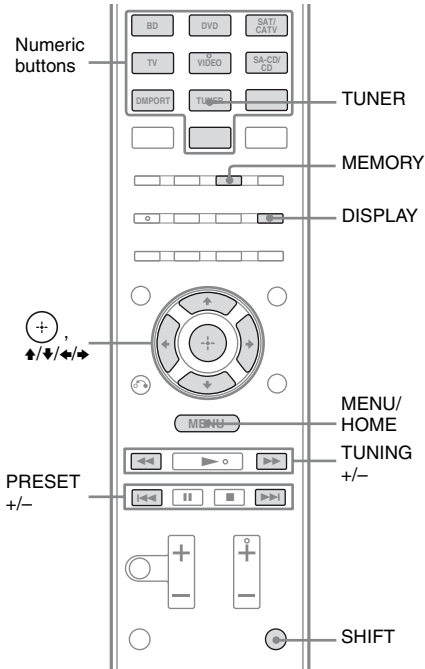

1 Press TUNER repeatedly to select the FM or AM band.

You can also press INPUT SELECTOR +/- on the receiver.

2 Press and hold TUNING +/- until the auto scanning starts.

Scanning stops when the receiver tunes in a station. "ST" (for stereo program) lights up on the display.

3 Press MEMORY.

A preset number appears on the display.

4 Press \uparrow/\downarrow repeatedly to select the preset number you want.

You can also select the preset number directly by holding SHIFT and then press the numeric buttons.

5 Press \oplus .

"COMPLETE" appears on the display and the station is stored.

6 Repeat steps 2 to 5 to store other stations.

To change the preset number

Restart from step 3.

Tuning to preset stations

1 Press TUNER repeatedly to select the FM or AM band.

You can also press INPUT SELECTOR +/- on the receiver.

2 Press PRESET +/- repeatedly to select the preset station you want.

Each time you press the button, the receiver tunes in one preset station. You can also press and hold SHIFT, then press the numeric buttons to select the preset station you want. Then, press \oplus to enter the selection.

Naming preset station

You can enter a name for preset stations. These names (for example, “XYZ”) appear on the display when a station is selected. Note that no more than one name can be entered for each preset station.

1 Press TUNER repeatedly to select the FM or AM band.

You can also press INPUT SELECTOR +/- on the receiver.

2 Press PRESET +/- repeatedly to select the preset station you want to create an index name for.

3 Press MENU/HOME.

4 Press \uparrow/\downarrow repeatedly until “NAME IN” appears, then press \oplus .

5 Create a name by using $\uparrow/\downarrow/\leftarrow/\rightarrow$.

Press \uparrow/\downarrow repeatedly to select a character, then press \rightarrow to move the cursor to the next position. Letters, numbers and other symbols can be input for a radio station name.

If you enter a wrong character

Press \leftarrow/\rightarrow repeatedly until the character to be changed flashes, then press \uparrow/\downarrow repeatedly to select the desired character.

6 Press \oplus .

“COMPLETE” appears on the display and the station name is stored.

7 Press MENU/HOME.

Viewing the station name or frequency on the display

When the receiver is set to “FM” or “AM”, you can check the frequency using the display.

Press DISPLAY.

Each time you press DISPLAY, the display changes as shown.

Station name^{a)} → Frequency^{b)} →
FM Mode^{b)}

^{a)}This is displayed if you have entered a name for a preset station.

^{b)}Returns to the original display when several seconds have elapsed.

Using the Radio Data System (RDS)

(Models of area code CEL only)

This receiver allows you to use Radio Data System (RDS), which enables radio stations to send additional information along with the regular program signal. You can display RDS information.

Notes

- RDS is operable only for FM stations.
- Not all FM stations provide RDS service, nor do they provide the same type of services. If you are not familiar with the RDS services in your area, check with your local radio stations for details.

Receiving RDS broadcasts

Simply select a station on the FM band using Direct Tuning (page 36), Auto Tuning (page 35), or Preset Tuning (page 37).

When you tune in a station that provides RDS services, the program service name appears on the display.

Note

RDS may not work properly if the station you tuned to is not transmitting the RDS signal properly or if the signal strength is weak.

Displaying RDS information

While receiving an RDS station, press DISPLAY repeatedly.

Each time you press the button, RDS information on the display changes cyclically as follows:

Program Service name → Frequency → FM mode

“BRAVIA” Sync Features

What is “BRAVIA” Sync?

“BRAVIA” Sync is compatible with Sony TV, Blu-ray Disc/DVD player, AV amplifier, etc., that is equipped with the Control for HDMI function.

By connecting Sony components that are compatible with the “BRAVIA” Sync using an HDMI cable (not supplied), operation is simplified as follows:

- One-Touch Play (page 41)
- System Audio Control (page 42)
- System Power Off (page 43)
- Audio Return Channel (ARC) (page 45)
- Theatre Mode (page 46)

Control for HDMI is a mutual control function standard used by HDMI CEC (Consumer Electronics Control) for HDMI (High-Definition Multimedia Interface).

The Control for HDMI function will not operate correctly in the following cases:

- When you connect the receiver to a component which does not correspond with Sony Control for HDMI function.
- When you connect the receiver and components using other than HDMI connection.

We recommend that you connect the receiver to products featuring “BRAVIA” Sync.

Note

Depending on the connected component, the Control for HDMI function may not work. Refer to the operating instructions of the component.

Preparing for the “BRAVIA” Sync

To use the “BRAVIA” Sync, turn the Control for HDMI function on for both the receiver and the connected component. The receiver is compatible with the “Control for HDMI-Easy Setting” function.

When your TV is compatible with the “Control for HDMI-Easy Setting” function

When you connect a Sony TV with the “Control for HDMI-Easy Setting” function, the Control for HDMI function of the receiver can be turned on simultaneously by turning the Control for HDMI function of the TV on.

- 1 Make sure that the receiver, TV, and playback components are connected using an HDMI cable (not supplied). (The respective components must be compatible with the Control for HDMI function).
- 2 Turn on the receiver, TV and the playback components.
- 3 Turn the Control for HDMI function of the TV on.
The Control for HDMI function of the receiver and all the connected components are simultaneously turned on. When the setup is completed, “COMPLETE” will appear. Wait until the setup is complete.

For details on setup of the TV, refer to the operating instructions of your TV.

When your TV is not compatible with the “Control for HDMI-Easy Setting” function

Turn the Control for HDMI function of the receiver and the connected component on individually.

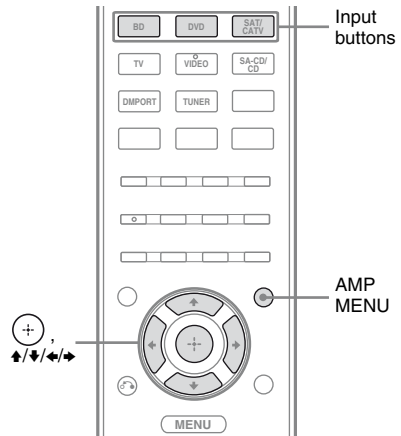

- 1 Perform the steps given in “When your TV is compatible with the “Control for HDMI-Easy Setting” function” (page 40).
- 2 Press AMP MENU.
“LEVEL” appears on the display.
- 3 Press \uparrow/\downarrow repeatedly until “SET HDMI” appears, then press \oplus or \rightarrow .
- 4 Press \uparrow/\downarrow repeatedly until “CTRL HDMI” appears, then press \oplus or \rightarrow .
- 5 Press \uparrow/\downarrow repeatedly until “CTRL ON” appears, then press \oplus .
The Control for HDMI function is set to on.
- 6 Press one of the input buttons (BD, DVD, SAT/CATV) to display the image of the playback component for which you want to set the Control for HDMI function.
- 7 Turn the Control for HDMI function of the connected component on.
For details, refer to the operating instructions of the connected component.

- 8** Repeat step 6 and 7 to set the Control for HDMI function for other connected component.

Notes

- When you unplug the HDMI cable or change the connection, perform the steps given in “When your TV is compatible with the “Control for HDMI-Easy Setting” function” (page 40) or “When your TV is not compatible with the “Control for HDMI-Easy Setting” function” (page 40).
- You cannot perform One-Touch Play and System Audio Control during Control for HDMI-Easy Setting operation.
- Before you do the Control for HDMI-Easy Setting from the TV, be sure to turn on the TV, connected components and receiver.
- If the playback components cannot function after you have made the settings for Control for HDMI-Easy Setting, check the Control for HDMI setting on your TV.
- If the connected components do not support Control for HDMI-Easy Setting, you need to set the Control for HDMI function for the connected components to on before you perform the Control for HDMI-Easy Setting from the TV.

Playing back components with one-touch operation (One-Touch Play)

By a simple operation (one touch), components connected to the receiver with HDMI connections start playback automatically.

You can enjoy the sound/image using the connected components.

Play back a connected component.

The receiver and the TV are turned on automatically and switched to the appropriate HDMI input.

Note

Be sure that the System Audio Control setting is set to on using TV menu.

Watching a DVD/Blu-ray Disc by simple operation

You can also select a connected component, such as a DVD/Blu-ray Disc player using the TV menu. In this case, the receiver and the TV switch to the appropriate HDMI input.

Note

Depending on the TV, the start of the content may not be output.

Tip

You can enjoy the components that are connected to the HDMI jacks, even if you turn the receiver off. The POWER/ACTIVE STANDBY indicator lights up in amber.

Enjoying the TV sound from the speakers connected to the receiver (System Audio Control)

You can enjoy the TV sound from the speakers connected to the receiver by a simple operation.

You can operate System Audio Control function using the TV menu. For details, refer to the operating instructions of the TV. When System Audio Control function is turned on, the receiver will turn on and switches to the appropriate input automatically.

TV sound is output from the speakers connected to the receiver, and the volume of the TV is minimized simultaneously.

You can use the System Audio Control function as follows.

- If you turn on the receiver while the TV is turned on, the System Audio Control function will automatically be set to on and the TV sound will output from the speakers connected to the receiver. However, if you turn off the receiver, the sound will output from the TV speakers.
- You can adjust the receiver's volume when you adjust the TV volume.

Notes

- If System Audio Control does not function according to your TV setting, refer to the operating instructions of the TV.
- When you connect a TV that does not have System Audio Control function, the System Audio Control function does not work.
- If the TV is turned on before turning on the receiver, the TV sound will not be output for a moment.

Using the Volume Limit function

When the System Audio Control function is active, and the output method changes from the TV speaker to the speakers connected to the receiver automatically, loud sound may be output depending on the volume level of the receiver. You can prevent this by limiting the maximum volume level.

- 1 Press AMP MENU.**
“LEVEL” appears on the display.
- 2 Press \uparrow/\downarrow repeatedly until “SET HDMI” appears, then press \oplus or \rightarrow .**
- 3 Press \uparrow/\downarrow repeatedly until “VOL LIMIT” appears, then press \oplus or \rightarrow .**
- 4 Press \uparrow/\downarrow repeatedly to select the maximum volume level you want, then press \oplus .**

The maximum volume level changes as follows:

LIMIT MAX \leftrightarrow LIMIT 49 \leftrightarrow LIMIT 48 \leftrightarrow \leftrightarrow LIMIT 2 \leftrightarrow LIMIT 1 \leftrightarrow LIMIT MIN

- 5 Press AMP MENU.**

The AMP menu turns off.

Notes

- This function is available only when the Control for HDMI function is set to on.
- This function is not available when the output method changes from the speakers connected to the receiver to the TV speaker.

Tips

- Sony recommends that you set the maximum volume level to a little lower than the volume you usually listen to.
- Regardless of the maximum volume level you set, the MASTER VOLUME on the receiver and the \triangleleft +/- on the remote are operable.
- If you do not want to limit the maximum volume level, select “LIMIT MAX”.

Turning off the receiver with the TV

(System Power Off)

When you turn the TV off by using the POWER button on the TV's remote, the receiver and the connected components turn off automatically.

You can also use the receiver's remote to turn off the TV.

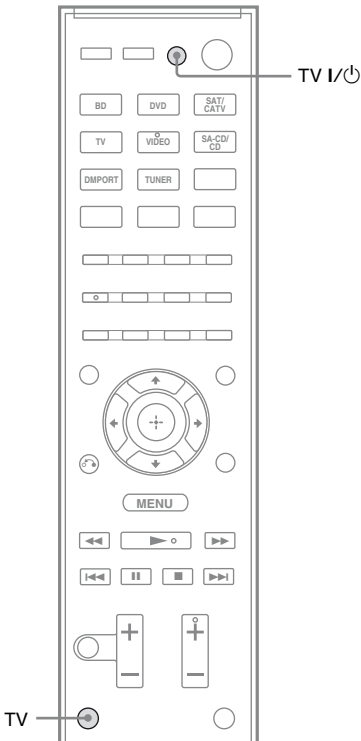

Notes

- Set the TV Standby Synchro to "ON" before using the System Power Off function. For details, refer to the operating instructions of the TV.
- Depending on the status, the connected components may not be turned off. For details, refer to the operating instructions of the connected components.

Press TV and TV I/⏻ at the same time.

The TV, receiver and the components connected via HDMI are turned off.

Using the power saving function (HDMI Signal Pass Through)

If a “BRAVIA” Sync-compatible TV is connected to the receiver, and the TV is turned off, HDMI signal transmission stops, and power consumption is reduced.

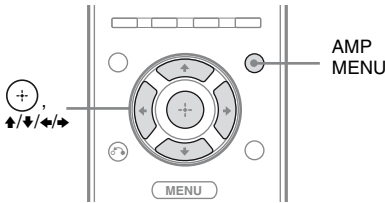

5 Press AMP MENU.

The AMP menu turns off.

Notes

- The power saving function may not work for some TVs compatible with the “BRAVIA” Sync. In this case, set “PASS THRU” to “THRU ON”.
- Depending on your components, it may take time before image or sound is output.
- This function is available only when the Control for HDMI function is set to on.

1 Press AMP MENU.

“LEVEL” appears on the display.

2 Press \uparrow/\downarrow repeatedly until “SET HDMI” appears, then press \oplus or \rightarrow .

3 Press \uparrow/\downarrow repeatedly until “PASS THRU” appears, then press \oplus or \rightarrow .

4 Press \uparrow/\downarrow repeatedly until the setting you want appears, then press \oplus .

- THRU AUTO: When the TV is turned on while the receiver is in the standby mode, the receiver outputs HDMI signals from the receiver’s HDMI TV OUT jack. Sony recommends this setting if you use a TV that is compatible with “BRAVIA” Sync. This setting saves power in the standby mode compared with the “THRU ON” setting.
- THRU ON: When the receiver is in the standby mode, the receiver continuously outputs HDMI signals from the receiver’s HDMI TV OUT jack.

Enjoying the TV sound via an HDMI connection (Audio Return Channel)

The receiver can receive the audio signal of the TV via an HDMI cable when your TV is compatible with the Audio Return Channel (ARC) function. You can enjoy TV sound via the receiver by using just one HDMI cable.

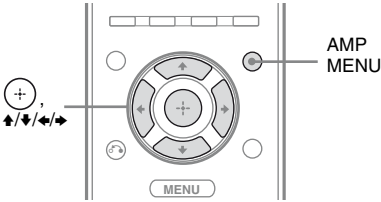

Notes

- This function is available only when the Control for HDMI function is set to on.
- Be sure that your TV is compatible with Audio Return Channel (ARC) function. For details on the TV settings, refer to the operating instructions of the TV.

1 Press AMP MENU.

“LEVEL” appears on the display.

2 Press \uparrow/\downarrow repeatedly until “SET HDMI” appears, then press \oplus or \rightarrow .

3 Press \uparrow/\downarrow repeatedly until “ARC” appears, then press \oplus or \rightarrow .

4 Press \uparrow/\downarrow repeatedly until the setting you want appears, then press \oplus .

- ARC ON: The receiver receives the audio signal of the TV automatically via an HDMI cable.
- ARC OFF: The receiver receives the audio signal of the TV via audio or optical digital cord.

5 Press AMP MENU.

The AMP menu turns off.

Enjoying optimum sound field for the selected scene

(Scene Select)

The Scene Select function allows you to enjoy the optimum picture quality and switches the sound field according to the selected scene on your TV. For details on the operation, refer to the operating instructions of the TV.

Notes

- This function is available only when the Control for HDMI function is set to on.
- The sound field may not switch depending on the TV.

Enjoying movies with the optimum sound field (Theatre Mode)

Press the THEATRE button on the remote of the receiver, TV, or the Blu-ray Disc player, while pointing the remote toward the TV.

The sound field switches to “MOVIE-D.C.S.-”. To return to the previous sound field, press the THEATRE button again.

Note

The sound field may not switch depending on the TV.

Tip

The sound field may be changed back to the previous one when you change the TV's input.

S-AIR Operations

About S-AIR products

This receiver is compatible with the S-AIR function (page 64), which allows wireless sound transmission between S-AIR products. When you purchase the S-AIR product, you need to establish the sound transmission.

There are two types of S-AIR product.

- S-AIR main unit (this receiver):
This is for transmitting sound.
You can use up to 3 S-AIR main units. (The number of usable S-AIR main unit depends on the use environment.)
- S-AIR sub unit (not supplied): This is for receiving sound.
 - Surround amplifier: You can enjoy surround speaker sound wirelessly.
 - S-AIR receiver: You can enjoy system's sound in another room.

These S-AIR products can be purchased as an option (the S-AIR products lineup differs depending on the area).

Notes or instruction for the S-AIR sub unit in this operating instructions is refer only when the S-AIR sub unit is used.

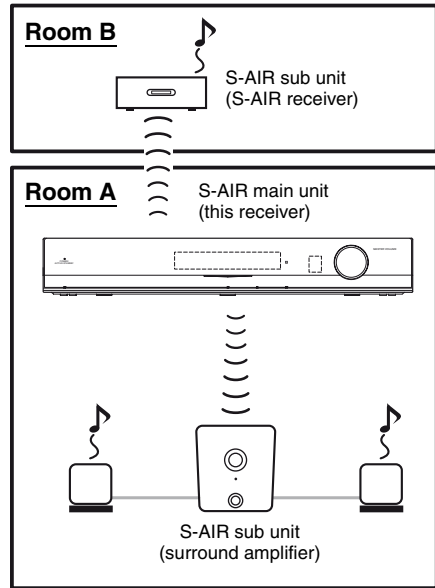

About environments where S-AIR products (S-AIR main unit and sub unit) are used

S-AIR products use a radio frequency of 2.4 GHz. Certain electronic equipment or other factors may cause lost connection or instability in S-AIR reception.

- Electronic equipment influence
The following may cause interference or cross talk.
 - Cellular phones, cordless phones
 - Wireless LAN, personal computers
 - Game machines using radio signals
 - Microwave ovens



- Other factors

- The following may cause poor reception.
- Materials or structures, such as walls and floors
 - The location where an S-AIR product is placed

When using S-AIR products, place them as far as possible from the above electronic equipment, or place where S-AIR reception is stable.

Setting up an S-AIR product

Before using an S-AIR product, be sure to perform the following settings to establish the sound transmission.

Inserting the wireless transmitter/transceiver

To make use of the S-AIR function, you need to insert the wireless transmitter (not supplied) into the S-AIR main unit and the wireless transceiver (not supplied) into the S-AIR sub unit.

Notes

- Before inserting the wireless transmitter/transceiver, be sure to disconnect the AC power cord (mains lead).
- Do not insert/detach the wireless transmitter/transceiver (not supplied) while the receiver is turned on.
- Do not touch the terminals of the wireless transmitter/transceiver.

To insert the wireless transmitter into the S-AIR main unit

1 Remove the screws.

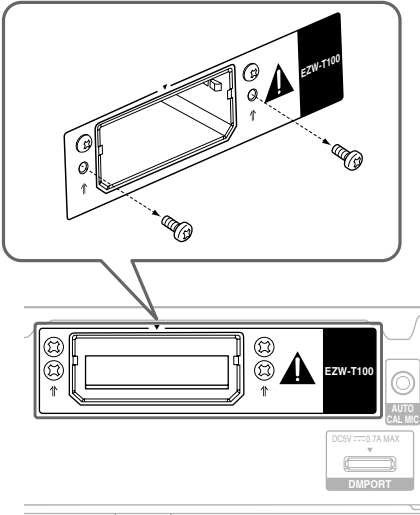

Note

Remove the screws pointed with ↑ marks. Do not remove other screws.

2 Insert the wireless transmitter.

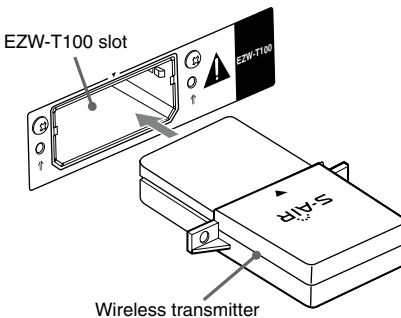

Notes

- Insert the wireless transmitter with the S-AIR logo facing up.
- Insert the wireless transmitter so that the ▼ marks are aligned.
- Do not insert other than the wireless transmitter into the EZW-T100 slot.

3 Use the screws that you removed from step 1 to fasten the wireless transmitter.

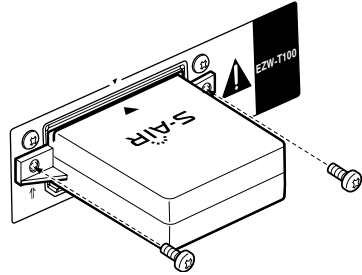

Note

Do not use other screws to fasten the wireless transmitter.

To insert the wireless transceiver into the S-AIR sub unit

Refer to the operating instructions of the S-AIR sub unit.

Establishing sound transmission between the S-AIR main unit and S-AIR sub unit (ID setting)

When you match the ID of the S-AIR main unit and the S-AIR sub unit, you can establish sound transmission.

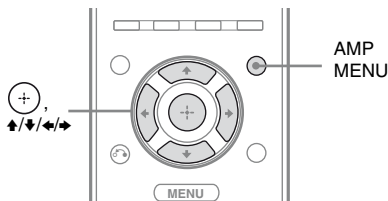

To set the ID of the S-AIR main unit

- 1 Press AMP MENU.**
“LEVEL” appears on the display.
- 2 Press ↑/↓ repeatedly until “S-AIR SET” appears, then press ⊕ or ➔.**
- 3 Press ↑/↓ repeatedly until “S-AIR ID” appears, then press ⊕ or ➔.**
- 4 Press ↑/↓ repeatedly to select the desired ID (A, B or C) then press ⊕.**

5 Set the S-AIR sub unit to the same ID.

Sound transmission is established as follows:

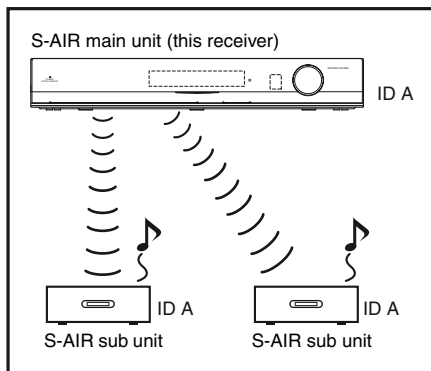

6 Press AMP MENU.

The AMP menu turns off.

To set the ID of the S-AIR sub unit

Be sure to match the ID on S-AIR sub unit you want to the S-AIR main unit.

For details on setting the ID of the S-AIR sub unit, refer to the operating instructions supplied with the S-AIR sub unit.

To use multiple S-AIR main units

You can use multiple S-AIR products by setting a different ID for each unit.

Sound transmission is established as follows:

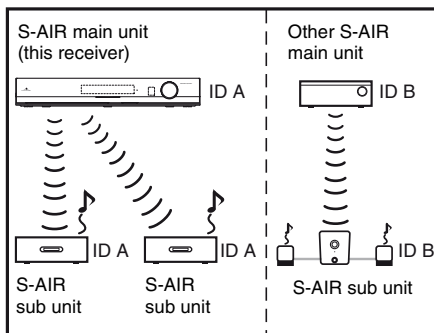

Pairing the S-AIR main unit with a specific S-AIR sub unit (Pairing operation)

To establish sound transmission, you need to set the same ID for your S-AIR main unit and S-AIR sub unit. However, if your neighbors have S-AIR products and their IDs are the same as yours, your neighbors could receive the sound of your S-AIR main unit or vice versa.

To prevent this, you can pair the S-AIR main unit with a specific S-AIR sub unit by performing the pairing operation.

■ Before pairing

Sound transmission is established by the ID.

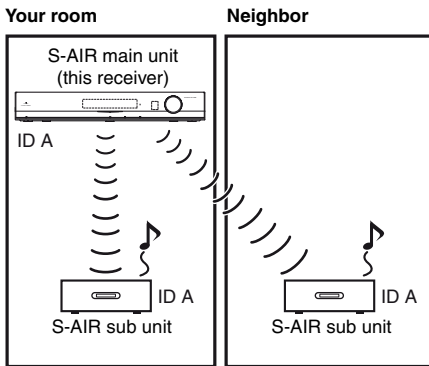

■ After pairing

Sound transmission is established between the paired S-AIR main unit and S-AIR sub unit(s) only.

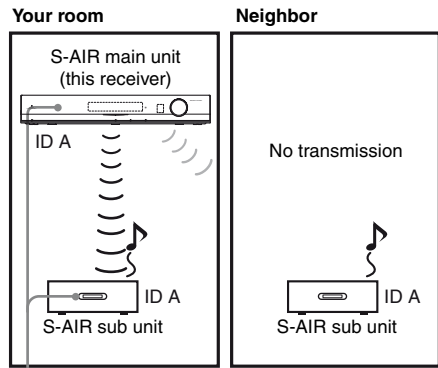

Pairing

To perform pairing

- 1 Place the S-AIR sub unit that you want to pair near the S-AIR main unit.

Note

Remove headphones from the surround amplifier (if connected).

- 2 Match the IDs of the S-AIR main unit and the S-AIR sub unit.

- To set the ID of the S-AIR main unit, see “To set the ID of the S-AIR main unit” (page 50).
- To set the ID of the S-AIR sub unit, refer to the operating instructions supplied with the S-AIR sub unit.

- 3 Press AMP MENU.

“LEVEL” appears on the display.

- 4 Press \uparrow/\downarrow repeatedly until “S-AIR SET” appears, then press \oplus or \rightarrow .

5 Press **▲/▼** repeatedly until “PAIRING” appears, then press **+** or **▶**.

6 Press **▲/▼** repeatedly until the setting you want appears, then press **+**.

- **START:** The S-AIR main unit starts pairing.
- **CONDITION:** You can check the current ID. When the pairing setting is timed out, “NO PAIRING” appears on the display.

7 Start pairing of the S-AIR sub unit.

■ For the surround amplifier

Refer to the operating instructions supplied with surround amplifier.

■ For the S-AIR receiver

Refer to the operating instructions supplied with S-AIR receiver.

8 Pairing completed.

“COMPLETE” appears on the display.

9 Press **AMP MENU**.

The AMP menu turns off.

Note

Perform the pairing within several minutes after you select “START” in step 6. Otherwise, the pairing is canceled automatically and “INCOMPLETE” appears on the display.

To cancel pairing

Reset the ID of the S-AIR main unit. For details, see “To set the ID of the S-AIR main unit” (page 50). You can set the same ID as before.

Enjoying the system’s sound in another room

(For the S-AIR receiver only (not supplied))

You can enjoy the system’s sound in another room by using the S-AIR receiver. The S-AIR receiver can be placed in another room for enjoying the system’s sound there.

For details of the S-AIR receiver, refer to the operating instructions supplied with S-AIR receiver.

Note

Sources with copyright protection may not be playable on S-AIR products.

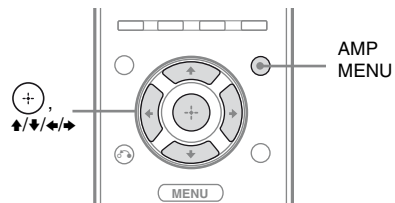

1 Set the ID of the S-AIR receiver to match the S-AIR main unit.

- To set the ID of the S-AIR main unit, see “To set the ID of the S-AIR main unit” (page 50).
- To set the ID of the S-AIR receiver, refer to the operating instructions supplied with S-AIR receiver.

Notes

- When you are using another S-AIR sub unit, such as a surround amplifier, do not change the ID of the S-AIR main unit. Set the ID of the S-AIR receiver to match the ID of the S-AIR main unit.
- When you pair the S-AIR main unit and another S-AIR sub unit, such as a surround amplifier, you also need to pair the S-AIR main unit and the S-AIR receiver. For details, see “Pairing the S-AIR main unit with a specific S-AIR sub unit (Pairing operation)” (page 51).

2 Press AMP MENU.

“LEVEL” appears on the display.

3 Press \uparrow/\downarrow repeatedly until “S-AIR SET” appears, then press \oplus or \rightarrow .**4 Press \uparrow/\downarrow repeatedly until “S-AIR MODE” appears, then press \oplus or \rightarrow .****5 Press \uparrow/\downarrow repeatedly until the setting you want appears, then press \oplus .**

- PARTY: The S-AIR sub unit outputs sound according to function set on the S-AIR main unit.
- SEPARATE: You can select the input you want for the S-AIR receiver while the input of the S-AIR main unit remain unchanged.

When “SEPARATE” is set, the functions you can select are “MAIN UNIT”, “SA-CD/CD”, “DMPORT”, “TUNER FM” and “TUNER AM”. To enjoy the same function as the S-AIR main unit, select “MAIN UNIT”.

6 Select the desired function on the S-AIR product.

When the sound is other than 2 channel stereo, multi channel sound is downmixed to 2 channel.

7 Adjust the volume on the S-AIR receiver.**Note**

When “TUNER FM” or “TUNER AM” is selected on the receiver, you can only select the same band for the tuner on the S-AIR product.

To control the system from the S-AIR receiver

You can control the system from the S-AIR receiver by using the following buttons.

Press	Operation
\blacktriangleright , \parallel , \blacksquare , \blacktriangleleft / \blacktriangleright	Share the same operations on the remote.
S-AIR CH	Change the function of the system.

For details, refer to the operating instructions of the S-AIR receiver.

Stabilizing S-AIR reception

Read the following when S-AIR reception is poor or unstable.

When S-AIR reception is poor

Check the following.

- Keep cords that are connected to the S-AIR product (AC power cord (mains lead), speaker cords, or other cords) away from the wireless adapter and slot.

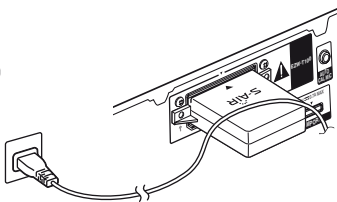
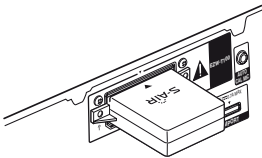

- Keep as much space as possible around S-AIR products.
 - Avoid placing S-AIR products on top of or directly below other electronic equipment.
 - Avoid placing S-AIR products in a closed rack, metal rack or under a table.

- Adjust the location (height, orientation, and place in the room) of S-AIR products until reception is the most stable.

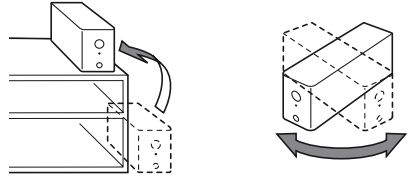

- Place so that the wireless adapters of the S-AIR main unit and sub unit are closer.

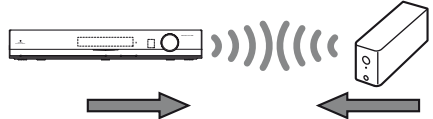

- Place so that S-AIR products are separated from other wireless devices.

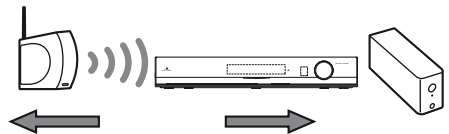

- Place so that S-AIR products are separated from metal doors or tables.

If you still cannot improve S-AIR reception, change the “RF CHANGE” setting (page 55).

Changing the channel for better sound transmission

If you use multiple wireless systems which sharing the 2.4 GHz band, such as wireless LAN or Bluetooth, the transmission of S-AIR products or other wireless systems may be unstable. In this case, the transmission may be improved by changing the following “RF CHANGE” setting.

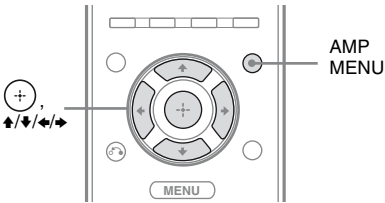

Notes

- When the wireless transmitter is not inserted in the S-AIR main unit, you cannot set “RF CHANGE”.
- In most cases, you will not need to change this setting.
- If “RF CHANGE” is set to “RF OFF”, transmission between the S-AIR main unit and S-AIR sub unit can be performed using one of the following channels.
 - S-AIR ID A: equivalent channel for IEEE 802.11b/g channel 1
 - S-AIR ID B: equivalent channel for IEEE 802.11b/g channel 6
 - S-AIR ID C: equivalent channel for IEEE 802.11b/g channel 11
- The transmission may be improved by changing the transmission channel (frequency) of the other wireless system(s). For details, refer to the operating instructions of the other wireless system(s).

1 Press AMP MENU.

“LEVEL” appears on the display.

2 Press \uparrow/\downarrow repeatedly until “S-AIR SET” appears, then press \oplus or \rightarrow .

3 Press \uparrow/\downarrow repeatedly until “RF CHANGE” appears, then press \oplus or \rightarrow .

4 Press \uparrow/\downarrow repeatedly until the setting you want appears, then press \oplus .

- RF AUTO: Normally select this. The system change “RF CHANGE” to “RF ON” or “RF OFF” automatically.
- RF ON: The system transmits sound by searching the better channel for transmitting.
- RF OFF: The system transmits sound by fixing the channel for transmitting.

5 Press AMP MENU.

The AMP menu turns off.

Enjoying the S-AIR receiver while the S-AIR main unit is in standby mode

(For the S-AIR receiver only (not supplied))

You can enjoy the S-AIR receiver while the S-AIR main unit is in standby mode by setting “S-AIR STBY” to “STBY ON”.

Note

The POWER/ACTIVE STANDBY indicator in the S-AIR main unit (this receiver) lights up in amber.

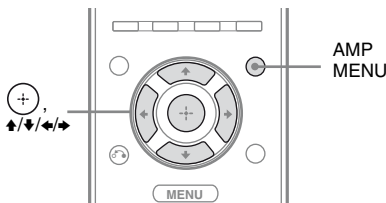

5 Press AMP MENU.

The AMP menu turns off.

Notes

- When you set “S-AIR STBY” to “STBY ON”, the power consumption increases during the standby mode.
- When the wireless transmitter is not inserted in the S-AIR main unit, you cannot set “S-AIR STBY”.
- When the wireless transmitter is removed from the S-AIR main unit, “S-AIR STBY” is set to “STBY OFF” automatically.
- When you turn the system off while “S-AIR STBY” is set to “STBY ON”, you cannot use any buttons other than I/⏻.
- The sound of the S-AIR receiver may be cut off by operation of the S-AIR main unit.

1 Press AMP MENU.

“LEVEL” appears on the display.

2 Press ↑/↓ repeatedly until “S-AIR SET” appears, then press ⊕ or →.

3 Press ↑/↓ repeatedly until “S-AIR STBY” appears, then press ⊕ or →.

4 Press ↑/↓ repeatedly until the setting you want appears, then press ⊕.

- STBY OFF: You cannot enjoy the S-AIR receiver while the S-AIR main unit is in standby mode.
- STBY ON: You can enjoy the S-AIR receiver while the S-AIR main unit is in standby mode or turned on.

Advanced Settings

Changing the input button assignments

You can change the initial settings of the input buttons (BD, DVD, SAT/CATV, VIDEO and SA-CD/CD) to suit the components in your system. For example, if you connect a Blu-ray Disc player to the DVD jack on the receiver, you can set the DVD button on this remote to control the Blu-ray Disc player.

Note

You cannot change the remote assignments for TV, DMPORT and TUNER.

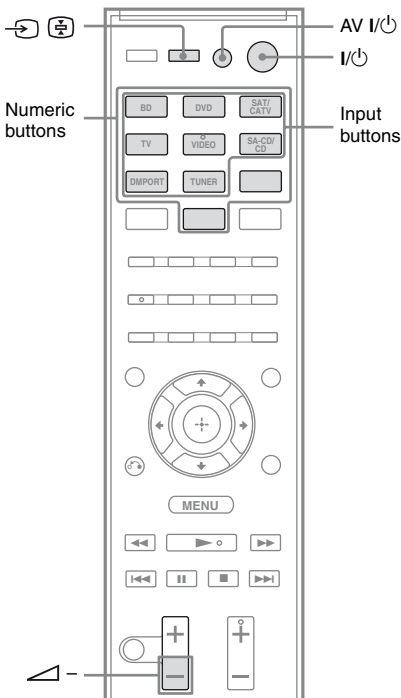

- 1** While holding down the input button of which you want to change the assignment, hold down AV I/⏻.

Example: While holding down DVD, hold down AV I/⏻.

- 2** With the AV I/⏻ button held, release the input button you selected in step 1.

Example: With the AV I/⏻ button held, release DVD.

- 3** Referring to the following table, press the corresponding button for the category you want, then release AV I/⏻.



Example: Press 1, then release AV I/⏻. Now you can use the DVD button to control the Blu-ray Disc player.

Categories and the corresponding buttons for BD, DVD, SAT/CATV, VIDEO and SA-CD/CD

Categories	Press
Blu-ray Disc player (command mode BD1) ^{a)}	1
Blu-ray Disc recorder (command mode BD3)	2
DVD player (command mode DVD1)	3
DVD recorder (command mode DVD3) ^{b)}	4
VCR (command mode VTR3)	5
CD player	6
Euro Digital Satellite Receiver ^{c)}	7

- a) The initial setting of the BD button.
For details on the BD1 or BD3 setting, refer to the operating instructions supplied with the Blu-ray Disc player or Blu-ray Disc recorder.
- b) The initial setting of the DVD button.
Sony DVD recorders are operated with a DVD1 or DVD3 setting. For details, refer to the operating instructions supplied with the DVD recorders.
- c) The initial setting of the SAT/CATV button.

To clear all remote button assignments

While holding down , press  and .







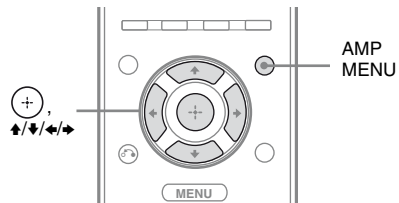

The remote is reset to its initial settings.

Settings and adjustments using the amplifier menu

By using the amplifier menus, you can make various adjustments to customize the receiver.

Navigating through menus



- 1 Press AMP MENU.**
“LEVEL” appears on the display.
- 2 Press  repeatedly until the menu you want appears, then press  or .**
- 3 Press  repeatedly until the parameter you want to adjust appears, then press  or .**
- 4 Press  repeatedly until the setting you want appears, then press .**

To return to the previous display

Press .

To exit the menu

Press AMP MENU.

Overview of the menus

You can set the following items using the AMP MENU. For details of each menu, see the following pages.

The default settings are underlined.

AMP MENU

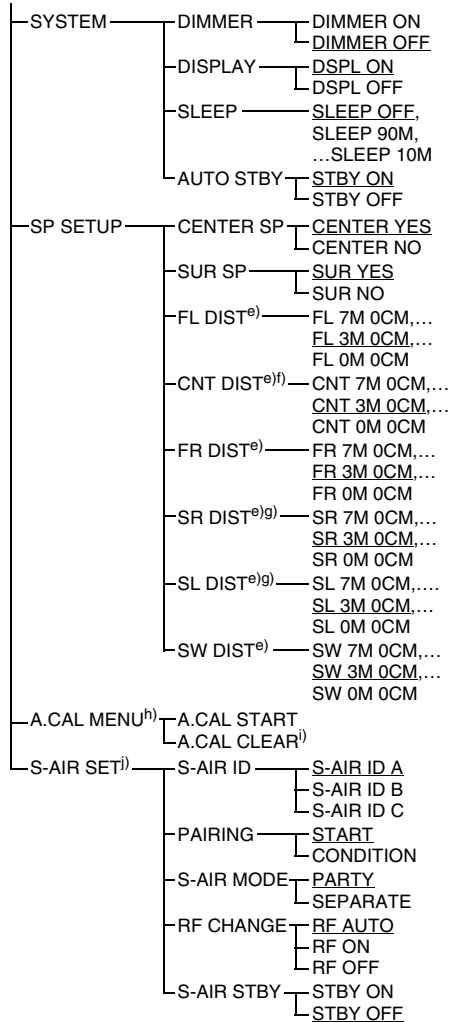
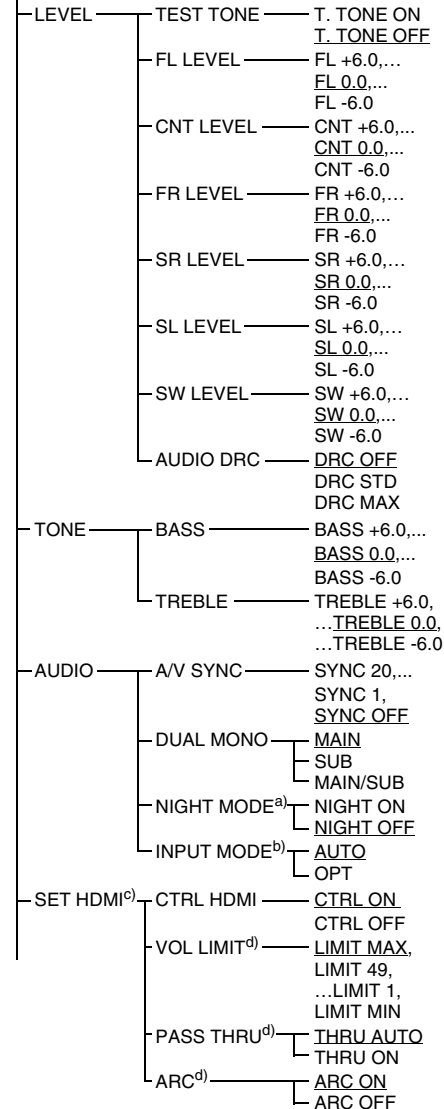

- a) For details, see “Enjoying the sound at low volume (NIGHT MODE)” (page 34).
- b) This parameter is only available when SAT/CATV input is selected.
- c) For details, see “Preparing for the “BRAVIA” Sync” (page 40).
- d) This parameter is only available when “CTRL HDMI” is set to “CTRL ON”.
- e) When the Auto Calibration result is saved, you can adjust the setting in 1 cm increment.
- f) This parameter is only available when “CENTER SP” is set to “CENTER YES”.
- g) This parameter is only available when “SUR SP” is set to “SUR YES”.
- h) For details, see “Performing Auto Calibration” (page 26).
- i) This parameter is only available when the result of the Auto Calibration is saved.
- j) This menu is only available when you insert the S-AIR transmitter (not supplied). For details, see “Setting up an S-AIR product” (page 48).

LEVEL menu

You can adjust the level of each speaker to suit your preference.

■ TEST TONE

You can adjust the speaker levels while listening to the test tone from your listening position.

To adjust the speaker levels

- **FL LEVEL (Front left speaker level)**
- **CNT LEVEL (Center speaker level)**
- **FR LEVEL (Front right speaker level)**
- **SR LEVEL (Surround right speaker level)**
- **SL LEVEL (Surround left speaker level)**
- **SW LEVEL (Subwoofer level)**

1 Press \uparrow/\downarrow repeatedly until “TEST TONE” appears, then press \oplus or \blacktriangleright .

2 Press \uparrow/\downarrow repeatedly until “T. TONE ON” appears, then press \oplus .

The test tone is emitted from each speaker in sequence as follows:
 Front left \rightarrow Center \rightarrow Front right \rightarrow
 Surround right \rightarrow Surround left \rightarrow
 Subwoofer

3 Press \leftarrow until “TEST TONE” appears.

4 Press \uparrow/\downarrow repeatedly to select the desired speaker, then press \oplus or \blacktriangleright .

The test tone is emitted from the speaker that is being adjusted only.

- FL LEVEL, CNT LEVEL, FR LEVEL, SR LEVEL, SL LEVEL, SW LEVEL

Notes

- “CNT LEVEL” does not appear when you set “CENTER NO” in the “SP SETUP” setting.
- “SR LEVEL” and “SL LEVEL” do not appear when you set “SUR NO” in the “SP SETUP” setting.

5 Press \uparrow/\downarrow repeatedly to adjust the speaker level, then press \oplus .

You can adjust from -6.0 dB to $+6.0$ dB in 0.5 dB steps.

Note

If you do not adjust for a certain period, the test tone is emitted from the next speaker in sequence.

6 Repeat step 4 and 5 to adjust the other speaker level.

7 After you have finished making adjustments, press \uparrow/\downarrow repeatedly until “TEST TONE” appears, then press \oplus or \blacktriangleright .

- 8** Press **▲/▼** repeatedly until “T. TONE OFF” appears, then press **⊕**.

When a test tone is not output from the speakers

- The speaker cords may not be connected securely.
- The speaker cords may have the short-circuit problem.

Note

The test tone signals are not output from the HDMI OUT jack.

■ AUDIO DRC

You can compress the dynamic range of the sound track. This may be useful when you want to watch movies at low volume. AUDIO DRC only applies to Dolby Digital sources.

- DRC OFF: Does not compress dynamic range.
- DRC STD: Compress dynamic range as intended by the recording engineer.
- DRC MAX: Compress dynamic range fully.

Tip

Audio dynamic range compression lets you compress the dynamic range of the soundtrack based on the dynamic range information included in the Dolby Digital signal.

“DRC STD” is the standard setting, but it only enacts light compression. Therefore, we recommend using the “DRC MAX” setting. This greatly compresses the dynamic range and lets you view movies late at night at low volumes. Unlike analog limiters, the levels are predetermined and provide a very natural compression.

TONE menu

You can adjust the tonal quality (bass and treble level) of the speakers.

■ BASS

■ TREBLE

To adjust the tone level

- 1 Press **▲/▼** repeatedly until “BASS” or “TREBLE” appears, then press **⊕** or **➔**.
- 2 Press **▲/▼** repeatedly until bass or treble level appears, then press **⊕**.
You can adjust from -6.0 dB to +6.0 dB in 0.5 dB steps.

AUDIO menu

You can make the settings for the audio to suit your preference.

■ A/V SYNC

You can delay the sound output using this function when the image is slower than the sound.

- SYNC OFF: Does not adjust.
- SYNC 1 – 20: Adjusts from 1 (10 ms) to 20 (200 ms) in 1 (10 ms) steps.

Notes

- You may not be able to adjust the delay between sound and image perfectly using this function.
- This function is useful only for Dolby Digital, DTS and Linear PCM (2ch) input by optical and coaxial audio input signals.

■ DUAL MONO

You can select the language you want to listen to during digital broadcast. This feature only functions for Dolby Digital sources.

- MAIN: Outputs sound of the main language.
- SUB: Outputs sound of the sub language.
- MAIN / SUB: Outputs sound of the main language through the front left speaker and sound of the sub language through the front right speaker simultaneously.

To set the speaker distance from your listening position

1 Press $\blacktriangle/\blacktriangledown$ repeatedly until the speaker you want to adjust appears, then press \oplus or \blacktriangleright .

- FL DIST, CNT DIST, FR DIST, SR DIST, SL DIST, SW DIST

Notes

- “CNT DIST” does not appear when you set “CENTER NO” in the “SP SETUP” setting.
- “SR DIST” and “SL DIST” do not appear when you set “SUR NO” in the “SP SETUP” setting.

2 Press $\blacktriangle/\blacktriangledown$ repeatedly to set the speaker distance, then press \oplus . You can adjust from 0M 0CM to 7M 0CM.

Tip

When the Auto Calibration result is saved, you can adjust the speakers distance in 1 cm steps. If the Auto Calibration result is not saved, you can adjust the speakers distance in 10 cm steps.

3 Repeat step 1 and 2 to adjust the other speaker distance.

Additional Information

Glossary

■ Deep Colour

Video signals for which the colour depth of signals passing through an HDMI jack have been raised.

The number of colours that could be expressed by 1 pixel was 24 bits (16,777,216 colours) with the current HDMI jack. However, the number of colours which can be expressed by 1 pixel will be 36 bits, etc., when the receiver corresponds to Deep Colour.

Since the gradation of the depth of a colour can be expressed more finely with more bits, continuous colour changes can be more smoothly expressed.

■ Digital Cinema Sound (DCS)

A unique sound reproduction technology for home theater developed by Sony, in cooperation with Sony Pictures Entertainment, for enjoying the exciting and powerful sound of movie theaters at home. With this “Digital Cinema Sound” developed by integrating a DSP (Digital Signal Processor) and measured data, the ideal sound field intended by filmmakers can be experienced at home.

■ Dolby Digital

This movie theater sound format is more advanced than Dolby Surround Pro Logic. In this format, the surround speakers output stereo sound with an expanded frequency range, and a subwoofer channel for deep bass is independently provided. This format is also called “5.1” with the subwoofer channel designed as the 0.1 channel (since it functions only when a deep bass effect is needed). All six channels in this format are recorded separately for superior channel separation. Furthermore, since all the signals are processed digitally, less signal degradation occurs.

■ Dolby Pro Logic II

Dolby Pro Logic II creates five full-bandwidth output channels from 2 channel sources. This is done using an advanced, high-purity matrix surround decoder that extracts the spatial properties of the original recording without adding any new sounds or tonal colorations.

■ Dolby Surround (Dolby Pro Logic)

Audio processing technology developed by Dolby Laboratories, Inc. Center and mono surround information is matrixed into two stereo channels. When reproduced, audio is decoded and output in 4 channel surround sound. This is the most common audio processing method for DVD-video.

■ DTS Digital Surround

Digital audio encoding/decoding technology for theaters developed by DTS, Inc. It compresses audio less than Dolby Digital, delivering a higher quality sound reproduction.

■ HDMI (High-Definition Multimedia Interface)

HDMI (High-Definition Multimedia Interface) is an interface that supports both video and audio on a single digital connection, allowing you to enjoy high quality digital picture and sound. The HDMI specification supports HDCP (High-bandwidth Digital Contents Protection), a copy protection technology that incorporates coding technology for digital video signals.

■ L.F.E. (Low Frequency Effects)

Sound effects of low frequencies which are output from a subwoofer in Dolby Digital or DTS, etc. By adding a deep bass with a frequency between 20 to 120 Hz, audio becomes more powerful.

■ S-AIR (Sony Audio Interactive Radio frequency)

Recent times have seen the rapid spread of DVD media, Digital Broadcasting, and other high quality media.

To ensure that the subtle nuances of these high quality media are transmitted with no deterioration, Sony has developed a technology called "S-AIR" for the radio transmission of digital audio signals with no compression, and has incorporated this technology into the EZW-RT10/EZW-T100. This technology transfers digital audio signals with no compression using the 2.4 GHz band range of ISM band (Industrial, Scientific, and Medical band), such as wireless LANs and Bluetooth applications.

■ S-Master

S-Master is an all-digital amplifier technology developed by Sony, which effectively minimizes the occurrence of sound fragmentation and jitter, delivering superb dialog clarity and faithful reproduction of the original sound. The compact amplifier section supports a higher power efficiency and improved thermal performance.

■ Sampling frequency

To convert analog audio to digital, analog data should be quantified. This process is called sampling, and the number of times per second the analog data is quantified is called the sampling frequency. A standard music CD stores data quantified at 44,100 times per second, which is expressed as a sampling frequency of 44.1 kHz. Generally speaking, a higher sampling frequency means better sound quality.

■ TSP (Time Stretched Pulse)

A TSP signal is a highly precise measuring signal that utilizes impulse energy, measuring a wide band, from low to high, in a short period.

The amount of energy used to measure signals is important to ensure measurement accuracy in a normal indoor environment. Using TSP signals makes it possible to measure signals effectively.

■ x.v.Colour

“x.v.Colour” enables the more faithful reproduction of various colours such as the brilliant colours of flowers and the turquoise blue of the southern ocean.

“x.v.Colour” is a promotion name given to the products that have the capability to realize a wide colour space based on the xvYCC specifications and is a trademark of Sony Corporation.

xvYCC is an international standard of the technical specifications of the extended-gamut colour space for video signals. The colour gamut of xvYCC is wider than the one of sRGB that is used with the current television system.

Precautions

On safety

Should any solid object or liquid fall into the cabinet, unplug the receiver and have it checked by qualified personnel before operating it any further.

On power sources

- Before operating the receiver, check that the operating voltage is identical with your local power supply.
The operating voltage is indicated on the nameplate on the back of the receiver.
- The unit is not disconnected from the AC power source (mains) as long as it is connected to the wall outlet, even if the unit itself has been turned off.
- If you are not going to use the receiver for a long time, be sure to disconnect the receiver from the wall outlet. To disconnect the AC power cord (mains lead), grasp the plug itself; never pull the cord.
- The AC power cord (mains lead) must be changed only at a qualified service shop.

On heat buildup

Although the receiver heats up during operation, this is not a malfunction. If you continuously use this receiver at a large volume, the cabinet temperature of the top, side and bottom rises considerably. To avoid burning yourself, do not touch the cabinet.

On placement

- Place the receiver in a location with adequate ventilation to prevent heat buildup and prolong the life of the receiver.
- Do not place the receiver near heat sources, or in a place subject to direct sunlight, excessive dust, or mechanical shock.
- Do not place anything on top of the cabinet that might block the ventilation holes and cause malfunctions.
- Do not place the receiver near equipment such as a TV, VCR, or tape deck. If the receiver is being used in combination with a TV, VCR, or tape deck, and is placed too close to that equipment, noise may result, and picture quality may suffer. This is especially likely when using an indoor antenna (aerial). Therefore, we recommend using an outdoor antenna (aerial).
- Use caution when placing the receiver or speakers on surfaces that have been specially treated (with wax, oil, polish, etc.) as staining or discolouration of the surface may result.

On operation

Before connecting other components, be sure to turn off and unplug the receiver.

If you encounter colour irregularity on a nearby TV screen

The center speaker is magnetically shielded to allow it to be installed near a TV set. However, colour irregularities may still be observed on certain types of TV sets. As the front speakers, surround speakers and subwoofer are not magnetically shielded, we recommend that you place them slightly further away from TV set (page 15).

If colour irregularity is observed...

Turn off the TV set, then turn it on again after 15 to 30 minutes.

If colour irregularity is observed again...

Place the speaker further away from the TV set.

If howling occurs

Reposition the speakers or turn down the volume on the receiver.

On cleaning

- Clean the cabinet, panel, and controls with a soft dry cloth. Do not use any type of abrasive pad, scouring powder, scrubbing brush or sponge.
- If it is stained with oil or fingerprints, breath on the surface and wipe it with soft dry cloth.

On S-AIR function

- As the S-AIR product(s) transmits sound by radio waves, sound may skip when radio waves are obstructed. This is a characteristic of radio waves and is not malfunction.
- As the S-AIR product(s) transmits sound by radio waves, equipment that generates electromagnetic energy, such as a microwave oven, may interfere with sound transmission.
- As the S-AIR product(s) uses the radio waves that share the same frequency as other wireless systems, such as wireless LAN or Bluetooth devices, interference or poor transmission may result. In this case, take the following steps:
 - Avoid placing the S-AIR product(s) near other wireless systems.
 - Avoid using the S-AIR product(s) and the other wireless systems at the same time.
 - The transmission may be improved by changing the transmission channel (frequency) of the other wireless system(s). For details, refer to the operating instructions of the other wireless system(s).

- The transmission distance differs depending on the usage environment. Find a location where transmission between the S-AIR main unit and sub unit is most effective, and install the S-AIR main unit and sub unit there.
- Place the S-AIR product(s) on the stable surface off the floor.
- Poor transmission may occur and the transmission distance may be too short if the following conditions exist:
 - There is a wall/floor made of reinforced concrete or stone between the S-AIR product(s).
 - There is an iron divider/door or furniture/ electric product made of fireproof glass, metal, etc., between the S-AIR product(s).

If you have any questions or problems concerning your receiver, please consult your nearest Sony dealer.

Troubleshooting

If you experience any of the following difficulties while using the receiver, use this troubleshooting guide to help you remedy the problem.

Audio

There is no sound, no matter which component is selected, or only a very low-level sound is heard.

- Check that the speakers and components are connected securely.
- Check that both the receiver and all components are turned on.
- Check that MASTER VOLUME is not set to “VOLUME MIN”.
- Press  to cancel the muting function.
- Check that you have selected the correct component with the input buttons.
- The protective device on the receiver has been activated. Turn off the receiver, eliminate the short-circuit problem, and turn on the power again.
- Check that the INPUT MODE setting is correct for SAT/CATV input.

There is no sound from a specific component.

- Check that the component is connected correctly to the audio input jacks for that component.
- Check that the cord(s) used for the connection is (are) fully inserted into the jacks on both the receiver and the component.

There is no sound from one of the front speakers.

- Make sure you have connected to both the L and R jacks of an analog component, and not only to either the L or R jack. Use an audio cord (not supplied).

There is no sound from digital sources (from OPTICAL input jack).

- Check that the INPUT MODE is set to “OPT” for SAT/CATV input (page 62).
- Set “ARC” to “ARC OFF” when no sound is output from TV OPT IN jack during TV input (page 45).

There is severe hum or noise.

- Check that the speakers and components are connected securely.
- Check that the connecting cords are away from a transformer or motor, and at least 3 meters away from a TV set or fluorescent light.
- Move your audio components away from the TV.
- The plugs and jacks are dirty. Wipe them with a cloth slightly moistened with alcohol.

There is pop noise from a specific component connected to this receiver when you turn on the component.

- Check that the INPUT MODE is set to “OPT” for SAT/CATV input (page 62).

There is no sound, or only a very low-level sound is heard from the center/surround speakers.

- Select “MOVIE-D.C.S.-” (page 33).
- Adjust the speaker level (page 60).
- Check that the speakers are connected securely.

There is no sound from the subwoofer.

- Check that the subwoofer is connected correctly and securely.

The surround effect cannot be obtained.

- Make sure the sound field function is on (press SOUND FIELD +/-).
- Sound fields do not function for signals with a sampling frequency of more than 48 kHz.

Dolby Digital or DTS multi channel sound is not reproduced.

- Check that the DVD, etc. you are playing is recorded in Dolby Digital or DTS format.
- When connecting the DVD player, etc., to the digital input jacks of this receiver, check the audio setting (the settings for the audio output) of the connected component.
- Use the TV menu to set the Speaker Setting to Audio System.

There is no sound from the component connected to the DIGITAL MEDIA PORT adapter.

- Adjust the volume of this receiver.
- The DIGITAL MEDIA PORT adapter and/or component is not connected correctly. Turn off the receiver, then reconnect the DIGITAL MEDIA PORT adapter and/or component.
- Check the DIGITAL MEDIA PORT adapter and/or component device to make sure it supports this receiver.

Video

There is no picture or an unclear picture appears on the TV screen or monitor.

- Make sure you have connected the video output of your video component to the TV.
- Move your audio components away from the TV.
- Depending on the DIGITAL MEDIA PORT adapter, video output may not be possible.

HDMI

The source sound input to the HDMI jack on the receiver is not output from the receiver or the TV speaker.

- Check the HDMI connection (page 21).
- Make sure “CTRL HDMI” is set to “CTRL ON” in SET HDMI menu.
- You cannot listen to the Super Audio CD by connecting HDMI.
- Depending on the playback component, you may need to set up the component. Refer to the operating instructions supplied with each component.
- Be sure to use a High Speed HDMI cable when you view images or listen to sound during Deep Colour or 3D transmission.

The source image input to the HDMI jack on the receiver is not output from the TV.

- Check the HDMI connection (page 21).
- Depending on the playback component, you may need to set up the component. Refer to the operating instructions supplied with each component.
- Be sure to use a High Speed HDMI cable when you view images or listen to sound during Deep Colour or 3D transmission.

The Control for HDMI function does not work.

- Check the HDMI connection (page 21).
- Make sure “CTRL HDMI” is set to “CTRL ON” in SET HDMI menu.
- Make sure the connected component is compatible with the Control for HDMI function.
- Check the Control for HDMI settings on the connected component. Refer to the operating instructions of the connected component.
- Repeat the procedures of “Preparing for the “BRAVIA” Sync” if you change the HDMI connection, connect/disconnect the AC power cord (mains lead), or there is a power failure (page 40).

No sound is output from the receiver and TV speaker while using the System Audio Control function.

- Make sure the TV is compatible with the System Audio Control function.
- If you cannot listen to the sound of a component connected to the receiver
 - Select the appropriate input when you want to watch a program on a component connected via HDMI connection to the receiver.
 - Change the TV channel when you want to watch a TV broadcast.
 - Select the component or input you want to watch when you watch a program on the component connected to the TV. Refer to the operating instructions of the TV on this operation.

When the receiver is in standby mode, there is no image or sound on the TV.

- When the receiver is in standby mode, image and sound are output from the HDMI component selected the last time you turned off the receiver. If you are enjoying other component, play the component and perform the One-Touch Play operation, or turn on the receiver to select the HDMI component you want to enjoy.
- Make sure “PASS THRU” is set to “THRU ON” in the SET HDMI menu if you connect components not compatible with the “BRAVIA” Sync to the receiver (page 44).

The volume turns down when the output method changes from the TV speaker to the speakers connected to the receiver.

- The Volume Limit function is working (page 42).

S-AIR function

S-AIR connection is not established (sound transmission is not established), e.g., the indicator of the S-AIR sub unit turns off, flashes, or turns red.

- If you use another S-AIR main unit, place it more than 8 meters away from this S-AIR main unit.
- Confirm the S-AIR IDs of the S-AIR main unit and S-AIR sub unit (page 50).
- Another S-AIR sub unit is paired to the S-AIR main unit. Pair the desired S-AIR sub unit with the S-AIR main unit (page 51).
- The S-AIR main unit is paired to another S-AIR sub unit. Cancel pairing.
- Place the S-AIR main unit and S-AIR sub unit separately from other wireless devices.
- Avoid using any other wireless devices.
- The S-AIR sub unit is turned off. Make sure the AC power cord (mains lead) is connected and turn on the S-AIR sub unit.

No sound is heard from the S-AIR product.

- If you use another S-AIR main unit, place it more than 8 meters away from this S-AIR main unit.
- Confirm the S-AIR IDs of the S-AIR main unit and S-AIR sub unit (page 50).
- Confirm the pairing setting (page 51).
- Place the S-AIR main unit and S-AIR sub unit closer to each other.
- Avoid using the equipment that generates electromagnetic energy, such as a microwave oven.
- Place the S-AIR main unit and S-AIR sub unit separately from other wireless devices.
- Avoid using any other wireless devices.
- Change the “RF CHANGE” setting (page 55).
- Change the S-AIR ID settings of the S-AIR main unit and S-AIR sub unit.
- Turn off the receiver and S-AIR sub unit, then turn on again.
- Check that headphones are not connected to the S-AIR sub unit.

There is noise or the sound skips.

- If you use another S-AIR main unit, place it more than 8 meters away from this S-AIR main unit.
- Sources with copyright protection may not be playable on S-AIR sub unit.
- Place the S-AIR main unit and S-AIR sub unit closer to each other.
- Avoid using the equipment that generates electromagnetic energy, such as a microwave oven.
- Place the S-AIR main unit and S-AIR sub unit separately from other wireless devices.
- Avoid using any other wireless devices.
- Change the “RF CHANGE” setting (page 55).
- Change the S-AIR ID settings of the S-AIR main unit and S-AIR sub unit.

“HP NO LINK” and “VOLUME MIN” appear alternately in the display and the volume of the receiver becomes minimum.

- Volume becomes minimum when you turn off the surround amplifier with headphones connected or if the radio reception is poor. Check the radio reception and adjust the volume level to restore the sound from the headphones.
-

Tuner

The FM reception is poor.

- Use a 75-ohm coaxial cable (not supplied) to connect the receiver to an outdoor FM antenna (aerial) as shown below. If you connect the receiver to an outdoor antenna (aerial), ground it against lightning. To prevent a gas explosion, do not connect the ground wire to a gas pipe.

Outdoor FM antenna (aerial)

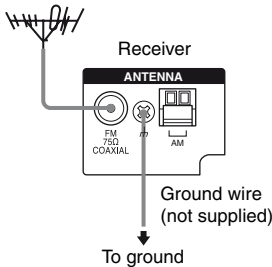

Radio stations cannot be tuned in.

- Check that the antennas are connected securely. Adjust the antennas and connect an external antenna (aerial), if necessary.
- The signal strength of the stations is too weak (when tuning in with automatic tuning). Change to monaural reception (page 35).
- No stations have been preset or the preset stations have been cleared (when tuning by scanning preset stations). Preset the stations (page 37).

RDS does not work.*

- Make sure that you are tuned to an FM RDS station.
- Select a stronger FM station.

The RDS information that you want does not appear.*

- Contact the radio station and find out whether they actually provide the service in question. If so, the service may be temporarily out of order.

* Models of area code CEL only.

Remote commander

The remote does not function.

- Point the remote at the remote sensor on the receiver.
- Remove any obstacles in the path between the remote and the receiver.
- Replace all the batteries in the remote with new ones, if they are weak.
- Make sure you select the correct input on the remote.

Others

The POWER/ACTIVE STANDBY indicator flashes.

- The receiver is in protection mode. Turn off the receiver and turn it on again.

The receiver is turned off automatically.

- The AUTO STBY function is working (page 62).

Error messages

If an error message appears while you perform Auto Calibration, see “When error codes appear” (page 28) to solve the problem.

If you are unable to remedy the problem using the troubleshooting guide

Clearing the receiver’s memory may remedy the problem (page 24). However, note that all memorized settings will be reset to their initial settings and you will have to readjust all settings on the receiver.

If the problem persist

Consult your nearest Sony dealer. Note that if service personnel changes some parts during repair, these parts may be retained.

In the event of a problem with S-AIR function, have a Sony dealer check the entire system together (S-AIR main unit and S-AIR sub unit).

Reference sections for clearing the receiver’s memory

To clear	See
All memorized settings	page 24

Specifications

Amplifier section

POWER OUTPUT (rated)

FRONT L + FRONT R

108 W + 108 W (at 3 ohms,
1 kHz, 1% THD)

POWER OUTPUT (reference)

FRONT L/FRONT R/CENTER/SUR L/SUR R

167 W (per channel at
3 ohms, 1 kHz)

SUBWOOFER

165 W (at 3 ohms, 60 Hz)

Inputs

Analog Sensitivity: 1 V/50 kohms

Digital (Coaxial) Impedance: 75 ohms

HDMI Video

Input/Output (HDMI Repeater block)

640 × 480p@60 Hz

720 × 480p@59.94/60 Hz

1280 × 720p@59.94/60 Hz

1920 × 1080i@59.94/60 Hz

1920 × 1080p@59.94/60 Hz

720 × 576p@50 Hz

1280 × 720p@50 Hz

1920 × 1080i@50 Hz

1920 × 1080p@50 Hz

1920 × 1080p@24 Hz

HDMI Video (3D)

Input/Output (HDMI Repeater block)

1280 × 720p@59.94/60Hz Frame packing

1920 × 1080i@59.94/60Hz Frame packing

1920 × 1080i@59.94/60Hz Side-by-Side (Half)

1920 × 1080p@59.94/60Hz Side-by-Side (Half)

1280 × 720p@50Hz Frame packing

1920 × 1080i@50Hz Frame packing

1920 × 1080i@50Hz Side-by-Side (Half)

1920 × 1080p@50Hz Side-by-Side (Half)

1920 × 1080p@24Hz Frame packing

FM tuner section

Tuning range	87.5 MHz – 108.0 MHz (50 kHz step)
Antenna	FM wire antenna (aerial)
Antenna terminals	75 ohms, unbalanced
Intermediate frequency	10.7 MHz

AM tuner section

Area code	Tuning scale	
	9 kHz step	10 kHz step
SP1, TW2, TH1	531 kHz – 1,602 kHz	530 kHz – 1,610 kHz
CEL	531 kHz – 1,602 kHz	–

Antenna	AM loop antenna (aerial)
Intermediate frequency	450 kHz

General

Power requirements

Area code	Power requirements
CEL, SP1, TH1	220 V AC – 240 V AC, 50/60 Hz
TW2	120 V AC, 50/60 Hz

Power output (DIGITAL MEDIA PORT)

DC OUT: 5 V, 0.7A MAX

Power consumption

Area code	Power consumption
CEL, SP1, TH1, TW2	110 W

Power consumption (during standby mode)

0.3 W (When Control for
HDMI and S-AIR standby
are set to off)

Dimensions (w/h/d) (Approx.)

430 mm × 66.5 mm ×
306 mm
including projecting parts
and controls

Mass (Approx.) 3.4 kg

Speaker section

HT-SF470 only

- Front speaker (SS-MSP37F)
- Surround speaker (SS-SRP37F)
- Center speaker (SS-CNP37)

Front/Surround speaker

Full range

Center speaker Full range, magnetically shielded

Speaker unit

Front/Surround speaker

65 mm, cone type

Center speaker 30 mm × 60 mm, cone type

Enclosure type

Front/Surround speaker

Bass reflex

Center speaker Acoustic suspension

Rated impedance 3 ohms

Dimension (w/h/d) (Approx.)

Front speaker 113 mm × 830 mm ×
83 mm (without stand)
315 mm × 1,015 mm –
1,345 mm × 315 mm
(with stand)

Surround speaker 108 mm × 540 mm ×
78 mm (without stand)
290 mm × 1,045 mm –
1,235 mm × 290 mm
(with stand)

Center speaker 380 mm × 50 mm × 64 mm
(with foot)

Mass (Approx.)

Front speaker 1.6 kg (without stand)
3.3 kg (with stand)

Surround speaker 1.1 kg (without stand)
2.6 kg (with stand)

Center speaker 0.38 kg (with foot)

• Subwoofer (SS-WP37)

Speaker unit 160 mm, cone type

Enclosure type Bass reflex

Rated impedance 3 ohms

Dimensions (w/h/d) (Approx.)

220 mm × 395 mm ×
325 mm (with foot)

Mass (Approx.) 5.6 kg (with foot)

HT-SS370 only

• Front/Surround speaker (SS-TSB101)

• Center speaker (SS-CTB101)

Front/Surround speaker

Full range

Center speaker Full range, magnetically shielded

Speaker unit

Front/Surround speaker

55 mm × 80 mm, cone type

Center speaker 30 mm × 60 mm, cone type

Enclosure type

Front/Surround speaker

Bass reflex

Center speaker Acoustic suspension

Rated impedance 3 ohms

Dimension (w/h/d) (Approx.)

Front/Surround speaker

75 mm × 225 mm × 71 mm
(with foot)

Center speaker 290 mm × 49 mm × 49 mm
(with foot)

Mass (Approx.)

Front/Surround speaker

0.45 kg (with foot)

Center speaker 0.28 kg (with foot)

• Subwoofer (SS-WSB101)

Speaker unit 160 mm, cone type

Enclosure type Bass reflex

Rated impedance 3 ohms

Dimensions (w/h/d) (Approx.)

260 mm × 320 mm ×
260 mm (with foot)

Mass (Approx.) 5.2 kg (with foot)

For details on the area code of the component you are using, see page 4.

Design and specifications are subject to change without notice.

Halogenated flame retardants are not used in the certain printed wiring boards.

Index

Numerics

5.1 channel 15

A

AUDIO DRC 61

Audio Return Channel
(ARC) 45

AUTO CALIBRATION 25

AUTO STBY 62

B

Blu-ray Disc player
connecting 22

playback 32

“BRAVIA” Sync
preparing 40

C

CD player
connecting 20
playback 32

D

Deep Colour 63

Digital Cinema Sound
(DCS) 63

DIGITAL MEDIA PORT
adapter
connecting 20
playback 32

DIMMER 62

DISPLAY 62

Dolby Digital 63

DTS 64

DVD player
connecting 23
playback 32

DVD recorder
connecting 22, 23
playback 32

E

Error messages 72

H

HDMI

connecting 22

HDMI Signal Pass Through
44

I

Initial setup 24

INPUT MODE 62

M

Menu

A.CAL MENU 59

AUDIO 59

LEVEL 59

S-AIR SET 59

SET HDMI 59

SP SETUP 59

SYSTEM 59

TONE 59

Muting 30

N

Naming 38

NIGHT MODE 34

O

One-Touch Play 41

P

Pairing 51

R

RDS 39

Remote commander 11

S

S-AIR 47

Satellite tuner, cable
television tuner
connecting 22
playback 31

Scene Select 46

Selecting
component 29

SLEEP 62

Sound fields
selecting 33

Speakers
connecting 18
installing 15

Super Audio CD player
connecting 20
playback 32

System Audio Control 42

System Power Off 43

T

Theatre Mode 46

Tuner
connecting 24

Tuning
automatically 35
directly 36
to preset stations 37

TV

connecting 19, 22
playback 31

V

Volume Limit 42



* 4 1 6 8 1 6 6 4 2 * (1)

Free Manuals Download Website

<http://myh66.com>

<http://usermanuals.us>

<http://www.somanuals.com>

<http://www.4manuals.cc>

<http://www.manual-lib.com>

<http://www.404manual.com>

<http://www.luxmanual.com>

<http://aubethermostatmanual.com>

Golf course search by state

<http://golfingnear.com>

Email search by domain

<http://emailbydomain.com>

Auto manuals search

<http://auto.somanuals.com>

TV manuals search

<http://tv.somanuals.com>